

DEPARTMENT OF TRANSPORTATION**National Highway Traffic Safety Administration****49 CFR Parts 571 and 596**

[Docket No. NHTSA–2023–0021]

RIN 2127–AM37

Federal Motor Vehicle Safety Standards: Automatic Emergency Braking Systems for Light Vehicles

AGENCY: National Highway Traffic Safety Administration (NHTSA), Department of Transportation (DOT).

ACTION: Notice of proposed rulemaking (NPRM).

SUMMARY: This NPRM proposes to adopt a new Federal Motor Vehicle Safety Standard to require automatic emergency braking (AEB), including pedestrian AEB (PAEB), systems on light vehicles. An AEB system uses various sensor technologies and sub-systems that work together to detect when the vehicle is in a crash imminent situation, to automatically apply the vehicle brakes if the driver has not done so, or to apply more braking force to supplement the driver's braking. The AEB system proposed in this NPRM would detect and react to an imminent crash with a lead vehicle or pedestrian. This NPRM promotes NHTSA's goal to equip vehicles with AEB and PAEB, and advances DOT's January 2022 National Roadway Safety Strategy that identified requiring AEB, including PAEB technologies, on new passenger vehicles as a key Departmental action to enable safer vehicles. This NPRM also responds to a mandate under the Bipartisan Infrastructure Law directing the Department to promulgate a rule to require that all passenger vehicles be equipped with an AEB system.

DATES: Comments must be received on or before August 14, 2023.

Proposed compliance date: Vehicles manufactured on or after September 1, four years after the publication date of a final rule, would be required to meet all requirements. Vehicles manufactured on or after September 1, three years after the publication date of a final rule, but before September 1, four years after the publication date of a final rule, would be required to meet all requirements except that lower speed PAEB performance test requirements specified in S5(b) would apply. Small-volume manufacturers, final-stage manufacturers, and alterers would be provided an additional year (added to those above) to meet the requirements of

the final rule. Early compliance is permitted but optional.

ADDRESSES: You may submit comments to the docket number identified in the heading of this document by any of the following methods:

- *Federal eRulemaking Portal:* Go to <https://www.regulations.gov>. Follow the online instructions for submitting comments.

- *Mail:* Docket Management Facility, M–30, U.S. Department of Transportation, West Building, Ground Floor, Rm. W12–140, 1200 New Jersey Avenue SE, Washington, DC 20590.

- *Hand Delivery or Courier:* West Building, Ground Floor, Room W12–140, 1200 New Jersey Avenue SE, between 9 a.m. and 5 p.m. Eastern Time, Monday through Friday, except Federal holidays. To be sure someone is there to help you, please call 202–366–9332 before coming.

- *Fax:* 202–493–2251.

Regardless of how you submit your comments, please provide the docket number of this document.

Instructions: For detailed instructions on submitting comments and additional information on the rulemaking process, see the Public Participation heading of the Supplementary Information section of this document. Note that all comments received will be posted without change to <https://www.regulations.gov>, including any personal information provided.

Privacy Act: In accordance with 5 U.S.C. 553(c), DOT solicits comments from the public to better inform its decision-making process. DOT posts these comments, without edit, including any personal information the commenter provides, to www.regulations.gov, as described in the system of records notice (DOT/ALL–14 FDMS), which can be reviewed at www.transportation.gov/privacy. In order to facilitate comment tracking and response, the agency encourages commenters to provide their name, or the name of their organization; however, submission of names is completely optional. Whether or not commenters identify themselves, all timely comments will be fully considered.

Docket: For access to the docket to read background documents or comments received, go to www.regulations.gov, or the street address listed above. To be sure someone is there to help you, please call 202–366–9332 before coming. Follow the online instructions for accessing the dockets.

FOR FURTHER INFORMATION CONTACT: For non-legal issues: Markus Price, Office of Crash Avoidance Standards (telephone:

202–366–1810). For legal issues: David Jasinski, Office of the Chief Counsel (telephone: 202–366–2992, fax: 202–366–3820). The mailing address for these officials is: National Highway Traffic Safety Administration, 1200 New Jersey Avenue SE, Washington, DC 20590.

SUPPLEMENTARY INFORMATION:**Table of Contents**

- I. Executive Summary
- II. Safety Problem
 - A. Overall Rear-End Crash Problem
 - B. Rear-End Crashes by Vehicle Type
 - C. Rear-End Crashes by Posted Speed Limit
 - D. Rear-End Crashes by Light Condition
 - E. Rear-End Crashes by Atmospheric Conditions
 - F. Pedestrian Fatalities and Injuries
 - G. Pedestrian Fatalities and Injuries by Initial Point of Impact and Vehicle Type
 - H. Pedestrian Fatalities and Injuries by Posted Speed Limit Involving Light Vehicles
 - I. Pedestrian Fatalities and Injuries by Lighting Condition Involving Light Vehicles
 - J. Pedestrian Fatalities and Injuries by Age Involving Light Vehicles
 - K. AEB Target Population
- III. Data on Effectiveness of AEB in Mitigating Harm
- IV. NHTSA's Earlier Efforts Related to AEB
 - A. NHTSA's Foundational AEB Research
 - 1. Forward Collision Warning Research
 - 2. AEB Research To Prevent Rear-End Impacts With a Lead Vehicle
 - 3. AEB Research To Prevent Vehicle Impacts With Pedestrians
 - 4. Bicycle and Motorcycle AEB
 - B. NHTSA's New Car Assessment Program
 - 1. FCW Tests
 - 2. Lead Vehicle AEB Tests
 - 3. PAEB Test Proposal
 - 4. 2016 Voluntary Commitment
 - D. Response To Petition for Rulemaking
- V. NHTSA's Decision to Require AEB
 - A. This Proposed Rule Is Needed To Address Urgent Safety Problems
 - B. Stakeholder Interest in AEB
 - 1. National Transportation Safety Board Recommendations
 - 2. Consumer Information Programs in the United States
 - 3. Petition for Rulemaking on PAEB Performance in Dark Conditions
 - C. Key Findings Underlying This Proposal
 - 1. Impact Speed Is Key to Improving AEB's Mitigation of Fatalities and Injuries
 - 2. Darkness Performance of PAEB Is Highly Important
 - 3. NHTSA's 2020 Research on Lead Vehicle AEB and PAEB Performance Show the Practicability of Higher Speed Tests
 - a. Lead Vehicle AEB Performance Tests
 - b. PAEB Daytime Performance Tests
 - c. PAEB Darkness Performance Tests
 - d. PAEB Darkness Performance Tests With Overhead Lighting
 - 4. This Proposed Standard Complements Other NHTSA Actions
- VI. Proposal To Require Automatic Emergency Braking

- A. Lead Vehicle AEB System Requirement
- B. Forward Collision Warning Requirement
 - 1. FCW Modalities
 - 2. FCW Auditory Signal Characteristics
 - 3. FCW Visual Signal Characteristics
 - 4. FCW Haptic Signal
- C. Lead Vehicle AEB—Performance Test Requirements
 - 1. Stopped Lead Vehicle Scenario Test Speeds
 - 2. Slower-Moving Lead Vehicle Scenario Test Speeds
 - 3. Decelerating Lead Vehicle Scenario Test Speeds
 - 4. Subject Vehicle Brake Application
- D. PAEB System Requirement
- E. PAEB—FCW Requirement
- F. PAEB—Performance Test Requirements
 - 1. PAEB Scenario Descriptions
 - 2. Overlap
 - 3. Vehicle and Pedestrian Surrogate Travel Speeds
 - 4. Crossing Path Scenario Testing Speeds
 - 5. Stationary Scenario Testing Speeds
 - 6. Along Path Scenario Testing Speeds
 - 7. PAEB Darkness Testing
- G. Alternatives to No-Contact Performance Test Requirement
- H. False Activation Requirement
 - 1. Steel Trench Plate False Activation Scenario
 - 2. Pass-Through False Activation Scenario
 - 3. Potential Alternatives to False Activation Requirements
- I. Malfunction Detection Requirement
- J. AEB System Disablement
- K. AEB System Performance Information
- VII. AEB Test Procedures
 - A. AEB System Initialization
 - B. Travel Path
 - C. Subject Vehicle Preparation
 - D. Subject Vehicle Tolerance Specifications
 - E. Lead Vehicle Test Set Up and Tolerance
 - F. Test Completion Criteria for Lead Vehicle AEB Tests
 - G. PAEB Test Procedures and Tolerance
 - H. False Positive AEB Test Procedures
 - I. Environmental Test Conditions
 - J. Test Track Conditions
 - K. Subject Vehicle Conditions
- VIII. Test Devices
 - A. Pedestrian Test Mannequins
 - 1. Background
 - 2. Mannequin Appearance
 - 3. Color and Reflectivity
 - 4. Radar Cross Section
 - 5. Other Considerations
 - B. Vehicle Test Device
 - 1. Description and Development
 - 2. Specifications
 - 3. Alternatives Considered
- IX. Proposed Effective Date Schedule
- X. Summary of Estimated Effectiveness, Cost, and Benefits
 - A. Target Population
 - B. Lead Vehicle AEB System Effectiveness
 - C. PAEB System Effectiveness
 - D. Fatalities Avoided and Injuries Mitigated
 - E. Costs
 - F. Cost-Effectiveness
 - G. Comparison of Regulatory Alternatives
- XI. Regulatory Notices and Analyses
- XII. Public Participation
- XIII. Appendices to the Preamble

I. Executive Summary

In 2019, there were 6,272 pedestrian fatalities in motor vehicle crashes, representing 17 percent of all motor vehicle fatalities.¹ This represents the continuation of the recent trend of increased pedestrian deaths on our nation's roadways.² A further 76,000 pedestrians were injured in motor vehicle crashes. In addition, there were nearly 2.2 million rear-end police-reported crashes involving light vehicles, which led to 1,798 deaths and 574,000 injuries. Deaths and injuries in more recent years are even greater. However, the agency's analysis of the safety problem focuses on the calendar year 2019 because it is the most recent year without the prominent effect of the COVID-19 pandemic.

This NPRM proposes to address this significant safety problem by proposing a new Federal Motor Vehicle Safety Standard (FMVSS) to require automatic emergency braking (AEB) systems on light vehicles that are capable of reducing the frequency and severity of both rear-end and pedestrian crashes. This proposed action represents a crucial step forward in implementing DOT's January 2022 National Roadway Safety Strategy (NRSS) to address the rising numbers of transportation deaths and serious injuries occurring on this country's streets, roads, and highways, including actions to protect vulnerable road users, including pedestrians.³

The Department's Safe System Approach emphasizes that multiple, complementary safety interventions to prevent crashes are critical to improving safety and protecting people. Through the NRSS, the Department is focusing on advancing initiatives that will significantly enhance roadway safety. These initiatives include infrastructure design and interventions along with proposed vehicle regulations such as this one. The Department is advancing support for the implementation of Complete Streets policies to help transportation agencies across the United States plan, develop, and operate roads, streets, and networks. Complete Streets policies prioritize safety, comfort, and connectivity to destinations for all users, including pedestrians, bicyclists, those who use wheelchairs and mobility devices, transit riders, micro-mobility users, shared ride services, motorists, and

freight delivery services. NHTSA is providing technical assistance to States to encourage the adoption of a safe system approach with emphasis on partnering with State Departments of Transportation and Emergency Medical Service agencies to comprehensively address various roadway issues including those affecting those who walk, bike and roll. NHTSA awards annual formula grants to the States to conduct lifesaving highway safety programs and is also assisting States as they conduct meaningful public engagement to ensure that affected communities are involved in program planning and implementation.

The crash problem that can be addressed by AEB is substantial.⁴ For example, 60 percent of fatal rear-end crashes and 73 percent of injury crashes were on roads with posted speed limits of 60 mph or below. Similarly, most of these crashes occurred in clear, no adverse atmospheric conditions—72 percent of fatal crashes and 74 percent of injury crashes. Also, about 51 percent of fatal and 74 percent of rear-end crashes involving light vehicles resulting in injuries occurred in daylight conditions. In addition, 65 percent of pedestrian fatalities and 67 percent of pedestrian injuries were the result of a strike by the front of a light vehicle. Of those, 77 percent, and about half of the pedestrian injuries, occur in dark lighting conditions. This NPRM proposes to adopt a new FMVSS to require AEB systems on light vehicles that are capable of reducing the frequency and severity of both lead vehicle and pedestrian collisions.⁵ AEB systems employ sensor technologies and sub-systems that work together to sense when the vehicle is in a crash imminent situation, to automatically apply the vehicle brakes if the driver has not done so, and to apply more braking force to supplement the driver's braking. Current systems primarily use radar- and camera-based sensors, while there are also emerging systems that use lidar and thermal sensors. These systems can reduce both lead vehicle rear-end (lead vehicle AEB) and pedestrian crashes (PAEB). Importantly, this proposal would require that systems are able to avoid pedestrian crashes in darkness testing conditions. AEB systems have

¹ <https://crashstats.nhtsa.dot.gov/Api/Public/ViewPublication/813079> Pedestrian Traffic Facts 2019 Data, May 2021.

² *Id.*, Table 1 Pedestrian fatalities 2010—4,302, 2019—6,272.

³ https://www.transportation.gov/sites/dot.gov/files/2022-01/USDOT_National_Roadway_Safety_Strategy_0.pdf.

⁴ The Insurance Institute for Highway Safety (IIHS) estimates a 50 percent reduction in front-to-rear crashes of vehicles with AEB (IIHS, 2020) and a 25 to 27 percent reduction in pedestrian crashes for PAEB (IIHS, 2022).

⁵ For the purpose of this NPRM, "light vehicles" means passenger cars, multipurpose passenger vehicles (MPVs), trucks, and buses with a gross vehicle weight rating of 4,536 kilograms (10,000 pounds) or less.

reached a level of maturity such that they will be able to reduce the frequency and severity of crashes and are thus ready to be mandated on all new light vehicles.

This proposal is issued under the authority of the National Traffic and Motor Vehicle Safety Act of 1966. Under 49 U.S.C. Chapter 301, the Secretary of Transportation is responsible for prescribing motor vehicle safety standards that are practicable, meet the need for motor vehicle safety, and are stated in objective terms. The responsibility for promulgation of FMVSSs is delegated to NHTSA. This rulemaking addresses a statutory mandate under the Bipartisan Infrastructure Law (BIL), codified as the Infrastructure Investment and Jobs Act (IIJA),⁶ which added 49 U.S.C. 30129, directing the Secretary of Transportation to promulgate a rule requiring that all passenger motor vehicles for sale in the United States be equipped with a FCW system and an AEB system.

The decision to mandate AEB builds on decades of research and development, which began in the 1990s, with initial research programs to support development of AEB technologies and methods by which system performance could be assessed. NHTSA began testing AEB systems as part of New Car Assessment Program (NCAP) in 2010 and reporting on the respective research and progress surrounding the technologies shortly thereafter.⁷ These research efforts led to the incorporation of AEB into incentive programs designed to raise consumer awareness of AEB, such as NCAP. NHTSA included FCW systems as a “recommended advanced technology” in NCAP in model year 2011, and in November 2015, added crash imminent braking (CIB) and dynamic brake support (DBS) technologies to the program with assessments of these technologies to begin in model year 2018.⁸ Most recently, NHTSA proposed upgrades to the lead vehicle AEB test in its March 2022 request for comment on NCAP.⁹ Separate from NCAP, in March 2016, NHTSA and Insurance Institute for Highway Safety (IIHS) announced a commitment by 20 manufacturers representing more than 99 percent of the U.S. light vehicle market to equip low-speed AEB as a standard feature on nearly all new light vehicles not later than September 1, 2022. As part of this

voluntary commitment, manufacturers would include both FCW and a CIB system that would reduce a vehicle’s speed in certain rear-end crash-imminent test conditions.

NHTSA also conducted research to understand the capabilities of PAEB systems beginning in 2011. This work began with an assessment of the most common pedestrian crash scenarios to determine how test procedures could be designed to address them. As part of this development, NHTSA also looked closely at a potential pedestrian mannequin to be used during testing and explored several aspects of the mannequin, including size and articulation of the arms and legs. This work resulted in a November 2019 draft research test procedure providing the methods and specifications for collecting performance data on PAEB systems for light vehicles.¹⁰ This procedure was expanded to cover updated vehicle speed ranges and different ambient conditions and included in a March 2022 request for comments notice proposing to include PAEB, higher speed AEB, blind spot warning and blind spot intervention into NCAP.¹¹

While these actions have increased market penetration of AEB systems, reduced injuries, and saved lives, NHTSA believes that mandating AEB systems that can address both lead vehicle and pedestrian crashes is necessary to better address the safety need. NHTSA incorporated FCW into NCAP beginning in model year 2011 and AEB into NCAP beginning in model year 2018. This has achieved success, with approximately 65% of new vehicles meeting the lead vehicle test procedures included in NCAP.¹² Similarly, the voluntary commitment resulted in approximately 90 percent of new light vehicles having an AEB system.

However, the test speeds and performance specifications in NCAP and the voluntary commitment would not ensure that the systems perform in a way that will prevent or mitigate crashes resulting in serious injuries and fatalities. The vast majority of fatalities, injuries, and property damage crashes occur at speeds above 40 km/h (25 mph), which are above those covered by the voluntary commitment.

NCAP and, even more so, other voluntary measures are intended to supplement rather than substitute for

the FMVSS, which remain NHTSA’s core way of ensuring that all motor vehicles are able to achieve an adequate level of safety performance. Thus, though the NCAP program provides valuable safety-related information to consumers in a simple to understand way, the agency believes that gaps in market penetration will continue to exist for the most highly effective AEB systems. NHTSA has also observed that, in the case of both electronic stability control and rear visibility, only approximately 70 percent of vehicles had these technologies during the time they were part of NCAP. Thus, while NCAP serves a vital safety purpose, NHTSA also recognizes its limitations and concludes that only regulation can ensure that all vehicles are equipped with AEB that meet the proposed performance requirements.

These considerations are of even greater weight when considering whether to require a system that can reduce pedestrian crashes. Pedestrian fatalities are increasing, and NHTSA’s testing has established that PAEB systems will be able to significantly reduce these deaths.¹³ Manufacturers’ responses to adding lead vehicle AEB and other technologies into NCAP suggests that it would take several years after PAEB is introduced into NCAP before the market began to see significant numbers of new vehicles that would be able to meet a finalized NCAP test. Moreover, as pedestrian safety addresses the safety of someone other than the vehicle occupant, it is not clear if past experiences with NCAP are necessarily indicative of how quickly PAEB systems would reach the levels of lead vehicle AEB, if pedestrian functionality that would meet NCAP performance levels was offered as a separate cost to consumers. NHTSA believes that there can be a significant safety benefit in NCAP providing consumers with information about new safety technologies before it is prepared to mandate them, but this is not a requirement.

A final factor weighing in favor of requiring AEB is that the technology is a significantly more mature level than what it was at the time of the voluntary commitment or when it was introduced into NCAP. NHTSA’s most recent testing has shown that higher performance levels than those in the voluntary commitment or the existing NCAP requirements are now practicable. Many model year 2019 and 2020 vehicles were able to repeatedly avoid impacting the lead vehicle in CIB

¹³ The accompanying PRIA estimates the impacts of the rule.

⁶ Public Law 117–58, 24208 (Nov. 15, 2021).

⁷ 77 FR 39561 (Jul. 2, 2012).

⁸ 80 FR 68604 (Nov. 5, 2015).

⁹ 87 FR 13452 (Mar. 9, 2022). See

www.regulations.gov, docket number NHTSA–2021–0002.

¹⁰ 84 FR 64405 (Nov. 21, 2019).

¹¹ 87 FR 13452 (Mar. 9, 2022).

¹² Percentage based on the vehicle manufacturer’s model year 2022 projected sales volume reported through the New Car Assessment Program’s annual vehicle information request.

tests and the pedestrian test mannequin in PAEB tests, even at higher test speeds than those prescribed currently in the agency's CIB and PAEB test procedures.

These results show that AEB systems are capable of reducing the frequency and severity of both lead vehicle and pedestrian crashes. Mandating AEB systems would address a clear and, in the case of pedestrian deaths, growing safety problem. To wait for market-driven adoption, even to the extent spurred on by NCAP, would lead to deaths and injuries that could be avoided if the technology were required, and would be unlikely to result in all vehicles having improved AEB. Thus, in consideration of the safety problem and NHTSA's recent test results, and consistent with the Safety Act and BIL, NHTSA has tentatively concluded that a new Federal motor vehicle safety standard requiring AEB systems that can address both lead vehicle and pedestrian collisions on all new light vehicles is necessary to address the problem of rear-end crashes resulting in property damage, injuries, and fatalities. The proposed lead vehicle AEB test procedures build on the existing FCW, CIB, and DBS NCAP procedures, but include higher speed performance requirements. Collision avoidance is required at speeds up to 100 km/h (62 mph) when manual braking is applied and up to 80 km/h (50 mph) when no manual braking is applied during the test. Based on data from the 2019 and 2020 research programs, NHTSA believes that it is practicable to require this higher level of system performance. Performance at these speeds would address the injuries and fatalities resulting from rear-end crashes. As part of this proposal, NHTSA is including testing under both daylight and darkness lighting conditions. In the darkness testing condition, NHTSA is proposing testing with both lower beam and upper beam headlamps activated. NHTSA believes darkness testing of PAEB is necessary because more than three-fourths of all pedestrian fatalities occur in conditions other than daylight.

The proposed standard includes four requirements for AEB systems for both lead vehicles and pedestrians. First, vehicles would be required to have an AEB system that provides the driver with a FCW at any forward speed greater than 10 km/h (6.2 mph). NHTSA is proposing that the FCW be presented via auditory and visual modalities when a collision with a lead vehicle or a pedestrian is imminent. Based on NHTSA's research, this proposal includes specifications for the auditory and visual warning components.

Additional warning modes, such as haptic, would be allowed.

Second, vehicles would be required to have an AEB system that applies the brakes automatically at any forward speed greater than 10 km/h (6.2 mph) when a collision with a lead vehicle or a pedestrian is imminent. This requirement would serve to ensure that AEB systems operate at all speeds above 10 km/h (6.2 mph), even if these speeds are above the speeds tested by NHTSA and provide at least some level of AEB system performance in those rear-end crashes. An AEB system active at any speed above 10 km/h (6.2 mph) will be able to mitigate collisions at high speeds through, at a minimum, speed reduction.

Third, the AEB system would be required to prevent the vehicle from colliding with the lead vehicle or pedestrian test mannequin when tested according to the proposed standard's test procedures. These track test procedures have defined parameters that will ensure that AEB systems prevent crashes in a controlled testing environment. There are three general test scenarios each for testing vehicles with a lead vehicle and four scenarios for testing vehicles with a pedestrian test mannequin. These test scenarios are designed to ensure that AEB systems are able to perform appropriately in common crash scenarios. In particular, the agency has proposed that pedestrian tests be done in both daylight and darkness. The proposed requirements also include two false positive tests (driving over a steel trench plate and driving between two parked vehicles) in which the vehicle would not be permitted to brake in excess of 0.25g in addition to any manual brake application.

The final proposed requirement is that a vehicle must detect AEB system malfunctions and notify the driver of any malfunction that causes the AEB system not to meet the minimum proposed performance requirements. Malfunctions would include those attributable to sensor obstruction or saturation, such as accumulated snow or debris, dense fog, or sunlight glare. The proposal only includes a specification that the notification be visual.

To ensure test repeatability that reflects how a subject vehicle—that is the vehicle under test, would respond in the real world, this proposal includes specifications for the test devices that NHTSA would use in both the lead vehicle and pedestrian compliance tests, relying in large part on relevant International Organization for Standardization standards.

This proposal would require that all of the AEB requirements be phased in within four years of publication of a final rule. All vehicles would be required to meet all requirements associated with lead vehicle AEB and all daylight test requirements for PAEB within three years. With respect to darkness testing, there are lower maximum test speed thresholds that would have to be met within three years for some specified test procedures. All vehicles would have to meet the minimum performance requirements with higher darkness test speeds four years after the publication of a final rule. Small-volume manufacturers, final-stage manufacturers, and alterers would be provided an additional year of lead time for all requirements.

NHTSA has issued a Preliminary Regulatory Impact Analysis (PRIA) that analyzes the potential impacts of this proposed rule. The PRIA is available in the docket for this NPRM. The proposed rule is expected to substantially decrease the safety problems associated with rear-end and pedestrian crashes.

NHTSA's assessment of available safety data indicates that between 2016 and 2019, there were an average of 1.12 million rear-impact crashes involving light vehicles annually. These crashes resulted in an approximate annual average of 394 fatalities, 142,611 non-fatal injuries, and an additional 1.69 million damaged vehicles. Additionally, between 2016 and 2019, there were an average of approximately 23,000 crashes that could potentially be addressed by PAEB annually. These crashes resulted in an annual average of 2,642 fatalities and 17,689 non-fatal injuries.

AEB systems meeting the requirements of this proposed rule would have a dramatic impact on risks associated with rear-end and pedestrian crashes, even beyond the benefits assumed to occur due to NCAP and other voluntary industry adoption. In order to determine the benefits and costs of this rulemaking, NHTSA developed a baseline, which reflects how the world would look in the absence of regulation. This baseline includes an assumption that all new light vehicles will have some AEB system and that approximately 65 percent of these vehicles will have systems meeting the NCAP test procedures. Thus, the impacts of this rule are less than the impacts of AEB as a technology, as it only accounts for marginal improvements over the baseline. Accordingly, NHTSA projects that this proposed rule would reduce fatalities by 362 (124 rear-end and 238 pedestrian) annually and reduce injuries by 24,321 (21,649 rear-end and 2,672

pedestrian) annually.¹⁴ In addition, lead vehicle AEB systems would likely yield substantial benefits over the lifetime of the vehicle in property damage avoided. Further, when calculating benefits, the agency excluded many scenarios where AEB systems are still likely to lead to safety benefits but where the agency has not conducted sufficient research to quantify those benefits, including crashes involving impacts into the rear of heavy vehicles. Further, the agency excluded calendar years 2020 and 2021 from its analysis of the safety problem, as those years may be atypical, but did include a sensitivity case in the RIA, which shows greater benefits.

With regard to costs NHTSA anticipates that systems can achieve the proposed requirements through upgraded software, as all vehicles are assumed to have the necessary hardware. Therefore, the incremental cost associated with this proposed rule reflects the cost of a software upgrade that will allow current systems to achieve lead vehicle AEB and PAEB functionality that meets the requirements specified in this proposed rule. The incremental cost per vehicle is estimated at \$82.15 for each design cycle change of the model.¹⁵ When accounting for design cycles and annual sales of new light vehicles, the total

annual cost associated with this proposed rule is approximately \$282.16 million in 2020 dollars.

Table 1 summarizes the finding of the benefit-cost analysis. The projected benefits of this proposed rule greatly exceed the projected costs. The lifetime monetized net benefit of this proposed rule is projected to be between \$5.24 and \$6.52 billion with a cost per equivalent life saved of between \$500,000 and \$620,000, which is far below the Department's existing value of a statistical life saved, which is currently calculated as \$11.8 million.

TABLE 1—LIFETIME SUMMARY OF BENEFITS AND COSTS FOR PASSENGER CARS AND LIGHT TRUCKS (MILLIONS 2020\$), DISCOUNT RATE

	3% Discount rate	7% Discount rate
Benefits		
Lifetime Monetized	\$6,802	\$5,518
Costs		
Lifetime Monetized	282.16	282.16
Net Benefits		
Lifetime Monetized	6,520	5,235

TABLE 2—ESTIMATED QUANTIFIABLE BENEFITS

Benefits	
Fatalities Reduced	362
Injuries Reduced	24,321

TABLE 3—ESTIMATED INSTALLATION COSTS

Costs (2020\$)	
System installation per vehicle per design cycle.....	\$82.15
Total Fleet per year	282.16 M

TABLE 4—ESTIMATED COST EFFECTIVENESS

Cost per Equivalent Life Saved	
AEB Systems ...	\$0.50 to \$0.62 million*

* The range presented is from a 3% to 7% discount rate.

NHTSA seeks comments and suggestions on all aspects of this proposal and any alternative

requirements that would address this safety problem. NHTSA also requests comments on the proposed lead time for meeting these requirements, and how the lead time can be structured to maximize the benefits that can be realized most quickly while ensuring that the standard is practicable.

Summary of Technical Terms

The following is a brief explanation of terms and technologies used to describe AEB systems. More detailed information can be found in Appendix A to this preamble.

Radar-Based Sensors

Many AEB systems employ radar sensors. At its simplest, radar is a time-of-flight sensor technology that measures the time between when a radio wave is transmitted and when its reflection is received back at the radar sensor. This time-of-flight sensor input is used to calculate the distance between the sensor and the object that caused the reflection. Multiple or continuous sampling can also provide information about the reflecting object,

such as the speed at which it is travelling.

Camera Sensors

Cameras are passive sensors in which optical data are recorded and then processed to allow for object detection and classification. Cameras are an important part of many automotive AEB systems and are typically mounted behind the front windshield near the rearview mirror, sometimes in groups of two or more. Cameras at this location provide a good view of the road and are protected by the windshield from debris, grease, dirt, and other contaminants that could obstruct the sensor. Some systems that use two or more cameras can see stereoscopically, allowing the processing system to better determine range information along with detection and classification.

Forward Collision Warning

A forward collision warning (FCW) system uses sensors that detect objects in front of vehicles and provides an alert to the driver. An FCW system is able to use the sensors' input to determine the speed of an object in front of it and the

¹⁴ A breakdown of the severity of the injuries that would be reduced by this proposed rule can be found in Section 4.3 of the accompanying PRIA.

¹⁵ The agency includes a higher potential cost value in the RIA for "disruptive" software changes,

which could also serve as a proxy for potential additional costs, including hardware costs. However, as discussed in the RIA, that value represents a less-likely higher end assumption, while the value used here represents the agency's

main assumption. Importantly, though, even under the higher assumption, benefits still greatly exceed costs.

distance between the vehicle and the object. If the FCW system determines that the closing distance and velocity between the vehicle and the object is such that a collision may be imminent, the system is designed to induce an immediate forward crash avoidance response by the vehicle operator. FCW systems may detect impending collisions with any number of roadway obstacles, including vehicles and pedestrians. Warning systems in use today provide drivers with a visual display, such as an illuminated telltale on or near the instrument panel, an auditory signal, or a haptic signal that provides tactile feedback to the driver to warn the driver of an impending collision so the driver may intervene. FCW systems alone do not brake the vehicle.

Electronically Modulated Braking Systems

Automatic actuation of a vehicle’s brakes requires more than just technology to sense when a collision is imminent. In addition to the sensing system, hardware is needed to apply the brakes without relying on the driver to depress the brake pedal. The automatic braking system relies on two foundational braking technologies—electronic stability control to automatically activate the vehicle brakes and an antilock braking system to mitigate wheel lockup. Not only do electronic stability control and antilock braking systems enable AEB operation, these systems also modulate the braking force so that the vehicle remains stable while braking during critical driving situations where a crash with a vehicle or pedestrian is imminent.

AEB Perception and Decision System

The performance of each AEB system depends on the ability of the system to

use sensor data to appropriately detect and classify forward objects. The AEB system uses this detection and classification to decide if a collision is imminent and then avoid or mitigate the potential crash. Manufacturers and suppliers of AEB systems have worked to address unnecessary AEB activations through techniques such as sensor fusion, which combines and filters information from multiple sensors, and advanced predictive models.

Lead Vehicle Automatic Emergency Braking

A lead vehicle AEB system automatically applies the brakes to help drivers avoid or mitigate the severity of rear-end crashes. Lead vehicle AEB has two similar functions that NHTSA has referred to as crash imminent braking and dynamic brake support. Crash imminent braking (CIB) systems apply automatic braking when forward-looking sensors indicate a crash is imminent and the driver has not applied the brakes. Dynamic brake support (DBS) systems use the same sensors to supplement the driver’s application of the brake pedal with additional braking when sensors determine the driver has applied the brakes, but the brake application is insufficient to avoid an imminent crash.

This NPRM does not split the terminology of these CIB and DBS functionalities, but instead considers them both as parts of AEB. When NHTSA first tested implementation of these systems, NHTSA found that DBS systems operated with greater automatic braking application than CIB systems. However, more recent testing has shown that vehicle manufacturers’ CIB systems provide the same level of braking as DBS systems. Nevertheless, the proposed standard includes performance tests that would require an

AEB system that has both CIB and DBS functionalities.

Pedestrian Automatic Emergency Braking

PAEB systems function like lead vehicle AEB systems but detect pedestrians in front of the vehicle. PAEB systems intervene in crash imminent situations in which the pedestrian is either directly in the path of a vehicle or entering the path of the vehicle. Current PAEB systems operate primarily when the vehicle is moving in a straight line. Sensor performance is defined by sensing depth, field of view, and resolution. However, performance may be degraded during low light conditions. This NPRM proposes requiring PAEB system performance in darkness conditions using the vehicle’s headlamps for illumination.

“AEB” as Used in This NPRM

When this NPRM refers to “AEB” generally, unless the context clearly indicates otherwise, it refers to a system that has: (a) an FCW component to alert the driver to an impending collision with a forward obstacle; (b) a CIB component that automatically applies the vehicle’s brakes if the driver does not respond to the FCW; and (c) a DBS component that automatically supplements the driver’s brake application if the driver applies insufficient manual braking to avoid a crash. Furthermore, unless the context indicates otherwise, reference to AEB includes both lead vehicle AEB and PAEB.

Abbreviations Frequently Used in This Document

The following table is provided for the convenience of readers for illustration purposes only.

TABLE 5—ABBREVIATIONS

Abbreviation	Full term	Notes
AEB	Automatic Emergency Braking	Applies a vehicle’s brakes automatically to avoid or mitigate an impending forward crash.
ADAS	Advanced driver assistance system.	
CIB	Crash Imminent Braking	Applies automatic braking when forward-looking sensors indicate a crash is imminent and the driver has not applied the brakes.
CRSS	Crash Report Sampling System	A sample of police-reported crashes involving all types of motor vehicles, pedestrians, and cyclists, ranging from property-damage-only crashes to those that result in fatalities.
DBS	Dynamic Brake Support	Supplements the driver’s application of the brake pedal with additional braking when sensors determine the driver-applied braking is insufficient to avoid an imminent crash.
FARS	Fatality Analysis Reporting System	A nationwide census providing annual data regarding fatal injuries suffered in motor vehicle crashes.
FCW	Forward Collision Warning	An auditory and visual warning provided to the vehicle operator that is designed to induce an immediate forward crash avoidance response by the vehicle operator.
FMVSS	Federal Motor Vehicle Safety Standard.	

TABLE 5—ABBREVIATIONS—Continued

Abbreviation	Full term	Notes
IIHS	Insurance Institute for Highway Safety.	Public Law 117–58 (Nov. 15, 2021).
IJA	Infrastructure Investment and Jobs Act.	
ISO	International Organization for Standardization.	
Lead Vehicle AEB	Lead Vehicle Automatic Emergency Braking.	An AEB system that is capable of avoiding or mitigating collisions with a lead vehicle.
MAIS	Maximum Abbreviated Injury Scale	A means of describing injury severity based on an ordinal scale. An MAIS 1 injury is a minor injury and an MAIS 5 injury is a critical injury.
NCAP	New Car Assessment Program.	Activates when a crash imminent situation occurs between the equipped vehicle and a pedestrian in the forward path.
PAEB	Pedestrian AEB	
RFC	Request for Comments.	
VTD	Vehicle Test Device	A test device used to test AEB system performance.

II. Safety Problem

There were 38,824 fatalities in motor vehicle crashes on U.S. roadways in 2020 and early estimates put the number of fatalities at 42,915 for 2021.¹⁶ This is the highest number of fatalities since 2005. While the upward trend in fatalities may be related to increases in risky driving behaviors during the COVID–19 pandemic,¹⁷ agency data show an increase of 3,356 fatalities between 2010 and 2019.¹⁸ Motor vehicle crashes have also trended upwards since 2010, which corresponds to an increase in fatalities, injuries, and property damage.

A. Overall Rear-End Crash Problem

This NPRM proposes a new FMVSS to reduce the frequency and severity of vehicle-to-vehicle rear-end crashes and to reduce the frequency and severity of

vehicle crashes into pedestrians. NHTSA uses data from its Fatality Analysis Reporting System (FARS) and the Crash Report Sampling System (CRSS) to account for and understand motor vehicle crashes. As defined in a NHTSA technical manual relating to data entry for FARS and CRSS, rear-end crashes are incidents where the first event is defined as the frontal area of one vehicle striking a vehicle ahead in the same travel lane. In a rear-end crash, as instructed by the 2020 FARS/CRSS Coding and Validation Manual, the vehicle ahead is categorized as intending to head either straight, left or right, and is either stopped, travelling at a lower speed, or decelerating.¹⁹

In 2019, rear-end crashes accounted for 32.5 percent of all crashes, making them the most prevalent type of crash.²⁰ Fatal rear-end crashes increased from

1,692 in 2010 to 2,363 in 2019 and accounted for 7.1 percent of all fatal crashes in 2019, up from 5.6 percent in 2010. Because data from 2020 and 2021 may not be representative of the general safety problem due to the COVID–19 pandemic, the following discussion refers to data from 2010 to 2020 when discussing rear-end crash safety problem trends, and 2019 data when discussing specific characteristics of the rear-end crash safety problem. While injury and property damage-only rear-end crashes from 2010 (476,000 and 1,267,000, respectively) and 2019 (595,000 and 1,597,000, respectively) are not directly comparable due to the difference in database structure and sampling, the data indicate that these numbers have not significantly changed from 2010–2015 (NASS–GES sampling) and 2016–2019 (CRSS sampling).

TABLE 6—2010–2020 REAR-END CRASHES ALL VEHICLE TYPES BY CRASH SEVERITY²¹

First harmful event	Rear-end crash severity			
	Fatal	Injury	Property-damage-only	Total rear-end
	Number	Number	Number	Number
2010	1,692	476,000	1,267,000	1,745,000
2011	1,808	475,000	1,245,000	1,721,000
2012	1,836	518,000	1,327,000	1,847,000
2013	1,815	503,000	1,326,000	1,831,000
2014	1,971	522,000	1,442,000	1,966,000
2015	2,225	556,000	1,543,000	2,101,000
2016	2,372	661,000	1,523,000	2,187,000
2017	2,473	615,000	1,514,000	2,132,000
2018	2,459	594,000	1,579,000	2,175,000
2019	2,363	595,000	1,597,000	2,194,000
2020	2,428	417,000	1,038,000	1,457,000

¹⁶ <https://crashstats.nhtsa.dot.gov/Api/Public/ViewPublication/813266>, <https://crashstats.nhtsa.dot.gov/Api/Public/ViewPublication/813283>.

¹⁷ These behaviors relate to increases in impaired driving, the non-use of seat belts, and speeding. NHTSA also cited external studies from telematics providers that suggested increased rates of cell

phone manipulation during driving in the early part of the pandemic.

¹⁸ NHTSA’s Traffic Safety Facts Annual Report, Table 2, <https://cdan.nhtsa.gov/tsftables/tsfar.htm#>. Accessed March 28, 2023.

¹⁹ <https://crashstats.nhtsa.dot.gov/Api/Public/ViewPublication/813251> Category II Configuration D. Rear-End.

²⁰ <https://crashstats.nhtsa.dot.gov/Api/Public/ViewPublication/813141> Traffic Safety Facts 2019, Table 29.

²¹ Compiled from NHTSA’s Traffic Safety Facts Annual Report, Table 29 from 2010 to 2020, <https://cdan.nhtsa.gov/tsftables/tsfar.htm#>. Accessed March 28, 2023.

Table 7 presents a breakdown of all the crashes in 2019 by the first harmful event where rear-end crashes represent

7.1 percent of the fatal crashes, 31.1 percent of injury crashes and 33.2

percent (or the largest percent) of property damage only crashes.

TABLE 7—2019 CRASHES, BY FIRST HARMFUL EVENT, MANNER OF COLLISION, AND CRASH SEVERITY²²

First harmful event	Crash severity					
	Fatal		Injury		Property damage only	
	Number	Percent	Number	Percent	Number	Percent
Collision with Motor Vehicle in Transport						
Angle	6,087	18.2	531,000	27.7	956,000	19.9
Rear-end	2,363	7.1	595,000	31.1	1,597,000	33.2
Sideswipe	917	2.7	138,000	7.2	739,000	15.4
Head On	3,639	10.9	91,000	4.7	86,000	1.8
Other/Unknown	150	0.4	8,000	0.4	69,000	1.4
Collision with a Fixed Object Collision with Object Not Fixed	9,579	28.6	281,000	14.7	657,000	13.7
	7,826	23.4	214,000	11.2	648,000	13.5
Non-collision	2,870	8.6	58,000	3.0	54,000	1.1

The following paragraphs provide a breakdown of rear-end crashes by vehicle type, posted speed limit, light conditions and atmospheric conditions for the year 2019 based on NHTSA’s FARS, CRSS and the 2019 Traffic Safety Facts sheets.

B. Rear-End Crashes by Vehicle Type

In 2019, passenger cars and light trucks were involved in the vast

majority of rear-end crashes. NHTSA’s “Manual on Classification of Motor Vehicle Traffic Accidents” provides a standardized method for crash reporting. It defines passenger cars as “motor vehicles used primarily for carrying passengers, including convertibles, sedans, and station wagons,” and light trucks as “trucks of 10,000 pounds gross vehicle weight

rating or less, including pickups, vans, truck-based station wagons, and utility vehicles.”²³ The 2019 data show that crashes where a passenger car or light truck is a striking vehicle represent at least 70 percent of fatal rear-end crashes, 95 percent of crashes resulting in injury, and 96 percent of damage only crashes (See Table 8).²⁴

TABLE 8—REAR-END CRASHES WITH IMPACT LOCATION—FRONT, BY VEHICLE TYPE, IN 2019²⁵

Vehicle body type, initial impact-front	Fatal	Injury	Property damage only
Passenger Car	888	329,000	906,000
Light Truck	910	245,000	642,000
All Other	762	31,000	57,000

C. Rear-End Crashes by Posted Speed Limit

When looking at posted speed limit and rear-end crashes, data show that the

majority of the crashes happened in areas where the posted speed limit was 60 mph (97 km/h) or less. Table 9 shows the rear-end crash data by posted speed limit and vehicle type from 2019. About

60 percent of fatal crashes were on roads with a speed limit of 60 mph (97 km/h) or lower. That number is 73 percent for injury crashes and 78 percent for property damage-only crashes.

TABLE 9—2019 REAR-END CRASHES INVOLVING PASSENGER CARS, MPVS, AND LIGHT TRUCKS WITH FRONTAL IMPACT BY POSTED SPEED LIMIT^{26 27}

Vehicles by posted speed limit	Passenger cars, light trucks, by crash severity					
	Fatal		Injury		Property-damage-only	
	Number	Percent	Number	Percent	Number	Percent
25 mph or less	16	1	28,000	5	103,000	7
30	30	2	24,000	4	78,000	5
35	95	5	91,000	16	267,000	17
40	87	5	66,000	11	175,000	11
45	223	12	129,000	22	373,000	24

²² NHTSA’s Traffic Safety Facts Annual Report, Table 29 for 2019, <https://cdan.nhtsa.gov/tsfables/tsfar.htm#>. Accessed March 28, 2023.

²³ <https://www.fars.nhtsa.dot.gov/help/terms.aspx>.

²⁴ <https://crashstats.nhtsa.dot.gov/Api/Public/ViewPublication/813141> Traffic Safety Facts 2019.

²⁵ Generated from FARS and CRSS databases (<https://www.nhtsa.gov/file-downloads?p=nhtsa/downloads/FARS/2019/National/>, <https://www.nhtsa.gov/file-downloads?p=nhtsa/downloads/CRSS/2019/>, accessed October 17, 2022).

www.nhtsa.gov/file-downloads?p=nhtsa/downloads/CRSS/2019/, accessed October 17, 2022).

TABLE 9—2019 REAR-END CRASHES INVOLVING PASSENGER CARS, MPVs, AND LIGHT TRUCKS WITH FRONTAL IMPACT BY POSTED SPEED LIMIT^{26 27}—Continued

Vehicles by posted speed limit	Passenger cars, light trucks, by crash severity					
	Fatal		Injury		Property-damage-only	
	Number	Percent	Number	Percent	Number	Percent
50	99	6	19,000	3	58,000	4
55	401	22	55,000	10	122,000	8
60	133	7	12,000	2	31,000	2
65 and above	684	38	75,000	13	153,000	10
All other	30	2	75,000	13	187,000	12
Total	1,798	100	574,000	100	1,547,000	100

D. Rear-End Crashes by Light Condition

Slightly more fatal rear-end crashes (51 percent) occurred during daylight than during dark-lighted and dark-not-lighted conditions combined (43

percent) in 2019. However, injury and property damage-only rear-end crashes were reported to have happened overwhelmingly during daylight, at 76 percent for injury rear-end crashes and 80 percent for property-damage-only

rear-end crashes. Table 10 presents a summary of all 2019 rear-end crashes of light vehicles by light conditions, where the impact location is the front of a light vehicle.

TABLE 10—2019 REAR-END CRASHES WITH LIGHT VEHICLE FRONT IMPACT, BY LIGHT CONDITION²⁸

Light condition	Crash severity					
	Fatal		Injury		Property Damage-only	
	Percent	Number	Percent	Number	Percent	Number
Daylight	925	51	436,000	76	1,232,000	80
Dark—Not Lighted	438	24	28,000	5	59,000	4
Dark—Lighted	349	19	86,000	15	192,000	12
All Other	86	5	24,000	4	65,000	4
Total	1,798	100	574,000	100	1,547,000	100

E. Rear-End Crashes by Atmospheric Conditions

In 2019, the majority of rear-end crashes of light vehicles were reported to occur during clear skies with no

adverse atmospheric conditions. These conditions were present for 72 percent of all fatal rear-end crashes, while 14 percent of fatal rear-end crashes were reported to occur during cloudy conditions. Similar trends are reported

for injury and property damage only crashes. A brief summary of 2019 rear-end crashes of light vehicle with frontal impact by atmospheric conditions is presented in Table 11.

TABLE 11—2019 REAR-END CRASHES INVOLVING LIGHT VEHICLES WITH FRONTAL IMPACT, BY ATMOSPHERIC CONDITIONS²⁹

Crashes atmospheric conditions	Crash severity					
	Fatal		Injury		Property damage-only	
	Percent	Number	Percent	Number	Percent	Number
Clear, No Adverse	1,295	72	426,000	74	1,113,000	72
Cloudy	247	14	87,000	15	245,000	16
All Other	256	14	61,000	11	189,000	12
Total	1,798	100	574,000	100	1,547,000	100

²⁶ Generated from FARS and CRSS databases (<https://www.nhtsa.gov/file-downloads?p=nhtsa/downloads/FARS/2019/National/>, <https://www.nhtsa.gov/file-downloads?p=nhtsa/downloads/CRSS/2019/>, accessed October 17, 2022).

²⁷ Total percentages may not equal the sum of individual components due to independent rounding throughout the Safety Problem section.

²⁸ Generated from FARS and CRSS databases (<https://www.nhtsa.gov/file-downloads?p=nhtsa/downloads/FARS/2019/National/>, <https://www.nhtsa.gov/file-downloads?p=nhtsa/downloads/CRSS/2019/>, accessed October 17, 2022).

²⁹ Generated from FARS and CRSS databases (<https://www.nhtsa.gov/file-downloads?p=nhtsa/downloads/FARS/2019/National/>, <https://www.nhtsa.gov/file-downloads?p=nhtsa/downloads/CRSS/2019/>, accessed October 17, 2022).

F. Pedestrian Fatalities and Injuries

While the number of fatalities from motor vehicle traffic crashes is increasing, pedestrian fatalities are increasing at a greater rate than the general trend and becoming a larger percentage of total fatalities. In 2010, there were 4,302 pedestrian fatalities (13 percent of all fatalities), which has increased to 6,272 (17 percent of all fatalities) in 2019. The latest agency

estimation data indicate that there were 7,342 pedestrian fatalities in 2021.³⁰ Since data from 2020 and 2021 may not be representative of the general safety problem due to the COVID-19 pandemic, the following sections refer to data from 2010 to 2020 when discussing pedestrian safety problem trends, and 2019 data when discussing specific characteristics of the pedestrian safety problem. While the number of

pedestrian fatalities is increasing, the number of pedestrians injured in crashes from 2010 to 2020 has not changed significantly, with exception of the 2020 pandemic year. In Table 12, the number and percentage of pedestrian fatalities and injuries for the 2010 to 2020 period is presented in relationship to the total number of fatalities and total number of people injured in all crashes.

TABLE 12—2010–2020 TRAFFIC CRASH FATALITIES AND PEDESTRIAN FATALITIES, AND INJURED PEOPLE AND PEDESTRIANS INJURED³¹

Year	Total fatalities ¹	Pedestrian fatalities ¹		Total people injured ²	Pedestrian injured ²	
		Number	Percent of total fatalities		Number	Percent of total injured
2010	32,999	4,302	13	2,248,000	70,000	3
2011	32,479	4,457	14	2,227,000	69,000	3
2012	33,782	4,818	14	2,369,000	76,000	3
2013	32,893	4,779	15	2,319,000	66,000	3
2014	32,744	4,910	15	2,343,000	65,000	3
2015	35,484	5,494	15	2,455,000	70,000	3
2016	37,806	6,080	16	3,062,000	86,000	3
2017	37,473	6,075	16	2,745,000	71,000	3
2018	36,835	6,374	17	2,710,000	75,000	3
2019	36,355	6,272	17	2,740,000	76,000	3
2020	38,824	6,516	17	2,282,015	55,000	2

¹ Data source: FARS 2010–2019, 2020 Annual Report (ARF).

² Data source: NASS GES 2010–2015, CRSS 2016–2019.

The following sections present a breakdown of pedestrian fatalities and injuries by initial impact point, vehicle type, posted speed limit, lighting condition, pedestrian age, and light conditions for the year 2019.

G. Pedestrian Fatalities and Injuries by Initial Point of Impact and Vehicle Type

In 2019, the majority of pedestrian fatalities, 4,638 (74 percent of all pedestrian fatalities), and injuries, 52,886 (70 percent of all pedestrian injuries), were in crashes where the

initial point of impact on the vehicle was the front. When the crashes are broken down by vehicle body type, the majority of pedestrian fatalities and injuries occur where the initial point of impact was the front of a light vehicle (4,069 pedestrian fatalities and 50,831 pedestrian injuries) (see Table 13).³²

TABLE 13—2019 PEDESTRIAN FATALITIES AND INJURIES, BY INITIAL POINT OF IMPACT FRONT AND VEHICLE BODY TYPE³³

Vehicle body type, initial impact—front	Crash severity			
	Pedestrian fatalities		Pedestrian injuries	
	Number	Percent	Number	Percent
Passenger Car	1,976	43	30,968	59
Light Truck	2,093	45	19,863	38
All Other	569	12	2,055	4
Total	4,638	100	52,886	100

H. Pedestrian Fatalities and Injuries by Posted Speed Limit Involving Light Vehicles

In 2019, the majority of pedestrian fatalities from crashes involving light

vehicles with the initial point of impact as the front occurred on roads where the posted speed limit was 45 mph or less, (about 70 percent). There is a near even split between the number of pedestrian

fatalities in 40 mph and lower speed zones and in 45 mph and above speed zones (50 percent and 47 percent respectively with the remaining unknown, not reported or lacking). As

³⁰ <https://crashstats.nhtsa.dot.gov/Api/Public/ViewPublication/813298> Early Estimates of Motor Vehicle Traffic Fatalities And Fatality Rate by Sub-Categories in 2021, May 2022.

³¹ <https://crashstats.nhtsa.dot.gov/Api/Public/ViewPublication/813079> Pedestrian Traffic Facts

2019 Data, May 2021, <https://crashstats.nhtsa.dot.gov/Api/Public/ViewPublication/813310> Pedestrian Traffic Facts 2020, Data May 2022.

³² As described previously, passenger cars and light trucks are the representative population for

vehicles with a GVWR of 4,536 kg (10,000 lbs.) or less.

³³ NHTSA's Traffic Safety Facts Annual Report, Table 99 for 2019, <https://cdan.nhtsa.gov/tsfables/tsfar.htm#Accessed> March 28, 2023.

for pedestrian injuries, in a large number of cases, the posted speed limit is either not reported or unknown (*i.e.*, about 34 percent of the sampled data). In situations where the posted speed

limit is known, 57 percent of the pedestrians were injured when the posted speed limit was 40 mph or below, and 9 percent when the posted speed limit was above 40 mph. Table 14

shows the number of pedestrian fatalities and injuries for each posted speed limit.

TABLE 14—2019 PEDESTRIAN FATALITIES AND INJURIES INVOLVING LIGHT VEHICLES, BY POSTED SPEED LIMIT ³⁴

Posted speed limit	Crash severity			
	Pedestrians fatalities		Pedestrian injuries	
	Number	Percent	Number	Percent
5 mph	3	0.07	185	0.36
10 mph	7	0.17	287	0.56
15 mph	10	0.25	865	1.70
20 mph	14	0.34	479	0.94
25 mph	346	8.50	9,425	18.54
30 mph	325	7.99	4,254	8.37
35 mph	765	18.80	9,802	19.28
40 mph	551	13.54	3,703	7.28
45 mph	821	20.18	3,094	6.09
50 mph	177	4.35	302	0.59
55 mph	463	11.38	546	1.07
60 mph	105	2.58	130	0.26
65 mph	199	4.89	241	0.47
70 mph	103	2.53	105	0.21
75 mph	19	0.47	4	0.01
80 mph	2	0.05	25	0.05
Not Reported	118	2.90	15,017	29.54
Unknown	16	0.39	176	0.35
No Statutory Limit/Non-Trafficway Area	25	0.61	2,191	4.31
Total	4,069	100	50,831	100

I. Pedestrian Fatalities and Injuries by Lighting Condition Involving Light Vehicles

The majority of pedestrian fatalities where a light vehicle strikes a

pedestrian with the front of the vehicle occurred in dark lighting conditions, 3,131 (75 percent). There were 20,645 pedestrian injuries (40 percent) in dark lighting conditions and 27,603

pedestrian injuries (54 percent) in daylight conditions.

TABLE 15—2019 PEDESTRIAN FATALITIES AND INJURIES INVOLVING LIGHT VEHICLES, BY LIGHTING CONDITION ³⁵

Light condition	Crash severity			
	Pedestrian fatalities		Pedestrian injuries	
	Number	Percent	Number	Percent
Daylight	767	19	27,603	54
Dark–Not Lighted	1,464	36	4,551	9
Dark–Lighted	1,621	40	15,996	31
Dark–Unknown Light	46	1	98	0
All Other	171	4	2,583	5
Total	4,069	100	50,831	100

J. Pedestrian Fatalities and Injuries by Age Involving Light Vehicles

In 2019, 646 fatalities and approximately 106,600 injuries involved children aged 9 and below. Of these, 68 fatalities and approximately 2,700 injuries involved pedestrians aged 9 and below in crashes with the front of a light

vehicle. As shown in Table 16, the first two age groups (less than age 5 and 5 to 9) each represent less than 1 percent of the total pedestrian fatalities in crashes with the front of a light vehicle. These age groups also represent about 1.5 and 3.8 percent of the total pedestrian injuries in crashes with the

front of a light vehicle, respectively. In contrast, age groups between age 25 and 69 each represent approximately 7 percent of the total pedestrian fatalities in crashes with the front of a light vehicle, with the 55 to 59 age group having the highest percentage at 10.9 percent. Pedestrian injury percentages

³⁴ The accompanying PRIA estimates the impacts of the rule based on the estimated travel speed of the striking vehicle. This table presents the speed

limit of the roads on which pedestrian crashes occur.

³⁵ Generated from FARS and CRSS databases (<https://www.nhtsa.gov/file-downloads?p=nhtsa/>

[downloads/FARS/2019/National/](https://www.nhtsa.gov/file-downloads?p=nhtsa/downloads/FARS/2019/National/), <https://www.nhtsa.gov/file-downloads?p=nhtsa/downloads/CRSS/2019/>, accessed October 17, 2022).

were less consistent, but distributed similarly, to pedestrian fatalities, with lower percentages reflected in children

aged 9 and below and adults over age 70.

TABLE 16—2019 PEDESTRIANS FATALITIES AND INJURIES IN TRAFFIC CRASHES INVOLVING LIGHT VEHICLES BY INITIAL POINT OF IMPACT FRONT³⁶ AND AGE GROUP³⁷

Age group	United States population (thousand)	Percent of population	Pedestrian fatalities		Pedestrians injuries	
			Light vehicle front-impact ped. fatalities	Percent of total pedestrian fatalities in light vehicle front-impact crashes	Light vehicle front-impact ped. injuries	Percent of total pedestrian injuries in light vehicle front-impact crashes
<5	19,736	6.1	37	0.9	770	1.5
5–9	20,212	6.2	31	0.8	1,907	3.8
10–14	20,827	6.4	58	1.4	2,830	5.6
15–20	20,849	6.4	159	3.9	5,673	11.2
21–24	21,254	6.6	173	4.3	3,190	6.3
25–29	23,277	7.2	287	7.1	4,394	8.6
30–34	21,932	6.8	315	7.7	3,735	7.3
35–39	21,443	6.6	316	7.8	3,636	7.2
40–44	19,584	6.0	277	6.8	2,812	5.5
45–49	20,345	6.3	294	7.2	2,745	5.4
50–54	20,355	6.3	350	8.6	3,311	6.5
55–59	21,163	6.5	442	10.9	3,678	7.2
60–64	20,592	6.3	379	9.3	3,469	6.8
65–69	17,356	5.4	303	7.4	2,594	5.1
70–74	14,131	4.4	207	5.1	1,724	3.4
75–79	9,357	2.9	172	4.2	1,136	2.2
80+	11,943	3.7	252	6.2	1,127	2.2
Unknown			17	0.4	2,103	4.1
Total			4,069	100	50,831	100

K. AEB Target Population

AEB technology is not expected to prevent all rear-end crashes or pedestrian fatalities. In order to determine the portion of the rear-end and pedestrian fatality population that could be affected by AEB, NHTSA used the FARS and CRSS databases to derive a target population.

Fatality data were derived from FARS and data on property damage vehicle crashes and injuries were derived from CRSS. The agency computed annualized averages for years 2016 to 2019 from fatalities and injuries.

For lead vehicle AEB, NHTSA first applied filters to ensure the target population included only rear-end crashes, excluding crashes other than those resulting from a motor vehicle in transport and only including crashes where the striking vehicle had frontal damage and the struck vehicle had rear-end damage. NHTSA conservatively excluded crashes with more than two vehicles because two-vehicle crashes most closely mirror the test track testing which includes a single lead vehicle. NHTSA only included crashes where a light vehicle struck another light vehicle. The striking vehicle was limited to light vehicles because this

proposal would only apply to light vehicles. The struck vehicle was limited to light vehicles because the specifications for the lead vehicle in testing were derived exclusively from light vehicles. The crash population was further limited to cases where the subject vehicle was traveling in a straight line and either braked or did not brake to avoid the crash (excluding instances where the vehicle attempted to avoid the crash in some other manner). These exclusions were applied because AEB systems may suppress automatic braking when the driver attempts to avoid a collision by some other action, such as turning. Finally, the crash scenarios were limited to those where the lead vehicle was either stopped, moving, or decelerating along the same path as the subject vehicle. Other maneuvers, such as crashes in which the vehicle turned prior to the crash, were excluded because current sensor systems have a narrow field of view that does not provide sufficient information to the perception system regarding objects in the vehicle's turning path.

For PAEB, the target population was also identified based on reported fatalities (in FARS data) and injuries (in

GES and CRSS data). Each of the estimated target population values were based on a six-year average (2014 through 2019). NHTSA applied filters such that only crashes involving a single light vehicle and pedestrians where the first harmful event was contact with the pedestrian are considered in the analysis. Further, the impact area was restricted to the front of the vehicle because the performance proposed in this rule is limited to forward vehicle movement. Additionally, the vehicle's pre-event movement (*i.e.*, the vehicle's activity prior to the driver's realization of the impending crash) was traveling in a straight line and the pedestrian movement was determined to be either crossing the vehicle's path or along the vehicle's path to match the track testing being proposed.

After applying these filters, NHTSA has tentatively concluded that AEB technology could potentially address up to 3,036 fatalities (394 lead vehicle and 2,642 pedestrian), 160,309 injuries (142,611 lead vehicle and 17,698 pedestrian), and 1,119,470 property damage only crashes (only lead vehicle). These crashes represent 15 percent and 14 percent of fatalities and injuries resulting from rear end crashes,

³⁶ Generated from FARS and CRSS databases (<https://www.nhtsa.gov/file-downloads?p=nhtsa/downloads/FARS/2019/National/>, <https://www.nhtsa.gov/file-downloads?p=nhtsa/downloads/CRSS/2019/>, accessed October 17, 2022).

³⁷ <https://www.census.gov/data/tables/2019/demo/age-and-sex/2019-age-sex-composition.html>, Table 12.

respectively and 43 percent and 28 percent of fatalities and injuries from pedestrian crashes. These crashes also represent 8.4 percent of total roadway fatalities, 5.9 percent of total roadway injuries, and 23 percent of property damage only crashes.

NHTSA has restricted the target population to two-vehicle crashes although FCW and AEB would likely provide safety benefits in multi-vehicle crashes even when the first impact would be completely avoided with FCW and AEB.³⁸ NHTSA also limited the target population to light vehicle to light vehicle crashes because NHTSA does not have data on how AEB systems would respond to other vehicle types such as heavy vehicles or motorcycles. NHTSA is currently researching light vehicle AEB performance in these situations.

III. Data on Effectiveness of AEB in Mitigating Harm

Forward collision warning systems were among the first generation of advanced driver assistance system technologies designed to help drivers avoid an impending crash.³⁹ In 2008, when NHTSA decided to include ADAS technologies in the NCAP program, FCW was selected because the agency believed (1) this technology addressed a major crash problem; (2) system designs existed that could mitigate this safety problem; (3) safety benefit projections were assessed; and (4) performance tests and procedures were available to ensure an acceptable performance level. At the time, the agency estimated that FCW systems were 15 percent effective in preventing rear-end crashes. More recently, in a 2017 study, the Insurance Institute for Highway Safety (IIHS) found that FCW systems may be more effective than NHTSA's initial estimates indicated.⁴⁰ IIHS found that FCW

systems reduced rear-end crashes by 27 percent.

When FCW is coupled with AEB, the system becomes more effective at reducing rear-end crashes. A limitation of FCW systems is that they are designed only to warn the driver, but they do not provide automatic braking of the vehicle. From a functional perspective, research suggests that active braking systems, such as AEB, provide greater safety benefits than corresponding warning systems, such as FCW. In a recent study sponsored by General Motors (GM) to evaluate the real-world effectiveness of ADAS technologies (including FCW and AEB) on 3.8 million model year 2013–2017 GM vehicles, the University of Michigan's Transportation Research Institute (UMTRI) found that, for frontal collisions, camera-based FCW systems produced an estimated 21 percent reduction in rear-end striking crashes, while the AEB systems studied (which included a combination of camera-only, radar-only, and fused camera-radar systems) produced an estimated 46 percent reduction in the same crash type.⁴¹ Similarly, in a 2017 study, IIHS found that vehicles equipped with FCW and AEB showed a 50 percent reduction for the same crash type.⁴²

NHTSA has found that current AEB systems often integrate the functionalities of FCW and AEB into one frontal crash prevention system to deliver improved real-world safety performance. Consequently, NHTSA believes that FCW should now be considered a component of lead vehicle AEB and PAEB, and has, in fact, developed a test in NCAP that assesses FCW in the same test that evaluates a vehicle's AEB and PAEB performance.⁴³

Not only are AEB systems proving effective, data indicate there is high consumer acceptance of the current systems. In a 2019 subscriber survey by Consumer Reports, 81 percent of vehicle owners reported that they were satisfied with AEB technology, 54 percent said that it had helped them avoid a crash,

and 61 percent stated that they trusted the system to work every time.⁴⁴

However, NHTSA is aware of data and other information indicating potential opportunities for AEB improvement. The data indicate the potential of AEB to reduce fatal crashes, especially if AEB systems performed at higher speeds. While AEB systems on currently available vehicles are highly effective at lower speed testing, some such systems do not perform well in tests done at higher speeds.

IV. NHTSA's Earlier Efforts Related to AEB

NHTSA sought to provide the public with valuable vehicle safety information by actively supporting development and implementation of AEB technologies through research and development and through NHTSA's NCAP. NHTSA also sought to incentivize installation of AEB and PAEB on vehicles by encouraging the voluntary installation of AEB systems by automakers through a voluntary industry commitment, resulting in participating automakers committing to installing an AEB system that met certain performance thresholds on most light duty cars and trucks by September 1, 2022, and on nearly all light vehicles by September 1, 2025.

A. NHTSA's Foundational AEB Research

NHTSA conducted extensive research on AEB systems to support development of the technology and eventual deployment in vehicles. There were three main components to this work. The agency conducted early research on FCW systems that warn drivers of potential rear-end crashes with other vehicles. This was followed by research into AEB systems designed to prevent or mitigate rear-end collisions through automatic braking. Later, NHTSA evaluated AEB systems designed to prevent or mitigate collisions with pedestrians in a vehicle's forward path.

1. Forward Collision Warning Research

NHTSA's earliest research on FCW systems began in the 1990s, at a time when the systems were under development and evaluation had been conducted primarily by suppliers and vehicle manufacturers. NHTSA collaborated with industry stakeholders to identify the specific crash types that an FCW system could be designed to address, the resulting minimum functional requirements, and potential

³⁸ As discussed in the PRIA for this NPRM, NHTSA decided not to include multi-vehicle crashes in the target population because it would be difficult to estimate safety benefits for occupants in the second and or third vehicles due to limited data.

³⁹ ADAS technologies use advanced technologies to assist drivers in avoiding a crash. NCAP currently recommends four kinds of ADAS technologies to prospective vehicle purchasers—forward collision warning, lane departure warning, crash imminent braking, and dynamic brake support (the latter two are considered AEB). <https://www.nhtsa.gov/equipment/driver-assistance-technologies>. In a March 2, 2022 request for comments notice, *infra*, NHTSA proposed to add four more ADAS technologies to NCAP.

⁴⁰ Cicchino, J.B. (2017, February), Effectiveness of forward collision warning and autonomous emergency braking systems in reducing front-to-rear crash rates, *Accident Analysis and Prevention*, 2017 Feb;99(Pt A):142–152. <https://doi.org/10.1016/j.aap.2016.11.009>.

⁴¹ The Agency notes that the FCW effectiveness rate (21%) observed by UMTRI is similar to that observed by IIHS in its 2019 study (27%). Differences in data samples and vehicle selection may contribute to the specific numerical differences. Regardless, the AEB effectiveness rate observed by UMTRI (46%) was significantly higher than the corresponding FCW effectiveness rate observed in either the IIHS or UMTRI study.

⁴² Cicchino, J.B. (2017, February), Effectiveness of forward collision warning and autonomous emergency braking systems in reducing front-to-rear crash rates, *Accident Analysis and Prevention*, 2017 Feb;99(Pt A):142–152, <https://doi.org/10.1016/j.aap.2016.11.009>.

⁴³ 87 FR 13486 March 9, 2022, proposed update to NCAP's FCW testing.

⁴⁴ Consumer Reports, (2019, August 5), *Guide to automatic emergency braking: How AEB can put the brakes on car collisions*, <https://www.consumerreports.org/car-safety/automatic-emergency-braking-guide/>.

objective test procedures for evaluation.⁴⁵ In the late 1990s, NHTSA worked with industry to conduct a field study, the Automotive Collision Avoidance System Program. NHTSA later contracted with the Volpe National Transportation Systems Center (Volpe) to conduct analyses of data recorded during that field study.⁴⁶ From this work, NHTSA learned about the detection and alert timing and information about warning signal modality (auditory, visual, etc.) of FCW systems, and predominant vehicle crash avoidance scenarios where FCW systems could most effectively play a role in alerting a driver to brake and avoid a crash. In 2009, NHTSA synthesized this research in the development and conduct of controlled track test assessments on three vehicles equipped with FCW.⁴⁷

Because FCW systems are designed only to warn the driver and not to provide automatic braking for meaningful speed reduction of the vehicle, NHTSA continued to research AEB systems.⁴⁸

2. AEB Research To Prevent Rear-End Impacts With a Lead Vehicle

NHTSA's research and test track performance evaluations of AEB began around 2010. The agency began a thorough examination of the state of forward-looking advanced braking technologies, analyzing their performance and identifying areas of

concern or uncertainty, to better understand their safety potential. NHTSA issued a report⁴⁹ and a request for comments notice seeking feedback on its CIB and DBS research in July 2012.⁵⁰ Specifically, NHTSA wanted to enhance its knowledge further and help guide its continued efforts pertaining to AEB effectiveness, test operation (including how to ensure repeatability using a target or surrogate vehicle), refinement of performance criteria, and exploring the need for an approach and criteria for "false positive" tests to minimize the unintended negative consequences of automatic braking in non-critical driving situations.

NHTSA considered feedback it received on the RFC and conducted additional testing to support further development of the test procedures. The agency documented its work in two additional reports, "Automatic Emergency Braking System Research Report" (August 2014)⁵¹ and "NHTSA's 2014 Automatic Emergency Braking (AEB) Test Track Evaluations" (May 2015),⁵² and in accompanying draft CIB and DBS test procedures.⁵³

In the follow-on tests, NHTSA found that CIB and DBS systems commercially available on several different production vehicles could be tested successfully to the agency's defined performance measures. NHTSA developed performance measures to define the performance CIB and DBS systems should attain to help drivers avoid or at least mitigate injury risk in rear-end crashes. The agency found that systems meeting the performance measures have the potential to reduce the number of rear-end crashes as well as deaths and injuries that result from these crashes. NHTSA used the research findings to develop NCAP's procedures for assessing the performance of vehicles with AEB and other crash-avoidance technologies⁵⁴ and for testing vehicles

at higher speeds. The findings also provided the foundation to upgrade NCAP's current AEB tests, as discussed in NHTSA's March 9, 2022, request for comments notice,⁵⁵ and the development of this NPRM.

3. AEB Research To Prevent Vehicle Impacts With Pedestrians

NHTSA began research on PAEB systems in 2011.⁵⁶ The agency worked on a project with Volpe and the Crash Avoidance Metrics Partnership (CAMP)⁵⁷ to develop preliminary PAEB test methods. The goal of the project was to develop and validate minimum performance requirements and objective test procedures for forward-looking PAEB systems intended to address in-traffic, pedestrian crash scenarios.

As part of this work, Volpe conducted an analysis of available crash data and found four common pedestrian pre-crash scenarios. These are when the vehicle is: 1. Heading in a straight line and a pedestrian is crossing the road; 2. turning right and a pedestrian is crossing the road; 3. turning left and a pedestrian is crossing the road; and 4. heading in a straight line and a pedestrian is walking along or against traffic. Understanding the pre-crash factors associated with pedestrian crashes led to the development of the draft research test methods, a set of test equipment requirements, a preliminary evaluation plan, and development of a 50th percentile adult male mannequin made from closed-cell foam. The culmination of this work was documented in a research report, "Objective Tests for Forward Looking Pedestrian Crash Avoidance/Mitigation Systems: Final Report" (June 2014).⁵⁸

and dynamic brake support (AEB) to prospective vehicle purchasers and identifies vehicles that meet NCAP performance test criteria for these technologies.

⁵⁵ 87 FR 13452, March 2, 2022.

⁵⁶ At that time, the agency used the term "pedestrian crash avoidance and mitigation (PCAM)" research.

⁵⁷ The participating companies that worked on this project included representatives from Continental, Delphi Corporation, Ford Motor Company, General Motors, and Mercedes-Benz.

⁵⁸ Carpenter, M.G., Moury, M.T., Skvarce, J.R., Struck, M. Zwicky, T.D., & Kiger, S.M. (2014, June), Objective Tests for Forward Looking Pedestrian Crash Avoidance/Mitigation Systems: Final report (Report No. DOT HS 812 040), Washington, DC: National Highway Traffic Safety Administration.

⁴⁵ This research was documented in a report, "Development and Validation of Functional Definitions and Evaluation Procedures for Collision Warning/Avoidance Systems," Kiefer, R., et al., DOT HS 808 964, August 1999. Additional NHTSA FCW research is described in Zador, Pub. L., et al., "Final Report—Automotive Collision Avoidance System (ACAS) Program," DOT HS 809 080, August 2000; and Ference, J.J., et al., "Objective Test Scenarios for Integrated Vehicle-Based Safety Systems," Paper No. 07-0183, Proceedings of the 20th International Conference for the Enhanced Safety of Vehicles, 2007.

⁴⁶ Najm, W.G., Stearns, M.D., Howarth, H., Koopmann, J., and Hitz, J., "Evaluation of an Automotive Rear-End Collision Avoidance System," DOT HS 810 569, April 2006 and Najm, W.G., Stearns, M.D., and Yanagisawa, M., "Pre-Crash Scenario Typology for Crash Avoidance Research," DOT HS 810 767, April 2007.

⁴⁷ Forkenbrock, G., O'Harra, B., "A Forward Collision Warning (FCW) Program Evaluation, Paper No. 09-0561, Proceedings of the 21st International Technical Conference for the Enhanced Safety of Vehicles, 2009.

⁴⁸ Some FCW systems use haptic brake pulses to alert the driver of a crash-imminent driving situation, but the pulses are not intended to slow the vehicle.

⁴⁹ The agency's initial research and analysis of CIB and DBS systems were documented in a report, "Forward-Looking Advanced Braking Technologies: An analysis of current system performance, effectiveness, and test protocols" (June 2012). <https://www.regulations.gov>, NHTSA 2012-0057-0001.

⁵⁰ 77 FR 39561.

⁵¹ <https://www.regulations.gov>, NHTSA 2012-0057-0037.

⁵² DOT HS 812 166.

⁵³ <https://www.regulations.gov>, NHTSA 2012-0057-0038.

⁵⁴ NCAP recommends forward collision warning, lane departure warning, crash imminent braking

NHTSA continued to refine the CAMP test procedures in pursuit of objective and repeatable test procedures using production vehicles equipped with PAEB systems. In doing so, NHTSA evaluated adult, child, non-articulating and articulating mannequins, walking and running speed capabilities, mannequin radar cross section characteristics, and mannequin position accuracy and control.⁵⁹ The evaluated mannequins and their characteristics represented the largest portion of the crash problem. NHTSA also updated its real-world pedestrian crash data analysis in 2017.⁶⁰

In November 2019, NHTSA published a draft research test procedure that provided the methods and specifications for collecting performance data on PAEB systems for light vehicles.⁶¹ The test procedures were developed to evaluate the PAEB performance in the two most frequent pre-crash scenarios involving pedestrians: where the pedestrian crosses the road in front of the vehicle and where the pedestrian walks alongside the road in the path of the vehicle. NHTSA focused its 2019 draft research test procedures on these two scenarios because a 2017 crash data study suggested they collectively represented 90 percent of pedestrian fatalities (64 percent and 28 percent, respectively). In contrast, the study found that the turning right and turning left scenarios were found to only account for 1 percent and 4 percent of pedestrian fatalities, respectively. NHTSA further focused the 2019 test procedures on PAEB-addressable crashes. PAEB systems offered at the time were not offering a wider field of view necessary for detection and braking in the turning scenarios. These two scenarios present different challenges due to the relative angles and distances between subject vehicle and pedestrian and could require additional hardware resulting in added cost. NHTSA's consideration of including the turning scenarios is further discussed in the PRIA accompanying this NPRM. The draft test procedures described in this document rely on the use of pedestrian mannequins for testing purposes.

⁵⁹ Albrecht, H., "Objective Test Procedures for Pedestrian Automatic Emergency Braking Systems," SAE Government/Industry Meeting, January 25–27, 2017.

⁶⁰ Yanagisawa, M., Swanson, E., Azeredo, P., Najm, W., "Estimation of Potential Safety Benefits for Pedestrian Crash Avoidance/Mitigation Systems, DOT HS 812 400, April 2017.

⁶¹ <https://regulations.dot.gov>, Docket No. NHTSA–2019–0102.

4. Bicycle and Motorcycle AEB

NHTSA is actively conducting research to characterize the performance of AEB systems in response to bicycle and motorcycles in the same scenarios as NHTSA's lead vehicle AEB testing, in both daylight and darkness conditions. NHTSA tested five vehicles with bicycle and motorcycle AEB and also tested with a vehicle surrogate as a control for AEB system performance. In addition to characterizing the performance of the five vehicles, this testing also allows NHTSA to refine its test procedures to determine whether any changes would be needed to test bicycle or motorcycle AEB.

Preliminary results suggest that the lane position of the test device, the lighting conditions, the positioning of a lead vehicle, and speed all have a significant effect on the performance of AEB systems relative to bicycles and motorcycles. However, there is no discernable pattern across vehicles tested, suggesting that performance is dependent upon specific test scenario definition. Further, preliminary testing has raised issues with the design of the bicycle and motorcycle surrogates and their impact on the vehicles under test. This report is expected to be completed by the end of 2023. The results from this research, and other future research, may lead to efforts to define test procedures, refine the bicycle and motorcycle surrogate devices, and characterize AEB system performance in response to additional test devices (scooters, mopeds, wheelchairs, or other assisted walking devices).

B. NHTSA's New Car Assessment Program

1. FCW Tests

In 2007, based on the research discussed above, NHTSA issued a notice requesting public comment on including rear-end crash warning/avoidance systems in NCAP.⁶² The technology under consideration at the time included forward vehicle sensing with warning or braking. In 2008, based upon feedback and further agency analysis, NHTSA published a final decision notice announcing its intent to include FCW in NCAP as a recommended technology and identify for consumers which vehicles have the technology.

To ensure that NCAP identified only vehicles that had FCW systems that satisfied a minimum level of performance, NHTSA adopted specific

⁶² 72 FR 3473 (January 25, 2007). NHTSA published a report in conjunction with this notice titled, "The New Car Assessment Program (NCAP): Suggested Approaches for Future Enhancements."

performance tests and thresholds and time-to-collision-based alert criteria that a system had to satisfy to be distinguished in NCAP as a vehicle equipped with the recommended technology. NCAP informs consumers that a particular vehicle has a recommended technology when NHTSA has data verifying that the vehicle's system meets the minimum performance threshold set by NHTSA for acceptable performance. If a vehicle's system meets the performance threshold using the test method NHTSA specifies, NHTSA uses a checkmark to indicate on the NCAP website that the vehicle is equipped with the technology.⁶³

The performance tests chosen for NCAP consisted of three scenarios that simulated the most frequent types of light vehicle rear-end crashes: crashes where a vehicle ahead is either stopped, suddenly starts braking, or is traveling at a much lower speed in the subject vehicle travel lane. The scenarios were named "lead vehicle stopped," "lead vehicle decelerating," and "lead vehicle moving," respectively.⁶⁴ In each scenario, the time needed for a driver to perceive an impending rear-end crash, decide the corrective action, and respond with the appropriate mitigating action is prescribed. If the FCW system fails to provide an alert within the required time during testing, the professional test driver applies the brakes or steers away to avoid a collision.

2. Lead Vehicle AEB Tests

NHTSA incorporated AEB technologies (CIB and DBS) in NCAP as recommended crash avoidance technologies in 2015,⁶⁵ starting with model year 2018 vehicles. NHTSA adopted performance tests and thresholds that a system must meet for the vehicle to be distinguished in NCAP as a vehicle with the recommended technology. The AEB performance tests consisted of test scenarios and test speeds that were derived from crash statistics, field operational tests, and NHTSA testing experience, including

⁶³ The March 2022 request for comments notice discusses, among other things, NHTSA's plan to develop a future rating system for new vehicles based on the availability and performance of all of the NCAP-recommended crash avoidance technologies. That is, instead of a simple checkmark showing the vehicle has a technology (and it meets the applicable performance test criteria), vehicles would receive a rating for each technology based on the systems' performance test criteria in NHTSA's tests. 87 FR 13452 (March 9, 2022).

⁶⁴ 73 FR 40016 (July 11, 2008). <https://regulations.gov>. Docket No. NHTSA–2006–26555–0118.

⁶⁵ 80 FR 68604.

experience gained from development of the FCW performance tests already in NCAP.⁶⁶ In the NCAP recommended crash avoidance technologies program, vehicles receive credit for meeting the agency's performance tests for CIB and DBS separately.

For AEB assessment, NCAP uses four test scenarios: lead vehicle stopped, lead vehicle decelerating, lead vehicle moving, and the steel trench plate test.⁶⁷ Each test scenario is evaluated separately for CIB and DBS. The only difference is that, in the DBS tests, manual braking is applied to the subject vehicle. For the first three test scenarios, the subject vehicle must demonstrate a specific speed reduction attributable to AEB intervention. The fourth scenario, the steel trench plate test, is a false positive test, used to evaluate the propensity of a vehicle's AEB system to activate inappropriately in a scenario that would not present a safety risk to the vehicle's occupants. For each of the scenarios, to receive NHTSA's technology recommendation through NCAP, the vehicle must meet the minimum specified performance in at least five out of seven valid test trials.

Lead Vehicle Stopped Tests

In the NCAP lead vehicle stopped test scenario, the subject vehicle encounters a stopped lead vehicle on a straight road. The subject vehicle travels in a straight line, at a constant speed of 40 km/h (25 mph), approaching a stopped lead vehicle in its path. The subject vehicle's throttle is released within 500 milliseconds (ms) after the subject vehicle issues an FCW. In the DBS test, the subject vehicle's brakes are manually applied at a time-to-collision of 1.1 seconds (at a nominal headway of 12.2 m (40 ft)). To receive credit for CIB, the subject vehicle speed reduction attributable to CIB intervention must be ≥ 15.8 km/h (9.8 mph) before the end of the test. To receive credit for DBS, the subject vehicle must not contact the lead vehicle.

Lead Vehicle Decelerating Tests

In the lead vehicle decelerating test scenario, the subject vehicle encounters a lead vehicle slowing with constant deceleration directly in front of it on a straight road. For this test scenario, the subject vehicle and lead vehicle are initially both driven at 56.3 km/h (35 mph) with an initial headway of 13.8 m (45.3 ft). The lead vehicle then decelerates, braking at a constant

deceleration of 0.3g in front of the subject vehicle, after which the subject vehicle throttle is released within 500 ms after the subject vehicle issues an FCW. In the DBS testing, the subject vehicle's brakes are applied at a time-to-collision of 1.4 seconds (at a nominal headway of 9.6 m or 31.5 ft). To receive credit for passing this test scenario for CIB, the subject vehicle speed reduction attributable to CIB intervention must be ≥ 16.9 km/h (10.5 mph) before the end of the test. To receive credit for passing this test for DBS, the subject vehicle must not contact the lead vehicle.

Lead Vehicle Moving Tests

In the lead vehicle moving test scenario, the subject vehicle encounters a slower-moving lead vehicle directly in front of it on a straight road. For this test scenario, two test conditions are assessed. For the first test condition, the subject vehicle and lead vehicle are driven at a constant speed of 40 km/h (25 mph) and 16 km/h (10 mph), respectively. For the second test condition, the subject and lead vehicle are driven at a constant speed of 72.4 km/h (45 mph) and 32.2 km/h (20 mph), respectively. In both tests, the subject vehicle throttle is released within 500 ms after the subject vehicle issues an FCW. In the DBS tests, the subject vehicle's brakes are applied at a time-to-collision of 1 second (at a nominal headway of 6.7 meters (22 ft)). To receive credit for passing the first CIB test, the subject vehicle must not contact the lead vehicle during the test. To receive credit for passing the second CIB test, the subject vehicle speed reduction attributable to crash imminent braking intervention must be ≥ 15.8 km/h (9.8 mph) by the end of the test. To receive credit for either DBS test, the subject vehicle must not contact the lead vehicle.

Steel Trench Plate Tests

In the steel trench plate test scenario, the subject vehicle is driven towards a steel trench plate (2.4 m \times 3.7 m \times 25.3 mm or 7.9 ft \times 12.1 ft \times 1 in) on a straight road at two different speeds: 40 km/h (25 mph) in one test and 72.4 km/h (45 mph) in the other. The subject vehicle throttle is released within 500 ms of the warning. For CIB tests, if no FCW is issued, the throttle is not released until the test is completed. For DBS tests, the throttle is released such that it is completely released within 500 ms of 2.1 seconds time-to-collision (at a nominal distance of 12.3 m (40.4 ft) or 22.3 m (73.2 ft) from the trench plate, depending on the test speed). The brake pedal is then applied at 1.1 s time-to-collision. To pass these tests for CIB, the

subject vehicle must not achieve a peak deceleration equal to or greater than 0.5 g at any time during its approach to the steel trench plate. To pass the DBS test, the subject vehicle must not experience a peak deceleration that exceeds 150 percent of the braking experienced through manual braking alone for the baseline condition at the same speed.

3. PAEB Test Proposal

NHTSA conducted research and published several NCAP RFC notices on the inclusion of PAEB systems. In the 2013 NCAP request for comments notice, NHTSA noted that PAEB systems capable of addressing both low-speed front and rear pedestrian impact prevention were already in production for some vehicle models.⁶⁸ The agency acknowledged that different technologies were being implemented at the time and different test procedures were being developed worldwide, although some test procedure complexities still existed. An additional complexity was the need for a crash avoidance test dummy that would provide a radar and/or camera recognition signature that would approximate that of a human and would be durable enough to withstand any testing impacts. NHTSA requested comments on methods of addressing and resolving these complexities.

In 2015, the agency announced its plan for several major NCAP program enhancements, including NHTSA's intention to implement a new 5-star rating system to convey vehicle safety information in three major areas—crashworthiness, crash avoidance, and pedestrian protection.⁶⁹ The agency proposed that PAEB be included in the pedestrian protection rating, along with rear automatic braking and pedestrian crashworthiness. At the time, NHTSA noted that the agency was still refining the pedestrian test scenarios for PAEB systems. Specifically, three different types of apparatus concepts were identified for transporting a test mannequin in a test run. These included two overhead gantry-style designs and one moving sled arrangement.

In November 2019, NHTSA published a **Federal Register** notice that sought comment on draft confirmation test procedures for PAEB, among other technologies (84 FR 64405).⁷⁰ It included the two most fatal scenario types: Pedestrian crossing path and

⁶⁸ 78 FR 20597 at 20600.

⁶⁹ 80 FR 78522 at 78526.

⁷⁰ National Highway Traffic Safety Administration (2019, April), *Pedestrian automatic emergency brake system confirmation test (working draft)*. Available at: <https://www.regulations.gov/document/NHTSA-2019-0102-0005>.

⁶⁶ Id. at 68608.

⁶⁷ NHTSA. (2015, October). Crash imminent brake system performance evaluation for the New Car Assessment Program. <https://www.regulations.gov>. Docket No. NHTSA-2015-0006-0025.

pedestrian along or standing in path. For the crossing path scenario (S1), the

draft included seven specific test procedures (Table 17). The maximum

subject vehicle traveling speed specified was 40 km/h (25 mph) in all cases.

Table 17. PAEB Crossing Path Scenarios

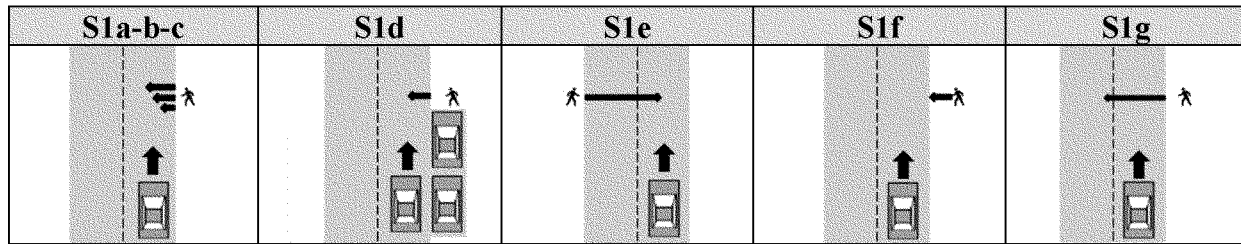

In the first three scenarios (S1a–b–c), a subject vehicle approaches an adult test mannequin starting on the right-hand side of the lane of travel and moving toward the left-hand side. The point on the vehicle at which the subject vehicle will strike the test mannequin without automatic braking, or overlap, is 25, 50, and 75 percent from the passenger side of the subject vehicle, respectively. In the fourth scenario (S1d), the subject vehicle approaches a crossing child test mannequin running from behind parked vehicles from the right-hand side of the travel lane toward the left-hand side

with the point of impact at a 50 percent overlap. In the fifth scenario (S1e), the subject vehicle approaches an adult test mannequin running from the left side of the travel lane toward the right with a 50 percent overlap point of impact.

The sixth and seventh crossing path scenarios (S1f and S1g) are false positive tests. In the sixth scenario, the subject vehicle approaches an adult test mannequin, which begins moving from the right-hand side of the roadway but safely stops short of entering the subject vehicle’s lane of travel. In the seventh scenario, the adult test mannequin also crosses from the right-hand side of the

road toward the left-hand side, but safely crosses the lane of travel completely. The false positive scenarios are used to evaluate the propensity of a PAEB system to inappropriately activate in a non-critical driving scenario that does not present a safety risk to the subject vehicle occupants or pedestrian.

NHTSA’s research test procedures also consisted of three along path (S4) test scenarios in which a test mannequin is either standing or traveling along the vehicle’s lane of travel (Table 18). The maximum subject vehicle traveling speed specified was 40 km/h (25 mph) for all procedures.

Table 18. NHTSA 2019 Draft Test Procedures - PAEB Along Path Scenarios

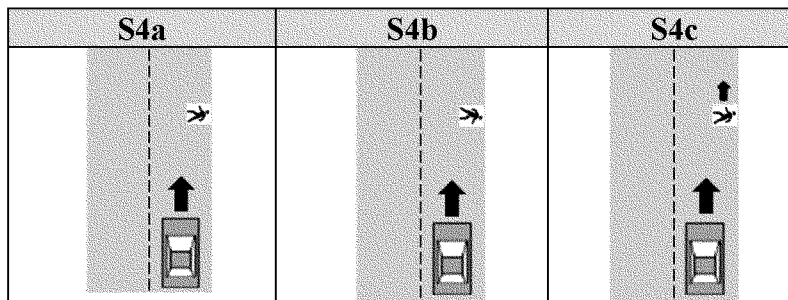

In the first scenario the stationary test mannequin is facing away from the vehicle (S4a) and in the second, it is facing toward the vehicle (S4b). In third scenario, a subject vehicle encounters an adult test mannequin walking in front of the vehicle on the nearside of the road away from the vehicle (S4c). In all three procedures, the stationary test mannequin is positioned with a 25 percent overlap from the passenger side of the vehicle.

NHTSA used the test procedures to conduct performance evaluations of model year 2019 and 2020 vehicles, which were used to support a March 9, 2022, request for comments notice proposing to include PAEB tests in

NCAP.⁷¹ In addition to PAEB, the RFC notice proposed including blind spot detection, blind spot intervention, and lane keeping support performance tests in NCAP. It further proposed strengthening the existing performance tests for FCW, AEB (CIB and DBS), and lane departure warning. It also proposed new rating criteria and provided a roadmap for future upgrades to the program.

C. 2016 Voluntary Commitment

On March 17, 2016, NHTSA and the Insurance Institute for Highway Safety (IIHS) announced a commitment by 20 automakers representing more than 99

percent of the U.S. light vehicle market to make lower speed AEB a standard feature on virtually all new light duty cars and trucks with a gross vehicle weight rating (GVWR) of 3,855 kg (8,500 lbs.) or less no later than September 1, 2022.⁷² Participating manufacturers needed to ensure their vehicles had an FCW system that met NHTSA’s FCW NCAP requirements for both the lead vehicle moving and lead vehicle decelerating performance tests. The

⁷¹ 87 FR 13452.

⁷² Audi, BMW, FCA US LLC, Ford, General Motors, Honda, Hyundai, Jaguar Land Rover, Kia, Maserati, Mazda, Mercedes-Benz, Mitsubishi Motors, Nissan, Porsche, Subaru, Tesla Motors Inc., Toyota, Volkswagen, and Volvo Car USA—representing more than 99 percent of the U.S. new light vehicle market.

voluntary commitment does not include meeting NHTSA's FCW NCAP requirements for the stopped lead vehicle scenario. The voluntary commitment includes automatic braking system performance (CIB only) able to achieve a specified average speed reduction over five repeated trials when assessed in a stationary lead vehicle test conducted at either 19 or 40 km/h (12 or 25 mph). To satisfy the performance specifications in the voluntary commitment, the vehicle would need to achieve a speed reduction of at least 16 km/h (10 mph) in either lead vehicle stopped test, or a speed reduction of 8 km/h (5 mph) in both tests. Participating automakers also committed to making the technology standard on virtually all trucks with a GVWR between 3,856 kg (8,501 lbs.) and 4,536 kg (10,000 lbs.) no later than September 1, 2025.

D. Response To Petition for Rulemaking

In 2017, NHTSA denied a petition for rulemaking from Consumer Watchdog, Center for Automotive Safety, and Public Citizen which requested that NHTSA initiate a rulemaking to require FCW, CIB, and DBS on all light vehicles.⁷³ NHTSA denied the petition after deciding that NCAP, the voluntary commitment, and the consumer information programs of various organizations would produce benefits substantially similar to those that would eventually result from the petitioner's requested rulemaking. Accordingly, the agency did not find evidence of a market failure warranting initiation of the requested rulemaking.⁷⁴ NHTSA further stated that the non-regulatory activities being undertaken at the time would make AEB standard on new light vehicles faster than could be achieved through a regulatory process and would thus make AEB standard equipment earlier, with its associated safety benefits. NHTSA stated that it would monitor vehicle performance in NCAP and the industry's voluntary commitment, and initiate rulemaking if the need arose.

V. NHTSA's Decision To Require AEB

A. This Proposed Rule Is Needed To Address Urgent Safety Problems

NHTSA announced its intention to propose an FMVSS for AEB light vehicles in the Spring 2021 Unified Regulatory Agenda.⁷⁵ In making the

decision to initiate this rulemaking, NHTSA recognized that the non-regulatory measures leading up to this NPRM had been key to an increased and more rapid fleet penetration of AEB technology but decided that rulemaking would best address the rise in motor vehicle fatalities. In addition, NHTSA found that AEB could perform effectively at higher speeds than the systems included in the voluntary agreement and NCAP and that PAEB in darkness has become technologically possible.

NHTSA initiated this rulemaking to reduce the frequency of rear-end crashes, which is the most prevalent vehicle crash type, and to target one of the most concerning and urgent traffic safety problems facing the U.S. today—the rapidly increasing numbers of pedestrian fatalities and injuries. Rear-end crashes are very common, although most are not deadly. Nevertheless, approximately 2,000 people die in rear-end crashes each year, making up 5 to 7 percent of total crash fatalities. Pedestrian crashes are deadly and have been increasing in recent years. They tend to happen at night and at higher speeds. About half of fatal pedestrian crashes happen on roads with a speed limit of 40 mph or lower and half on roads with a speed limit of 45 mph and higher.

The non-regulatory approaches of the past were instrumental in developing AEB and encouraging manufacturers to include and consumers to purchase AEB in most passenger vehicles sold today. With AEB sensors and other hardware installed in the fleet as a result of NCAP and the voluntary commitment, regulatory costs to equip new vehicles are reduced. However, an FMVSS is needed to compel technological improvement of AEB systems, and to ensure that every vehicle will be equipped with a proven countermeasure that can drastically reduce the frequency and severity of rear-end crashes and the safety risks posed to pedestrians. NHTSA is aware of data and other information indicating potential opportunities for AEB improvement. A recent IIHS study of 2009–2016 crash data from 23 States suggested that the increasing effectiveness of AEB technology in certain crash situations is changing rear-end crash scenarios.⁷⁶ IIHS's study identified rear-end crashes in which striking vehicles equipped with AEB

were over-represented compared to those without AEB. For instance, IIHS found that striking vehicles involved in the following rear-end crashes were more likely to have AEB: (1) where the striking vehicle was turning relative to when it was moving straight; (2) when the struck vehicle was turning or changing lanes relative to when it was slowing or stopped; (3) when the struck vehicle was not a passenger vehicle or was a special use vehicle relative to a passenger car; (4) on snowy or icy roads; or (5) on roads with speed limits of 70 mph relative to those with 64 to 72.4 km/h (40 to 45 mph) speed limits. Overall, the study found that 25.3 percent of crashes where the striking vehicle was equipped with AEB had at least one of these over-represented characteristics, compared with 15.9 percent of impacts by vehicles that were not equipped with AEB. IIHS found that in 2016, nearly 300,000 (15 percent) of the police reported two-vehicle rear-end crashes involved one of the rear-end crashes mentioned above.

These results suggest that the metrics used to evaluate the performance of AEB systems by NHTSA's NCAP, the voluntary industry commitment, and other consumer information programs have facilitated the development of AEB systems that reduce the crashes they were designed to address. However, the results also indicate that AEB systems have not yet provided their full crash reduction potential. While they are effective at addressing some of the lower speed rear-end crashes, they are less effective at fully addressing the safety need.

These data also indicate the potential of AEB to reduce fatal crashes, especially if test speeds were increased. Accordingly, NHTSA has issued this NPRM to drive AEB performance to maximize safety benefits, assess practicability limits, and ensure that AEB technology is incorporated in all vehicles to the extent possible. This NPRM is issued to reach farther than NCAP to expand the availability of AEB technologies to all vehicles—not just to those whose manufacturers were incentivized to add such systems or whose purchasers were interested in purchasing them. By ensuring the universal implementation of AEB, this NPRM would best achieve equity in the safety provided across vehicles and the safety provided to the communities on whose roads they operate.

This NPRM would improve the capability of AEB systems beyond that of the low-speed AEB systems contemplated by the voluntary commitment, increasing safety benefits. The NPRM also would require PAEB,

⁷³ 82 FR 8391 (January 25, 2017).

⁷⁴ Section 1(b) of E.O. 12866 requires agencies to assess the failures of private markets to address the problem identified by the agency.

⁷⁵ <https://www.reginfo.gov/public/do/eAgendaViewRule?pubId=202104&RIN=2127-AM37>.

⁷⁶ Cicchino, J.B. & Zuby, D.S. (2019, August), Characteristics of rear-end crashes involving passenger vehicles with automatic emergency braking, *Traffic Injury Prevention*, 2019, VOL. 20, NO. S1, S112–S118 <https://doi.org/10.1080/15389588.2019.1576172>.

while the voluntary commitment does not address PAEB. Requiring AEB systems under an FMVSS would ensure that manufacturers design and produce vehicles that provide at least the minimum level of safety mandated by the standard or face consequences for not doing so, including recalling the vehicle and remedying the noncompliance free of charge. These positive outcomes could not be achieved by a voluntary commitment alone.

Further, this NPRM responds to Congress's directive that AEB be required on all passenger vehicles. On November 15, 2021, President Biden signed the Bipartisan Infrastructure Law, codified as the Infrastructure Investment and Jobs Act.⁷⁷ Section 24208(a) of BIL added 49 U.S.C. 30129, directing the Secretary of Transportation to promulgate a rule to establish minimum performance standards with respect to crash avoidance technology and to require that all passenger motor vehicles for sale in the United States be equipped with a forward collision warning system and an automatic emergency braking system.⁷⁸ The FCW and AEB system is required to alert the driver if the vehicle is closing its distance too quickly to a vehicle ahead or to an object in the path of travel ahead and a collision is imminent, and to automatically apply the brakes if the driver fails to do so.

BIL requires that "all passenger motor vehicles" be equipped with AEB and FCW. This NPRM would require AEB and FCW on all passenger cars and multipurpose passenger vehicles, trucks, and buses with a GVWR of 10,000 lbs. or less. NHTSA believes that the scope of this NPRM includes all vehicles required be equipped with AEB by section 24208 of the IJJA.

BIL further requires that an FCW system alert the driver if there is a "vehicle ahead or an object in the path of travel" if a collision is imminent. Accordingly, NHTSA has defined an AEB system as one that detects an imminent collision with a vehicle or with an object. NHTSA does not read this provision as mandating a particular level of performance regarding the detection of vehicles and objects. More specifically, NHTSA does not interpret this provision to require passenger vehicles to detect and respond to imminent collisions with all vehicles or all objects in all scenarios. Such a

requirement would be unreasonable given the wide array of harmless objects that drivers could encounter on the roadway that do not present safety risks. NHTSA also does not interpret section 24208 to mandate AEB performance to avoid any specific objects or to mandate PAEB.

Instead, NHTSA interprets section 24208 as broadly requiring AEB capable of detecting and responding to vehicles and objects while leaving to NHTSA the discretion to promulgate specific performance requirements. Following this interpretation, NHTSA's proposal, if implemented, would require light vehicles to be equipped with FCW and automatic emergency braking, and the proposal defines AEB as a system that detects an imminent collision with vehicles, objects, and road users in or near the path of a vehicle and automatically controls the vehicle's service brakes to avoid or mitigate the collision.

NHTSA has authority and discretion to promulgate requirements that go beyond those contemplated under Section 24208. Pursuant to its authority at 49 U.S.C. 30111, NHTSA is proposing that all light passenger vehicles be required to have PAEB.

B. Stakeholder Interest in AEB

1. National Transportation Safety Board Recommendations

This NPRM is responsive to several National Transportation Safety Board (NTSB) recommendations. In May 2015, the NTSB issued a special investigation report, "The Use of Forward Collision Avoidance Systems to Prevent and Mitigate Rear-End Crashes."⁷⁹ The report detailed nine crash investigations involving passenger or commercial vehicles striking the rear of another vehicle, and concluded that collision warning systems, particularly when paired with active braking, could significantly reduce the frequency and severity of rear-end crashes. As a result, the NTSB issued several safety recommendations to NHTSA, including the following:

- H-15-04: Develop and apply testing protocols to assess the performance of forward collision avoidance systems in passenger vehicles at various velocities, including high speed and high velocity-differential.

In September 2018, the NTSB issued another special investigation report, "Pedestrian Safety."⁸⁰ This report examined the past 10 years of

pedestrian crash data, described NTSB pedestrian safety investigations, and summarized issues raised in a public forum. As a result, the NTSB issued several safety recommendations to NHTSA, including the following:

- H-18-41: Develop performance test criteria for vehicle designs that reduce injuries to pedestrians.
- H-18-42: Develop performance test criteria for manufacturers to use in evaluating the extent to which automated pedestrian safety systems in light vehicles will prevent or mitigate pedestrian injury.

2. Consumer Information Programs in the United States

In the United States, in addition to NHTSA's NCAP, the Insurance Institute for Highway Safety also tests AEB systems in vehicles for the purpose of informing consumers about their performance. Both programs test AEB systems in response to a stationary lead vehicle test device, but IIHS only performs tests to assess crash imminent braking system performance, while NCAP AEB evaluations also test DBS responses and assess system performance for both slower-moving and decelerating lead vehicle scenarios. NCAP also tests for false positive AEB activation by having subject vehicles drive over a steel trench plate. NCAP provides pass/fail results based on speed reduction and crash avoidance in DBS tests attributed to AEB, while IIHS awards points based only on speed reduction.⁸¹ Both programs are considering upgrades to their AEB performance tests. On March 9, 2022, NHTSA issued a request for comments notice proposing increased test speeds in its DBS and CIB test protocols. On May 5, 2022, IIHS announced its intention to test six vehicles equipped with AEB at higher speeds, up to 72.4 km/h (45 mph), to better align with reported crashes.⁸²

IIHS further conducts PAEB tests in two scenarios like those proposed in the NPRM. In the first scenario, an articulated test mannequin crosses the subject vehicle's path; this condition is tested with both the articulated child surrogate (Perpendicular Child) and the articulated adult surrogate (Perpendicular Adult). In the second scenario, an adult test mannequin without articulation is standing in a

⁸¹ The March 9, 2022, request for comments notice also asks for public comment on NHTSA's plan to develop a future rating system for new vehicles based on the availability and performance of all the NCAP-recommended crash avoidance technologies. 87 FR 13452.

⁸² <https://www.iihs.org/news/detail/iihs-eyes-higher-speed-test-for-automatic-emergency-braking>.

⁷⁷ Public Law 117-58, 24208 (Nov. 15, 2021).

⁷⁸ Section 24208 also directs DOT to require a lane departure warning and lane-keeping assist system that warns the driver to maintain the lane of travel; and corrects the course of travel if the driver fails to do so.

⁷⁹ <https://www.nts.gov/safety/safety-studies/Documents/SIR1501.pdf>.

⁸⁰ <https://www.nts.gov/safety/safety-studies/Documents/SIR1803.pdf>.

vehicle's path, offset 25 percent from center (Parallel Adult). Both test scenarios are conducted during daylight conditions. Points are awarded in the IIHS test based on vehicle speed reduction.

Other consumer information groups have also invested effort into supplying customers with information regarding AEB. Since 2016, Consumer Reports has been awarding "bonus" points to its overall score for vehicles that come equipped with AEB and FCW as standard features across all trim levels of a model.⁸³

3. Petition for Rulemaking on PAEB Performance in Dark Conditions

On March 22, 2022, IIHS and the Highway Loss Data Institute petitioned NHTSA to require, through rulemaking, that passenger vehicles be equipped with AEB that responds to pedestrians in all light conditions. The petitioners stated that research from IIHS estimates that PAEB systems reduce pedestrian crash risk by an estimated 32 to 33 percent in daylight or dark conditions with street lighting but does not reduce pedestrian crash risk in the dark without street lighting. The petitioners stated that over a third of pedestrian deaths occur in dark, unlit conditions, and that requiring PAEB systems that function in those conditions will lead to a greater reduction in fatalities than only requiring those systems that function in daylight.

When NHTSA received the petition from IIHS, the agency had already announced in the Fall 2021 Unified Agenda of Regulatory and Deregulatory Actions⁸⁴ that it had initiated rulemaking on PAEB. The agency announced that it would issue a proposal to require and/or standardize performance for light vehicle AEB, including PAEB. NHTSA's Agenda entry further announced that this rulemaking would set performance requirements for AEB systems and would specify a test procedure under which compliance with those requirements would be measured. Given this context, NHTSA denied the petition as moot because NHTSA had already commenced rulemaking on the requested action and was, and remains, deeply immersed in developing the rule. Although NHTSA has denied the petition, NHTSA has considered its points as suggestions for this

rulemaking. A copy of the petition has been placed in the docket for this rulemaking.

C. Key Findings Underlying This Proposal

1. Impact Speed Is Key To Improving AEB's Mitigation of Fatalities and Injuries

As described in the section II of this NPRM, 79 percent of property-damage-only crashes, 73 percent of injuries, and 60 percent of fatalities in rear-end crashes involving light vehicles occur on roads where the posted speed limit is 60 mph (97 km/h) or less. However, the majority of those crashes are skewed towards the higher end of that range. Only 3 percent of fatalities, 9 percent of injuries, and 12 percent of property-damage-only crashes occur at posted speeds below 30 mph (48 km/h). NHTSA believes that most of the safety need exists at speeds greater than 30 mph (48 km/h). In light of these data, this NPRM seeks to address a safety need at a speed well above that found in the voluntary commitment, which has a maximum test speed of 40 km/h (25 mph). The data show that speeds higher than those proposed in the 2022 NCAP request for comments notice⁸⁵ (with a maximum testing speed of 80 km/h (50 mph)) are also required to address the safety need.⁸⁶ In fact, the data demonstrate the safety need for AEB systems to activate at as high a speed as can practicably be achieved.

2. Darkness Performance of PAEB Is Highly Important

Out of the 4,069 pedestrian fatalities in 2019 resulting from being struck by the front of a light vehicle, about 77 percent occurred in dark conditions and about 50 percent of all pedestrian fatalities occurred at posted speeds of 40 mph (64 km/h) or less. Forty percent of all pedestrian injuries, regardless of how a pedestrian is struck, occur in dark conditions and 57 percent of them occur at posted speeds of 40 mph (64 km/h) or less. Based on these data, the agency tentatively concludes that performance testing under various lighting conditions and at higher speeds is necessary.

During 2020 agency research testing using model year 2019 and 2020 vehicles, observed AEB performance was not consistent for some of the proposed lighting conditions and speeds. During PAEB testing, 5 out of 11

vehicles avoided collision in at least one test at speeds up to 60 km/h (37.3 mph) in daylight when an adult pedestrian test mannequin crossed the path of the vehicle from the right; absent PAEB intervention, the front middle section of the vehicle would have hit the test mannequin. For the same scenario, 5 vehicles out of 11 avoided impact with the test mannequin in at least one test at speeds up to 40 km/h (25 mph) when testing using the vehicle's lower beam headlamps in dark conditions. Only 1 of 11 vehicles could consistently avoid impact in every test trial in each of the daylight and dark lower beam headlamp conditions at these speeds.

For tests involving a stationary pedestrian test mannequin situated toward the right side of the road, but within the path of the vehicle, 3 vehicles out of 11 consistently avoided impact at speeds up to 50 km/h (31.1 mph) in daylight conditions, and one avoided impact in five out of six tests at 60 km/h (37 mph). In dark conditions, using only the lower beam headlamps, one vehicle avoided collision at all speeds up to 50 km/h (31.1 mph) and in four out of five tests at 55 km/h (34.2 mph). However, other tested vehicles contacted the test mannequin at all speeds above 16 km/h (10 mph) in the same darkness condition.

NHTSA has tentatively concluded that the performance achieved by the better performing vehicles in dark lighting conditions can be achieved by all vehicles given an adequate phase-in period. This is consistent with recent testing performed by IIHS, which found that existing systems can perform in darkness conditions regardless of their IIHS headlamp ratings.⁸⁷ The agency tentatively concludes that AEB system performance is improving, and the latest AEB systems are already able to perform much better than previous systems. Concurrent with the development of this proposed rule, NHTSA performed PAEB testing on model year 2021 and 2022 vehicles using the proposed performance requirements and test procedures. The results of this testing are detailed in the PAEB report docketed with this proposed rule.

3. NHTSA's 2020 Research on Lead Vehicle AEB and PAEB Performance Show the Practicability of Higher Speed Tests

In 2020, NHTSA conducted lead vehicle AEB and PAEB performance tests on 11 model year 2019 and 2020 vehicles from 10 vehicle manufacturers.

⁸³ <https://www.consumerreports.org/car-safety/where-automakers-stand-on-automatic-emergency-braking-pledge/>.

⁸⁴ <https://www.reginfo.gov/public/do/eAgendaMain>; See RIN 2127-AM37, titled, "Light Vehicle Automatic Emergency Braking (AEB) with Pedestrian AEB."

⁸⁵ 87 FR 13452.

⁸⁶ In 2019, 67 percent of fatalities within the target population occur where the posted speeds are above 50 mph, and 29 percent of the fatalities occur at posted speeds of 55 mph and 60 mph.

⁸⁷ IIHS dark light press release: <https://www.iihs.org/news/detail/pedestrian-crash-avoidance-systems-cut-crashes-but-not-in-the-dark>.

This work was done to support the agency’s March 9, 2022 request for comments notice proposing to upgrade NCAP, as well as to assist in the development of this NPRM.

a. Lead Vehicle AEB Performance Tests

To evaluate lead vehicle AEB performance at higher speeds, the agency performed CIB tests in accordance with NCAP’s CIB test procedures,⁸⁸ but repeated the lead vehicle stopped and lead vehicle decelerating test scenarios using an expanded set of input conditions to assess how specific test procedures changes, such as increasing speed or deceleration magnitude, would affect the vehicle’s CIB performance. NHTSA placed test reports detailing the results in the docket of the March 9, 2022, NCAP request for comments notice on the proposed updates.⁸⁹

For the NCAP CIB lead vehicle stopped test scenario, NHTSA conducted tests at incremental vehicle speeds from 40 to 72.4 km/h (25 to 45 mph). The results showed that the tested vehicle CIB systems exceeded the performance established in consumer programs, such as model year 2022 NCAP and IIHS. Three vehicles were able to demonstrate no contact with the lead vehicle at speeds up to 72.4 km/h (45 mph), and the remaining eight vehicles had an average speed reduction of 37.7 km/h (23.4 mph) when tested at this speed.⁹⁰ One vehicle avoided contact in all tests and at speeds up to 72.4 km/h (45 mph), for a total of 27 out of 27 tests without contact.

NHTSA also conducted CIB lead vehicle decelerating tests as a part of NHTSA’s 2020 research study. When

the test conditions were modified such that the lead vehicle decelerated at 0.5g, rather than 0.3g as specified in NHTSA’s CIB NCAP test procedure, eight vehicles demonstrated the ability to avoid contact with the lead vehicle in at least one test and three vehicles avoided contact in all tests despite having less time to avoid the crash. Similarly, when the speed of the subject vehicle and lead vehicle was increased to 72.4 km/h (45 mph), nine vehicles demonstrated the ability to avoid contact with the lead vehicle in at least one test while four vehicles avoided contact in all tests. One vehicle was able to avoid contact in all lead vehicle decelerating tests, including both increased speeds and increased lead vehicle deceleration.

Although NHTSA did not perform higher speed evaluations for the slower-moving lead vehicle test scenario as part of its CIB study, NHTSA believes that it is reasonable and appropriate for this NPRM to propose raising the subject vehicle speed above that specified currently in NCAP’s test to ensure improved AEB performance. NHTSA also did not conduct DBS testing in its characterization study to evaluate AEB system performance capabilities. However, the CIB and DBS test procedures proposed in this NPRM use the same test scenarios. Differences exist only with respect to the use of subject vehicle manual brake application and maximum test speeds. NHTSA constructed its 2020 research program using CIB to demonstrate the practicability of testing at higher speeds with a no-contact requirement. In past testing, DBS performance has typically been as good as if not better than CIB.

Concurrent with the development of this proposed rule, NHTSA performed lead vehicle AEB testing on model year 2021 and 2022 vehicles using the proposed performance requirements and test procedures. The results of that testing provide additional support to the tentative conclusion that the test conditions, parameters, and procedures are practical to conduct and that the proposed requirements are practical for manufacturers to achieve. The results of this testing are detailed in the lead vehicle AEB report docketed with this proposed rule. The 12 model year 2021 and 2022 vehicles were selected to provide a balance of anticipated market penetration (using 2021 sales data) and a mix of vehicle types, including internal combustion engine vehicles and electric vehicles. Tests enabled the agency to refine the test procedures and validate test execution within the proposed tolerances.

b. PAEB Daytime Performance Tests

NHTSA selected the same 11 model year 2019 and 2020 vehicles used in the CIB testing to assess the performance of current PAEB systems. NHTSA issued test reports detailing the results in support of the March 9, 2022, NCAP request for comments notice.⁹¹

As shown in Table 19, NHTSA used its 2019 draft PAEB research test procedures, but increased the subject vehicle speed for specific test conditions.⁹² Additionally, NHTSA used articulating test mannequins, as used in Euro NCAP, instead of the posable mannequins specified in the draft test procedure.⁹³

TABLE 19—MATRIX OF THE DAYTIME PAEB NHTSA 2020 RESEARCH TESTS

Test Mann	Crossing path					Along path		
	Adult	Child	Adult	Adult	Adult	Adult		
Motion	Walking	Running		Walking	Walking	Fixed	Walking	
Direction	Right	Right, Obstructed	Left	Right	Right	Facing Away	Facing Vehicle	Away from Vehicle
Test Mann. Speed	5 km/h	5 km/h	8 km/h	5 km/h	5 km/h	0 km/h	0 km/h	5 km/h

⁸⁸ www.regulations.gov. NHTSA Docket No. NHTSA–2015–0006–0025.

⁸⁹ www.regulations.gov. NHTSA Docket No. NHTSA–2021–0002–0002. “Final MY2019/MY2020 Research Reports for Pedestrian Automatic Emergency Braking, High-Speed Crash Imminent Braking, Blind Spot Warning, and Blind Spot Intervention Testing.” There are 11 test reports w/ the following title for each vehicle name: “Crash Imminent Braking System Research Test.”

⁹⁰ Two vehicles were able to avoid contact in five out of five tests conducted at 72.4 km/h (45 mph). The third vehicle avoided contact in one out of five tests conducted at 72.4 km/h (45 mph).

⁹¹ See Docket No. NHTSA–2021–0002–0002. There are embedded reports titled, “PEDESTRIAN AUTOMATIC EMERGENCY BRAKING SYSTEM RESEARCH TEST” for each of the 11 vehicle make/models.

⁹² 84 FR 64405 (Nov. 21, 2019). www.regulations.gov, NHTSA Docket No. NHTSA–2019–0102–0005. Note, in this document, the PAEB test procedures were called “Pedestrian Automatic Emergency Brake System Confirmation Tests.” NHTSA increased test speeds for the S1b, S1d, S1e, S4a, and S4c from NHTSA’s draft test procedure.

⁹³ <https://cdn.euroncap.com/media/41769/euro-ncap-pedestrian-testing-protocol-v85.201811091256001913.pdf>.

TABLE 19—MATRIX OF THE DAYTIME PAEB NHTSA 2020 RESEARCH TESTS—CONTINUED

	Crossing path							Along path		
	25%	50%	75%	50%	50%	Stops Before Vehicle Path	Crosses/ Clears Vehicle Path	25%	25%	25%
Scenario	S1a	S1b	S1c	S1d	S1e	S1f	S1g	S4a	S4b	S4c
Subject Vehicle Speed (km/h)	16 40	16 20	16 40	16 20	40 50	40	40	16 40	16 40	16 40
		30		30	60			50		50
		40		40				60		60
		50		50				70		70
		60		60				80		80

The maximum test speeds for the crossing path and along path scenarios were 60 km/h (37.5 mph) and 80 km/h (50 mph), respectively. These maximum speeds were consistent with Euro NCAP’s AEB Vulnerable Road User Protection protocol published at the time of testing.⁹⁴

The results demonstrated that several vehicles avoided contact with the test mannequin in nearly all tests conducted, including at speeds up to 60 km/h (37.5 mph) in the 50 percent overlap test (S1b). The most challenging crossing path test condition was the running child from behind parked vehicle condition (S1d); however, one vehicle was able to detect and avoid contact with the test mannequin at all subject vehicle speeds up to 60 km/h (37.5 mph). Similarly, in the crossing adult pedestrian running from the left side test condition (S1e), the testing

demonstrated that at least one vehicle did not collide with the test mannequin in all tests conducted at speeds up to 60 km/h (37.5 mph).⁹⁵ The walking test mannequin stopping prior to entering the travel lane test condition (S1f) was the most challenging for vehicles to predict and not unnecessarily activate PAEB. The other false positive test, where a crossing adult test mannequin walks from the nearside and clears the vehicle’s path (S1g), resulted in fewer instances of automatic braking.

In the test with the stationary pedestrian facing away from the subject vehicle (S4a), NHTSA’s research testing showed that several vehicles were able to repeatedly avoid impacting the test mannequin at speeds of 50 km/h (31 mph) and 60 km/h (37.5 mph). However, vehicles were not able to avoid impact at the highest test speed of 80 km/h (50 mph). In the scenario

where the subject vehicle encounters an adult pedestrian walking away from the vehicle (S4c), two vehicles were able to avoid contact with the test mannequin in tests at speeds up to 65 km/h (40.3 mph) during each test performed at that speed.

c. PAEB Darkness Performance Tests

NHTSA conducted additional PAEB tests under dark lighting conditions using vehicle lower and upper beam headlamps. The tests used the same test scenarios and conditions as NHTSA’s 2019 draft research test procedures and the same 11 vehicles tested for CIB and daylight PAEB performance. Tests were conducted first with the test mannequin illuminated only by the vehicle’s lower beam headlamps and then by the upper beam headlamps. The area where the test mannequin was located was not provided any additional light source.

TABLE 20—MATRIX OF THE DARK LIGHTING PAEB NHTSA 2020 RESEARCH TESTS *

	Crossing path			Along path	
	Adult	Child	Adult	Adult	Adult
Test Mann	Adult	Child	Adult	Adult	Adult
Motion	Walking	Running		Fixed	Walking
Direction	Right	Right, Obstructed	Left	Facing Away	Away from Vehicle
Test Mann. Speed	5 km/h	5 km/h	8 km/h	0 km/h	5 km/h
Overlap	50%	50%	50%	25%	25%
Scenario	S1b	S1d	S1e	S4a	S4c
Subject Vehicle Speed (km/h)	16 20 30 40 50 60	16 20 30 40 50 60	40 50 60	16 40 50 60 70 80	16 40 50 60 70 80

* Tests were separately conducted with the vehicle lower and upper beam headlamps activated.

⁹⁴ European New Car Assessment Programme (Euro NCAP). (2019, July). TEST PROTOCOL—AEB VRU systems 3.0.2.

⁹⁵ At the 60 km/h (37.5 mph) test speed, the vehicle achieved no contact in four out of five tests conducted.

NHTSA's testing showed that tests conducted with upper beam headlamps generally resulted in greater braking and less contact with the test mannequin than identical tests conducted with lower beam headlamps in the S1b test condition. The maximum speed at which at least one vehicle avoided contact in all trials with the test mannequin was 60 km/h (37.3 mph) for the upper beam condition, compared to 50 km/h (31.1 mph) for the lower beam condition.

NHTSA observed that many of the model year 2019 and 2020 vehicles experienced difficulties or inconsistent performance in the crossing child pedestrian running from behind parked vehicles scenario (S1d). Many vehicle contacts with the test mannequin did not include any AEB system activation. Additionally, many of the tests in the crossing adult pedestrian running from the left side test condition (S1e) were not conducted due to the lack of PAEB activation at lower speeds. For example, in the lower beam tests at 40 km/h (25 mph), 8 of the 11 vehicles could not avoid test mannequin contact. Vehicle performance in the upper beam headlamp tests were only marginally better for this test condition.

In the along path research tests (S4a), one vehicle was able to avoid test mannequin contact for all vehicle test speeds up to 60 km/h (37.5 mph) using the upper beam headlamps and at speeds up to 55 km/h (34.2 mph) using the lower beam headlamps. However, many other vehicles were not tested above 40 km/h (25 mph) due to contact with the test mannequin.

Likewise, in the scenario in which the subject vehicle encounters an adult pedestrian standing facing away from the vehicle (S4c), many vehicles were not tested above 40 km/h (25 mph) due to repeated contact with the test mannequin. In the lower beam headlamp tests, two vehicles were able to avoid contact with the test mannequin in tests at speeds up to 60 km/h (37.5 mph), and one was able to do so during each test performed. In the upper beam headlamp tests, one vehicle was able to avoid contact with the test mannequin during each test performed at all tested speeds up to 50 km/h (31.1 mph).

d. PAEB Darkness Performance Tests With Overhead Lighting

To study potential performance differences attributable to the use of overhead lights during dark conditions, NHTSA performed several of the PAEB test scenarios at two test speeds, 16 km/h (10 mph) and 40 km/h (25 mph), using

two model year 2020 vehicles.⁹⁶ This study was performed using the vehicles' lower beams under dark conditions with overhead lights. In this testing, the agency observed only slightly better PAEB performance in dark lighting conditions with overhead lights than in dark lighting conditions without overhead lights.

4. This Proposed Standard Complements Other NHTSA Actions

This NPRM is part of NHTSA's multi-pronged approach to enhance vehicle performance against pedestrian injury and counter the rising numbers of pedestrian fatalities and injuries. This proposal would require the installation of PAEB technologies that warn about and respond to an imminent collision with a pedestrian at higher speeds than PAEB systems on the market today.

This proposal would complement a rulemaking proposal under development that would require that passenger vehicle hoods mitigate the risk of serious or fatal child and adult head injury in pedestrian crashes.⁹⁷ When new vehicles are equipped with PAEB, fewer pedestrians will be struck. For impacts that cannot be avoided due to high closing speed of the vehicle, the automatic braking provided by PAEB will lower the vehicle's speed at impact. Lowering the speed of pedestrian impact and strengthening pedestrian protection provided by vehicle hoods would be complementary actions, resulting in complementary benefits of the two proposed rules. Furthermore, NHTSA has announced plans to propose a crashworthiness pedestrian protection testing program in NCAP. This pedestrian protection program would incorporate three crashworthiness tests (*i.e.*, head-to-hood, upper leg-to-hood leading edge, and lower leg-to-bumper).⁹⁸

On February 22, 2022, NHTSA published a final rule amending NHTSA's lighting standard to allow adaptive driving beam headlamps.⁹⁹ These headlighting systems incorporate an advanced type of headlamp beam switching that can provide a variable upper beam sculpted so that it provides more light on the roadway ahead without creating glare for the drivers of oncoming or preceding vehicles. Adaptive driving beam headlighting

systems also have the potential to provide safety benefits in preventing collisions with pedestrians.

VI. Proposal To Require Automatic Emergency Braking

This NPRM proposes a new FMVSS to require AEB systems on light vehicles that are capable of reducing the frequency and severity both rear-end and pedestrian crashes. Having considered the actions of industry, including those in response to nonregulatory incentives, NHTSA has concluded that this rulemaking is necessary to require that all new light vehicles are equipped with AEB systems and to set specific performance requirements for AEB systems. NHTSA incorporated FCW into NCAP beginning in model year 2011 and AEB into NCAP beginning in model year 2018. This has achieved success, with approximately 65 percent of new vehicles meeting the lead vehicle test procedures included in NCAP.¹⁰⁰ Similarly, the voluntary commitment resulted in approximately 90 percent of new light vehicles having an AEB system.¹⁰¹

However, NHTSA has tentatively concluded that these actions have insufficiently addressed the safety problem associated with rear-end and pedestrian crashes for three primary reasons. First, the test speeds and performance specifications in NCAP and the voluntary commitment would not ensure that the systems perform in a way that will prevent or mitigate crashes resulting in serious injuries and fatalities. The vast majority of fatalities, injuries, and property damage crashes occur at speeds above 40 km/h (25 mph), which are above those covered by the voluntary commitment.

Second, NCAP and, even more so, other voluntary measures are intended to supplement rather than substitute for the FMVSS, which remain NHTSA's core way of ensuring that all motor vehicles are able to achieve an adequate level of safety performance. Thus, though the NCAP program provides valuable safety-related information to consumers in a simple to understand way, the agency believes that gaps in market penetration will continue to exist for the most highly effective AEB systems. Moreover, as pedestrian safety addresses the safety of someone other than the vehicle occupant, it is not clear if past experiences with NCAP are necessarily indicative of how quickly PAEB systems would reach the levels of

⁹⁶ Specifically, NHTSA performed overhead lighting tests using scenarios S1b, S1d, and S1e and S4a and S4c.

⁹⁷ Unified Agenda of Regulatory and Deregulatory Actions, Regulation Identifier Number (RIN) 2127-AK98, "Pedestrian Safety Global Technical Regulation."

⁹⁸ 87 FR 13452, March 9, 2022.

⁹⁹ RIN 2127-AL83.

¹⁰⁰ Percentage based on the vehicle manufacturer's model year 2022 projected sales volume reported through the New Car Assessment Program's annual vehicle information request.

¹⁰¹ *Id.*

lead vehicle AEB, if pedestrian functionality that would meet NCAP performance levels was offered as a separate cost to consumers. NHTSA believes that there can be a significant safety benefit in NCAP providing consumers with information about new safety technologies before it is prepared to mandate them, but this is not a requirement.

A final factor weighing in favor of requiring AEB is that the technology is a significantly more mature level than what it was at the time of the voluntary commitment or when it was introduced into NCAP. NHTSA's most recent testing has shown that higher performance levels than those in the voluntary commitment or the existing NCAP requirements are now practicable. Many model year 2019 and 2020 vehicles were able to repeatedly avoid impacting the lead vehicle in CIB tests and the pedestrian test mannequin in PAEB tests, even at higher test speeds than those prescribed currently in the agency's CIB and draft PAEB test procedures.

This proposed rule includes three basic lead vehicle AEB test scenarios—stopped, slower-moving, and decelerating lead vehicle. Each lead vehicle AEB scenario has performance requirements at specific speeds or ranges of speeds. Each scenario also includes performance requirements with and without manual braking. NHTSA's general approach in developing performance requirements was to consider the state of AEB technology and its ability to address crashes. Key parameters were identified that are important in differentiating between AEB systems that are effective at preventing crashes, and AEB systems that only engage in narrow and very controlled conditions, with the latter being potentially less effective at reducing fatalities and injuries. For example, a system that only automatically applies the brakes where the posted speed limit is 25 mph or less would be effective at preventing property damage rear-end crashes, but would prevent very few fatalities and injuries. Likewise, PAEB systems that are unable to prevent crashes in low-light ambient conditions would fail to reduce a large portion of pedestrian fatalities. Considering the ability of current AEB technology to safely prevent crashes, and using information from vehicle testing, NHTSA is proposing requirements, including test scenarios and parameters, that are either within the capability of at least one recent production vehicle or for which there is a practical engineering basis for

the prescribed capability in current AEB systems.

The proposal requires a vehicle to provide a FCW and have an emergency braking system that automatically applies the brakes when a collision with the rear of another vehicle or a pedestrian is imminent at speeds above 10 km/h (6.2 mph). Furthermore, proposed AEB performance requirements will ensure that an AEB system is able to completely avoid collision with the rear of another vehicle or a pedestrian. Specifically, the proposal includes a set of performance requirements for vehicle-level track testing that will realistically evaluate vehicles at normal driving speeds and introduce test devices for which vehicles must automatically brake in a way that avoids any impact with the objects. The requirements include lead vehicle AEB test scenarios, where the test object that must be avoided is the lead vehicle test device, and PAEB test scenarios, where the object that must be avoided is a pedestrian test mannequin. In all tests that include a test device, the observable and objective criterion for passing is avoiding contact with the object. The agency is proposing additional system requirements for false activation and provisions for indicating AEB malfunction to the vehicle operator.

A. Lead Vehicle AEB System Requirement

The agency is proposing that vehicles be required to have a forward collision warning system and an automatic emergency braking system that are able to function continuously to apply the service brakes automatically when a collision with a vehicle or object is imminent. The system must operate when the vehicle is traveling at any forward speed greater than 10 km/h (6.2 mph). This is a general system equipment requirement with no associated performance test. No specific speed reduction or crash avoidance would be required. However, this requirement is included to ensure that AEB systems are able to function at all times, including at speeds above those NHTSA is proposing as part of the performance test requirements.

This requirement complements the performance requirements in several ways. While the track testing described below provides a representation of real-world crash events, no amount of track testing can fully duplicate the real world. This requirement ensures that the AEB's perception system identifies and automatically detects a vehicle, warns the driver, and applies braking when a collision is imminent. This

requirement also ensures that AEB systems continue to function in environments that are not as controlled as the test track environment. For example, unlike during track testing, other vehicles, pedestrians, bicyclists, and buildings may be present within the view of the sensors. Finally, track test equipment limitations and safety considerations limit the ability to test at high speeds. However, crashes still occur at higher travel speeds. The automatic braking requirement ensures that AEB systems continue to provide safety benefits at speeds above those for which a track-testing requirement is currently not practicable, either because of performance capabilities or track test limitations. Where a performance standard is not practical or does not sufficiently meet the need for safety, NHTSA may specify an equipment requirement as part of an FMVSS.¹⁰²

Enforcement of such a performance requirement can be based on evidence obtained by engineering investigation that might include a post-crash investigation and/or system design investigation. For instance, if a crash occurs in which the vehicle under examination has collided with a lead vehicle, NHTSA could investigate the details surrounding the crash to determine if a warning was provided and the automatic emergency braking system applied the service brakes automatically. In appropriate cases in the context of an enforcement proceeding, NHTSA could also use its information-gathering authority to obtain information from a manufacturer describing the basis on which it certified that its FCW and AEB systems meet this proposed requirement.

B. Forward Collision Warning Requirement

NHTSA is proposing that AEB-equipped vehicles must have forward collision warning functionality that provides a warning to the vehicle operator if a forward collision with a lead vehicle is imminent. The proposal defines FCW as an auditory and visual warning provided to the vehicle operator that is designed to elicit an immediate crash avoidance response by the vehicle operator. The system must operate when the vehicle is traveling at any forward speed greater than 10 km/h (6.2 mph).

¹⁰² See 72 FR 17235, 17299 (Apr. 6, 2007) (discussing the understeer requirement in FMVSS No. 126); *Chrysler Corp. v. DOT*, 515 F.2d 1053 (6th Cir. 1975) (holding that NHTSA's specification of dimensional requirements for rectangular headlamps constitutes an objective performance standard under the Safety Act).

While some vehicles are equipped with alerts that precede the FCW and research has examined their use, NHTSA's proposal is not specifying an advisory or preliminary alert that would precede the FCW. Lerner, Kotwal, Lyons, and Gardner-Bonneau (1996) differentiated between an imminent alert, which "requires an immediate corrective action," and a cautionary alert, which "alerts the operator to a situation which requires immediate attention and may require a corrective action."¹⁰³ A 2004 NHTSA report titled "Safety Vehicles using adaptive Interface Technology (Task 9): A Literature Review of Safety Warning Countermeasures," examined the question of whether to include a cautionary alert level in an FCW system. Although the two FCW algorithms in the Automotive Collision Avoidance System Field Operational Test algorithms included a cautionary phase, the Collision Avoidance Metrics Partnership (1999) program recommended that only single (imminent) stage warnings be used.

Unlike the FCW required as part of the track testing, NHTSA is not specifically requiring that FCW presentation occur prior to the onset of braking in instances that are not tested on the track. This is to provide manufacturers with the flexibility to design systems that are most appropriate for the complexities of various crash situations, some of which may provide very little time for a driver to take action to avoid a crash. A requirement that FCW occur prior to automatic braking could suppress the automatic braking function in some actual driving scenarios, such as a lead vehicle cutting immediately in front of an AEB-equipped vehicle, where immediate automatic braking should not wait for a driver warning.

1. FCW Modalities

Since approximately 1994, NHTSA has completed research and published related reports for more than 35 research efforts related to crash avoidance warnings or forward collision warnings. These research efforts, along with other published research and existing ISO standards (15623 and 22839) and SAE International (SAE) documents (J3029 and J2400), provide a basis for the proposed requirements.¹⁰⁴

¹⁰³ Lerner, Kotwal, Lyons, and Gardner-Bonneau (1996). Preliminary Human Factors Guidelines for Crash Avoidance Warning Devices. DOT HS 808 342. National Highway Traffic Safety Administration.

¹⁰⁴ ISO 15623—Forward vehicle collision warning systems—Performance requirements and test procedures; ISO 22839—Forward vehicle

NHTSA NCAP and Euro NCAP information relating to FCW was also considered. Since model year 2011, the agency has included FCW as a recommended technology in NCAP and identifies to consumers which light vehicles have FCW systems that meet NCAP's performance tests. NHTSA's March 2022 request for comments notice on proposed changes to NCAP sought comment on which FCW modalities or modality combinations should be necessary to receive NHTSA's NCAP recommendation.¹⁰⁵ Commenters generally supported the use of a multimodal FCW strategy. The Alliance for Automotive Innovation and Intel both advocated allowing credit for any effective FCW signal type. Multiple commenters supported allowing NCAP credit for FCW having either auditory or haptic signals. BMW, Stellantis, and General Motors supported use of FCW auditory or haptic signals in addition to a visual signal. NTSB and Advocates for Highway and Auto Safety recommended that NHTSA conduct research examining the human-machine interface and examine the effectiveness of haptic warning signals presented in different locations (e.g., seat belt, seat pan, brake pulse). Dynamic Research, Inc. advocated allowing NCAP credit for implementation of a FCW haptic brake pulse, while ZF supported use of a haptic signal presented via the seat belt. Bosch warned that use of a haptic signal presented via the steering wheel for lane keeping or blind spot warning and FCW should be avoided as it may confuse the driver. The Alliance for Automotive Innovation raised the potential benefits of standardizing the warning characteristics to improve effectiveness as individuals move from vehicle to vehicle.

All current U.S. vehicle models appear to provide auditory and visual FCW signals, while only a few manufacturers also provide a haptic signal (e.g., seat pan vibration or a brake pulse). Visual FCW signals in current models consist of either a symbol or word (e.g., "BRAKE!"), presented on the instrument panel or head-up display, and most are red.

For this NPRM, NHTSA proposes that the FCW be presented to the vehicle operator via at least two sensory

collision mitigation systems—Operation, performance, and verification requirements (applies to light and heavy vehicles); SAE J3029: Forward Collision Warning and Mitigation Vehicle Test Procedure and Minimum Performance Requirements—Truck and Bus (2015–10; WIP currently); SAE J2400 2003–08 (Information report). Human Factors in Forward Collision Warning Systems: Operating Characteristics and User Interface Requirements.

¹⁰⁵ 87 FR 13452 (Mar. 9, 2022).

modalities, auditory and visual. Use of a multimodal warning ensures that most drivers will perceive the warning as soon as its presented, allowing the most time for the driver to take evasive action to avoid a crash. As a vehicle operator who is not looking toward the location of a visual warning at the time it is presented may not see it, NHTSA's proposal views the auditory warning signal as the primary modality and the visual signal as a secondary, confirmatory indication that explains to the driver what the warning was intended to communicate (i.e., a forward crash-imminent situation). However, because hearing-impaired drivers may not perceive an FCW auditory signal, a visual signal would be important for presenting the FCW to hearing-impaired individuals.

A multimodal FCW strategy is consistent with the recommendations of multiple U.S. and international organizations including ISO, SAE International, and Euro NCAP. ISO recommends a multimodal approach in both ISO 15623, "Forward vehicle collision warning systems—Performance requirements and test procedures," and ISO 22839, "Forward vehicle collision mitigation systems—Operation, performance, and verification requirements" (which applies to light and heavy vehicles). SAE addresses the topic of a multimodal FCW strategy in both information report J2400 2003–08, "Human Factors in Forward Collision Warning Systems: Operating Characteristics and User Interface Requirements," and J3029, "Forward Collision Warning and Mitigation Vehicle Test Procedure and Minimum Performance Requirements—Truck and Bus (2015–10; Work in Progress currently)." Most of these recommendations specify an FCW consisting of auditory and visual signals, while ISO 15623 specifies that an FCW include a visual warning as well as an auditory or haptic signal.

2. FCW Auditory Signal Characteristics

The proposed FCW auditory signal would be the primary means used to direct the vehicle operator's attention to the forward roadway and should be designed to be conspicuous to quickly capture the driver's attention, convey a high level of urgency, and be discriminable from other auditory signals presented within the vehicle.¹⁰⁶ Some specifications from NHTSA's "Human Factors Design Guidance For Driver-Vehicle Interfaces" are proposed

¹⁰⁶ DOT HS 810 697, Crash Warning System Interfaces: Human Factors Insights and Lessons Learned—Final Report

as forward collision warning specifications to meet these criteria.¹⁰⁷ As the FCW auditory signal would be the primary warning mode, this signal would not be permitted to be disabled.

To be conspicuous and quickly capture the driver's attention, the FCW auditory signal must ensure that the driver will readily detect the warning under typical driving conditions (e.g., ambient noise). The auditory signal must be clearly perceptible and quickly focus the driver's attention on the forward roadway. To ensure that the FCW auditory signal is conspicuous to the vehicle operator, any in-vehicle system or device that produces sound that may conflict with the FCW presentation would be required to be muted, or substantially reduced in volume, during the presentation of the FCW.¹⁰⁸ In order for the warning to be detectable, a minimum intensity of 15–30 dB above the masked threshold (MT) should be used.^{109 110 111 112} Because sound levels inside a vehicle can vary based on any number of different factors, such as vehicle speed and pavement condition, NHTSA is not proposing a specific sound level at this time, but requests comments on suitable and reasonable approaches for ensuring that the FCW auditory signal can be detected by drivers under typical driving conditions.

For communicating urgency and ensuring comprehension of auditory

messages, fundamental frequency, the lowest frequency in a periodic signal, is a key design parameter.¹¹³ Research has shown that auditory warning signals with a high fundamental frequency of at least 800 Hz more effectively communicate urgency.^{114 115} Greater perceived urgency of a warning is associated with faster reaction times, which would mean a quicker crash avoidance response by the driver.^{116 117 118} Therefore, NHTSA proposes that the FCW auditory signal's fundamental frequency must be at least 800 Hz.¹¹⁹ Additional proposed FCW auditory signal requirements that support communication of the urgency of the situation include a duty cycle,¹²⁰ or percentage of time sound is present, of 0.25–0.95, and faster auditory signals with a tempo in the range of 6–12 pulses per second to be perceived as urgent and elicit rapid driver response.¹²¹

The FCW auditory signal needs to be easily discriminable from other auditory signals in the vehicle. Therefore, vehicles equipped with more than one crash warning type should use FCW auditory signals that are distinguishable from other warnings.¹²² This proposed requirement is consistent with ISO 15623.¹²³ Standardization of FCW auditory signals would likely be beneficial in ensuring driver comprehension of the warning condition across vehicle makes and

models. NHTSA invites comments on the feasibility of specifying a common FCW auditory signal. While this proposal contains no specific requirements ensuring that the FCW auditory signal is distinguishable from other auditory warnings in the vehicles, NHTSA believes that industry is likely to consider this in their vehicle designs as part of their due diligence and safety assurance.

3. FCW Visual Signal Characteristics

Current FCWs in the U.S. vehicle fleet use a mix of symbols and words as a visual forward collision warning. Use of a common FCW symbol across makes and models would help to improve consumer understanding of the meaning of FCWs and encourage more appropriate driver responses in forward crash-imminent situations.

ISO 7000, “Graphical symbols for use on equipment—Registered symbols,”¹²⁴ and the SAE J2400 (2003–08)¹²⁵ information report, “Human Factors in Forward Collision Warning Systems: Operating Characteristics and User Interface Requirements,” contain recommended FCW symbols shown in Figure 1. These symbols are similar as they both communicate a forward impact, while the ISO symbol portrays the forward impact as being specifically with another vehicle.

¹⁰⁷ Campbell, J.L., Brown, J.L., Graving, J.S., Richard, C.M., Lichty, M.G., Sanquist, T., . . . & Morgan, J.L. (2016, December). Human factors design guidance for driver-vehicle interfaces (Report No. DOT HS 812 360). Washington, DC: National Highway Traffic Safety Administration.

¹⁰⁸ DOT HS 810 697, Crash Warning System Interfaces: Human Factors Insights and Lessons Learned—Final Report.

¹⁰⁹ Campbell, J.L., Brown, J.L., Graving, J.S., Richard, C.M., Lichty, M.G., Sanquist, T., . . . & Morgan, J.L. (2016, December). Human factors design guidance for driver-vehicle interfaces (Report No. DOT HS 812 360). Washington, DC: National Highway Traffic Safety Administration. “The amplitude of auditory signals is in the range of 10–30 dB above the masked threshold (MT), with a recommended minimum level of 15 dB above the MT (e.g., [1, 2, 3]). Alternatively, the signal is at least 15 dB above the ambient noise [3].”

¹¹⁰ Campbell, J.L., Richman, J.B., Carney, C., and Lee, J.D. (2002). In-vehicle display icons and other information elements. Task F: Final in-vehicle symbol guidelines (FHWA-RD-03-065). Washington, DC: Federal Highway Administration.

¹¹¹ International Organization for Standardization (ISO). (2005). Road vehicles—Ergonomic aspects of in-vehicle presentation for transport information and control systems—Warning systems (ISO/TR 16532). Geneva, Switzerland: International Organization of Standards.

¹¹² MIL-STD-1472F. (1998). Human engineering. Washington, DC: Department of Defense.

¹¹³ Campbell, J.L., Brown, J.L., Graving, J.S., Richard, C.M., Lichty, M.G., Sanquist, T., . . . & Morgan, J.L. (2016, December). Human factors design guidance for driver-vehicle interfaces (Report No. DOT HS 812 360). Washington, DC: National Highway Traffic Safety Administration.

¹¹⁴ Campbell, J.L., Brown, J.L., Graving, J.S., Richard, C.M., Lichty, M.G., Sanquist, T., . . . & Morgan, J.L. (2016, December). Human factors design guidance for driver-vehicle interfaces (Report No. DOT HS 812 360). Washington, DC: National Highway Traffic Safety Administration.

¹¹⁵ Guillaume, A., Drake, C., Rivenez, M., Pellieux, L., & Chastres, V. (2002). Perception of urgency and alarm design. Proceedings of the 8th International Conference on Auditory Display.

¹¹⁶ Campbell, J.L., Brown, J.L., Graving, J.S., Richard, C.M., Lichty, M.G., Sanquist, T., . . . & Morgan, J.L. (2016, December). Human factors design guidance for driver-vehicle interfaces (Report No. DOT HS 812 360). Washington, DC: National Highway Traffic Safety Administration.

¹¹⁷ Campbell, J.L., Richman, J.B., Carney, C., & Lee, J.D. (2004). In-vehicle display icons and other information elements, Volume I: Guidelines (Report No. FHWA-RD-03-065). Washington, DC: Federal Highway Administration. Available at www.fhwa.dot.gov/publications/research/safety/03065/index.cfm.

¹¹⁸ Sued, C., Susini, P., & McAdams, S. (2008). Evaluating warning sound urgency with reaction times. *Journal of Experimental Psychology: Applied*, 14(3), 201–212.

¹¹⁹ Campbell, J.L., Brown, J.L., Graving, J.S., Richard, C.M., Lichty, M.G., Sanquist, T., . . . & Morgan, J.L. (2016, December). Human factors design guidance for driver-vehicle interfaces (Report No. DOT HS 812 360). Washington, DC: National Highway Traffic Safety Administration.

¹²⁰ Duty cycle, or percentage of time sound is present, is equal to the total pulse duration divided by the sum of the total pulse duration and the sum of the inter-pulse intervals.

¹²¹ Gonzalez, C., Lewis, B.A., Roberts, D.M., Pratt, S.M., & Baldwin, C.L. (2012). Perceived urgency and annoyance of auditory alerts in a driving context. Proceedings of the Human Factors and Ergonomics Society Annual Meeting, 56(1), 1684–1687.



¹²² DOT HS 810 697, Crash Warning System Interfaces: Human Factors Insights and Lessons Learned—Final Report

¹²³ ISO 15623—Forward vehicle collision warning systems—Performance requirements and test procedures.

¹²⁴ ISO 7000—Graphical symbols for use on equipment—Registered symbols.

¹²⁵ SAE J2400 (info. report, not RP or standard), 2003–08. Human Factors in Forward Collision Warning Systems: Operating Characteristics and User Interface Requirements.

Figure 1: Industry Standard Visual Warning Symbols

Organization	Symbol
ISO 7000 – 2681: “Forward collision warning system (FCWS)”	
SAE J2400 (2003-08)	

Because the symbol in SAE J2400 relates the idea of a frontal crash without depicting a particular forward object, this symbol could visually represent and apply to both the lead vehicle and pedestrian scenarios. Therefore, NHTSA finds the SAE J2400 symbol to be most applicable to the FCW requirements in this proposal. NHTSA proposes that FCW visual signals using a symbol must use the SAE J2400 (2003–08) symbol.

Some other vehicle models employ a word-based visual warning, such as “STOP!” or “BRAKE!” SAE J2400 also includes a word-based visual warning recommendation consisting of the word, “WARNING.” A well-designed warning should instruct people about what to do or what not to do to avoid a hazard. The potential benefit of a word-based warning for FCW is that it can communicate to the driver an instruction about what to do to avoid or mitigate the crash, thereby expediting the driver’s initiation of an appropriate crash avoidance response. However, Consumer Reports noted in its online “Guide to forward collision warning” that for some models, visual warning word use was found to be confusing to some drivers surveyed.¹²⁶ Respondents reported a common complaint that “their vehicle would issue a visual “BRAKE” alert on the dash, but it wouldn’t bring the car to a stop” This confusion as to whether the word is meant to communicate what the driver should do or what the vehicle is doing may stem from drivers assuming that any information presented within the instrument panel area is communicating something relating to the vehicle’s condition or state, as symbols presented in that location generally do. Presenting a word-based warning in a higher location away from the instrument panel, as recommended

by SAE J2400, may be interpreted more accurately by drivers as well as increase the likelihood of FCW visual warning perception by drivers.¹²⁷ NHTSA requests comments on this issue and any available objective research data that relates to the effectiveness of word-based FCW visual signals in instrument panel versus head-up display locations. NHTSA also requests comments regarding whether permitting word-based warnings that are customizable in terms of language settings is necessary to ensure warning comprehension by all drivers.

One plausible benefit of a word-based visual warning is that some word choices that instruct the driver to initiate a particular action, such as “STOP!,” would be fully applicable to both lead vehicle and pedestrian scenarios, whereas a symbol containing an image of a lead vehicle would not be directly applicable to a forward pedestrian imminent crash scenario. As the response desired from the driver, to apply the brakes, is the same for both lead vehicle and forward pedestrian scenarios, the content of the visual warning need not be specific to the type of forward obstacle, but needs simply to communicate the idea of an impending forward crash. NHTSA requests comments and any available research data regarding the use and effectiveness of obstacle-specific symbols and word-based visual warnings and the relative effectiveness of word-based visual warnings compared to symbols.

While many current vehicle models present a visual FCW signal within the instrument panel, drawing a driver’s eyes downward away from the roadway to the instrument panel during a forward crash-imminent situation is likely to have a negative impact on the effectiveness of the driver’s response to the FCW. Research indicates that a

visual FCW signal presented in the instrument panel can slow driver response.¹²⁸ The research findings support the SAE J2400 recommendation advising against the use of instrument panel based visual FCWs.¹²⁹ SAE J2400 (2003–08) states:

Visual warnings shall be located within a 10-degree cone of the driver’s line of sight. Qualitatively, this generally implies a top-of-dashboard or head-up display location. A conventional dashboard location shall not be used for the visual warning. The rationale for this is based on the possibility that an instrument panel-based visual warning may distract the driver from the hazard ahead.

This FCW visual signal location guidance is also consistent with ISO 15623, which states that the FCW visual signal shall be presented in the “main glance direction.” Current vehicles equipped with head-up displays have the ability to present a FCW visual signal within the driver’s forward field of view. Furthermore, some GM vehicles not equipped with head up displays currently have the ability to present a FCW visual signal reflected onto the windshield in the driver’s forward line-of-sight. Despite the FCW visual signal being considered secondary to the auditory signal, NHTSA agrees that the effectiveness of a FCW visual signal would be maximized for both hearing and hearing-impaired drivers if the signal is presented at a location within the driver’s forward field of view above the instrument panel. To ensure maximum conspicuity of the FCW visual signal (be it word-based or a symbol), NHTSA proposes that it be presented within a 10-degree cone of the driver’s line of sight. The line of sight

¹²⁶ “Guide to forward collision warning: How FCW helps drivers avoid accidents.” Consumer Reports. <https://www.consumerreports.org/car-safety/forward-collision-warning-guide/>. Accessed April 2022.

¹²⁷ SAE J2400 2003–08 (Information report). Human Factors in Forward Collision Warning Systems: Operating Characteristics and User Interface Requirements.

¹²⁸ “Evaluation of Forward Collision Warning System Visual Alert Candidates and SAE J2400,” SAE Paper No. 2009–01–0547, <https://trid.trb.org/view/1430473>.

¹²⁹ SAE J2400 2003–08 (Information report). Human Factors in Forward Collision Warning Systems: Operating Characteristics and User Interface Requirements.

would be based on the forward-looking eye midpoint (M_f) as described in FMVSS No. 111, “Rear visibility,” S14.1.5.

The FCW visual signal would be required to be red, as is generally used to communicate a dangerous condition and as recommended by ISO 15623 and SAE J2400 (2003–08). Because the FCW visual signal is intended to be confirmatory for the majority of drivers, the symbol would be required to be steady burning.

4. FCW Haptic Signal

The agency considered also specifying a complementary haptic FCW signal as part of the proposed FCW specifications. Currently, only a portion of U.S. vehicles equipped with forward collision warning include a haptic warning component. For example, General Motors vehicles equipped with the haptic warning feature can present either a haptic seat pulse (vibration) or auditory warning based on a driver-selectable setting. Some other vehicle manufacturers, such as Stellantis and Audi, use a brake pulse, or brief deceleration of the vehicle, as part of the FCW. Some Hyundai/Kia models incorporate a haptic steering wheel vibration into the FCW. As haptic steering wheel signals are used by many lane keeping features of current vehicles to encourage drivers to steer the vehicle back toward the center of the lane, providing a haptic FCW signal via the steering wheel may result in driver confusion and be less effective in eliciting a timely and beneficial driver response.

ISO 15623 allows a haptic signal as an alternative to an auditory signal.¹³⁰ It permits a haptic brake pulse warning with a duration of less than 1 second when the driver is not already applying the brakes. ISO 15623 also allows actuation of a seat belt pretensioner as a haptic FCW signal.

Some research has shown that haptic FCW signals can improve crash avoidance response. NHTSA research on “Driver-Vehicle Interfaces for Advanced Crash Warning Systems” found that a haptic signal delivered via the seat belt pretensioner would be beneficial in eliciting an effective crash avoidance response from the vehicle operator. The research showed for FCWs issued at 2.1-s time-to-collision (TTC) that seat belt pretensioner-based FCW signals elicited the most effective crash avoidance performance.¹³¹ Haptic FCW

signals led to faster driver response times than did auditory tonal signals. FCW modality had a significant effect on participant reaction times and on the speed reductions resulting from participants’ avoidance maneuvers (regardless of whether a collision ultimately occurred). Brake pulsing or seat belt tensioning were found to be effective for returning distracted drivers’ attention to the forward roadway and eliciting desirable vehicle control responses; seat vibration similar to a virtual rumble strip (vibrating the front of the seat) was not found to return driver attention rapidly and reliably to the forward roadway within the Crash Warning Interface Metrics research. Similarly, research by Aust (2014) found that “combining sound with seat belt jerks or a brake pulse leads to significantly faster response times than combining the sound with a visual warning” and stated, “these results suggest that future FCWs should include a haptic modality to improve driver performance.”¹³² Aust (2014) also found use of a haptic seat belt FCW signal to be slightly more effective (100 ms faster driver response) than a haptic brake pulse in one of two scenarios (response times were equal in a second scenario). Despite these promising research results associated with use of a seat belt based FCW haptic component, NHTSA was unable to identify any current U.S. vehicle models equipped with a haptic seat belt FCW component.

Other studies found FCW haptic brake pulses effective at getting a driver’s attention and that drivers are more likely to detect a brake pulse if it produces a sensation of “jerk” or “self-motion.”¹³³ Kolke reported reaction times shortened by one-third (approximately 0.3 s, non-significant) when a brake pulse was added to an audio-visual warning.¹³⁵ One usability

November). Driver-vehicle interfaces for advanced crash warning systems: Research on evaluation methods and warning signals. (Report No. DOT HS 812 208). Washington, DC: National Highway Traffic Safety Administration.

¹³² Aust, M. (2014) Effects of Haptic Versus Visual Modalities When Combined With Sound in Forward Collision Warnings. Driving Simulation Conference 2014, Paper number 36. Paris, France, September 4–5, 2014.

¹³³ Lee, J.D., McGehee, D.V., Brown, T.L., & Nakamoto, J. (2012). Driver sensitivity to brake pulse duration and magnitude. *Ergonomics*, 50(6), 828–836.

¹³⁴ Brown, S.B., Lee, S.E., Perez, M.A., Doerzaph, Z.R., Neale, V.L., & Dingus, T.A. (2005). Effects of haptic brake pulse warnings on driver behavior during an intersection approach. *Proceedings of the Human Factors and Ergonomics Society 49th Annual Meeting*, 1892–1896.

¹³⁵ Kolke, Gauss, and Silvestro (2012). Accident reduction through emergency braking systems in passenger cars. Presentation at the 8th ADAC/BAST-

drawback is that drivers tend to report that vehicle brake pulses are too disruptive, which can lead to unfavorable annoyance.¹³⁶

Presentation of a FCW haptic signal via the driver’s seat pan has also been investigated. NHTSA’s “Human factors design guidance for driver-vehicle interfaces” contains best practice information for implementation of haptic displays, including “Generating a Detectable Signal in a Vibrotactile Seat.”¹³⁷ In a large-scale field test of FCW and LDW systems on model year 2013 Chevrolet and Cadillac vehicles, the University of Michigan Transportation Research Institute and GM found that GM’s Safety Alert Seat, which provides haptic seat vibration pulses, increases driver acceptance of both FCW and LDW systems compared to auditory signals.¹³⁸

NHTSA’s March 2022 request for comments notice on the NCAP sought comment on which FCW modalities or modality combinations should receive credit and asked specific questions regarding haptic signals and whether certain types should be excluded from consideration (*e.g.*, because they may be such a nuisance to drivers that they are more likely to disable the FCW or AEB system). A preliminary review of comments on that notice found multiple comments highlighting a need for more research relating to FCW signals. The National Transportation Safety Board highlighted the need for additional information regarding haptic signals presented in different locations, stating “[w]ithout examining the efficacy of different means of providing haptic alerts and defining appropriate, research-supported implementations, a prudent approach would give credit only for audible unimodal alerts or for bi-modal alerts that include audible alerts.” Rivian stated “[t]he agency should award credit to systems that provide both audible and haptic alerts

Symposium “Driving Safely in Europe.” October 5, 2012, Workshop B.

¹³⁶ Campbell, J.L., Brown, J.L., Graving, J.S., Richard, C.M., Lichty, M.G., Sanquist, T., . . . & Morgan, J.L. (2016, December). Human factors design guidance for driver-vehicle interfaces (Report No. DOT HS 812 360). Washington, DC: National Highway Traffic Safety Administration.

¹³⁷ Campbell, J.L., Brown, J.L., Graving, J.S., Richard, C.M., Lichty, M.G., Sanquist, T., . . . & Morgan, J.L. (2016, December). Human factors design guidance for driver-vehicle interfaces (Report No. DOT HS 812 360). Washington, DC: National Highway Traffic Safety Administration.

¹³⁸ Flannagan, C., LeBlanc, D., Bogard, S., Nobukawa, K., Narayanaswamy, P., Leslie, A., Kiefer, R., Marchione, M., Beck, C., and Lobes, K. (2016, February). Large-scale field test of forward collision alert and lane departure warning systems (Report No. DOT HS 812 247). Washington, DC: National Highway Traffic Safety Administration.

¹³⁰ ISO 15623—Forward vehicle collision warning systems—Performance requirements and test procedures.

¹³¹ Lerner, N., Singer, J., Huey, R., Brown, T., Marshall, D., Chrysler, S., . . . & Chiang, D.P. (2015),

and provide the option to turn either of them OFF based on driver preference. These audible or haptic alerts should be in sync with providing a visual alert of an impending collision. The agency should recommend the decibel level and the haptic feedback location and type as a baseline and based on research on reducing nuisance to the driver.” As the agency is actively reviewing comments, NHTSA is not proposing to require a complementary FCW haptic signal component at this time.

Given the lack of consensus within available research as to the best location for a FCW haptic signal (seat belt, seat pan, steering wheel, or brake pulse), NHTSA is not at this time proposing to require a haptic FCW component, but invites comment on whether requiring FCW to contain a haptic component presented via any location may increase FCW effectiveness or whether a FCW haptic signal presented in only one specific, standardized location should be allowed.

While the FCW auditory signal is envisioned as being the primary means of warning the driver, providing a haptic FCW signal that would complement or supplant the auditory warning signal would likely improve FCW perception for hearing-impaired drivers. Some drivers also may prefer an alternative modality to auditory warnings (e.g., due to annoyance caused by the auditory warning). However, the degree of additional benefit that may be accrued by requiring a haptic FCW signal in addition to a well-designed auditory and visual FCW that meets the specifications proposed is not known.

A haptic FCW signal, to be effective, would necessarily require the driver to

be in physical contact with the vehicle component through which the haptic signal is presented in order to perceive the warning. For example, if the driver is not wearing a seat belt, a haptic FCW signal presented via the seat belt would not be effectively received. A seat pan based haptic FCW signal would be unlikely to have such a non-contact issue. Providing a haptic FCW signal would increase the likelihood of FCW perception by hearing-impaired drivers and could also be used to provide an alternative modality to drivers who do not prefer auditory warnings. NHTSA is interested in research data documenting the comparison of a compliant auditory-visual FCW to that same FCW with an added haptic component. NHTSA also welcomes any objective data documenting the relative effectiveness of different haptic signal presentation locations for FCW use.

C. Lead Vehicle AEB—Performance Test Requirements

In addition to the requirement that vehicles must provide a forward crash warning and automatically control the brakes to reduce the vehicle’s speed, the agency is proposing performance test requirements that involve a no collision criterion under specific testing scenarios. NHTSA is proposing lead vehicle AEB performance tests requiring a vehicle to automatically brake or supplement insufficient manual braking as a means of avoiding contact with the lead vehicle under three specific test scenarios—stopped lead vehicle, slower-moving lead vehicle, and decelerating lead vehicle.

The scenarios are implemented using track tests and are based on those used

in NCAP and NHTSA’s research testing to evaluate AEB systems.¹³⁹ The proposed performance criterion for all AEB tests involving a lead vehicle is full collision avoidance, meaning the subject vehicle must not contact the lead vehicle. NHTSA chose the performance criterion of collision avoidance because it maximizes the safety benefits of the rule as compared to a metric that might permit a reduced speed collision. NHTSA has tentatively concluded that a no-contact criterion for the performance test requirements is practicable to achieve, consistent with the need for safety, and may be necessary to ensure test repeatability.¹⁴⁰

The lead vehicle AEB tests include parameters necessary to fully define the initial test conditions in each scenario. Key test parameters for the lead vehicle AEB tests include the travel speed of both the subject vehicle and lead vehicle, the initial headway between the subject vehicle and the lead vehicle, the deceleration of the lead vehicle, and any manual brake application made to the subject vehicle. Some of these key parameters are chosen from a range of values.¹⁴¹ The use of a range of potential values allows the agency to ensure that AEB system performance remains consistent, as test parameters vary within the bounds of the range. During testing, some AEB systems performed better at high speeds and did not perform well at lower speeds.¹⁴² The key proposed test parameters and the combinations in which they will be used are summarized in Table 21. The sections that follow provide more detail about the selection of these test parameters.

TABLE 21—LEAD VEHICLE AEB COLLISION AVOIDANCE—KEY TEST PARAMETERS

	Speed (km/h)		Headway ¹ (m)	Lead Vehicle Deceleration (g)	Manual brake application
	Subject vehicle	Lead vehicle			
Stopped Lead Vehicle	Any 10–80	0	No.
	Any 70–100	0	Yes.
Slower-Moving Lead Vehicle ...	Any 40–80	20	No.
	Any 70–100	20	Yes.
Decelerating Lead Vehicle	50	50	Any 12–40	Any 0.3–0.5	No.
	50	50	Any 12–40	Any 0.3–0.5	Yes.
	80	80	Any 12–40	Any 0.3–0.5	No.
	80	80	Any 12–40	Any 0.3–0.5	Yes.

¹ Where headway is not noted, headway is not a key parameter. The initial headway for these scenarios is based on the travel speeds and is defined within the detailed test conditions.

¹³⁹ 87 FR 13452 (Mar. 9, 2022).

¹⁴⁰ Requiring vehicles to avoid contact during testing addresses practical considerations as well. These practical considerations are discussed in section VI.G of this NPRM, in which NHTSA seeks comment on alternatives to the no-contact requirement.

¹⁴¹ In instances where an FMVSS includes a range of values for testing and/or performance requirements, 49 CFR 571.4 states, “The word any, used in connection with a range of values or set of items in the requirements, conditions, and procedures of the standards or regulations in this chapter, means generally the totality of the items or

values, any one of which may be selected by the Administration for testing, except where clearly specified otherwise.”

¹⁴² <https://www.regulations.gov/document/NHTSA-2021-0002-0002>.

The stopped lead vehicle scenario consists of the vehicle traveling straight ahead, at a constant speed, approaching a stopped lead vehicle in its path. The vehicle must be able to avoid contact with the stopped lead vehicle. The slower-moving lead vehicle scenario involves the subject vehicle traveling straight ahead at constant speed, approaching a lead vehicle traveling at a slower speed in the subject vehicle path. The decelerating lead vehicle scenario is meant to assess the AEB performance when the subject vehicle and lead vehicle initially are travelling at the same constant speed in a straight path and the lead vehicle begins to decelerate.

The agency proposes testing under two conditions. In one condition, NHTSA would test without any manual brake application. This would simulate a scenario where a driver does not intervene at all in response to the FCW or impending collision. In the other condition, NHTSA would test with manual brake application that would not be sufficient to avoid the crash. Not only does the second condition ensure that the AEB will supplement the manual braking when needed, it also provides a way by which to ensure that an application of insufficient manual braking does not suppress automatic braking in circumstances where it is initiated before the manual brake application is used.

The proposed speed ranges were selected based on the speeds at which rear-end crashes tend to happen, while considering two primary factors. The first factor is the practical ability of AEB technology to consistently operate and

avoid contact with a lead vehicle. NHTSA's 2020 research testing at 72.4 km/h suggested that the selected speed ranges for the various scenarios are within the capabilities of at least some MY 2020 AEB-equipped production vehicles. Where a speed range is proposed, it is meant to ensure AEB system robustness. As an example, during the agency's AEB research testing, two vehicles performed better at higher speeds (48 km/h or 30 mph) than at lower speeds (40 km/h or 25 mph) in the lead vehicle stopped tests, which suggests that the performance degradation at lower speeds was not due to the vehicles' brake capabilities.¹⁴³

The second factor is the practical limits of safely conducting track tests of AEB systems. Based on the available data, a majority of fatalities and injuries from rear-end crashes occur at posted speeds up to 60 mph (97 km/h). Due to the tendency of fatalities and injuries to increase as the vehicle travel speed increases, this proposal would allow for AEB system testing at the highest speeds at which NHTSA can safely and repeatably conduct tests. If the system does not intervene as required and the subject vehicle collides with the lead vehicle test device, it should do so in a manner that will not injure any vehicle occupants while also limiting damage to the subject vehicle and test equipment.

The proposed speed ranges were informed based on the results from the 2020 NHTSA research. When discussing the research as it relates to this notice, the tested vehicles were assigned an identifier as shown in Table 22.

¹⁴³ <https://www.regulations.gov/document/NHTSA-2021-0002-0002>.

Additional detail can be found in the Preliminary Regulatory Impact Assessment for this rulemaking.¹⁴⁴

TABLE 22—NHTSA R&D AEB TESTED VEHICLES AND ASSIGNED IDENTIFIER

Identifier	Vehicle
V1	2020 Nissan Altima.
V2	2020 Volvo S60 T6 AWD Momentum.
V3	2020 Honda Odyssey EX-L.
V4	2020 Toyota Corolla LE.
V5	2020 Ford F-150 4X4 SuperCrew.
V6	2020 Subaru Outback Premium/LDD.
V7	2020 Audi Q5 45 TFSI quattro.
V8	2020 Hyundai Palisade SEL FWD.
V9	2019 Audi A6 3.0 T quattro.
V10	2020 Land Rover Range Rover Sport HSE.
V11	2020 Mercedes-Benz GLC 300 4Matic SUV.

Agency CIB testing in the stopped lead vehicle scenario at 72.4 km/h (45 mph)—8 km/h (5 mph) lower than the proposed speeds—of 11 MY 2019/2020 vehicles found two vehicles avoided contact with a stopped lead vehicle in five consecutive tests (See Figure 2).¹⁴⁵ NHTSA's evaluation of model year 2021 and 2022 includes tests performed at the proposed speeds. The results of this testing are detailed in the lead vehicle AEB report docketed with this proposed rule.

BILLING CODE 4910-59-P

¹⁴⁴ The Preliminary Regulatory Impact Analysis can be found in the docket of this notice.

¹⁴⁵ National Highway Traffic Safety Administration (2022, March), "Final MY2019/MY2020 Research Reports for Pedestrian Automatic Emergency Braking, High-Speed Crash Imminent Braking, Blind Spot Warning, and Blind Spot Intervention Testing," <https://www.regulations.gov>, Docket No. NHTSA-2021-0002-0002.

Figure 2: NHTSA R&D AEB speed reduction by vehicle – subject vehicle speed 45 mph vs. stopped lead vehicle

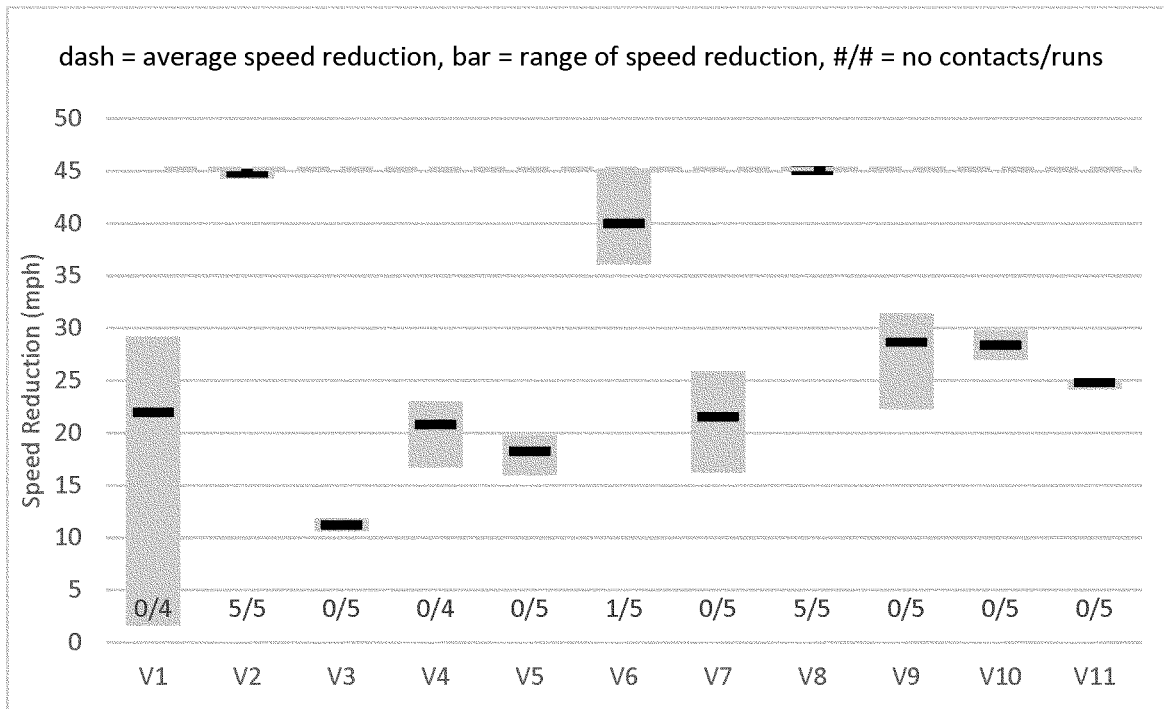

At this time, the agency has tentatively concluded that the maximum practicable test speed is 100 km/h (62 mph) and the maximum speed differential between the subject vehicle and the lead vehicle is 80 km/h (50 mph). The proposed test speed ranges reflect this conclusion.

1. Stopped Lead Vehicle Scenario Test Speeds

The two different speed ranges proposed for the AEB stopped lead vehicle tests are dependent on whether the brakes were applied manually in the subject vehicle during the test. For tests with no manual brake application, the test speed is chosen from any speed between 10 km/h (6 mph) and 80 km/h (50 mph). For tests with manual brake application, the test speed is chosen from any speed between 70 km/h (44 mph) and 100 km/h (62 mph).

For the stopped lead vehicle scenario, the proposed lower bound of the speed range is 70 km/h (44 mph) when testing with manual brake application and the lower bound of the speed range for the condition of no manual brake application is specified is 10 km/h (6 mph). This presents an overlap in test speeds where manual braking and automatic braking might occur. The overlap of the speed ranges is intended evaluate AEB system robustness by

ensuring that automatic braking still occurs if manual braking is insufficient to avoid the crash scenario. NHTSA believes that by testing at the higher end of the proposed speed range manufacturers will extend this functionality to the entire speed range and the testing burden can be reduced.

To assure that AEB system functionality with and without manual brake application exists, the speed ranges when testing with and without manual brake application overlap between 70 km/h (44 mph) and 80 km/h (50 mph). Because AEB systems must activate with or without manual brake application at all speeds above 10 km/h (6 mph), evaluating the subject vehicle braking performance with and without manual brake application from 70 km/h (44 mph) to 80 km/h (50 mph) provides a basis for comparison and a way to ensure that performance of the AEB system with manual brake application does not affect the ability of the subject vehicle to avoid colliding with the lead vehicle. These are the same criteria as proposed for AEB system performance without manual brake application.

The upper bound when testing with no manual brake application is 80 km/h (50 mph) since this is the highest

practicable test speed differential.¹⁴⁶ Similarly, the 100 km/h (62 mph) upper bound for the manual brake application scenario is the highest practicable test speed and testing speed differential.¹⁴⁷ Testing with the subject vehicle speed of 80 km/h (50 mph) is consistent with NHTSA's NCAP request for comments notice and Euro NCAP test speeds.¹⁴⁸

2. Slower-Moving Lead Vehicle Scenario Test Speeds

In the slower-moving lead vehicle scenario, the proposed subject vehicle test speed is any speed between 40 km/h (24.9 mph) and 80 km/h (50.0 mph). Given that the lead vehicle speed is always 20 km/h (12.4 mph) during the proposed lead vehicle moving test, this translates to a relative speed range of 20 km/h (12.4 mph) to 60 km/h (37.3 mph). Because the stopped lead vehicle test is almost always more stringent than the slower-moving lead vehicle test (both in

¹⁴⁶ See Travel Speed introduction section for further details.

¹⁴⁷ Under the proposed scenario the subject vehicle traveling at 100 km/h (62 mph) under constant average deceleration of 0.4 g would impact the lead vehicle in similar manner to the vehicle traveling at 80 km/h (50 mph) with no manual brake application.

¹⁴⁸ See NHTSA's NCAP Request for Comments notice (87 FR 13452 (Mar. 9, 2022) at 13485, 13487) and Euro NCAP test speeds (Euro NCAP TEST PROTOCOL—AEB VRU systems 3.0.2, July 2019).

terms of the AEB sensing/recognition and braking timing) NHTSA tentatively concludes that AEB performance at relative speeds below 20 km/h (12.4 mph) is adequately evaluated by the proposed stopped lead vehicle performance requirement, and it would be duplicative to test both scenarios at low speeds.

The second proposed subject vehicle speed range for tests performed with manual brake application is any speed between 70 km/h (43.5 mph) and 100 km/h (62.1 mph) (the same as for the

stopped lead vehicle scenario).¹⁴⁹ Given that the lead vehicle speed is always 20 km/h (12.4 mph) during the proposed lead vehicle moving test, this translates to a relative speed range of 50 km/h (31.1 mph) to 80 km/h (49.7 mph).

NHTSA's 2020 CIB research testing showed that all 11 tested vehicles did not collide with the lead vehicle when the vehicle speed was 40 km/h (24.9 mph), and lead vehicle speed was 16 km/h (9.9 mph). Furthermore, 10 of the 11 tested vehicles did not collide with the lead vehicle when the subject

vehicle speed was 72.4 km/h (45.0 mph) and the lead vehicle speed was 32.2 km/h (20.0 mph) on all test runs (See Figures 3 and 4).¹⁵⁰ Based on these data, NHTSA proposes one consistent 20 km/h (12.4 mph) speed for the slower-moving lead vehicle in this test scenario. These speed combinations also align with those specified in the March 9, 2022, NCAP RFC for the lead vehicle moving scenario, which have been shown to be practicable.¹⁵¹

Figure 3: NHTSA R&D AEB speed reduction by vehicle – subject vehicle speed 25 mph vs. slower lead vehicle speed 10 mph

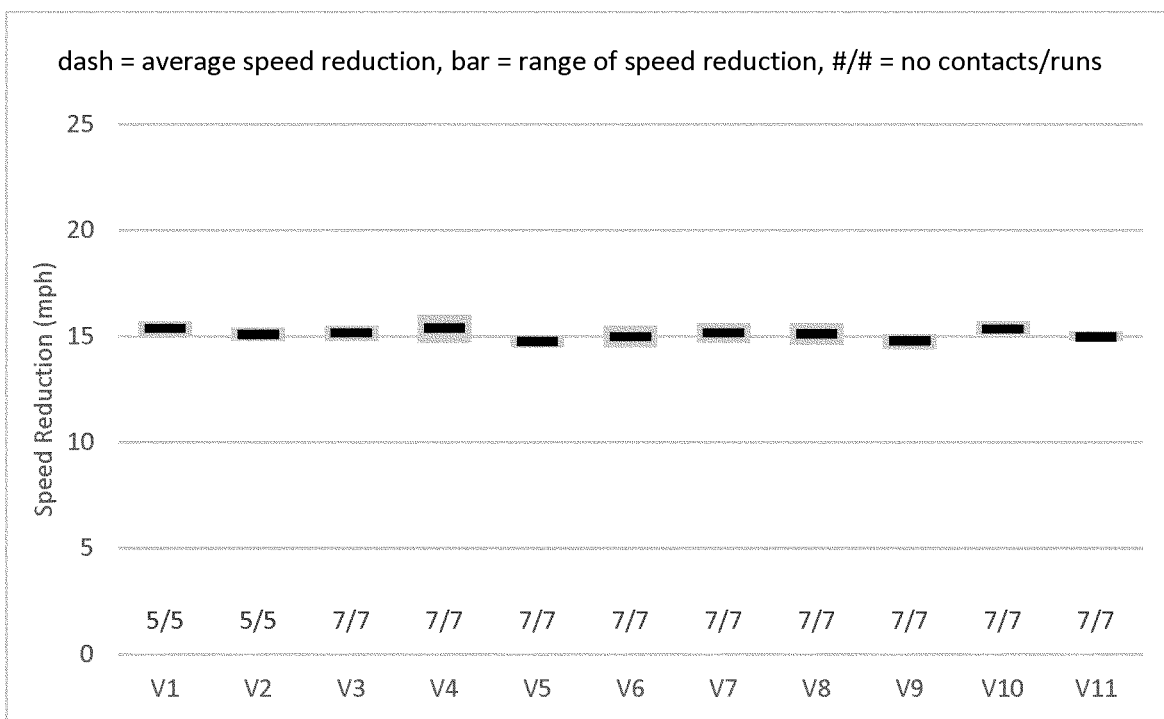

¹⁴⁹ See previous sections from *Travel Speed* for speed range reasoning not mentioned here.

¹⁵⁰ 87 FR 13452 (Mar. 9, 2022) and National Highway Traffic Safety Administration (2022, March), Final MY2019/MY2020 Research Reports

for Pedestrian Automatic Emergency Braking, High-Speed Crash Imminent Braking, Blind Spot Warning, and Blind Spot Intervention Testing, <https://www.regulations.gov>, Docket No. NHTSA-2021-0002-0002.

¹⁵¹ 87 FR 13452 (Mar. 9, 2022).

Figure 4: NHTSA R&D AEB speed reduction by vehicle – subject vehicle speed 45 mph vs. slower lead vehicle speed 20 mph

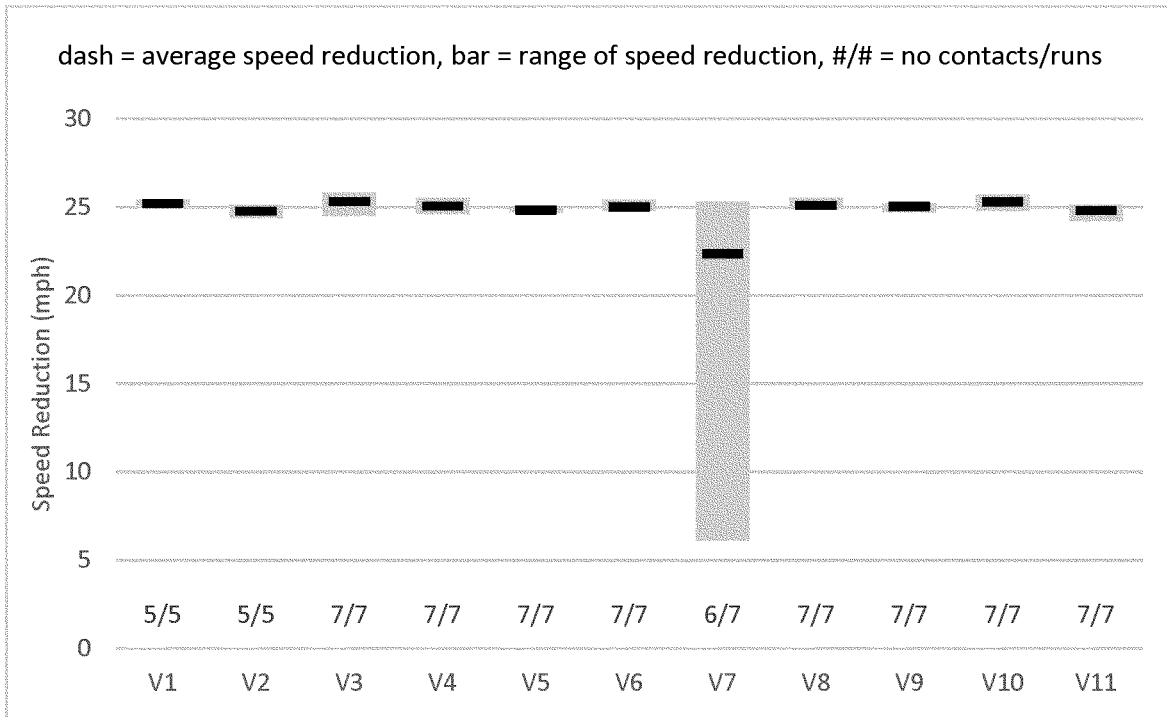

3. Decelerating Lead Vehicle Scenario Test Speeds

The initial speed conditions for the decelerating lead vehicle scenario are not as critical to the outcome of the test as other parameters. Because the subject and lead vehicle speeds are initially the same, the main parameters for a successful test outcome are the headway and lead vehicle deceleration. Thus, NHTSA proposes to use two discrete test speeds rather than a speed chosen from a range for both the subject and lead vehicles in the decelerating lead

vehicle test scenario, and to use ranges for the headway and deceleration parameters. This NPRM proposes that both the subject vehicle and lead vehicle travel at the same speed of either 50 km/h (31.1 mph) or 80 km/h (49.7 mph) in tests both with and without manual brake application.¹⁵²

NHTSA’s 2020 CIB research testing was performed with the subject vehicle and lead vehicle traveling at 56.3 km/h (35.0 mph) with a lead vehicle deceleration of 0.3g and 0.5g and a headway of 13.8 m (45.0 ft) (See Figure 5) as well as with the subject vehicle

and lead vehicle traveling at 72.4 km/h (45.0 mph) and a deceleration of 0.3g. When testing at 56.3 km/h (35.0 mph) with 0.3 g deceleration of the lead vehicle, 7 out of 11 vehicles avoided contact with the lead vehicle in all tests. Using the same test speeds but 0.5 g deceleration of the lead vehicle, 3 out of 11 vehicles avoided contact in all test runs. For the testing performed with the vehicle and lead vehicle travelling at 72.4 km/h (45.0 mph) and a deceleration of 0.3 g with the same headway of 13.8 m (45.0 ft), 4 out of 11 vehicles avoided contact with the lead vehicle.

¹⁵² The agency is proposing two discrete speeds, instead of one, for the Decelerating Lead Vehicles scenarios to ensure system robustness.

Figure 5: NHTSA R&D AEB speed reduction by vehicle – subject vehicle speed 35 mph, decelerating lead vehicle initial speed 35 mph, lead vehicle deceleration of 0.3g vs. 0.5g

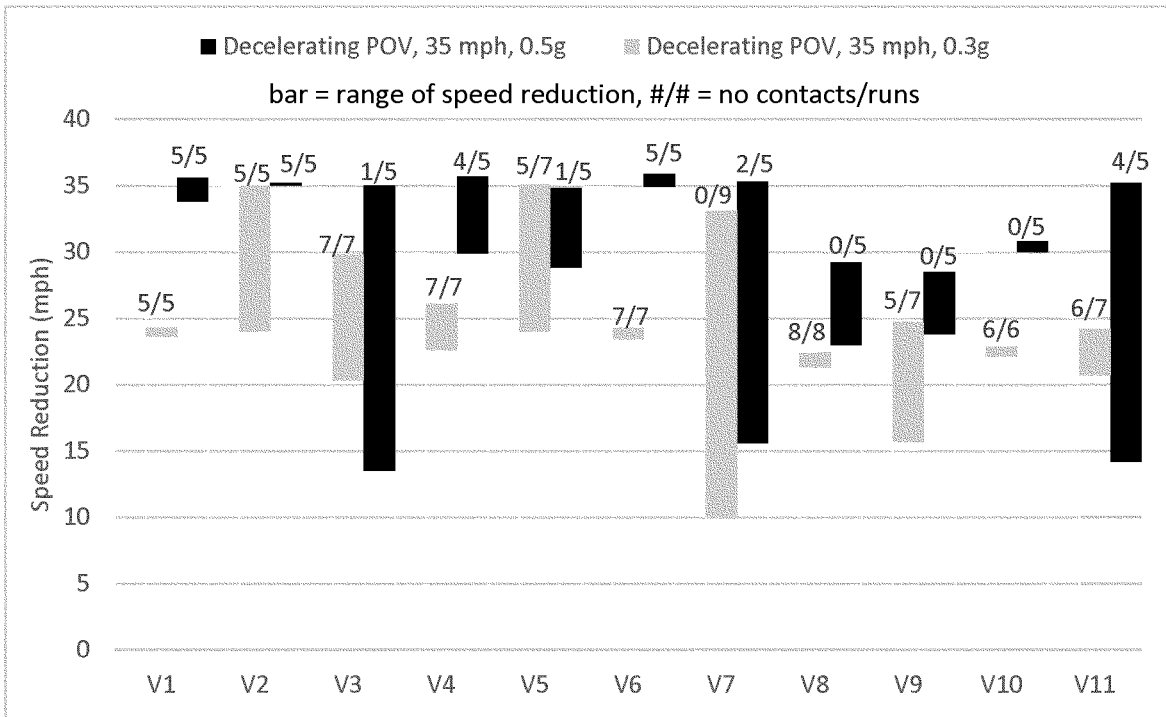
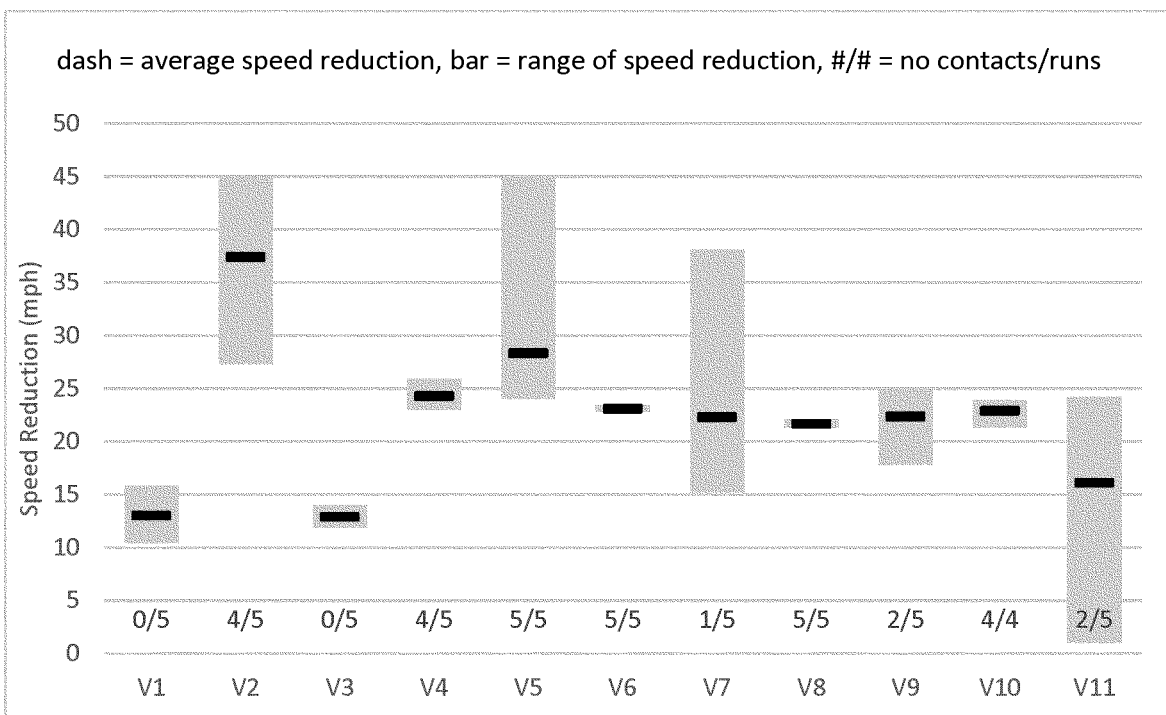

Figure 6: NHTSA R&D AEB speed reduction by vehicle – subject vehicle speed 45 mph, decelerating lead vehicle initial speed 45 mph, lead vehicle deceleration of 0.3g



BILLING CODE 4910-59-C

Headway and lead vehicle deceleration are the main parameters for the dynamics of the decelerating lead vehicle test because both subject and lead vehicles start the test at the same speed. At the start of the test, the proposed headway specifications include any distance between 12 m (39.4 ft) and 40 m (131.2 ft).¹⁵³ Based on the initial headway and lead vehicle deceleration, the most stringent headway and deceleration combination is the shortest headway (12 m (39.4 ft)) and the greatest deceleration (0.5g). Based on the 2020 research test results, which used a 13.8 m (45.3 ft.) headway for the decelerating lead vehicle test scenario, NHTSA has tentatively concluded based on the 2020 research test results that the proposed 12 m (39.4 ft) headway is practicable and is currently performing additional testing at this headway.¹⁵⁴

NHTSA proposes testing at any deceleration of the lead vehicle from 0.3g to 0.5g during the conduct of the decelerating lead vehicle tests. Based on previous agency research, when drivers need to apply the brakes in a non-emergency situation, they do so by decelerating up to approximately 0.306g, while drivers encountering an unexpected obstacle apply the brakes at 0.48g.¹⁵⁵ NHTSA's past research analysis of event data recorder data also showed that drivers applied the brakes at 0.383 g in rear-end crash scenarios.¹⁵⁶ Based upon this research, NHTSA has tentatively concluded that deceleration between 0.3g and 0.5g is representative of manual, on-the-road, service brake application.

From NHTSA's 2020 research testing, of the 11 vehicles tested with subject vehicle and lead vehicle speeds of 56.3 km/h (35.0 mph), a headway of 13.8 m (45 ft) and a lead vehicle deceleration of 0.5g, 3 vehicles avoided contact on every test run and 2 vehicles avoided contact on four out of five tests. When tested with a subject vehicle and lead vehicle speed of 56.3 km/h (35.0 mph) and a 0.3g lead vehicle deceleration, 7

out of 11 vehicles avoided contact with the lead vehicle in every test, and 3 of the other 4 vehicles avoided contact with the lead vehicle in five or six out of seven tests. The fourth vehicle could not avoid contact with the lead vehicle in the tests, but the AEB system provided an average speed reduction of 31 km/h (19.3 mph) over seven tests. When tested with a subject vehicle and lead vehicle speed of 72.4 km/h (45.0 mph) and a 0.3 g deceleration of the lead vehicle, 4 out of 11 vehicles avoided contact in every test and 2 other vehicles avoided contact in all but one test. Three of the remaining vehicles avoided contact in one or two tests, while the two others could not avoid contact but both demonstrated an average 21 km/h (13 mph) speed reduction.

From these results NHTSA has tentatively concluded that current AEB systems will be able to avoid a collision using a 12.0 m (39.3 ft) headway, 0.5g lead vehicle deceleration, and 50.0 km/h (31.1 mph) and 80.0 km/h (49.7 mph) subject vehicle speeds. Further, the agency believes that some of the other tested AEB systems have hardware capable of full crash avoidance, but the perception software is not tuned for the higher lead vehicle deceleration (0.5g).

4. Subject Vehicle Brake Application

The manual brake application tests two potential functions within the AEB system. The first function is directly linked to driver engagement. Normally, in a potential rear-end collision event, an FCW will be provided before the onset of automatic braking. In situations where it is practical for the vehicle to warn prior to automatic activation of the brakes, an inattentive driver may re-engage in the driving task and apply the brakes. However, in these circumstances, research suggests that a driver's brake application typically does not take advantage of the full capacity of the foundation braking system, and a crash may still occur. The AEB system, on the other hand, can use forward-looking sensor input, coupled with brake pressure information, to determine that additional braking is needed to avoid a crash. The proposed test conditions replicate this situation so that the AEB system must provide the additional braking needed to avoid contact with the lead vehicle.

The second function of the tests is to ensure that the brake application by the driver in a crash imminent situation does not suppress the vehicle's automatic brake application. In other words, the brake pedal cannot be used as a means of overriding the AEB system. NHTSA recognizes that in some

on-road scenarios, high-level emergency braking may not be the appropriate vehicle response. If deemed necessary to override an emergency braking event, a means to do so can be provided.

All lead vehicle scenarios include a test condition for which a manual brake application is used. This is functionally similar to NHTSA's NCAP DBS test. When manual brake application is part of the test parameters, the service brake on the subject vehicle is applied in such a manner that the subject vehicle decelerates with an average magnitude of 0.4g (absent automatic braking) starting at 1.0 second after onset of the FCW.

A deceleration of up to 0.5g is expected from a driver during an emergency crash imminent brake application. However, research has shown that female and older drivers tend not to apply the same force to the brake pedal as young male drivers, thus resulting in lower deceleration.¹⁵⁷ Based on this information, for the manual brake application tests, the brake pedal will be applied with a displacement, force, or some combination thereof, to sufficiently decelerate the subject vehicle an average of 0.4g. This is consistent with the manual brake applications defined in NHTSA's NCAP test procedures for DBS performance assessment and NHTSA's past research analysis of event data recorder data from rear-end crashes.^{158 159}

The brake will be applied 1.0 second after the vehicle has provided an FCW. This 1.0 second delay is based on the time it takes a driver to react when presented with an obstacle. Previous NHTSA research has shown that on average, it takes drivers 1.04 seconds to begin applying the brake when presented with an unexpected obstacle and 0.8 seconds when presented with an anticipated obstacle.¹⁶⁰

¹⁵³ The bounds of the headway range are consistent with the headways in the April 2021 European New Car Assessment Programme (Euro NCAP), Test Protocol—AEB Car-to-Car systems, Version 3.0.3 for the same scenario.

¹⁵⁴ 87 FR 13452 (Mar. 9, 2022).

¹⁵⁵ Gregory M. Fitch, Myra Blanco, Justin F. Morgan, Jeanne C. Rice, Amy Wharton, Walter W. Wierwille, and Richard J. Hanowski (2010, April) Human Performance Evaluation of Light Vehicle Brake Assist Systems: Final Report (Report No. DOT HS 811 251) Washington, DC: National Highway Traffic Safety Administration, p. 13 and p. 101.

¹⁵⁶ Automatic Emergency Braking System (AEB) Research Report, NHTSA, August 2014, pg. 47. <https://www.regulations.gov/document/NHTSA-2012-0057-0037>.

¹⁵⁷ Gregory M. Fitch, Myra Blanco, Justin F. Morgan, Jeanne C. Rice, Amy Wharton, Walter W. Wierwille, and Richard J. Hanowski (2010, April) Human Performance Evaluation of Light Vehicle Brake Assist Systems: Final Report (Report No. DOT HS 811 251) Washington, DC: National Highway Traffic Safety Administration, pp. 104–108.

¹⁵⁸ Automatic Emergency Braking System (AEB) Research Report, NHTSA, August 2014, pg. 47. <https://www.regulations.gov/document/NHTSA-2012-0057-0037>.

¹⁵⁹ National Highway Traffic Safety Administration (2014, August), *Dynamic Brake Support Performance Evaluation (working draft)*. Available at: <https://www.regulations.gov/document/NHTSA-2012-0057-0038>.

¹⁶⁰ Gregory M. Fitch, Myra Blanco, Justin F. Morgan, Jeanne C. Rice, Amy Wharton, Walter W. Wierwille, and Richard J. Hanowski (2010, April) Human Performance Evaluation of Light Vehicle Brake Assist Systems: Final Report (Report No. DOT HS 811 251) Washington, DC: National Highway Traffic Safety Administration, p. 101.

D. PAEB System Requirement

NHTSA is proposing that AEB systems also be able to provide a warning to the driver and automatically intervene to avoid or mitigate collisions with pedestrians in the vehicle's forward path. Similar to the lead vehicle AEB proposal, the performance requirements for PAEB are to provide an FCW and automatically apply the service brakes at all forward speeds attainable by the vehicle above 10 km/h (6 mph) in response to an imminent collision with a pedestrian.¹⁶¹ The proposal would require that the vehicle completely avoid a collision with a pedestrian test mannequin during specific test track scenarios. NHTSA is not proposing FCW and AEB systems to be active below 10 km/h (6 mph), because it has tentatively concluded that AEB systems do not offer consistent performance at such low speeds.¹⁶² A lower bound of 10 km/h (6 mph), which is 6 km/h (3.7 mph) less than that stipulated in NHTSA's 2019 draft PAEB research test procedure, is also consistent with the lower bound for testing under the Euro NCAP rating program and the proposed lower bound for PAEB testing under the agency's NCAP.¹⁶³ Not requiring PAEB to be active below 10 km/h (6 mph) should not be construed to preclude making the AEB system active, if possible, at speeds below 10 km/h (6 mph). In fact, the agency anticipates that manufacturers will make the system available at the lowest practicable speed (the manual for 6 of the 11 tested vehicles shows PAEB available at speeds below 10 km/h).

Automatic braking must be able to decelerate the vehicle when a collision with a pedestrian is imminent in the absence of any driver brake input. Unlike for lead vehicle AEB, the proposed requirements for PAEB do not require that the AEB system supplement the driver's brake input. The reason is that the agency has tentatively concluded that, due to the sudden succession of events in a potential collision between a vehicle and a pedestrian, particularly for the pedestrian crossing path scenarios, a driver is unlikely to have enough time to react to the crash imminent event, and the vehicle will brake automatically

without driver input. While this proposal would not specifically require PAEB to supplement driver brake input, it anticipates that AEB system designs will include this feature.

E. PAEB—FCW Requirement

NHTSA is proposing that the same FCW specifications outlined for the lead vehicle AEB condition be applied to the PAEB condition. The FCW system must operate at any forward speed greater than 10 km/h (6.2 mph). The proposed FCW modalities and related characteristics of auditory and visual components are the same for lead vehicle AEB and PAEB conditions. NHTSA is proposing that the auditory mode have a high fundamental frequency of at least 800 Hz, a duty cycle of 0.25–0.95, and tempo in the range of 6–12 pulses per second; the visual mode would be located according to SAE 2400 AUG2003 paragraph 4.1.14 and must include the crash icon in the bottom right of paragraph 4.1.16.¹⁶⁴ Line of sight as referenced in 4.1.14 would be determined based on the forward-looking eye midpoint (M_f) as described in FMVSS No. 111 S14.1.5.

Some current vehicle models display a pedestrian symbol during activation of the FCW for PAEB scenarios. However, NHTSA is now aware of research or data indicating that displaying a visual symbol that corresponds to the type of forward obstacle (*i.e.*, vehicle or pedestrian) affects the driver's response. Providing consistency across FCWs provided for lead vehicle AEB and PAEB imminent crash scenarios should maximize the likelihood that drivers will associate the FCW with a forward crash of any sort. As such, the agency is not proposing different symbols for the visual FCW modality based on the type of forward obstacle to which the AEB is responding.

When evaluating existing PAEB systems through NHTSA's 2020 research testing, the agency found that during certain test scenarios, FCW did not occur prior to the onset of automatic braking.¹⁶⁵ NHTSA tentatively

concludes that, due to the dynamics of some pedestrian crashes that result in a quick succession of events, it is impractical to require that the warning and automatic braking be sequential, as it could potentially hinder the reaction time of AEB systems. The agency anticipates that FCW may occur at any time during the automatic braking event. When it occurs after onset of automatic braking, the FCW would serve to inform the driver that automatic braking is ongoing, rather than solicit a driver response.

F. PAEB—Performance Test Requirements

NHTSA is proposing that AEB-equipped vehicles avoid a collision by applying the brakes automatically and alerting the vehicle operator when a collision with a pedestrian is imminent under specified test-track scenarios. Similar to the lead vehicle AEB performance test requirements, NHTSA has tentatively concluded that a no-contact requirement is necessary for PAEB testing in order to maximize safety. Even low-speed vehicle impacts with pedestrians can result in fatalities and serious injuries. NHTSA has tentatively concluded that a no-contact criterion for the performance test requirements is practicable to achieve, consistent with the need for safety, and may be necessary to ensure test repeatability.¹⁶⁶

The test scenarios proposed for PAEB evaluation involve track tests and are based on previous research completed by the agency to evaluate existing PAEB systems and on knowledge and experience from developing the related NCAP test procedures.¹⁶⁷ The proposed speed ranges and other key parameters detailed in the following sections are based on the observed capabilities of PAEB systems, limitations of the pedestrian test mannequins, and the safety problem.¹⁶⁸

Manual brake application by the driver is not a parameter of the proposed test scenarios for PAEB. However, NHTSA anticipates that, because AEB systems will be tested under the proposed requirements with manual brake activation for lead vehicle, that functionality will exist for

¹⁶¹ The FCW and brake application need not be sequential.

¹⁶² A review of 11 model year 2019/2020 vehicle owner's manuals found that PAEB activation ranged from 4.8 km/h (3 mph) to 11.3 km/h (7 mph) with the average being 7.7 km/h (4.8 mph).

¹⁶³ European New Car Assessment Program (Euro NCAP) (2019, July), Test Protocol—AEB Car-to-Car systems, Version 3.0.2; 87 FR 13452 (Mar. 9, 2022); and www.regulations.gov, NHTSA Docket No. NHTSA-2019-0102-0005.

¹⁶⁴ SAE 2400 AUG2003, Human Factors in Forward Collision Warning Systems: Operating Characteristics and User Interface Requirements.

¹⁶⁵ As an example, when testing the Obstructed Running Child, Crossing Path from the Right Scenario (see following paragraphs for scenario description) with a MY 2020 Subaru Outback traveling at 16 km/h the onset of the alert was 0.92s (FCW on time history plot) and service brake application was at 0.91 s (PAEB on time history plot) essentially at the same time. "Final Report of Pedestrian Automatic Emergency Braking System Research Testing of a 2020 Subaru Outback Premium/LDD," <https://www.regulations.gov/document/NHTSA-2021-0002-0002>, See: Figure D66. Time History for PAEB Run 180, S1d, Daytime, 16 km/h.

¹⁶⁶ Requiring vehicles to avoid contact during testing addresses practical considerations as well. These practical considerations are discussed in section VI.G of this NPRM, in which NHTSA seeks comment on alternatives to the no-contact requirement.

¹⁶⁷ See Research section of this notice, 87 FR 13452 (Mar. 9, 2022) at 13472 and 13473, and <https://www.regulations.gov/document/NHTSA-2021-0002-0002>.

¹⁶⁸ See Safety Problem section of this notice.

PAEB.¹⁶⁹ The absence of manual brake application in NHTSA’s proposed test parameters should not be construed to mean that AEB systems should not function when a manually applied brake input is present.

The proposed series of on-track tests fall into three groups of scenarios based on the pedestrian test mannequin actions. The first group of scenarios involves the test mannequin crossing the path of the vehicle. In each of the first group of scenarios, the test

mannequin travels perpendicular to the vehicle’s path. In the second group, the test mannequin is stationary within the path of the vehicle. In the third group, the test mannequin is moving along the travel path of the vehicle. In all scenarios, the test is set up such that the subject vehicle would collide with the test mannequin if it did not automatically brake. The key test parameters for the PAEB test scenarios include the type of test mannequin, the initial location of the test mannequin,

the direction of travel of the test mannequin, the point on the subject vehicle that would impact the test mannequin (the overlap), the vehicle speed, the speed of the test mannequin, the ambient light condition, and the headlamp beam used during darkness

These key test parameters and the combinations in which they will be used are summarized in Table 23. The sections that follow provide more detail about how and why these key test parameters were selected.

TABLE 23—PAEB COLLISION AVOIDANCE KEY TEST PARAMETERS

	Pedestrian surrogate reference location	Overlap (%)	Speed (km/h)		Lighting condition
			Subject vehicle	Pedestrian	
Crossing Path	Right	25	Any 10–60	5	Daylight.
	Right	50	Any 10–60		Daylight.
	Right	50	Any 10–60 ¹		Lower Beams.
	Right	50	Any 10–60	3 5	Upper Beams.
	Right ²	50	Any 10–50		Daylight.
	Left	50	Any 10–60		Daylight.
Stationary Along Path	Right	25	Any 10–55	0	Daylight.
			Any 10–55 ¹		Lower Beams.
			Any 10–55		Upper Beams.
Moving Along Path	Right	25	Any 10–65	5	Daylight.
			Any 10–65 ¹		Lower Beams.
			Any 10–65 ¹		Upper Beams.

¹ Final speed range requirements after an additional one-year phase-in.

² Obstructed, running child.

³ Running child.

⁴ Running adult.

There are certain test conditions in Table 23 where the test speed would be implemented one additional year after the initial proposed phase-in. Based on the performance of existing PAEB systems during the agency’s dark lower-beam and dark upper-beam pedestrian tests, NHTSA proposes a reduced speed range for the first three years after the proposed requirements are to take effect. As discussed further in this notice,

NHTSA has tentatively concluded that this approach would afford adequate lead time for vehicle manufacturers and suppliers to adjust their PAEB system designs for higher speed ranges in these scenarios. Table 24 summarizes the scenarios to which these changes apply. The agency proposes that four years after the date of publication of the final rule, the performance testing requirements follow all the key

parameters in Table 23. A more detailed discussion on the phase-in appears further below in this section. Concurrent with the development of this proposal, NHTSA conducted testing of model year 2021 and model year 2022 vehicles using the proposed performance test requirements. The details of these tests and results are docketed with this proposed rule.

TABLE 24—PAEB COLLISION AVOIDANCE KEY TEST PARAMETERS, REDUCED SPEED RANGES

	Pedestrian surrogate reference location	Overlap (%)	Speed (km/h)		Lighting condition
			Vehicle	Test mannequin	
Crossing Path	Right	50	Any 10–40	5	Lower Beams.
Stationary Along Path	Right	25	Any 10–50	0	Lower Beams.
Moving Along Path	Right	25	Any 10–60	5	Lower Beams.
			Any 10–60		Upper Beams.

¹⁶⁹ Since supplementing brake application is a functionality that must already exist for the lead vehicle AEB based on this NPRM, NHTSA

anticipates the same capability will be provided when the subject vehicle encounters an emergency

braking situation involving a pedestrian and manual braking is applied.

In all PAEB collision avoidance scenarios (see Table 23 and Table 24) the vehicle must avoid a collision with the pedestrian through use of the vehicle's AEB system without manual brake input.

NHTSA evaluated various scenarios when developing the draft NCAP test procedures for PAEB.¹⁷⁰ During this evaluation, four scenarios were found to account for 98 percent of functional years lost (*i.e.*, the years of life lost due to fatal injury and the years of functional capacity lost due to nonfatal injury) and the direct economic cost of all vehicle-pedestrian crashes, but they only accounted for 46 percent of all national pedestrian cases from NHTSA's General Estimate Systems database.¹⁷¹

¹⁷⁰ Mikio Yanagisawa, Elizabeth Swanson, and Wassim G. Najm (2014, April) Target Crashes and Safety Benefits Estimation Methodology for Pedestrian Crash Avoidance/Mitigation Systems (Report No. DOT HS 811 998) Washington, DC: National Highway Traffic Safety Administration, p. xi.

¹⁷¹ T. Miller, J. Viner, S. Rossman, N. Pindus, W. Gellert, J. Douglass, A. Dillingham, and G.

These scenarios were subject vehicle traveling straight ahead and pedestrian crossing the road, subject vehicle traveling straight ahead and pedestrian walking along/against traffic, subject vehicle turning right and pedestrian crossing the road, and subject vehicle turning left and pedestrian crossing the road.

Further NHTSA research found that, on average, the subject vehicle traveling straight ahead and pedestrian crossing the road and subject vehicle traveling straight ahead and pedestrian walking along/against traffic accounted for approximately 52 percent of vehicle-pedestrian crashes and 90 percent of fatal vehicle-pedestrian crashes with a light vehicle striking a pedestrian as the first event.¹⁷² Based on this research,

Blomquist, "The Costs of Highway Crashes". FHWA-RD-91-055, October 1991.

¹⁷² Mikio Yanagisawa, Elizabeth D. Swanson, Philip Azeredo, and Wassim Najm (2017, April) *Estimation of potential safety benefits for pedestrian crash avoidance/mitigation systems* (Report No. DOT HS 812 400) Washington, DC:

the following scenarios are proposed because they would have the highest impact on the safety problem.

1. PAEB Scenario Descriptions

Pedestrian Crossing Path From the Right

The crossing path from the right scenarios consist of the subject vehicle traveling straight ahead at a constant speed towards the adult pedestrian test mannequin, which enters its travel path from the right side of the vehicle.¹⁷³ The subject vehicle must be able to avoid contact with the pedestrian test mannequin crossing its path.

A basic setup for the pedestrian crossing the path of the vehicle from the right scenarios with 25 percent and 50 percent overlap is shown in Figure 7.

BILLING CODE 4910-59-P

National Highway Traffic Safety Administration, p. xiii.

¹⁷³ Travel Path is the path projected onto the road surface by a point located at the intersection of the subject vehicle's frontmost vertical plane and longitudinal vertical center plane as the subject vehicle travels.

Figure 7: Pedestrian Crossing Path from the Right 25 and 50 Percent Overlap Basic Setup

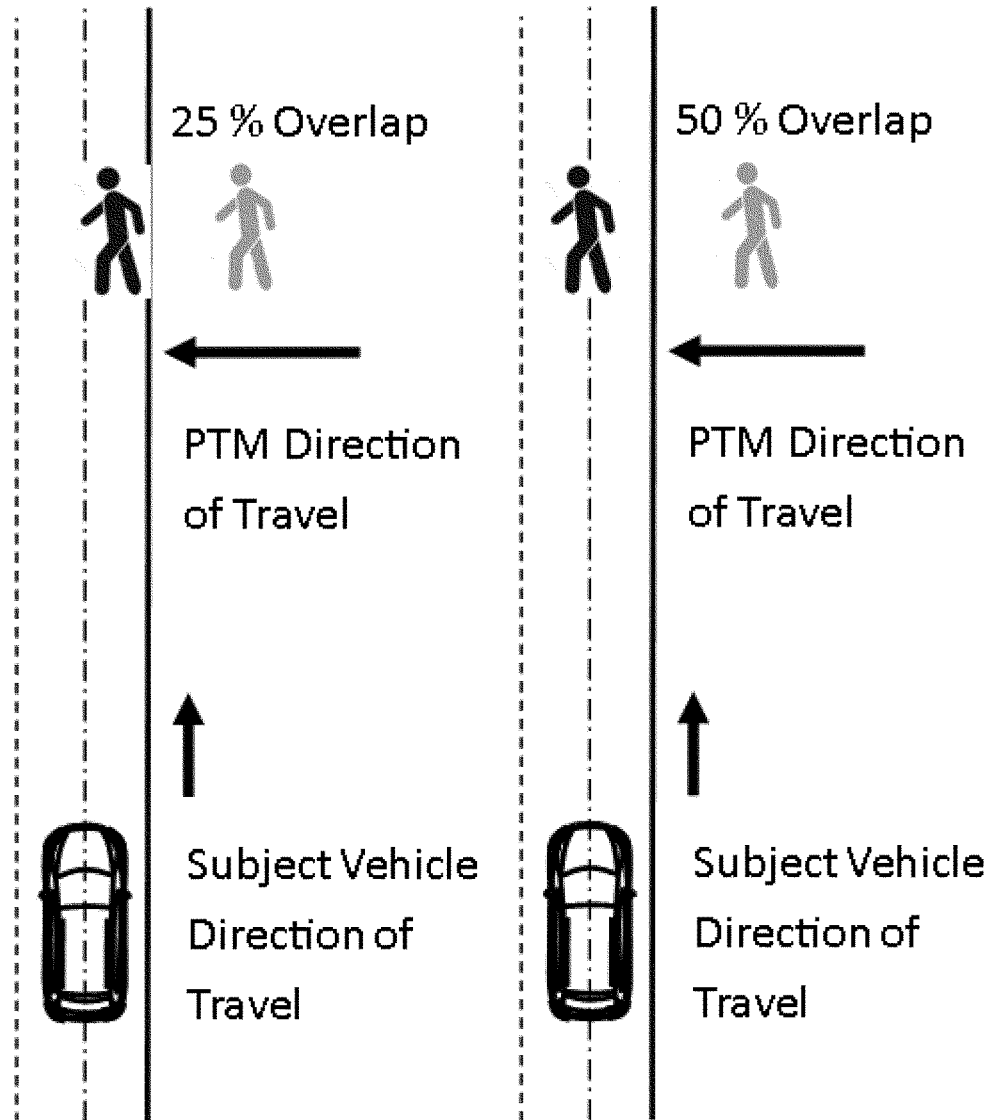

Pedestrian, Obstructed Running Child, Crossing Path from the Right

In this scenario, an obstructed child pedestrian moves in the vehicle's travel path. The child pedestrian is simulated by a child pedestrian surrogate that appears from the right of the travel path. The pedestrian surrogate crosses the subject vehicle's travel path from in

front of two stopped vehicle test devices. The VTDs are parked to the right of the subject vehicle's travel path, in the adjacent lane, at 1.0 m (3 ft) from the side of the subject vehicle. The VTDs are parked one after the other and are facing in the same direction as the

subject vehicle.¹⁷⁴ The basic setup for the obstructed running child pedestrian scenario is shown in Figure 8. The subject vehicle must avoid collision with the child pedestrian surrogate without manual brake input.

¹⁷⁴ See the Proposed Test Procedure section of this NPRM for further details.

Figure 8: Pedestrian Child Crossing Path from the Right Basic Setup

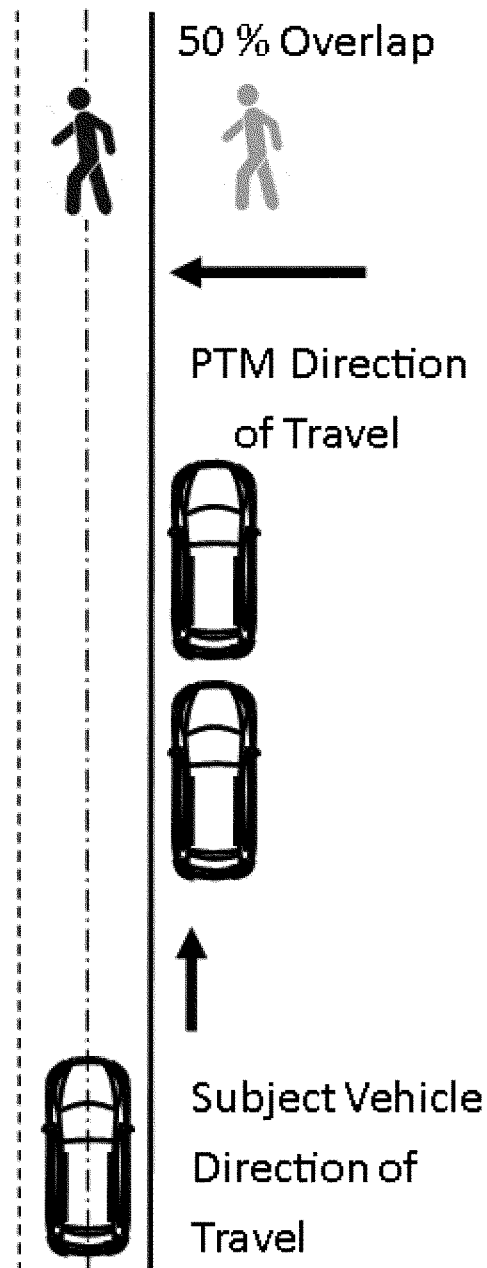

Pedestrian, Running, Crossing Path from the Left

In this scenario, a simulated running adult pedestrian (the pedestrian surrogate) crosses into the path of the vehicle traveling straight ahead at a constant speed. The pedestrian

surrogate enters the path from the left side of the vehicle. No contact between the subject vehicle and pedestrian surrogate is allowed. For testing, the subject vehicle travels at a constant

speed when it encounters the pedestrian surrogate crossing from the left side. Figure 9 shows the basic setup for this scenario.

Figure 9: Pedestrian Crossing Path from the Left Basic Setup

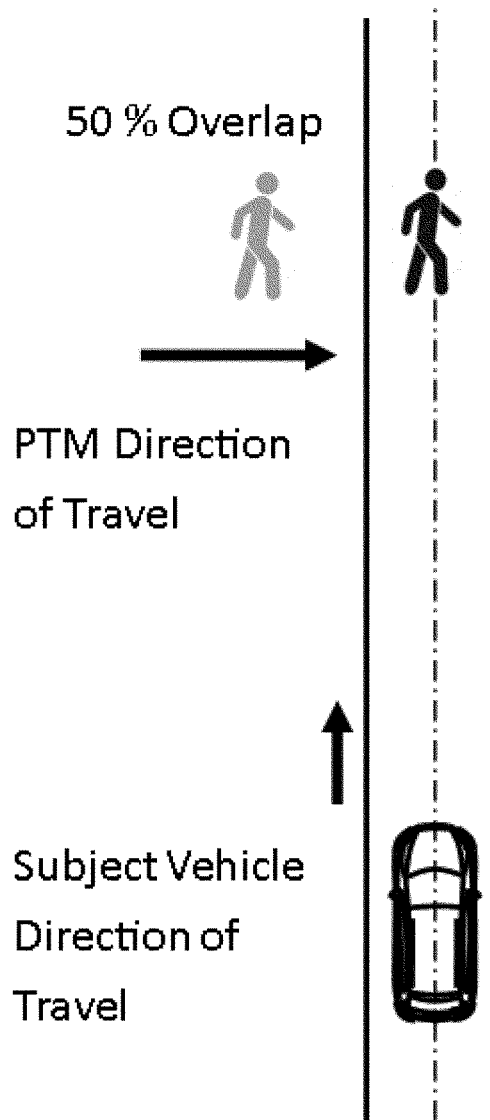

Pedestrian Along Path, Stationary

In this scenario the pedestrian surrogate, with its back to the subject vehicle, is stationary in the travel path of the subject vehicle at a 25 percent overlap. The subject vehicle travels at a

constant speed and encounters the stationary pedestrian surrogate positioned in the subject vehicle's path. The subject vehicle must completely avoid a collision with the pedestrian

surrogate. Figure 10 shows the basic setup for the pedestrian stationary in the path of the subject vehicle.

Figure 10: Pedestrian Along Path, Stationary Basic Setup

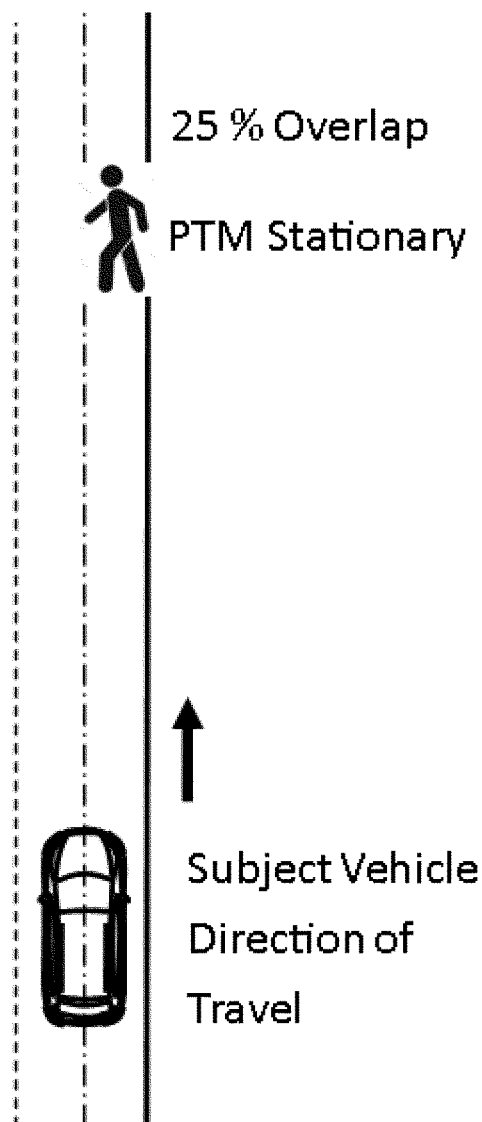

Pedestrian Along Path, Moving

In this scenario, a moving pedestrian is traveling along the vehicle's path. The vehicle must avoid collision with the pedestrian surrogate. Figure 11 shows the basic setup for this scenario.

Figure 11: Pedestrian Along Path, Moving Basic Setup

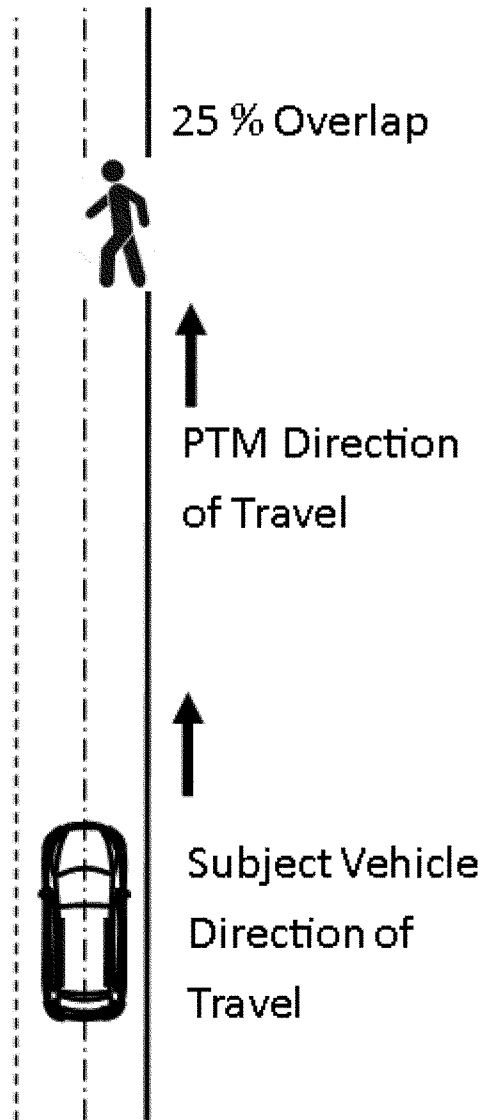

2. Overlap

The overlap is the location on the subject vehicle where the vehicle would collide with the pedestrian surrogate. Overlap is defined as the percent of the vehicle's width that the pedestrian would traverse prior to impact if the vehicle's speed and pedestrian's speed

remain constant. Overlap is based on overall vehicle width, as shown in Figure 12, and is the intended point of impact with the pedestrian mannequin in the absence of vehicle braking. Two overlaps are proposed for testing, a 25 percent overlap and a 50 percent overlap. The minimum overlap is 25

percent to allow for the test mannequin to be fully in the path of the vehicle. The overlap determines the available time for the AEB system to detect and react when a collision with the test mannequin is imminent—a 50 percent overlap allows for more time than a 25 percent overlap.¹⁷⁵

¹⁷⁵ As an example, for the timing, for a road width of 3 m (10 ft), a subject vehicle width of 2 m (7 ft) and the constant pedestrian speed of 5 km/h (3

mph), the time it takes the pedestrian to travel from the edge of the road to the 25% overlap is 0.72 s

and the time it takes the pedestrian to travel to the 50% overlap is 1.08 s.

Figure 12: Vehicle Overlap

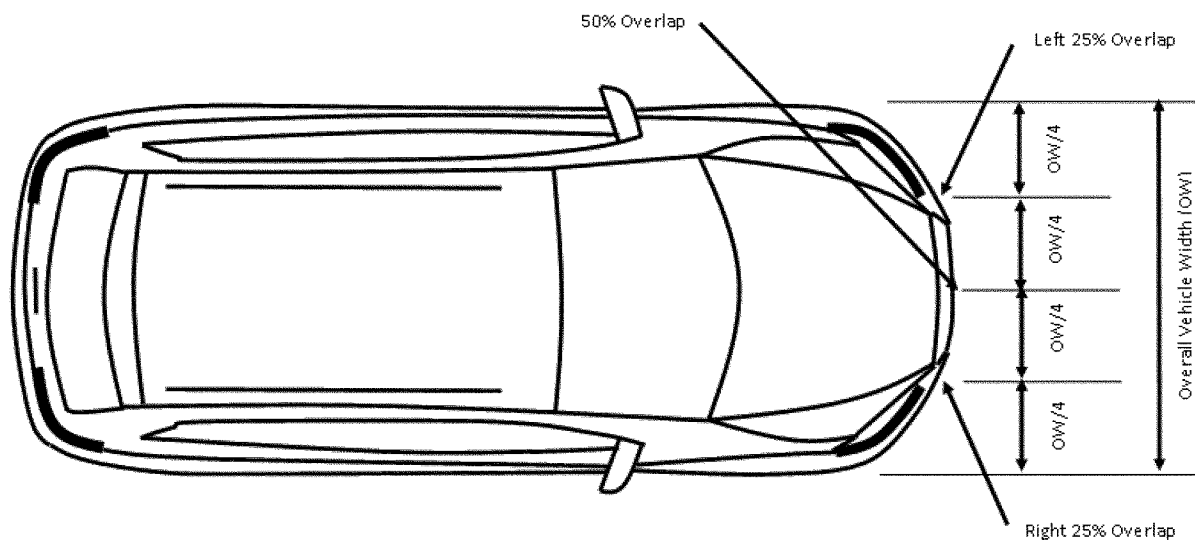
**BILLING CODE 4910-59-C**

For the scenarios involving a pedestrian crossing from the right, two overlap conditions are proposed: A more challenging test condition of 25 percent overlap and a 50 percent overlap to ensure system robustness. The 25 percent overlap tests are performed only under daylight conditions, while the 50 percent overlap tests are performed in all lighting conditions. For the crossing path scenarios, as described in the testing section of this notice, the pedestrian surrogate continues to travel along its path either until collision occurs or it clears the subject vehicle's path. NHTSA also considered a 75 percent overlap, and this condition was included in the testing performed in 2020. As expected, due to the increase in time range afforded by a larger overlap, the AEB performance observed when testing at 75 percent overlap was substantially similar to the AEB performance achieved when testing at 50 percent overlap.¹⁷⁶ NHTSA believes that a 75 percent overlap need not be included in the proposed requirements because the minimum performance is sufficiently addressed by testing at the 25 percent and 50 percent overlap.

Based on the no contact criterion and braking performance observed during its 2020 research testing of 11 vehicles, NHTSA is proposing to test PAEB performance with the dark upper beam and dark lower beam conditions at 50

¹⁷⁶ For the 75% overlap condition the agency only performed daylight testing. In general, when testing in the daylight condition, AEB performance was similar, or better, when testing at the 75% overlap versus testing at 50% and 25% overlaps.

percent overlap only. NHTSA has tentatively concluded that, due to the reduced timing and AEB system reaction time observed during the 25 percent overlap tests, testing at 25 percent overlap for the dark upper beam and lower beam is not currently practicable. NHTSA is also proposing to use only 50 percent overlap in the obstructed child running from the right and the running adult from the left scenarios due to the same reduced reaction time.

NHTSA considered requiring testing at 25 percent overlap for all crossing path scenarios. However, this would have required reducing the subject vehicle speed to allow more reaction time for the AEB system to avoid the pedestrian surrogate at the proposed speeds. NHTSA lacks information as to practicable maximum test speed for this condition. The proposal to test only at 50 percent overlap for certain scenarios allows for testing at higher speeds, which is more representative of the safety problem, while effectively encompassing tests at 25 percent overlap and lower speeds.¹⁷⁷ Further, if an AEB system is able to avoid collision in daylight at 25 percent overlap, poor performance for other crossing path

¹⁷⁷ For the pedestrian test mannequin to reach the 50 percent overlap, it must pass through the 25 percent overlap location. As an example, for a road width of 3 m (10 ft), a vehicle width of 2 m (7 ft), a pedestrian speed of 5 km/h (3 mph), a 0.7 g average deceleration and a AEB system which reacts when the pedestrian test mannequin reaches the edge of the road, testing with the subject vehicle speed of 27 km/h (17 mph) for the crossing path from the right scenario at 50 percent overlap is equivalent to testing at 18 km/h (11 mph) at 25 percent overlap.

scenarios would not be linked to the vehicle's braking performance, but rather would likely be linked to the detection and processing part of the AEB system.

The 25 percent overlap for the stationary and along path scenarios emulate a pedestrian standing stationary or walking on the roadway in the path of the subject vehicle. In along path scenarios in the real world, the pedestrian is positioned towards the edge of the roadway in the path of the subject vehicle. Positioning the pedestrian surrogate at 25 percent overlap assures that the surrogate test target is fully in the path of the vehicle. NHTSA has tentatively concluded that a 25 percent overlap for the along path scenarios also represents a more stringent condition than 50 percent overlap for the AEB system, as it ensures that the system has an adequate operational field of view and is able to identify pedestrians that are not at the center of the travel path.

3. Vehicle and Pedestrian Surrogate Travel Speeds

The proposed subject vehicle and pedestrian surrogate travel speed ranges for the PAEB test scenarios were informed by results from NHTSA's 2020 research study and results from a NHTSA research program examining four vehicles under dark lighting conditions for PAEB performance.^{178 179}

¹⁷⁸ 87 FR 13452 (Mar. 9, 2022).

¹⁷⁹ See 87 FR 13452 (Mar. 9, 2022) Tables 4, 5 and 6 for the complete test matrix. The other 4 vehicles tested for PAEB functionality under dark lighting

Continued

As in the case for lead vehicle AEB, the proposed speed ranges for PAEB testing consider two primary factors—the ability of AEB systems to consistently operate and avoid contact with the surrogate pedestrian and the practical limits for testing safely.¹⁸⁰

All proposed speed ranges for the PAEB tests have a lower bound of 10 km/h (6 mph). The upper bound is set at the highest speed NHTSA has tentatively determined is practicable. The 10 km/h (6 mph) lower bound for the speed range was based on the agency’s tentative conclusion that PAEB systems may not offer consistent

performance at speeds below 16 km/h (10 mph) and corroborated by NHTSA’s 2020 testing. The lower bound of 10 km/h (6 mph) is 6 km/h (4 mph) less than that specified in the 2019 NHTSA draft PAEB research test procedure and is consistent with the lower bound established for testing under Euro NCAP’s rating program and the lower bound proposed for NCAP testing.¹⁸¹ The agency has tentatively concluded that testing at speeds below 10 km/h is not practicable at this time and testing at speeds above 10 km/h sufficiently addresses performance of AEB systems

at low speeds. Concurrent with the development of this proposed rule, NHTSA performed PAEB testing on model year 2021 and 2022 vehicles using the proposed performance requirements and test procedures. The results of that testing provide additional support to the tentative conclusion that the test conditions, parameters, and procedures are practical to conduct and that the proposed requirements are practical for manufacturers to achieve. The results of this testing are detailed in the PAEB report docketed with the proposed rule.

TABLE 25—USER MANUAL PAEB RANGE OF FUNCTIONALITY BY TESTED VEHICLE

Vehicle	Speed			
	Low (km/h)	Low (mph)	High (km/h)	High (mph)
V1	9.6	6	59.2	37
V2	4.8	3	80	50
V3	4.8	3	99.2	62
V4	11.2	7	80	50
V5	4.8	3	120	75
V6	11.2	7	160	100
V7	9.6	6	80	50
V8	8	5	72	45
V9	9.6	6	80	50
V10	4.8	3	59.2	37
V11	6.4	4	68.8	43

About half of all pedestrian fatalities and injuries occur in areas where the posted speed limit is 40 mph or lower.¹⁸² In order to mitigate as much of the safety problem as possible, the agency is proposing the highest practicable speeds for the upper bound of the subject vehicle speed ranges. However, the testing speed may also be limited by the ability to test safely and repeatably. The pedestrian surrogates NHTSA plans to use for testing have a maximum impact speed of 60 km/h (37.5 mph). Therefore, similar to the lead vehicle, the highest subject vehicle test speed is determined by the speed differential, which is equivalent to the maximum impact speed. The maximum test speeds for crossing pedestrian and stationary adult scenarios are 60 km/h (37.5 mph), and 65 km/h (40.4 mph) for the pedestrian surrogate moving away from vehicle at 5 km/h (3.1 mph) scenario, which corresponds to a 60 km/h (37.5 mph) speed differential). The 65 km/h (37.5 mph) proposed subject

vehicle speed is consistent with NCAP’s request for comments notice but is 5 km/h (3.1 mph) greater than the Euro NCAP test speed.¹⁸³

When testing at higher speeds and dark lower and dark upper beam lighting conditions, PAEB performance was not consistent across the tested fleet. The test results, however, showed that for the majority of test conditions, at least one of the AEB systems for the MY 2019 and 2020 test vehicles could perform at the proposed speed ranges. NHTSA believes that this aggregate performance of available production AEB systems is not indicative of shortcomings in the overall capability of AEB technology, but is due to differences in how manufacturers have developed perception and decision-making algorithms for specific scenarios absent an FMVSS. To afford time to manufacturers to adjust the performance of their AEB systems to the proposed requirements, we are proposing an

extended phase-in period for some test conditions.

NHTSA observed a similar trend with the deployment of AEB technology approximately four years ago, when performance was inconsistent in NHTSA’s NCAP program for the lead vehicle AEB scenarios. AEB systems failed to meet all of the NCAP performance levels at that time, but AEB performance quickly improved as manufacturers updated and improved software.

The proposed walking and running speeds of the pedestrian surrogates are based on the action of the pedestrian in the test scenario. For walking adult scenarios and the running child scenario, the pedestrian surrogate speed is 5 km/h (3 mph), and for the running adult condition, the pedestrian surrogate speed is 8 km/h (5 mph). Research performed by Directorate-General for Research and Innovation and published in 2014 identified these speeds as most appropriate for PAEB

conditions were only tested at 16 km/h and 40 km/h.

¹⁸⁰ Where possible and practicable, the proposed speed ranges align with the latest NCAP proposed upgrade (87 FR 13452 (Mar. 9, 2022)). In instances where system performance for existing PAEB was

lower, or a safety need exists, the top speeds of the ranges were adjusted accordingly.

¹⁸¹ <https://www.euroncap.com/en/for-engineers/protocols/vulnerable-road-user-vru-protection/>, 87 FR 13452 (Mar. 9, 2022) and <https://www.regulations.gov/document/NHTSA-2019-0102-0005>.

¹⁸² See Safety Problem section of this notice.

¹⁸³ Euro NCAP test speeds, <https://www.euroncap.com/en/for-engineers/protocols/vulnerable-road-user-vru-protection/>, 87 FR 13470 (Mar. 9, 2022).

testing.¹⁸⁴ The proposed pedestrian surrogate speeds and the stationary pedestrian surrogate condition are also consistent with previous NHTSA research, 2019 draft NHTSA PAEB test procedures, and Euro NCAP.¹⁸⁵

4. Crossing Path Scenario Testing Speeds

Two speed ranges are proposed for the crossing path test conditions—a range of 10 km/h (6 mph) to 60 km/h (37 mph) for all adult pedestrian scenarios in the walking and running conditions

(pedestrian surrogate moving at 5 km/h (3 mph) and 8 km/h (5 mph), respectively), and a range of 10 km/h (6 mph) to 50 km/h (31 mph) for the running child (pedestrian surrogate moving at 5 km/h (3 mph)) obstructed view scenario.

The proposed speed ranges for PAEB are based on the results from the 2020 NHTSA research. When discussing the research as it relates to this notice, the tested vehicles were assigned an identifier as shown in Table 22. From the vehicles tested, V3 did not have

PAEB capabilities in most tests and is not further discussed. Testing performed for the 25 percent overlap daylight condition at 16 km/h (10 mph) and 40 km/h (25 mph) (pedestrian surrogate speed 5 km/h (3 mph)) showed that four of the tested vehicles avoided a collision with the pedestrian surrogate in all tests conducted and six vehicles avoided collision with the pedestrian surrogate in all tests when tested at 40 km/h (25 mph) (See Table 26).

Table 26: NHTSA R&D AEB ratio of no contact trials to total trials by vehicle and tested speed - adult pedestrian crossing path from the right scenario, 25 percent overlap, daylight¹⁸⁶

Subject Vehicle Speed (km/h)	V1	V2	V4	V5	V6	V7	V8	V9	V10	V11
11	--	--	--	--	--	--	--	--	--	6/6
16	5/5	5/5	5/5	0/3	3/6	6/6	5/5	5/5	4/5	0/4
35	--	--	--	--	--	--	--	--	4/5	--
40	5/5	5/5	5/5	5/5	5/5	3/5	3/5	6/6	2/5	0/4

Figure 13 shows the automatic speed reduction from the testing performed at the 25 percent overlap. As an example, if the subject vehicle traveling at 40 km/h (25 mph) would approach a stopped object, it would need to reduce its speed by 40 km/h (25 mph) to avoid collision with the object. However, since the pedestrian surrogate continues its movement even after reaching the

overlap, the subject vehicle does not need to come to a stop to avoid contact with the pedestrian surrogate (for an example, see V9 at 40 km/h (25 mph) in Figure 13). Different marker shapes are used based on the tested speed and shading of the markers to differentiate between the trials where the subject vehicle collided with the pedestrian surrogate and the successful trials with

no contact. As shown in the figures, a successful no contact trial is represented by a shaded (filled) shape, while the trials with contact are shown as shapes with no shade (no fill). The only exception are the trials at 16 km/h (10 mph), where the “x” represents the no contact trials and the “-” represents the trials with contact.

¹⁸⁴ <https://cordis.europa.eu/docs/results/285/285106/final1-aspecss-publishable-final-report-2014-10-14-final.pdf> at pg. 19.

¹⁸⁵ 87 FR 13452 (Mar. 9, 2022), Euro NCAP test speeds, <https://www.euroncap.com/en/for-engineers/protocols/vulnerable-road-user-vru-protection/>.

¹⁸⁶ <https://www.regulations.gov/document/NHTSA-2021-0002-0002>.

Figure 13: NHTSA R&D AEB speed reduction by vehicle and tested speed - adult pedestrian crossing path from the right scenario, 25 percent overlap, daylight¹⁸⁷

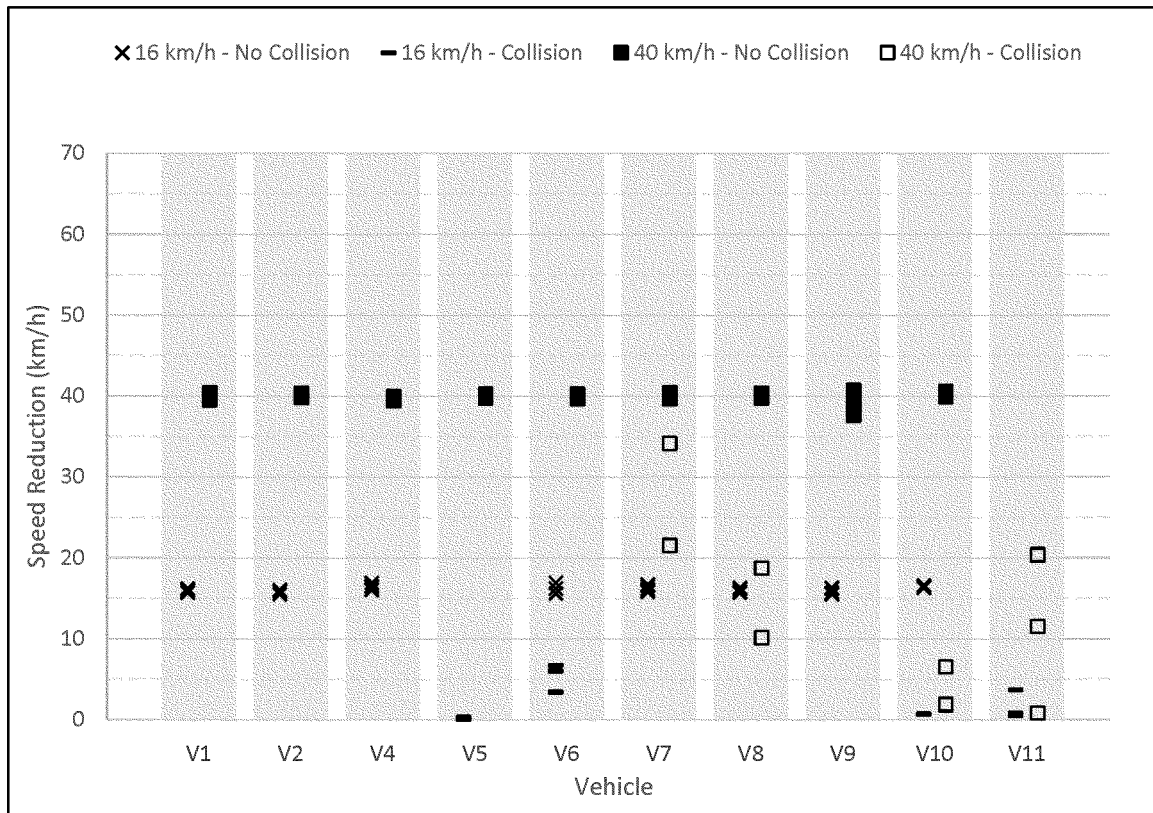

Even though testing was not performed at 60 km/h (37 mph) for the crossing path from the right and 25 percent overlap condition, based on the safety need and the consistency of the results observed at 40 km/h (25 mph) for the 25 percent overlap, NHTSA has tentatively concluded that the proposed performance testing requirements are practicable. The agency is currently performing testing at the proposed speed ranges, including the 60 km/h (37 mph) speed, to corroborate this conclusion. NHTSA is proposing a

range for the tested speeds from a low 10 km/h (6 mph) starting point to ensure system performance at all speeds, as opposed to only testing at the highest practicable speeds. As an example, the owner's manual of V5 shows the PAEB system working from 5 km/h (3 mph) up to 120 km/h (75 mph), but when tested, V5 failed to avoid collision on all trials at 16 km/h (10 mph). These proposed subject vehicle speed ranges are also consistent with Euro NCAP vehicle speed ranges and the pedestrian surrogate speeds are consistent with

both NCAP's latest request for comments notice and Euro NCAP pedestrian testing speeds.¹⁸⁸

The crossing path from the right at 50 percent overlap test scenarios with an adult pedestrian surrogate in the daylight condition was performed at a range of speeds from 16 km/h (10 mph) up to 60 km/h (37 mph) in NHTSA's 2020 research study. From the 10 relevant vehicles, 3 avoided collision in all tests up to 50 km/h (31 mph) and one avoided collision in all but one test up to 60 km/h (37 mph) (See Table 27).

¹⁸⁷ *Id.*

¹⁸⁸ Euro NCAP test speeds, <https://www.euroncap.com/en/for-engineers/protocols/>

vulnerable-road-user-vru-protection/, 87 FR 13470 (Mar. 9, 2022).

Table 27: NHTSA R&D AEB ratio of no contact trials to total trials by vehicle and tested speed - adult pedestrian crossing path from the right scenario, 50 percent overlap, daylight

Subject Vehicle Speed (km/h)	V1	V2	V4	V5	V6	V7	V8	V9	V10	V11
16	6/6	5/5	5/5	1/4	5/5	5/5	5/5	6/6	5/5	3/5
20	7/7	5/5	5/5	6/6	6/6	5/5	5/5	5/5	3/5	5/5
30	5/5	3/5	5/5	5/5	5/5	5/5	5/5	5/5	5/5	4/5
40	5/5	3/5	5/5	5/5	5/5	5/5	5/5	5/5	2/4	3/5
45	--	--	--	0/3	--	--	1/4	--	0/4	3/5
50	5/5	5/5	5/5	0/3	5/5	4/6	0/3	5/6	0/3	0/4
55	--	--	--	--	5/5	0/3	--	1/1	--	--
60	5/7	3/5	4/5	--	1/4	0/1	--	5/5	--	--

Figure 14 shows the speed reduction at various tested speeds. For clarity, not all tested speeds are shown. The testing speeds shown represent the current PAEB research test procedures test speeds (16 km/h (10 mph) and 40 km/h

(25 mph)) and three other speeds relevant to the proposed testing requirements. The three vehicles that avoided impact on all tests up to 50 km/h (31 mph) were also able to significantly reduce their speeds when

tested at 60 km/h (37 mph). This suggests that a slight tuning of the AEB systems would allow those systems to avoid collision at 60 km/h (37 mph).

Figure 14: NHTSA R&D AEB speed reduction by vehicle and tested speed - adult pedestrian crossing path from the right scenario, 50 percent overlap, daylight

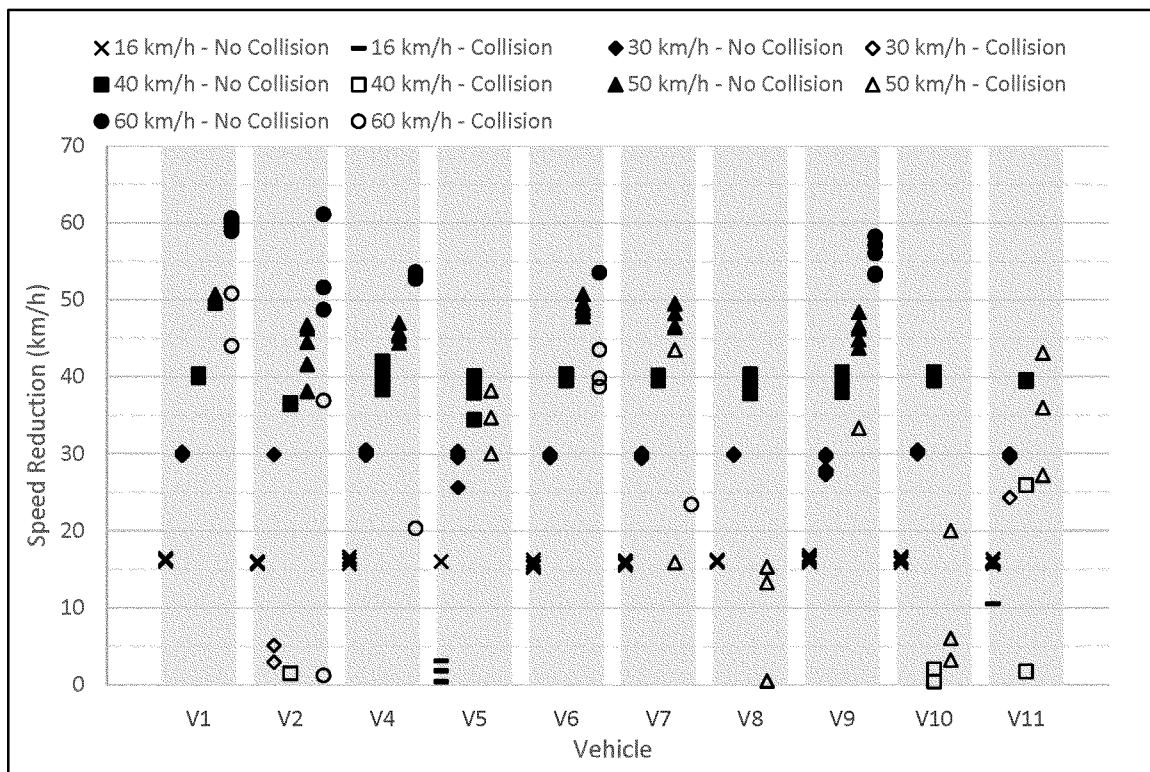

In the agency's crossing path from the right with 50 percent overlap during dark lighting condition using the vehicle's upper beam headlamps, one

vehicle avoided collision in all but one test when tested at speeds up to 60 km/h (37 mph), and another vehicle avoided collision on all tests at speeds above 20

km/h (12 mph) and on most tests at 16 km/h (10 mph). A total of four vehicles avoided collision either on all or some of the tests at 60 km/h (37 mph) and on

all tests at 50 km/h (31 mph). Table 28 shows a summary of the tests with no contact versus the total number of tests conducted at each test speed.

Table 28: NHTSA R&D AEB ratio of no contact trials to total trials by vehicle and tested speed - adult pedestrian crossing path from the right scenario, 50 percent overlap, dark, upper beam

Subject Vehicle Speed (km/h)	V1	V2	V4	V5	V6	V7	V8	V9	V10	V11
11	--	2/5	--	0/3	--	0/3	--	--	0/3	--
16	3/5	0/3	5/5	5/8	3/5	0/3	4/5	7/7	0/3	5/5
20	4/4	3/4	5/5	5/5	3/5	--	5/5	4/5	--	5/5
25	--	--	--	--	--	--	--	2/5	--	--
30	4/4	5/5	5/5	4/5	5/5	--	5/5	0/4	--	4/5
35	--	--	--	--	--	--	--	--	--	5/5
40	5/5	5/5	5/5	5/8	4/5	0/3	5/5	1/4	0/2	1/4
45	--	--	--	--	--	--	0/3	--	--	--
50	3/3	4/4	5/5	--	6/6	--	--	--	--	--
55	--	--	--	--	4/5	--	--	--	--	--
60	6/6	4/5	5/5	--	1/4	--	--	--	--	--

The four vehicles that avoided contact with the test mannequin on all or some of the tests at 60 km/h (37 mph) also achieved a speed reduction of 30 km/h

(19 mph) or more before collision in the tests where contact was observed (See Figure 15), which suggests that the systems can be adjusted with minimal

hardware to the achieve consistent collision avoidance at 60 km/h (37 mph).

Figure 15: NHTSA R&D AEB speed reduction by vehicle and tested speed - adult pedestrian crossing path from the right scenario, 50 percent overlap, dark upper beam

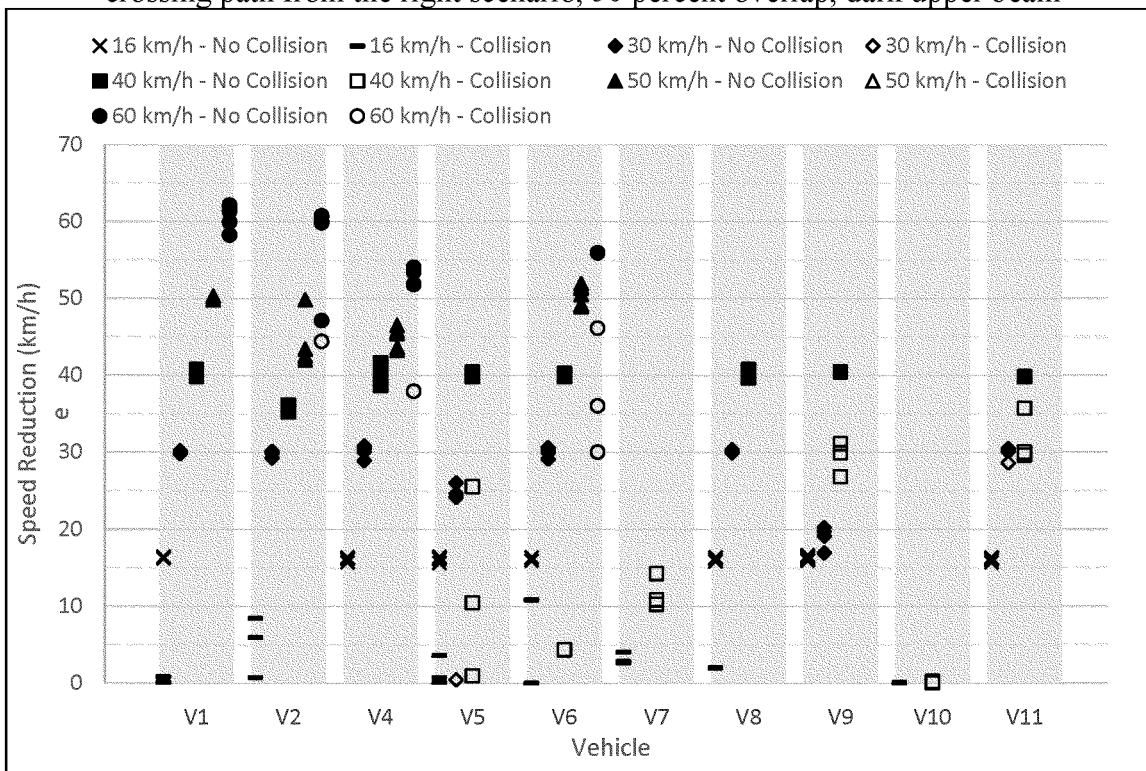

When testing the crossing path scenario from the right with 50 percent overlap at night using the lower beam headlamps, performance was generally worse than when testing with the upper beam headlamps or during the daylight condition. Only two vehicles were

tested at 50 km/h (31 mph), one of which avoided contact in two out of four tests and the other made contact in every test.¹⁸⁹ V4 had no contact in four out of five tests at 40 km/h (25 mph) and V6 avoided collision in all tests at the same speed. From the 10 vehicles

tested, 5 had at least one test that resulted in collision avoidance at 40 km/h (25 mph). A summary of the no contact tests and the total number of tests per vehicle at each speed is presented in Table 29.

Table 29: NHTSA R&D AEB ratio of no contact trials to total trials by vehicle and tested speed - adult pedestrian crossing path from the right scenario, 50 percent overlap, dark, lower beam

Subject Vehicle Speed (km/h)	V1	V2	V4	V5	V6	V7	V8	V9	V10	V11
11	--	0/3	--	0/4	--	0/3	--	--	0/3	--
16	0/3	0/3	5/5	0/4	4/5	0/3	5/5	6/6	0/3	5/5
20	--	--	5/5	--	3/5	--	5/5	5/5	--	5/5
30	--	--	5/5	--	5/5	--	5/5	3/5	--	5/5
35	--	0/3	--	--	--	--	--	0/3	--	--
40	0/3	0/3	4/5	0/4	5/5	0/3	4/5	1/4	0/3	3/5
45	--	--	3/5	--	2/5	--	0/3	--	--	4/5
50	--	--	2/4	--	0/3	--	--	--	--	--

¹⁸⁹ In general, based on the testing matrix a vehicle was tested at a higher speed only after it

had a majority of no contact tests at the previous tested speed. Conversely, testing at a 5 km/h lower

speed was performed only if the vehicle had at least one no contact test at the higher speed.

Of the two vehicles tested at 50 km/h (31 mph), V6 only had tests that resulted in contact but was able to achieve a speed reduction of 33 km/h (21 mph) in two tests and 23 km/h (14 mph) in the other. While V4 was able to avoid contact in two tests, it only showed a speed reduction of 13 km/h (8 mph) in the tests with contact. The five vehicles that had at least one no contact run at 40 km/h (25 mph) also achieved a speed reduction of 25 km/h (16 mph) or more (except for one test for V9) on the tests which resulted in contact with the test mannequin. Speed reduction by

vehicle and tested speed for this scenario is presented in Figure 16. The observed performance of AEB systems when tested under the dark lower beam condition led the agency to tentatively conclude that requiring PAEB at speeds up to 60 km/h (37 mph) is not practicable at this time, but achievable with an adequate phase-in. Therefore, for this scenario, as well as other dark testing scenarios (see Table 25), in order to afford manufacturers sufficient time to adjust the performance of the AEB systems to the proposed test requirements, the higher testing speeds

are proposed to be implemented four years (instead of three years) after the date of publication of the final rule. Based on the results of NHTSA's testing, a 10 to 40 km/h (6 to 25 mph) range is currently practicable (See Figure 16). Tests conducted on model year 2021 and 2022 vehicles (available in the docket of this proposed rule) and based on current data from NHTSA's 2020 research testing, NHTSA expects improved performance across all speeds.

Figure 16: NHTSA R&D AEB speed reduction by vehicle and tested speed - adult pedestrian crossing path from the right scenario, 50 percent overlap, dark lower beam

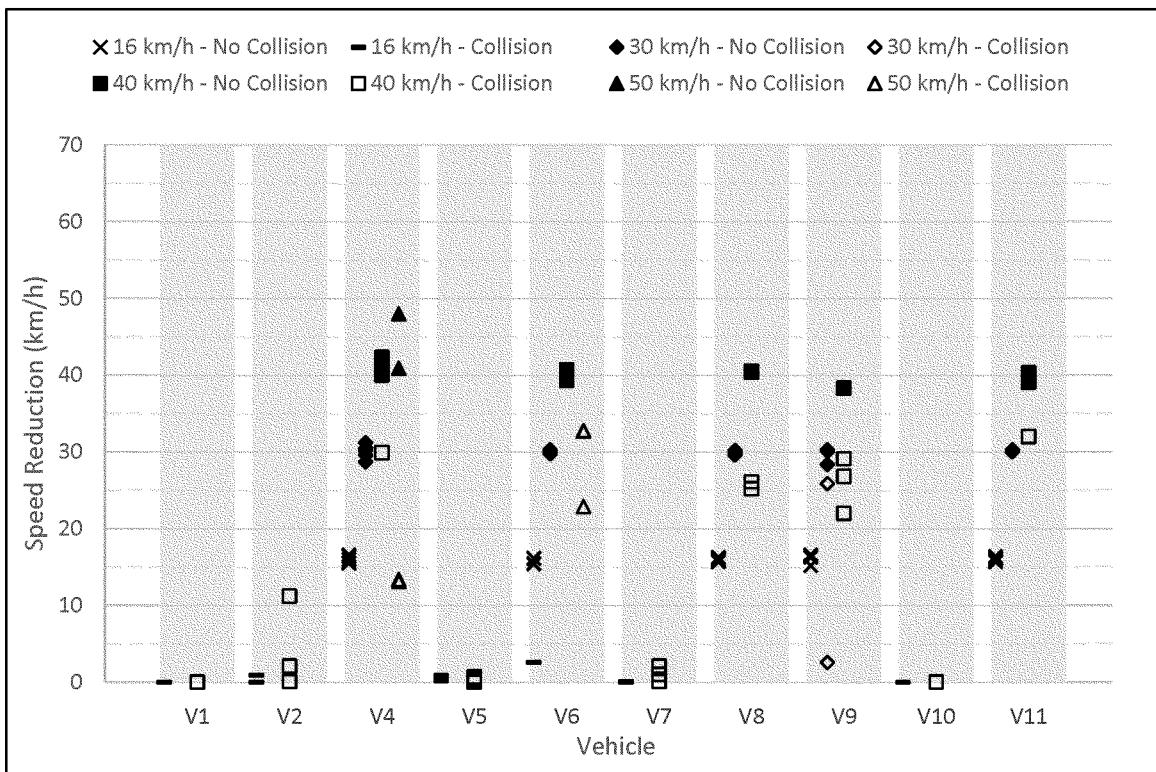

Testing for the obstructed running child (child pedestrian surrogate travelling at a speed of 5 km/h (3 mph)) scenario with a 50 percent overlap for the daylight condition found one

vehicle that avoided collision in all tests up to 50 km/h (31 mph) and in four out of five tests from 60 km/h (37 mph). Another vehicle avoided collision in all but one test up to 40 km/h (25 mph) and

had two tests without contact at 50 km/h (31 mph). Table 30 shows the ratio of no contact tests to total test by vehicle and tested speed.

Table 30: NHTSA R&D AEB ratio of no contact trials to total trials by vehicle and tested speed - running child obstructed from the right scenario, 50 percent overlap, daylight

Subject Vehicle Speed (km/h)	V1	V2	V4	V5	V6	V7	V8	V9	V10	V11
11	--	--	--	--	--	--	--	--	0/3	--
16	4/5	5/5	5/5	5/5	5/5	4/5	4/5	7/7	1/4	4/7
20	4/4	5/5	5/5	3/5	6/6	5/5	5/5	5/5	--	3/5
25	--	--	--	1/4	--	--	--	--	--	--
30	3/5	5/5	5/5	--	5/5	5/5	5/5	5/5	--	3/5
35	3/5	--	--	--	4/5	5/5	5/5	5/5	--	3/5
40	0/4	4/5	5/5	0/3	0/3	2/5	1/4	4/5	1/4	0/4
45	--	4/5	--	--	--	--	--	0/5	--	--
50	--	2/5	5/5	--	--	--	--	--	--	--
60	--	--	4/5	--	--	--	--	--	--	--

Only V4 was tested at 60 km/h (37 mph), and V4 avoided contact with the child mannequin in four out of five tests and achieved a speed reduction of more than 50 km/h (31 mph) in the test with contact. Of the two vehicles tested at 50 km/h (31 mph), V4 avoided collision in all cases. V2 avoided collision in two tests and achieved more than a 25 km/h (15.5 mph) speed reduction in two tests and a 19 km/h (12 mph) speed reduction in a third. Figure 17 shows

the speed reduction at the test speed for all vehicles tested. Based on the observed performance during testing, the agency has tentatively concluded that requiring performance at speeds up to 50 km/h (31 mph) is practicable in daylight conditions with an adequate phase-in. Concurrent with the development of this proposed rule, NHTSA performed PAEB testing on model year 2021 and 2022 vehicles using the proposed performance

requirements and test procedures. The results of that testing provide additional support to the tentative conclusion that the test conditions, parameters, and procedures are practical to conduct and that the proposed requirements are practical for manufacturers to achieve. The results of this testing are detailed in the PAEB report docketed with this proposed rule.

Figure 17: NHTSA R&D AEB speed reduction by vehicle and tested speed - running child obstructed from the right scenario, 50 percent overlap, daylight

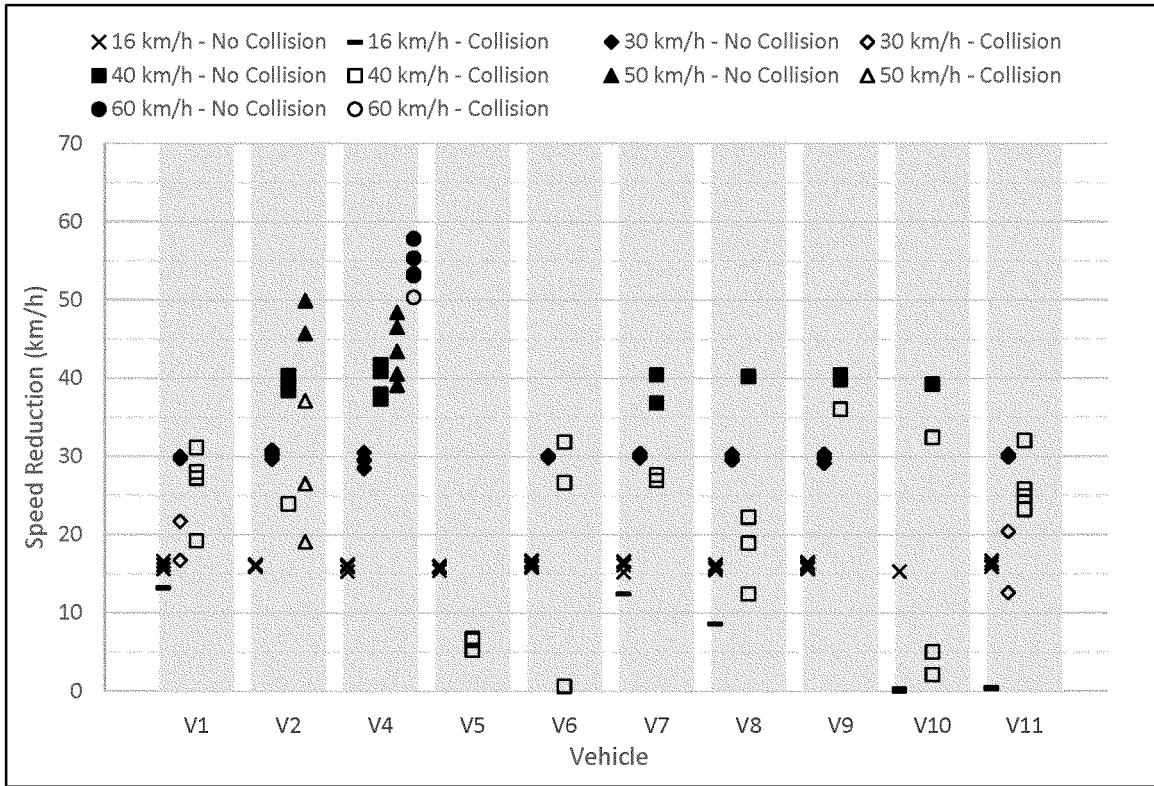

NHTSA’s testing of the running adult pedestrian scenario (pedestrian surrogate travelling at 8 km/h (5 mph)) from the left was performed at speeds from 40 km/h (25 mph) to 60 km/h (37 mph) with a 50 percent overlap during

daylight.¹⁹⁰ The results showed that five vehicles made no contact with the pedestrian surrogate in at least one test conducted at 60 km/h (37 mph) and all had no contact tests at 50 km/h (31 mph). One of the five vehicles, V2,

avoided contact with the test mannequin in all tests at 60 km/h (37 mph). A summary of the tests is shown in Table 31.

Table 31: NHTSA R&D AEB ratio of no contact trials to total trials by vehicle and tested speed - running adult pedestrian crossing path from the left scenario, 50 percent overlap, daylight

Subject Vehicle Speed (km/h)	V1	V2	V4	V5	V6	V7	V8	V9	V10	V11
35	--	--	--	0/3	--	--	--	--	--	5/5
40	5/5	5/5	5/5	0/3	6/6	5/5	4/5	3/6	4/5	2/6
45	--	--	--	--	--	--	5/5	1/4	0/5	--
50	5/5	7/7	5/5	--	5/5	5/5	2/5	--	0/3	--
55	--	--	5/5	--	--	5/7	--	--	--	--
60	5/6	5/5	1/3	--	4/5	4/6	--	--	--	--

¹⁹⁰ Only V5 and V11 were tested at 35 km/h (22 mph) due to poor performance at 40 km/h per the test matrix.

For the 60 km/h (37 mph) tests, the vehicles that did not avoid contact still exhibited significant speed reduction. In the one instance where V1 collided with the test mannequin, it still achieved a speed reduction of 42 km/h (26 mph). V4, V6 and V7 all achieved a speed reduction of more than 35 km/h (22 mph) in all instances with contact when

tested at 60 km/h (37.5 mph). In general, except for V5 and two tests (V9 at 40 km/h (25 mph) and V7 at 55 km/h (34 mph)) all vehicles achieved significant speed reduction over all tested speeds. Figure 18 shows the speed reduction at the test speed for all vehicles tested. The observed performance of five vehicles avoiding contact with an adult surrogate

running from the left in tests conducted at 60 km/h (37 mph) leads the agency to tentatively conclude that requiring performance at speeds up to 60 km/h (37 mph) is practicable in daylight conditions three years after the publication of a final rule.

Figure 18: NHTSA R&D AEB speed reduction by vehicle and tested speed - running adult pedestrian crossing path from the left scenario, 50 percent overlap, daylight

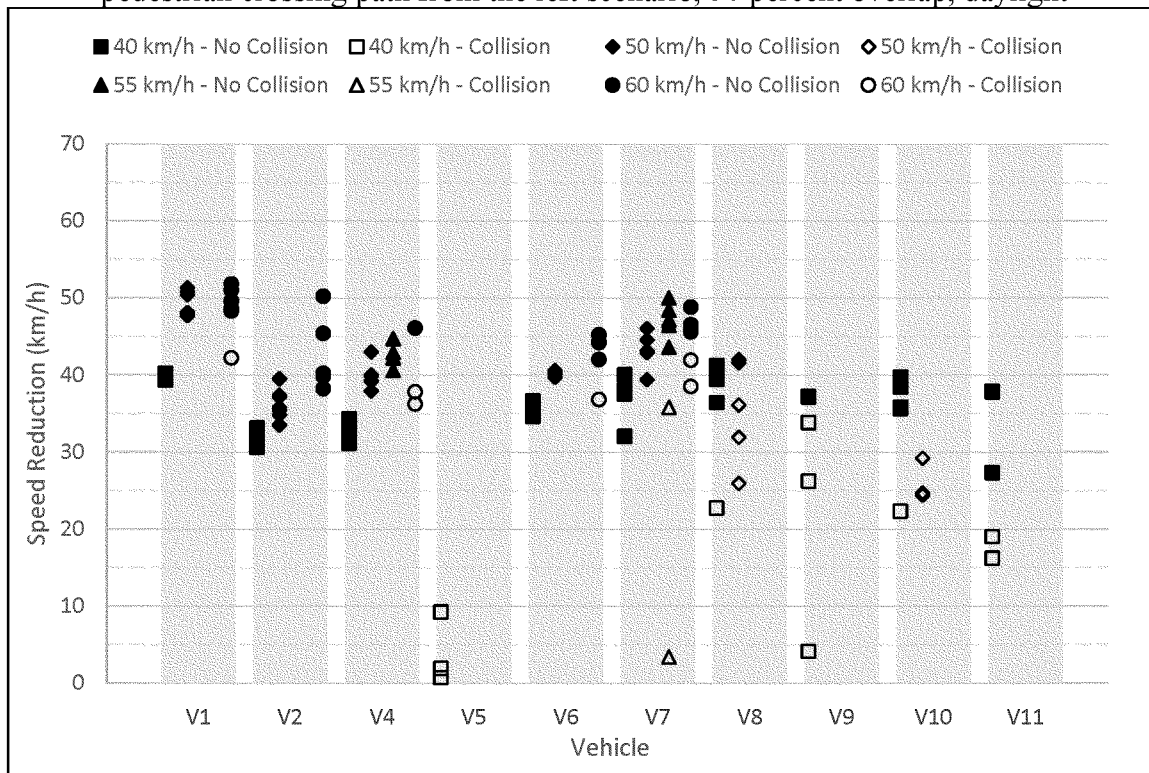

5. Stationary Scenario Testing Speeds

NHTSA is proposing a range of subject vehicle travel speeds from 10 km/h (6 mph) to 55 km/h (34 mph) for the stationary pedestrian along path scenario.

NHTSA’s 2020 research testing of this scenario during daylight conditions

found one vehicle, V1, that avoided collision with the test mannequin on all tests but one at 60 km/h (37.5 mph), and two other vehicles, V4 and V6, that avoided collision with the test mannequin when tested at speeds up to 55 km/h (34 mph). For all the tests up to 55 km/h (34 mph), V4 avoided

collision in all tests and V6 had only one collision at 55 km/h (34 mph). Four other vehicles had some no contact runs at 40 km/h (25 mph) and 9 of the 10 vehicles had no contact on all tests at 16 km/h (10 mph). Table 32 shows a brief overview of test results.

Table 32: NHTSA R&D AEB ratio of no contact trials to total trials by vehicle and tested speed - stationary adult pedestrian scenario, 25 percent overlap, daylight

Subject Vehicle Speed (km/h)	V1	V2	V4	V5	V6	V7	V8	V9	V10	V11
11	--	--	--	--	--	--	--	--	--	0/3
16	5/5	5/5	5/5	5/5	5/5	5/5	5/5	6/6	5/5	0/3
20	--	--	--	--	--	--	--	5/5	--	--
30	--	--	--	--	--	--	--	5/5	--	--
35	--	--	--	--	--	3/5	5/5	--	4/5	--
40	5/5	0/3	5/5	3/5	5/5	0/3	2/5	3/5	2/5	0/2
45	--	--	--	0/3	--	--	--	3/5	--	--
50	4/4	--	5/5	--	5/5	--	--	0/3	--	--
55	--	--	5/5	--	4/5	--	--	--	--	--
60	5/6	--	0/3	--	0/3	--	--	--	--	--

The three vehicles tested at 60 km/h (37 mph), vehicles V1, V4, and V6, had considerable speed reduction on the tests where they collided with the test mannequin. Where V1 collided with the test mannequin, it achieved a speed reduction of 37 km/h (23 mph). Where V6 collided with the test mannequin, it

showed very consistent results and had a speed reduction between 52 km/h (32 mph) and 55 km/h (34 mph) on all three tests at 60 km/h (37.5 mph). Similarly, V4 had a speed reduction when tested at 60 km/h (37.5 mph) of between 40 km/h (25 mph) and 45 km/h (28 mph). The consistent speed reduction results

at 60 km/h (37.5 mph) reinforce the agency's opinion that minimal tuning is required for existing systems to perform at the proposed requirements. Figure 19 shows the speed reduction at the test speed for all vehicles tested.

Figure 19: NHTSA R&D AEB speed reduction by vehicle and tested speed - stationary adult pedestrian scenario, 25 percent overlap, daylight

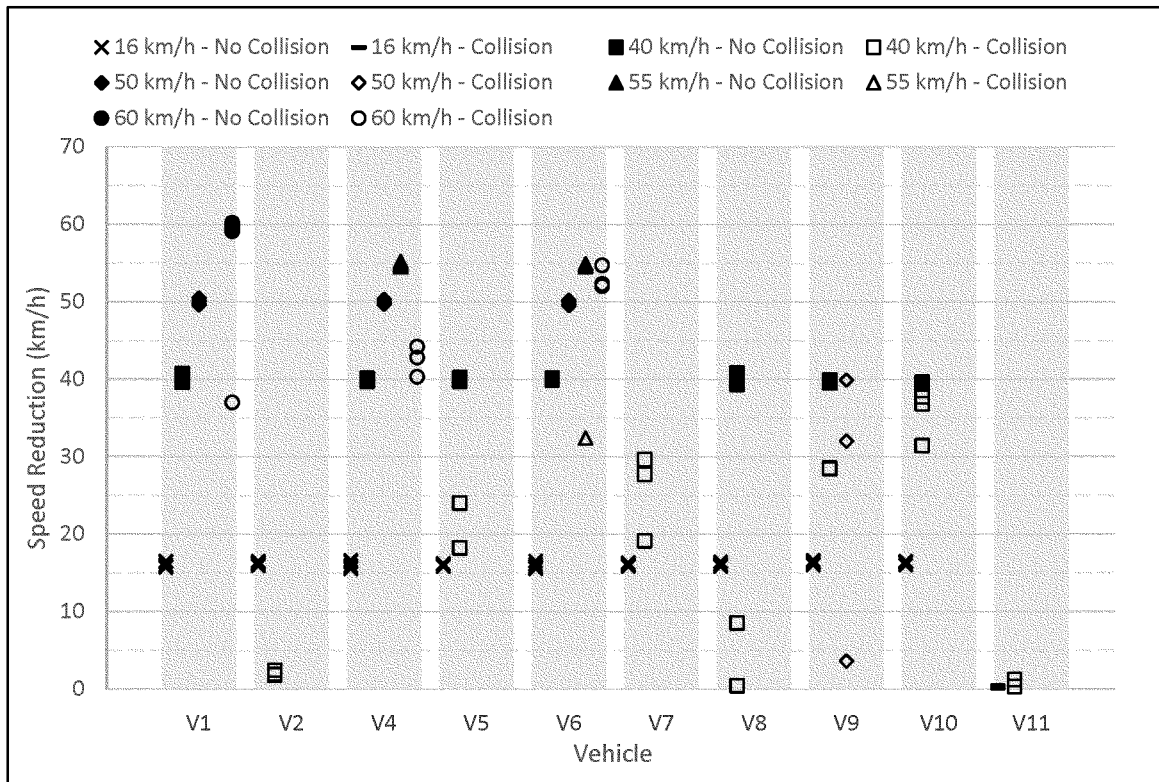

NHTSA upper beam testing using the stationary pedestrian along path scenario under dark lighting conditions resulted in one vehicle, V4, being able

to avoid collision in all tests at speeds up to and including 55 km/h (34 mph). The vehicle achieved an average speed reduction of 48 km/h (30 mph) in three

other tests conducted at 60 km/h (37 mph). Two other vehicles avoided collision in all tests at 40 km/h (25 mph) (See Table 33).

Table 33: NHTSA R&D AEB ratio of no contact trials to total trials by vehicle and tested speed - stationary adult pedestrian scenario, 25 percent overlap, dark upper beam

Subject Vehicle Speed (km/h)	V1	V2	V4	V5	V6	V7	V8	V9	V10	V11
11	--	5/5	--	--	--	0/3	--	--	--	--
16	3/5	0/3	5/5	5/5	5/5	0/3	5/5	5/5	4/5	2/5
35	--	0/3	--	--	1/4	--	3/5	0/3	0/3	--
40	0/3	2/5	5/5	5/5	2/5	0/3	0/2	0/3	0/3	5/5
45	--	--	--	1/4	--	--	--	--	--	--
50	--	--	5/5	--	--	--	--	--	--	3/5
55	--	--	5/5	--	--	--	--	--	--	0/3
60	--	--	0/3	--	--	--	--	--	--	0/2

When tested at 60 km/h, V4 and V11 collided with the test mannequin, but were still able to achieve significant speed reduction. V4 had very consistent speed reductions ranging from 46 km/h

(28.6 mph) to 52 km/h (32.3 mph), and V11 achieved a speed reduction of 29 km/h (18 mph) and 32 km/h (19.9 mph). When tested at 55 km/h (34 mph), V11 achieved a speed reduction of 25 km/h

(15.5 mph) or more in two tests and did not have a large speed reduction on the other test. At 50 km/h (31.1 mph), V11 achieved speed reductions of more than 30 km/h (18.6 mph) when it contacted

the test mannequin. The other vehicles, where they did not avoid contact at 40 km/h (25 mph), had a significant number of tests without large speed

reductions when they contacted the test mannequin. However, V9 at 40 km/h (25 mph) showed an average speed reduction of 23.5 km/h (14.6 mph) in

the tests where it contacted the test mannequin. Figure 20 shows the speed reduction at the test speed for all vehicles tested.

Figure 20: NHTSA R&D AEB speed reduction by vehicle and tested speed - stationary adult pedestrian scenario, 25 percent overlap, dark upper beam

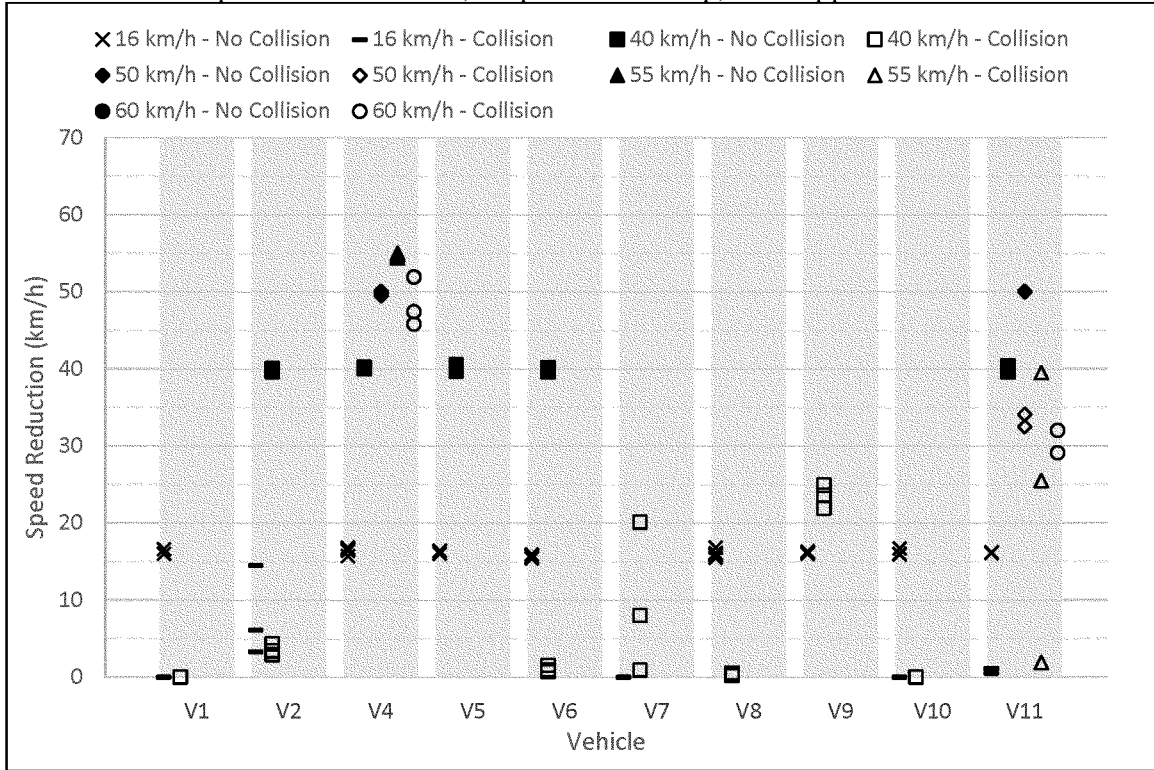

Based on the results of the testing, NHTSA has tentatively concluded that requiring testing up to 55 km/h (34.2 mph) is feasible give the three-year phase-in period after the publication of the final rule. At the speeds where some of the tested vehicles made contact, V4, with similar hardware, was able to avoid collision. The agency anticipates that the other vehicles will be able to avoid contact at the proposed testing speed ranges through tuning of their systems to the requirements. Concurrent with the development of this proposed rule, NHTSA performed PAEB testing

on model year 2021 and 2022 vehicles using the proposed performance requirements and test procedures. The results of that testing provide additional support to the tentative conclusion that the test conditions, parameters, and procedures are practical to conduct and that the proposed requirements are practical for manufacturers to achieve. The results of this testing are detailed in the PAEB report docketed with this proposed rule.

The same vehicle that avoided collision in all tests up to 55 km/h (34 mph) under dark conditions with upper

beams (V4) also avoided collision during all lower beam testing under dark conditions in tests up to and including those performed at 50 km/h (31 mph) and during four out of five tests at 55 km/h (34 mph). The other tested vehicles contacted the test mannequin at speeds on all or most tests when tested at speeds above 16 km/h (10 mph). A brief overview of the results for the dark lower beam testing for the stationary along path scenario is presented in Figure 21 and Table 34.

Table 34: NHTSA R&D AEB ratio of no contact trials to total trials by vehicle and tested speed - stationary adult pedestrian scenario, 25 percent overlap, dark lower beam

Subject Vehicle Speed (km/h)	V1	V2	V4	V5	V6	V7	V8	V9	V10	V11
11	--	--	--	--	--	0/3	--	--	0/3	0/3
16	0/3	5/5	5/5	4/5	3/5	0/3	5/5	5/5	0/3	0/3
35	--	0/3	--	0/3	0/3	--	0/3	0/3	--	--
40	0/3	0/3	5/5	0/3	0/3	0/3	0/1	2/5	0/2	0/1
50	--	--	5/5	--	--	--	--	--	--	--
55	--	--	4/5	--	--	--	--	--	--	--
60	--	--	0/3	--	--	--	--	--	--	--

V4 had significant and consistent speed reduction of between 45 km/h (28 mph) and 52 km/h (32 mph) when tested at 60 km/h (37 mph). V4 also reduced its speed by more than 30 km/h (19 mph) in the one instance it contacted the test mannequin when

tested at 55 km/h (34 mph). All other vehicles showed poor results at speeds above 16 km/h (10 mph). Three vehicles had no meaningful AEB activation on all tests, including 16 km/h (10 mph). V9 was the only vehicle that was able to avoid collision on two tests at 40 km/h

(25 mph) and had significant speed reduction on the other tests at this speed. Figure 21 shows the speed reduction at the test speed for all vehicles tested.

Figure 21: NHTSA R&D AEB speed reduction by vehicle and tested speed - stationary adult pedestrian scenario, 25 percent overlap, dark lower beam

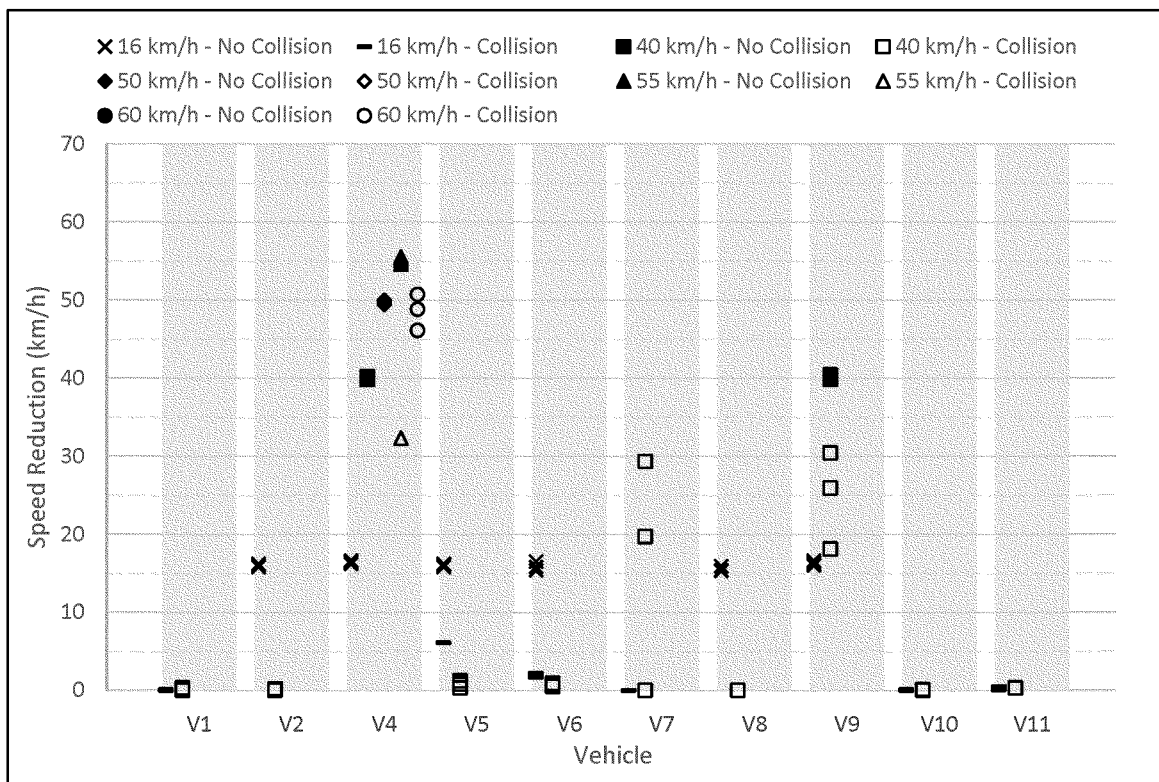

Given that V4, using commonly found hardware in AEB systems, was able to

avoid contact on every test up to 50 km/h (31.1 mph), avoided contact on most

tests at 55 km/h (34 mph), and achieved significantly reduced speed on all other

higher speed tests (including 65 km/h (60 mph)), the agency has tentatively concluded that a no contact requirement for speed ranges up to 55 km/h (34 mph) is feasible. The proposed 50 km/h (31 mph) upper bound of the range 3 years after final rule publication and 55 km/h (34 mph) 4 years after publication of the final rule is necessary due to pedestrian crashes and fatalities predominantly happening at night and at higher speeds (see safety section and PRIA). Concurrent with the development of this proposed rule, NHTSA performed PAEB testing on model year 2021 and 2022 vehicles using the proposed performance

requirements and test procedures. The results of that testing provide additional support to this tentative conclusion. The results of this testing are detailed in the PAEB report docketed with this proposed rule.

6. Along Path Scenario Testing Speeds

The proposed travel speed range for the pedestrian test mannequin moving (walking at 5 km/h (3 mph)) along the vehicle's path is from 10 km/h (6 mph) to 65 km/h (40 mph). NHTSA's 2020 PAEB research testing identified three vehicles that avoided contact with the test mannequin during all tests performed at 65 km/h (40 mph) (V1 was

only tested once at 65 km/h (40 mph) where it avoided collision with the test mannequin). Of these three vehicles, V6 avoided collision on all tests and tested speeds up to 65 km/h (40 mph), V1 avoided collision on all but one test up to 65 km/h (40 mph), and V9 avoided collision on all or most of the tests up to 65 km/h (40 mph) and avoided collision on 2 out of 5 tests at 70 km/h (44 mph). Another vehicle that performed well, V4, avoided collision on all tests up to 60 km/h (37.5 mph). Table 35 provides a breakdown of tests based on the collision avoidance outcome.

Table 35: NHTSA R&D AEB ratio of no contact trials to total trials by vehicle and tested speed - along path moving adult pedestrian scenario, 25 percent overlap, daylight

Subject Vehicle Speed (km/h)	V1	V2	V4	V5	V6	V7	V8	V9	V10	V11
11	--	--	--	--	--	--	--	--	--	1/4
16	5/5	4/5	5/5	5/5	5/5	0/3	5/5	5/6	5/5	0/3
35	--	--	--	2/5	--	--	5/5	--	--	--
40	3/3	0/3	5/5	0/2	5/5	5/5	0/3	5/5	4/5	0/3
45	--	--	--	--	--	--	--	--	5/6	--
50	6/7	--	5/5	--	5/5	5/5	--	5/5	1/4	--
55	--	--	--	--	--	2/5	--	--	--	--
60	5/5	--	5/5	--	5/5	0/3	--	4/6	--	--
65	1/1	--	0/3	--	5/5	--	--	5/5	--	--
70	--	--	0/3	--	0/3	--	--	2/5	--	--

V4 had a significant speed reduction of more than 40 km/h on all tests when tested at 65 km/h (40 mph). On the test at 50 km/h (31.1 mph), where V1 collided with the target, it still achieved

a speed reduction of more than 30 km/h (18.6 mph). Speed reduction for this scenario by relevant tested speeds is shown in Figure 22. Based on the results from the 2020 testing, NHTSA has

tentatively concluded that an upper speed bound of 65 km/h (40 mph) is practicable three years after the publication of the final rule.

Figure 22: NHTSA R&D AEB speed reduction by vehicle and tested speed - along path moving adult pedestrian scenario, 25 percent overlap, daylight

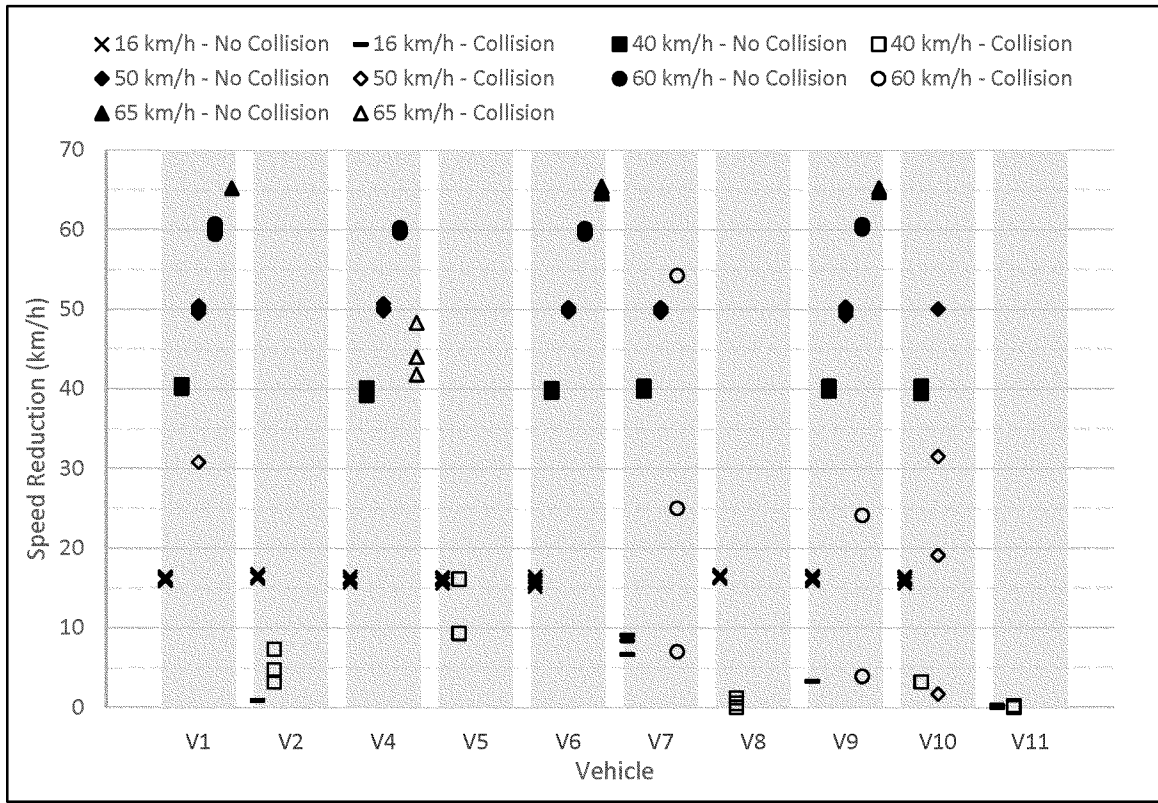

Testing for the dark upper beam along path pedestrian test mannequin moving scenario produced better performance than when testing for the dark upper beam stationary scenario. In the along path moving scenario, the test mannequin moves away from the subject vehicle at a constant speed and continues moving even as the subject vehicle decelerates during the AEB event. This has the potential to allow for

more time and distance to avoid collision. In the agency's research testing, one vehicle, V11, avoided collision on all tests at speeds up to 50 km/h (31.1 mph), had four out of five test runs at 55 km/h (34 mph) with no contact, and avoided collision once at 60 km/h (37 mph). V4 avoided collision on all tests up to 40 km/h (25 mph), collided once out of five tests at 50 km/h (31.1 mph), once out of five tests at

60 km/h (37 mph), and had one out of four no collision tests at 65 km/h (40 mph). Another vehicle, V9, avoided collision on all tests at 50 km/h (31.1 mph) and avoided collision on a majority of tests at the other tested speeds except at 65 km/h (40 mph). A total of five vehicles avoided collision on at least some of the tests at speeds up to 50 km/h (31.1 mph). Table 36 presents a summary of the test results.

Table 36: NHTSA R&D AEB ratio of no contact trials to total trials by vehicle and tested speed - along path moving adult pedestrian scenario, 25 percent overlap, dark upper beam

Subject Vehicle Speed (km/h)	V1	V2	V4	V5	V6	V7	V8	V9	V10	V11
11	--	1/4	--	--	--	0/3	--	--	--	--
16	0/3	2/5	5/5	4/5	5/5	1/4	4/5	3/6	1/4	5/5
35	--	--	--	3/5	--	--	--	--	--	--
40	0/4	6/7	5/5	2/5	3/5	0/3	3/5	4/5	5/5	6/6
45	--	5/5	--	--	2/5	--	1/4	--	1/4	--
50	--	2/5	4/5	--	0/4	--	--	5/5	1/4	5/5
55	--	--	--	--	--	--	--	--	--	4/5
60	--	--	4/5	--	--	--	--	3/5	--	1/4
65	--	--	1/4	--	--	--	--	0/3	--	--

Figure 23 shows the speed reduction achieved by each vehicle by tested speed. For example, when V11 contacted the test mannequin, it achieved significant speed reduction. Another vehicle achieving significant speed reduction in the tests where it contacted the test mannequin across all tested speeds was V4. This vehicle was the only one to avoid collision at 65 km/h (40 mph), and even though it only avoided collision in one test, it achieved

a speed reduction of more than 50 km/h (31.1 mph) in all others. The other vehicles did not provide consistent results during testing, with a wide range of speed reduction values. Because no vehicle was able to avoid collision on all tests at the higher speeds, the agency is proposing that the upper bound for the speed range for this scenario be 60 km/h (37 mph) three years after publication of the final rule and 65 km/h (40 mph) four years after publication

of the final rule. Concurrent with the development of this proposed rule, NHTSA performed PAEB testing on model year 2021 and 2022 vehicles using the proposed performance requirements and test procedures. The results of that testing provide additional support to this tentative conclusion. The results of this testing are detailed in the PAEB report docketed with this proposed rule.

Figure 23: NHTSA R&D AEB speed reduction by vehicle and tested speed - along path moving adult pedestrian scenario, 25 percent overlap, dark upper beam

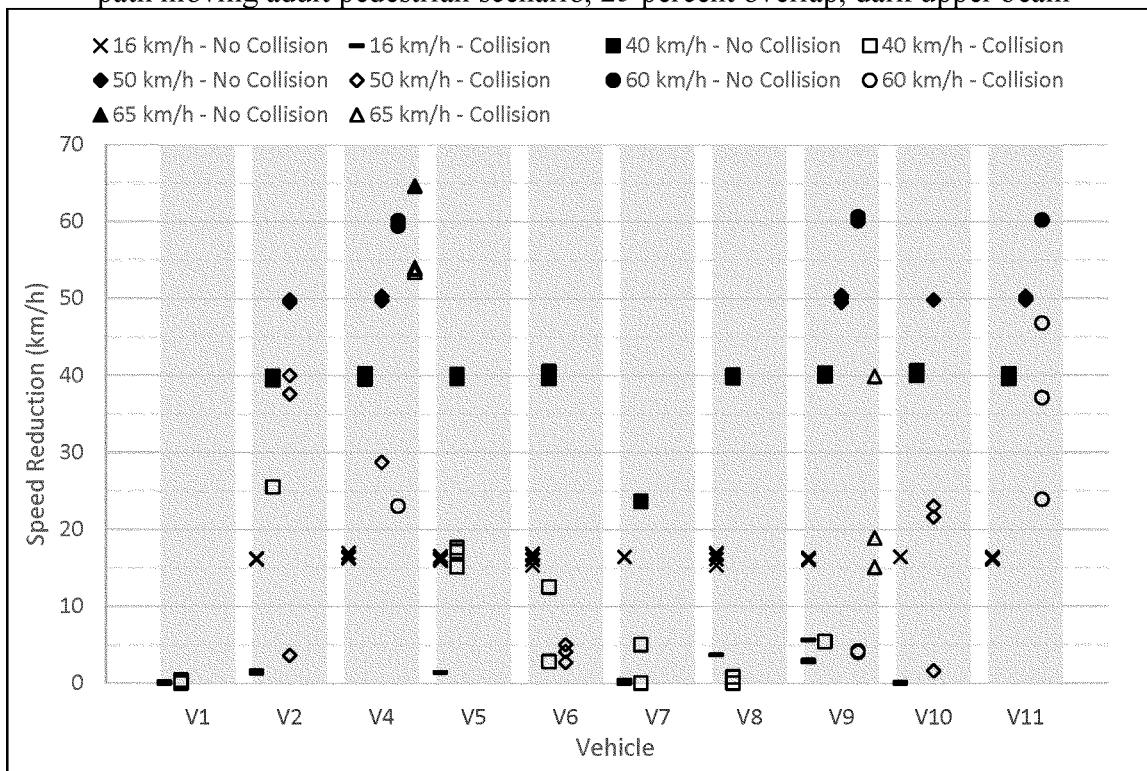

Similar to the stationary scenarios, the results from lower beam testing in dark lighting conditions for the along path moving test condition were less consistent than for the other lighting conditions. The tested vehicles were able to avoid contact with the test

mannequin at higher speeds than in the stationary along path scenario. Two vehicles were able to avoid contact with the test mannequin in at least one test during tests performed at 60 km/h (37 mph). One vehicle, V4, avoided contact with the test mannequin in all tests at

60 km/h (37 mph) and had two out of five no contact tests at 50 km/h (31.1 mph). The other vehicle, V9, had one no contact test out of four at 60 km/h (37.5 mph) and a majority of no contact tests at all lower tested speeds. The results of the tests are presented in Table 37.

Table 37: NHTSA R&D AEB ratio of no contact trials to total trials by vehicle and tested speed - along path moving adult pedestrian scenario, 25 percent overlap, dark lower beam

Subject Vehicle Speed (km/h)	V1	V2	V4	V5	V6	V7	V8	V9	V10	V11
11	--	0/4	--	0/3	--	--	--	--	0/4	--
16	0/3	1/4	5/5	0/3	5/5	5/7	5/5	3/5	0/3	4/4
35	--	0/3	--	--	1/4	0/3	2/5	--	--	0/3
40	0/3	0/4	4/5	0/3	0/3	0/3	0/3	4/5	0/3	0/3
50	--	--	2/5	--	--	--	--	3/5	--	--
60	--	--	5/5	--	--	--	--	1/4	--	--
65	--	--	0/3	--	--	--	--	--	--	--

For the along path moving scenario dark lower beam testing, V4 had significant speed reduction when tested at 65 km/h (40 mph) in two test runs but failed to activate in a meaningful manner in one test. When tested at 60 km/h (37 mph), V9 had two tests with

a speed reduction of at least 30 km/h (18.6 mph) and one test with no meaningful speed reduction. The results from the other tested speeds for V4 and V9 show that their AEB systems performed in a similar manner to their performance for the upper speeds

already discussed. In general, the other tested vehicles performed poorly at all speeds except 16 km/h (10 mph) and did not show consistent speed reduction. Figure 24 shows the speed reduction at the test speed for all vehicles tested.

Figure 24: NHTSA R&D AEB speed reduction by vehicle and tested speed - along path moving adult pedestrian scenario, 25 percent overlap, dark lower beam

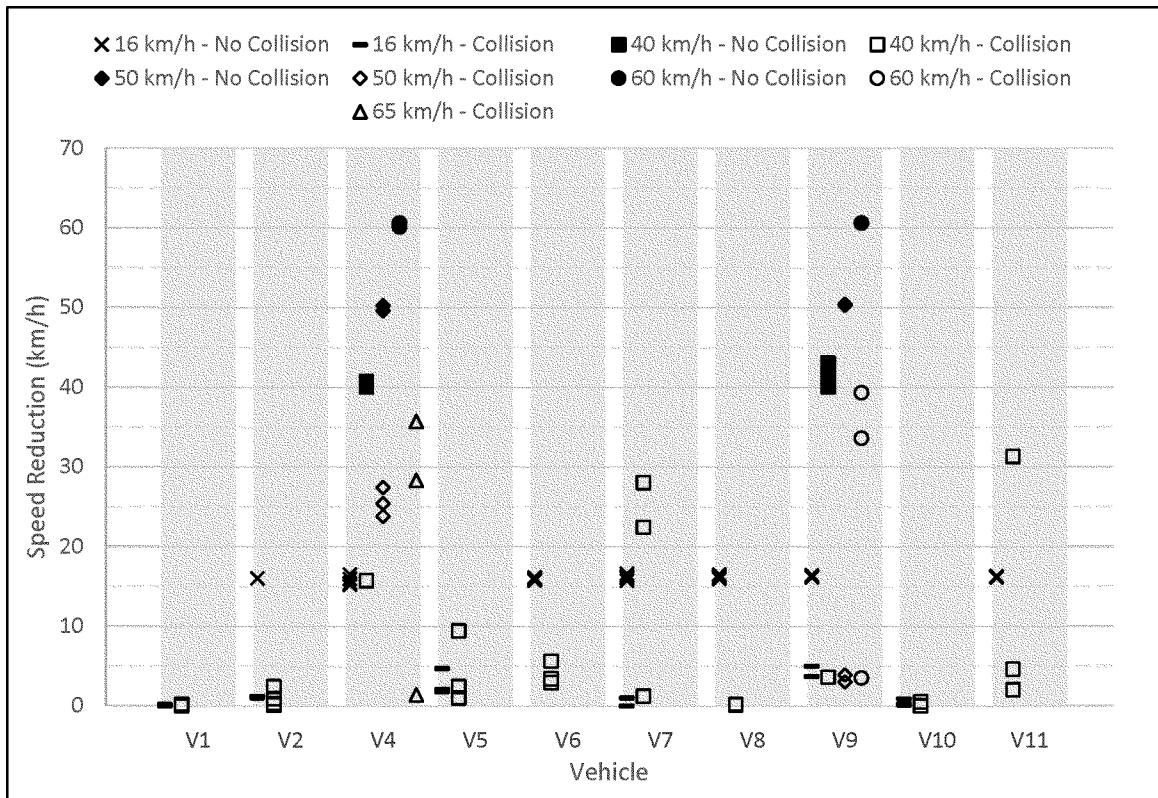

Two vehicles avoided contacting the surrogate in at least one test at 60 km/h (37 mph). NHTSA has tentatively concluded that this can be achieved across the fleet three years after the publication of a final rule. While no vehicle was able to avoid collision at a test speed of 65 km/h (40 mph), based on the fact that V4 and V9 (equipped with AEB systems with hardware in common) were able to avoid collision in at least one test at 60 km/h (37 mph), the agency tentatively concludes that four years after the publication of the final rule, vehicles will be able to achieve no contact at 65 km/h (40 mph). The need for testing at higher speeds in dark lighting conditions is dictated by the safety need, since as previously discussed, pedestrian fatalities predominantly occur during dark conditions and at higher speeds.

Concurrent with the development of this proposed rule, NHTSA performed PAEB testing on model year 2021 and 2022 vehicles using the proposed performance requirements and test procedures. The results of that testing provide additional support to this tentative conclusion. The results of this testing are detailed in the PAEB report docketed with this proposed rule.

7. PAEB Darkness Testing

During agency testing, PAEB system performance was not consistent for some of the proposed lighting conditions and speeds. However, the agency has tentatively concluded that testing in dark lighting conditions is necessary, and vehicles can be designed and produced to avoid collisions in all dark lighting test conditions given an adequate phase-in period. This is

consistent with recent IIHS tests finding that existing systems can perform in the dark-lighted conditions regardless of their IIHS headlamp ratings.^{191 192} NHTSA tentatively concludes that PAEB system performance is improving, and the latest PAEB systems are already able to perform much better under the proposed lighting conditions than previous iterations of the systems.¹⁹³ Concurrent with the development of this proposed rule, NHTSA performed PAEB testing on model year 2021 and 2022 vehicles using the proposed

¹⁹¹ IIHS dark light press release: <https://www.iihs.org/news/detail/pedestrian-crash-avoidance-systems-cut-crashes--but-not-in-the-dark>.
¹⁹² Id.
¹⁹³ “The better-performing systems are too new to be included in our study of real-world crashes . . . This may indicate that some manufacturers are already improving the darkness performance of their pedestrian AEB systems.” Id.

performance requirements and test procedures. The results of that testing provide additional support to the tentative conclusion that the test conditions, parameters, and procedures are practical to conduct and that the proposed requirements are practical for manufacturers to achieve. The results of this testing are detailed in the PAEB report docketed with this proposed rule. When tested, the observed crash avoidance performance of the tested PAEB systems was best for the daylight

and upper beam conditions. Table 38 shows the maximum speeds at which the test vehicles did not collide with the test mannequin either on all trials or at least one trial. Based on the previously detailed results of the 2020 testing, the agency tentatively concludes that three years after final rule publication, consistent performance is possible for the darkness testing conditions through further tuning of existing AEB systems without major hardware upgrades. The additional year of phase-in for higher

speed darkness performance requirements would allow time for systems that currently do not perform consistently to be adjusted or tuned to the proposed requirements. NHTSA has also concluded that the crossing path running child from the right scenario and the running adult from the left scenario with dark lower beam or upper beam are not a practicable requirement at this time.

TABLE 38—PAEB: HIGHEST SPEED AT WHICH A VEHICLE AVOIDED CONTACT ON AT LEAST ONE TRIAL VERSUS ALL TRIALS

Lighting condition	Crossing path—right, 50 percent overlap		Stationary		Along-path	
	At least one trial	All trials	At least one trial	All trials	At least one trial	All trials
Daylight	60 km/h	60 km/h	60 km/h	55 km/h	70 km/h	65 km/h.
Dark, Upper Beam	60 km/h	60 km/h	55 km/h	55 km/h	65 km/h	50 km/h.
Dark, Lower Beam	50 km/h	40 km/h	55 km/h	50 km/h	60 km/h	60 km/h.

G. Alternatives to No-Contact Performance Test Requirement

NHTSA is considering two alternatives to a no-contact requirement for both the lead vehicle and pedestrian performance test requirements.

The first alternative would be to permit low speed contact in NHTSA’s on-track testing. Under this alternative, the subject vehicle would meet the requirements of the standard if it applied the brakes automatically in a way that reduced the impact speed either by a defined amount or to a maximum collision speed. The speed at which the collision would be allowed to occur would be low enough that the crash would be highly unlikely to be fatal or to result in serious injury.

NHTSA seeks comment on the appropriateness of such a requirement, any factors to consider surrounding such a performance level, and what the appropriate reduction in speed or maximum impact speed should be. NHTSA has considered this alternative separately for the lead vehicle requirement and the pedestrian requirement and came to the same tentative conclusion to propose a no contact performance requirement for on-track testing in each case. However, NHTSA seeks comment on this level of performance separately for the lead vehicle and pedestrian requirements because the safety implications of low-speed impacts are different for each of these two crash types.

NHTSA also seeks comment on the potential consequences on testing if vehicle contact were allowed. NHTSA has extensive experience with

performing AEB evaluations and has observed that it is possible for even relatively low-speed collisions with the lead vehicle test device or pedestrian test mannequin to potentially damage the subject vehicle. For instance, if a test vehicle were to strike the lead vehicle test device, even at a low speed, sensors on the vehicle could become misaligned, and subsequent tests might not be representative of the vehicle condition at time of first sale. For instance, cameras or radar devices could become misaligned. Additionally, striking the vehicle test device or pedestrian test mannequin might prematurely degrade the appearance of the device and modify its specifications, including in ways that are not immediately observable. For example, damage to the test device might affect the radar cross section that requires a long verification procedure to discover. NHTSA is concerned that any performance test requirement that allows for vehicle contact could result in expensive or time-consuming interruptions to repair the subject vehicle or test device to ensure repeatable testing. NHTSA seeks comment on this concern.

The second alternative the agency is considering is a no contact requirement that permits the vehicle to use multiple runs to achieve the performance test requirements. For example, NHTSA’s CIB and DBS NCAP test performance criteria currently specify that the speed reduction requirements for each test scenario must be met in at least 5 out of 7 tests runs. This approach would provide a vehicle more opportunities to

achieve the required performance and the agency more statistical power in characterizing the performance of the vehicle. The agency seeks comment on the number of repeated tests for a given test condition and on potential procedures for repeated tests. The agency also seeks comment on the merits of permitting a vehicle that fails to activate its AEB system in a test to be permitted additional repeat tests, including a repeat test process similar to that in the recent revisions to UN ECE Regulation No. 151.¹⁹⁴ Finally, the agency seeks comment on whether there should be additional tests performed in the event no failure occurs on an initial test for each series.

In the request for comments on upgrades to NCAP, NHTSA sought comment on an approach that permitted repeated trials for collision avoidance requirements if an impact occurred with a minimum speed reduction of at least 50 percent.¹⁹⁵ This approach would not permit repeated trials if an impact occurred above certain speeds during the test series conducted for a given test scenario/condition. NHTSA seeks comment on the implications if NHTSA were to require a partial speed reduction, such as 50 percent, in

¹⁹⁴ Section 6.10.1 of UN ECE Regulation No. 151 provides robustness criteria that specifies that each test condition is performed two times. If vehicle does not meet the required performance criteria in one of the two test runs, a third test may be conducted. A test scenario is considered passed if the required performance is met in two test runs. However, the total number of failed test runs cannot exceed 10 percent for the lead vehicle and pedestrian tests.

¹⁹⁵ 87 FR 13452 March 9, 2022.

combination with an alternate approach for multiple trials. For example, if a collision occurs and the relative impact speed is less than 50 percent of the initial speed, the test is repeated. If a collision occurs again, the subject vehicle would be noncompliant. Alternatively, even if the subject vehicle avoids a collision, NHTSA could test again. The number of repeated tests needed to meet the performance test requirement would be established by NHTSA. If the agency were to consider such an approach, what should be the required speed reduction (e.g., 50 percent, 75 percent, etc.) and how many tests must follow without a collision?

H. False Activation Requirement

NHTSA is also proposing to include two scenarios in which braking is not warranted. These tests are sometimes referred to as “false-positive” tests. AEB systems need to be able to differentiate between a real threat and a non-threat to avoid false activations. NHTSA is concerned that false activation events may introduce hard braking situations when such actions are not warranted, potentially causing rear-end crashes. The proposed false activation tests establish only a baseline for system functionality. They are by no means comprehensive, nor sufficient to

eliminate susceptibility to false activations. Rather, the proposed tests are a means to establish minimum performance. NHTSA expects that vehicle manufacturers will design AEB systems to thoroughly address the potential for false activations.¹⁹⁶ Vehicles that have excessive false positive activations may pose an unreasonable risk to safety and may be considered to have a safety-related defect. Previous implementations of other technologies have shown that manufacturers have a strong incentive to mitigate false positives and are successful even in the absence of specific requirements.

The two proposed false activation scenarios are the steel trench plate and the vehicle pass-through test scenarios. Both of these tests will include acceleration pedal release and testing both with and without manual braking, similar to testing with a stopped lead vehicle. NHTSA is proposing that, during each test trial, the subject vehicle accelerator pedal will be released either when a forward collision warning is given or at a headway that corresponds to a time-to-collision of 2.1 seconds, whichever occurs earlier. For tests where manual braking occurs, the brake is applied at a headway that

corresponds to a time-to-collision of 1.1 seconds.

1. Steel Trench Plate False Activation Scenario

The steel trench plate test was introduced in the NHTSA NCAP test procedures to assess whether a false positive condition could be identified and consistently utilized.¹⁹⁷ In the steel trench plate test, a steel plate commonly used in road construction is placed on the surface of a test track. The steel plate presents no imminent danger, and the subject vehicle can safely travel over the plate without harm.

In the steel trench plate false activation scenario, a subject vehicle traveling at 80 km/h (50 mph) encounters a secured 2.4 m (7.9 ft) wide by 3.7 m (12.1 ft) long steel by 25 mm (1 in) thick ASTM A36 steel plate placed flat in the subject vehicle’s lane of travel, and centered in the travel path, with its short side toward the vehicle (long side transverse to the path of the vehicle). The AEB system must not engage the brakes to create a peak deceleration of more than 0.25g additional deceleration than any manual brake application generates (if used). The basic setup for the steel trench plate false positive test is shown in Figure 25.

Figure 25: Steel Trench Plate Test Scenario Basic Setup

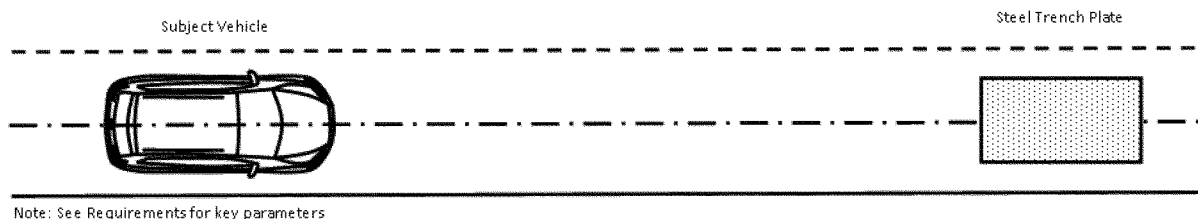

2. Pass-Through False Activation Scenario

The pass-through test, as the name suggests, simulates the subject vehicle encountering two vehicles outside of the subject vehicle’s path that do not present a threat to the subject vehicle. The test is similar to the UNECE R131 and UNECE R152 false reaction tests.¹⁹⁸ In the pass-through scenario, two VTDs

are positioned in the adjacent lanes to the left and right of the subject vehicle’s travel path, while the lane in which the subject vehicle is traveling is free of obstacles.

The two stopped VTDs are positioned parallel to each other and 4.5 m (14.8 ft) apart in the two adjacent lanes to that of the subject vehicle (one to the left and one to the right with a 4.5 m (14.8 ft) gap between them). The 4.5 m (14.8 ft)

gap represents a typical travel lane of about 3.6 m (11.8 ft) plus a reasonable distance at which a vehicle would be stationary within the adjacent travel lanes.¹⁹⁹ Similar to the steel trench plate false activation scenario, the AEB must not engage the brakes to create a peak deceleration of more than 0.25g beyond any manual braking. In Figure 26, a basic setup for the test is shown.

¹⁹⁶ From the NCAP request for comments notice “Specifically, the Alliance stated that vehicle manufacturers will optimize their systems to minimize false positive activations for consumer acceptance purposes, and thus such tests will not be necessary. Similarly, Honda stated that vehicle manufacturers must already account for false positives when considering marketability and HMI.” 87 FR 13452 (Mar. 9, 2022) at 13460.

¹⁹⁷ CIB Non-Threatening Driving Scenarios (DOT HS 811 795); NHTSA CIB—Crash Imminent Braking test procedure- <https://www.regulations.gov/document/NHTSA-2015-0006-0025>, <https://www.regulations.gov/document/NHTSA-2015-0006-0176>.

¹⁹⁸ U.N. Regulation No. 131 (Feb. 27, 2020), available at <https://unece.org/fileadmin/DAM/trans/main/wp29/wp29regs/2015/R131r1e.pdf>; U.N.

Regulation No. 152, E/ECE/TRANS/505/Rev.3/Add.151/Amend.1 (Nov. 4, 2020), available at <https://unece.org/fileadmin/DAM/trans/main/wp29/wp29regs/2020/R152am1e.pdf>.

¹⁹⁹ Federal Highway Administration (Oct. 15, 2014), Range of lane widths for travel lanes and ramps, https://safety.fhwa.dot.gov/geometric/pubs/mitigationstrategies/chapter3/3_lanewidth.cfm.

Figure 26: Pass-Through Test Scenario Basic Setup

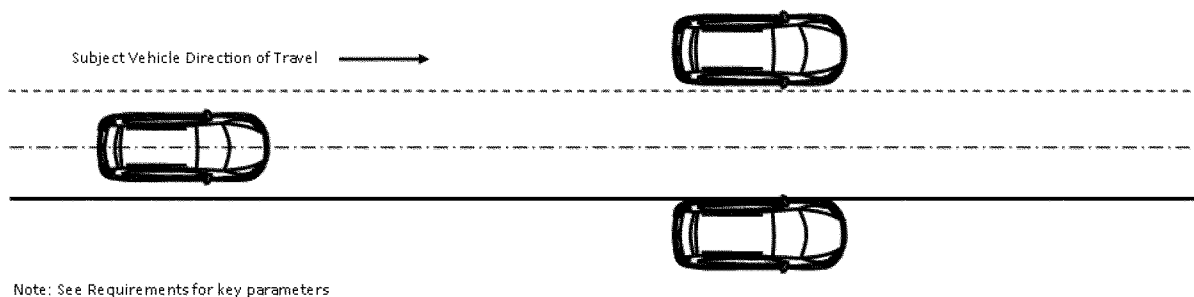

3. Potential Alternatives to False Activation Requirements

As alternatives to these two false activation tests, NHTSA is considering removing the false activation tests completely, requiring a robust documentation process or specifying a data storage requirement. First, NHTSA seeks comment on the anticipated impacts on safety and the certification burden if the agency were to finalize a rule that did not contain one or both of the proposed false positive tests. Alternatively, NHTSA is considering requiring that manufacturers maintain documentation demonstrating that robust process standards are followed specific to the consideration and suppression of false application of AEB in the real world. Other industries where safety-critical software-controlled equipment failures may be life-threatening (e.g., aviation²⁰⁰ and medical devices)²⁰¹ are regulated via process controls ensuring that good software development engineering practices are followed. This approach recognizes that system tests are limited in their ability to evaluate complex and constantly changing software-driven control systems. Software development lifecycle practices that include risk management, configuration management, and quality assurance processes are used in various safety-critical industries. ISO 26262, “Road vehicles—Functional safety,” ISO

21448, “Safety of the Intended Functionality (SOTIF),” and related standards, are examples of an approach for overseeing software development practices. Process standards could be a robust approach to the regulation of false positives because false activation of braking is a complex engineering problem with multiple factors and conditions that must be considered in the real world. The agency seeks public comment on all aspects of requiring manufacturers to document that they have followed process standards in the consideration of the real-world false activation performance of the AEB system.

Finally, NHTSA is considering requiring targeted data recording and storage of significant AEB activations. These data could then be used by manufacturers to improve system performance, or by the agency to review if a particular alleged false activation was part of a safety defect investigation. NHTSA is considering a requirement that an AEB event that results in a speed reduction of greater than 20 km/h (12 mph) activate the recording and storage of the following key information: date, time, engine hours (*i.e.*, the time as measured in hours and minutes during which an engine is operated), AEB activation speed, AEB exit speed (*i.e.*, vehicle speed at which the AEB is completely released), AEB exit reason (e.g., driver override with throttle or brake, or system decision), location, and camera image data. This information could be used by investigators to analyze the source of the activation and determine if there was a false activation. Such data would need to be accessible by the agency and potentially by the vehicle operator for a full and transparent analysis. The agency seeks comment on all aspects of this data collection approach as an alternative to false activation testing, including

whether this list of potential elements is incomplete, overinclusive, or impractical.

I. Malfunction Detection Requirement

NHTSA is proposing that AEB systems must continuously detect system malfunctions. If an AEB system detects a malfunction that prevents it from performing its required safety function, the vehicle would provide the vehicle operator with a warning. The warning would be required to remain active as long as the malfunction exists while the vehicle’s starting system is on. NHTSA would consider a malfunction to include any condition in which the AEB system fails to meet the proposed performance requirements. NHTSA is proposing that the driver must be warned in all instances of component or system failures, sensor obstructions, environmental limitations (like heavy precipitation), or other situations that would prevent a vehicle from meeting the proposed AEB performance requirements. While NHTSA is not proposing the specifics of the telltale, NHTSA anticipates that the characteristics of the alert will be documented in the vehicle owner’s manual and provide sufficient information to the vehicle operator to identify it as an AEB malfunction.

NHTSA is considering requirements pertaining to specific failures and including an accompanying test procedure. For instance, NHTSA could develop or use available tests that specify examples of how an AEB system might be placed in a malfunctioning state, such as disconnecting sensor wires, removing fuses, misaligning or covering sensors.

NHTSA is considering minimum requirements for the malfunction indication to standardize the means by which the malfunction is communicated to the vehicle operator. Malfunctions of

²⁰⁰ 14 CFR 33.201 (a) The engine must be designed using a design quality process acceptable to the FAA, that ensures the design features of the engine minimize the occurrence of failures, malfunctions, defects, and maintenance errors that could result in an IFSD, loss of thrust control, or other power loss.

²⁰¹ 21 CFR 820.30(a)(1) Each manufacturer of any class III or class II device, and the class I devices listed in paragraph (a)(2) of this section, shall establish and maintain procedures to control the design of the device in order to ensure that specified design requirements are met.

an AEB system are somewhat different than other malfunctions NHTSA has considered in the past. While some malfunctions may be similar to other malfunctions NHTSA has considered in FMVSSs because they require repair (loose wires, broken sensors, etc.), others are likely to resolve without any intervention, such as low visibility due to environmental conditions or blockages due to build-up of snow, ice, or loose debris.

NHTSA is considering requiring that the malfunction indicator convey the actions that a driver should take when an AEB malfunction is detected. NHTSA seeks comment on the potential advantages of specifying test procedures that would describe how the agency would test a malfunction indicator and on the level of detail that this regulation should require for a malfunction indicator. Additionally, NHTSA is considering requiring more details for the indicator itself, such as a standardized appearance (e.g., color, size, shape, illuminance). NHTSA seeks comment on the need and potential safety benefits of requiring a standardized appearance for the malfunction indicator and what standardized characteristics would achieve the best safety outcomes. NHTSA seeks comment on the use of an amber FCW warning indicator visual icon as the malfunction indicator.

NHTSA anticipates driving situations in which AEB activation may not increase safety and in some rare cases may increase risk. For instance, an AEB system in which sensors have been compromised because of misalignment, frayed wiring, or other partial failure, could provide the perception system with incomplete information that is then misinterpreted and causes a dangerous vehicle maneuver to result. In other instances, such as when a light vehicle is towing a trailer with no independent brakes, or brakes that do not include stability control functions, emergency braking may cause jack-knifing, or other dangerous outcomes. NHTSA is considering restricting the automatic deactivation of the AEB system generally and providing a list of situations in which the vehicle is permitted to automatically deactivate the AEB or otherwise restrict braking authority granted to the AEB system.

In addition to these, NHTSA is considering allowing the AEB system to be placed in a nonfunctioning mode whenever the vehicle is placed in 4-wheel drive low or when ESC is turned off, and whenever equipment such as a snowplow is attached to the vehicle that might interfere with the AEB system's sensors or perception system. The

malfunction indication requirements would apply in any such instance. NHTSA seeks comment on the permissibility of automatic deactivation of the AEB system and under which situations the regulation should explicitly permit automatic deactivation of the AEB system.

J. AEB System Disablement

This proposed rule would not permit manual AEB system disablement at any speed above the proposed 10 km/h (6 mph) minimum speed threshold above which the AEB system must operate. NHTSA seeks comment on whether manual deactivation for an AEB system should be allowed at speeds above 10 km/h (6 mph), similar to what is allowed for ESC systems in FMVSS No. 126.²⁰² NHTSA seeks comment on the appropriate performance requirements if the standard were to permit the installation of a manually operated deactivation switch. Such requirements might include limitations such that the default position of the switch be "AEB ON" with each cycle of the starting system, or the deactivation functionality could be limited to specific speeds.

K. AEB System Performance Information

This proposed rule has no requirements that the vehicle manufacturer provide information to vehicle operators about how the AEB system works. NHTSA is considering a requirement that manufacturers provide information describing the conditions under which the AEB system can avoid collisions, warning drivers that the AEB system is an emergency system and not designed for typical braking situations, and specifying the conditions under which the AEB system is not likely to prevent a collision. NHTSA seeks comment on the potential safety impacts of requiring such information be provided to vehicle operators and any costs associated with such an information requirement.

VII. AEB Test Procedures

To determine compliance with the proposed requirements, NHTSA proposes to test AEB systems on a test track using specified procedures and conditions. To establish the appropriate test procedures and conditions, the agency considered several factors, including the expected real-world conditions under which AEB systems need to operate to effectively reduce crash risk, the procedures and conditions that provide a high degree of test repeatability and reproducibility, the procedures and conditions needed

for safe testing, procedures and conditions that are within the practical operating range of AEB systems, the consistency between FMVSS and NCAP test procedures and conditions, and harmonization with test procedures and conditions in international AEB regulations and other test programs such as NCAP.

NHTSA's 2014 draft CIB and DBS research test procedures are the original basis for the proposed AEB-Lead Vehicle test procedures included in this NPRM.^{203 204} Similarly, NHTSA's 2019 draft research test procedure for PAEB systems is the original basis for the PAEB test procedures in this NPRM.²⁰⁵ Those documents reflect the agency's experience researching automatic braking systems at the NHTSA Vehicle Research and Test Center. They also are the main source of NHTSA's current NCAP test procedures for AEB-equipped vehicles.

To the extent possible, the proposed test conditions (such as environmental conditions, vehicle set-up, etc.) are the same in all tests unless otherwise specified. This provides for simplified, consistent test procedures and conditions.

A. AEB System Initialization

NHTSA is proposing that AEB systems will be initialized before each series of performance tests to ensure the AEB system is in a ready state for each test trial. The electronic components of an AEB system, including sensors and processing modules, may require a brief interval following each starting system cycle to reset to their default operating state. It also may be necessary for an AEB-equipped vehicle to be driven at a minimum speed for a period of time prior to testing so that the electronic systems can self-calibrate to a default or baseline condition, and/or for the AEB system to become active. The proposed initialization procedure specifies that, once the test vehicle starting system is cycled on, it will remain on for at least one minute and the vehicle is driven at a forward speed of at least 10 km/h (6 mph) before any performance trials

²⁰³ National Highway Traffic Safety Administration (2014, August), *Crash imminent brake system performance evaluation (working draft)*. Available at: <https://www.regulations.gov/document/NHTSA-2012-0057-0038>.

²⁰⁴ National Highway Traffic Safety Administration (2014, August), *Dynamic Brake Support Performance Evaluation (working draft)*. Available at: <https://www.regulations.gov/document/NHTSA-2012-0057-0038>.

²⁰⁵ National Highway Traffic Safety Administration (2019, April), *Pedestrian automatic emergency brake system confirmation test (working draft)*. Available at: <https://www.regulations.gov/document/NHTSA-2019-0102-0005>.

commence. This procedure also ensures that no additional driver actions are needed for the AEB system to be in a fully active state.

B. Travel Path

To maximize test repeatability, the travel path in each of the proposed test scenarios is straight rather than curved. A straight path simplifies vehicle motion and eliminates the more complex vehicle control needed for curve-following and which is likely to be less repeatable. NHTSA's draft research test procedures also specify straight-line vehicle tests, and other AEB test programs including NHTSA's NCAP employ a straight travel path.

The intended travel path is the target path for a given test scenario. For the proposed AEB tests as conducted by NHTSA for NCAP, the travel path has been programmed into a robotic steering controller, and a global positioning system (GPS) has been used to follow the intended path. The proposed text does not limit the method for steering the subject vehicle and as such any method including a human driver could be used by the agency during compliance testing. Regardless of the steering method, the positional tolerance would be maintained for a valid test. The travel path is identified by the projection onto the road surface of the frontmost point of the subject vehicle that is located on its longitudinal, vertical center plane. The subject vehicle's actual travel path is recorded and compared to the intended path. For test repeatability, the subject vehicle's actual travel path is measured during each test run and will not deviate more than a specified distance from the intended path.

NHTSA is proposing that the intended subject vehicle travel path be coincident with the center of a test lane whenever there are two edge lines marking a lane on the test track surface. If there is only one lane line (either a single or double line) marked on the test track, the vehicle path will be parallel to it and offset by 1.8 m (6 ft) to one side (measured from the inside edge of the line). Modern vehicles equipped with AEB often are equipped with other advanced driver assistance systems, such as lane-centering technology, which detects lane lines and which might be triggered if the travel path diverges substantially from the center of a marked test lane, potentially leading to unrepeatability results. These specifications reflect the agency's NCAP tests for AEB.^{206 207 208}

²⁰⁶ National Highway Traffic Safety Administration (2014, August), Crash imminent

C. Subject Vehicle Preparation

NHTSA is proposing that there be no specific limitations on how a subject vehicle may be driven prior to the start of a test trial. As long as the specified initialization procedure is executed, a subject vehicle may be driven under any conditions including any speed and direction, and on any road surface, for any elapsed time prior to reaching the point where a test trial begins. This is because the manner in which a subject vehicle is operated prior to a crash imminent situation should not compromise or otherwise affect the functionality of the AEB system. Also, ancillary subject vehicle operation on and around a test track will vary depending on exigencies of testing such as test lane location. For example, a subject vehicle may need to be driven across an unmarked section of pavement, be maneuvered using unspecified steering, braking, and accelerator inputs, and/or be driven in reverse in order to reach the start position for a test trial.

D. Subject Vehicle Tolerance Specifications

NHTSA is proposing that the subject vehicle speed would be maintained within a tolerance range of ± 1.6 km/h (± 1.0 mph) of the chosen test speed between the beginning of a test and the onset of the forward collision warning. For test repeatability, subject vehicle speed would be as consistent as possible from run to run. Subject vehicle speed determines the time-to-collision, which is a critical variable in AEB tests. In NHTSA's experience, subject vehicle speed can be reliably controlled within the ± 1.6 km/h (± 1.0 mph) tolerance range, and speed variation within that range yields consistent test results. A smaller speed tolerance is unnecessary for repeatability and burdensome as it may result in a higher test rejection rate without any greater assurance of accuracy of the AEB system's test track performance. This speed tolerance also is the same as that specified in the agency's NCAP tests for AEB systems.

NHTSA is proposing that, during each test trial, the subject vehicle accelerator

brake system performance evaluation (working draft). Available at: <https://www.regulations.gov/document/NHTSA-2012-0057-0038>.

²⁰⁷ National Highway Traffic Safety Administration (2014, August), Dynamic Brake Support Performance Evaluation (working draft). Available at: <https://www.regulations.gov/document/NHTSA-2012-0057-0038>.

²⁰⁸ National Highway Traffic Safety Administration (2013, February), Lane departure warning system confirmation test and lane keeping support performance documentation. See <https://www.regulations.gov>, Docket No. NHTSA-2006-26555-0135.

pedal will be released when a forward collision warning is given or when the AEB system first engages, whichever is sooner. Input to the accelerator pedal after AEB has engaged will potentially interfere with the system and may override the automatic braking. Therefore, it is necessary to fully release the subject vehicle's accelerator pedal. The proposed procedure states that the accelerator pedal is released at any rate and is fully released within 500 milliseconds. This ensures consistent release of the accelerator to eliminate any interference with AEB engagement and improve test repeatability. This procedure also better reflects real-world conditions because a driver's first reaction to a forward collision warning is likely to be accelerator release.²⁰⁹ This manner of accelerator pedal control is the same as specified in the agency's NCAP test procedures for AEB systems.

The accelerator pedal release can be omitted from tests of vehicles with cruise control actively engaged because there is no driver input to the accelerator pedal in that case. The AEB performance requirements in this proposal are the same for vehicles with and without cruise control engaged, and AEB systems must provide an equivalent level of crash avoidance or mitigation whether or not cruise control is active.

NHTSA is proposing that the subject vehicle yaw rate does not exceed ± 1.0 deg/s prior to onset of when the subject vehicle forward collision warning is given or the subject vehicle AEB system first engages, whichever is sooner. The agency proposes to adopt this tolerance for test repeatability. A ± 1.0 deg/s yaw rate tolerance, which is the most stringent value among the yaw rate limits specified in the agency's NCAP test procedures for AEB.

NHTSA is proposing that the travel path of the subject vehicle does not deviate more than 0.3 m (1.0 ft) laterally from the centerline of the lead vehicle. For consistent test conduct, it is necessary to maintain close alignment between the subject vehicle path and the lead vehicle path. Significant misalignment of the travel paths may change detection characteristics such as range and relative direction, potentially resulting in test-to-test inconsistency. Therefore, the agency proposes to use the tolerance requirement of 0.3 m (1.0 ft) for the subject vehicle's lateral position, which is more stringent than

²⁰⁹ Campbell, J.L., Brown, J.L., Graving, J.S., Richard, C.M., Lichty, M.G., Sanquist, T., . . . & Morgan, J.L. (2016, December). Human factors design guidance for driver-vehicle interfaces (Report No. DOT HS 812 360). Washington, DC: National Highway Traffic Safety Administration.

the lateral tolerance used in NHTSA's NCAP test procedures for AEB, but less stringent than the lateral tolerance specified in NHTSA's NCAP test procedures for PAEB. This tolerance is consistent with the SAE International recommended practice for AEB. In this proposal, the same lateral tolerance 0.3 m (1.0 ft) would be used for both lead vehicle AEB and PAEB.

E. Lead Vehicle Test Set Up and Tolerance

NHTSA is proposing that the speed of the lead vehicle would be maintained within a tolerance of ± 1.6 km/h (± 1.0 mph) during slower-moving tests and during decelerating lead vehicle tests until the lead vehicle initiates its deceleration. Like the subject vehicle speed, the speed of the lead vehicle (*i.e.*, the target vehicle) is a key parameter that directly influences TTC and other test outcomes. Results from a series of tests with run-to-run speed variations outside this tolerance range may be inconsistent. Therefore, for lead vehicle speed, the agency is proposing to use the same tolerance of ± 1.6 km/h (± 1.0 mph) specified for the subject vehicle speed, which also reflects the tolerance value used for NHTSA's NCAP AEB tests.

NHTSA is proposing that the lead vehicle would not diverge laterally more than 0.3 m (1.0 ft) from the intended travel path. This tolerance applies to both the slower-moving and decelerating lead vehicle test scenarios (for the stopped lead vehicle scenario, the lead vehicle is stationary and is centered on the projected subject vehicle travel path). If the lead vehicle's lateral position deviates significantly from the intended travel path, its alignment within the field of view of the forward sensors of the subject vehicle will be off-center, which can contribute to test series variability. The ± 0.3 m (± 1.0 ft.) tolerance for the lead vehicle's lateral position is the same tolerance specified for the subject vehicle's lateral position, which is consistent with the tolerance used in the SAE recommended practice for AEB testing.²¹⁰

Controlled lead vehicle deceleration is essential for repeatable decelerating lead vehicle AEB testing because the reaction of the subject vehicle depends largely on the position and motion of the lead vehicle. NHTSA is proposing that the lead vehicle will achieve the specified deceleration within 1.5 seconds of the onset of lead vehicle

braking. Over this time period, the overall deceleration will be lower than the target, but will rise over time, allowing for easier test completion. This lead-in time also makes it easier for the test to be performed while not making the test harder to pass. The lead vehicle will maintain this deceleration until 250 milliseconds prior to the vehicle coming to rest. Over these 250 milliseconds the vehicle dynamics do not reflect the overall dynamics of the test, and any acceleration data recorded is dismissed. This deceleration profile is consistent with NHTSA's NCAP test procedures and SAE's industry recommended practice for AEB systems.²¹¹

F. Test Completion Criteria for Lead Vehicle AEB Tests

For lead vehicle tests, NHTSA is proposing test-completion criteria to clearly establish the point at which a test trial has concluded. For all lead vehicle scenarios, each test run is considered complete immediately when the subject vehicle makes contact with the lead vehicle. In the case of stopped or decelerating lead vehicle tests, each test run also would be considered complete when the subject vehicle comes to a complete stop without impact. For slower-moving lead vehicle tests, the test is complete when the subject vehicle's speed is less than the lead vehicle speed. These test completion criteria are important in identifying a pass-fail outcome for AEB-equipped light vehicles. These criteria also are needed to limit consideration of vehicle motion or behavior after there is no longer a foreseeable collision with the lead vehicle.

G. PAEB Test Procedures and Tolerance

For PAEB testing, NHTSA proposes using the same general procedures described above, as applicable, including procedures for subject vehicle speed, yaw rate, travel path, lateral tolerance, subject vehicle accelerator pedal release.

Overlap refers to the test mannequin's potential impact point measured horizontally across the front end of the subject vehicle. It identifies the point on the subject vehicle that would contact a test mannequin that is within the subject vehicle travel path if the subject vehicle were to maintain its speed without braking. NHTSA proposes using an overlap value of either 50 percent, the midpoint of the subject vehicle's frontal surface, or 25 percent indicating the point that is one-quarter of the

subject vehicle width from the right side of the subject vehicle. NHTSA is proposing a 0.15 m (0.5 ft) overlap tolerance, which provides a high degree of test repeatability while also allowing a spacing tolerance for the pedestrian test mannequin position.

NHTSA is proposing different test scenarios in which the pedestrian test mannequin enters the path of the subject vehicle, including entering from the right side and left side of the subject vehicle's lane. For a pedestrian test mannequin initially positioned on the right side, NHTSA proposes an origination point that is 4.0 ± 0.1 m (13.1 ± 0.3 ft) from the subject vehicle's intended travel path. For a pedestrian test mannequin initially positioned on the left side, NHTSA proposes an origination point that is 6.0 ± 0.1 m (19.7 ± 0.3 ft) from the intended travel path. These initial pedestrian test mannequin positions are somewhat longer than those specified in NHTSA's 2019 draft test procedures for PAEB, which specify a right-side test mannequin offset of 3.5 m (11.5 ft) and left-side test mannequin offset of 5.5 m (18.0 ft).²¹² NHTSA is proposing the larger test mannequin offsets because the agency has found that the test mannequin sways and oscillates in an inconsistent manner when it is just starting to move, and the extra distance will provide time for it to stabilize before entering the subject vehicle's travel path. This, in turn, will enhance repeatability and accuracy of the test.

For test scenarios with a moving pedestrian test mannequin, NHTSA proposes to specify the maximum distance for the pedestrian test mannequin to reach its intended speed. NHTSA is proposing 1.5 m (4.9 ft) as the maximum distance which will be used for both crossing path test scenarios and along path test scenarios. Although it is generally desirable for the test mannequin to attain its final speed as quickly as possible to efficiently execute tests, the agency has found that acceleration that is too sudden often results in inconsistent, jerky test mannequin motions that may compromise repeatability. NHTSA therefore is proposing distances that are similar to the requirements in NHTSA's 2019 draft research test procedures for a PAEB system.

NHTSA is proposing that the simulated walking speed of the pedestrian test mannequin be maintained within 0.4 km/h (± 0.2 mph)

²¹⁰ SAE International (2017), *Automatic Emergency Braking (AEB) System Performance Testing* (SAE J3087).

²¹¹ SAE International (2017), *Automatic Emergency Braking (AEB) System Performance Testing* (SAE J3087).

²¹² National Highway Traffic Safety Administration (2019, April), *Pedestrian automatic emergency brake system confirmation test (working draft)*. Available at: <https://www.regulations.gov/document/NHTSA-2019-0102-0005>.

during PAEB tests. In NHTSA's 2020 PAEB research experience in conducting hundreds of tests, this amount of test mannequin speed tolerance is consistently achievable and provides a high level of run-to-run repeatability and consistent test results.

NHTSA is proposing clear test completion criteria to establish a point when a PAEB test may be considered fully concluded. In all PAEB test scenarios, a test is immediately complete if the subject vehicle makes contact with the pedestrian test mannequin. In test scenarios with the pedestrian test mannequin either crossing or stationary within the subject vehicle path, a test is complete when the subject vehicle comes to a complete stop without contacting the pedestrian test mannequin. In scenarios where the pedestrian mannequin moves along the forward path of the subject vehicle, the test is complete when the subject vehicle slows to below the pedestrian test mannequin speed. These test completion criteria are important for identifying a pass-fail outcome for PAEB-equipped light vehicles. These criteria also are needed to limit consideration of vehicle motion or behavior after there is no longer a risk of collision with a pedestrian test mannequin.

NHTSA is proposing that, when conducting PAEB tests with two VTDs, their left sides are aligned on the same plane, and they are positioned 1.0 ± 0.1 m (3.3 ± 0.3 ft) from the subject vehicle's right side when coincident with the intended travel path. The VTD positioning is consistent with NHTSA's 2019 draft research test procedures for PAEB systems for the scenario where an obscured child test mannequin runs into traffic from behind two parked vehicles. These test specifications are repeatable and provide for consistent test results.

H. False Positive AEB Test Procedures

For the steel trench plate test, the starting point, L_0 , is measured between the subject vehicle's front plane and the leading edge (closest to the subject vehicle) of the steel trench plate. For the pass-through scenario, the starting point is measured between the front plane of the subject vehicle and the vertical plane that contains the rearmost point of the vehicle test devices.

NHTSA is proposing criteria to clearly establish when a false-activation test trial may be considered fully concluded. For steel trench plate tests, a test trial is complete when the subject vehicle either comes to a stop or passes the leading edge of the steel trench plate. For the pass-through test, a test trial is complete when the subject vehicle

either comes to a stop or passes between the vehicle test devices. These criteria provide a definitive, observable pass-fail basis for false-activation test outcomes in each of the two scenarios.

I. Environmental Test Conditions

NHTSA proposes testing AEB systems in daylight and in darkness to ensure performance in a wide range of ambient light conditions.

For daylight testing, the proposed ambient illumination at the test site is not less than 2,000 lux.²¹³ This minimum level approximates a typical roadway light level on an overcast day.²¹⁴ The acceptable range also includes any higher illumination level including levels associated with bright sunlight on a clear day.

To ensure test repeatability, the agency further proposes that testing is not performed while the intended travel path is such that the heading angle of the vehicle is less than 25 degrees with respect to the sun²¹⁵ and while the solar elevation angle is less than 15 degrees. The intensity of low-angle sunlight aligned directly into the sensing element of a camera or other optical AEB sensor can saturate or "wash out" the sensor and lead to unrepeatable test results. Also, low-angle sunlight may create long shadows around a test vehicle, which could potentially compromise test repeatability.

For the proposed PAEB testing in darkness, the ambient illumination at the test site must be no greater than 0.2 lux. This value approximates roadway lighting in dark conditions without direct overhead lighting with moonlight and low levels of indirect light from other sources, such as reflected light from buildings and signage. An illumination level of 0.2 lux also is the same level specified in the test procedures for the recently issued final rule for adaptive driving beams.²¹⁶ This darkness level accounts for the effect ambient light has on AEB performance, particularly for camera-based systems. This ensures robust performance of all AEB systems, regardless of what types of sensors they may use.

NHTSA proposes that the ambient temperature in the test area be between

0 Celsius (32 °F) and 40 Celsius (104 °F) during AEB testing. This ambient temperature range matches the range specified in NHTSA's safety standard for brake system performance.²¹⁷ These temperatures represent a wide range of conditions that AEB-equipped vehicles will encounter. While AEB controls and sensors can operate at lower temperatures, the limiting factor in this case is the braking performance. The reduced surface friction possible in below-freezing temperatures may result in unrepeatable test conditions and may adversely affect subject vehicle braking performance.

NHTSA is proposing that the maximum wind speed during AEB compliance testing be no greater than 10 m/s (22 mph) for lead vehicle avoidance tests and 6.7 m/s (15 mph) for pedestrian avoidance tests. These are the same maximum wind speeds specified for AEB tests in the agency's AEB NCAP procedures and PAEB draft research test procedure.^{218 219} Excessive wind during testing could disturb the test devices in various ways. For example, high wind speeds could affect the ability of the VTD to maintain consistent speed and/or lateral position. The pedestrian mannequin could bend or sway unpredictably in excessively windy conditions. Test equipment that needs to remain stable also could be affected by wind. To ensure test repeatability, the agency has tentatively decided to adopt these wind speed specifications to minimize wind effects during testing.

NHTSA is proposing that AEB compliance tests not be conducted during periods of precipitation, including rain, snow, sleet, or hail. The presence of precipitation could influence the outcome of the tests. Wet, icy, or snow-covered pavement has lower friction, which may affect the outcome of the test. More importantly, in those conditions compared to dry conditions, it is more difficult to reproduce a friction level with good precision. Therefore, the agency is proposing to adopt the precipitation specification specified in the agency's NCAP test procedures for AEB systems.

NHTSA is proposing that AEB performance tests be conducted when visibility at the test site is unaffected by

²¹³ This illumination threshold is the same as that adopted in SAE J3087 "Automatic Emergency Braking (AEB) System Performance Testing."

²¹⁴ During an overcast day (no sun), when the solar altitude is around 6 degrees, the light intensity on a horizontal surface is around 2,000 lux. Illuminating Engineering Society of North America. 1979. "Recommended Practice of Daylighting."

²¹⁵ The horizontal angle between the sun and a vertical plane containing the centerline of the subject vehicle would be not less than 25 degrees for a valid test.

²¹⁶ 87 FR 9916.

²¹⁷ FMVSS No. 135—Light vehicle brake systems.

²¹⁸ National Highway Traffic Safety Administration (2014, August), *Crash imminent brake system performance evaluation (working draft)*. Available at: <https://www.regulations.gov/document/NHTSA-2012-0057-0038>.

²¹⁹ National Highway Traffic Safety Administration (2019, April), *Pedestrian automatic emergency brake system confirmation test (working draft)*. Available at: <https://www.regulations.gov/document/NHTSA-2019-0102-0005>.

fog, smoke, ash, or airborne particulate matter. AEB systems may use cameras to detect other vehicles and pedestrians. Reduced visibility due to the presence of fog or other substances is difficult to reproduce in a manner that produces repeatable test results. A current industry standard specifies that the horizontal visibility at ground level must be greater than 1 km (0.62 miles), and AEB test procedures in the European NCAP use that requirement.^{220 221} NHTSA believes a minimum visibility range is unnecessary to ensure test repeatability. Therefore, the agency is proposing a limitation on the presence of conditions that would obstruct visibility, including fog or smoke during AEB testing, but is not proposing a minimum visibility range. NHTSA seeks comment on whether to adopt a minimum level of visibility.

J. Test Track Conditions

NHTSA is proposing that the test track surface have a peak friction coefficient of 1.02 when measured using an ASTM F2493 standard reference test tire, in accordance with ASTM E1337–19 at a speed of 64.4 km/h (40 mph), without water delivery.²²² Surface friction is a critical factor in brake system performance testing, including AEB. The presence of moisture will significantly change the measured performance of a braking system. A dry surface is more consistent and provides for greater test repeatability. The proposed peak friction coefficient is the same value that NHTSA selected for an update of a NHTSA FMVSS related to surface friction for brake performance testing.²²³

NHTSA is proposing that the test surface have a consistent slope between 0 and 1 percent. The slope of a road surface can affect the performance of an AEB-equipped vehicle.²²⁴ It also influences the dynamics and layout involved in the proposed AEB test scenarios for both lead vehicle AEB and PAEB. Therefore, NHTSA proposes to limit the slope of the test surface by

²²⁰ SAE International (2017), *Automatic Emergency Braking (AEB) System Performance Testing* (SAE J3087).

²²¹ European New Car Assessment Program (Euro NCAP) (2019, July), *Test Protocol—AEB Car-to-Car systems, Version 3.0.2*.

²²² ASTM E1337–19, *Standard Test Method for Determining Longitudinal Peak Braking Coefficient (PBC) of Paved Surfaces Using Standard Reference Test Tire*.

²²³ 87 FR 34800 (June 8, 2022), Final rule, Standard Reference Test Tire.

²²⁴ Kim, H. et al., *Autonomous Emergency Braking Considering Road Slope and Friction Coefficient*, International Journal of Automotive Technology, 19, 1013–1022 (2018).

adopting the slope requirement specified for AEB tests in the agency's lead vehicle AEB NCAP procedures and PAEB draft research test procedure.^{225 226}

NHTSA proposes that the lead vehicle and pedestrian test mannequin be unobstructed from the subject vehicle's view during compliance tests except where specified. Furthermore, each compliance test would be conducted without any vehicles, obstructions, or stationary objects within one lane width of either side of the subject vehicle's path unless specified as part of the test procedure. This test condition is the same as that specified in the agency's research test procedures for AEB systems. The presence of unnecessary objects near the path of the subject vehicle could interfere with detection of a lead vehicle or test mannequin and have an unintentional effect on the field of view of the AEB system, which may compromise test repeatability.

K. Subject Vehicle Conditions

NHTSA is proposing that the subject vehicle be loaded with not more than 277 kg (611 lb.), which includes the sum of any vehicle occupants and any test equipment and instrumentation. The agency proposes this lightly loaded vehicle specification because the primary goal of the AEB testing is to measure the sensing and perception capability of a vehicle, which is relatively insensitive to the level of the vehicle load. In addition, braking tests with fully loaded vehicles are already required and conducted under exiting FMVSS, such as FMVSS No. 135, *Light Vehicle Brake Systems*, to measure the maximum brake capacity of a vehicle.

To maximize test repeatability, NHTSA is proposing that subject vehicle brakes be burnished prior to AEB performance testing according to the specifications of either S7.1 of FMVSS No. 135, which applies to passenger vehicles with GVWR of 3,500 kilograms or less, or according to the specifications of S7.4 of FMVSS No. 105, which applies to passenger vehicles with GVWR greater than 3,500 kilograms. AEB capability relies upon the function of the service brakes on a vehicle. Thus, it is reasonable and logical that the same pre-test conditioning procedures that apply to

²²⁵ National Highway Traffic Safety Administration (2014, August), *Crash imminent brake system performance evaluation (working draft)*. Available at: <https://www.regulations.gov/document/NHTSA-2012-0057-0038>.

²²⁶ National Highway Traffic Safety Administration (2019, April), *Pedestrian automatic emergency brake system confirmation test (working draft)*. Available at: <https://www.regulations.gov/document/NHTSA-2019-0102-0005>.

service brake performance evaluations should also apply to AEB system performance evaluations.

To maximize test repeatability, NHTSA is proposing that the subject vehicle service brakes be maintained at an average temperature between 65 °C (149 °F) and 100 °C (212 °F). The brake temperature is evaluated using either the front or rear brakes, depending on which has a higher temperature. This temperature range is the same as the range specified in NHTSA's safety standard for light vehicle brake systems²²⁷ and is important for consistent brake performance and test repeatability. Foundation brakes that are too cool or too hot may perform with less consistency, such that stopping distance may be unrepeatable. Hot or cold brakes also may fade or experience stiction or other effects that exacerbate inconsistent brake performance.

User adjustable settings, such as regenerative braking settings and FCW settings, would be tested in any setting state. Furthermore, adaptive and traditional cruise control may be used in any selectable setting during testing. The agency would test vehicles with any cruise control or adaptive cruise control setting to make sure that these systems do not disrupt the ability for the AEB system to stop the vehicle in crash imminent situations. However, for vehicles that have an ESC off switch, NHTSA will keep ESC engaged for the duration of the test.

VIII. Test Devices

A. Pedestrian Test Mannequins

NHTSA is proposing specifications for two pedestrian test devices to be used for compliance testing for the new PAEB requirements. These specifications would be referenced within the PAEB test procedures and NHTSA would use test devices meeting these specifications when it performs compliance testing. The two pedestrian test devices would each consist of a test mannequin and a motion apparatus (carrier system) that positions the test mannequin during a test. NHTSA is proposing specifications for a pedestrian test mannequin representing a 50th percentile adult male and a pedestrian test mannequin representing a 6- to 7-year-old child. NHTSA would use these pedestrian test mannequins to ensure that light vehicles are equipped with PAEB systems that detect pedestrians and automatically provide emergency braking to avoid pedestrian test mannequin contact in the tests specified in this proposal. NHTSA is proposing to

²²⁷ FMVSS No. 135—Light vehicle brake systems.

incorporate by reference specifications from three ISO standards.

1. Background

Since the introduction of PAEB, vehicle manufacturers and other entities have been engaged in testing and evaluating the technology. Because testing cannot be performed with live pedestrians, test mannequins have been developed to facilitate a safe and practical way to perform these evaluations objectively. However, to ensure the PAEB systems operate as intended, the test mannequins must be representative of pedestrians from the perspective of the vehicle sensors. That is, sensors used to detect the test mannequins must operate as if they were detecting actual pedestrians in the real world, which in turn allows the PAEB system to interpret and respond to the sensor data in a realistic manner. This representativeness ensures that PAEB system test results translate to real-world safety benefits.

There have been several efforts by different organizations to develop common specifications for PAEB testing, including an ISO Standard, ISO 19206–2:2018, “Road vehicles—Test devices for target vehicles, vulnerable road users and other objects, for assessment of active safety functions—Part 2: Requirements for pedestrian targets,” and an SAE Recommended Practice, SAE International Standard J3116, “Active Safety Pedestrian Test Mannequin Recommendation.” ISO 19206–4:2020, “Road vehicles—test devices for target vehicles, vulnerable road users and other objects, for assessment of active safety functions—Part 4: Requirements for bicyclists targets,” has color and infrared reflectivity specifications. Additionally, Euro NCAP specifies use of test mannequins that conform to the specifications in its “Articulated Pedestrian Target Specification Document,”²²⁸ which sets specifications for size, color, motion patterns, and detectability by vehicle sensors.

In November 2019, NHTSA published a **Federal Register** notice that sought comment on NHTSA’s draft research test procedure for PAEB testing (84 FR 64405). The draft test procedures provided methods and specifications for performing PAEB systems performance evaluations.²²⁹ During the development

of these test procedures, NHTSA used the 4activePS pedestrian static mannequin that was developed by 4Active Systems.²³⁰ The 4activePS pedestrian static mannequin was developed specifically for testing PAEB systems and conforms to the specifications in ISO 19206–2:2018. NHTSA continues to test with live mannequins developed by 4Active Systems. However, NHTSA has transitioned to performing tests using the 4activePA, which has articulated legs.

The change from using static mannequins to mannequins equipped with articulated, moving legs is in response to information that demonstrates that articulated mannequins may be more representative of actual pedestrians. In response to NHTSA’s 2015 NCAP request for comments notice, the agency received comments asking that NHTSA use articulated mannequins to test PAEB systems. The commenters reasoned that the articulated mannequins better represent actual pedestrians. In response to these comments, NHTSA proposed, in its 2022 NCAP RFC, the use of articulated mannequins.²³¹ In adopting this approach, NHTSA noted that using articulating mannequins would harmonize with other major consumer information-focused entities that use articulating mannequins, such as Euro NCAP and IIHS.²³²

For the test scenarios involving a moving pedestrian, NHTSA is proposing that the legs of the pedestrian test mannequin would articulate to emulate a walking motion.²³³ A test mannequin that has leg articulation when in motion more realistically represents an actual walking or running pedestrian. For test scenarios involving a stationary pedestrian, NHTSA is proposing that the legs of the pedestrian test

mannequin remain at rest (*i.e.*, emulate a standing posture).

In developing the specifications for the pedestrian test mannequins that will be used in NHTSA compliance testing, NHTSA first considered what characteristics these devices need to have. Not only does a test mannequin need to be able to facilitate accurate, repeatable, and reproducible tests when used for compliance testing, but it must also ensure that performance during the PAEB tests will be representative of performance in the real world. This means that a PAEB system should detect and classify the test mannequin similarly to real pedestrians.

It is NHTSA’s understanding that PAEB systems currently on the market may use a combination of camera and radar-based systems, and that Automated Driving Systems may also use lidar systems. NHTSA is proposing specifications for the pedestrian test mannequin based on these technologies. These specifications include those for visual characteristics, such as the color and physical dimensions. They also include specifications for infrared reflectivity, radar cross section, and articulation (the latter two affect how radar-based systems will perceive the pedestrian test mannequin radar signature).

Additionally, NHTSA has considered the need for the test mannequins to allow for safe and non-destructive testing. In the course of testing PAEB systems, the subject vehicle may impact the test mannequin. In the event contact is made, it is important that the test mannequin has characteristics that do not pose safety risks to those conducting the tests. From a practical standpoint, it is also important for test mannequins to be durable so they can be used repeatedly, yet strikable in a way that minimizes the risk of damage to the subject vehicle should contact be made with the test mannequin, even at a high relative velocity.

NHTSA’s proposed specifications incorporate by reference existing industry standards that represent the culmination of many years of coordination and research. NHTSA not only believes these specifications are sufficient to ensure that test results are objective and translate to real-world safety benefits, but also that there are currently available test mannequins that meet these specifications and possess characteristics that allow for safe and non-destructive testing.

2. Mannequin Appearance

The pedestrian test mannequin specification includes basic body proportions that, from any angle,

emergency brake system confirmation test (working draft). Available at: <https://www.regulations.gov/document/NHTSA-2019-0102-0005>.

²³⁰ *Id.* at 8, citing 4activeSystems GmbH. (n.a.). 4activePS pedestrian static (web page). Traboch, Austria: Author. Available at www.4activesystems.at/en/products/dummies/4activeps.html.

²³¹ 87 FR 13452, March 9, 2022, *supra*.

²³² *Id.*

²³³ The velocity of the articulated legs could be detected by an AEB system because some sensing technologies, such as radar, “may be able to measure and detect the relative velocities of moving legs.” Since the articulated legs of the current test mannequin move at a constant pace during a test, identifying proper leg velocities for a range of speeds would be needed in developing the next generation test mannequin. European Automobile Manufacturers’ Association (ACEA), February 2016, “Articulated Pedestrian Target Specification Document,” Version 1.0. <https://www.acea.auto/publication/articulated-pedestrian-target-acea-specifications/>.

²²⁸ European Automobile Manufacturers’ Association (ACEA), February 2016, “Articulated Pedestrian Target Specification Document,” Version 1.0, available at <https://www.acea.auto/publication/articulated-pedestrian-target-acea-specifications/>.

²²⁹ National Highway Traffic Safety Administration (2019, April), *Pedestrian automatic*

represent either a 50th percentile adult male or a 6 to 7-year-old child. The pedestrian test mannequins' specifications include a head, torso, two arms, and two articulating legs. The pedestrian test mannequin appears clothed in a black long-sleeved shirt and blue long pants. The black shirt and blue pants are selected to challenge a camera system, as the minimal contrast between the shirt and pants is challenging for a camera system to detect.

The physical dimensions of the pedestrian test mannequins are intended to be consistent with live pedestrians. NHTSA is proposing that the pedestrian test mannequins have the dimensions specified in ISO 19206–2:2018, which would be incorporated by reference into proposed 49 CFR part 561.

Evaluation of crash data indicates that the pedestrian injury and fatality safety problem is one that predominately affects adults, with adults aged 21 or older comprising 93 percent of all pedestrian fatalities.²³⁴ However, to address child pedestrian safety, NHTSA is proposing requirements for a scenario representing a child running into the street from an obstructed location, such as from behind a parked car. Children are among the most vulnerable road users, especially in the absence of adult supervision. Due to the small size of children, they can be obstructed from view until they are already in the travel path of a vehicle. This situation can be challenging for drivers and represents an area in which PAEB can also offer safety benefits.

Both the ISO Standard and SAE Recommended Practice J3116 set forth specifications for an adult and child test mannequin. The ISO Standard specifies a 50th percentile adult male test mannequin and a 6 to 7-year-old child test mannequin. The SAE recommendation specifies an adult test mannequin based on the average adult pedestrian involved in fatal pedestrian crashes, and a 6-year-old child test mannequin. The specific dimensions for the test mannequins differ slightly between the two recommended practices, but NHTSA has tentatively concluded that this difference is immaterial as it relates to this NPRM. As an example, one of the biggest differences in dimensions is the height of the adult test mannequin, where the ISO document specifies a height for the adult test mannequin of 1800 mm (70.9 in) with shoes and the SAE specifies a

height of 1715 mm (67.5 in) without shoes (the SAE recommended practice provides no recommendation for shoe height, or for a test mannequin with shoes).²³⁵ In considering the appropriate dimensions for the test mannequins used for AEB testing, NHTSA found most persuasive ISO 19206–2:2018, particularly due to the wide adoption of the specification and commercial availability of test mannequins based on the specification.²³⁶ Furthermore, NHTSA uses the test mannequins recommended in the ISO standard for all PAEB tests. NHTSA has no information on how a different recommendation for the test mannequin, such as the SAE recommended practice, would affect correlation between results and test repeatability. However, NHTSA requests comments on whether it would be more appropriate to use the SAE Recommended Practice specifications because they are more representative of the average pedestrian fatality.

For the remaining proposed PAEB scenarios, NHTSA is proposing to use only the adult test mannequin. For these scenarios, NHTSA is proposing specifications that are largely from ISO 19206–2:2018. However, for color and infrared reflectivity, including skin color, NHTSA is proposing specifications from ISO 19206–4:2020, “Road vehicles—test devices for target vehicles, vulnerable road users and other objects, for assessment of active safety functions—Part 4: Requirements for bicyclists targets.”

NHTSA believes that it is important for PAEB performance requirements to ensure real world safety benefits across a broad spectrum of real-world pedestrian crash scenarios. While NHTSA understands that, for practical reasons the performance requirements cannot address every pedestrian crash scenario, NHTSA also seeks to understand better whether the specifications for the adult test mannequin in the ISO standards are reasonably sufficient to address the crash risks for pedestrians of other sizes, such as small adult women. NHTSA seeks comment on whether use of the 50th percentile adult male test mannequin ensures PAEB systems would react to small adult females and other pedestrians other than mid-size adult males.

²³⁵ A mannequin wearing shoes is representative of a person crossing the road. If considering a 30 mm (1.2 in) height for shoes the differences in height between the two recommended practices is 55 mm (2.2 in).

²³⁶ NHTSA is not aware of any commercially available test mannequins conforming to SAE J3116.

NHTSA has considered whether a small adult female mannequin is necessary. However, NHTSA is unaware of any standards providing specifications for a 5th percentile adult female test mannequin, or of any consumer information programs testing with such a device. Instead, NHTSA seeks comment on whether the child test mannequin also should be specified for use in all PAEB scenarios. Such an approach could better ensure that PAEB systems are able to perceive and respond to a larger range of pedestrians in the real world than if only the 50th percentile adult male test mannequin was prescribed. However, as NHTSA has not performed testing with the child test mannequin in all of the test scenarios, the agency requests comment on whether such a requirement is feasible or appropriate.

In summary, NHTSA is proposing to incorporate by reference the dimensions and posture specifications found in ISO 19206–2:2018 for a test mannequin representing a 50th percentile adult male and a 6- to 7-year-old child. NHTSA considers these specifications to be an appropriate representation for the test mannequins. Specifically, NHTSA is proposing to incorporate by reference the complete set of dimensions for the adult and child test mannequins found in Annex A, Table A.1 of ISO 19206–2:2018. NHTSA is also proposing to incorporate by reference Figures A.1 and A.2, which illustrate reference dimensions for the adult and child test mannequins.

3. Color and Reflectivity

Specifications for test mannequin skin color are not found in ISO 19206–2:2018. Further, while the standard provides specifications for reflectivity, it does not include procedures for measuring it. For these reasons, NHTSA is proposing to incorporate by reference the bicyclist mannequin specifications for color and reflectivity found in ISO 19206–4:2018, “Road vehicles—test devices for target vehicles, vulnerable road users and other objects, for assessment of active safety functions—Part 4: Requirements for bicyclists targets.” Although this standard provides requirements for bicyclist test devices, NHTSA proposes to reference these specifications for color and reflectivity for the prescribed adult and child test mannequins because the specifications appear workable for use with the ISO Standard for pedestrian test devices. NHTSA is specifying that the test mannequins be of a color that matches a specified range of skin colors representative of very dark to very light complexions, with features that

²³⁴ <https://crashstats.nhtsa.dot.gov/Api/Public/ViewPublication/813079> Pedestrian Traffic Facts 2019 Data, May 2021.

represent hair, facial skin, hands, a long-sleeve black shirt, blue long pants, and black shoes.

NHTSA believes that the specifications in ISO 19206–4:2020 for color and infrared reflectivity for a bicyclist mannequin can be used for PAEB testing and should be incorporated by reference to fill in gaps in ISO 19206–2:2018 for those specifications. Not only would these specifications provide needed specifications for these features, but they also allow NHTSA to harmonize with specifications for test mannequins in use by Euro NCAP.

4. Radar Cross Section

Some PAEB systems use radar sensors to detect the presence of pedestrians. Accordingly, NHTSA is proposing that the pedestrian test mannequins have radar reflectivity characteristics that are representative of real pedestrians. Specifically, NHTSA is proposing that the radar cross section of the pedestrian test mannequin, when measured in accordance with procedures specified in ISO 19206–2:2018, Annex C, fall within the upper and lower boundaries shown in Annex B, Section B.3, Figure B.6.

5. Other Considerations

In addition to the characteristics specified in this proposal, NHTSA considered whether the test mannequins should have thermal characteristics. NHTSA believes there is a potential that thermal sensing technologies may be used in active safety systems in the future. While NHTSA does not want to dissuade manufacturers from developing or implementing such technology, the agency is not aware of any vehicle manufacturers currently using such technology for the detection of pedestrians as part of a PAEB system. NHTSA has also not conducted research on what specifications would be needed to ensure that a test mannequin has thermal characteristics that are representative of real-world pedestrians. Accordingly, NHTSA has not included thermal specifications for the pedestrian test mannequins in the draft regulatory text.

NHTSA also considered whether it was necessary to propose specifications for the motion of the pedestrian test mannequin carrier system. The carrier system is needed to control the speed (where applicable) and position of the pedestrian test device. Specifically, this equipment is needed to achieve the necessary closed-loop test scenario choreography between the subject vehicle and pedestrian test mannequin (e.g., lateral overlap relative to the front of the subject vehicle and desired

baseline contact points). ISO 19206–2:2018 provides recommended specifications in section 7. These specifications are designed to ensure that the carrier system is capable of positioning the pedestrian test mannequin relative to the target within the specific tolerances required by the different test procedures. Careful positioning is necessary because the relative position and speed of the subject vehicle and pedestrian test mannequin need to be consistent in order to achieve repeatable and reproducible test results.

However, ISO 19206–2:2018 also includes specifications intended to ensure that the carrier system minimally affects how the pedestrian test mannequin is perceived by the subject vehicle. Tentatively, NHTSA has concluded that including specifications for the pedestrian test mannequin carrier system itself is not necessary. This is primarily because no specific reflective or radar characteristics of the carrier system are needed to ensure objective and representative PAEB testing. Moreover, the characteristics of the carrier system should be irrelevant for conducting the test, as the carrier system ought not bear on the results of the test. To the extent that the carrier system is detected by a PAEB-equipped vehicle during compliance testing, NHTSA believes that such detection would not adversely affect the test result. Accordingly, NHTSA intends to use a carrier system for compliance testing that has minimal radar cross-section and minimal optical features based on test environment.

B. Vehicle Test Device

1. Description and Development

To ensure repeatable and reproducible testing that reflects how a subject vehicle would be expected to respond to an actual vehicle in the real world, this proposal includes broad specifications for a vehicle test device to be used as a lead vehicle, pass through vehicle, or obstructing vehicle during testing. NHTSA is proposing that the vehicle test device be based on certain specifications defined in ISO 19206–3:2021, “Road vehicles—Test devices for target vehicles, vulnerable road users and other objects, for assessment of active safety functions—Part 3: Requirements for passenger vehicle 3D targets.”²³⁷ The vehicle test device is a tool that NHTSA proposes to use to facilitate the agency’s compliance tests to measure the performance of AEB

²³⁷ <https://www.iso.org/standard/70133.html>. May 2021.

systems required by the proposed FMVSS. This NPRM describes the vehicle test device that NHTSA would use.

The surrogate vehicle NHTSA currently uses in its research testing is the Global Vehicle Target (GVT). The GVT is a full-sized harmonized surrogate vehicle developed to test crash avoidance systems while addressing the limitations of earlier generation surrogate vehicles. To obtain input from the public and from industry stakeholders, NHTSA participated in a series of five public workshops and three radar tuning meetings between August 2015 and December 2016. These workshops and meetings provided representatives from the automotive industry with an opportunity to inspect, measure, and assess the realism of prototype surrogates during the various stages of development. Workshop and meeting participants were permitted to take measurements and collect data with their own test equipment, which they could then use to provide specific recommendations about how the surrogate vehicle’s appearance, to any sensor, could be improved to increase realism.

After feedback from automotive vehicle manufacturers and suppliers was incorporated into an earlier design of the GVT, a series of high-resolution radar scans were performed by the Michigan Tech Research Institute (MTRI) under NHTSA contract. These measurements provided an independent assessment of how the radar characteristics of the GVT compared to those from four real passenger cars.²³⁸ This study found that the GVT has generally less radar scatter than the real vehicles to which it was compared. However, MTRI found that “even though the [GVT] may more often reflect a greater amount of energy than the [real] vehicles, it is not exceeding the maximum energy of the returns from the vehicles. Thus, a sensor intended for the purpose of detecting vehicles should perform well with the [GVT].”²³⁹

NHTSA also performed tests to determine the practicality of using the GVT for test-track performance evaluations by examining how difficult it was to reassemble the GVT after it was struck in a test. Using a randomized matrix designed to minimize the effect

²³⁸ The comparison passenger cars used were a 2008 Hyundai Accent, a 2004 Toyota Camry, a 2016 Ford Fiesta hatchback, and a 2013 Subaru Impreza.

²³⁹ Buller, W., Hart, B., Aden, S., and Wilson, B. (2017, May) “Comparison of RADAR Returns from Vehicles and Guided Soft Target (GST).” Michigan Technological University, Michigan Tech Research Institute. Docket NHTSA–2015–0002–0007 (www.regulations.gov).

of learning, these tests were performed with teams of three or five members familiar with the GVT reassembly process.²⁴⁰ NHTSA found that reassembly of the GVT on the robotic platform takes approximately 10 minutes to complete; however, additional time is often required to re-initialize the robotic platform GPS afterwards.²⁴¹

Finally, NHTSA conducted its own crash imminent braking tests to compare the speed reduction achieved by three passenger cars as they approached the GVT, compared to the Strikable Surrogate Vehicle (SSV), the surrogate vehicle NHTSA currently uses for its NCAP AEB tests. These tests found that any difference that might exist between the GVT and the SSV were small enough to not appreciably influence the outcome of vehicle testing.²⁴²

When used during lead vehicle AEB testing, the GVT is secured to the top of a low-profile robotic platform. The robotic platform is essentially flat and is movable and programmable. The vehicle test device's movement can be accurately and repeatably defined and choreographed with the subject vehicle and testing lane through the use of data from the robotic platform's on-board inertial measurement unit, GPS, and closed-loop control facilitated by communication with the subject vehicle's instrumentation. The shallow design of the robotic platform allows the tested vehicle to drive over it. The GVT is secured to the top of the robotic platform using hook-and-loop fastener attachment points, which allow the pieces of the GVT to easily and safely break away without significant harm to the vehicle being tested if struck.

The internal frame of the GVT is constructed primarily of vinyl-covered foam segments held together with hook-and-loop fasteners. The GVT's exterior is comprised of multiple vinyl "skin" sections designed to provide the dimensional, optical, and radar characteristics of a real vehicle that can be recognized as such by camera and radar sensors.²⁴³ If the subject vehicle impacts the GVT at low speed, the GVT is typically pushed off and away from the robotic platform without breaking apart. At higher impact speeds, the GVT breaks apart as the subject vehicle essentially drives through it.

2. Specifications

The most recent widely accepted iteration of vehicle test device specifications is contained in ISO 19206-3:2021. Using data collected by measuring the fixed-angle/variable-range radar cross section for several real vehicles, ISO developed generic "acceptability corridors," which are essentially boundaries that the vehicle test device's radar cross section must fit within to be deemed representative of a real vehicle.²⁴⁴ All vehicles that ISO tested have radar cross section measurements that fit within the boundaries set forth in the ISO standard.

This proposal would incorporate by reference ISO 19206-3:2021 into NHTSA's regulations and specify that the vehicle test device meets several specifications in ISO 19206-3:2021, in addition to other specifications identified by NHTSA. Because the GVT was considered during the development of ISO 19206-3:2021, the GVT would meet the standard's specifications. However, should the design of the GVT change or a new vehicle test device be developed, reference to the more general specifications of ISO 19206-3:2021 should ensure that NHTSA is able to test with such other vehicle test devices, and should also ensure that such vehicle test devices have properties needed by an AEB system to identify it as a motor vehicle.

The vehicle test device's physical dimensions are proposed to be consistent with those of the subcompact and compact car vehicle class. The specific range of dimensions in this proposal for individual surfaces of the vehicle test device are incorporated from ISO 19206-3:2021, Annex A, Table A.4. These include specifications for the test device's width and the placement of the license plate, lights, and reflectors relevant to the rear-end of the vehicle test device.

The vehicle test device is proposed to have features printed on its surface to represent features that are identifiable on the rear of a typical passenger vehicle, such as tail lamps, reflex reflectors, windows, and the rear license plate. The proposed color ranges for the various surface features, including tires, windows, and reflex reflectors, are incorporated from ISO 19206-3:2021, Annex B, Tables B.2 and B.3. Table B.2 specifies the colors of the tires, windows, and reflectors, which reflect the colors observed in the real world. The color of the exterior of the

vehicle is specified to be a range representing the color white, which provides a high color contrast to the other identifiable features. White is also a common color for motor vehicles.²⁴⁵ The proposed reflectivity ranges for the various features on the vehicle test device are incorporated from ISO 19206-3:2021, Annex B, Table B.1. Table B.3 specifies the recommended minimum, mean, and maximum color range for the white body, specifically the outer cover.

Because many AEB systems rely on radar sensors in some capacity to identify the presence of other vehicles, the vehicle test device must have a radar cross section that would be recognized as a real vehicle by an AEB system. In particular, the vehicle test device must have a radar cross section consistent with a real vehicle when approached from the rear over a range of distances.

NHTSA is proposing that the radar cross section of the vehicle test device fall within an "acceptability corridor" when measured using an automotive-grade radar sensor. This acceptability corridor would be defined by the upper and lower boundaries specified by ISO 19206-3:2021, Annex C, Equations C.1 and C.2, using the radar cross section boundary parameters defined in ISO 19206-3:2021, Annex C, Table C.3 for a fixed viewing angle of 180 degrees. NHTSA is aware that, unlike some predecessor specification documents, such as Euro NCAP Technical Bulletin 025 from May 2018, the ISO standard does not specify that the radar cross section measurements be verified using a specific model of radar. Rather, the ISO standard specifies that the radar sensor used have certain specifications and operational characteristics. NHTSA's proposal similarly does not specify that the vehicle test device's initial radar cross section be measured with a specific model or brand of radar. NHTSA only proposes that the radar sensor used to validate the radar cross section operate within the 76-81 GHz bandwidth, have a horizontal field of view of at least 10 degrees, a vertical field of view of at least 5 degrees, and a range greater than 100 m (328 ft). Additionally, NHTSA's proposal does not specify that the VTD's radar cross section during in-the-field verifications be performed to objectively assess whether the radar cross section still falls within the acceptability corridor. NHTSA seeks comment about whether

²⁴⁰ Snyder, Andrew C. et al., "A Test Track Comparison of the Global Vehicle Target (GVT) and NHTSA's Strikeable Surrogate Vehicle (SSV)," July 2019 <https://rosap.nhtl.bts.gov/view/dot/41936>.

²⁴¹ Id.

²⁴² Id.

²⁴³ Id.

²⁴⁴ The vehicles tested to develop the ISO standard are: 2016 BMW M235i, 2006 Acura RL, 2019 Tesla Model 3, 2017 Nissan Versa, 2018 Toyota Corolla, and 2019 Ford Fiesta.

²⁴⁵ Globally, white was the most popular color for light vehicles in 2021. <https://gmauthority.com/blog/2022/02/white-was-the-most-popular-car-color-again-in-2021/#:~:text=According%20to%20PPG%2C%2035%20percent,by%20silver%20at%2011%20percent.>

use of the optional field verification procedure provided in ISO 19206–3:2021, Annex E, section E.3 should be used.

Because the test procedures proposed in this rule only involve rear-end approaches by the subject vehicle, NHTSA is at this time only proposing to establish specifications applicable for the rear-end of the vehicle test device. NHTSA seeks comment on whether the specifications for the vehicle test device should include sides of the vehicle, as well as the rear-end. If NHTSA were to include, in a final rule, specifications for sides of a vehicle test device, NHTSA anticipates that those specifications would also be incorporated from ISO 19206–3:2021.

3. Alternatives Considered

One alternative test device that NHTSA considered for use in its lead vehicle AEB evaluations was the agency's self-developed Strikable Surrogate Vehicle device, which NHTSA currently uses in its NCAP testing of AEB performance. NHTSA adopted the use of the SSV as part of its 2015 NCAP upgrade, under which the agency began testing AEB performance.²⁴⁶ The SSV resembles the rear section of a 2011 Ford Fiesta hatchback. The SSV is constructed primarily from a rigid carbon fiber mesh, which allows it to maintain a consistent shape over time (unless damaged during testing). To maximize visual realism, the SSV shell is wrapped with a vinyl material that simulates paint on the body panels and rear bumper, and a tinted glass rear window. The SSV is also equipped with a simulated United States specification rear license plate. The taillights, rear bumper reflectors, and third brake light installed on the SSV are actual original equipment from a production vehicle. NHTSA testing shows that AEB systems will recognize the SSV and will respond in a way that is comparable to how they would to an actual vehicle.²⁴⁷

While the SSV and GVT are both recognized as real vehicles by AEB systems from the rear approach aspect, the SSV has several disadvantages compared to the GVT. The foremost disadvantage of the SSV is how easily it can be irreparably damaged when struck by a subject vehicle during testing, particularly at high relative velocities. While NHTSA has tried to address this issue by attaching a foam bumper to the rear of the SSV to reduce

the peak forces resulting from an impact by the subject vehicle, the SSV can still easily be damaged to a point where it can no longer be used if the relative impact speed is sufficiently high (*i.e.*, >40 km/h (25 mph), which is much lower than the maximum relative impact speed of 80 km/h (50 mph) potentially encountered during the AEB tests performed at the maximum relative speeds proposed in this notice). Also, unlike the GVT, which has its movement controlled by precise programming and closed loop control, the SSV moves along a visible monorail secured to the test surface, which may be visible to a camera-based AEB system.

In addition to the vehicle test device specifications, NHTSA seeks comment on specifying a set of real vehicles to be used as vehicle test devices in AEB testing. UN ECE Regulation No. 152 specifies that the lead vehicle be either a regular high-volume passenger sedan or a "soft target" meeting the specifications of ISO 19206–1:2018.²⁴⁸ UN ECE regulation does not require the use of real vehicles as targets, but rather offers them as an alternative to manufacturers to homologate their systems, at their choice. Although NHTSA has tentatively concluded that the specification in UN ECE Regulation No. 152 of any high-volume passenger sedan is not sufficiently specific for an FMVSS, NHTSA seeks comment on whether it should create a list of vehicles from which NHTSA could choose a lead vehicle for testing. Unlike the UN ECE regulation, which provides flexibility to manufacturers, inclusion of a list of vehicles would provide flexibility to the agency in the assessment of the performance of AEB systems. Such a list would be in addition to the vehicle test device proposed in this document, to provide assurance of vehicle performance with a wider array of lead vehicles. For example, the list could include the highest selling vehicle models in 2020.

Using actual vehicles has various challenges, including the potential for risk to individuals conducting the tests and damage to the vehicles involved, and assuring a safe testing environment that could encounter high energy collisions between real vehicles in cases of poor AEB system performance or AEB or test equipment malfunctions. NHTSA seeks comment on the utility and feasibility of test laboratories safely conducting AEB tests with real vehicles,

such as through removing humans from test vehicles and automating scenario execution, and how laboratories would adjust testing costs to factor in the risk of damaged vehicles.

Beyond the practical safety limits and cost of testing described above, managing a list of relevant lead vehicles would require the standard to be updated periodically to keep pace with the vehicle fleet and to ensure that lead vehicles are available years after a final rule. NHTSA seeks comments on the merits and potential need for testing using real vehicles, in addition to using a vehicle test device, as well as challenges, limitations, and incremental costs of such.

IX. Proposed Effective Date Schedule

NHTSA is proposing that, within four years after publication of a final rule, all requirements for AEB would be applicable. Most requirements would have to be met within three years of the date of publication of the final rule. Small-volume manufacturers, final-stage manufacturers, and alterers would be provided an additional year (added to those above) to meet the requirements of the final rule.

NHTSA anticipates that nearly all vehicles subject to this proposal would already have the hardware capable of meeting the proposed requirements by the effective date of a final rule. An AEB system requires sensing, perception, warning hardware, and electronically modulated braking subsystems. The perception subsystem is comprised of computer software that analyzes information provided by the sensors and computational hardware to process the code. NHTSA anticipates that manufacturers will need time to build code that analyzes the frontal view of the vehicle in a way that achieves the requirements of this proposed rule.

NHTSA has found that some manufacturers have already built systems that are capable of meeting some of the scenarios that are proposed. Therefore, for all lead vehicle AEB, PAEB daylight, PAEB darkness with upper beam headlamps, and most PAEB darkness with lower beam headlamps activated, NHTSA proposes a three-year lead time for manufacturers to build the needed software capabilities. NHTSA proposes a four-year lead time for the remaining higher speed PAEB scenarios. NHTSA expects manufacturers to create any new code needed to meet the second stage lead time requirements as well as to modify existing vehicle equipment such as headlamps to support the functionality of PAEB in darkness.

²⁴⁶ 80 FR 68604.

²⁴⁷ www.regulations.gov. NHTSA Docket Nos. NHTSA–2012–0057–0032, NHTSA–2012–0057–0034, and NHTSA–2012–0057–0039.

²⁴⁸ U.N. Regulation No. 152, E/ECE/TRANS/505/Rev.3/Add.151/Amend.1 (Nov. 4, 2020), available at <https://unece.org/fileadmin/DAM/trans/main/wp29/wp29regs/2020/R152am1e.pdf>.

NHTSA is concerned about the potential costs and practicability burdens imposed on manufacturers. Given that darkness pedestrian avoidance technology is new, the agency believes that more time should be afforded to manufacturers to refine PAEB systems to meet the crash avoidance requirements for the higher end of the speed range in darkness conditions, compared to lead vehicle avoidance or lower speed pedestrian avoidance. The agency is also aware that implementing new technology outside of the normal vehicle redesign cycle can increase costs of implementation.

With these considerations, NHTSA is proposing a split compliance schedule. For requirements other than those proposed for the darkness pedestrian avoidance requirements at higher speeds, NHTSA proposes an effective date of the first September 1st that is at

least three years from the date of publication of a final rule. The proposed schedule then requires full compliance for all vehicles manufactured on or after the first September 1st four years after publication of a final rule.

X. Summary of Estimated Effectiveness, Cost, and Benefits

NHTSA’s assessment of available safety data indicates that between 2016 and 2019, light vehicles averaged 1.12 million rear-impact crashes annually. These crashes resulted in an annual average of 394 fatalities, 142,611 non-fatal injuries, and an additional 1.69 million damaged vehicles. Additionally, between 2016 and 2019, an average of approximately 23 thousand crashes annually could potentially have been addressed by PAEB. These crashes resulted in an annual average of 2,642 pedestrian fatalities and 17,689 non-fatal injuries.

A. Target Population

The target population for the lead vehicle AEB analysis includes two-vehicle, rear-end light vehicle crashes and their resulting occupant fatalities and non-fatal injuries. FARS is used to obtain the target population for fatalities and CRSS is used to obtain the target population for property damage only crashes and occupant injuries. The target population includes two-vehicle light-vehicle to light-vehicle crashes in which the manner of collision is a rear-end crash and the first harmful event was a collision with a motor vehicle in transport. Further refinement includes limiting the analysis to crashes where the striking vehicle was traveling straight ahead prior to the collision at a speed less than 90 mph (145 km/h) and the struck vehicle was either stopped, moving, or decelerating.

TABLE 39—LIGHT VEHICLE TO LIGHT VEHICLE TARGET POPULATION

Light vehicle to light vehicle target population	Crashes	PDOs	Injuries						Fatalities
			MAIS1	MAIS2	MAIS3	MAIS4	MAIS5	MAIS 1–5	
All Conditions	1,119,470	1,692,678	130,736	9,364	1,942	256	57	142,611	394

The target population for the PAEB analysis considered only light vehicle crashes that included a single vehicle and pedestrian in which the first injury-causing event was contact with a pedestrian. The area of initial impact was limited to the front of the vehicle,

specified as clock points 11, 12, and 1, and the vehicle’s pre-event movement was traveling in a straight line. These crashes were then categorized as either the pedestrian crossing the vehicle path or along the vehicle path. The crashes are inclusive of all light, road surface,

and weather conditions to capture potential crashes, fatalities, and injuries in real world conditions. Data elements listed as “unknown” were proportionally allocated, as needed.

TABLE 40—TARGET POPULATION OF PEDESTRIAN FATALITIES AND NON-FATAL INJURIES

Light vehicle to pedestrian target population	Injuries						Fatalities
	MAIS 1	MAIS 2	MAIS 3	MAIS 4	MAIS 5	MAIS 1–5	
All Scenarios	13,894	3,335	1,541	300	75	19,511	2,508
Crossing Path	12,637	3,087	1,442	284	71	17,522	2,083
Along Path	1,257	248	98	16	4	1,622	425

B. Lead Vehicle AEB System Effectiveness

Lead vehicle AEB system effectiveness was determined based on the expected injury risk reduction applied to current crashes resulting in injuries or fatalities. The target population was split into three groups corresponding to the three lead vehicle test scenarios (lead vehicles stopped, moving, and decelerating). The crashes in these scenarios were further categorized into two sub-groups: Those in which the striking vehicle driver did not apply the brakes prior to impact and those where the striking vehicle driver

applied the brakes as an avoidance maneuver. The baseline for the system effectiveness analysis assumed that the striking vehicle in the control group is not equipped with FCW or any AEB functionality. For the treatment group, NHTSA predicted the crash outcomes if the striking vehicle were equipped with an AEB system meeting the proposed performance requirements.

For crashes where the striking vehicle’s operator did not apply the brakes, the initial event treatment section has two stages. The first stage covers when FCW activates, and the second stage covers how the driver reacts to the FCW warning. Depending

on whether the striking vehicle driver is predicted to react to the warning or not, the second stage models how the vehicle intervenes. If the striking vehicle driver reacts to the FCW and applies the brakes, the vehicle was modeled to provide supplemental braking. If the striking vehicle driver was predicted to not apply the brakes, the vehicle was modeled to apply the brakes automatically.

Similarly, for cases where the striking vehicle driver applied the brakes according to the crash database, the initial treatment section has two stages. The first stage models the driver’s reaction to FCW and the second stage

models supplemental braking (there are no conditions for which the driver is modeled not to apply the brakes in this situation because NHTSA does not anticipate that an FCW will decrease the probability of a driver applying the brakes). For cases where the driver applied the brakes, it was assumed that, in response to a forward collision warning, the driver would apply the brakes sooner compared to the crash database and that the resulting deceleration would be greater as a result of supplemental braking.

Although NHTSA evaluated the crash data assuming the striking vehicles were not equipped with any AEB functionality, NHTSA does anticipate that lead vehicle AEB systems will have substantial voluntary market penetration, though at lower performance level than the proposed requirements in this NPRM. Therefore, the baseline (what the world would look like in the absence of the proposed regulation) takes into account voluntary installation of AEB. The baseline is incorporated by evaluating injury risk based on the expected difference in vehicle performance between a baseline vehicle and a vehicle meeting the proposed requirements. System effectiveness is estimated based on the calculated difference of the vehicle

striking speed between the baseline and proposed rule and the difference in injury risk for each group and sub-group described above.

C. PAEB System Effectiveness

To estimate PAEB system effectiveness, the target populations for along path and crossing path were further grouped by vehicle travel speed.

NHTSA assumes that a PAEB system meeting the proposed requirements would recognize a pedestrian standing or moving along the same longitudinal path as the vehicle and be able to identify the speed differential between the two. NHTSA also estimates that the PAEB system’s capabilities include reaching a stop 55 centimeters in front of the pedestrian. Thus, in the absence of external mitigating factors (the impacts of these factors are included later in the analyses), NHTSA estimates that PAEB would prevent all fatalities along path scenarios when activated within the operational speed range up to 45 mph (73 km/h).

For pedestrian crossing path crashes, NHTSA first estimated the distribution of collision by the location along the front of the vehicle at which the pedestrians were struck. This step establishes the time in which the pedestrian is within the path of the vehicle for a crossing path situation.

This timing is important for NHTSA to model the PAEB system’s ability to avoid or mitigate the crash (very short times do not provide much time for the PAEB system to react and thus the reduction in speed before the impact is low). After this, the effectiveness of a PAEB system that meets the proposed requirements is established for each travel speed.

To account for external physical factors impeding PAEB-braking system effectiveness, NHTSA adjusted the estimated fatalities prevented and non-fatal injuries that would be mitigated by PAEB downward by 10 percent. This assumption represents limitations associated with factors such as tire traction and pedestrian visibility due to inclement weather, contaminants on the roadway, changes in vehicle balance affecting traction, and poor tire and road maintenance.

D. Fatalities Avoided and Injuries Mitigated

Table 41 presents the safety benefits associated with the proposed rule. As a result of the proposed rule, NHTSA estimates that a total of 362 fatalities would be prevented, and 24,321 non-fatal (MAIS 1–5) injuries would be mitigated over the course of one vehicle model year’s lifetime.

TABLE 41—SUMMARY OF SAFETY BENEFITS: FATALITIES PREVENTED AND NON-FATAL INJURIES MITIGATED

Category	Lead vehicle AEB	PAEB	Total
Non-fatal Injuries (MAIS 1–5)	21,649	2,672	24,321
Fatalities	124	238	362

The agency considers these estimates to be conservative because some benefits of the proposed rule may not be quantified. The target population does not include multiple-vehicle rear-end crashes. AEB is also likely to be effective at reducing some rear-end crashes where the struck vehicle is something other than a light vehicle, such as a heavy vehicle or motorcycle.

Additionally, these estimates are influenced by voluntary adoption of AEB. If voluntary performance levels are lower than the agency estimates, the benefits of the rule will be higher than estimated.

E. Costs

The analysis makes use of annual sales data between calendar year 2011–

2020 to estimate the number of vehicles subject to the proposed rule. Table 42 presents the annual sales of new light vehicles for 2011 through 2020. Over the ten-year period, an average of 15.7 million light vehicles were sold annually, of which approximately 40 percent were cars and 60 percent were light trucks.

TABLE 42—ANNUAL SALES OF NEW LIGHT VEHICLES
[Thousands]

Year	Cars	Light trucks	Total light vehicle sales
2011	6,093	6,449	12,542
2012	7,245	6,975	14,220
2013	7,586	7,693	15,279
2014	7,708	8,484	16,192
2015	7,529	9,578	17,107
2016	6,883	10,296	17,179
2017	6,089	10,738	16,827
2018	5,310	11,609	16,919
2019	4,720	11,911	16,630

TABLE 42—ANNUAL SALES OF NEW LIGHT VEHICLES—Continued
[Thousands]

Year	Cars	Light trucks	Total light vehicle sales
2020	3,402	10,712	14,114
Annual Average	6,257	9,445	15,701
(% of total LV sales)	(39.8)	(60.2)	(100)

Because common hardware is used across lead vehicle AEB and PAEB systems, specific system functionality can be achieved through upgraded software. Therefore, the incremental cost associated with this proposed rule reflects the cost of a software upgrade

that would allow current systems to achieve lead vehicle AEB and PAEB functionality that meets the requirements specified in the proposed rule. The incremental cost per vehicle is estimated at \$82.15 for each design cycle change of the model. When

accounting for design cycles and annual sales of new light vehicles, the total annual cost associated with the proposed rule is approximately \$282.16 million in 2020 dollars.

TABLE 43—TOTAL ANNUAL COST

Category	Number of vehicles (thousands)	Per vehicle cost		Total annual cost (millions)
		Design cycle	Annual	
Cars	6,257	\$82.15	\$27.38	\$171.32
Light Trucks	9,445		11.74	110.84
Total	15,701			282.16

Note: Values may not sum due to rounding.

F. Cost-Effectiveness

This proposed rule is highly cost effective. Based on cost-effectiveness and benefit-cost analyses, it is expected that society would be better off as a result of this proposed rule. When discounted at three and seven percent,

the cost per equivalent life saved under the proposed rule ranges from \$0.50 to \$0.62 million. Because the cost per equivalent life saved is less than the comprehensive economic cost of a fatality, the proposed rule is considered to be cost-effective.²⁴⁹ Furthermore,

when discounted at three and seven percent, the net benefits associated with the proposed rule are estimated at approximately \$6.52 and \$5.24 billion, respectively. Positive net benefits indicate that the proposed rule generates a net benefit to society.

TABLE 44—SUMMARY OF COSTS AND BENEFITS

Benefits	Monetized benefits (millions)		Total cost (millions)	Cost per equivalent life saved (millions)		Net benefits (millions)	
	3%	7%		3%	7%	3%	7%

G. Comparison of Regulatory Alternatives

To explore fully other possible rulemaking options, the agency examined a variety of combinations of performance requirements, with greater and lesser stringency than the preferred alternative. NHTSA evaluated regulatory alternatives for this rulemaking. These regulatory options were: (1) Requiring light vehicles to meet the proposed lead vehicle AEB

requirements only (no requirements for PAEB), (2) PAEB systems requirements only during daylight conditions (no change to the lead vehicle AEB requirements in the proposed rule), and (3) adding PAEB requirements in turning scenarios in addition to the requirements proposed in this NPRM (no change to the lead vehicle AEB requirements in the proposed rule). The last option, adding PAEB requirements in turning scenarios, is the only option that is expected to require new

hardware in addition to software to cover a wider field of view when the vehicle is turning. The added sensors contributed to the higher projected cost per vehicle and the low anticipated benefits from adding these scenarios contributed to the higher estimated cost per equivalent life saved shown in Table 45. When comparing cost-effectiveness and benefit-cost measures across regulatory options, the proposed rule is the most cost-effective option and also offers the highest net benefits.

²⁴⁹ The PRIA presents the Value of a Statistical Life as \$11.6 million based on the "Revised

Departmental Guidance, Treatment of Value of

Preventing Fatalities and Injuries in Preparing Economic Analyses", March 2021.

TABLE 45—SUMMARY OF REGULATORY ALTERNATIVES

Regulatory options	Relative to preferred option	Cost per equivalent life saved (millions)		Net benefits (millions)	
		3%	7%	3%	7%
Option #1: Lead Vehicle AEB Requirements	Less Stringent	\$0.88	\$1.09	\$3,650	\$2,910
Option #2: Daylight only PAEB	Less Stringent	0.71	0.87	4,594	3,674
Option #3: Proposed Rule	Preferred Option	0.50	0.62	6,520	5,235
Option #4: Add turning scenarios for PAEB	More Stringent	3.13	3.86	5,447	4,062

XI. Regulatory Notices and Analyses

Executive Orders 12866, 13563, and 14094 and DOT Regulatory Policies and Procedures

The agency has considered the impact of this rulemaking action under Executive Order (E.O.) 12866, E.O. 13563, E.O. 14094, and the Department of Transportation's regulatory procedures. This rulemaking is considered "(3)(f)(1) significant" and was reviewed by the Office of Management and Budget under E.O. 12866, "Regulatory Planning and Review," as amended by E.O. 14094, "Modernizing Regulatory Review." It is expected to have an annual effect on the economy of \$200 million or more. NHTSA has prepared a preliminary regulatory impact analysis that assesses the cost and benefits of this proposed rule, which has been included in the docket listed at the beginning of this NPRM. The benefits, costs, and other impacts of this NPRM are summarized in the prior section of this NPRM.

Regulatory Flexibility Act

The Regulatory Flexibility Act of 1980, as amended, requires agencies to evaluate the potential effects of their proposed and final rules on small businesses, small organizations, and small governmental jurisdictions. I certify that this NPRM would not have a significant economic impact on a substantial number of small entities.

The PRIA discusses the economic impact of the proposed rule on small vehicle manufacturers, of which NHTSA is aware of 12. NHTSA believes that this proposed rule would not have a significant economic impact on these manufacturers. Much of the work developing and manufacturing AEB system components would be conducted by suppliers. Although the final certification would be made by the manufacturer, this proposal would allow one additional year for small-volume manufacturers to comply with any requirement. This approach is similar to the approach we have taken in other rulemakings in recognition of manufacturing differences between

larger and smaller manufacturers. This NPRM proposes a phased compliance schedule to attain lead vehicle AEB and PAEB safety benefits as soon as practicable, while providing more time to develop technology improvements, such as those needed to meet darkness PAEB requirements. As the countermeasures are developed, AEB suppliers would likely supply larger vehicle manufacturers first, before small manufacturers. This NPRM recognizes this and proposes to provide smaller manufacturers flexibility, so they have time to obtain the equipment and work with the suppliers after the demands of the larger manufacturers are met.

This proposal may also affect final stage manufacturers, many of whom would be small businesses. However, it is NHTSA's understanding that final stage manufacturers rarely make modifications to a vehicle's braking system and instead rely upon the pass-through certification provided by a first-stage manufacturer. As with small-volume manufacturers, final stage manufacturers would be provided with one additional year to comply with any requirement.

Additional information concerning the potential impacts of this proposal on small business is presented in the PRIA accompanying this proposal.

National Environmental Policy Act

The National Environmental Policy Act of 1969 (NEPA)²⁵⁰ requires Federal agencies to analyze the environmental impacts of proposed major Federal actions significantly affecting the quality of the human environment, as well as the impacts of alternatives to the proposed action.²⁵¹ The Council on Environmental Quality (CEQ) directs federal agencies to prepare an environmental assessment for a proposed action "that is not likely to have significant effects or when the significance of the effects is unknown."²⁵² When a Federal agency prepares an environmental assessment,

²⁵⁰ 42 U.S.C. 4321–4347.

²⁵¹ 42 U.S.C. 4332(2)(C).

²⁵² 40 CFR 1501.5(a).

CEQ's NEPA implementing regulations require it to (1) "[b]riefly provide sufficient evidence and analysis for determining whether to prepare an environmental impact statement or a finding of no significant impact;" and (2) "[b]riefly discuss the purpose and need for the proposed action, alternatives . . . , and the environmental impacts of the proposed action and alternatives, and include a listing of agencies and persons consulted."²⁵³

This section serves as NHTSA's Draft Environmental Assessment (EA). In this Draft EA, NHTSA outlines the purpose and need for the proposed rulemaking, a reasonable range of alternative actions the agency could adopt through rulemaking, and the projected environmental impacts of these alternatives.

Purpose and Need

This NPRM sets forth the purpose and need for this action. In this NPRM, NHTSA proposes to adopt a new FMVSS to require AEB systems on light vehicles that are capable of reducing the frequency and severity of both lead vehicle rear-end (lead vehicle AEB) and pedestrian crashes (PAEB). As explained earlier in this preamble, the AEB system improves safety by using various sensor technologies and sub-systems that work together to detect when the vehicle is in a crash imminent situation, to automatically apply the vehicle brakes if the driver has not done so, or to apply more braking force to supplement the driver's braking, thereby detecting and reacting to an imminent crash with a lead vehicle or pedestrian. This NPRM promotes NHTSA's goal to reduce the frequency and severity of crashes described in the summary of the crash problem discussed earlier in the NPRM, and advances DOT's January 2022 National Roadway Safety Strategy that identified requiring AEB, including PAEB technologies, on new passenger vehicles as a key Departmental action to enable safer vehicles. This NPRM also responds to a mandate under the Bipartisan Infrastructure Law (BIL)

²⁵³ 40 CFR 1501.5(c).

directing the Department to promulgate such a rule.

Alternatives

NHTSA has considered four regulatory alternatives for the proposed action and a “no action alternative.” Under the no action alternative, NHTSA would not issue a final rule requiring that vehicles be equipped with systems that meet minimum specified performance requirements, and manufacturers would continue to add AEB systems voluntarily. However, since the BIL directs NHTSA to promulgate a rule that would require that all passenger vehicles be equipped with an AEB system, the no action alternative is not a permissible option. Alternative 1 considers requirements specific to lead vehicle AEB only. Alternative 2 includes the lead vehicle AEB requirements in Alternative 1 and a requirement in which PAEB is only required to function in daylight conditions. Alternative 3, the preferred alternative, considers requirements for lead vehicle AEBs and PAEB requirements in both daylight and darkness conditions. Alternative 4 considers a more-stringent requirement in which PAEB would be required to provide pedestrian protections in turning scenarios (no change to the lead vehicle AEB requirements in the proposed rule).

NHTSA has also considered the International Organization for Standardization (ISO) standards, SAE International standards, the Economic Commission for Europe (ECE) standards, test procedures used by NHTSA’s New Car Assessment Program (NCAP) and Euro NCAP, and more which are described above in this preamble and accompanying appendixes. In the proposed rule, NHTSA incorporates aspects of the test procedures and standards mentioned here, but departs from them in numerous and significant ways.

Environmental Impacts of the Proposed Action and Alternatives

This proposed rule is anticipated to result in the employment of sensor technologies and sub-systems on light vehicles that work together to sense when a vehicle is in a crash imminent situation, to automatically apply the vehicle brakes if the driver has not done so, and to apply more braking force to supplement the driver’s braking. This proposed rule is also anticipated to improve safety by mitigating the amount of fatalities, non-fatal injuries, and property damage that would result from crashes that could potentially be prevented or mitigated because of AEB.

As a result, the primary environmental impacts²⁵⁴ that could potentially result from this rulemaking are associated with: greenhouse gas emissions and air quality, socioeconomics, public health and safety, solid waste/property damage/congestion, and hazardous materials. Consistent with CEQ regulations and guidance, this EA discusses impacts in proportion to their potential significance. The effects of the proposed rulemaking that were analyzed further are summarized below.

Greenhouse Gas Emissions and Air Quality

NHTSA has previously recognized that additional weight required by FMVSS could potentially negatively impact the amount of fuel consumed by a vehicle, and accordingly result in greenhouse gas emissions or air quality impacts from criteria pollutant emissions. Atmospheric greenhouse gases (GHGs) affect Earth’s surface temperature by absorbing solar radiation that would otherwise be reflected back into space. Carbon dioxide (CO₂) is the most significant greenhouse gas resulting from human activity. Motor vehicles emit CO₂ as well as other GHGs, including methane and nitrous oxides, in addition to criteria pollutant emissions that negatively affect public health and welfare.

Additional weight added to a vehicle, like added hardware from safety systems, can cause an increase in vehicle fuel consumption and emissions. An AEB system requires the following hardware: sensing, perception, warning hardware, and electronically modulated braking subsystems. As discussed in the preamble and the PRIA, NHTSA anticipates that under the no-action alternative and Alternatives 1–3, nearly all vehicles subject to the proposal would already have all of the hardware capable of meeting the proposed requirements by the effective date of a final rule. For all alternatives, NHTSA assumes that manufacturers will need time to build code that analyses the frontal view of the vehicle (*i.e.*, manufacturers would need to upgrade the software for the perception subsystem) in a way that achieves the requirements of this proposed rule, but no additional hardware would need to

²⁵⁴ NHTSA anticipates that the proposed action and alternatives would have negligible or no impact on the following resources and impact categories, and therefore has not analyzed them further: topography, geology, soils, water resources (including wetlands and floodplains), biological resources, resources protected under the Endangered Species Act, historical and archeological resources, farmland resources, environmental justice, and Section 4(f) properties.

be added. Alternative 4 does include an assumption that two cameras will be added; however, based on weight assumptions included in studies cited in the PRIA, that weight impact would be minimal, at approximately 1570 grams, or 3.46 pounds. NHTSA has previously estimated that a 3–4-pound increase in vehicle weight is projected to reduce fuel economy by 0.01 mpg.²⁵⁵ Accordingly, while Alternatives 1–3 would not have any fuel economy penalty because no hardware would be added, Alternative 4 would potentially have a negligible fuel economy penalty.

Pursuant to the Clean Air Act (CAA), the U.S. Environmental Protection Agency (EPA) has established a set of National Ambient Air Quality Standards (NAAQS) for the following “criteria” pollutants: carbon monoxide (CO), nitrogen dioxide (NO₂), ozone, particulate matter (PM) less than 10 micrometers in diameter (PM₁₀), PM less than 2.5 micrometers in diameter (PM_{2.5}), sulfur dioxide (SO₂), and lead (Pb). The NAAQS include “primary” standards and “secondary” standards. Primary standards are intended to protect public health with an adequate margin of safety. Secondary standards are set at levels designed to protect public welfare by accounting for the effects of air pollution on vegetation, soil, materials, visibility, and other aspects of the general welfare. Under the General Conformity Rule of the CAA,²⁵⁶ EPA requires a conformity determination when a Federal action would result in total direct and indirect emissions of a criteria pollutant or precursor originating in nonattainment or maintenance areas equaling or exceeding the emissions thresholds specified in 40 CFR 93.153(b)(1) and (2). However, the General Conformity Rule does not require a conformity determination for Federal actions that are “rulemaking and policy development and issuance,” such as this action.²⁵⁷ Therefore, NHTSA has determined it is not required to perform a conformity analysis for this action.

Socioeconomics

The socioeconomic impacts of the proposed rulemaking would be primarily felt by vehicle manufacturers, light vehicle drivers, passengers, and pedestrians on the road that would

²⁵⁵ Final Regulatory Impact Analysis, Corporate Average Fuel Economy for MYs 2012–2016 Passenger Cars and Light Trucks, Table IV–5 (March 2010).

²⁵⁶ Section 176(c) of the CAA, codified at 42 U.S.C. 7506(c); To implement CAA Section 176(c), EPA issued the General Conformity Rule (40 CFR part 51, subpart W and part 93, subpart B).

²⁵⁷ 40 CFR 93.153(c)(2)(iii).

otherwise be killed or injured in light vehicle crashes. NHTSA conducted a detailed assessment of the economic costs and benefits of establishing the new rule in its PRIA. The main economic benefits come primarily from the reduction in fatalities and non-fatal injuries (safety benefits). Reductions in the severity of motor vehicle crashes would be anticipated to have corresponding reductions in costs for medical care, emergency services, insurance administrative costs, workplace costs, and legal costs due to the fatalities and injuries avoided. Other socioeconomic factors discussed in the PRIA that would affect these parties include software costs and property damage savings. Overall, Alternative 1 is anticipated to have societal net benefits of \$2.91 to \$3.65 billion, Alternative 2 is anticipated to have societal net benefits of \$3.67 to \$4.59 billion, Alternative 3 (the preferred alternative) is anticipated to have societal net benefits of \$5.24 to \$6.52 billion, and Alternative 4 is anticipated to have societal net benefits of \$4.06 to \$5.45 billion. The PRIA discusses this information in further detail.

Public Health and Safety

The affected environment for public health and safety includes roads, highways and other driving locations used by all light vehicle drivers, other drivers, passengers in light vehicles and other motor vehicles, and pedestrians or other individuals who could be injured or killed in crashes involving the vehicles regulated by the proposed action. In the PRIA, the agency determined the impacts on public health and safety by estimating the reduction in fatalities and injuries resulting from the decreased crash severity due to the use of AEB systems under the four action alternatives. Under Alternative 1, it is expected that the addition of a less stringent requirement that only specifies requirements for lead vehicle AEB would result each year in 260 to 320 equivalent lives saved. Under Alternative 2, it is expected that the less-stringent requirement, in which PAEB is only required to function in daylight conditions, would result each year in 323 to 398 equivalent lives saved. Under Alternative 3 (the preferred alternative), it is expected that the regulatory option would result each year in 454 to 559 equivalent lives saved. Finally, under Alternative 4, it is expected that the addition of more stringent requirements in which PAEB would be required to provide pedestrian protections in turning scenarios would result each year in 490 to 604 equivalent

lives saved. The PRIA discusses this information in further detail.

Solid Waste/Property Damage/ Congestion

Vehicle crashes can generate solid wastes and release hazardous materials into the environment. The chassis and engines, as well as associated fluids and components of automobiles and the contents of the vehicles, can all be deemed waste and/or hazardous materials. Solid waste can also include damage to the roadway infrastructure, including road surface, barriers, bridges, and signage. Hazardous materials are substances that may pose a threat to public safety or the environment because of their physical, chemical, or radioactive properties when they are released into the environment, in this case as a result of a crash.

NHTSA's proposed rulemaking is projected to reduce the amount and severity of light vehicle crashes, and therefore may reduce the quantity of solid waste, hazardous materials, and other property damage generated by light vehicle crashes in the United States. The addition of an AEB system may also result in reduced damage to the vehicles and property, as well as reduced travel delay costs due to congestion. This is especially the case in "property damage only" crashes, where no individuals are injured or killed in the crash, but there may be damage to the vehicle or whatever is impacted by it. NHTSA estimates that based off data from 2016–2019 alone, an average of 1.12 million rear-impact crashes involving light vehicles occurred annually. These crashes resulted in an annual average of 394 fatalities, 142,611 non-fatal injuries, and approximately 1.69 million property damage only vehicles (PDOV).

Less solid waste translates into cost and environmental savings from reductions in the following areas: (1) transport of waste material, (2) energy required for recycling efforts, and (3) landfill or incinerator fees. Less waste will result in beneficial environmental effects through less GHG emissions used in the transport of it to a landfill, less energy used to recycle the waste, less emissions through the incineration of waste, and less point source pollution at the scene of the crash that would result in increased emissions levels or increased toxins leaking from the crashed vehicles into the surrounding environment.

The addition of an AEB system may also result in reduced post-crash environmental effects from congestion. As discussed in the PRIA, NHTSA's monetized benefits are calculated by

multiplying the number of non-fatal injuries and fatalities mitigated by their corresponding "comprehensive costs." The comprehensive costs include economic costs that are external to the value of a statistical life (VSL) costs, such as emergency management services or legal costs, and congestion costs. NHTSA has recognized that motor vehicle crashes result in congestion that has both socioeconomic and environmental effects. These environmental effects include "wasted fuel, increased greenhouse gas production, and increased pollution as engines idle while drivers are caught in traffic jams and slowdowns."²⁵⁸ NHTSA's monetized benefits therefore do include a quantified measure of congestion avoidance. NHTSA did not calculate congestion effects specifically for each regulatory alternative, however, because comprehensive costs are a discrete cost applied to non-fatal injuries and fatalities at the same rate, we can conclude that there are increasing benefits associated with fewer crashes, and specifically decreased congestion, as the monetized benefits increase across regulatory alternatives. To the extent that any regulatory option for AEB results in fewer crashes and accordingly higher monetized benefits, there would be fewer congestion-related environmental effects.

NHTSA has tentatively concluded that under the agency's proposal, the economic benefits resulting from improved safety outcomes, property damage savings, fuel savings, and GHG reductions would not only limit the negative environmental impacts caused by additional solid waste/property damage due to crashes but also would limit such effects. Similarly, while the potential degree of hazardous materials spills prevented due to the reduction of crash severity and crash avoidance expected from the rulemaking has not specifically been analyzed in the PRIA or NPRM, the addition of the AEB system is projected to reduce the amount and severity of light vehicle crashes and may improve the environmental effects with respect to hazardous material spills. While the PRIA does not specifically quantify these impact categories, in general NHTSA believes the benefits would increase relative to the crashes avoided and would be relative across the different alternatives. The PRIA

²⁵⁸ Blincoe, L.J., Miller, T.R., Zaloshnja, E., & Lawrence, B.A. (2015, May). The economic and societal impact of motor vehicle crashes, 2010. (Revised) (Report No. DOT HS 812 013). Washington, DC: National Highway Traffic Safety Administration.

discusses information related to quantified costs and benefits of crashes, and in particular property damage due to crashes, for each regulatory alternative in further detail.

Cumulative Impacts

In addition to direct and indirect effects, CEQ regulations require agencies to consider cumulative impacts of major Federal actions. CEQ regulations define cumulative impacts as the impact “on the environment that result from the incremental [impact] of the action when added to . . . other past, present, and reasonably foreseeable future actions regardless of what agency (Federal or non-Federal) or person undertakes such other actions.”²⁵⁹ NHTSA notes that the public health and safety, solid waste/property damage/congestion, air quality and greenhouse gas emissions, socioeconomic, and hazardous material benefits identified in this EA were based on calculations described in the PRIA, in addition to other NHTSA actions and studies on motor vehicle safety. That methodology required the agency to adjust historical figures to reflect vehicle safety rulemakings that have recently become effective. As a result, many of the calculations in this EA already reflect the incremental impact of this action when added to other past actions.

NHTSA’s and other parties’ past actions that improve the safety of light vehicles, as well as future actions taken by the agency or other parties that improve the safety of light vehicles, could further reduce the severity or number of crashes involving light vehicles. Any such cumulative improvement in the safety of light vehicles would have an additional effect in reducing injuries and fatalities and could reduce the quantity of solid and hazardous materials generated by crashes. With regard to vehicle fuel use that leads to criteria air pollutant and GHG emissions, Federal or State actions, like NHTSA’s Corporate Average Fuel Economy standards for light duty vehicles or EPA’s greenhouse gas and criteria pollutant emissions standards for light duty vehicles, may result in additional emissions reductions by light vehicles in the future.

Agencies and Persons Consulted

This preamble describes the various materials, persons, and agencies consulted in the development of the proposal.

Finding of No Significant Impact

Although this rule is anticipated to result in increased FMVSS requirements for light vehicle manufacturers, AEB systems have already largely been introduced by manufacturers voluntarily. The addition of regulatory requirements (depending on the regulatory alternative) to standardize the AEB systems in all vehicle models is anticipated to result in no or negligible fuel economy and emissions penalties (*i.e.*, only Alternative 4 would potentially require additional hardware, but the added weight is negligible), increasing socioeconomic and public safety benefits as the alternatives get more stringent, and an increase in benefits from the reduction in solid waste, property damage, and congestion (including associated traffic level impacts like reduction in energy consumption and tailpipe pollutant emissions) from fewer vehicle crashes across the regulatory alternatives.

Based on the information in this Draft EA and assuming no additional information or changed circumstances, NHTSA expects to issue a Finding of No Significant Impact (FONSI).²⁶⁰ NHTSA has tentatively concluded that none of the impacts anticipated to result from the proposed action and alternatives under consideration will have a significant effect on the human environment. Such a finding will be made only after careful review of all public comments received. A Final EA and a FONSI, if appropriate, will be issued as part of the final rule.

Executive Order 13132 (Federalism)

NHTSA has examined this NPRM pursuant to Executive Order 13132 (64 FR 43255, August 10, 1999) and concludes that no additional consultation with States, local governments, or their representatives is mandated beyond the rulemaking process. The agency has concluded that the rulemaking will not have sufficient federalism implications to warrant consultation with State and local officials or the preparation of a federalism summary impact statement. The NPRM will not have “substantial direct effects on the States, on the relationship between the national government and the States, or on the distribution of power and responsibilities among the various levels of government.”

NHTSA rules can preempt in two ways. First, the National Traffic and Motor Vehicle Safety Act contains an express preemption provision: When a

motor vehicle safety standard is in effect under this chapter, a State or a political subdivision of a State may prescribe or continue in effect a standard applicable to the same aspect of performance of a motor vehicle or motor vehicle equipment only if the standard is identical to the standard prescribed under this chapter. 49 U.S.C. 30103(b)(1). It is this statutory command by Congress that preempts any non-identical State legislative and administrative law addressing the same aspect of performance.

The express preemption provision described above is subject to a savings clause under which compliance with a motor vehicle safety standard prescribed under this chapter does not exempt a person from liability at common law. 49 U.S.C. 30103(e). Pursuant to this provision, State common law tort causes of action against motor vehicle manufacturers that might otherwise be preempted by the express preemption provision are generally preserved.

However, the Supreme Court has recognized the possibility, in some instances, of implied preemption of such State common law tort causes of action by virtue of NHTSA’s rules, even if not expressly preempted. This second way that NHTSA rules can preempt is dependent upon there being an actual conflict between an FMVSS and the higher standard that would effectively be imposed on motor vehicle manufacturers if someone obtained a State common law tort judgment against the manufacturer, notwithstanding the manufacturer’s compliance with the NHTSA standard. Because most NHTSA standards established by an FMVSS are minimum standards, a State common law tort cause of action that seeks to impose a higher standard on motor vehicle manufacturers will generally not be preempted. However, if and when such a conflict does exist—for example, when the standard at issue is both a minimum and a maximum standard—the State common law tort cause of action is impliedly preempted. See *Geier v. American Honda Motor Co.*, 529 U.S. 861 (2000).

Pursuant to Executive Order 13132 and 12988, NHTSA has considered whether this proposed rule could or should preempt State common law causes of action. The agency’s ability to announce its conclusion regarding the preemptive effect of one of its rules reduces the likelihood that preemption will be an issue in any subsequent tort litigation. To this end, the agency has examined the nature (*i.e.*, the language and structure of the regulatory text) and objectives of this proposed rule and finds that this rule, like many NHTSA

²⁵⁹ 40 CFR 1508.1(g)(3).

²⁶⁰ 40 CFR 1501.6(a).

rules, would prescribe only a minimum safety standard. As such, NHTSA does not intend this NPRM to preempt state tort law that would effectively impose a higher standard on motor vehicle manufacturers rule. Establishment of a higher standard by means of State tort law will not conflict with the minimum standard adopted here. Without any conflict, there could not be any implied preemption of a State common law tort cause of action.

Civil Justice Reform

With respect to the review of the promulgation of a new regulation, section 3(b) of Executive Order 12988, "Civil Justice Reform" (61 FR 4729, February 7, 1996) requires that Executive agencies make every reasonable effort to ensure that the regulation: (1) Clearly specifies the preemptive effect; (2) clearly specifies the effect on existing Federal law or regulation; (3) provides a clear legal standard for affected conduct, while promoting simplification and burden reduction; (4) clearly specifies the retroactive effect, if any; (5) adequately defines key terms; and (6) addresses other important issues affecting clarity and general draftsmanship under any guidelines issued by the Attorney General. This document is consistent with that requirement.

Pursuant to this Order, NHTSA notes as follows. The preemptive effect of this rulemaking is discussed above. NHTSA notes further that there is no requirement that individuals submit a petition for reconsideration or pursue other administrative proceeding before they may file suit in court.

Paperwork Reduction Act (PRA)

Under the PRA of 1995, a person is not required to respond to a collection of information by a Federal agency unless the collection displays a valid OMB control number. There are no "collections of information" (as defined at 5 CFR 1320.3(c)) in this NPRM.

National Technology Transfer and Advancement Act

Under the National Technology Transfer and Advancement Act of 1995 (NTTAA) (Pub. L. 104-113), all Federal agencies and departments shall use technical standards that are developed or adopted by voluntary consensus standards bodies, using such technical standards as a means to carry out policy objectives or activities determined by the agencies and departments. Voluntary consensus standards are technical standards (e.g., materials specifications, test methods, sampling procedures, and business practices) that

are developed or adopted by voluntary consensus standards bodies, such as the International Organization for Standardization and SAE International. The NTTAA directs us to provide Congress, through OMB, explanations when we decide not to use available and applicable voluntary consensus standards.

NHTSA is proposing to incorporate by reference ISO and ASTM standards into this proposed rule. NHTSA considered several ISO standards and has proposed to use ISO 19206-3:2021 to specify the vehicle test device and a combination of ISO 19206-2:2018 and ISO 19206-4:2020 to specify the test mannequins. NHTSA is incorporating by reference ASTM E1337-19, which is already incorporated by reference into many FMVSSs, to measure the peak braking coefficient of the testing surface.

NHTSA considered SAE International Recommended Practice J3087, "Automatic emergency braking (AEB) system performance testing," which define the conditions for testing AEB and FCW systems. This standard defines test conditions, test targets, test scenarios, and measurement methods, but does not provide performance criteria. There is considerable overlap in the test setup and conditions between this proposed rule and the SAE standard including the basic scenarios of lead vehicle stopped, slower moving, and decelerating. This SAE recommended practice is substantially similar to the existing NCAP test procedures and this proposal.

NHTSA also considered SAE International Standard J3116, "Active Safety Pedestrian Test Mannequin Recommendation," which provides recommendations for the characteristics of a surrogate that could be used in testing of active pedestrian safety systems. NHTSA proposed to incorporate the ISO standard because the ISO Standard specifications are more widely adopted than the SAE Recommended Practice. However, NHTSA requests comments on whether it would be more appropriate to use the SAE Recommended Practice specifications because they are more representative of the average pedestrian fatality.

In Appendix B of this preamble, NHTSA describes several international test procedures and regulations the agency considered for use in this NPRM. This proposed rule has substantial technical overlap with UNECE Regulation No. 131 and UNECE Regulation No. 152. This proposal and the UNECE regulations both specify a forward collision warning and automatic emergency braking. Several

lead vehicle AEB scenarios are nearly identical, including the lead vehicle stopped and lead vehicle moving scenarios. The pedestrian crossing path scenario specified in UNECE Regulation No. 152 is substantially similar to this NPRM. As discussed in the preamble, this proposed rule differs from the UNECE standards in the areas of maximum test speed and the minimum level of required performance. This proposed rule uses higher test speeds and a requirement that the test vehicle avoid contact. This approach would increase the repeatability of the test and maximize the realized safety benefits of the rule.

Incorporation by Reference

Under regulations issued by the Office of the Federal Register (1 CFR 51.5(a)), an agency, as part of a proposed rule that includes material incorporated by reference, must summarize material that is proposed to be incorporated by reference and discuss the ways the material is reasonably available to interested parties or how the agency worked to make materials available to interested parties.

In this NPRM, NHTSA proposes to incorporate by reference six documents into the Code of Federal Regulations, one of which is already incorporated by reference. The document already incorporated by reference into 49 CFR part 571 is ASTM E1337, "Standard Test Method for Determining Longitudinal Peak Braking Coefficient (PBC) of Paved Surfaces Using Standard Reference Test Tire." ASTM E1337 is a standard test method for evaluating peak braking coefficient of a test surface using a standard reference test tire using a trailer towed by a vehicle. NHTSA uses this method in all of its braking and electronic stability control standards to evaluate the test surfaces for conducting compliance test procedures.

NHTSA is also proposing to incorporate by reference into part 571 SAE J2400 "Human Factors in Forward Collision Warning System: Operating Characteristics and User Interface Requirements." SAE J2400 is an information report that is intended as a starting point of reference for designers of forward collision warning systems. NHTSA would incorporate this document by reference solely to specify the location specification and symbol for a visual forward collision warning.

NHTSA is proposing to incorporate by reference four ISO standards into 49 CFR part 596. The first of these standards is ISO 3668:2017, "Paints and varnishes—Visual comparison of colour of paints." This document specifies a

method for the visual comparison of the color of paints against a standard. This method would be used to verify the color of certain elements of the pedestrian test mannequin NHTSA is proposing to use in PAEB testing. Specifically, NHTSA is using these procedures in order to determine that the color of the hair, torso, arms, and feet of the pedestrian test mannequin is black and that the color of the legs are blue.

NHTSA is also proposing to incorporate by reference ISO 19206–2:2018(E), “Road vehicles—Test devices for target vehicles, vulnerable road users and other objects, for assessment of active safety functions—Part 2: Requirements for pedestrian targets.” This document addresses the specification for a test mannequin. It is designed to resemble the characteristics of a human, while ensuring the safety of the test operators and preventing damage to subject vehicles in the event of a collision during testing. NHTSA is referencing many, but not all, of the specifications of ISO 19206–2:2018(E), as discussed in section VIII.A of this NPRM.

NHTSA is also proposing to incorporate by reference ISO 19206–3:2021(E), “Test devices for target vehicles, vulnerable road users and other objects, for assessment of active safety functions—Part 3: Requirements for passenger vehicle 3D targets.” This document provides specification of three-dimensional test devices that resemble real vehicles. Like the test mannequin described in the prior paragraph, it is designed to ensure the safety of the test operators and to prevent damage to subject vehicles in the event of a collision during testing. NHTSA is referencing many, but not all, of the specifications of ISO 19206–3:2021(e), as discussed in section VIII.B of this NPRM.

Finally, NHTSA is proposing to incorporate by reference ISO 19206–4:2020, “Road vehicles—test devices for target vehicles, vulnerable road users and other objects, for assessment of active safety functions—Part 4: Requirements for bicyclists targets.” This standard describes specifications for bicycle test devices, which are representative of adult and child sizes. However, NHTSA is not proposing to use a bicycle test device during testing. Rather, this standard is incorporated by reference solely because it contains specifications for color and reflectivity, including skin color, that NHTSA is applying to its pedestrian test mannequin.

All standards proposed to be incorporated by reference in this NPRM

are available for review at NHTSA’s headquarters in Washington, DC, and for purchase from the organizations promulgating the standards. The ASTM standard presently incorporated by reference into other NHTSA regulations is also available for review at ASTM’s online reading room.²⁶¹

Unfunded Mandates Reform Act

The Unfunded Mandates Reform Act of 1995 (Pub. L. 104–4) requires agencies to prepare a written assessment of the costs, benefits, and other effects of proposed or final rules that include a Federal mandate likely to result in the expenditures by States, local or tribal governments, in the aggregate, or by the private sector, of more than \$100 million annually (adjusted annually for inflation with base year of 1995). Adjusting this amount by the implicit gross domestic product price deflator for 2021 results in an estimated current value of \$165 million (2021 index value of 113.07/1995 index value of 68.60 = 1.65). The assessment may be included in conjunction with other assessments, as it is here.

A proposed rule on lead vehicle AEB and PAEB is not likely to result in expenditures by State, local or tribal governments of more than \$100 million annually. However, it is estimated to result in the estimated expenditure by automobile manufacturers and/or their suppliers of \$282 million annually (estimated to be \$27.38 per passenger car and \$11.74 per light truck annually). This range in estimated cost impacts reflects that the estimated incremental costs depend on a variety of lead vehicle AEB hardware and software that manufacturers plan to install (in vehicles used as “baseline” for the cost estimate). The final cost will greatly depend on choices made by the automobile manufacturers to meet the lead vehicle AEB and PAEB test requirements. These effects have been discussed in this Preliminary Regulatory Impact Analysis in Chapter 5.3.

The Unfunded Mandates Reform Act requires the agency to select the “least costly, most cost-effective or least burdensome alternative that achieves the objectives of the rule.” As an alternative, the agency considered a full-vehicle dynamic test to evaluate the capability of lead vehicle AEB and PAEB systems to prevent crashes or mitigate the severity of crashes. Based on our experience on conducting vehicle tests for vehicles equipped with lead vehicle AEB and PAEB where we utilize a reusable surrogate target crash vehicle and test mannequins instead of

conducting the test with an actual vehicle as the target, we determined that full vehicle-to-vehicle crash tests can have an undesired amount of variability in vehicle kinematics. Unlike vehicle-to-vehicle tests, the lead vehicle AEB and PAEB tests with a surrogate target vehicle is conducted in a well-controlled test environment, which results in an acceptable amount of variability. In addition, the agency’s lead vehicle AEB and PAEB tests with surrogate target vehicle and pedestrian were able to reveal deficiencies in the system that resulted in inadequate system capability in detecting and activating the brakes. Therefore, we concluded that a full vehicle-to-vehicle test would not achieve the objectives of the rule.

In addition, the agency evaluated data across a broad range of test scenarios in an effort to identify the maximum range of test speeds at which it is feasible for test vehicles to achieve a no-contact result. The range of feasible speeds identified in the review was specified as the mandated range in the proposed rule. Thus, there are no alternative test procedures available that would improve the ability of manufacturers to achieve no-contact results. In turn, the agency concluded that lead vehicle AEB and PAEB systems designed to meet the no-contact requirement at speeds outside the ranges specified in the proposed rule would not achieve the objectives of the rule.

Executive Order 13609 (Promoting International Regulatory Cooperation)

The policy statement in section 1 of E.O. 13609 states, in part, that the regulatory approaches taken by foreign governments may differ from those taken by U.S. regulatory agencies to address similar issues and that, in some cases, the differences between the regulatory approaches of U.S. agencies and those of their foreign counterparts might not be necessary and might impair the ability of American businesses to export and compete internationally. The E.O. states that, in meeting shared challenges involving health, safety, labor, security, environmental, and other issues, international regulatory cooperation can identify approaches that are at least as protective as those that are or would be adopted in the absence of such cooperation, and that international regulatory cooperation can also reduce, eliminate, or prevent unnecessary differences in regulatory requirements. NHTSA requests public comment on the “regulatory approaches taken by foreign governments” concerning the subject matter of this rulemaking.

²⁶¹ <https://www.astm.org/READINGLIBRARY/>.

Regulation Identifier Number

The Department of Transportation assigns a regulation identifier number (RIN) to each regulatory action listed in the Unified Agenda of Federal Regulations. The Regulatory Information Service Center publishes the Unified Agenda in April and October of each year. You may use the RIN contained in the heading at the beginning of this document to find this action in the Unified Agenda.

Plain Language

Executive Order 12866 requires each agency to write all rules in plain language. Application of the principles of plain language includes consideration of the following questions:

- Have we organized the material to suit the public's needs?
- Are the requirements in the rule clearly stated?
- Does the rule contain technical language or jargon that isn't clear?
- Would a different format (grouping and order of sections, use of headings, paragraphing) make the rule easier to understand?
- Would more (but shorter) sections be better?
- Could we improve clarity by adding tables, lists, or diagrams?
- What else could we do to make the rule easier to understand?

If you have any responses to these questions, please write to us with your views.

XII. Public Participation

How long do I have to submit comments?

Please see the **DATES** section at the beginning of this document.

How do I prepare and submit comments?

- Your comments must be written in English.
- To ensure that your comments are correctly filed in the Docket, please include the Docket Number shown at the beginning of this document in your comments.
- Your comments must not be more than 15 pages long. (49 CFR 553.21). We established this limit to encourage you to write your primary comments in a concise fashion. However, you may attach necessary additional documents to your comments. There is no limit on the length of the attachments.
- If you are submitting comments electronically as a PDF (Adobe) File, NHTSA asks that the documents be submitted using the Optical Character Recognition (OCR) process, thus allowing NHTSA to search and copy

certain portions of your submissions. Comments may be submitted to the docket electronically by logging onto the Docket Management System website at <http://www.regulations.gov>. Follow the online instructions for submitting comments.

- You may also submit two copies of your comments, including the attachments, to Docket Management at the address given above under **ADDRESSES**.

Please note that pursuant to the Data Quality Act, in order for substantive data to be relied upon and used by the agency, it must meet the information quality standards set forth in the OMB and DOT Data Quality Act guidelines. Accordingly, we encourage you to consult the guidelines in preparing your comments. OMB's guidelines may be accessed at <http://www.whitehouse.gov/omb/information-regulatory-affairs/information-policy/>. DOT's guidelines may be accessed at <http://www.transportation.gov/dot-information-dissemination-quality-guidelines>.

How can I be sure that my comments were received?

If you wish Docket Management to notify you upon its receipt of your comments, enclose a self-addressed, stamped postcard in the envelope containing your comments. Upon receiving your comments, Docket Management will return the postcard by mail.

How do I submit confidential business information?

If you wish to submit any information under a claim of confidentiality, you should submit three copies of your complete submission, including the information you claim to be confidential business information, to the Chief Counsel, NHTSA, at the address given above under **FOR FURTHER INFORMATION CONTACT**. In addition, you should submit two copies, from which you have deleted the claimed confidential business information, to Docket Management at the address given above under **ADDRESSES**. When you send a comment containing information claimed to be confidential business information, you should include a cover letter setting forth the information specified in our confidential business information regulation. (49 CFR part 512). To facilitate social distancing during COVID-19, NHTSA is temporarily accepting confidential business information electronically. Please see <https://www.nhtsa.gov/coronavirus/submission-confidential-business-information> for details.

Will the agency consider late comments?

We will consider all comments that Docket Management receives before the close of business on the comment closing date indicated above under **DATES**. To the extent possible, we will also consider comments that Docket Management receives after that date. If Docket Management receives a comment too late for us to consider in developing the final rule, we will consider that comment as an informal suggestion for future rulemaking action.

How can I read the comments submitted by other people?

You may read the comments received by Docket Management at the address given above under **ADDRESSES**. The hours of the Docket are indicated above in the same location. You may also see the comments on the internet. To read the comments on the internet, go to <http://www.regulations.gov>. Follow the online instructions for accessing the dockets.

Please note that, even after the comment closing date, we will continue to file relevant information in the Docket as it becomes available. Further, some people may submit late comments. Accordingly, we recommend that you periodically check the Docket for new material.

XIII. Appendices to the Preamble

Appendix A: Description of Technologies

For the convenience of readers, this section describes various technologies of an AEB system. An AEB system employs multiple sensor technologies and sub-systems that work together to sense a crash imminent scenario and, where applicable, automatically apply the vehicle brakes to avoid or mitigate a crash. Current systems utilize radar- and camera-based sensors, and the agency is aware of emerging technologies such as lidar and infrared sensors. AEB builds upon electronic stability control (ESC) technology joined with a perception system, and ESC itself is an extension of antilock braking system (ABS) technologies. It also builds upon older forward collision warning-only (FCW-only) systems.

Radar-Based Sensors

At its simplest form, radar is a time-of-flight sensor that measures the time between when a radio wave is transmitted, and its reflection is recorded. This time-of-flight is then used to calculate the distance to the object that caused the reflection. More information about the reflecting object,

such as speed, can be determined by comparing the output signal to the input signal. Typical automotive applications use a type of radar called Frequency Modulated Continuous Wave radar. This radar system sends out a radio pulse where the pulse frequency rises through the duration of the pulse. This pulse is reflected off the object and the radar sensor compares the reflected signal to the original pulse to determine the range and relative speed.

Radar sensors are widely used in AEB applications, for many reasons. These sensors can have a wide range of applicability, with automotive grade radar sensing ranges on the order of 1 meter (3 ft) up to over 200 meters (656 ft). Radar sensors are also relatively unaffected by time of day, precipitation, fog, and many other adverse weather conditions. Automotive radar systems typically operate on millimeter wave lengths, easily reflecting off even the smallest metallic surfaces found on vehicles. Radio waves tend to penetrate soft materials, such as rubber and plastic, allowing these sensors to be mounted in the front ends of vehicles behind protective and visually appealing grilles and bumper fascia.

Radar-based sensors have limitations that impact their effectiveness. Radar is a line-of-sight sensor, in that it only operates in the direction the receiving antenna is pointed and therefore has a limited angular view. Also, while radar is excellent at identifying radar-reflective objects, the nature of the radar reflection makes classification of those objects difficult. In addition, objects that do not reflect radio waves easily, such as rubber, plastic, humans, and other soft objects, are difficult for radar-based sensors to detect. Lastly, because forward facing radar sensors are usually mounted inside the front end of equipped vehicles, damage caused from front-end collisions can lead to alignment issues and reduced effectiveness.

Camera Sensors

Cameras are passive sensors that record optical data using digital imaging chips, which are then processed to allow for object detection and classification. They are an important part of most automotive AEB systems, and one or more cameras are typically mounted behind the front windshield, often high up near the rearview mirror. This provides a good view of the road, and the windshield wipers can provide a way to clear debris, dirt, and other contaminants from the windshield in front of the sensor.

Camera-based imaging systems are one of the few sensor types that can

determine both color and contrast information. This makes them able to recognize and classify objects such as road signs, other vehicles, and pedestrians, much in the same way the human eye does. In addition, systems that utilize two or more cameras can see stereoscopically, allowing the processing system to determine range information along with detection and classification.

Like all sensor systems, camera-based sensors have their benefits and limitations. Monocular camera systems lack depth perception and are poor at determining range, and even stereoscopic camera systems are not ideal for determining speed. Because cameras rely on the visible spectrum of light, conditions that make it difficult to see, such as rain, snow, sleet, fog, and even dark unlit areas, decrease the effectiveness of perception checks of these systems. It is also possible for the imaging sensor to saturate when exposed to excessive light, such as driving towards the sun. For these reasons, camera sensors are often used in conjunction with other sensors like radar.

Thermal Imaging Systems

While rare in the current generation of AEB systems, suppliers of AEB technologies are looking at advanced sensor technologies to augment the limitations of camera/radar systems. Thermal imaging systems are one such advanced sensor. Very similar to cameras, thermal imaging systems are optical sensors that record visual information. The difference is that, where cameras rely on the visible spectrum of light, thermal imaging systems rely on infrared radiation, also known as thermal radiation.

Infrared radiation is the part of the electromagnetic spectrum between visible light and microwave radiation. Typically, the wavelengths range from 750 nm up to 1 mm. This spectrum also corresponds to the energy output by warm bodies, making these sensors ideal for use in dark areas where traditional cameras may have difficulties. Thermal imaging systems can be particularly useful for darkness detection of pedestrians. They can also have an active component, either a blanket infrared flood light or an infrared laser system, to augment the passive collection of a camera.

These systems, however, also have limitations. They may not be able to differentiate between multiple hot bodies, and in the presence of thermal insulation, such as a jacket or cold weather clothing, warm bodies can appear cold and difficult to differentiate

from the background. Reflectivity of the detected object as well as the ambient environment can affect the performance of these systems.

Lidar

Lidar, or Light Detection and Ranging is a laser-based time-of-flight sensor that uses pulses of visual light to determine distances between the sensor and an object. Much like radar, by calculating the amount of time between the transmission and reception of a pulse of light, a lidar system can determine the distance to the object. These sensors are one of the primary sensors in prototype automated driving systems under development for future AEB systems.²⁶²

Because a lidar system uses lasers for range-finding, it can infer exact measurements of most objects surrounding a vehicle, including other vehicles and pedestrians. Because of how accurately lidar can measure distances and speeds, it is very good at determining the differences between cars, pedestrians, cyclists, light posts, road signs, and many other obstacles in the path of a vehicle. With proper control software, a lidar sensor can detect things like lane boundaries.

Limitations of lidar tend to be similar to those of both camera systems and radar systems. Lidar is an active system, so it is unaffected by dark lighting conditions, but it can be severely degraded by rain, sleet, fog, or snow. It is a line-of-sight sensor and cannot see through certain objects in the way that radar can. Its maximum effective range is often limited by surface reflectivity, illumination saturation (driving towards the sun or other bright light), and environmental attenuation, such as hazy conditions or heat shimmer. Other limiting factors are the large computational processing needs to adequately utilize the lidar sensor, and its currently high costs.

Electronically Modulated Braking Systems

Automatic actuation of the vehicle brakes requires more than just systems to sense when a collision is imminent. Regardless of how good a sensing system is, hardware is needed to physically apply the brakes without relying on the driver to modulate the brake pedal. The automatic braking system relies on two foundational

²⁶² SAE J3016, "Taxonomy and Definitions for Terms Related to Driving Automation Systems for On-Road Motor Vehicles," APR2021, defines an automated driving system as the hardware and software that are collectively capable of performing the entire dynamic driving task on a sustained basis, regardless of whether it is limited to a specific operational design domain.

braking technologies, antilock braking systems and electronic stability control.

Antilock brakes are a foundational braking technology that automatically controls the degree of wheel slip during braking to prevent wheel lock and minimize skidding, by sensing the rate of angular rotation of the wheels and modulating the braking force at the wheels to keep the wheels from slipping. Modern ABS systems have wheel speed sensors and independent brake modulation at each wheel and can increase and decrease braking pressures as needed.

ESC builds upon the antilock brakes with the addition of at least two sensors, a steering wheel angle sensor and an inertial measurement unit. These sensors allow the ESC controller to determine the intended steering direction (from the steering wheel angle sensor), compare it to the actual vehicle direction, and then modulate braking forces at each wheel, without the driver applying input to the brake pedal, to induce a counter yaw when the vehicle starts to lose lateral stability.

AEB uses the hardware needed for ESC and automatically applies the brakes to avoid certain scenarios where a crash with a vehicle or pedestrian is imminent.

Forward Collision Warning

Using the sensors described above, coupled with an alert mechanism and perception calculations, a FCW system is able to monitor a vehicle's speed, the speed of the vehicle in front of it, and the distance between the two vehicles. If the FCW system determines that the distance from the driver's vehicle to the vehicle in front of it is too short and the closing velocity between the two vehicles is too high, the system warns the driver of an impending rear-end collision.

Typically, FCW systems are comprised of two components: a sensing system, which can detect a vehicle in front of the driver's vehicle, and a warning system, which alerts the driver to a potential crash threat. The sensing portion of the system may consist of forward-looking radar, camera systems, lidar, or a combination of these. Warning systems in use today provide drivers with a visual display, such as an illuminated telltale on the instrument panel, an auditory signal (e.g., beeping tone or chime), and/or a haptic signal that provides tactile feedback to the driver (e.g., rapid vibrations of the seat pan or steering wheel or a momentary brake pulse) to alert the driver to an impending crash so that the driver may manually intervene (e.g., apply the vehicle's brakes or make an evasive

steering maneuver) to avoid or mitigate the crash.

FCW systems alone are designed to warn the driver, but do not provide automatic braking of the vehicle (some FCW systems use haptic brake pulses to alert the driver of a crash-imminent driving situation, but they are not intended to effectively slow the vehicle). Since the first introduction of FCW systems, the technology has advanced so that it is now possible to couple those sensors, software, and alerts with the vehicle's service brake system to provide additional functionality covering a broader portion of the safety problem.

From a functional perspective, research suggests that active braking systems, such as AEB, provide greater safety benefits than warning systems, such as FCW systems. However, NHTSA has found that current AEB systems often integrate the functionalities of FCW and AEB into one frontal crash prevention system to deliver improved real-world safety performance and high consumer acceptance. FCW can now be considered a component of lead vehicle AEB. As such, this NPRM integrates FCW directly into the performance requirements for AEB—Lead Vehicle. This integration would also enable the agency to assess vehicles' compliance with the proposed FCW and AEB requirements at the same time in a single test.

Automatic Emergency Braking—Lead Vehicle

Unlike systems that only alert, AEB systems (systems that automatically apply the brakes), are designed to actively help drivers avoid or mitigate the severity of rear-end crashes. AEB—Lead Vehicle has been previously broken down into two primary functions, crash imminent braking and dynamic brake support. CIB systems provide automatic braking when forward-looking sensors indicate that a crash is imminent and the driver has not applied the brakes, whereas DBS systems use the same forward-looking sensors, but provide supplemental braking after the driver applies the brakes when sensors determine that driver-applied braking is insufficient to avoid an imminent rear-end crash. This NPRM does not split the terminology of these functionalities and instead discusses them together as "AEB." In some crash situations, AEB functions independently of the driver's use of the brake pedal (CIB), while in other situations, the vehicle uses the driver's pedal input to better evaluate the situation and avoid the crash (DBS). This proposal considers each function

necessary to address the safety need and presents a performance-based regulatory approach that can permit the detailed application of each function to be based on the specific vehicle application and the manufacturer's approach to meeting the standard.

In response to an FCW or a driver noticing an imminent crash scenario, a driver may initiate braking to avoid a rear-end crash. In situations where the driver's braking is insufficient to prevent a collision, the AEB system can automatically supplement the driver's braking action to prevent or mitigate the crash. Similar to FCW systems, AEB systems employ forward-looking sensors such as radar, cameras, infrared, and/or lidar sensors to detect vehicles in the path directly ahead and monitor the subject vehicle's operating conditions such as speed or brake application. However, AEB systems can also actively supplement braking to assist the driver, whereas FCW systems serve only to warn the driver of a potential crash threat.

If a driver does not take action to apply the brakes when a rear-end crash is imminent, AEB systems utilize the same types of forward-looking sensors to apply the vehicle's brakes automatically to slow or stop the vehicle. The amount of braking applied varies by manufacturer, and several systems are designed to achieve maximum vehicle deceleration just prior to impact. In reviewing model year 2017–2019 NCAP crash imminent braking test data, NHTSA observed a deceleration range of 0.31 to 1.27 g. This NPRM does not directly require a particular deceleration capability but specifies situations in which crash avoidance must be achieved. Avoidance may be produced by the automatic application of the subject vehicle brakes or by automatically supplementing the deceleration achieved by driver's braking action in the case where the subject vehicle brakes are manually applied.

Pedestrian Automatic Emergency Braking

PAEB systems function like lead vehicle AEB systems, but detect pedestrians instead of leading vehicles. PAEB uses information from forward-looking sensors to actively and automatically apply the vehicle's brakes when a pedestrian is in front of the vehicle and the driver has not acted to avoid the impending impact. Similar to lead vehicle AEB, PAEB systems typically use cameras to determine whether a pedestrian is in imminent danger of being struck by the vehicle, but some systems may use a

combination of cameras, radar, lidar, and infrared sensors.

A camera's field of view plays a key role in the type of pedestrian crashes that a PAEB system can assist in avoiding. Cameras used for PAEB can provide the information required by the system to provide crash protection in situations where the pedestrian is either directly in the path of a vehicle or is entering the path of the vehicle while the vehicle is moving straight ahead.

Sensor performance may be limited by the availability of environmental lighting. The cameras used in PAEB systems rely on reflected light in the same way as a human eye. As such, the vehicle's integration of headlighting systems along with the tuning of camera exposure rates and sensor light sensitivities are important considerations in producing a PAEB system that assists in avoiding pedestrian crashes that happen at night. The permeance limits proposed in this NPRM can be achieved with radar and camera system technologies.

Appendix B: International Activities

International AEB Testing Standards

NHTSA has considered other vehicle testing organizations' AEB test procedures as part of the development of this proposal. The ISO has published Standard 22733-1, "Road vehicles—Test method to evaluate the performance of autonomous emergency braking systems." This ISO standard does not set minimum performance requirements for lead vehicle AEB systems or any pass/fail conditions. Instead, the standard sets forth a test procedure using progressively increasing speeds at which a vehicle equipped with lead vehicle AEB approaches a stationary or moving surrogate vehicle until it makes contact.

The surrogate vehicle specified is the vehicle target defined in ISO 19206-3:2021, "Road vehicles—Test devices for target vehicles, vulnerable road users and other objects, for assessment of active safety functions—Part 3: requirements for passenger vehicle 3D targets."

ISO is developing but has not published Standard 22733-2 describing tests for PAEB systems. SAE International has published recommended practice J3087, "Automatic emergency braking (AEB) system performance testing," defining the conditions for testing AEB and FCW systems. This standard defines test conditions, test targets, test scenarios, and measurement methods, but, like ISO 22733-1, does not provide performance criteria. Unlike ISO 22733-

1, SAE J3087 does not require specific speed ranges for test execution. Test scenarios are employed where the lead surrogate vehicle is stopped, moving at a constant slower speed, or decelerating, broadly similar to that proposed in this NPRM. SAE International Standard J3116, "Active Safety Pedestrian Test Mannequin Recommendation," provides recommendations for the characteristics of a surrogate that could be used in testing of active pedestrian safety systems, but there is no SAE International standard defining test procedures for PAEB systems.

International AEB Regulation

The United Nations (UN) Economic Commission for Europe (ECE) Regulation No. 152 "Uniform provisions concerning the approval of motor vehicles with regard to the Advanced Emergency Braking System (AEBS) for M1 and N1 vehicles,"²⁶³ provides definitions and standards for AEB Systems for signatory nations to the "1958 Agreement."²⁶⁴ Some signatories mandate the regulation and others accept it as "if-fitted." ECE Regulation No. 152 describes the timing of warnings, mode of warnings, required minimum deceleration, and allowable impact speeds for AEB tests for both stationary lead surrogate vehicles and lead surrogate vehicles moving at 20 km/h. Each test run is conducted "in absence of driver's input," (*i.e.*, testing CIB but not DBS). A "false reaction test" is also specified, where a vehicle must pass between two parked vehicles without issuing a warning or applying the brakes. AEB systems are required to operate between 10 km/h and 60 km/h, and cannot be deactivated at speeds above 10 km/h.

ECE Regulation No. 152 also describes requirements and test procedures for PAEB systems, including specification of minimum daylight lighting conditions (which match this NPRM) and surrogates. Test scenarios for PAEB systems include a test for a crossing test mannequin, and a false positive test where a test mannequin is parallel with and outside of the subject vehicle's

path, and the vehicle must not issue a warning or provide braking. Further specifications test for electrical failure and compliance with deactivation requirements (if equipped). A "car to bicycle" test and required standards are also specified, which our proposed regulation does not include.

For both the "car to car" and "car to pedestrian" tests, performance requirements are differentiated for M1 passenger vehicles and N1 goods carrying vehicles at different loaded masses and at different speeds; for some speed and weight combinations, collision avoidance is required. Starting at 38 km/h (24 mph), the standard specifies a maximum allowable impact speed; in contrast, our proposed regulation requires collision avoidance at up to 80 km/h (50 mph) without driver intervention. Up to 10 percent of test runs in any category can be failed and the system would still be given certification.

International AEB Consumer Testing

Internationally, several organizations also test vehicles' lead vehicle AEB systems to provide safety information to consumers. Euro NCAP, Australasian NCAP, and Korean NCAP each test lead vehicle AEB systems using scenarios similar to NHTSA's NCAP, where the lead vehicle test device is stationary, moving more slowly, or decelerating. ASEAN NCAP, China NCAP, and Japan NCAP each test vehicle lead vehicle AEB systems using stationary or slower-moving lead vehicle scenarios. Latin NCAP tests lead vehicle AEB systems using slower moving or decelerating lead vehicle scenarios. As discussed further in this notice, NHTSA will require collision avoidance over a range of subject vehicle test speeds; in contrast, Euro NCAP, Australasian NCAP, Korean NCAP, Chinese NCAP, and Japan NCAP each test AEB starting at 10 km/h and increase the speed during progressive test runs until the vehicle strikes the surrogate. There are no false positive tests, and points are awarded based on the speed at which the vehicle surrogate was struck.

Euro NCAP, China NCAP, Japan NCAP, and Korean NCAP each test PAEB systems in crossing path scenarios with a test mannequin. Euro NCAP and China NCAP further test PAEB systems for pedestrians walking parallel along the subject vehicle's forward path. Euro NCAP also tests PAEB systems for vehicles turning into a crossing test mannequin's path at an intersection. A variety of lighting conditions are used depending upon the scenario tested, with each organization conducting PAEB tests using daylight

²⁶³ As defined in the Addenda to the 1958 Agreement, inclusive of Amendments published Dec 21, 2021. <https://unece.org/transport/vehicle-regulations-wp29/standards/addenda-1958-agreement-regulations-141-160>.

²⁶⁴ United Nations Economic Commission for Europe. *Agreement concerning the Adoption of Harmonized Technical United Nations Regulations for Wheeled Vehicles, Equipment and Parts which can be Fitted and/or be Used on Wheeled Vehicles and the Conditions for Reciprocal Recognition of Approvals Granted on the Basis of these United Nations Regulations (Revision 3)*. (Original: 1958; Current, as amended: 20 Oct. 2017). <https://unece.org/trans/main/wp29/wp29regs>. The U.S. is not a signatory to the 1958 Agreement.

conditions, darkness conditions with streetlights, or darkness conditions without streetlights for at least one of their tests. There are no false positive tests, and for each test, the testing programs award points or provide a rating based on each vehicle's AEB performance.

Euro NCAP specifies the test mannequin in its "Articulated Pedestrian Target Specification Document,"²⁶⁵ which sets specifications for size, color, motion patterns, and detectability by vehicle sensors. China NCAP, Japan NCAP, and Korean NCAP use the same specifications, either by reference or substantially similar translation. These specifications are used by the test mannequin supplier to IIHS and NHTSA research.

List of Subjects

49 CFR Part 571

Imports, Incorporation by Reference, Motor vehicle safety, Motor vehicles, and Tires.

49 CFR Part 596

Automatic emergency braking, Incorporation by Reference, Motor vehicle safety, Test devices.

In consideration of the foregoing, NHTSA proposes to amend 49 CFR chapter V as follows:

PART 571—FEDERAL MOTOR VEHICLE SAFETY STANDARDS

■ 1. The authority citation for part 571 continues to read as follows:

Authority: 49 U.S.C. 322, 30111, 30115, 30117 and 30166; delegation of authority at 49 CFR 1.95.

■ 2. Amend § 571.5 by:

■ a. Revising paragraph (d)(34);
 ■ b. Redesignating paragraphs (l)(49) and (50) as paragraphs (l)(50) and (51), respectively; and

■ c. Adding new paragraph (l)(49).

The revisions and additions read as follows:

§ 571.5 Matter incorporated by reference.

* * * * *

(d) * * *

(34) ASTM E1337–19, "Standard Test Method for Determining Longitudinal Peak Braking Coefficient (PBC) of Paved Surfaces Using Standard Reference Test Tire," approved December 1, 2019, into §§ 571.105; 571.121; 571.122; 571.126; 571.127; 571.135; 571.136; 571.500.

* * * * *

²⁶⁵ European Automobile Manufacturers' Association (ACEA), February 2016, "Articulated Pedestrian Target Specification Document," Version 1.0. <https://www.acea.auto/publication/articulated-pedestrian-target-acea-specifications/>.

(l) * * *

(49) SAE J2400, "Human Factors in Forward Collision Warning System: Operating Characteristics and User Interface Requirements," August 2003 into § 571.127.

* * * * *

■ 3. Add § 571.127 to read as follows:

§ 571.127 Standard No. 127; Automatic emergency braking systems for light vehicles.

S1. *Scope.* This standard establishes performance requirements for automatic emergency braking (AEB) systems for light vehicles.

S2. *Purpose.* The purpose of this standard is to reduce the number of deaths and injuries that result from crashes in which drivers do not apply the brakes or fail to apply sufficient braking power to avoid or mitigate a crash.

S3. *Application.* This standard applies to passenger cars and to multipurpose passenger vehicles, trucks, and buses with a gross vehicle weight rating of 4,536 kilograms (10,000 pounds) or less.

S4. *Definitions.*

Adaptive cruise control system is an automatic speed control system that allows the equipped vehicle to follow a lead vehicle at a pre-selected gap by controlling the engine, power train, and service brakes.

Ambient illumination is the illumination as measured at the test surface, not including any illumination provided by the subject vehicle.

Automatic emergency braking (AEB) system is a system that detects an imminent collision with vehicles, objects, and road users in or near the path of a vehicle and automatically controls the vehicle's service brakes to avoid or mitigate the collision.

Brake pedal application onset is when 11 N of force has been applied to the brake pedal.

Forward collision warning is an auditory and visual warning provided to the vehicle operator by the AEB system that is designed to induce immediate forward crash avoidance response by the vehicle operator.

Forward collision warning onset is the first moment in time when a forward collision warning is provided.

Headway is the distance between the lead vehicle's rear-most plane normal to its centerline and the subject vehicle's frontmost plane normal to its centerline.

Lead vehicle is a vehicle test device facing the same direction and preceding a subject vehicle within the same travel lane.

Lead vehicle braking onset is the point at which the lead vehicle achieves

a deceleration of 0.05 g due to brake application.

Pedestrian test mannequin is a device used during AEB testing, when approaching pedestrians, meeting the specifications of subpart B of 49 CFR part 596.

Small-volume manufacturer means an original vehicle manufacturer that produces or assembles fewer than 5,000 vehicles annually for sale in the United States.

Steel trench plate is a rectangular steel plate often used in road construction to temporarily cover sections of pavement unsafe to drive over directly.

Subject vehicle is the vehicle under examination for compliance with this standard.

Travel path is the path projected onto the road surface of a point located at the intersection of the subject vehicle's frontmost vertical plane and longitudinal vertical center plane, as the subject vehicle travels forward.

Vehicle Test Device is a device meeting the specifications set forth in subpart C of 49 CFR part 596.

S5. *Requirements.*

(a) Except as provided in paragraphs (b) and (c) of this section S5, vehicles manufactured on or after [the first September 1 that is three years after publication of a final rule] must meet the requirements of this standard.

(b) The following lower-speed performance test requirements apply to vehicles manufactured on or after [the first September 1 that is three years after date of publication of a final rule] and before [the first September 1 that is four years after the date of publication of a final rule].

(1) For testing in the darkness condition using lower beam headlamps with an intended overlap of 50 percent, the subject vehicle test speed in S8.3.1(g) is any speed between 10 km/h and 40 km/h.

(2) For testing in the darkness condition using lower beam headlamps, the subject vehicle test speed in S8.4.1(e) is any speed between 10 km/h and 50 km/h.

(3) For testing in the darkness condition, the subject vehicle test speed in S8.5.1(f) is any speed between 10 km/h and 60 km/h.

(c) The requirements of paragraphs (a) and (b) of this section S5 do not apply to small-volume manufacturers, final-stage manufacturers and alterers until one year after the dates specified in those paragraphs.

S5.1. *Requirements when approaching a lead vehicle.*

S5.1.1. *Forward Collision Warning.* A vehicle is required to have a forward

collision warning system, as defined in S4 of this section, that provides an auditory and visual signal to the driver of an impending collision with a lead vehicle when traveling at any forward speed greater than 10 km/h (6.2 mph). The auditory signal must have a high fundamental frequency of at least 800 Hz, a duty cycle of 0.25–0.95, and tempo in the range of 6–12 pulses per second. The visual signal must be located according to SAE J2400 (incorporated by reference see § 571.5), paragraph 4.1.14 and must include the symbol in the bottom right of paragraph 4.1.16. Line of sight is based on the forward-looking eye midpoint (M_f) as described in S14.1.5. of § 571.111 of this part. The symbol must be red in color and steady-burning.

S5.1.2. Automatic Emergency Braking. A vehicle is required to have an automatic emergency braking system, as defined in S4 of this section, that applies the service brakes automatically when a collision with a lead vehicle is imminent. The system must operate when the vehicle is traveling at any forward speed greater than 10 km/h (6.2 mph).

S5.1.3. Performance Test Requirements. The vehicle must provide a forward collision warning and subsequently apply the service brakes automatically when a collision with a lead vehicle is imminent such that the subject vehicle does not collide with the lead vehicle when tested using the procedures in S7 under the conditions specified in S6. The forward collision warning is not required if adaptive cruise control is engaged.

S5.2. Requirements when approaching pedestrians.

S5.2.1. Forward Collision Warning. A vehicle is required to have a forward collision warning system, as defined in S4 of this section, that provides an auditory and visual signal to the driver of an impending collision with a pedestrian. The auditory signal must have a high fundamental frequency of at least 800 Hz, a duty cycle of 0.25–0.95, and tempo in the range of 6–12 pulses per second. The visual signal must be located according to SAE J2400, (incorporated by reference see § 571.5), paragraph 4.1.14 and must include the crash icon in the bottom right of paragraph 4.1.16. Line of sight is based on the forward-looking eye midpoint (M_f) as described in S14.1.5. of § 571.111. The symbol must be red in color and steady burning. The system must operate at any forward speed greater than 10 km/h (6.2 mph).

S5.2.2. Automatic Emergency Braking. A vehicle is required to have an automatic emergency braking system, as

defined in S4 of this section, that applies the service brakes automatically when a collision with a pedestrian is imminent when the vehicle is traveling at any forward speed greater than 10 km/h (6.2 mph).

S5.2.3. Performance Test Requirements. The vehicle must automatically apply the brakes and alert the vehicle operator such that the subject vehicle does not collide with the pedestrian test mannequin when tested using the procedures in S8 under the conditions specified in S6.

S5.3. False Activation. The vehicle must not automatically apply braking that results in peak additional deceleration that exceeds what manual braking would produce by 0.25g or greater, when tested using the procedures in S9 under the conditions specified in S6.

S5.4. Malfunction Detection. The system must continuously detect system malfunctions, including malfunctions caused solely by sensor obstructions. If the system detects a malfunction that prevents the system from meeting the requirements specified in S5.1, S5.2, or S5.3, the system must provide the vehicle operator with a telltale notification that the malfunction exists.

S6. Test Conditions.

S6.1. Environmental conditions.

S6.1.1. Temperature. The ambient temperature is any temperature between 0 °C and 40 °C.

S6.1.2. Wind. The maximum wind speed is no greater than 10 m/s (22 mph) during lead vehicle avoidance tests and 6.7 m/s (15 mph) during pedestrian avoidance tests.

S6.1.3. Ambient Lighting.

(a) *Daylight testing.*

(1) The ambient illumination on the test surface is any level at or above 2,000 lux.

(2) Testing is not performed while driving toward or away from the sun such that the horizontal angle between the sun and a vertical plane containing the centerline of the subject vehicle is less than 25 degrees and the solar elevation angle is less than 15 degrees.

(b) *Dark testing.*

(1) The ambient illumination on the test surface is any level at or below 0.2 lux.

(2) Testing is performed under any lunar phase.

(3) Testing is not performed while driving toward the moon such that the horizontal angle between the moon and a vertical plane containing the centerline of the subject vehicle is less than 25 degrees and the lunar elevation angle is less than 15 degrees.

S6.1.4. Precipitation. Testing is not conducted during periods of

precipitation or when visibility is affected by fog, smoke, ash, or other particulate.

S6.2. Road conditions.

S6.2.1. Test Track Surface and Construction. The tests are conducted on a dry, uniform, solid-paved surface. Surfaces with debris, irregularities, or undulations, such as loose pavement, large cracks, or dips are not used.

S6.2.2. Surface Friction. The road test surface produces a peak friction coefficient (PFC) of 1.02 when measured using an American Society for Testing and Materials (ASTM) F2493 standard reference test tire, in accordance with ASTM E1337–19 (incorporated by reference, see § 571.5), at a speed of 64 km/h (40 mph), without water delivery.

S6.2.3. Slope. The test surface has any consistent slope between 0 percent and 1 percent.

S6.2.4. Markings. The road surface within 2 m of the intended travel path is marked with zero, one, or two lines of any configuration or color. If one line is used, it is straight. If two lines are used, they are straight, parallel to each other, and at any distance from 2.7 m to 4.5 m apart.

S6.2.5. Obstructions. Testing is conducted such that the vehicle does not travel beneath any overhead structures, including but not limited to overhead signs, bridges, or gantries. No vehicles, obstructions, or stationary objects are within 7.4 m of either side of the intended travel path except as specified.

S6.3. Subject vehicle conditions.

S6.3.1. Malfunction notification.

Testing is not conducted while the AEB malfunction telltale specified in S5.4 is illuminated.

S6.3.2. Sensor obstruction. All sensors used by the system and any part of the vehicle immediately ahead of the sensors, such as plastic trim, the windshield, etc., are free of debris or obstructions.

S6.3.3. Tires. The vehicle is equipped with the original tires present at the time of initial sale. The tires are inflated to the vehicle manufacturer's recommended cold tire inflation pressure(s) specified on the vehicle's placard or the tire inflation pressure label.

S6.3.4. Brake burnish.

(a) Vehicles subject to § 571.105 are burnished in accordance with S7.4 of that section.

(b) Vehicles subject to § 571.135 are burnished in accordance with S7.1 of that section.

S6.3.5. Brake temperature. The average temperature of the service brakes on the hottest axle of the vehicle during testing, measured according to

S6.4.1 of § 571.135, is between 65 °C and 100.°C prior to braking.

S6.3.6. *Fluids.* All non-consumable fluids for the vehicle are at 100 percent capacity. All consumable fluids are at any level from 5 to 100 percent capacity.

S6.3.7. *Propulsion battery charge.* The propulsion batteries are charged at any level from 5 to 100 percent capacity.

S6.3.8. *Cruise control.* Cruise control, including adaptive cruise control, is configured under any available setting.

S6.3.9. *Adjustable forward collision warning.* Forward collision warning is configured in any operator-configurable setting.

S6.3.10. *Engine braking.* A vehicle equipped with an engine braking system that is engaged and disengaged by the operator is tested with the system in any selectable configuration.

S6.3.11. *Regenerative braking.* Regenerative braking is configured under any available setting.

S6.3.12. *Headlamps.*

(a) Daylight testing is conducted with the headlamp control in any selectable position.

(b) Darkness testing is conducted with the vehicle's lower beams or upper beams active.

(c) Prior to performing darkness testing, headlamps are aimed according to the vehicle manufacturer's instructions. The weight of the loaded

vehicle at the time of headlamp aiming is within 10 kg of the weight of the loaded vehicle during testing.

S6.3.13. *Subject vehicle loading.* The vehicle load, which is the sum of any vehicle occupants and any test equipment and instrumentation, does not exceed 277 kg. The load does not cause the vehicle to exceed its GVWR or any axle to exceed its GAWR.

S6.3.14. *AEB system initialization.* The vehicle is driven at a speed of 10 km/h or higher for at least one minute prior to testing, and subsequently the starting system is not cycled off prior to testing.

S6.4. *Equipment and Test Devices.*

S6.4.1. The vehicle test device is specified in 49 CFR part 596 subpart C. Local fluttering of the lead vehicle's external surfaces does not exceed 10 mm perpendicularly from the reference surface, and distortion of the lead vehicle's overall shape does not exceed 25 mm in any direction.

S6.4.2. Adult Pedestrian Test Mannequin is specified in 49 CFR part 596 subpart B.

S6.4.3. Child Pedestrian Test Mannequin is specified in 49 CFR part 596 subpart B.

S6.4.4. The steel trench plate used for the false activation test has the dimensions 2.4 m x 3.7 m x 25 mm and

is made of ASTM A36 steel. Any metallic fasteners used to secure the steel trench plate are flush with the top surface of the steel trench plate.

S7. *Testing when approaching a lead vehicle.*

S7.1. *Setup.*

(a) The testing area is set up in accordance with Figure 2.

(b) Testing is conducted during daylight.

(c) For reference, Table 1 to S7.1 specifies the subject vehicle speed (V_{SV}), lead vehicle speed (V_{LV}), headway, and lead vehicle deceleration for each test that may be conducted.

(d) The intended travel path of the vehicle is a straight line toward the lead vehicle from the location corresponding to a headway of L_0 .

(e) If the road surface is marked with a single or double lane line, the intended travel path is parallel to and 1.8 m from the inside of the closest line. If the road surface is marked with two lane lines bordering the lane, the intended travel path is centered between the two lines.

(f) For each test run conducted, the subject vehicle speed (V_{SV}), lead vehicle speed (V_{LV}), headway, and lead vehicle deceleration will be selected from the ranges specified.

TABLE 1 TO S7.1—TEST PARAMETERS WHEN APPROACHING A LEAD VEHICLE

	Speed (km/hr)		Headway (m)	Lead vehicle decel (g)	Manual brake application
	V_{SV}	V_{LV}			
Stopped Lead Vehicle	Any 10–80	0	No.
	Any 70–100	0	Yes.
Slower Lead Vehicle	Any 40–80	20	No.
	Any 70–100	20	Yes.
Decelerating Lead Vehicle	50	50	Any 12–40	Any 0.3–0.5	No.
	50	50	Any 12–40	Any 0.3–0.5	Yes.
	80	80	Any 12–40	Any 0.3–0.5	No.
	80	80	Any 12–40	Any 0.3–0.5	Yes.

S7.2. *Headway calculation.* For each test run conducted under S7.3 and S7.4, the headway (L_0), in meters, providing 5 seconds time to collision (TTC) is calculated. L_0 is determined with the following equation where V_{SV} is the speed of the subject vehicle in m/s and V_{LV} is the speed of the lead vehicle in m/s:

$$L_0 = TTC_0 \times (V_{SV} - V_{LV})$$

$$TTC_0 = 5$$

S7.3. *Stopped lead vehicle.*

S7.3.1. *Test parameters.*

(a) For testing with no subject vehicle manual brake application, the subject vehicle test speed is any speed between 10 km/h and 80 km/h, and the lead vehicle speed is 0 km/h.

(b) For testing with manual brake application of the subject vehicle, the subject vehicle test speed is any speed between 70 km/h and 100 km/h, and the lead vehicle speed is 0 km/h.

S7.3.2. *Test conduct prior to forward collision warning onset.*

(a) The lead vehicle is placed stationary with its longitudinal centerline coincident to the intended travel path.

(b) Before the headway corresponds to L_0 , the subject vehicle is driven at any speed, in any direction, on any road surface, for any amount of time.

(c) The subject vehicle approaches the rear of the lead vehicle.

(d) Beginning when the headway corresponds to L_0 , the subject vehicle

speed is maintained within 1.6 km/h of the test speed with minimal and smooth accelerator pedal inputs.

(e) Beginning when the headway corresponds to L_0 , the subject vehicle heading is maintained with minimal steering input such that the travel path does not deviate more than 0.3 m laterally from the intended travel path and the subject vehicle's yaw rate does not exceed ± 1.0 deg/s.

S7.3.3. *Test conduct after forward collision warning onset.*

(a) The accelerator pedal is released at any rate such that it is fully released within 500 ms. This action is omitted for vehicles tested with cruise control active.

(b) For testing conducted with manual brake application, the service brakes are applied as specified in S10. The onset of brake pedal application occurs 1.0 ±0.1 second after forward collision warning onset.

(c) For testing conducted without manual brake application, no manual brake application is made until the test completion criteria of S7.3.4 are satisfied.

S7.3.4. *Test completion criteria.* The test run is complete when the subject vehicle comes to a complete stop without making contact with the lead vehicle or when the subject vehicle makes contact with the lead vehicle.

S7.4. *Slower-moving lead vehicle.*

S7.4.1. *Test parameters.*

(a) For testing with no subject vehicle manual brake application, the subject vehicle test speed is any speed between 40 km/h and 80 km/h, and the lead vehicle speed is 20 km/h.

(b) For testing with manual brake application of the subject vehicle, the subject vehicle test speed is any speed between 70 km/h and 100 km/h, and the lead vehicle speed is 20 km/h.

S7.4.2. *Test conduct prior to forward collision warning onset.*

(a) The lead vehicle is propelled forward in a manner such that the longitudinal center plane of the lead vehicle does not deviate laterally more than 0.3m from the intended travel path.

(b) The subject vehicle approaches the lead vehicle.

(c) Beginning when the headway corresponds to L₀, the subject vehicle and lead vehicle speed is maintained within 1.6 km/h of the test speed with minimal and smooth accelerator pedal inputs.

(d) Beginning when the headway corresponds to L₀, the subject vehicle and lead vehicle headings are be maintained with minimal steering input such that the subject vehicle's travel path does not deviate more than 0.3 m laterally from the centerline of the lead vehicle, and the yaw rate of the subject vehicle does not exceed ±1.0 deg/s prior to the forward collision warning onset.

S7.4.3. *Test conduct after forward collision warning onset.*

(a) The subject vehicle's accelerator pedal is released at any rate such that it is fully released within 500 ms. This action is omitted for vehicles tested with cruise control active.

(b) For testing conducted with manual braking application, the service brakes are applied as specified in S10. The onset of brake pedal application is 1.0 ±0.1 second after the forward collision warning onset.

(c) For testing conducted without manual braking application, no manual brake application is made until the test completion criteria of S7.4.4 are satisfied.

S7.4.4. *Test completion criteria.* The test run is complete when the subject vehicle speed is less than or equal to the lead vehicle speed without making contact with the lead vehicle or when the subject vehicle makes contact with the lead vehicle.

S7.5. *Decelerating lead vehicle.*

S7.5.1. *Test parameters.*

(a) The subject vehicle test speed is 50 km/h or 80 km/h, and the lead vehicle speed is identical to the subject vehicle test speed.

(b) [Reserved]

S7.5.2. *Test conduct prior to lead vehicle braking onset.*

(a) Before the 3 seconds prior to lead vehicle braking onset, the subject vehicle is be driven at any speed, in any direction, on any road surface, for any amount of time.

(b) Between 3 seconds prior to lead vehicle braking onset and lead vehicle braking onset:

(1) The lead vehicle is propelled forward in a manner such that the longitudinal center plane of the vehicle does not deviate laterally more than 0.3 m from the intended travel path.

(2) The subject vehicle follows the lead vehicle at a headway of any distance between 12 m and 40 m.

(3) The subject vehicle's speed is maintained within 1.6 km/h of the test speed with minimal and smooth accelerator pedal inputs prior to forward collision warning onset.

(4) The lead vehicle's speed is maintained within 1.6 km/h.

(5) The subject vehicle and lead vehicle headings are maintained with minimal steering input such that their travel paths do not deviate more than 0.3 m laterally from the centerline of the lead vehicle, and the yaw rate of the subject vehicle does not exceed ±1.0 deg/s until onset of forward collision warning.

S7.5.3. *Test conduct following lead vehicle braking onset.*

(a) The lead vehicle is decelerated to a stop with a targeted average deceleration of any value between 0.3g and 0.5g. The targeted deceleration magnitude is achieved within 1.5 seconds of lead vehicle braking onset and is maintained until 250 ms prior to coming to a stop.

(b) After forward collision warning onset, the subject vehicle's accelerator pedal is released at any rate such that it is fully released within 500 ms. This action is omitted for vehicles with cruise control active.

(c) For testing conducted with manual braking application, the service brakes are applied as specified in S10. The brake pedal application onset occurs 1.0 ±0.1 second after the forward collision warning onset.

(d) For testing conducted without manual braking application, no manual brake application is made until the test completion criteria of S7.5.4 are satisfied.

S7.5.4. *Test completion criteria.* The test run is complete when the subject vehicle comes to a complete stop without making contact with the lead vehicle or when the subject vehicle makes contact with the lead vehicle.

S8. *Testing when approaching a pedestrian.*

S8.1. *Setup.*

S8.1.1. *General.*

(a) For reference, Table 2 to S8.1.1 specifies the subject vehicle speed (V_{SV}), the pedestrian test mannequin speed (V_P), the overlap of the pedestrian test mannequin, and the lighting condition for each test that may be conducted.

(b) The intended travel path of the vehicle is a straight line originating at the location corresponding to a headway of L₀.

(c) If the road surface is marked with a single or double lane line, the intended travel path is parallel to and 1.8 m from the inside of the closest line. If the road surface is marked with two lane lines bordering the lane, the intended travel path is centered between the two lines.

(d) For each test run conducted, the subject vehicle speed (V_{SV}) will be selected from the range specified.

TABLE 2 TO S8.1.1—TEST PARAMETERS WHEN APPROACHING A PEDESTRIAN

	Direction	Overlap (%)	Obstructed	Speed (km/h)		Lighting condition
				V _{SV}	V _P	
Crossing Path	Right	25	No	Any 10–60	5	Daylight. Daylight.
	Right	50	No	Any 10–60		

TABLE 2 TO S8.1.1—TEST PARAMETERS WHEN APPROACHING A PEDESTRIAN—Continued

	Direction	Overlap (%)	Obstructed	Speed (km/h)		Lighting condition
				V _{SV}	V _P	
Stationary	Right	50	No	Any 10–60*	8	Lower Beams.
	Right	50	No	Any 10–60		Upper Beams.
	Right	50	Yes	Any 10–50		Daylight.
	Left	50	No	Any 10–60		Daylight.
	Right	25	No	Any 10–55		Daylight.
Along-Path	Right	25	No	Any 10–55*	5	Lower Beams.
				Any 10–55		Upper Beams.
				Any 10–65		Daylight.
				Any 10–65*		Lower Beams.
				Any 10–65*		Upper Beams.

* Lower speed performance test requirements apply prior to [the first September 1 that is four years after publication of a final rule]. See S5(b).

S8.1.2. *Overlap.* As depicted in Figure 1 to this section, overlap describes the location of the point on the front of the subject vehicle that would make contact with a pedestrian if no braking occurred. Overlap is the percentage of the subject vehicle’s overall width that the pedestrian test mannequin traverses. It is measured from the right or the left, depending on the side of the subject vehicle where the pedestrian test mannequin originates. For each test run, the actual overlap will be within 0.15 m of the specified overlap.

S8.1.3. *Pedestrian Test Mannequin.*

(a) For testing where the pedestrian test mannequin is secured to a moving apparatus, the pedestrian test mannequin is secured so that it faces the direction of motion. The pedestrian test mannequin leg articulation starts on apparatus movement and stops when the apparatus stops.

(b) For testing where the pedestrian test mannequin is stationary, the pedestrian test mannequin faces away from the subject vehicle, and the pedestrian test mannequin legs remain still.

S8.2. *Headway calculation.* For each test run conducted under S8.3, S8.4, and S8.5, the headway (L_0), in meters, between the front plane of the subject vehicle and a parallel contact plane on the pedestrian test mannequin providing 4.0 seconds time to collision (TTC) is calculated. L_0 is determined with the following equation where V_{SV} is the speed of the subject vehicle in m/s and V_{P-y} is the component of speed of the pedestrian test mannequin in m/s in the direction of the intended travel path:
 $L_0 = TTC_0 \times (V_{SV} - V_{P-y})$
 $TTC_0 = 4.0$

S8.3. *Pedestrian crossing road.*

S8.3.1. *Test parameters and setup (unobstructed from right).*

(a) The testing area is set up in accordance with Figure 3 to this section.

(b) Testing is conducted in the daylight or darkness conditions, except

that testing with the pedestrian at the 25 percent overlap is only conducted in daylight conditions.

(c) Testing is conducted using the adult pedestrian test mannequin.

(d) The movement of the pedestrian test mannequin is perpendicular to the subject vehicle’s intended travel path.

(e) The pedestrian test mannequin is set up 4.0 ±0.1 m to the right of the intended travel path.

(f) The intended overlap is 25 percent from the right or 50 percent.

(g) The subject vehicle test speed is any speed between 10 km/h and 60 km/h.

(h) The pedestrian test mannequin speed is 5 km/h.

S8.3.2. *Test parameters and setup (unobstructed from left).*

(a) The testing area is set up in accordance with Figure 4 to this section.

(b) Testing is conducted in the daylight condition.

(c) Testing is conducted using the adult pedestrian mannequin.

(d) The movement of the pedestrian test mannequin is perpendicular to the intended travel path.

(e) The pedestrian test mannequin is set up 6.0 ±0.1 m to the left of the intended travel path.

(f) The intended overlap is 50 percent.

(g) The subject vehicle test speed is any speed between 10 km/h and 60 km/h.

(h) The pedestrian test mannequin speed is 8 km/h.

S8.3.3. *Test parameters and setup (obstructed).*

(a) The testing area is set up in accordance with Figure 5 to this section.

(b) Testing is conducted in the daylight condition.

(c) Testing is conducted using the child pedestrian test mannequin.

(d) The movement of the pedestrian test mannequin is perpendicular to the intended travel path.

(e) The pedestrian test mannequin is set up 4.0 ±0.1 m to the right of the intended travel path.

(f) The intended overlap is 50 percent.

(g) Two vehicle test devices are secured in stationary positions parallel to the intended travel path. The two vehicle test devices face the same direction as the intended travel path. One vehicle test device is directly behind the other separated by 1.0 ±0.1 m. The left side of each vehicle test device is 1.0 ±0.1 m to the right of the vertical plane parallel to the intended travel path and tangent with the right outermost point of the subject vehicle when the subject vehicle is in the intended travel path.

(h) The subject vehicle test speed is any speed between 10 km/h and 50 km/h.

(i) The pedestrian test mannequin speed is 5 km/h.

S8.3.4. *Test conduct prior to forward collision warning or vehicle braking onset.*

(a) The subject vehicle approaches the crossing path of the pedestrian test mannequin.

(b) Beginning when the headway corresponds to L_0 , the subject vehicle speed is maintained within 1.6 km/h of the test speed with minimal and smooth accelerator pedal inputs.

(c) Beginning when the headway corresponds to L_0 , the subject vehicle heading is maintained with minimal steering inputs such that the subject vehicle’s travel path does not deviate more than 0.3 m laterally from the intended travel path, and the yaw rate of the subject vehicle does not exceed ±1.0 deg/s prior to any automated braking onset.

(d) The pedestrian test mannequin apparatus is triggered at a time such that the pedestrian test mannequin meets the intended overlap, subject to the criteria in S8.1.2. The pedestrian test mannequin achieves its intended speed within 1.5 m after the apparatus begins to move and maintains its intended speed within 0.4 km/h until the test

completion criteria of S8.3.6 are satisfied.

S8.3.5. *Test conduct after either forward collision warning or vehicle braking onset.*

(a) After forward collision warning or vehicle braking onset, the subject vehicle's accelerator pedal is released at any rate such that it is fully released within 500 ms. This action is omitted for vehicles with cruise control active.

(b) No manual brake application is made until the test completion criteria of S8.3.6 are satisfied.

(c) The pedestrian mannequin continues to move until the completion criteria of S8.3.6 are satisfied.

S8.3.6. *Test completion criteria.* The test run is complete when the subject vehicle comes to a complete stop without making contact with the pedestrian test mannequin, when the pedestrian test mannequin is no longer in the path of the subject vehicle, or when the subject vehicle makes contact with the pedestrian test mannequin.

S8.4. *Stationary pedestrian.*

S8.4.1. *Test parameters and setup.*

(a) The testing area is set up in accordance with Figure 6 to this section.

(b) Testing is conducted in the daylight or darkness conditions.

(c) Testing is conducted using the adult pedestrian test mannequin.

(d) The pedestrian mannequin is set up at the 25 percent right overlap position facing away from the approaching vehicle.

(e) The subject vehicle test speed is any speed between 10 km/h and 55 km/h.

(f) The pedestrian mannequin is stationary.

S8.4.2. *Test conduct prior to forward collision warning or vehicle braking onset.*

(a) The subject vehicle approaches the pedestrian test mannequin.

(b) Beginning when the headway corresponds to L_0 , the subject vehicle speed is maintained within 1.6 km/h of the test speed with minimal and smooth accelerator pedal inputs.

(c) Beginning when the headway corresponds to L_0 , the subject vehicle heading is maintained with minimal steering inputs such that the subject vehicle's travel path does not deviate more than 0.3 m laterally from the intended travel path, and the yaw rate of the subject vehicle does not exceed ± 1.0 deg/s prior to any automated braking onset.

S8.4.3. *Test conduct after either forward collision warning or vehicle braking onset.*

(a) After forward collision warning or vehicle braking onset, the subject vehicle's accelerator pedal is released at

any rate such that it is fully released within 500 ms. This action is omitted with vehicles with cruise control active.

(b) No manual brake application is made until the test completion criteria of S8.4.4 are satisfied.

S8.4.4. *Test completion criteria.* The test run is complete when the subject vehicle comes to a complete stop without making contact with the pedestrian test mannequin, or when the subject vehicle makes contact with the pedestrian test mannequin.

S8.5. *Pedestrian moving along the path*

S8.5.1. *Test parameters and setup.*

(a) The testing area is set up in accordance with Figure 7 to this section.

(b) Testing is conducted in the daylight or darkness conditions.

(c) Testing is conducted using the adult pedestrian test mannequin.

(d) The movement of the pedestrian test mannequin is parallel to and in the same direction as the subject vehicle.

(e) The pedestrian test mannequin is set up in the 25 percent right offset position.

(f) The subject vehicle test speed is any speed between 10 km/h and 65 km/h.

(g) The pedestrian test mannequin speed is 5 km/h.

S8.5.2. *Test conduct prior to forward collision warning or vehicle braking onset.*

(a) The subject vehicle approaches the pedestrian test mannequin.

(b) Beginning when the headway corresponds to L_0 , the subject vehicle speed is maintained within 1.6 km/h of the test speed with minimal and smooth accelerator pedal inputs.

(c) Beginning when the headway corresponds to L_0 , the subject vehicle heading is maintained with minimal steering inputs such that the travel path does not deviate more than 0.3 m laterally from the intended travel path, and the yaw rate of the subject vehicle does not exceed ± 1.0 deg/s prior to any automated braking onset.

(d) The pedestrian test mannequin apparatus is triggered any time after the distance between the front plane of the subject vehicle and a parallel contact plane on the pedestrian test mannequin corresponds to L_0 . The pedestrian test mannequin achieves its intended speed within 1.5 m after the apparatus begins to move and maintains its intended speed within 0.4 km/h until the test completion criteria of S8.5.4 are satisfied.

S8.5.3. *Test conduct after either forward collision warning or vehicle braking onset.*

(a) After forward collision warning or vehicle braking onset, the subject

vehicle's accelerator pedal is released at any rate such that it is fully released within 500 ms. This action is omitted for vehicles with cruise control active.

(b) No manual brake application is made until the test completion criteria of S8.5.4 are satisfied.

S8.5.4. *Test completion criteria.* The test run is complete when the subject vehicle slows to speed below the pedestrian test mannequin travel speed without making contact with the pedestrian test mannequin or when the subject vehicle makes contact with the pedestrian test mannequin.

S9. *False AEB activation.*

S9.1. *Headway calculation.* For each test run to be conducted under S9.2 and S9.3, the headway (L_0 , $L_{2,1}$, $L_{1,1}$), in meters, between the front plane of the subject vehicle and either the steel trench plate's leading edge or the rearmost plane normal to the centerline of the vehicle test devices providing 5.0 seconds, 2.1 seconds, and 1.1 seconds time to collision (TTC) is calculated. L_0 , $L_{2,1}$, and $L_{1,1}$ are determined with the following equation where V_{SV} is the speed of the subject vehicle in m/s:

$$L_x = TTC_x \times (V_{SV})$$

$$TTC_0 = 5.0$$

$$TTC_{2,1} = 2.1$$

$$TTC_{1,1} = 1.1$$

S9.2. *Steel trench plate.*

S9.2.1. *Test parameters and setup.*

(a) The testing area is set up in accordance with Figure 8.

(b) The steel trench plate is secured flat on the test surface so that its longest side is parallel to the vehicle's intended travel path and horizontally centered on the vehicle's intended travel path.

(c) The subject vehicle test speed is 80 km/h.

(d) Testing may be conducted with manual brake application.

S9.2.2. *Test conduct.*

(a) The subject vehicle approaches the steel trench plate.

(b) Beginning when the headway corresponds to L_0 , the subject vehicle speed is maintained within 1.6 km/h of the test speed with minimal and smooth accelerator pedal inputs.

(c) Beginning when the headway corresponds to L_0 , the subject vehicle heading is maintained with minimal steering input such that the travel path does not deviate more than 0.3 m laterally from the intended travel path, and the yaw rate of the subject vehicle does not exceed ± 1.0 deg/s.

(d) If forward collision warning occurs, the subject vehicle's accelerator pedal is released at any rate such that it is fully released within 500 ms. This action is omitted for vehicles with cruise control active.

(e) For tests where no manual brake application occurs, manual braking is not applied until the test completion criteria of S9.2.3 are satisfied.

(f) For tests where manual brake application occurs, the subject vehicle's accelerator pedal, if not already released, is released when the headway corresponds to $L_{2,1}$ at any rate such that it is fully released within 500 ms.

(g) For tests where manual brake application occurs, the service brakes are applied as specified in S10. The brake application pedal onset occurs at headway $L_{1,1}$.

S9.2.3. *Test completion criteria.* The test run is complete when the subject vehicle comes to a stop prior to crossing over the leading edge of the steel trench plate or when the subject vehicle crosses over the leading edge of the steel trench plate.

S9.3. *Pass-through.*

S9.3.1. *Test parameters and setup.*

(a) The testing area is set up in accordance with Figure 9.

(b) Two vehicle test devices are secured in a stationary position parallel to one another with a lateral distance of 4.5 m \pm 0.1 m between the vehicles' closest front wheels. The centerline between the two vehicles is parallel to the intended travel path.

(c) The subject vehicle test speed is 80 km/h.

(d) Testing may be conducted with manual subject vehicle pedal application.

S9.3.2. *Test conduct.*

(a) The subject vehicle approaches the gap between the two vehicle test devices.

(b) Beginning when the headway corresponds to L_0 , the subject vehicle speed is maintained within 1.6 km/h with minimal and smooth accelerator pedal inputs.

(c) Beginning when the headway corresponds to L_0 , the subject vehicle heading is maintained with minimal steering input such that the travel path does not deviate more than 0.3 m laterally from the intended travel path,

and the yaw rate of the subject vehicle does not exceed ± 1.0 deg/s.

(d) If forward collision warning occurs, the subject vehicle's accelerator pedal is released at any rate such that it is fully released within 500 ms.

(e) For tests where no manual brake application occurs, manual braking is not applied until the test completion criteria of S9.3.3 are satisfied.

(f) For tests where manual brake application occurs, the subject vehicle's accelerator pedal, if not already released, is released when the headway corresponds to $L_{2,1}$ at any rate such that it is fully released within 500 ms.

(g) For tests where manual brake application occurs, the service brakes are applied as specified in S10. The brake application onset occurs when the headway corresponds to $L_{1,1}$.

S9.3.3. *Test completion criteria.* The test run is complete when the subject vehicle comes to a stop prior to its rearmost point passing the vertical plane connecting the forwardmost point of the vehicle test devices or when the rearmost point of the subject vehicle passes the vertical plane connecting the forwardmost point of the vehicle test devices.

S10. *Subject Vehicle Brake Application Procedure.*

S10.1. The procedure begins with the subject vehicle brake pedal in its natural resting position with no preload or position offset.

S10.2. At the option of the manufacturer, either displacement feedback or hybrid feedback control is used.

S10.3. *Displacement feedback procedure.* For displacement feedback, the commanded brake pedal position is the brake pedal position that results in a mean deceleration of 0.4g in the absence of AEB system activation.

(a) The mean deceleration is the deceleration over the time from the pedal achieving the commanded position to 250 ms before the vehicle comes to a stop.

(b) The pedal displacement controller depresses the pedal at a rate of 254 mm/s \pm 25.4 mm/s to the commanded brake pedal position.

(c) The pedal displacement controller may overshoot the commanded position by any amount up to 20 percent. If such an overshoot occurs, it is corrected within 100 ms.

(d) The achieved brake pedal position is any position within 10 percent of the commanded position from 100 ms after pedal displacement occurs and any overshoot is corrected.

S10.4. *Hybrid brake pedal feedback procedure.* For hybrid brake pedal feedback, the commanded brake pedal application is the brake pedal position and a subsequent commanded brake pedal force that results in a mean deceleration of 0.4g in the absence of AEB system activation.

(a) The mean deceleration is the deceleration over the time from the pedal achieving the commanded position to 250 ms before the vehicle comes to a stop.

(b) The hybrid controller displaces the pedal at a rate of 254 mm/s \pm 25.4 mm/s to the commanded pedal position.

(c) The hybrid controller may overshoot the commanded position by any amount up to 20 percent. If such an overshoot occurs, it is corrected within 100 ms.

(d) The hybrid controller begins to control the force applied to the pedal and stops controlling pedal displacement 100 ms after pedal displacement occurs and any overshoot is corrected.

(e) The hybrid controller applies a pedal force of at least 11.1 N.

(f) The applied pedal force is maintained within 10 percent of the commanded brake pedal force from 350 ms after commanded pedal displacement occurs and any overshoot is corrected until test completion.

Figure 1 to § 571.127—Percentage Overlap Nomenclature

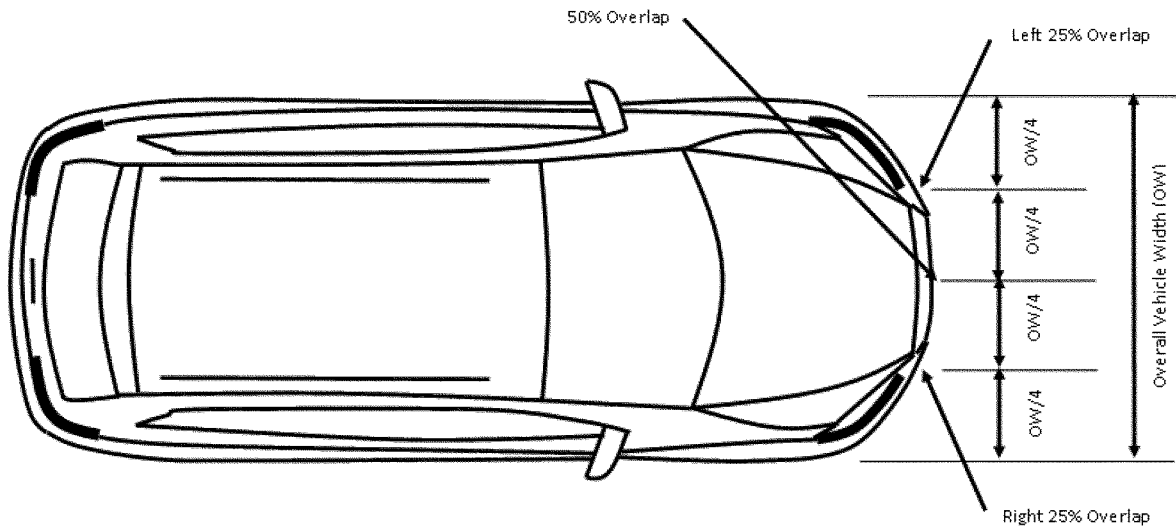

Figure 2 to § 571.127—Setup for Lead Vehicle Automatic Emergency Braking

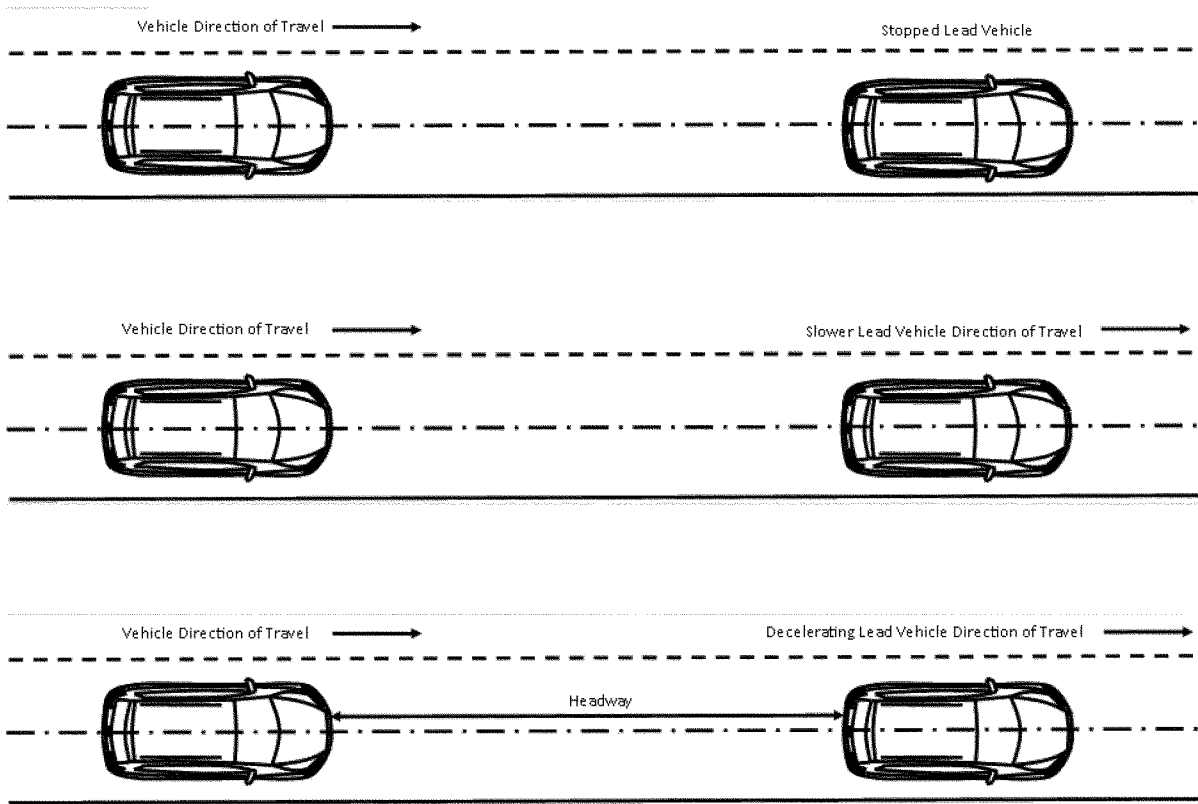

Figure 3 to § 571.127—Setup for Pedestrian, Crossing Path, Right

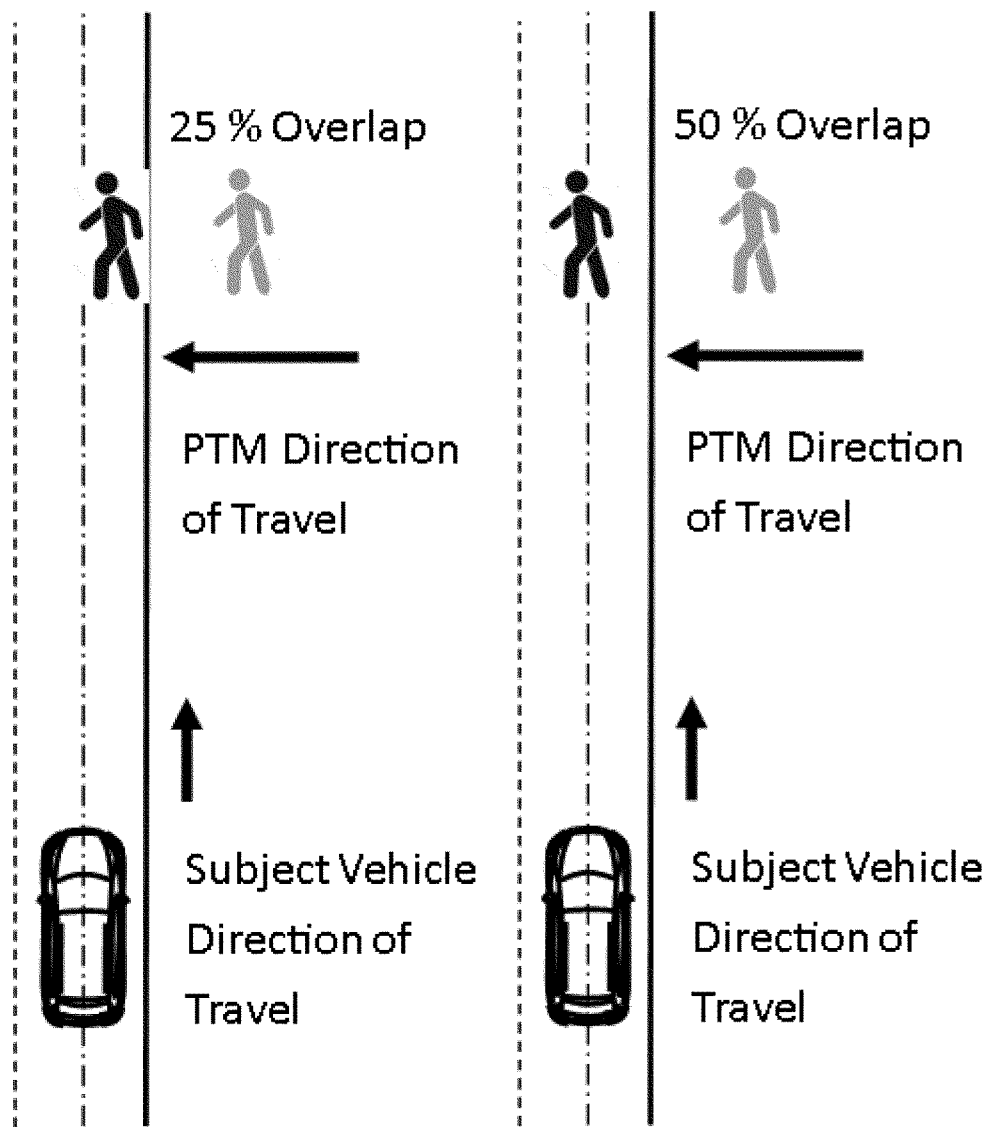

Figure 4 to § 571.127—Setup for Pedestrian, Crossing Path, Left

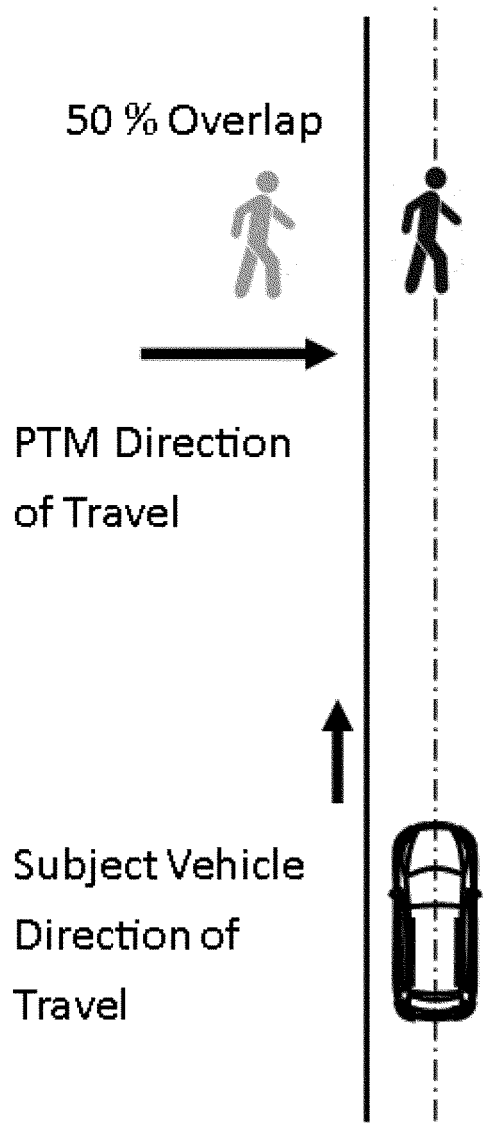

Figure 5 to § 571.127—Setup for Pedestrian, Obstructed

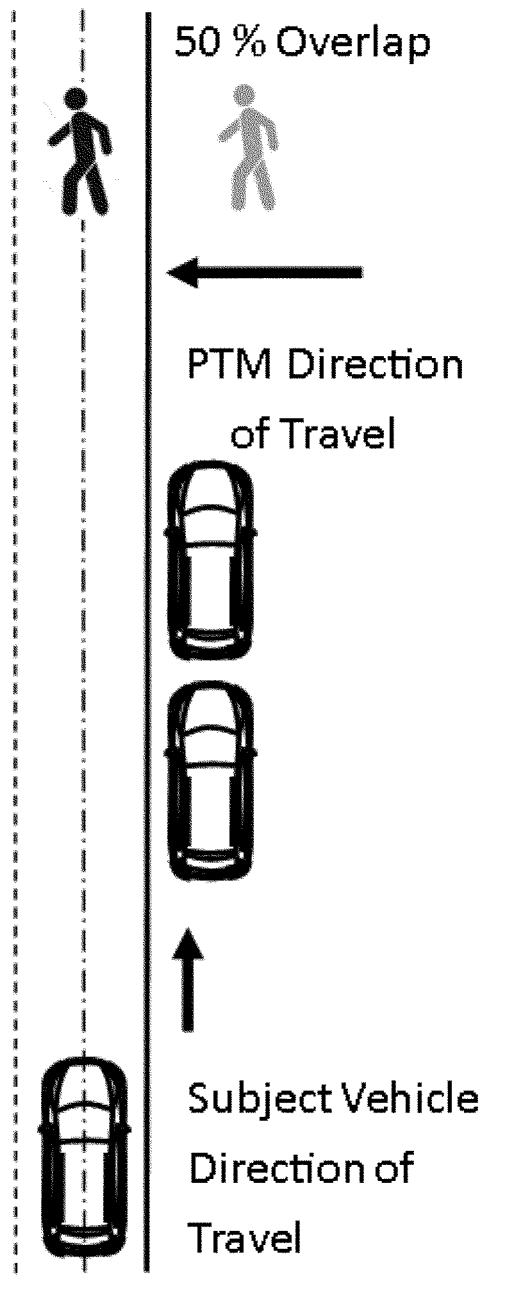

Figure 6 to § 571.127—Setup for Pedestrian Along-Path Stationary

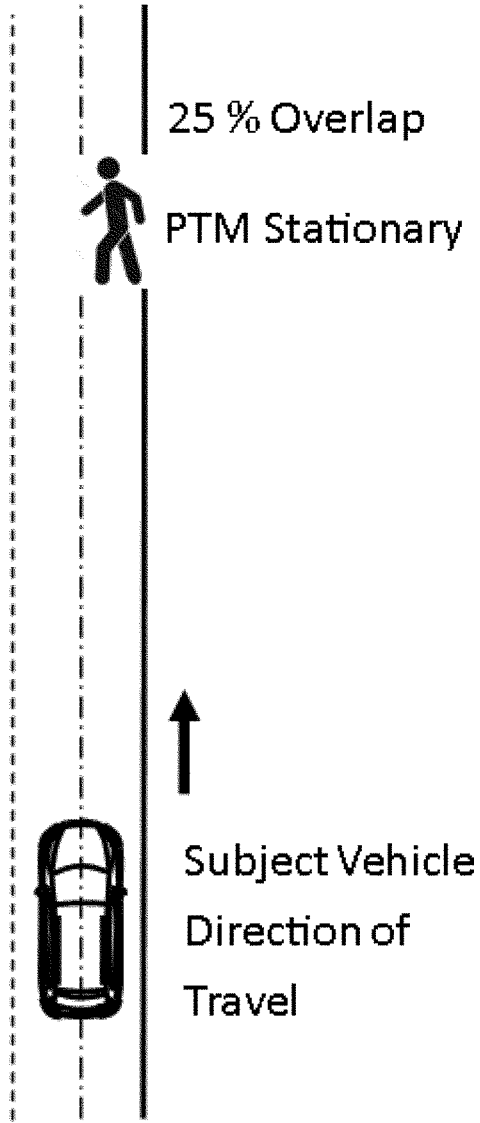

Figure 7 to § 571.127—Setup for Pedestrian Along-Path Moving

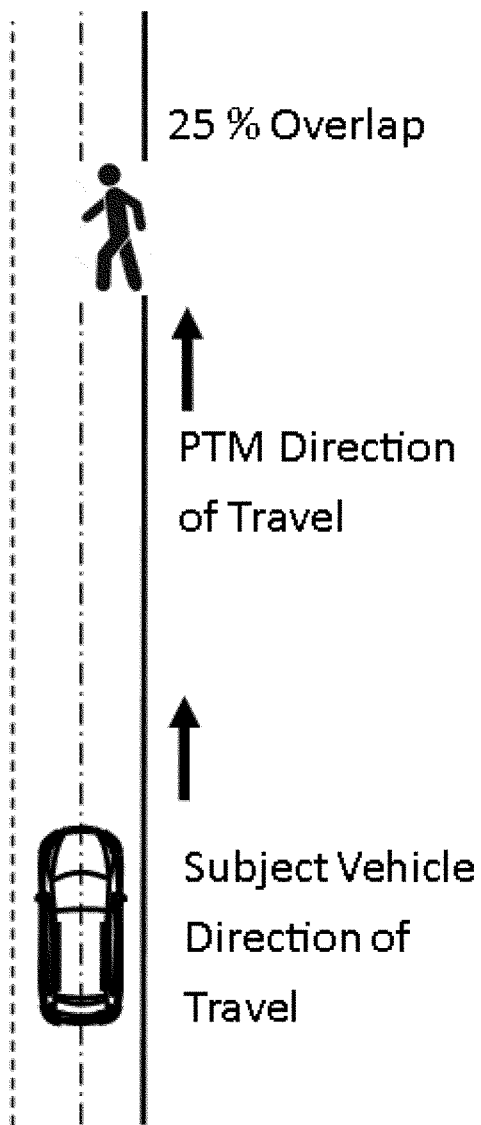

Figure 8 to § 571.127—Steel Trench Plate

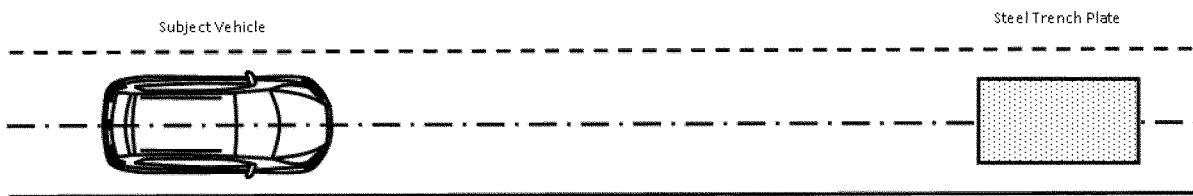
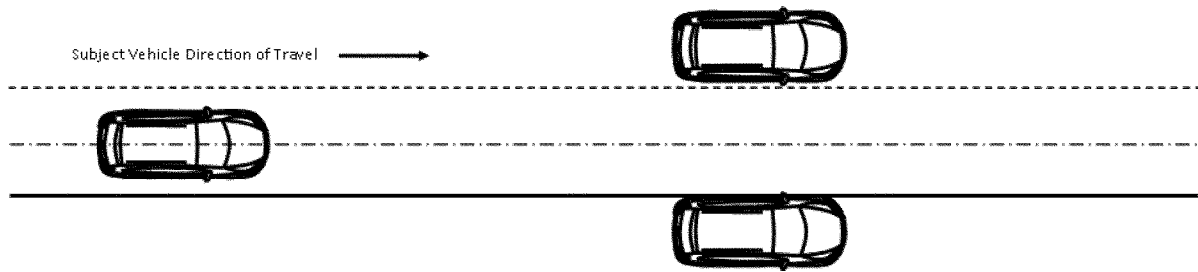

Figure 9 to § 571.127—Pass-Through



- 4. Add part 596 to read as follows.

PART 596—AUTOMATIC EMERGENCY BRAKING TEST DEVICES

- 1. The authority citation for part 596 reads as follows:

Authority: 49 U.S.C. 322, 30111, 30115, 30117 and 30166; delegation of authority at 49 CFR 1.95.
Sec.

Subpart A—General

- 596.1 Scope.
- 596.2 Purpose.
- 596.3 Application
- 596.4 Definitions.
- 596.5 Matter incorporated by reference.

Subpart B—Pedestrian Test Devices

- 596.7 Specifications for pedestrian test devices.
- 596.8 [Reserved]

Subpart C—Vehicle Test Device

- 596.9 General Description
- 596.10 Specifications for the Vehicle Test Device

Authority: 49 U.S.C. 322, 30111, 30115, 30117 and 30166; delegation of authority at 49 CFR 1.95.

Subpart A—General

§ 596.1 Scope.

This part describes the test devices that are to be used for compliance testing of motor vehicles with motor vehicle safety standards for automatic emergency braking.

§ 596.2 Purpose.

The design and performance criteria specified in this part are intended to describe devices with sufficient precision such that testing performed with these test devices will produce repetitive and correlative results under similar test conditions to reflect adequately the automatic emergency braking performance of a motor vehicle.

§ 596.3 Application.

This part does not in itself impose duties or liabilities on any person. It is a description of tools that are used in compliance tests to measure the performance of automatic emergency braking systems required by the safety standards that refer to these tools. This

part is designed to be referenced by, and become part of, the test procedures specified in motor vehicle safety standards, such as 49 CFR 571.127 (Standard No. 127, *Automatic emergency braking systems for light vehicles*).

§ 596.4 Definitions.

All terms defined in section 30102 of the National Traffic and Motor Vehicle Safety Act (49 U.S.C. chapter 301, *et seq.*) are used in their statutory meaning.

Adult Pedestrian Test Mannequin (APTM) means a test device with the appearance and radar cross section that simulates an adult pedestrian for the purpose of testing automatic emergency brake system performance.

Child Pedestrian Test Mannequin (CPTM) means a test device with the appearance and radar cross section that simulates a child pedestrian for the purpose of testing automatic emergency brake system performance.

Vehicle Test Device means a test device that simulates a passenger vehicle for the purpose of testing automatic emergency brake system performance.

Vehicle Test Device Carrier means a movable platform on which a Lead Vehicle Test Device may be attached during compliance testing.

Pedestrian Test Device(s) means an Adult Pedestrian Test Mannequin and/or a Child Pedestrian Test Mannequin.

Pedestrian Test Mannequin Carrier means a movable platform on which an Adult Pedestrian Test Mannequin or Child Pedestrian Test Mannequin may be attached during compliance testing.

§ 596.5 Matter incorporated by reference.

(a) Certain material is incorporated by reference into this part with the approval of the Director of the Federal Register under 5 U.S.C. 552(a) and 1 CFR part 51. To enforce any edition other than that specified in this section, the National Highway Traffic Safety Administration (NHTSA) must publish notice of change in the **Federal Register** and the material must be available to the public. All approved material is available for inspection at NHTSA at the

National Archives and Records Administration (NARA). Contact NHTSA at: NHTSA Office of Technical Information Services, 1200 New Jersey Avenue SE, Washington, DC 20590; (202) 366-2588 and For information on the availability of this material at NARA, visit www.archives.gov/federal-register/cfr/ibr-locations.html or email fr.inspection@nara.gov. The material may be obtained from the source(s) in the following paragraph of this section.

(b) International Organization for Standardization (ISO), 1, ch. de la Voie-Creuse, CP 56, CH-1211 Geneva 20, Switzerland; phone: + 41 22 749 01 11 fax: + 41 22 733 34 30; website: www.iso.org/.

(1) ISO 3668:2017, “Paints and varnishes—Visual comparison of colour of paints,” Third edition, 2017-05; into § 596.7.

(2) ISO 19206-2:2018(E), “Road vehicles—Test devices for target vehicles, vulnerable road users and other objects, for assessment of active safety functions—Part 2: Requirements for pedestrian targets,” First edition, 2018-12; into § 596.7.

(3) ISO 19206-3:2021(E), “Test devices for target vehicles, vulnerable road users and other objects, for assessment of active safety functions—Part 3: Requirements for passenger vehicle 3D targets,” First edition, 2021-05; into § 596.10.

(4) ISO I9206-4:2020(E), “Test devices for target vehicles, vulnerable road users and other objects, for assessment of active safety functions—Part 4: Requirements for bicyclist targets,” First edition, 2020-11; into § 596.7.

Subpart B—Pedestrian Test Devices

§ 596.7 Specifications for Pedestrian Test Devices.

(a) The words “recommended,” “should,” “can be,” or “should be” appearing in sections of ISO 19206-2:2018(E) (incorporated by reference, see § 596.5), referenced in this section, are read as setting forth specifications that are used.

(b) The words “may be,” or “either” used in connection with a set of items

appearing in sections of ISO 19206–2:2018(E) (incorporated by reference, see § 596.5), referenced in this section, are read as setting forth the totality of items, any one of which may be selected by NHTSA for testing.

(c) *Specifications for the Pedestrian Test Devices*—(1) *General description.* The Adult Pedestrian Test Mannequin (APTM) provides a sensor representation of a 50th percentile adult male and consist of a head, torso, two arms and hands, and two legs and feet. The Child Pedestrian Test Mannequin (CPTM) provides a sensor representation of a 6–7-year-old child and consists of a head, torso, two arms and hands, and two legs and feet. The arms of the APTM and CPTM are posable, but do not move during testing. The legs of the APTM and CPTM articulate and are synchronized to the forward motion of the mannequin.

(2) *Dimensions and posture.* The APTM has basic body dimensions and proportions specified in Annex A, table A.1 in ISO 19206–2:2018 (incorporated by reference, see § 596.5). The CPTM has basic body dimensions and proportions specified in Annex A, table A.1 in ISO 19206–2:2018 (incorporated by reference, see § 596.5).

(3) *Visual Properties*—(i) *Head.* The head has a visible hairline silhouette by printed graphic. The hair is black as defined in Annex B table B.2 of ISO 19206–4:2020, as tested in accordance with ISO 3668:2017 (both incorporated by reference, see § 596.5).

(ii) *Face.* The head does not have any facial features (*i.e.*, eyes, nose, mouth, and ears).

(iii) *Skin.* The face, neck and hands have a skin colored as defined Annex B, table B.2 of ISO 19206–4: 2020 (incorporated by reference, see § 596.5).

(iv) *Torso and Arms.* The torso and arms are black as defined in Annex B table B.2 of ISO 19206–4:2020, as tested in accordance with ISO 3668:2017 (both incorporated by reference, see § 596.5).

(v) *Legs.* The legs are blue as defined in Annex B table B.2 of ISO 19206–4:2020, as tested in accordance with ISO 3668:2017 (both incorporated by reference, see § 596.5).

(vi) *Feet.* The feet are black as defined in Annex B table B.2 of ISO 19206–4:2020, as tested in accordance with ISO 3668:2017 (both incorporated by reference, see § 596.5).

(4) *Infrared properties.* The surface of the entire APTM or CPTM are within the reflectivity ranges specified in Annex B section B.2.2 of ISO 19206–2:2018, as illustrated in Annex B, figure B.2 (incorporated by reference, see § 596.5).

(5) *Radar properties.* The radar reflectivity characteristics of the pedestrian test device approximates that of a pedestrian of the same size when approached from the side or from behind.

(6) *Radar cross section measurements.* The radar cross section measurements of the APTM and the CPTM is within the upper and lower boundaries shown in Annex B, section B.3, figure B.6 of ISO 19206–2:2018 when tested in accordance with the measure procedure in Annex C, section C.3 of ISO 19206–2:2018 (incorporated by reference, see § 596.5).

(7) *Posture.* The pedestrian test device has arms that are posable and remain posed during testing. The pedestrian test device is equipped with moving legs consistent with standard gait phases specified in Section 5.6 of ISO 19206–2:2018 (incorporated by reference, see § 596.5).

(8) *Articulation Properties.* The legs of the pedestrian test device are in accordance with, and as described in, Annex D, section D.2 and illustrated in Figures D.1, D.2, and D.3 of ISO 19206–2:2018 (incorporated by reference, see § 596.6).

§ 596.8 [Reserved]

Subpart C—Vehicle Test Device

§ 596.9 General Description

(a) The Vehicle Test Device provides a sensor representation of a passenger motor vehicle.

(b) The rear view of the Vehicle Test Device contains representations of the vehicle silhouette, a rear window, a high-mounted stop lamp, two taillamps, a rear license plate, two rear reflex reflectors, and two tires.

§ 596.10 Specifications for the Vehicle Test Device.

(a) The words “recommended,” “should,” “can be,” or “should be” appearing in sections of ISO 19206–3:2021(E) (incorporated by reference, see § 596.5), referenced in this section, are read as setting forth specifications that are used.

(b) The words “may be,” or “either,” used in connection with a set of items appearing in sections of ISO 19206–3:2021(E) (incorporated by reference, see § 596.5), referenced in this section, are read as setting forth the totality of items, any one of which may be selected by NHTSA for testing.

(c) *Dimensional specifications.* (1) The rear silhouette and the rear window are symmetrical about a shared vertical centerline.

(2) Representations of the taillamps, rear reflex reflectors, and tires are

symmetrical about the surrogate’s centerline.

(3) The license plate representation has a width of 300 ±15 mm and a height of 150 ±15 mm and mounted with a license plate holder angle within the range described in 49 CFR 571.108 S6.6.3.1.

(4) The Vehicle Test Device representations are located within the minimum and maximum measurement values specified in columns 3 and 4 of Tables A.4 of ISO 19206–3:2021(E) Annex A (incorporated by reference, see § 596.5). The tire representations are located within the minimum and maximum measurement values specified in columns 3 and 4 of Tables A.3 of ISO 19206–3:2021(E) Annex A (incorporated by reference, see § 596.5). The terms “rear light” means “taillamp,” “retroreflector” means “reflex reflector,” and “high centre taillight” means “high-mounted stop lamp.”

(d) *Visual and near infrared specification.* (1) The Vehicle Test Device rear representation colors are within the ranges specified in Tables B.2 and B.3 of ISO 19206–3:2021(E) Annex B (incorporated by reference, see § 596.5).

(2) The rear representation infrared properties of the Vehicle Test Device are within the ranges specified in Table B.1 of ISO 19206–3:2021(E) Annex B (incorporated by reference, see § 596.5) for wavelengths of 850 to 950 nm when measured according to the calibration and measurement setup specified in paragraph B.3 of ISO 19206–3:2021(E) Annex B (incorporated by reference, see § 596.5).

(3) The Vehicle Test Device rear reflex reflectors, and at least 50 cm² of the taillamp representations are grade DOT–C2 reflective sheeting as specified in 49 CFR 571.108 S8.2.

(e) *Radar reflectivity specifications.*

(1) The radar cross section of the Vehicle Test Device is measured with it attached to the carrier (robotic platform). The radar reflectivity of the carrier platform is less than 0 dBm² for a viewing angle of 180 degrees and over a range of 5 to 100 m when measured according to the radar measurement procedure specified in C.3 of ISO 19206–3:2021(E) Annex C (incorporated by reference, see § 596.5) for fixed-angle scans.

(2) The rear bumper area as shown in Table C.1 of ISO 19206–3:2021(E) Annex C (incorporated by reference, see § 596.5) contributes to the target radar cross section.

(3) The radar cross section is assessed using radar sensor that operates at 76 to 81 GHz and has a range of at least 5 to

100 m, a range gate length smaller than 0.6m, a horizontal field of view of 10 degrees or more (– 3dB amplitude limit), and an elevation field of view of 5 degrees or more (– 3dB amplitude).

(4) At least 92 percent of the filtered data points of the surrogate radar cross section for the fixed vehicle angle, variable range measurements are within the radar cross section boundaries defined in Sections C.2.2.4 of ISO 19206–3:2021(E) Annex C (incorporated by reference, see § 596.5) for a viewing

angle of 180 degrees when measured according to the radar measurement procedure specified in C.3 of ISO 19206–3:2021(E) Annex C (incorporated by reference, see § 596.5) for fixed-angle scans.

(5) Between 86 to 95 percent of the Vehicle Test Device spatial radar cross section reflective power is with the primary reflection region defined in Section C.2.2.5 of ISO 19206–3:2021(E) Annex C (incorporated by reference, see § 596.5) when measured according to

the radar measurement procedure specified in C.3 of ISO 19206–3:2021(E) Annex C (incorporated by reference, see § 596.5) using the angle-penetration method.

Issued under authority delegated in 49 CFR part 1.95 and 49 CFR 501.8.

Raymond R. Posten,

Associate Administrator for Rulemaking.

[FR Doc. 2023–11863 Filed 6–12–23; 8:45 am]

BILLING CODE 4910–59–P