

**ENVIRONMENTAL PROTECTION AGENCY**

**40 CFR Parts 2, 59, 60, 80, 85, 86, 87, 600, 1027, 1030, 1033, 1036, 1037, 1039, 1042, 1043, 1045, 1048, 1051, 1054, 1060, 1065, 1066, 1068, and 1090**

[EPA-HQ-OAR-2019-0055; FRL-7165-03-OAR]

RIN 2060-AU41

**Control of Air Pollution From New Motor Vehicles: Heavy-Duty Engine and Vehicle Standards**

**AGENCY:** Environmental Protection Agency (EPA).

**ACTION:** Proposed rule.

**SUMMARY:** The Environmental Protection Agency (EPA) is proposing a rule that would reduce air pollution from highway heavy-duty vehicles and engines, including ozone, particulate matter, and greenhouse gases. This proposal would change the heavy-duty emission control program—including the standards, test procedures, useful life, warranty, and other requirements—to further reduce the air quality impacts of heavy-duty engines across a range of operating conditions and over a longer period of the operational life of heavy-duty engines. Heavy-duty vehicles and engines are important contributors to concentrations of ozone and particulate matter and their resulting threat to public health, which includes premature death, respiratory illness (including childhood asthma), cardiovascular problems, and other adverse health impacts. This proposal would reduce emissions of nitrogen oxides and other pollutants. In addition, this proposal would make targeted updates to the existing Heavy-Duty Greenhouse Gas Emissions Phase 2 program, proposing that further GHG reductions in the MY 2027 timeframe are appropriate considering lead time, costs, and other factors, including market shifts to zero-emission technologies in certain segments of the heavy-duty vehicle sector. We also propose limited amendments to the regulations that implement our air pollutant emission standards for other sectors (e.g., light-duty vehicles, marine diesel engines, locomotives, various types of nonroad engines, vehicles, and equipment).

**DATES:** *Comments:* Written comments must be received on or before May 13, 2022. Under the Paperwork Reduction Act (PRA), comments on the information collection provisions are best assured of consideration if the Office of Management and Budget

(OMB) receives a copy of your comments on or before April 27, 2022.

*Public Hearing:* EPA plans to hold a virtual public hearing on April 12, 2022. An additional session may be held on April 13, 2022. Please refer to Participation in Virtual Public Hearing in the **SUPPLEMENTARY INFORMATION** section for additional information on the public hearing.

**ADDRESSES:** You may send comments, identified by Docket ID No. EPA-HQ-OAR-2019-0055, by any of the following methods:

- *Federal eRulemaking Portal:* <https://www.regulations.gov/> (our preferred method). Follow the online instructions for submitting comments.
- *Email:* [a-and-r-Docket@epa.gov](mailto:a-and-r-Docket@epa.gov). Include Docket ID No. EPA-HQ-OAR-2019-0055 in the subject line of the message.
- *Mail:* U.S. Environmental Protection Agency, EPA Docket Center, OAR, Docket EPA-HQ-OAR-2019-0055, Mail Code 28221T, 1200 Pennsylvania Avenue NW, Washington, DC 20460.
- *Hand Delivery or Courier (by scheduled appointment only):* EPA Docket Center, WJC West Building, Room 3334, 1301 Constitution Avenue NW, Washington, DC 20004. The Docket Center's hours of operations are 8:30 a.m.–4:30 p.m., Monday–Friday (except Federal Holidays).

*Instructions:* All submissions received must include the Docket ID No. for this rulemaking. Comments received may be posted without change to <https://www.regulations.gov/>, including any personal information provided. For detailed instructions on sending comments and additional information on the rulemaking process, see the “Public Participation” heading of the **SUPPLEMENTARY INFORMATION** section of this document. Out of an abundance of caution for members of the public and our staff, the EPA Docket Center and Reading Room are open to the public by appointment only to reduce the risk of transmitting COVID-19. Our Docket Center staff also continues to provide remote customer service via email, phone, and webform. Hand deliveries and couriers may be received by scheduled appointment only. For further information on EPA Docket Center services and the current status, please visit us online at <https://www.epa.gov/dockets>.

*Public Hearing.* EPA plans to hold a virtual public hearing for this rulemaking. Please refer to *Participation in Virtual Public Hearing* in the **SUPPLEMENTARY INFORMATION** section for additional information.

**FOR FURTHER INFORMATION CONTACT:**

Brian Nelson, Assessment and Standards Division, Office of Transportation and Air Quality, Environmental Protection Agency, 2000 Traverwood Drive, Ann Arbor, MI 48105; telephone number: (734) 214-4278; email address: [nelson.brian@epa.gov](mailto:nelson.brian@epa.gov).

**SUPPLEMENTARY INFORMATION:**

**A. Public Participation**

*Written Comments*

Submit your comments, identified by Docket ID No. EPA-HQ-OAR-2019-0055, at <https://www.regulations.gov> (our preferred method), or the other methods identified in the **ADDRESSES** section. Once submitted, comments cannot be edited or removed from the docket. The EPA may publish any comment received to its public docket. Do not submit electronically any information you consider to be Confidential Business Information (CBI) or other information whose disclosure is restricted by statute. Multimedia submissions (audio, video, etc.) must be accompanied by a written comment. The written comment is considered the official comment and should include discussion of all points you wish to make. The EPA will generally not consider comments or comment contents located outside of the primary submission (i.e., on the web, cloud, or other file sharing system). For additional submission methods, the full EPA public comment policy, information about CBI or multimedia submissions, and general guidance on making effective comments, please visit <https://www.epa.gov/dockets/commenting-epa-dockets>.

Due to public health concerns related to COVID-19, the EPA Docket Center and Reading Room are open to the public by appointment only. Our Docket Center staff also continues to provide remote customer service via email, phone, and webform. Hand deliveries or couriers will be received by scheduled appointment only. For further information and updates on EPA Docket Center services, please visit us online at <https://www.epa.gov/dockets>.

The EPA continues to carefully and continuously monitor information from the Centers for Disease Control and Prevention (CDC), local area health departments, and our Federal partners so that we can respond rapidly as conditions change regarding COVID-19.

*Participation in Virtual Public Hearing*

Please note that because of current CDC recommendations, as well as state and local orders for social distancing to

limit the spread of COVID-19, EPA cannot hold in-person public meetings at this time.

The EPA plans to hold a virtual public hearing on April 12, 2022. An additional session may be held on April 13, 2022. This hearing will be held using Zoom. In order to attend the virtual public hearing, all attendees (including those who will not be presenting verbal testimony) must register in advance. EPA will begin registering speakers for the hearing upon publication of this document in the **Federal Register**. To register, please use the registration link that will be available on the EPA rule web page once registration begins: <https://www.epa.gov/regulations-emissions-vehicles-and-engines/proposed-rule-and-related-materials-control-air-1>. A separate registration form must be submitted for each person attending the hearing.

The last day to register to speak at the hearing will be five working days before the first public hearing date. The EPA will post a general agenda for the hearing with the order of speakers at: <https://www.epa.gov/regulations-emissions-vehicles-and-engines/proposed-rule-and-related-materials-control-air-1>. This agenda will be available no later than two working days before the first public hearing date.

In order to allow everyone to be heard, EPA is limiting verbal testimony to three minutes per person. Speakers will not be able to share graphics via the virtual public hearing. Speakers will be able to request an approximate speaking time as part of the registration process, with preferences considered on a first-come, first-served basis. EPA also recommends submitting the text of oral comments as written comments to the rulemaking docket.

EPA will make every effort to follow the schedule as closely as possible on the day of the hearing; however, please plan for the hearings to run either ahead of schedule or behind schedule.

The EPA may ask clarifying questions during the oral presentations, but will not respond to the presentations at that time. Written statements and supporting information submitted during the comment period will be considered with the same weight as oral comments and supporting information presented at the public hearing.

Please note that any updates made to any aspect of the hearing will be posted online at: <https://www.epa.gov/regulations-emissions-vehicles-and-engines/proposed-rule-and-related-materials-control-air-1>. While the EPA expects the hearing to go forward as described here, please monitor our

website or contact Tuana Phillips, (202)-565-0074, [phillips.tuana@epa.gov](mailto:phillips.tuana@epa.gov) to determine if there are any updates. The EPA does not intend to publish a document in the **Federal Register** announcing updates.

If you require the services of a translator or special accommodations such as audio description, please identify these needs when you register for the hearing or by contacting Tuana Phillips at (202)-565-0074, [phillips.tuana@epa.gov](mailto:phillips.tuana@epa.gov). EPA may not be able to arrange accommodations without advance notice.

## B. General Information

### *Does this action apply to me?*

This action relates to companies that manufacture, sell, or import into the United States new heavy-duty highway engines. Additional amendments apply for gasoline refueling facilities and for manufacturers of all sizes and types of motor vehicles, stationary engines, aircraft and aircraft engines, and various types of nonroad engines, vehicles, and equipment. Regulated categories and entities include the following:

NAICS codes <sup>a</sup>	NAICS title
326199 .....	All Other Plastics Product Manufacturing.
332431 .....	Metal Can Manufacturing.
335312 .....	Motor and Generator Manufacturing.
336111 .....	Automobile Manufacturing.
336112 .....	Light Truck and Utility Vehicle Manufacturing.
336120 .....	Heavy Duty Truck Manufacturing.
336211 .....	Motor Vehicle Body Manufacturing.
336212 .....	Truck Trailer Manufacturing.
336213 .....	Motor Home Manufacturing.
336411 .....	Manufacturers of new aircraft.
336412 .....	Manufacturers of new aircraft engines.
333618 .....	Other Engine Equipment Manufacturing.
336999 .....	All Other Transportation Equipment Manufacturing.
423110 .....	Automotive and Other Motor Vehicle Merchant Wholesalers.
447110 .....	Gasoline Stations with Convenience Stores.
447190 .....	Other Gasoline Stations.
454310 .....	Fuel dealers.
811111 .....	General Automotive Repair.
811112 .....	Automotive Exhaust System Repair.
811198 .....	All Other Automotive Repair and Maintenance.

<sup>a</sup> NAICS Association. NAICS & SIC Identification Tools. Available online: <https://www.naics.com/search>.

This table is not intended to be exhaustive, but rather provides a guide for readers regarding entities likely to be regulated by this action. This table lists the types of entities that EPA is now aware could potentially be regulated by this action. Other types of entities not listed in the table could also be regulated. To determine whether your entity is regulated by this action, you should carefully examine the

applicability criteria found in Sections XII and XIII of this preamble. If you have questions regarding the applicability of this action to a particular entity, consult the person listed in the **FOR FURTHER INFORMATION CONTACT** section.

### *What action is the agency taking?*

The Environmental Protection Agency (EPA) is proposing a rule that would reduce air pollution from highway heavy-duty vehicles and engines. This proposal would change the heavy-duty emission control program—including the standards, test procedures, regulatory useful life, emission-related warranty, and other requirements—to further reduce the air quality impacts of heavy-duty engines across a range of operating conditions and over a longer period of the operational life of heavy-duty engines. Heavy-duty vehicles and engines are important contributors to concentrations of ozone and particulate matter and their resulting threat to public health, which includes premature death, respiratory illness (including childhood asthma), cardiovascular problems, and other adverse health impacts. This proposal would reduce emissions of nitrogen oxides and other pollutants. In addition, this proposal would make targeted updates to the existing Heavy-Duty Greenhouse Gas Emissions Phase 2 program, proposing that further GHG reductions in the MY 2027 timeframe are appropriate considering lead time, costs, and other factors, including market shifts to zero-emission technologies in certain segments of the heavy-duty vehicle sector.

### *What is the agency's authority for taking this action?*

Section 202(a)(1) of the Clean Air Act requires the EPA to set emission standards for air pollutants from new motor vehicles or new motor vehicle engines, which the Administrator has found cause or contribute to air pollution that may endanger public health or welfare. See Sections I.A.4, I.F, and XIV of this preamble for more information on the agency's authority for this action.

### *What are the incremental costs and benefits of this action?*

We compare total monetized health benefits to total costs associated with the proposed Options 1 and 2 in Section IX. Our results show that annual benefits of the proposed Option 1 would be larger than the annual costs in 2045, a year when the program would be fully implemented and when most of the regulated fleet would have turned over,

with annual net benefits of \$9 and \$31 billion assuming a 3 percent discount rate, and net benefits of \$8 and \$28 billion assuming a 7 percent discount rate.<sup>1</sup> Annual benefits would also be larger than annual costs in 2045 for the proposed Option 2, although net benefits would be lower than from the proposed Option 1 (net benefits of proposed Option 2 would be \$6 and \$23 billion at a 3 percent discount rate, and net benefits of \$5 and 21 billion at a 7 percent discount rate). See Section VIII for more details on the net benefit estimates. For both the proposed Options 1 and 2, benefits also outweigh the costs when expressed in present value terms and as equalized annual values.

*Did EPA conduct a peer review before issuing this action?*

This regulatory action was supported by influential scientific information. Therefore, EPA conducted peer reviews in accordance with OMB's Final Information Quality Bulletin for Peer Review. Specifically, we conducted peer reviews on five analyses: (1) Analysis of Heavy-Duty Vehicle Sales Impacts Due to New Regulation (Sales Impacts), (2) Exhaust Emission Rates for Heavy-Duty Onroad Vehicles in MOVES\_CTI NPRM (Emission Rates), (3) Population and Activity of Onroad Vehicles in MOVES\_CTI NPRM (Population and Activity), (4) Cost teardowns of Heavy-Duty Valvetrain (Valvetrain costs), and (5) Cost teardown of Emission Aftertreatment Systems (Aftertreatment Costs). These peer reviews were all letter reviews conducted by a contractor. The peer review reports for each analysis are located in the docket for this action and at EPA's Science Inventory (<https://cfpub.epa.gov/si/>).

## Table of Contents

<ul style="list-style-type: none"> <li>ES. Executive Summary           <ul style="list-style-type: none"> <li>A. Purpose of the Regulatory Action</li> <li>B. Overview of the Regulatory Action</li> <li>C. Summary of the Major Provisions in the Regulatory Action</li> <li>D. Projected Emission Reductions, Air Quality Improvements, Costs, and Benefits</li> <li>E. Summary of Specific Requests for Comments</li> </ul> </li> <li>I. Introduction           <ul style="list-style-type: none"> <li>A. Brief Overview of the Heavy-Duty Truck Industry</li> <li>B. History of Emission Standards for Heavy-Duty Engines and Vehicles</li> <li>C. Petitions to EPA for Additional NO<sub>x</sub> Emissions Control</li> <li>D. California Heavy-Duty Highway Low NO<sub>x</sub> Program Development</li> </ul> </li> </ul>	<ul style="list-style-type: none"> <li>E. Advance Notice of Proposed Rulemaking</li> <li>F. EPA Statutory Authority for the Proposal</li> <li>G. Basis of the Proposed Standards</li> <li>II. Need for Additional Emissions Control           <ul style="list-style-type: none"> <li>A. Background on Pollutants Impacted by This Proposal</li> <li>B. Health Effects Associated With Exposure to Pollutants Impacted by This Proposal</li> <li>C. Environmental Effects Associated With Exposure to Pollutants Impacted by This Proposal</li> </ul> </li> <li>III. Proposed Test Procedures and Standards           <ul style="list-style-type: none"> <li>A. Overview</li> <li>B. Summary of Compression-Ignition Exhaust Emission Standards and Duty Cycle Test Procedures</li> <li>C. Summary of Compression-Ignition Off-Cycle Standards and In-Use Test Procedures</li> <li>D. Summary of Spark-Ignition Heavy-Duty Engine Exhaust Emission Standards and Test Procedures</li> <li>E. Summary of Spark-Ignition Heavy-Duty Vehicle Refueling Emission Standards and Test Procedures</li> </ul> </li> <li>IV. Compliance Provisions and Flexibilities           <ul style="list-style-type: none"> <li>A. Regulatory Useful Life</li> <li>B. Ensuring Long-Term In-Use Emissions Performance</li> <li>C. Onboard Diagnostics</li> <li>D. Inducements</li> <li>E. Certification Updates</li> <li>F. Durability Testing</li> <li>G. Averaging, Banking, and Trading</li> <li>H. Early Adoption Incentives</li> <li>I. Compliance Options for Generating NO<sub>x</sub> Emission Credits From Electric Vehicles</li> <li>J. Fuel Quality</li> <li>K. Other Flexibilities Under Consideration</li> </ul> </li> <li>V. Program Costs           <ul style="list-style-type: none"> <li>A. Technology Package Costs</li> <li>B. Operating Costs</li> <li>C. Program Costs</li> </ul> </li> <li>VI. Estimated Emission Reductions From the Proposal and Alternatives           <ul style="list-style-type: none"> <li>A. Emission Inventory Methodology</li> <li>B. Estimated Emission Reductions From the Proposed Criteria Pollutant Program</li> <li>C. Estimated Emission Reductions From the Alternatives Analyzed</li> <li>D. Evaluating Emission Impacts of Electric Vehicles in the Proposed Emission Inventory Baseline</li> </ul> </li> <li>VII. Air Quality Impacts of the Proposed Rule           <ul style="list-style-type: none"> <li>A. Ozone</li> <li>B. Particulate Matter</li> <li>C. Nitrogen Dioxide</li> <li>D. Carbon Monoxide</li> <li>E. Air Toxics</li> <li>F. Visibility</li> <li>G. Nitrogen Deposition</li> <li>H. Demographic Analysis of Air Quality</li> </ul> </li> <li>VIII. Benefits of the Program</li> <li>IX. Comparison of Benefits and Costs           <ul style="list-style-type: none"> <li>A. Methods</li> <li>B. Results</li> </ul> </li> <li>X. Economic Impact Analysis           <ul style="list-style-type: none"> <li>A. Impact on Vehicle Sales, Mode Shift, and Fleet Turnover</li> <li>B. Employment Impacts</li> </ul> </li> <li>XI. Targeted Updates to the HD GHG Phase 2 Heavy-Duty Greenhouse Gas Emissions Program           <ul style="list-style-type: none"> <li>A. Background on Heavy-Duty Greenhouse Gas Emission Standards</li> <li>B. What has changed since we finalized the HD GHG Phase 2 rule?</li> </ul> </li> </ul>	<ul style="list-style-type: none"> <li>C. Proposed Changes to HD GHG Phase 2 CO<sub>2</sub> Standards for Targeted Subcategories</li> <li>D. HD GHG Phase 2 Advanced Technology Credits for CO<sub>2</sub> Emissions</li> <li>E. Emissions and Cost Impacts of Proposed Revised MY 2027 CO<sub>2</sub> Emission Standards</li> <li>F. Summary of Proposed Changes to HD GHG Phase 2</li> <li>XII. Other Amendments           <ul style="list-style-type: none"> <li>A. General Compliance Provisions (40 CFR Part 1068) and Other Cross-Sector Issues</li> <li>B. Heavy-Duty Highway Engine and Vehicle Emission Standards (40 CFR Parts 1036 and 1037)</li> <li>C. Fuel Dispensing Rates for Heavy-Duty Vehicles (40 CFR Parts 80 and 1090)</li> <li>D. Refueling Interface for Motor Vehicles (40 CFR Parts 80 and 1090)</li> <li>E. Light-Duty Motor Vehicles (40 CFR Parts 85, 86, and 600)</li> <li>F. Large Nonroad Spark-Ignition Engines (40 CFR Part 1048)</li> <li>G. Small Nonroad Spark-Ignition Engines (40 CFR Part 1054)</li> <li>H. Recreational Vehicles and Nonroad Evaporative Emissions (40 CFR Parts 1051 and 1060)</li> <li>I. Marine Diesel Engines (40 CFR Parts 1042 and 1043)</li> <li>J. Locomotives (40 CFR Part 1033)</li> <li>K. Stationary Compression-Ignition Engines (40 CFR Part 60, Subpart IIII)</li> <li>L. Heavy-Duty Compression-Ignition Engines (40 CFR Part 86)</li> </ul> </li> <li>XIII. Executive Orders Reviews           <ul style="list-style-type: none"> <li>A. Executive Order 12866: Regulatory Planning and Review and Executive Order 13563: Improving Regulation and Regulatory Review</li> <li>B. Paperwork Reduction Act (PRA)</li> <li>C. Regulatory Flexibility Act (RFA)</li> <li>D. Unfunded Mandates Reform Act (UMRA)</li> <li>E. Executive Order 13132: Federalism</li> <li>F. Executive Order 13175: Consultation and Coordination With Indian Tribal Governments</li> <li>G. Executive Order 13045: Protection of Children From Environmental Health and Safety Risks</li> <li>H. Executive Order 13211: Actions Concerning Regulations That Significantly Affect Energy Supply, Distribution, or Use</li> <li>I. National Technology Transfer and Advancement Act (NTTAA) and 1 CFR Part 51</li> <li>J. Executive Order 12898: Federal Actions To Address Environmental Justice in Minority Populations and Low-Income Populations.</li> </ul> </li> <li>XIV. Statutory Provisions and Legal Authority</li> </ul>
---	--	---

## Executive Summary

### A. Purpose of the Regulatory Action

The Environmental Protection Agency (EPA) is proposing a multipollutant rule to further reduce air pollution from heavy-duty engines and vehicles across the United States, including ozone and particulate matter (PM). In addition, as part of this rulemaking we are proposing

<sup>1</sup> The range of benefits and net benefits reflects a combination of assumed PM<sub>2.5</sub> and ozone mortality risk estimates and selected discount rate.

targeted updates to the existing Heavy-Duty Greenhouse Gas Emissions Phase 2 program (HD GHG Phase 2). This proposed rulemaking builds on and improves the existing emission control program for on-highway heavy-duty engines and vehicles. This proposal is pursuant to EPA's authority under the Clean Air Act to regulate air pollutants emitted from mobile sources. The proposal is also consistent with Executive Order (E.O.) 14037, which directed EPA to consider setting new oxides of nitrogen (NO<sub>x</sub>) emission standards and updating the existing GHG emissions standards for heavy-duty engines and vehicles.<sup>2,3</sup> In this proposed action, EPA is co-proposing two regulatory options for new NO<sub>x</sub> standards: Proposed Option 1 and proposed Option 2. As discussed in Section B.1 of this Executive Summary and throughout this preamble, we request comment on the options presented, as well as the full range of options between them.

Heavy-duty (HD) engines operating across the U.S. emit NO<sub>x</sub> and other pollutants that contribute to ambient levels of ozone, PM, and NO<sub>x</sub>. These pollutants are linked to premature death, respiratory illness (including childhood asthma), cardiovascular problems, and other adverse health impacts. Data show that heavy-duty engines are important contributors to concentrations of ozone and PM<sub>2.5</sub> and their resulting threat to public health.<sup>4,5</sup>

The proposed rulemaking would change key provisions of the heavy-duty emission control program—including the standards, test procedures, regulatory useful life, emission-related warranty, and other requirements; the two regulatory options (proposed Options 1 and 2) would result in different numeric levels of the standards and lengths of useful life and warranty periods. The proposed Options 1 and 2 and the range between them provide the numeric values for these key provisions that we focus on for this proposal. Together, the key provisions in the proposal would further reduce the air quality impacts of heavy-duty engines

across a range of operating conditions and over a longer period of the operational life of heavy-duty engines (see Section I.B for an overview of the proposed program). The requirements in the proposed Option 1 and the proposed Option 2 would lower emissions of NO<sub>x</sub> and other air pollutants (PM, hydrocarbons (HC), air toxics, and carbon monoxide (CO)) beginning as early as model year (MY) 2027. The emission reductions from both the proposed Option 1 and the proposed Option 2 would increase over time as more new, cleaner vehicles enter the fleet.

We estimate that if finalized as proposed, the proposed Option 1 would reduce NO<sub>x</sub> emissions from heavy-duty vehicles in 2040 by more than 50 percent; by 2045, a year by which most of the regulated fleet would have turned over, heavy-duty NO<sub>x</sub> emissions would be more than 60 percent lower than they would have been without this action. Our estimates show proposed Option 2 would reduce heavy-duty NO<sub>x</sub> emissions in 2045 by 47 percent (see Section I.D for more information on our projected emission reductions from proposed Option 1 or 2). These emission reductions would result in air quality improvements in ozone and PM<sub>2.5</sub>; we estimate that in 2045, the proposed Option 1 would result in total annual monetized ozone- and PM<sub>2.5</sub>-related benefits of \$12 and \$33 billion at a 3 percent discount rate, and \$10 and \$30 billion at a 7 percent discount rate. In the same calendar year, proposed Option 2 would result in total annual monetized ozone- and PM<sub>2.5</sub>-related benefits of \$9 and \$26 billion at a 3 percent discount rate, and \$8 and \$23 billion at a 7 percent discount (see Section VIII for discussion on quantified and monetized health impacts). Given the analysis we present in this proposal, we currently believe that Option 1 may be a more appropriate level of stringency as it would result in a greater level of achievable emission reduction for the model years proposed, which is consistent with EPA's statutory authority under Clean Air Act section 202(a)(3). These emission reductions would result in widespread decreases in ambient concentrations of pollutants such as ozone and PM<sub>2.5</sub>. These widespread projected air quality improvements would play an important role in addressing concerns from states, local communities, and Tribal governments about the contributions of heavy-duty engines to air quality challenges they face such as meeting their obligations to attain or continue to meet National Ambient Air Quality

Standards (NAAQS), and to reduce other human health and environmental impacts of air pollution.

In addition to further reducing emissions of NO<sub>x</sub> and other ozone and PM<sub>2.5</sub> precursors, as part of this rulemaking we are proposing targeted updates to the existing Heavy-Duty Greenhouse Gas Emissions Phase 2 program (HD GHG Phase 2).<sup>6</sup> The proposed updates would apply to certain CO<sub>2</sub> standards for MYs 2027 and later trucks that are appropriate considering lead time, costs, and other factors, including market shifts to zero-emission technologies in certain segments of the heavy-duty vehicle sector. The proposed updates are intended to balance further incentivizing zero and near-zero emissions vehicle development with ensuring that the standards achieve an appropriate fleet-wide level of CO<sub>2</sub> emissions reductions.

## 1. Industry Overview

Heavy-duty highway vehicles (also referred to as “trucks” in this preamble) range from vocational vehicles that support local and regional construction, refuse collection, and delivery work to long-haul tractor-trailers that move freight cross-country. This diverse array of vehicles is categorized into weight classes based on gross vehicle weight ratings (GVWR) that span Class 2b trucks and vans greater than 8,500 lbs GVWR through Class 8 long-haul tractors and other commercial vehicles that exceed 33,000 lbs GVWR.<sup>7</sup> These vehicles are primarily powered by diesel-fueled, compression-ignition (CI) engines, although gasoline-fueled, spark-ignition (SI) engines are common in the lighter weight classes, and

<sup>6</sup> 81 FR at 73478 (October 25, 2016).

<sup>7</sup> This proposed rulemaking includes revised criteria pollutant standards for engine-certified Class 2b through 8 heavy-duty engines and vehicles; this proposal also includes revised GHG standards for Class 4 through 8 vehicles. Class 2b and 3 vehicles with GVWR between 8,500 and 14,000 pounds are primarily commercial pickup trucks and vans and are sometimes referred to as “medium-duty vehicles”. The majority of Class 2b and 3 vehicles are chassis-certified vehicles, and EPA intends to include them in a future combined light-duty and medium-duty rulemaking action, consistent with E.O. 14037, Section 2a. Heavy-duty engines and vehicles are also used in nonroad applications, such as construction equipment; nonroad heavy-duty engines and vehicles are not the focus of this proposal. See Section I for more discussion on the spectrum of heavy-duty vehicles and how they relate to the proposed rule. As outlined in Section C of this Executive Summary and detailed in Section XII, this proposal also includes limited amendments to regulations that implement our air pollutant emission standards for other industry sectors, including light-duty vehicles, light-duty trucks, marine diesel engines, locomotives, and various types of nonroad engines, vehicles, and equipment.

<sup>2</sup> President Joseph Biden. Executive Order on Strengthening American Leadership in Clean Cars and Trucks. 86 FR 43583, August 10, 2021.

<sup>3</sup> Oxides of nitrogen (NO<sub>x</sub>) refers to nitric oxide (NO) and nitrogen dioxide (NO<sub>2</sub>).

<sup>4</sup> Zawacki et al, 2018. Mobile source contributions to ambient ozone and particulate matter in 2025. Atmospheric Environment, Vol 188, pg 129–141. Available online: <https://doi.org/10.1016/j.atmosenv.2018.04.057>.

<sup>5</sup> Davidson et al, 2020. The recent and future health burden of the U.S. mobile sector apportioned by source. Environmental Research Letters. Available online: <https://doi.org/10.1088/1748-9326/ab83a8>.

smaller numbers of alternative fuel engines (e.g., liquified petroleum gas, compressed natural gas) are found in the heavy-duty fleet. Vehicles powered by electricity, either in the form of battery electric vehicles (BEVs) or fuel cell electric vehicles (FCEVs) are also increasingly entering the heavy-duty fleet. The operational characteristics of some commercial applications (e.g., delivery vehicles) can be similar across several vehicle weight classes, allowing a single engine, or electric power source in the case of BEVs and FCEVs, to be installed in a variety of vehicles. For instance, engine specifications needed for a Class 4 parcel delivery vehicle may be similar to the needs of a Class 5 mixed freight delivery vehicle or a Class 6 beverage truck. Performance differences needed to operate across this range of vehicles can be achieved through adjustments to chassis-based systems (e.g., transmission, cooling system) external to the engine.

## 2. The Need for Additional Emission Control of NO<sub>x</sub> and Other Pollutants From Heavy-Duty Engines

Across the U.S., NO<sub>x</sub> emissions from heavy-duty engines are important contributors to concentrations of ozone and PM<sub>2.5</sub> and their resulting health effects.<sup>8,9</sup> Heavy-duty engines will continue to be one of the largest contributors to mobile source NO<sub>x</sub> emissions nationwide in the future, representing 32 percent of the mobile source NO<sub>x</sub> emissions in calendar year 2045.<sup>10</sup> Furthermore, it is estimated that heavy-duty engines would represent 89 percent of the onroad NO<sub>x</sub> inventory in calendar year 2045.<sup>11</sup> Reducing NO<sub>x</sub> emissions is a critical part of many areas' strategies to attain and maintain the ozone and PM NAAQS; many state and local agencies anticipate challenges in attaining the NAAQS, maintaining the NAAQS in the future, and/or preventing nonattainment (see Section II). Some nonattainment areas have already been "bumped up" to higher

<sup>8</sup>Zawacki et al. 2018. Mobile source contributions to ambient ozone and particulate matter in 2025. *Atmospheric Environment*, Vol 188, pg 129–141. Available online: <https://doi.org/10.1016/j.atmosenv.2018.04.057>.

<sup>9</sup>Davidson et al. 2020. The recent and future health burden of the U.S. mobile sector apportioned by source. *Environmental Research Letters*. Available online: <https://doi.org/10.1088/1748-9326/ab83a8>.

<sup>10</sup>U.S. Environmental Protection Agency (2021). 2016v1 Platform. <https://www.epa.gov/air-emissions-modeling/2016v1-platform>.

<sup>11</sup>Han, Jaehoon. Memorandum to the Docket EPA-HQ-OAR-2019-0055: "MOVES Modeling-Related Data Files (MOVES Code, Input Databases and Runspecs) for the Proposed Heavy-Duty 2027 Standards". February 2022.

classifications because of challenges in attaining the NAAQS.<sup>12</sup>

In addition, emissions from heavy-duty engines can significantly affect individuals living near truck freight routes. Based on a study EPA conducted of people living near truck routes, an estimated 72 million people live within 200 meters of a truck freight route (see discussion in Section II.B.7). Relative to the rest of the population, people of color and those with lower incomes are more likely to live near truck routes (see Sections II.B and VII.H for additional discussion on our analysis of environmental justice impacts of this proposal). This population includes children, and in addition, childcare facilities and schools can be in close proximity to freight routes.<sup>13</sup>

Clean Air Act section 202(a)(3)(A) requires EPA to set emission standards for NO<sub>x</sub>, PM, HC, and CO that reflect the greatest degree of emission reduction achievable through the application of technology that will be available for the model year to which such standards apply. Although heavy-duty engines have become much cleaner over the last decade, catalysts and other technologies have evolved such that harmful air pollutants can be reduced even further.

Heavy-duty emissions that affect local and regional populations are attributable to several engine operating modes and processes. Specifically, the operating modes and processes projected to contribute the most to the heavy-duty NO<sub>x</sub> emission inventory in 2045 are medium-to-high load (36 percent), low-load (28 percent), and aging (24 percent) (i.e., deterioration and mal-maintenance of the engine's emission control system) (see Section VI for more information on projected inventory contributions from each operating mode or process). These data suggest that medium- and high-load operating conditions continue to merit concern, while also showing that opportunities for significant additional emission reductions and related air quality improvements can be achieved through provisions that encourage emission control under low-load operation and throughout an engine's

<sup>12</sup>For example, in September 2019 several 2008 ozone nonattainment areas were reclassified from moderate to serious, including Dallas, Chicago, Connecticut, New York/New Jersey and Houston, and in January 2020, Denver. The 2008 NAAQS for ozone is an 8-hour standard with a level of 0.075 ppm, which the 2015 ozone NAAQS lowered to 0.070 ppm.

<sup>13</sup>Kingsley, S., Eliot, M., Carlson, L. et al. Proximity of US schools to major roadways: a nationwide assessment. *J Expo Sci Environ Epidemiol* 24, 253–259 (2014). <https://doi.org/10.1038/jes.2014.5>.

operational life. Our approach for provisions that address these aspects of the emission inventory is outlined below and described in more detail in sections that follow.

As described in Section III, the standards in proposed Options 1 and 2 would reduce emissions during a broader range of operating conditions that span nearly all in-use operation. The standards in proposed Options 1 and 2 are based on technology improvements which have become available over the 20 years since the last major rule was promulgated to address emissions of NO<sub>x</sub>, PM, HC, and CO (hereafter referred to as "criteria pollutants") and toxic pollutants from heavy-duty engines. As further detailed in Section III, available data indicate that emission levels demonstrated for certification are not achieved under the broad range of real-world operating conditions.<sup>14 15 16 17</sup> In fact, less than ten percent of the data collected during a typical test while the vehicle is operated on the road is subject to EPA's in-use, on-the-road emission standards.<sup>18</sup> These testing data further show that NO<sub>x</sub> emissions from heavy-duty diesel vehicles are high during many periods of vehicle operation that are not subject to current on-the-road emission standards. For example, "low-load" engine conditions occur when a vehicle operates in stop-and-go traffic or is idling; these low-load conditions can result in exhaust temperature decreases that then lead to the diesel engine's selective catalytic reduction (SCR)-based emission control system becoming less effective or ceasing to function. Test data collected as part of EPA's manufacturer-run in-use testing program indicate that this low-load operation could account for more than half of the NO<sub>x</sub> emissions from a

<sup>14</sup>Hamady, Fakhri, Duncan, Alan. "A Comprehensive Study of Manufacturers In-Use Testing Data Collected from Heavy-Duty Diesel Engines Using Portable Emissions Measurement System (PEMS)." 29th CRC Real World Emissions Workshop, March 10–13, 2019.

<sup>15</sup>Sandhu, Gurdas, et al. "Identifying Areas of High NO<sub>x</sub> Operation in Heavy-Duty Vehicles". 28th CRC Real-World Emissions Workshop, March 18–21, 2018.

<sup>16</sup>Sandhu, Gurdas, et al. "In-Use Emission Rates for MY 2010+ Heavy-Duty Diesel Vehicles". 27th CRC Real-World Emissions Workshop, March 26–29, 2017.

<sup>17</sup>As noted in Section C of this Executive Summary and discussed in Section III, testing engines and vehicles while they are operating over the road without a defined duty cycle is referred to as "off-cycle" testing; as detailed in Section III, we are proposing new off-cycle test procedures and standards as part of this rulemaking.

<sup>18</sup>Heavy-duty CI engines are currently subject to off-cycle standards that are not limited to specific test cycles, but we use the term "on-the-road" here for readability.

vehicle during a typical workday.<sup>19</sup> Similarly, heavy-duty SI engines also operate in conditions where their catalyst technology becomes less effective, resulting in higher levels of air pollutants; however, unlike CI engines, it is sustained medium-to-high load operation where emission levels are less certain.

As noted in this Section A.2 of the Executive Summary, deterioration and mal-maintenance of the engine's emission control system is also projected to result in NO<sub>x</sub> emissions that would represent a substantial part of the HD inventory in 2045. To address this problem, as part of our comprehensive approach, both proposed Options 1 and 2 include longer regulatory useful life and emission-related warranty requirements that would maintain emission control through more of the operational life of heavy-duty vehicles (see Section IV for more discussion on the proposed useful life and warranty requirements).

Reducing NO<sub>x</sub> emissions from heavy-duty vehicles would address health and environmental issues raised by state, local, and Tribal agencies in their comments on the Advance Notice of Proposed Rule (ANPR).<sup>20</sup> In addition to concerns about meeting the ozone and PM<sub>2.5</sub> NAAQS, they expressed concerns about environmental justice, regional haze, and damage to terrestrial and aquatic ecosystems. They mentioned the impacts of NO<sub>x</sub> emissions on numerous locations, such as the Chesapeake Bay, Narragansett Bay, Long Island Sound, Joshua Tree National Park and the surrounding Mojave Desert, the Adirondacks, and other areas. Tribes and agencies commented that NO<sub>x</sub> deposition into lakes is harmful to fish and other aquatic life forms on which they depend for subsistence livelihoods. They also commented that regional haze and increased rates of weathering caused by pollution are of particular concern and can damage culturally significant archeological sites.

### 3. The Historic Opportunity for Clean Air Provided by Zero-Emission Vehicles

We are at the early stages of a significant transition in the history of the heavy-duty on-highway sector—a shift to zero-emission vehicle (ZEV) technologies. This change is underway and presents an opportunity for

significant reductions in heavy-duty vehicle emissions. Major trucking fleets, manufacturers and U.S. states have announced plans to transition the heavy-duty fleet to zero-emissions technology, and over just the past few years we have seen the early introduction of zero-emission technology into a number of heavy-duty vehicle market segments.

Executive Order 14037 identifies three potential regulatory actions for EPA to consider: (1) This proposed rule for heavy-duty vehicles for new criteria pollutant standards and strengthening of the Model Year 2027 GHG standards; (2) a separate rulemaking to establish more stringent criteria and GHG emission standards for medium-duty vehicles for Model Year 2027 and later (in combination with light-duty vehicles); and (3) a third rulemaking to establish new GHG standards for heavy-duty vehicles for Model Year 2030 and later. This strategy will establish the EPA regulatory path for the future of the heavy-duty vehicle sector, and in each of these actions EPA will consider the critical role of ZEVs in enabling stringent emission standards.

In addition to the proposed standards and requirements for NO<sub>x</sub> and other air pollutant emissions, we are also proposing targeted revisions to the already stringent HD GHG Phase 2 rulemaking, which EPA finalized in 2016.<sup>21</sup> The HD GHG Phase 2 program includes GHG emission standards tailored to certain regulatory vehicle categories in addition to heavy-duty engines including: Combination tractors; vocational vehicles; and heavy-duty pickup trucks and vans. The HD GHG Phase 2 program includes progressively more stringent CO<sub>2</sub> emission standards for HD engines and vehicles; these standards phase in starting in MY 2021 through MY 2027. The program built upon the GHG Phase 1 program promulgated in 2011, which set the first-ever GHG emission standards for heavy-duty engines and trucks.<sup>22</sup>

When the HD GHG Phase 2 rule was promulgated in 2016, we established the Phase 2 GHG standards and advanced technology incentives on the premise that electrification of the heavy-duty market was unlikely to occur in the timeframe of the program. However, several factors have arisen since the

adoption of Phase 2 that have changed our outlook for heavy-duty electric vehicles. First, the heavy-duty market has evolved such that in 2021, there are a number of manufacturers producing fully electric heavy-duty vehicles in a number of applications. Second, the State of California has adopted an Advanced Clean Trucks program that includes a manufacturer sales requirement for zero-emission truck sales, specifically that “manufacturers who certify Class 2b–8 chassis or complete vehicles with combustion engines would be required to sell zero-emission trucks as an increasing percentage of their annual California sales from 2024 to 2035.”<sup>23</sup> Finally, other states have signed a Memorandum of Understanding establishing goals to increase the heavy-duty electric vehicle market.<sup>24</sup> We are proposing that further GHG reductions in the MY 2027 timeframe are appropriate considering lead time, costs, and other factors, including these developments to zero-emission technologies in certain segments of the heavy-duty vehicle sector. We discuss the impacts of these factors on the heavy-duty market in Section XI. As outlined in Section I.B and detailed in Section XI, we are proposing to increase the stringency of the existing MY 2027 standards for many of the vocational vehicle and tractor subcategories, specifically those where we project early introduction of ZEVs. We are also considering whether it would be appropriate in the final rule to increase the stringency of the standards even more than what we propose for MYs 2027–2029, including the potential for progressively more stringent CO<sub>2</sub> standards across these three model years. Progressively strengthening the stringency of the standards for model years 2028 and 2029 could help smooth the transition to ambitious greenhouse gas standards for the heavy-duty sector starting as soon as model year 2030. We believe there is information and data that could support higher projected penetrations of HD ZEVs in the MY 2027 to 2029 timeframe and we request comment and additional supporting information and data on higher penetration rates, which could serve as the basis for the increase in the stringency of the CO<sub>2</sub> standards for specific Phase 2 vehicle subcategories. For example, what information and data are available that

<sup>19</sup> Sandhu, Gurdas, et al. “Identifying Areas of High NO<sub>x</sub> Operation in Heavy-Duty Vehicles”. 28th CRC Real-World Emissions Workshop, March 18–21, 2018.

<sup>20</sup> The Agency published an ANPR on January 21, 2020 to present EPA's early thinking on this rulemaking and solicit feedback from stakeholders to inform this proposal (85 FR 3306).

<sup>21</sup> 81 FR 73478 (October 25, 2016). Note that the HD GHG Phase 2 program also includes coordinated fuel efficiency standards established by the U.S. Department of Transportation through the National Highway Traffic Safety Administration, and those standards were established in a joint rulemaking process with EPA.

<sup>22</sup> 76 FR 57106, September 15, 2011.

<sup>23</sup> CARB. “Notice of Decision: Advanced Clean Truck Regulation.” June 2020. Available online at: <https://ww3.arb.ca.gov/regact/2019/act2019/nod.pdf>.

<sup>24</sup> Fifteen states and one district sign Multi-State MOU. <https://www.nescuum.org/documents/multistate-truck-zev-governors-mou-20200714.pdf>.

would support HD ZEV penetration rates of 5 percent or 10 percent (or higher) in this timeframe, and in what HD vehicle applications and categories. We are also requesting comment on an aspect of the HD GHG Phase 2 advanced technology incentive program.

EPA has heard from a number of stakeholders urging EPA to put in place policies to rapidly advance ZEVs in this current rulemaking, and to establish standards requiring 100 percent of all new heavy-duty vehicles be zero-emission no later than 2035. The stakeholders state that accelerating ZEV technologies in the heavy-duty market is necessary to prioritize environmental justice in communities that are impacted by freight transportation and already overburdened by pollution.<sup>25</sup> One policy EPA has been asked to consider is the establishment of a ZEV sales mandate (*i.e.*, a nationwide requirement for manufacturers to produce a portion of their new vehicle fleet as ZEVs). EPA is not proposing in this action to establish a heavy-duty ZEV mandate. EPA in this action is considering how the development and deployment of ZEVs can further the goals of environmental protection and best be reflected in the establishment of EPA's standards and regulatory program for MY 2027 and later heavy-duty vehicles. As discussed earlier in this section, EPA will also be considering the important role of ZEV technologies in the upcoming light-duty and medium-duty vehicle proposal for MY 2027 and later, and in the heavy-duty vehicle proposal for MY 2030 and later. EPA requests comment under this proposal on how the Agency can best consider the potential for ZEV technologies to significantly reduce air pollution from the heavy-duty vehicle sector (including but not limited to the topic of whether and how to consider including specific sales requirements for HD ZEVs).

#### 4. Statutory Authority for This Action

As discussed in Section I, EPA is proposing revisions to emission standards and other requirements applicable to emissions of NO<sub>x</sub>, PM, HC, CO, and GHG from new heavy-duty engines and vehicles under our broad statutory authority to regulate air pollutants emitted from mobile sources, consistent with our history of using a multi-pollutant approach to regulating criteria pollutants and GHG emissions from heavy-duty engines and vehicles. Section 202(a)(1) of the Clean Air Act

(CAA) requires the EPA to “by regulation prescribe (and from time to time revise) . . . standards applicable to the emission of any air pollutant from any class or classes of new motor vehicles or new motor vehicle engines . . . , which in his judgment cause, or contribute to, air pollution which may reasonably be anticipated to endanger public health or welfare”. Standards under CAA section 202(a) take effect “after such period as the Administrator finds necessary to permit the development and application of the requisite technology, giving appropriate consideration to the cost of compliance within such period.” Thus, in establishing or revising CAA section 202(a) standards designed to reduce air pollution that endangers public health and welfare, EPA also must consider issues of technological feasibility, compliance cost, and lead time. EPA may consider other factors such as safety. There are currently heavy-duty engine and vehicle standards for emissions of NO<sub>x</sub>, PM, HC, CO, and GHGs.

Under CAA section 202(a)(3)(A), standards for emissions of NO<sub>x</sub>, PM, HC, and CO emissions from heavy-duty vehicles and engines are to “reflect the greatest degree of emission reduction achievable through the application of technology which the Administrator determines will be available for the model year to which such standards apply, giving appropriate consideration to cost, energy, and safety factors associated with the application of such technology.”<sup>26</sup> Section 202(a)(3)(C) requires that these standards apply for no less than 3 model years and apply no earlier than 4 years after promulgation.

Emission standards set under CAA section 202(a) apply to vehicles and engines “for their useful life.” CAA section 202(d) directs EPA to prescribe regulations under which the useful life of vehicles and engines shall be determined, and for heavy-duty vehicles and engines establishes minimum values of 10 years or 100,000 miles, whichever occurs first, unless EPA determines that greater values are appropriate. CAA section 207(a) further requires manufacturers to provide an emissions warranty, and EPA set the current warranty periods for heavy-duty engines in 1983.<sup>27</sup>

As outlined in this executive summary, the proposed program would reduce heavy-duty emissions through

several major provisions pursuant to the CAA authority described in this section. Sections I.F and XIV of this preamble further discuss our statutory authority for this proposal; Section I.G further describes the basis of our proposed NO<sub>x</sub>, PM, HC, CO, and GHG emission standards and other requirements. Section XIII describes how this proposal is also consistent with E.O. 14037, “Strengthening American Leadership in Clean Cars and Trucks” (August 5, 2021), which directs EPA to consider taking action to establish new NO<sub>x</sub> standards for heavy-duty engines and vehicles beginning with model year 2027.

#### B. Overview of the Regulatory Action

Our approach to further reduce air pollution from highway heavy-duty engines and vehicles through the proposed program features several key provisions. We co-propose options to address criteria pollutant emissions from heavy-duty engines. In addition, this proposal would make targeted updates to the existing Heavy-Duty Greenhouse Gas Emissions Phase 2 program, proposing that further GHG reductions in the MY 2027 timeframe are appropriate considering lead time, costs, and other factors, including market shifts to zero-emission technologies in certain segments of the heavy-duty vehicle sector. We also propose limited amendments to the regulations that implement our air pollutant emission standards for other sectors (*e.g.*, light-duty vehicles, marine diesel engines, locomotives, various types of nonroad engines, vehicles, and equipment). Our proposed provisions are briefly described in this Section I.B and summarized in Section I.C. We describe the proposed Options 1 and 2 in detail in the Sections III, IV, and XI. We discuss our analyses of estimated emission reductions, air quality improvements, costs, and monetized benefits of the proposed program in Section I.D below, and these are detailed in Sections V through X.

#### 1. Overview of Criteria Pollutant Program

The proposed provisions to reduce criteria pollutant emissions can be thought of in three broad categories: (1) Controlling emissions under a broader range of engine operating conditions, (2) maintaining emission control over a greater portion of an engine's operational life,<sup>28</sup> and (3) providing manufacturers with flexibilities to meet

<sup>25</sup> Letter to EPA Administrator Michael Regan from the Moving Forward Network. October 26, 2021.

<sup>26</sup> Section 202(a)(3)(A) and (C) apply only to regulations applicable to emissions of these four pollutants and do not apply to regulations applicable to GHGs.

<sup>27</sup> 48 FR 52170, November 16, 1983.

<sup>28</sup> As further discussed in Section IV.A, we use “operational life” to refer to when engines are in use on the road.

the proposed standards while clarifying our regulations. Specifically, provisions in the first category would include updated test procedures and revised emission standards, while those in the second category would include lengthened regulatory useful life and emission warranty periods, as well as several other updates to encourage proper maintenance and repair. These provisions would apply to heavy-duty engines used in Class 2b through 8 vehicles.<sup>29</sup> Provisions in the third category would provide opportunities to generate NO<sub>x</sub> emission credits that provide manufacturers with flexibilities to meet the proposed standards and encourage the introduction of new emission control technologies earlier than required. This category also includes our proposal to modernize our current regulatory text, including clarifications and updates for hybrid electric, battery-electric, and fuel cell electric heavy-duty vehicles.

Our discussion below focuses on the revised emission standards and useful life and warranty periods contained in two regulatory options that we are proposing: The proposed Option 1 and the proposed Option 2. Although we refer to the two regulatory options as the proposed Option 1 and the proposed Option 2, we are giving full consideration to both options, as well as the full range of options between them. Both the proposed Option 1 and the proposed Option 2 would begin in MY 2027, but the proposed Option 1 would have a second step in MY 2031. Overall, proposed Option 2 is less stringent than the MY 2031 standards in the proposed Option 1 because the proposed Option 2 has higher numeric NO<sub>x</sub> emission standards and shorter useful life periods. As discussed in Section D of this Executive Summary and Section VI, we project proposed Option 1 would result in greater emission reductions than proposed Option 2; Section I.G summarizes the basis of our proposed Options 1 and 2 with details on our feasibility analysis for each option presented in Section III. In addition to the proposed Options 1 and 2, we present an alternative (the Alternative) that we also considered. The Alternative is more stringent than either the proposed Option 1 MY 2031 standards or the proposed Option 2 because the

Alternative has shorter lead time, lower numeric NO<sub>x</sub> emission standards and longer useful life periods. We note that we currently are unable to conclude that the Alternative is feasible in the MY 2027 timeframe over the useful life periods in the Alternative in light of deterioration in the emission control technologies that we have evaluated to date, and we expect that we would need additional supporting data or other information in order to determine that the Alternative is feasible in the MY 2027 timeframe to consider adopting it in the final rule.

The proposed Option 1 and proposed Option 2 generally represent the range of regulatory options, including the standards and test procedures, regulatory useful life and emission-related warranty periods and implementation schedules that we are currently considering in this rulemaking, depending in part on any additional comments and other information we receive on the feasibility, costs, and other impacts of the proposed Options 1 and 2. We request comment on all aspects of the proposed Options 1 and 2, or other alternatives roughly within the range of options covered by the proposed Options 1 and 2, including the revised emission standards and useful life and warranty periods, one and two-step approaches, model years of implementation and other provisions described in this proposal. Based on currently available information, in order to consider adopting the Alternative in the final rule, we believe we would need additional supporting data or other information to be able to conclude that the Alternative is feasible in the MY 2027 timeframe. We request comment, including relevant data and other information, related to the feasibility of the implementation model year, numeric levels of the emission standards, and useful life and warranty periods included in the Alternative, or other alternatives outside the range of options covered by the proposed Options 1 and 2.

We will continue learning about the capability and durability of engine and aftertreatment technologies through our ongoing technology evaluations, as well as any information provided in public comments on this proposal. Section III describes our plans for expanding on the analyses developed for this proposal.

## 2. Overview of Targeted Revisions to the HD GHG Phase 2 Program

In addition to the proposed criteria pollutant program provisions, we are proposing to increase the stringency of

the existing GHG standards for MY 2027 trucks and requesting comment on updates to the advanced technology incentive program for electric vehicles. We propose updates to select MY 2027 GHG standards after consideration of the market shifts to zero-emission technologies in certain segments of the heavy-duty vehicle sector. These proposed GHG provisions are based on our evaluation of the heavy-duty EV market for the MY 2024 through 2027 timeframe. While the HD Phase 2 GHG standards were developed in 2016 based on the premise that electrification of the heavy-duty market beyond low volume demonstration projects was unlikely to occur in the timeframe of the program, our current evaluation shows that there are a number of manufacturers producing fully electric heavy-duty vehicles in several applications in 2021—and this number is expected to grow in the near term. These developments along with considerations of lead time, costs and other factors have demonstrated that further GHG reductions in the MY 2027 timeframe are appropriate. We expect school buses, transit buses, delivery trucks (such as box trucks or step vans), and short haul tractors to have the highest EV sales of all heavy-duty vehicle types between now and 2030.<sup>30</sup> We have given careful consideration to an approach that would result in targeted updates to reflect the emerging HD EV market without fundamentally changing the HD GHG Phase 2 program as a whole. Thus, we are proposing targeted updates to the HD Phase 2 GHG standards to account for the current electrification of the market by making changes to only those standards that are impacted by these four types of electric vehicles. We believe this proposal considered the feasibility of technologies, cost, lead time, emissions impact, and other relevant factors, and therefore these standards are appropriate under CAA section 202(a). We also are seeking comment on changes to the advanced technology credit program since the current level of HD GHG Phase 2 incentives for electrification may no longer be appropriate for certain segments of the HD EV market considering the projected rise in electrification. We provide an overview of this approach in this Section I.C and detail our proposal in Section XI.

<sup>30</sup> See Section XI.B for more on the growing EV market for these four vehicle types.

<sup>29</sup> EPA plans to consider new standards for chassis-certified Class 2b and 3 vehicles (GVWR between 8,500 and 14,000 pounds) as part of a future combined light-duty and medium-duty rulemaking action, consistent with E.O. 14037. We are not proposing changes to the standards or test procedures for chassis-certified heavy-duty vehicles. Instead, this proposal focuses on engine-certified products.



C. Summary of the Major Provisions in the Regulatory Action

1. Controlling Criteria Pollutant Emissions Under a Broader Range of Engine Operating Conditions

In the first broad category of provisions to reduce criteria pollutant emissions in this rulemaking, we are proposing to reduce emissions from heavy-duty engines under a range of operating conditions through revisions to our emissions standards and test procedures. These revisions would apply to both laboratory-based standards and test procedures for both heavy-duty CI and SI engines, as well as the standards and test procedures for heavy-duty CI engines on the road in the real world.<sup>31</sup>

i. Proposed Laboratory Standards and Test Procedures

For heavy-duty CI engines, we are proposing new standards for laboratory-based tests using the current duty cycles, the transient Federal Test Procedure (FTP) and the steady-state Supplemental Emission Test (SET) procedure. These existing test procedures require CI engine manufacturers to demonstrate the effectiveness of emission controls when the engine is transitioning from low-to-high loads or operating under sustained high load, but do not provide for demonstrating emission control under sustained low-load operations. We are proposing that laboratory demonstrations for heavy-duty CI

engines would also include a new low-load cycle (LLC) test procedure to demonstrate that emission controls are meeting proposed LLC standards when the engine is operating under low-load and idle conditions. The proposed addition of the LLC would help ensure lower NO<sub>x</sub> emissions in urban areas and other locations where heavy-duty vehicles operate in stop-and-go traffic or other low-load conditions.

For heavy-duty SI engines, we are proposing new standards for their laboratory demonstrations using the current FTP duty cycle, and updates to the current engine mapping procedure to ensure the engines achieve the highest torque level possible during testing. We are proposing to add the SET procedure to the heavy-duty SI laboratory demonstrations; it is currently only required for heavy-duty CI engines. Heavy-duty SI engines are increasingly used in larger heavy-duty vehicles, which makes it more likely for these engines to be used in higher-load operations covered by the SET. We are further proposing a new refueling emission standard for incomplete vehicles above 14,000 lb GVWR starting in MY 2027.<sup>32</sup> The proposed refueling standard is based on the current refueling standard that applies to complete heavy-duty gasoline-fueled vehicles. Consistent with the current evaporative emission standards that apply for these same vehicles, we are proposing that manufacturers could use an engineering analysis to demonstrate

that they meet our proposed refueling standard.

Our proposed Option 1 and proposed Option 2 NO<sub>x</sub> emission standards for all defined duty cycles for heavy-duty CI and SI engines are detailed in Table 1. As shown, the proposed Option 1 NO<sub>x</sub> standards would be implemented in two steps beginning with MY 2027 and becoming more stringent in MY 2031. The proposed Option 2 NO<sub>x</sub> emission standards would be implemented with a single step in MY 2027. As noted in Section B.1 of this Executive Summary, overall, we consider proposed Option 2 to be less stringent than the standards in the proposed Option 1 because proposed Option 2 has higher numeric NO<sub>x</sub> emission standards with similar useful life periods as the proposed Option 1 in MY 2027, and shorter length of useful life periods than the proposed Option 1 in MY 2031. In contrast, the Alternative is more stringent than proposed Option 1's MY 2031 standards (see Section III), and we currently do not have information to support the conclusion that the combination of shorter lead time, lower numeric levels of the standards and longer useful life periods in the Alternative is feasible in the MY 2027 timeframe based on the emission control technologies we have evaluated to date. See Section III for more discussion on feasibility. Consistent with our current approach for criteria pollutants, the standards in proposed Options 1 and 2, presented in Table 1, are numerically identical for SI and CI engines.<sup>33</sup>

TABLE 1—PROPOSED OPTIONS 1 AND 2 NO<sub>x</sub> EMISSION STANDARDS FOR HEAVY-DUTY CI AND SI ENGINES ON SPECIFIC DUTY CYCLES

[Milligrams/horsepower-hour (mg/hp-hr)]<sup>a</sup>

Duty cycle	Proposed Option 1				Proposed Option 2
	Model years 2027–2030	Model years 2031 and later			Model years 2027 and later
		All HD engines	Spark ignition HDE, light HDE, and medium HDE	Heavy HDE through intermediate useful life (IUL)	Heavy HDE from IUL to full useful life (FUL)
FTP (transient mid/high load conditions) .....	35	20	20	40	50
SET (steady-state conditions) .....	35	20	20	40	50
LLC (low-load conditions) .....	90	50	50	100	100

<sup>a</sup> The current FTP and SET standard for all HD engines is 0.20 g/hp-hr or 200 mg/hp-hr; we are proposing the LLC test procedure and therefore there is not a current standard for the LLC.

<sup>31</sup> Duty cycle test procedures measure emissions while the engine is operating over precisely defined duty cycles in an emissions testing laboratory and provide very repeatable emission measurements. “Off-cycle” test procedures measure emissions while the engine is not operating on a specified duty-cycle; this testing can be conducted while the engine is being driven on the road (e.g., on a package delivery route), or in an emission testing

laboratory. We may also refer to off-cycle test procedures in this preamble as “on the road” testing for simplicity. Both duty cycle and off-cycle testing are conducted pre-production (e.g., for certification) or post-production to verify that the engine meets applicable duty cycle or off-cycle emission standards throughout useful life (See Section III.A and IV.K for more discussion).

<sup>32</sup> Some vehicle manufacturers sell their engines or “incomplete vehicles” (i.e., chassis that include their engines, the frame, and a transmission) to body builders who design and assemble the final vehicle.

<sup>33</sup> See Section III for our proposed and alternative PM, HC, and CO standards.

ii. Proposed On-the-Road Standards and Test Procedures

In addition to demonstrating emission control over defined duty cycles in a laboratory, heavy-duty CI engines must be able to demonstrate emission control over an undefined duty cycle while engines are in use on the road in the real world. Both proposed Options 1 and 2 include updates to the procedure for “off-cycle” testing, such that data collected during a wider range of operating conditions would be valid, and therefore subject to emission standards.<sup>34</sup>

Similar to the current approach, emission measurements collected during off-cycle testing would be collected on a second-by-second basis. We are proposing the emissions data would be grouped into 300-second windows of operation. Each 300-second window would then be binned based on the type of operation that the engine performs during that 300-second period.

Specifically, the average power of the engine during each 300-second window would determine whether the emissions during that window are binned as idle (Bin 1), low-load (Bin 2), or medium-to-high load (Bin 3).<sup>35</sup>

Our proposed 3-bin approach would cover a wide range of operations that occur in the real world—significantly more in-use operation than today’s requirements. Bin 1 would include extended idle and other very low-load operations, where engine exhaust temperatures may drop below the optimal temperature where SCR-based aftertreatment works best. Bin 2 would include a large fraction of urban driving conditions, during which engine exhaust temperatures are generally moderate. Bin 3 would include higher-power operations, such as on-highway driving that typically results in higher exhaust temperatures and high catalyst efficiencies.<sup>36</sup> Given the different operational profiles of each of these

three bins, we are proposing a separate standard for each bin. The proposed structure follows that of our current not-to-exceed (NTE) off-cycle standards, while covering a much broader range of engine operation.

Table 2 presents our proposed Option 1 and Option 2 off-cycle standards for NO<sub>x</sub> emissions from heavy-duty CI engines. The proposed Option 2 off-cycle NO<sub>x</sub> standards are higher (less stringent) and have a shorter useful life than the proposed Option 1 standards in MY 2031. For the Alternative, our assessment of currently available data indicates that the off-cycle standard for the medium/high load bin (Bin 3) would not be feasible in the MY 2027 timeframe, and additional or different technology would be necessary to meet the Alternative off-cycle standards. See Section III for details on the off-cycle standards for other pollutants in the proposed Options 1 and 2 and the Alternative.

TABLE 2—PROPOSED OPTIONS 1 AND 2 OFF-CYCLE NO<sub>x</sub> STANDARDS FOR HEAVY-DUTY CI ENGINES

Operation bin	Proposed Option 1				Proposed Option 2
	Model years 2027–2030	Model years 2031 and later			Model years 2027 and later
		All HD engines	Light HDE, and medium HDE	Heavy HDE through IUL	
idle (g/hr) .....	10	7.5	7.5	7.5	15
low load (mg/hp-hr) .....	180	75	7.5	150	150
medium/high load (mg/hp-hr) .....	70	30	30	60	75

In addition to the proposed standards for the defined duty cycle and off-cycle test procedures, the proposed Options 1 and 2 include several other provisions for controlling emissions from specific operations in CI or SI engines. First, we are proposing to allow CI engine manufacturers to voluntarily certify to the California Air Resources Board (CARB) clean idle standards by adding to EPA regulations an idle test procedure that is based on an existing CARB procedure.<sup>37</sup> We are also proposing to require a closed crankcase ventilation system for all highway CI engines to prevent crankcase emissions from being emitted directly to the atmosphere. See Section III.B for more discussion on both the proposed idle and crankcase provisions. For heavy-duty SI, we are proposing refueling

emission standards for incomplete vehicles above 14,000 lb GVWR (see Section III.E for more discussion).

2. Maintaining Criteria Pollutant Emission Control Over a Greater Portion of an Engine’s Operational Life

Reducing emissions under a broad range of engine operating conditions is one category of our proposed program provisions. Maintaining emission control over a greater portion of an engine’s operational life is the second broad category of proposed provisions. The major elements in this category include proposals to (1) extend the regulatory useful life of heavy-duty engines, (2) provide an opportunity for manufacturers to use rapidly aged parts necessary to demonstrate emission performance over the regulatory useful

life, (3) lengthen emission warranty periods, and 4) increase the likelihood that emission controls will be maintained properly through more of the service life of heavy-duty engines. Our proposals for each of these elements is outlined below and detailed in Section IV; unless explicitly stated otherwise, proposals for each of these elements would apply under both proposed Options 1 and 2, as well as the full range of options in between them.

i. Proposed Useful Life Periods

EPA is proposing to increase the regulatory useful life mileage values for new heavy-duty engines to better reflect real-world usage, extend the emissions durability requirement for heavy-duty engines, and ensure certified emission performance is maintained throughout

<sup>34</sup> As discussed in Section III, “off-cycle” testing measures emissions while the engine is not operating on a specified duty-cycle; this testing can be conducted while the engine is being driven on the road (e.g., on a package delivery route), or in an emission testing laboratory.

<sup>35</sup> Due to the challenges of measuring engine power directly on in-use vehicles, we are proposing

to use the CO<sub>2</sub> emission rate (grams per second) as a surrogate for engine power; further, we propose to normalize CO<sub>2</sub> emission rates relative to the nominal maximum CO<sub>2</sub> rate of the engine (e.g., when an engine with a maximum CO<sub>2</sub> emission rate of 50 g/sec emits at a rate of 10 g/sec, its normalized CO<sub>2</sub> emission rate is 20 percent).

<sup>36</sup> Because the proposed approach considers time-averaged power, any of the bins could include some idle operation and any of the bins could include some high-power operation.

<sup>37</sup> 13 CCR 1956.8 (a)(6)(C)—Optional NO<sub>x</sub> idling emission standard.

more of an engine’s operational life. For proposed Option 1, Increases to useful life values for heavy-duty engines would apply in two steps, as discussed in Section IV.A. For the first step for CI engines, MY 2027 through 2030, we are proposing useful life mileage values that are approximately a midpoint between the current useful life mileages and our proposed CI engines MY 2031 and later mileages. For the second step, we are proposing useful life mileage values for MY 2031 and later CI engines that cover

a majority of the estimated operational life mileages, but less than the first out-of-frame rebuild for these engines. The proposed Option 1 first step for SI engines in MY 2027 through 2030 would better align with the current useful life mileages for GHG emission standards applicable to these engines. The proposed Option 1 second step useful life mileage for SI engines for MY 2031 and later is based on the published engine service life for heavy-duty gasoline engines in the market today.

The useful life mileages in the proposed Option 2 are shorter than those in the proposed Option 1; we are giving full consideration to the useful life periods of proposed Options 1 and 2, and the range between the useful life periods in the proposed Options. Our proposed Option 1 and Option 2 useful life periods for heavy-duty CI and SI engines are presented in Table 3. See Section IV for the useful periods of the Alternative.<sup>38</sup>

TABLE 3—PROPOSED OPTIONS 1 AND 2 USEFUL LIFE PERIODS FOR HEAVY-DUTY CI AND SI ENGINES CRITERIA POLLUTANT STANDARDS

Model year	Spark-ignition HDE		Compression-ignition					
	Miles	Years	Light HDE		Medium HDE		Heavy HDE <sup>b,c</sup>	
			Miles	Years	Miles	Years	Miles	Years
Current <sup>a</sup> .....	110,000	10	110,000	10	185,000	10	435,000	10
Proposed Option 1: 2027–2030 .....	155,000	12	190,000	12	270,000	11	600,000	11
Proposed Option 1 <sup>d</sup> : 2031 and later .....	200,000	15	270,000	15	350,000	12	800,000	12
Proposed Option 2: 2027 and later .....	150,000	10	250,000	10	325,000	10	650,000	10

<sup>a</sup>Current useful life period for Spark-ignition HDE and Light HDE for GHG emission standards is 15 years or 150,000 miles. See 40 CFR 1036.108(d).

<sup>b</sup>We are also proposing to increase the hours-based useful life criterion from the current 22,000 hours for Heavy HDE to 32,000 hours for model years 2027–2030 and 40,000 hours for model years 2031 and later.

<sup>c</sup>The Heavy HDE class includes certain SI engines (e.g., natural gas-fueled engines) intended for use in Class 8 vehicles.

<sup>d</sup>For MY 2031 and later Heavy HDE, the proposed Option 1 would include intermediate useful life periods of 435,000 miles, 10 years, or 22,000 hours, whichever comes first. See Section III for a discussion of the proposed Option 1 standards we propose to apply for the intermediate and full useful life periods.

ii. Proposed Durability Demonstration Updates

The proposed longer useful life periods outlined in Table 3 would require manufacturers to extend their durability demonstrations, which show that the engines will meet applicable emission standards throughout their regulatory useful life. EPA regulations require manufacturers to include durability demonstration data as part of an application for certification of an engine family. Manufacturers typically complete this demonstration by following regulatory procedures to calculate a deterioration factor (DF).

To address the need for accurate and efficient emission durability demonstration methods, EPA worked with manufacturers and CARB to address this concern through guidance for MY 2020 and later engines.<sup>39</sup> In Section IV.F, we propose three methods for determining DFs, consistent with the recent guidance, including a new option to bench-age the aftertreatment system to limit the burden of generating a DF over the proposed lengthened useful life

periods. We also propose to codify in the EPA regulations three DF verification options available to manufacturers in recent guidance. The proposed verification options would confirm the accuracy of the DF values submitted by manufacturers for certification. We also introduce a test program to evaluate a rapid-aging protocol for diesel catalysts that we may consider as an option for CI engine manufacturers to use in their durability demonstration.

iii. Proposed Emissions Warranty Periods

EPA’s current emission-related warranty periods range from 22 percent to 54 percent of regulatory useful life. As EPA is proposing to lengthen the useful life periods in this rulemaking, we are also proposing to lengthen the emission warranty periods and increase the fraction of useful life miles covered under warranty. These proposed revised warranty periods are expected to result in better engine maintenance and less tampering, helping to maintain the

benefits of the emission controls. In addition, longer regulatory warranty periods may lead engine manufacturers to simplify repair processes and make them more aware of system defects that would be tracked and reported to EPA over a longer period.

In Section IV.B, we provide detailed discussion and request comment on these four ways that longer emission warranty periods may enhance long-term performance of emission-related devices and systems. We also discuss other impacts of lengthening regulatory emission warranty periods and other approaches that vary coverage and may similarly ensure long-term in-use emission performance.

EPA is proposing to lengthen the emissions warranty periods for all primary intended service classes to cover a larger portion of the operational lives of new heavy-duty engines. Our proposed Option 1 warranty mileages for MY 2031 are approximately 80 percent of the proposed useful life mileages. The proposed Option 1 MY 2027 through 2030 mileages are

<sup>38</sup> As noted in this Section C of the Executive Summary, we are proposing refueling standards for HD SI engines that are certified as incomplete vehicles that are equivalent to the standards in effect for complete heavy-duty vehicles. We propose to apply the existing useful life periods for

the complete vehicle refueling standards (15 years or 150,000 miles; see 40 CFR 1037.103(f) and 86.1805–16(d) for “MDPV” and “HDV”) to the HD SI engines certified as incomplete vehicles. See preamble Section IV.A for more details.

<sup>39</sup> U.S. EPA. “Guidance on Deterioration Factor Validation Methods for Heavy-Duty Diesel Highway Engines and Nonroad Diesel Engines equipped with SCR.” CD–2020–19 (HD Highway and Nonroad). November 17, 2020.

approximately midpoints between the current and proposed Option 1 MY 2031 and later mileages. The proposed Option 2 set of emission warranty periods would match CARB’s Step 1 warranty periods that will already be in effect beginning in model year 2022 for engines sold in California.<sup>40</sup> We believe

the proposed Option 2 mileages represent an appropriate lower end of the range we are considering for the revised regulatory emission warranty periods. Our proposed Option 1 and proposed Option 2 emission warranty periods are presented in Table 4.<sup>41</sup> See Section IV.B for updates in proposed

Options 1 and 2 to our years-based warranty periods and add hours-based warranty periods for all engine classes to cover low average annual mileage applications. We also considered an alternative set of warranty periods that are presented in Section IV.B.

TABLE 4—PROPOSED OPTIONS 1 AND 2 EMISSION-RELATED WARRANTY PERIODS FOR HEAVY-DUTY CI AND SI ENGINES CRITERIA POLLUTANT STANDARDS

Model year	Spark-ignition HDE		Compression-ignition						Years
	Miles	Hours	Light HDE		Medium HDE		Heavy HDE		
			Miles	Hours	Miles	Hours	Miles	Hours	
Current .....	50,000	NA	50,000	NA	100,000	NA	100,000	NA	5
Proposed Option 1: 2027–2030 .....	110,000	6,000	150,000	7,000	220,000	11,000	450,000	22,000	7
Proposed Option 1: 2031 and later	160,000	8,000	210,000	10,000	280,000	14,000	600,000	30,000	10
Proposed Option 2: 2027 and later	110,000	NA	110,000	NA	150,000	NA	350,000	NA	5

iv. Proposed Provisions To Ensure Long-Term Emissions Performance

In the ANPR, we introduced several ideas for an enhanced, comprehensive strategy to increase the likelihood that emission controls will be maintained properly through more of the operational life of heavy-duty engines, including beyond their useful life periods. Our proposed updates to maintenance provisions include defining the type of maintenance manufacturers may choose to recommend to owners in maintenance instructions, updating minimum maintenance intervals for certain critical emission-related components, and outlining specific requirements for maintenance instructions provided in the owner’s manual.

We are proposing changes to the owner’s manual and emissions label requirements to ensure access to certain maintenance information and improve serviceability. We expect this additional maintenance information to improve factors that contribute to mal-maintenance, which would result in better service experiences for independent repair technicians, specialized repair technicians, owners who repair their own equipment, and possibly vehicle inspection and maintenance technicians. We also

believe that improving owner experiences with operating and maintaining heavy-duty engines can reduce the likelihood of tampering.

v. Proposed Inducement Provisions

ANPR commenters indicated that engine derates or “inducements” are a significant source of operator frustration.<sup>42</sup> EPA currently has guidance on potential options manufacturers might utilize to meet existing requirements through an inducement strategy for their SCR-based aftertreatment system.<sup>43</sup> We are proposing to codify inducement provisions after considering manufacturer designs and operator experiences with SCR-based aftertreatment systems. In Section IV.D, we present the key principles we followed in developing the proposed inducement provisions, which includes a focus on conditions that are within an operator’s control, a multi-step derate schedule, and a backup check to override false inducements. We also include a detailed set of requests for comment highlighting the wide range of adjustments we are currently considering.

vi. Proposed Onboard Diagnostics Provisions

Onboard diagnostics (OBD) refer to systems of electronic controllers and sensors required by current regulation to detect malfunctions of engines and emission controls. EPA’s existing OBD program, promulgated in 2009, allows manufacturers to demonstrate how the OBD system they have designed to comply with California OBD requirements also complies with the intent of the EPA OBD requirements.<sup>44</sup> Although EPA maintains separate OBD regulations, all manufacturers currently seek OBD approval from CARB for OBD systems in engine families applying for 50-state certification, and then use this approval to demonstrate compliance with EPA requirements.

In Section IV.C, we are proposing to update our OBD regulations both to better address newer diagnostic methods and available technologies, and to streamline provisions where possible. We propose to incorporate by reference the existing CARB OBD regulations updated in 2019 as the starting point for our updated OBD regulations.<sup>45</sup> We are proposing to exclude or revise certain CARB provisions that we believe are not appropriate for a federal program and are proposing to include additional elements to improve the usefulness of

<sup>40</sup> For SI engines, the Alternative 1 warranty mileage matches the current useful life, consistent with the approach for Light HDE Alternative 1 warranty.

<sup>41</sup> In addition to exhaust standards, we are proposing refueling standards for HD SI engines that are certified as incomplete vehicles. The onboard refueling vapor recovery systems necessary to meet the proposed refueling standards will likely build on existing evaporative emissions systems, and we propose to apply the existing warranty periods for evaporative emission control systems to

the ORVR systems (5 years or 50,000 miles). See Preamble IV.B.1.

<sup>42</sup> Engine derating is an aftertreatment design strategy that reduces engine performance to induce operators to maintain appropriate levels of high-quality diesel emission fluid (DEF) in their SCR-based aftertreatment systems. Throughout this preamble we refer to engine derates that derive from DEF-related triggers as “inducements.”

<sup>43</sup> Kopin, Amy. Memorandum to docket EPA–HQ–OAR–2019–0055. “Inducement-Related

Guidance Documents, and Workshop Presentation.” October 1, 2021.

<sup>44</sup> See 40 CFR 86.010–18(a)(5).

<sup>45</sup> CARB Final Rulemaking to Consider Technical Status and Proposed Revisions to On-Board Diagnostic System Requirements for Heavy-Engines, Passenger Cars, Light-Duty Trucks, Medium Duty Vehicles and Engines was approved and became effective on July 31, 2013. California Code of Regulations sections 1968.2 and 1971.1 available at: <https://ww3.arb.ca.gov/regact/2012/hdodb2/hdodb2.htm>.

OBD systems for users (see Section IV.C for details).

EPA is specifically proposing additional OBD elements to improve the robustness and usefulness of OBD systems. These additional elements include emission system health monitors, an expanded list of publicly available OBD parameters, additional freeze frame data parameters, and enabling certain self-testing capabilities for owners. These proposed changes would benefit the environment by helping to reduce malfunctioning emission systems in-use through access to additional data that may be useful for service technicians, state and local inspection and maintenance operations, and owners.

### 3. Other Proposed Compliance Provisions and Flexibilities

In addition to the key program provisions, we are also proposing several provisions to provide manufacturers with flexibility to meet the proposed standards and encourage the introduction of new emission control technologies earlier than required; these provisions would apply under both proposed Options 1 and 2, as well as the full range of options in between them. These provisions include our proposal to migrate and update the compliance provisions of 40 CFR part 86, subpart A, to 40 CFR part 1036; continue averaging, banking, and trading (ABT) of credits generated against our heavy-duty engine criteria pollutant standards; provide incentives for early adoption of technologies to meet the standards; allow manufacturers to generate NO<sub>x</sub> emission credits for hybrid electric, battery electric, and fuel cell electric vehicles (HEVs, BEVs, and FCEVs); and make limited amendments to regulations that implement our air pollutant emission standards for other industry sectors, including light-duty vehicles, light-duty trucks, marine diesel engines, locomotives, and various types of nonroad engines, vehicles, and equipment.

#### i. Proposed Migration From 40 CFR Part 86, Subpart A

Heavy-duty criteria pollutant regulations were originally codified into 40 CFR part 86, subpart A, in the 1980s. We believe this rulemaking provides an opportunity to clarify (and otherwise improve) the wording of our existing heavy-duty criteria pollutant regulations in plain language and migrate them to 40 CFR part 1036.<sup>46</sup> Part 1036, which

<sup>46</sup> We are proposing to migrate some provisions to parts 1065 and 1068 to apply broadly to other sectors. Additionally, some current vehicle

was created for the Phase 1 GHG program, provides a consistent, updated format for our regulations, with improved organization. In general, this migration is not intended to change the compliance program previously specified in part 86, except as specifically proposed in this rulemaking. See our summary of the proposed migration in Section III.A, and additional details in our memorandum to the docket.<sup>47</sup> The proposed provisions of part 1036 would generally apply for model years 2027 and later, unless noted, and manufacturers would continue to use part 86 in the interim.

#### ii. Proposed Opportunities for NO<sub>x</sub> Emission Credits

We are proposing targeted revisions to the current emissions ABT provisions to account for specific aspects of the broader proposed program. We are also proposing an early adoption incentive program that would recognize the environmental benefits of lower-emitting vehicles entering the fleet ahead of required compliance dates for the proposed standards. Through this optional program, manufacturers who demonstrate early compliance with the proposed MY 2027 or MY 2031 standards would apply a multiplier to emission credits generated under the proposed ABT program (see Section IV.H for details). We are also proposing to offer NO<sub>x</sub> emission credits for HEVs, BEVs and FCEVs based on the near-zero or zero-tailpipe emissions performance of these technologies, for HEVs or BEVs and FCEVs, respectively, and after consideration of ANPR comments. We are choosing not to propose emission credit multipliers for HEVs, BEVs, and FCEVs. We believe that the potential loss of emission reductions that could result from providing credit multipliers is not justified in light of the current extent of technology development and implementation. Manufacturers choosing to generate NO<sub>x</sub> emission credits from BEVs or FCEVs would need to conduct testing and meet durability requirements discussed in Section IV.

#### iii. Other Amendments

EPA has promulgated emission standards for highway and nonroad engines, vehicles, and equipment. Section XII of this proposed rule

provisions in part 1037 refer to part 86 and we are proposing to update those references in part 1037 as needed.

<sup>47</sup> Stout, Alan; Brakora, Jessica. Memorandum to docket EPA-HQ-OAR-2019-0055. "Technical Issues Related to Migrating Heavy-Duty Highway Engine Certification Requirements from 40 CFR part 86, subpart A, to 40 CFR part 1036". October 1, 2021.

describes several amendments to correct, clarify, and streamline a wide range of regulatory provisions for many of those different types of engines, vehicles, and equipment. Section XII.A includes technical amendments to compliance provisions that apply broadly across EPA's emission control programs to multiple industry sectors, including light-duty vehicles, light-duty trucks, marine diesel engines, locomotives, and various other types of nonroad engines, vehicles, and equipment. Some of those amendments are for broadly applicable testing and compliance provisions in 40 CFR parts 1065, 1066, and 1068. Other cross-sector issues involve making the same or similar changes in multiple standard-setting parts for individual industry sectors. The rest of Section XII describes proposed amendments that apply uniquely for individual industry sectors.

We are proposing amendments in two areas of note for the general compliance provisions in 40 CFR part 1068. First, we are proposing to take a comprehensive approach for making confidentiality determinations related to compliance information that companies submit to EPA. We are proposing to apply these provisions for all highway, nonroad, and stationary engine, vehicle, and equipment programs, as well as aircraft and portable fuel containers.

Second, we are proposing provisions that include clarifying text to establish what qualifies as an adjustable parameter and to identify the practically adjustable range for those adjustable parameters. The proposed adjustable-parameter amendments also include specific provisions related to electronic controls that aim to deter tampering.

### 4. Targeted Revisions to the HD GHG Phase 2 Program

As noted at the start of this Section I.B, we have developed a proposed approach to make targeted updates that take into consideration the growing HD electric vehicle market without fundamentally changing the HD GHG Phase 2 program as a whole. These developments along with considerations of lead time, costs and other factors have demonstrated that further GHG reductions in the MY 2027 timeframe are appropriate. Specifically, we propose to adjust the HD GHG Phase 2 vehicle GHG emission standards by sales-weighting the projected heavy-duty EV production levels of school buses, transit buses, commercial delivery trucks, and short-haul tractors and by lowering the applicable emission standards in MY 2027 accordingly. We project these four vehicle types will have the highest EV sales of all heavy-

duty vehicle types between now and 2030. Because these four EV vehicle types do not correspond directly with the specific subcategories for standards that we developed in HD GHG Phase 2 (subcategories differentiated by vehicle weight, use, fuel type, etc.), we use EPA certification data to determine which subcategories of standards would be impacted by EV production in MY 2027. By sales-weighting the projected production levels of the four EV vehicle types in 2027, our proposed approach adjusts 17 of the 33 MY 2027 Phase 2 vocational vehicle and tractor standards and does not change any MY 2021 or MY 2024 standards or any of the Class 2b/3 pickup truck and van standards. We request comment on the proposed approach to determine the threshold.

In addition to these proposed standard adjustments, we are requesting comment on options to update the advanced technology incentive program for electric and plug-in hybrid vehicles beginning in MY 2024. These changes may be appropriate to reflect that such levels of incentives for electrification may no longer be appropriate for certain segments of the HD EV market. We are trying to balance providing additional incentives for the continued development of zero and near-zero emission vehicles without inadvertently undermining the GHG emission reductions from the HD GHG Phase 2 program with inappropriate incentives.

*D. Projected Emission Reductions, Air Quality Improvements, Costs, and Benefits*

Our analysis of the estimated emission reductions, air quality improvements, costs, and monetized benefits of the proposed criteria pollutant program is outlined below and detailed in Sections V through X. While the discussion below generally focuses on our analysis of the proposed Option 1, we also discuss the proposed Option 2; additional information on analyses of proposed Options 1 and 2 is included in the sections that follow. As discussed in Section III, we currently lack information to show that the Alternative is feasible in the MY 2027 timeframe based on the emission control technologies that we have evaluated to date, and therefore we are not presenting an analysis of the costs or benefits of the Alternative. We expect that we would need additional data supporting the feasibility of the Alternative to further consider it in the development of the final rule.

The proposed provisions in Options 1 and 2, which are described in detail in Sections III and IV, are expected to reduce emissions from highway heavy-

duty engines in several ways. We project the proposed emission standards for heavy-duty CI engines would reduce tailpipe emissions of NO<sub>x</sub>; the combination of the proposed low-load test cycle and off-cycle test procedure for CI engines would help to ensure that the reductions in tailpipe emissions are achieved in-use, not only under high-speed, on-highway conditions, but also under low-load and idle conditions. We also project reduced tailpipe emissions of NO<sub>x</sub>, CO, PM, VOCs, associated air toxics, and methane from the proposed emission standards for heavy-duty SI engines, particularly under cold-start and high-load operating conditions. The longer emission warranty and regulatory useful life requirements for heavy-duty CI and SI engines in the proposed Options 1 and 2 would help maintain the expected emission reductions for all pollutants, including primary exhaust PM<sub>2.5</sub>, throughout the useful life of the engine. The onboard refueling vapor recovery requirements for heavy-duty SI engines in the proposed Options 1 and 2 would reduce VOCs and associated air toxics. Table 5 summarizes the projected reductions in heavy-duty emission from the proposed Options 1 and 2 in 2045 and shows the significant reductions in NO<sub>x</sub> emissions from the proposal. In general, we estimate that Option 2 would result in lower emission reductions because of the less stringent emission standards combined with shorter useful life and warranty periods than the proposed Option 1 in MY 2031. Section VI and draft Regulatory Impact Analysis (RIA) Chapter 5 provide more information on our projected emission reductions for proposed Options 1 and 2, as well as the Alternative.

TABLE 5—PROJECTED HEAVY—DUTY EMISSION REDUCTIONS IN 2045 FROM THE PROPOSED OPTIONS 1 AND 2 STANDARDS

Pollutant	Percent reduction in highway heavy-duty emissions	
	Proposed Option 1	Proposed Option 2
NO <sub>x</sub> .....	61	47
Primary PM <sub>2.5</sub> ...	26	24
VOC .....	21	20
CO .....	17	16

The proposed criteria pollutant program in proposed Options 1 and 2 would also reduce emissions of other pollutants. For instance, the proposed Option 1 would result in a 27 percent reduction in benzene and a 0.7 percent reduction in methane from highway heavy-duty engines in 2045. Leading up to 2045, emission reductions are

expected to increase over time as the fleet turns over to new, compliant engines.

Reductions in emissions of NO<sub>x</sub>, VOC, PM<sub>2.5</sub>, and CO from the proposed rule are projected to lead to decreases in ambient concentrations of ozone, PM<sub>2.5</sub>, NO<sub>2</sub>, and CO. The proposed Option 1 standards would significantly decrease ozone concentrations across the country, with a population-weighted average decrease of over 2 ppb in 2045.<sup>48</sup> Ambient PM<sub>2.5</sub>, NO<sub>2</sub> and CO concentrations are also predicted to improve in 2045 as a result of the proposed Option 1 program. The emission reductions provided by the proposed standards would be important in helping areas attain the NAAQS and prevent future nonattainment. In addition, the proposed Option 1 standards are expected to result in improvements in nitrogen deposition and visibility, but they are predicted to have relatively little impact on ambient concentrations of air toxics.

We also used our air quality data from modeling Option 1 to conduct a demographic analysis of human exposure to future air quality in scenarios with and without the proposed criteria pollutant standards in place. To compare demographic trends, we sorted 2045 baseline air quality concentrations from highest to lowest concentration and created two groups: Areas within the contiguous U.S. with the worst air quality and the rest of the country. We found that in the 2045 baseline, the number of people of color living within areas with the worst air quality is nearly double that of non-Hispanic Whites. We also found that the largest predicted improvements in both ozone and PM<sub>2.5</sub> are estimated to occur in areas with the worst baseline air quality, where larger numbers of people of color are projected to reside. More details on our air quality modeling and demographic analyses are included in Section VII and draft RIA Chapter 6.

Our estimates of reductions in heavy-duty engine emissions, and associated air quality impacts, are based on manufacturers adding emissions-reduction technologies in response to the proposed Options 1 or 2 criteria pollutant standards, along with making emission control components more durable in response to the longer regulatory useful life periods in the proposed Options 1 or 2. We also estimate costs to both truck owners and manufacturers attributable to the longer emission warranty for both the proposed Options 1 and 2. We estimate costs of

<sup>48</sup> Due to resource constraints, we only conducted air quality modeling for the proposed Option 1.

the proposed Options 1 and 2 to both manufacturers and truck owners in our program cost analysis in Section V and draft RIA Chapter 7.

Our evaluation of costs to manufacturers includes direct costs (*i.e.*, cost of materials, labor costs) and indirect manufacturing costs (*e.g.*, warranty, research and development). The direct manufacturing costs include individual technology costs for emission-related engine components and for exhaust aftertreatment systems. Importantly, our analysis of direct manufacturing costs includes the costs of the existing emission control technologies because we expect the emissions warranty and regulatory useful life provisions in the proposed Options 1 and 2 to have some impact on not only the new technology added to comply with the proposed standards, but also on any existing emission control components. The cost estimates thus reflect the portion of baseline case engine hardware and aftertreatment systems for which new costs would be incurred due to the proposed warranty and useful life provisions, even absent any changes in the level of emission standards. The indirect manufacturing costs in our analysis include warranty costs, research and development costs, profits and other indirect costs. We combine direct and indirect manufacturing costs to calculate total technology costs, which we then add to operating costs in our calculation of program costs.

As part of our evaluation of operating costs, we estimate costs truck owners incur to repair emission control system components. Our repair cost estimates are based on industry data showing the amount spent annually by truck owners on different types of repairs, and our estimate of the percentage of those repairs that are related to emission control components. Our analysis of this data shows that extending the useful life and emission warranty periods would lower emission repair costs during several years of operation for several vehicle types. More discussion on our emission repair costs estimates of the

proposed Options 1 and 2 criteria pollutant standards is included in Section V, with additional details presented in draft RIA Chapter 7.

We combined our estimates of emission repair costs with other operating costs (*i.e.*, urea/DEF, fuel consumption) and technology costs to calculate total program costs. Our analysis of proposed Option 1 shows that total costs for the criteria pollutant program relative to the baseline (or no action scenario) range from \$1.8 billion in 2027 to \$2.3 billion in 2045 (2017 dollars, undiscounted, see Table V–16). We estimate that proposed Option 2 would result in higher costs than the proposed Option 1 in 2045. We expect that the same emission control technologies would be needed to meet both the proposed Option 1 and 2 standards, which would result in the same direct technology costs in both cases. The higher projected costs of the proposed Option 2 relative to the proposed Option 1 result from our expectation that the shorter useful life and emission warranty periods of the proposed Option 2 compared to proposed Option 1 in MY 2031 and later would lead to higher emission control system repair costs for proposed Option 2 than the proposed Option 1 (*i.e.*, shorter emissions warranty periods result in higher emission repair costs in proposed Option 2) (see Section V for details). Overall, the analysis shows that the costs of proposed Option 1 are less than the costs of proposed Option 2. The present value of program costs for proposed Options 1 and 2, and additional details are presented in Section V.

Section VIII presents our analysis of the human health benefits associated with the proposed Options 1 and 2. We estimate that in 2045, the proposed Option 1 would result in total annual monetized ozone- and PM<sub>2.5</sub>-related benefits of \$12 and \$33 billion at a 3 percent discount rate, and \$10 and \$30 billion at a 7 percent discount rate.<sup>49</sup> In the same calendar year, proposed Option 2 would result in total annual monetized ozone- and PM<sub>2.5</sub>-related

benefits of \$9 and \$26 billion at a 3 percent discount rate, and \$8 and \$23 billion at a 7 percent discount. These benefits only reflect those associated with reductions in NO<sub>x</sub> emissions (a precursor to both ozone and secondarily-formed PM<sub>2.5</sub>) and directly-emitted PM<sub>2.5</sub> from highway heavy-duty engines. There are additional human health and environmental benefits associated with reductions in exposure to ambient concentrations of PM<sub>2.5</sub>, ozone, and NO<sub>2</sub> that EPA has not quantified due to data, resource, or methodological limitations. There would also be benefits associated with reductions in air toxic pollutant emissions that result from the proposed program, but we did not attempt to monetize those impacts due to methodological limitations. The estimated benefits of the proposed Options 1 and 2 would be larger if we were able to monetize all unquantified benefits at this time. More detailed information about the benefits analysis conducted for the proposal, including the present value of program benefits for Options 1 and 2, is included in Section VIII and draft RIA Chapter 8.

We compare total monetized health benefits to total costs associated with the proposed Options 1 and 2 in Section IX. Table 6 shows that annual benefits of the proposed Option 1 would be larger than the annual costs in 2045, with annual net benefits of \$9 and \$31 billion assuming a 3 percent discount rate, and net benefits of \$8 and \$28 billion assuming a 7 percent discount rate.<sup>50</sup> Annual benefits would also be larger than annual costs in 2045 for the proposed Option 2, although net benefits would be slightly lower than from the proposed Option 1 (net benefits of proposed Option 2 would be \$6 and \$23 billion at a 3 percent discount rate, and net benefits of \$5 and 21 billion at a 7 percent discount rate). For both the proposed Options 1 and 2, benefits also outweigh the costs when expressed in present value terms and as equalized annual values.

TABLE 6—2045 COSTS, BENEFITS AND NET BENEFITS OF THE PROPOSED OPTION 1 AND OPTION 2

[Billions, 2017\$]<sup>a b</sup>

	Proposed Option 1		Proposed Option 2	
	3% discount	7% discount	3% discount	7% discount
2045:				
Benefits .....	\$12–\$33	\$10–\$30	\$9.1–\$26	\$8.2–\$23
Costs .....	2.3	2.3	2.9	2.9

<sup>49</sup> 2045 is a snapshot year chosen to approximate the annual health benefits that occur in a year in which the proposed program would be fully

implemented and when most of the regulated fleet would have turned over.

<sup>50</sup> The range of benefits and net benefits reflects a combination of assumed PM<sub>2.5</sub> and ozone mortality risk estimates and selected discount rate.

TABLE 6—2045 COSTS, BENEFITS AND NET BENEFITS OF THE PROPOSED OPTION 1 AND OPTION 2—Continued  
[Billions, 2017\$]<sup>a b</sup>

	Proposed Option 1		Proposed Option 2	
	3% discount	7% discount	3% discount	7% discount
Net Benefits .....	9.2–31	8.1–28	6.2–23	5.3–21

<sup>a</sup> All benefits estimates are rounded to two significant figures; numbers may not sum due to independent rounding. The range of benefits (and net benefits) in this table are two separate estimates and do not represent lower- and upper-bound estimates, though they do reflect a grouping of estimates that yield more and less conservative benefits totals. The costs and benefits in 2045 are presented in annual terms and are not discounted. However, all benefits in the table reflect a 3 percent and 7 percent discount rate used to account for cessation lag in the valuation of avoided premature deaths associated with long-term exposure.

<sup>b</sup> The benefits associated with the standards presented here do not include the full complement of health, environmental, and climate-related benefits that, if quantified and monetized, would increase the total monetized benefits.

Section X examines the potential impacts of the proposed standards on heavy-duty vehicles (sales, mode shift, fleet turnover) and employment in the heavy-duty industry. The proposed standards may impact vehicle sales due to both changes in purchase price and longer emission warranty mileage requirements; these effects may show up as increased purchases of more new vehicles than usual before the proposed standards come into effect, in anticipation of higher prices after the proposed standards (“pre-buy”). The proposed standards may also reduce sales after the proposed standards would be in place (“low-buy”). In this proposal, we suggest an approach to quantify potential impacts on vehicle sales due to new emission standards; we also provide an example of how the results could be applied to the final regulatory analysis for this rule in draft RIA Chapter 10.1. Our example results for proposed Option 1 suggest pre- and low-buy for Class 8 trucks may range from zero to approximately two percent increase in sales over a period of up to 8 months before the 2031 standards begin (pre-buy), and a decrease in sales from zero to approximately two percent over a period of up to 12 months after the 2031 standards begin (low-buy). We have provided the example results as information for commenters to consider and provide input to EPA on this type of approach for quantifying how emissions regulations may impact heavy-duty vehicle sales fleet turnover. Based on input we receive, we may consider using this type of analysis in the final rule to inform both the potential impacts on vehicle sales, and the related impacts on employment in the heavy-duty industry. We expect little mode shift due to the proposed standards because of the large difference in cost of moving goods via trucks versus other modes of transport (e.g., planes or barges).

Employment impacts of the proposed standards depend on the effects of the standards on sales, the share of labor in

the costs of the standards, and changes in labor intensity due to the standards. We quantify the effects of costs on employment, and we discuss the effects due to sales and labor intensity qualitatively. This partial quantification of employment impacts estimates that increased costs of vehicles and parts would, by itself and holding labor intensity constant, be expected to increase employment by 400 to 2,200 job-years in 2027, and 300 to 1,800 job-years in 2032 under proposed Option 1.<sup>51</sup> Employment would be expected to increase by 400 to 2,200 job years, and 300 to 1,500 job years in 2027 and 2032 respectively under proposed Option 2. See Section X for further detail on limitations and assumptions of this analysis.

Finally, the projected cost and GHG emission impacts of the proposed changes to the HD GHG Phase 2 program are described in Section XI.E.

*E. Summary of Specific Requests for Comments*

We are requesting comment on all aspects of this proposed rulemaking. In addition, as detailed in the sections that follow, we are specifically requesting comments from stakeholders on a variety of key topics throughout this proposed to inform the final rulemaking process. In this section we highlight topics on which we believe it would be especially beneficial to receive comments from stakeholders, or which may be of most interest to stakeholders.

Section III presents extensive information and analyses, including two options for the proposed criteria pollutant standards, to provide notice that EPA will be considering a range of numeric emission standard values and implementation dates in the final rule. We are requesting comment on the proposed Options 1 and 2, as well as the Alternative, standards for each duty cycle, as well as the one- and two-step

approaches in proposed Options 1 and 2, respectively, and the implementation dates of MYs 2027 and 2031. In addition, we are requesting input on several aspects of the proposed new LLC duty cycle for heavy-duty CI engines and applying the SET duty cycle to heavy-duty SI engines (see Section III). We are also requesting comment on several aspects of the proposed off-cycle standards for heavy-duty CI engines, including the levels of the standards in proposed Options 1 and 2 and the specific operating range covered by each bin, and whether off-cycle standards and in-use testing should also apply for SI engines. For SI engines, we request comment on our proposed refueling HC emission standard for incomplete vehicles above 14,000 lb GVWR, including requests for comment and data to inform test procedure updates we should consider to measure HC emissions from these larger fuel systems and vehicles. We are also requesting comment on whether EPA should finalize interim standards for testing used to verify that the engine meets the standards through useful life (i.e., in-use testing that occurs after the vehicle enters commerce). Typically, EPA sets the same standards for in-use testing and certification testing but, in some cases, we have provided higher in-use standards to give manufacturers time to gain experience with the new technology needed to meet the standards.<sup>52</sup> As outlined in this Executive Summary and discussed in Sections III and IV, we are proposing to significantly lower NO<sub>x</sub> emission standards and to significantly increase the regulatory useful life for heavy-duty on highway engines, which would require manufactures to develop and produce additional engine and aftertreatment technology. Due to the combination of lower (more stringent) numeric standards and longer useful periods included in our proposal, we are requesting comment on whether

<sup>51</sup> Where a job-year is, for example, one year of full-time work for one person, or one year of half-time work for two people.

<sup>52</sup> See 81 FR 23414 (April 28, 2014).



EPA should finalize in-use standards that are 40 to 100 percent higher than the proposed Option 1 standards for MY 2027 to MY 2033 engines.

In Section IV we detail our requests for comment on a number of topics related to our proposed lengthened useful life and warranty periods, as well as other compliance provisions and flexibilities. For instance, we are requesting stakeholder input on our proposed useful life and warranty periods, as well as the range of options covered by the proposed Options 1 and 2, or other alternatives outside of that range. In addition to the proposed warranty periods, we request comment on other approaches to warranty, such as graduated warranty phases, that may similarly ensure long-term in-use emission performance with a smaller impact on the purchase price. We further request comment on our proposed provisions to increase the likelihood that emission controls will be maintained properly through more of the service life of heavy-duty engines (e.g., revise inducement strategies, improve serviceability). In addition, we are interested in stakeholder input on our proposed approaches for the durability demonstration that manufacturers are required to include their application for certification (see Section IV.F for details). We are also interested in stakeholder input on our proposed requirements for manufacturers choosing to generate NO<sub>x</sub> emission credits from BEVs or FCEVs, as well as whether EPA should consider for this final rule, or other future rules, restrictions for NO<sub>x</sub> emission credits in the longer term (e.g., beyond MY 2031) (See Section IV.I for details).

Throughout Sections III and IV, we discuss areas where our proposal differs from the California Air Resources Board (CARB) Heavy-Duty Omnibus Rulemaking, and request comment on our proposal, including whether it is appropriate to harmonize the federal and CARB regulatory programs more in light of the authority and requirements of CAA section 202, and the benefits or challenges if EPA were to finalize particular aspects of its program that are or are not fully aligned with the Omnibus.

There are also several topics that we are requesting comment on that relate to the analyses that support our proposal. For instance, we are interested in stakeholder input on our approach for estimating emission reductions from lengthening useful life and warranty periods (see Section VI for details). We are also interested in comments on our estimate of repair costs for emission control system components (see Section

V for details). We request comment on the method we outline to estimate potential impacts of a proposed regulation on heavy-duty vehicle sales; we also request comment on approaches to estimate employment impacts attributable to the proposed rule (see Section X for details).

We are also interested in input from environmental justice stakeholders and underserved and overburdened communities, including children's health stakeholders, regarding the need for revised standards and how heavy-duty vehicles affect communities (see Section II); the air quality improvements we project from this proposal and how they are distributed (see Section VII); and ways the proposal could be improved to advance environmental protection for all people, including people of color, low-income communities, and those who live near highways or in heavily trafficked areas with frequent truck congestion and idling, such as ports.

In Section XI, we request comment in a number of areas related to the proposed updates to the HD GHG Phase 2 program for certain heavy-duty vehicles that are shifting to zero-emission vehicles. We are considering whether it would be appropriate in the final rule to increase the stringency of the standards even more than what we propose. Therefore, we request information on heavy-duty electric vehicle sales projections, including for what HD vehicle types, to help inform our HD electric vehicle sales projections in the MY 2024 through MY 2029 timeframe. We also are considering whether to establish more stringent standards beyond MY 2027, specifically in MY 2028 and MY 2029 using the methodology described in Section XI.C.1. We request comment on appropriate stringency and supporting data for each of those model years.

We are also interested in stakeholder input that supports changes to the advanced technology credit multiplier approach under consideration. In addition, we request comment under this proposal on how EPA can best consider the potential for ZEV technology to significantly reduce air pollution from the heavy-duty vehicle sector, including whether and how to consider including specific sales requirements for HD ZEVs.

For these and all requests for comment detailed throughout the proposal, stakeholders are encouraged to provide their rationale and any available data that supports to their perspectives.

## I. Introduction

### A. Brief Overview of the Heavy-Duty Truck Industry

Heavy-duty highway vehicles (also referred to as "trucks" in this preamble) range from commercial pickup trucks to vocational vehicles that support local and regional transportation, construction, refuse collection, and delivery work, to line-haul tractor-trailers that move freight cross-country. This diverse array of vehicles is categorized into weight classes based on gross vehicle weight ratings (GVWR). These weight classes span Class 2b pickup trucks and vans from 8,500 to 10,000 lbs GVWR through Class 8 line-haul tractors and other commercial vehicles that exceed 33,000 lbs GVWR.<sup>53 54</sup>

Heavy-duty highway vehicles are primarily powered by diesel-fueled, compression-ignition (CI) engines. However, gasoline-fueled, spark-ignition (SI) engines are common in the lighter weight classes, and smaller numbers of alternative fuel engines (e.g., liquified petroleum gas, compressed natural gas) are found in the heavy-duty fleet. Vehicles powered by electricity, either in the form of battery electric vehicles (BEVs) or fuel cell electric vehicles (FCEVs) are also increasingly entering the heavy-duty fleet. The operational characteristics of some commercial applications (e.g., delivery vehicles) can be similar across several vehicle weight classes, allowing a single engine, or electric power source in the case of BEVs and FCEVs, to be installed in a variety of vehicles. For instance, engine specifications needed for a Class 4 parcel delivery vehicle may be similar

<sup>53</sup> This proposed rulemaking includes revised criteria pollutants standards for engine-certified Class 2b through 8 heavy-duty engines and vehicles; this proposal also includes revised GHG standards for Class 4 through 8 vehicles. Class 2b and 3 vehicles with GVWR between 8,500 and 14,000 pounds are primarily commercial pickup trucks and vans and are sometimes referred to as "medium-duty vehicles". The majority of Class 2b and 3 vehicles are chassis-certified vehicles and will be included in a future combined light-duty and medium-duty rulemaking action, consistent with E.O. 14037, Section 2a. Heavy-duty engines and vehicles are also used in nonroad applications, such as construction equipment; nonroad heavy-duty engines and vehicles are not the focus of this proposal. See Section I for more discussion on the spectrum of heavy-duty vehicles and how they relate to the proposed rule. See Sections I.B and III for more discussion on the spectrum of heavy-duty vehicles and how they relate to the proposed rule.

<sup>54</sup> The focus of this proposal is on highway heavy-duty engines and vehicles. However, we are also proposing limited amendments to regulations that implement our air pollutant emission standards for other sectors, including light-duty vehicles, light-duty trucks, marine diesel engines, locomotives, and various types of nonroad engines, vehicles, and equipment (see Section XII).

to the needs of a Class 5 mixed freight delivery vehicle or a Class 6 beverage truck. Any performance differences needed to operate across this range of vehicles can be achieved through adjustments to chassis-based systems (*i.e.*, transmission, cooling system) external to the engine.

The industry that designs and manufactures these heavy-duty vehicles is composed of three primary segments: Vehicle manufacturers, engine manufacturers and other major component manufacturers, and secondary manufacturers (*i.e.*, body builders). Some vehicle manufacturers are vertically integrated, designing, developing, and testing their engines in-house for use in their vehicles, while others purchase some or all of their engines from independent engine suppliers. Today, only one major independent engine manufacturer supports the heavy-duty truck industry, though some vehicle manufacturers sell their engines or “incomplete vehicles” (*i.e.*, chassis that include their engines, the frame, and a transmission) to body builders who design and assemble the final vehicle. Each of these subindustries is often supported by common suppliers for subsystems such as transmissions, axles, engine controls, and emission controls.

In addition to the manufacturers and suppliers responsible for producing highway heavy-duty vehicles, an extended network of dealerships, repair and service facilities, and rebuilding facilities contribute to the sale, maintenance, and extended life of these vehicles and engines. Heavy-duty vehicle dealerships offer customers a place to order vehicles from a specific manufacturer and include service facilities for those vehicles and engines. Dealership service technicians are trained to perform regular maintenance and make repairs, which generally include repairs under warranty and in response to manufacturer recalls. Some trucking fleets, businesses, and large municipalities benefit from hiring their own technicians to service their vehicles in their own facilities. Many refueling centers along major trucking routes have also expanded their facilities to include roadside assistance and service stations to diagnose and repair common problems.

Heavy-duty CI engines installed in the larger weight classes of vehicles are designed to be rebuilt. Dealerships and other service facilities are generally equipped to replace common components, such as pistons and bearings that wear over time. However, large-scale (*i.e.*, “out-of-frame”) engine overhauls that replace most of the

engine components require a more sophisticated process that only a limited number of facilities provide. Some heavy-duty engine manufacturers have established their own rebuilding facilities as a separate branch of their operations and others work with independent rebuilding factories that are affiliated with multiple engine manufacturers. Rebuilding allows owners to extend the life of their engines at a lower cost than purchasing a replacement vehicle, which has made the practice common for some heavy-duty engines.

The end-users for highway heavy-duty vehicles are as diverse as the applications for which these vehicles are purchased. Smaller weight class heavy-duty vehicles are commonly purchased by delivery services, contractors, and municipalities. The middle weight class vehicles tend to be commercial vehicles for businesses and municipal work that transport people and goods locally and regionally or provide services such as utilities. Vehicles in the heaviest weight classes are generally purchased by businesses with high load demands, such as construction, towing or refuse collection, or freight delivery fleets and owner-operators with both load and speed demands for regional and long-haul goods movement. The competitive nature of the businesses and owner-operators that purchase and operate highway heavy-duty vehicles means that any time the vehicle is unable to operate due to maintenance or repair (*i.e.*, downtime) can lead to a loss in income. This need for reliability drives much of the truck and engine manufacturers’ innovation and research to meet the needs of their customers.

### *B. History of Emission Standards for Heavy-Duty Engines and Vehicles*

Emission standards for heavy-duty highway engines in the U.S. were first issued by the Department of Health, Education, and Welfare in the 1960s. These standards and the corresponding certification and testing procedures were codified at 45 CFR part 1201. In 1972, shortly after EPA was created as a federal agency and given responsibility for regulating heavy-duty engines, EPA published new standards and updated procedures while migrating the regulations to 40 CFR part 85 as part of the effort to consolidate all EPA regulations in a single location.<sup>55</sup> EPA created 40 CFR part 86 in 1976 to reorganize emission standards and certification requirements for light-duty

<sup>55</sup> See Section I.G for additional discussion on EPA’s Statutory Authority relevant to this proposal.

vehicles and heavy-duty highway engines. In 1985, EPA promulgated new standards for heavy-duty highway engines, codifying the standards in 40 CFR part 86, subpart A. Since then, EPA has promulgated several rules for highway heavy-duty engines and vehicles to set new and more stringent emission standards for criteria pollutants and precursors,<sup>56</sup> to set requirements for controlling evaporative and refueling emissions,<sup>57</sup> to establish emission control programs for greenhouse gases (GHGs), and to add or revise certification procedures.<sup>58</sup>

EPA’s criteria pollutant regulatory programs for the heavy-duty highway industry apply to engines.<sup>59</sup> Our regulations require that engine manufacturers identify the “primary intended service class” for each engine by considering the vehicles for which they design and market their engines. Heavy-duty CI engines are specified as light heavy-duty engine (Light HDE), medium heavy-duty engine (Medium HDE), or heavy heavy-duty engine (Heavy HDE) based largely on the weight class of the vehicles in which the engines are expected to be installed and the potential for rebuild. SI heavy-duty engines are generally specified as a single spark-ignition HDE service class unless they are designed or intended for use in the largest heavy-duty vehicles, and therefore considered heavy HDEs.<sup>60</sup> EPA sets emission standards and other regulatory provisions, including regulatory useful life and emissions warranty periods, that are targeted for the operational characteristics of each primary intended service class.

In the 1990s, EPA issued increasingly stringent standards for NO<sub>x</sub>, CO, HC,

<sup>56</sup> For example, oxides of nitrogen (NO<sub>x</sub>), hydrocarbons (HC), particulate matter (PM) and carbon monoxide (CO).

<sup>57</sup> See Section III.E for more discussion on controlling evaporative and refueling emissions from light- and heavy-duty vehicles.

<sup>58</sup> U.S. Environmental Protection Agency. “EPA Emission Standards for Heavy-Duty Highway Engines and Vehicles,” Available online: <https://www.epa.gov/emission-standards-reference-guide/epa-emission-standards-heavy-duty-highway-engines-and-vehicles>. (last accessed June 25, 2021).

<sup>59</sup> EPA’s regulations address heavy-duty engines and vehicles separately from light-duty vehicles. Vehicles with GVWR above 8,500 pounds (Class 2b and above) are classified in the regulations as heavy-duty. For criteria pollutants EPA’s standards generally apply to the engine rather than the vehicle for heavy-duty. However, most of the Class 2b and 3 pickup trucks and vans (vehicles with a GVWR between 8,500 and 14,000 pounds) are chassis-certified heavy-duty vehicles and covered by standards in EPA’s Tier 3 program (79 FR 23414, April 28, 2014; 80 FR 0978, February 19, 2015). As noted in Section III, there are a small number of Class 2b and 3 engines (*e.g.*, trucks with dual rear wheels that are sold with a cab and chassis only), which are the subject of this proposed rulemaking.

<sup>60</sup> See 40 CFR 1036.140(a)(3).

and PM. These exhaust standards were derived from engine-based emission control strategies and manufacturers generally certified their engines' emission performance over defined duty cycles on an engine dynamometer (*i.e.*, "engine certification"). In 1997, EPA finalized standards for heavy-duty highway diesels (62 FR 54693, October 21, 1997), effective beginning with the 2004 model year, including a combined non-methane hydrocarbon (NMHC) and NO<sub>x</sub> standard that represented a reduction of NO<sub>x</sub> emissions by 50 percent. These NO<sub>x</sub> reductions also resulted in significant reductions in secondary nitrate PM.

In early 2001, EPA finalized the 2007 Heavy-Duty Engine and Vehicle Rule (66 FR 5002, January 18, 2001) to continue addressing NO<sub>x</sub> and PM emissions from both diesel and gasoline-fueled highway heavy-duty engines. This rule established a comprehensive national program that regulated a heavy-duty engine and its fuel as a single system, with emission standards taking effect beginning with model year (MY) 2007 and fully phasing in by MY 2010 (EPA 2010 standards). Prior to 2007, emission standards were based on controlling the emissions formed during the combustion process (*i.e.*, engine-out emissions), and there was no further control of emissions between the engine and the truck's tailpipe. But with promulgation of the 2007 final rule, emission standards were, for the first time, based on the use of technologies to capture, convert, and reduce harmful engine-out emissions, resulting in tailpipe emissions that were cleaner than engine-out emissions. By and large, the industry met these new standards through the use of exhaust aftertreatment technologies, namely, diesel oxidation catalysts, particulate filters, and high-efficiency catalytic exhaust emission control devices. Consistent with previous criteria pollutant regulatory programs, the program also offered flexibility to manufacturers through the use of various emission credits averaging, banking, and trading (ABT) programs.

To ensure proper functioning of these aftertreatment technologies, which could be damaged by sulfur, EPA also reduced the allowable level of sulfur in highway diesel fuel by 97 percent by mid-2006. Together, the use of exhaust aftertreatment technologies and lower-sulfur fuel resulted in diesel-fueled trucks that emitted PM and NO<sub>x</sub> tailpipe emissions at levels 90 percent and 95 percent below emission levels from then-current highway heavy-duty engines, respectively. The PM standard for new highway heavy-duty engines

was set at 0.01 grams (10 milligrams, or 10 mg) per horsepower-hour (mg/hp-hr) by MY 2007 and the NO<sub>x</sub> and NMHC standards of 200 mg/hp-hr and 140 mg/hp-hr, respectively, were set to phase in between model years 2007 and 2010.<sup>61</sup> In finalizing that rule, EPA estimated that the emission reductions would achieve significant health and environmental impacts, and that the total monetized PM<sub>2.5</sub> and ozone-related benefits of the program would exceed \$70 billion, versus program costs of \$4 billion (1999\$).

In 2005, EPA finalized a manufacturer-run, in-use testing program that uses portable emission measurement systems to measure HC, CO, NO<sub>x</sub>, and PM emissions from the exhaust of in-use heavy-duty diesel trucks (70 FR 34594, June 14, 2005). The fully enforceable program began in 2007. This effort was a significant advancement in helping to ensure that the benefits of more stringent emission standards are realized under real-world driving conditions.

In 2009, as advanced emissions control systems were being introduced to meet the MY 2007/2010 standards, EPA promulgated a final rule to require that these advanced emissions control systems be monitored for malfunctions via an onboard diagnostic (OBD) system (74 FR 8310, February 24, 2009). The rule, which has been fully phased in, required engine manufacturers to install OBD systems that monitor the functioning of emission control components on new engines and alert the vehicle operator to any detected need for emission-related repair. It also required that manufacturers make available to the service and repair industry information necessary to perform repair and maintenance service on OBD systems and other emission related engine components. In addition, EPA published a series of documents that provided guidance to manufacturers on potential methods and measures to ensure that trucks equipped with Selective Catalytic Reduction (SCR) technology would be refilled with the specified quantity and quality of a urea-water mixture (also known as diesel exhaust fluid, or DEF) necessary for the proper functioning of this NO<sub>x</sub>-reducing technology. These guidance documents describe potential approaches that included progressive levels of alerts and warnings communicated to the driver of the truck,

<sup>61</sup> Heavy-duty engine emission standards are defined in work specific units (*i.e.*, milligrams per horsepower-hour) because the standards cover a large range of engine ratings, and thus time specific standards would not provide equal stringency across all engines.

which would allow adequate time to refill the DEF tank, but ultimately, if DEF is not added, or if it is determined to be of insufficient quality, a vehicle speed-limiting "inducement" would be triggered, requiring the DEF tank to be refilled or the system to be repaired.

Also in 2009, EPA and Department of Transportation's National Highway Traffic Safety Administration (NHTSA) began working on a joint regulatory program to reduce GHG emissions and fuel consumption from heavy-duty vehicles and engines.<sup>62</sup> By utilizing regulatory approaches recommended by the National Academy of Sciences, the first phase ("Phase 1") of the GHG and fuel efficiency program was finalized in 2011 (76 FR 57106, September 15, 2011).<sup>63</sup> The Phase 1 program, spanning implementation from MY 2014 to 2018, included separate standards for highway heavy-duty vehicles and heavy-duty engines. The program offered flexibility allowing manufacturers to attain these standards through a mix of technologies and the option to participate in an emissions credit ABT program. In the Phase 1 rulemaking EPA also revised the heavy-duty vehicle and engine regulations to make them consistent with the light-duty vehicle approach, such that all criteria pollutant and GHG standards would apply regardless of fuel type, including all-electric vehicles (EVs).

In 2016, EPA and NHTSA finalized the Heavy-Duty Phase 2 GHG and fuel efficiency program ("HD GHG Phase 2") (81 FR 73478, October 25, 2016). HD GHG Phase 2 includes technology-advancing performance-based standards for highway heavy-duty vehicles and heavy-duty engines that will phase in over the long term, with initial standards for most vehicles and engines commencing in MY 2021, increasing in stringency in MY 2024, and culminating in MY 2027 standards. HD GHG Phase 2 built upon the Phase 1 program and set standards based not only on currently available technologies, but also on technologies that were still under development or not yet widely deployed. To ensure adequate time for

<sup>62</sup> Greenhouse gas emissions from heavy-duty engines are primarily carbon dioxide (CO<sub>2</sub>), but also include methane (CH<sub>4</sub>) and nitrous oxide (N<sub>2</sub>O). Because CO<sub>2</sub> is formed from the combustion of fuel, it is directly related to fuel consumption.

<sup>63</sup> National Research Council; Transportation Research Board. The National Academies' Committee to Assess Fuel Economy Technologies for Medium- and Heavy-Duty Vehicles; "Technologies and Approaches to Reducing the Fuel Consumption of Medium- and Heavy-Duty Vehicles." 2010. Available online: <https://www.nap.edu/catalog/12845/technologies-and-approaches-to-reducing-the-fuel-consumption-of-medium-and-heavy-duty-vehicles>.

technology development, HD GHG Phase 2 provided up to 10 years lead time to allow for the development and phase-in of these control technologies. EPA recently finalized technical amendments to the HD GHG Phase 2 rulemaking (“HD Technical Amendments”) that included changes to the test procedures for heavy-duty engines and vehicles to improve accuracy and reduce testing burden.<sup>64</sup>

### C. Petitions to EPA for Additional NO<sub>x</sub> Emissions Control

In the summer of 2016 more than 20 organizations, including state and local air agencies from across the country, petitioned EPA to develop more stringent NO<sub>x</sub> emission standards for on-road heavy-duty engines.<sup>65</sup> Among the reasons stated by the petitioners for such an EPA rulemaking was the need for NO<sub>x</sub> emission reductions to reduce adverse health and welfare impacts and to help areas attain the NAAQS. EPA subsequently met with a wide range of stakeholders in listening sessions, during which certain themes were consistent across those stakeholders.<sup>66</sup> For example, it became clear that there is broad support for federal action in collaboration with the California Air Resources Board (CARB). So-called “50-state” standards would enable technology suppliers and manufacturers to efficiently produce a single set of reliable and compliant products. There was also broad acknowledgement of the value of aligning implementation of new NO<sub>x</sub> standards with existing MY 2021, 2024, and 2027 milestones for HD Phase 2 GHG and fuel efficiency standards. Stakeholders thought that such alignment would ensure that the GHG and fuel consumption reductions achieved under HD GHG Phase 2 are maintained and allow the regulated industry to implement GHG- and NO<sub>x</sub>-reducing technologies into their products at the same time.<sup>67</sup>

EPA responded to the petitions on December 20, 2016, noting that an opportunity exists to develop a new, harmonized national NO<sub>x</sub> reduction strategy for heavy-duty highway engines.<sup>68</sup> EPA emphasized the importance of scientific and technological information when determining the appropriate level and form of a future low NO<sub>x</sub> standard and highlighted the following potential components of the action:

- Lower NO<sub>x</sub> emission standards
- Improvements to test procedures and test cycles to ensure emission reductions occur in the real world, not only over the currently applicable certification test cycles
- Updated certification and in-use testing protocols
- Longer periods of mandatory emission-related component warranties
- Consideration of longer regulatory useful life, reflecting actual in-use activity
- Consideration of rebuilding
- Incentives to encourage the transition to current- and next-generation cleaner technologies as soon as possible

As outlined in the Executive Summary and detailed in the sections that follow, this proposed rulemaking considered these components.

### D. California Heavy-Duty Highway Low NO<sub>x</sub> Program Development

In this section, we present a summary of recent efforts by the state of California to establish new, lower emission standards for highway heavy-duty engines and vehicles.<sup>69</sup> For the past several decades, EPA and the California Air Resources Board (CARB) have worked together to reduce air pollutants from highway heavy-duty engines and vehicles by establishing harmonized

emission standards for new engines and vehicles. For much of this time, EPA has taken the lead in establishing emission standards through notice and comment rulemaking, after which CARB would adopt the same standards and test procedures. For example, EPA promulgated the current heavy-duty engine NO<sub>x</sub> and PM standards in a 2001 final rule, and CARB subsequently adopted the same emission standards. EPA and CARB often cooperate during the implementation of highway heavy-duty standards. Thus, for many years, the regulated industry has been able to design a single product line of engines and vehicles that can be certified to both EPA and CARB emission standards (which have been the same) and sold in all 50 states.

Given the significant ozone and PM air quality challenges in the state of California, CARB has taken several steps since the EPA 2010 standards were implemented to encourage or establish standards and requirements that go beyond EPA requirements, to further reduce NO<sub>x</sub> emissions from heavy-duty vehicles and engines in its state. CARB’s optional (voluntary) low NO<sub>x</sub> program, which started in 2013, was created to encourage heavy-duty engine manufacturers to introduce technologies that emit NO<sub>x</sub> at levels below the current EPA 2010 standards. Under this optional program, manufacturers can certify engines to one of three levels of stringency that are 50, 75, and 90 percent below the existing EPA 2010 standards with the lowest optional standard being 20 milligrams NO<sub>x</sub> per horsepower-hour (mg/hp-h).<sup>70</sup> To date, only natural gas and liquefied petroleum gas engines have been certified to these optional standards.<sup>71</sup>

In May 2016, CARB published its Mobile Source Strategy that outlined its approach to reduce in-state emissions from mobile sources and meet its air quality targets.<sup>72</sup> In November 2016, CARB held its first Public Workshop on its plans to update its heavy-duty engine and vehicle programs.<sup>73</sup> CARB’s 2016 Workshop kicked off a technology

<sup>64</sup> 86 FR 34308, June 29, 2021.  
<sup>65</sup> Brakora, Jessica. “Petitions to EPA for Revised NO<sub>x</sub> Standards for Heavy-Duty Engines” Memorandum to Docket EPA–HQ–OAR–2019–0055. December 4, 2019.  
<sup>66</sup> Stakeholders included: Emissions control technology suppliers; engine and vehicle manufacturers; a labor union that represents heavy-duty engine, parts, and vehicle manufacturing workers; a heavy-duty trucking fleet trade association; an owner-operator driver association; a truck dealers trade association; environmental, non-governmental organizations; states and regional air quality districts; Tribal interests; California Air Resources Board (CARB); and the petitioners.

<sup>64</sup> 86 FR 34308, June 29, 2021.

<sup>65</sup> Brakora, Jessica. “Petitions to EPA for Revised NO<sub>x</sub> Standards for Heavy-Duty Engines” Memorandum to Docket EPA–HQ–OAR–2019–0055. December 4, 2019.

<sup>66</sup> Stakeholders included: Emissions control technology suppliers; engine and vehicle manufacturers; a labor union that represents heavy-duty engine, parts, and vehicle manufacturing workers; a heavy-duty trucking fleet trade association; an owner-operator driver association; a truck dealers trade association; environmental, non-governmental organizations; states and regional air quality districts; Tribal interests; California Air Resources Board (CARB); and the petitioners.

<sup>67</sup> U.S. EPA. 2016. Memorandum in Response to Petition for Rulemaking to Adopt Ultra-Low NO<sub>x</sub> Standards for On-Highway Heavy-Duty Trucks and Engines. Available at <https://19january2017snapshot.epa.gov/sites/production/files/2016-12/documents/nox-memorandum-nox-petition-response-2016-12-20.pdf>.

<sup>68</sup> U.S. EPA. 2016. Memorandum in Response to Petition for Rulemaking to Adopt Ultra-Low NO<sub>x</sub> Standards for On-Highway Heavy-Duty Trucks and Engines. Available at <https://19january2017snapshot.epa.gov/sites/production/files/2016-12/documents/nox-memorandum-nox-petition-response-2016-12-20.pdf>.  
<sup>69</sup> California has long had the unique ability among states to adopt its own separate new motor vehicle and engine standards per Section 209 of the Clean Air Act. Although CAA section 209(a) expressly preempts states from adopting and enforcing standards relating to the control of emissions from new motor vehicles or new motor vehicle engines (such as state controls for new heavy-duty engines and vehicles), CAA section 209(b) directs EPA to waive this preemption for California under certain conditions. Even with California’s ability under the CAA to establish its own emission standards, EPA and the California Air Resources Board have worked closely together over the past several decades to largely harmonize new heavy-duty vehicle and engine criteria pollutant standard programs.

<sup>70</sup> California Code of Regulations, Title 13, section 1956.8.

<sup>71</sup> California Air Resources Board. “Optional Low NO<sub>x</sub> Certified Heavy-Duty Engines”. February 2020. Available online: [https://ww3.arb.ca.gov/msprog/onroad/optionnox/optional\\_low\\_nox\\_certified\\_hd\\_engines.pdf](https://ww3.arb.ca.gov/msprog/onroad/optionnox/optional_low_nox_certified_hd_engines.pdf).

<sup>72</sup> California Air Resources Board. “Mobile Source Strategy”. May 2016. Available online: <https://ww3.arb.ca.gov/planning/sip/2016sip/2016mobsrc.pdf>.

<sup>73</sup> California Air Resources Board. “Heavy-Duty Low NO<sub>x</sub>: Meetings & Workshops”. Available online: <https://ww2.arb.ca.gov/our-work/programs/heavy-duty-low-nox/heavy-duty-low-nox-meetings-workshops>.

demonstration program (the CARB “Low NO<sub>x</sub> Demonstration Program”), and announced plans to update emission standards, laboratory-based and in-use test procedures, emissions warranty, durability demonstration requirements, and regulatory useful life provisions. The initiatives introduced in its 2016 Workshop have since become components of CARB’s Heavy-Duty “Omnibus” Rulemaking.<sup>74</sup>

CARB’s goal for its Low NO<sub>x</sub> Demonstration Program was to investigate the feasibility of reducing NO<sub>x</sub> emissions to levels significantly below today’s EPA 2010 standards. Southwest Research Institute (SwRI) was contracted to perform the work, which was split into three “Stages.”<sup>75</sup> In Stage 1 and 1b, SwRI demonstrated an engine technology package capable of achieving a 90 percent NO<sub>x</sub> emissions reduction on today’s regulatory test cycles to a useful life of 435,000 miles using an accelerated aging process.<sup>76</sup> In Stage 2, SwRI developed and evaluated a new low load-focused engine test cycle. In Stage 3, SwRI evaluated a new engine platform and different technology package to ensure both criteria and GHG emission performance. EPA has been closely observing CARB’s Low NO<sub>x</sub> Demonstration Program as a member of the Low NO<sub>x</sub> Advisory Group for the technology development work, which includes representatives from heavy-duty engine and aftertreatment industries, as well as from federal, state, and local governmental agencies.<sup>77</sup>

CARB has published several updates related to its Omnibus Rulemaking. In June 2018, CARB approved its “Step 1” update to California’s emission control system warranty regulations.<sup>78</sup> Starting in MY 2022, the existing 100,000-mile warranty for all diesel engines will

increase to 110,000 miles for engines certified as light heavy-duty, 150,000 miles for medium heavy-duty engines, and 350,000 miles for heavy heavy-duty engines. In November 2018, CARB approved revisions to the OBD requirements that include implementation of real emissions assessment logging (REAL) for heavy-duty engines and other vehicles.<sup>79</sup> In April 2019, CARB published a “Staff White Paper” to present its staff’s assessment of the technologies they believed were feasible for medium and heavy heavy-duty diesel engines in the 2022–2026 timeframe.<sup>80</sup>

In August 2020, the CARB governing board approved the staff proposal for the Omnibus rule and directed staff to initiate the process of finalizing the provisions.<sup>81</sup> The final Omnibus rule was approved by the California Office of Administrative Law in December 2021. The final rule includes updates to CARB engine standards, duty-cycle test procedures, and heavy-duty off-cycle testing program that would take effect in MY 2024, with additional updates to warranty, durability, and useful life requirements and further reductions in standards in MYs 2027 and 2031.<sup>83</sup>

As described in Sections I.F and I.G, with details in Sections III and IV, EPA is proposing new NO<sub>x</sub>, PM, HC, and CO emission standards for heavy-duty engines that reflect the greatest degree of emission reduction achievable through the application of technology that we have determined would be available for the model years to which the proposed standards would apply. In doing so we have given appropriate consideration to additional factors, namely lead time,

cost, energy, and safety (see Sections I.F and I.G for more discussion).

Throughout the rulemaking process we will continue to evaluate what standards are appropriate given the factors that we are directed to consider under CAA section 202(a)(3). As noted at the start of this Section I.D, EPA and CARB have historically worked together to establish harmonized emission standards for new heavy-duty engines and vehicles. We have received comments from different stakeholder groups who have expressed perspectives on the alignment between the EPA and CARB Omnibus standards they would like EPA to consider during the rulemaking. For instance, in response to an Advance Notice of Proposed Rulemaking (ANPR) for this rule, many stakeholders encouraged EPA to develop a national program harmonized to the greatest extent possible (see Section I.E).<sup>84</sup> Following the ANPR, various stakeholders have provided EPA with additional perspectives on the Omnibus rule and on the extent to which EPA should align with the California program. For example, organizations such as the National Association of Clean Air Agencies,<sup>85</sup> the National Tribal Air Association,<sup>86</sup> as well as multiple vehicle supplier trade associations<sup>87</sup> have written letters to EPA in support of strong federal standards that reflect both the stringency and timeline of CARB’s standards. In contrast, some engine manufacturers have raised concerns about EPA harmonizing its national program with California’s rule because of their concerns with that program’s overall stringency, costs, and focus on near-term NO<sub>x</sub> reductions over long-term CO<sub>2</sub> emission reductions. EPA has considered these harmonization comments in light of the authority and requirements of CAA sections 202 and

<sup>74</sup> California Air Resources Board. Heavy-Duty Engine and Vehicle Omnibus Regulation and Associated Amendments. Available online: <https://ww2.arb.ca.gov/rulemaking/2020/hdomnibuslownox>.

<sup>75</sup> Southwest Research Institute. “Update on Heavy-Duty Low NO<sub>x</sub> Demonstration Programs at SwRI”. September 26, 2019. Available online: [https://ww3.arb.ca.gov/msprog/hdlownox/files/workgroup\\_20190926/guest/swri\\_hd\\_low\\_nox\\_demo\\_programs.pdf](https://ww3.arb.ca.gov/msprog/hdlownox/files/workgroup_20190926/guest/swri_hd_low_nox_demo_programs.pdf).

<sup>76</sup> Southwest Research Institute. “Evaluating Technologies and Methods to Lower Nitrogen Oxide Emissions from Heavy-Duty Vehicles: Final Report”. April 2017. Available online: <https://ww3.arb.ca.gov/research/apr/past/13-312.pdf>.

<sup>77</sup> California Air Resources Board. “Evaluating Technologies and Methods to Lower Nitrogen Oxide Emissions from Heavy-Duty Vehicles”. May 10, 2017. Available online: <https://ww3.arb.ca.gov/research/veh-emissions/low-nox/low-nox.htm>.

<sup>78</sup> California Air Resources Board. “HD Warranty 2018” June 28, 2018. Available online: <https://ww2.arb.ca.gov/rulemaking/2018/hd-warranty-2018>.

<sup>79</sup> California Air Resources Board. “Heavy-Duty OBD Regulations and Rulemaking”. Available online: <https://ww2.arb.ca.gov/resources/documents/heavy-duty-obd-regulations-and-rulemaking>.

<sup>80</sup> California Air Resources Board. “California Air Resources Board Staff Current Assessment of the Technical Feasibility of Lower NO<sub>x</sub> Standards and Associated Test Procedures for 2022 and Subsequent Model Year Medium-Duty and Heavy-Duty Diesel Engines”. April 18, 2019. Available online: [https://ww3.arb.ca.gov/msprog/hdlownox/white\\_paper\\_04182019a.pdf](https://ww3.arb.ca.gov/msprog/hdlownox/white_paper_04182019a.pdf).

<sup>81</sup> California Air Resources Board. “Staff Report: Initial Statement of Reasons-Public Hearing to Consider the Proposed Heavy-Duty Engine and Vehicle Omnibus Regulation and Associated Amendments”. June 23, 2020. Available online at: <https://ww3.arb.ca.gov/regact/2020/hdomnibuslownox/isor.pdf>.

<sup>82</sup> California Air Resources Board. Heavy-Duty Engine and Vehicle Omnibus Regulation and Associated Amendments. Available online: <https://ww2.arb.ca.gov/rulemaking/2020/hdomnibuslownox>.

<sup>83</sup> Throughout this proposal we use “Omnibus” to refer to the engine standards, duty-cycle test procedures, heavy-duty off-cycle testing program, useful life and warranty requirements included in the final Omnibus.

<sup>84</sup> The Agency published an ANPR on January 21, 2020 to present EPA’s early thinking on this rulemaking and solicit feedback from stakeholders to inform this proposal (85 FR 3306).

<sup>85</sup> Letter to EPA Administrator Michael Regan from the National Association of Clean Air Agencies. Re: The urgent need for federal regulatory action to adopt more stringent NO<sub>x</sub> standards for heavy-duty engines and vehicles, beginning immediately with highway heavy-duty trucks. August 26, 2021.

<sup>86</sup> Letter to EPA Administrator Andrew Wheeler from the National Tribal Air Association. Re: EPA’s Advance Notice of Proposed Rulemaking for Control of Air Pollution from New Motor Vehicles: Heavy-Duty Engine Standards Docket ID EPA-HQ-OAR-2019-0055. February 20, 2020.

<sup>87</sup> Letter to EPA Administrator Michael Regan from the Motor & Equipment Manufacturers Association, Manufacturers of Emission Controls Association, Advanced Engine Systems Institute, and Alliance for Vehicle Efficiency. Re: Completion of EPA’s Heavy-duty Low-NO<sub>x</sub> Rulemaking. June 24, 2021.

207 in developing the proposed standards, regulatory useful life periods, and emissions warranty periods and intends to continue to take into consideration potential harmonization with the CARB Omnibus program, as appropriate and consistent with CAA sections 202 and 207, during the rulemaking. As described in Sections III and IV, a notable difference between the proposed EPA program and the Omnibus rule is that the first step of the Omnibus rule takes effect in MY 2024, whereas the first step of the proposed EPA program is in MY 2027. EPA's statutory authority requires a four-year lead time for any heavy-duty engine or vehicle standard promulgated or revised under CAA section 202(a)(3) (see Section I.F). In Sections III and IV, we discuss areas where our proposal aligns with or differs from the Omnibus rule and request comment on issues related to harmonization between the federal and CARB regulatory programs, including benefits or challenges if EPA were to finalize particular aspects of its program that are not fully aligned with the Omnibus rule.<sup>88</sup>

As discussed in the draft RIA, we analyzed the emission inventory and air quality impacts for the proposed criteria pollutant standards before the Omnibus Rule was finalized. We may incorporate the Omnibus rule into our emission inventory and other analyses as appropriate for the final rulemaking (FRM).<sup>89 90</sup> We also may incorporate the CARB Advanced Clean Truck (ACT) Regulation into our final rule analyses. As further discussed in Sections IV, VI, and XI, the CARB ACT Regulation requires a minimum percentage of each manufacturer's heavy-duty vehicle sales in the state of California to be zero tailpipe emission technologies starting in MY 2024.<sup>91 92</sup>

<sup>88</sup> Draft RIA Chapter 5, Appendix 6 includes tables that present the main elements (*i.e.*, numeric level of standards, useful life, emission warranty) of CARB Omnibus requirements and EPA proposal.

<sup>89</sup> See Section VI and draft RIA Chapter 5 for more information on our emission inventory modeling for the proposal and plans to incorporate other updates in our modeling for the final rule.

<sup>90</sup> EPA has received waiver requests under CAA section 209(b) from California for the Omnibus or ACT rules; EPA is currently reviewing the waiver requests for the CA Omnibus and ACT rules and may consider including these rules in our analyses for the final rule. See Section III.B for discussion on our proposed approach to a voluntary standard based on one aspect of the Omnibus requirements.

<sup>91</sup> CARB. "Notice of Decision: Advanced Clean Truck Regulation." June 2020. Available online at: <https://ww3.arb.ca.gov/regact/2019/act2019/nod.pdf>.

<sup>92</sup> Buysse and Sharpe. (July 20, 2020) "California's Advanced Clean Trucks regulation: Sales requirements for zero-emission heavy-duty trucks", available online at: <https://theicct.org/>

### *E. Advance Notice of Proposed Rulemaking*

The ANPR provided background for the provisions proposed in this rulemaking to address criteria pollutant emissions from heavy-duty engines, including technologies we are evaluating, test programs we have initiated, and compliance programs under consideration, as well as requests for comments and data. The ANPR did not include discussion on the potential stringency of standards, potential costs of the standards, or a quantitative assessment of societal impacts (*e.g.*, air quality, economic, environmental health); these topics are presented in this proposal.<sup>93</sup>

EPA received over 300 comments on the ANPR from a wide range of stakeholders, including: Government organizations (state, local, and Tribal), environmental groups, trade associations, heavy-duty engine manufacturers, independent owner-operators, suppliers, individual fleets, and individual private citizens. We provide a brief overview of the perspectives included in these comments in this subsection, with more specific discussion of comments included in subsequent sections of the proposal as relevant to individual comments or groups of comments.

Comments from government organizations, including multiple state and local air agencies, emphasized that reductions in NO<sub>x</sub> emissions from heavy-duty engines are necessary for attainment and maintenance of the NAAQS. States commented that they cannot control heavy-duty engine emissions since they cross state borders and controlling emissions from other sources would be economically burdensome. Commenters stated that areas in nonattainment of the NAAQS are having difficulty attaining, and some areas currently in attainment are close to or exceeding the NAAQS. As further discussed in Section II, commenters noted environmental justice and other public health concerns, along with regional haze and ecosystem concerns. These commenters requested stringent emission controls on heavy-duty engines in as short a timeframe as possible (including early incentives) and expressed widespread interest in ensuring control over the lifetime of the

*publications/california-hdv-ev-update-jul2020* (last accessed August 11, 2021).

<sup>93</sup> The ANPR also did not include the proposed, targeted revisions to the HD GHG Phase 2 program that are included in this rulemaking (see Section I.G for a summary of these proposed provisions and Section XI for details).

engine, including addressing emissions from tampering and idling.

Several environmental groups submitted comments that were similar to several of the state and local agency comments; environmental groups supported stringent emission controls and maintaining that level of emission control for longer durations by lengthening useful life and emission warranty periods. These commenters further supported improvements to the in-use testing program for heavy-duty diesel engines, and anti-tampering measures for all heavy-duty engines.

Comments from the Truck and Engine Manufacturers Association (EMA), a trade association for heavy-duty engine and truck manufacturers emphasized broad support for a 50-state program and encouraged EPA to conduct a thorough analysis of the costs and benefits of proposed NO<sub>x</sub> emission standards. To emphasize their cost concerns, EMA provided an industry-sponsored assessment of the cost to comply with potential requirements discussed in the April 2019 CARB Staff Whitepaper.<sup>94</sup>

Several truck owners, truck operators, fleets, and dealerships also expressed general support for a national, harmonized low-NO<sub>x</sub> program. Many commenters included their experiences with expensive towing costs and downtime from emission system failures; they stated that although the reliability of emission system controls has improved since the 2010 timeframe, it remains an ongoing concern. ANPR commenters also indicated that engine derates or "inducements" are a significant source of operator frustration.<sup>95</sup> In addition, commenters urged EPA to conduct a thorough cost assessment, and noted that if the initial purchase price, or operational costs for new trucks is too high, then it may incentivize owners to keep older trucks on the road. These commenters expressed varying views on lengthening emission warranty requirements, with some urging a careful consideration of the impacts of longer warranty requirements, while others expressed

<sup>94</sup> California Air Resources Board. "California Air Resources Board Staff Current Assessment of the Technical Feasibility of Lower NO<sub>x</sub> Standards and Associated Test Procedures for 2022 and Subsequent Model Year Medium-Duty and Heavy-Duty Diesel Engines". April 18, 2019. Available online: [https://ww3.arb.ca.gov/msprog/hdlownox/white\\_paper\\_04182019a.pdf](https://ww3.arb.ca.gov/msprog/hdlownox/white_paper_04182019a.pdf).

<sup>95</sup> Engine derating is a control strategy that reduces engine performance to protect the engine or induce an operator behavior, such as maintaining appropriate levels of high-quality diesel emission fluid (DEF) in their SCR-based aftertreatment systems. Throughout this preamble we refer to engine derates that derive from aftertreatment-related triggers as "inducements".

support for longer warranty requirements.

Suppliers, supplier trade groups, and labor groups were all generally supportive of more stringent NO<sub>x</sub> emission standards. They also generally stated strong support for a 50-state, harmonized EPA-CARB program. They also emphasized the importance of providing industry with regulatory certainty. They noted that EPA must balance emission reductions with technology costs, feasibility, lead-time, and avoid market disruptions. Several suppliers and trade groups provided detailed technical information on low NO<sub>x</sub> technology. They also expressed support for longer useful life and warranty requirements but cautioned EPA to carefully design longer emissions warranty requirements and to consider a phase-in approach. Several suppliers and trade groups also supported incentives for the early introduction of low-NO<sub>x</sub> technology.

All of the ANPR comments are part of the docket for the proposal and have informed our thinking in developing the proposed provisions to address criteria pollutant emissions from heavy-duty engines.

#### F. EPA Statutory Authority for the Proposal

This section briefly summarizes the statutory authority for the proposed rule. Title II of the Clean Air Act provides for comprehensive regulation of mobile sources, authorizing EPA to regulate emissions of air pollutants from all mobile source categories. Specific Title II authorities for this proposal include: CAA sections 202, 203, 206, 207, 208, 213, 216, and 301 (42 U.S.C. 7521, 7522, 7525, 7541, 7542, 7547, 7550, and 7601). We discuss some key aspects of these sections in relation to this proposed action immediately below (see also Section XIV of this preamble), as well as in each of the relevant sections later in this proposal. Regarding the confidentiality determinations EPA is proposing to make through this notice and comment rulemaking for much of the information collected by EPA for certification and compliance under Title II, see Section XII.A. for discussion of relevant statutory authority.

Statutory authority for the proposed NO<sub>x</sub>, PM, HC, CO, and GHG emission standards in this action comes from CAA section 202(a) which states that “the Administrator shall by regulation prescribe (and from time to time revise) . . . standards applicable to the emission of any air pollutant from any class or classes of new . . . motor vehicle engines, which in his judgment

cause, or contribute to, air pollution which may reasonably be anticipated to endanger public health or welfare.” Standards under CAA section 202(a) take effect “after such period as the Administrator finds necessary to permit the development and application of the requisite technology, giving appropriate consideration to the cost of compliance within such period.” Thus, in establishing or revising CAA section 202(a) standards designed to reduce air pollution that endangers public health and welfare, EPA also must consider issues of technological feasibility, compliance cost, and lead time. EPA may consider other factors and in previous engine and vehicle standards rulemakings has considered the impacts of potential standards on the heavy-duty industry, fuel savings, oil conservation, energy security and other energy impacts, as well as other relevant considerations such as safety.

#### 1. Statutory Authority for Proposed Criteria Pollutant Program

Section 202(a)(3) further addresses EPA authority to establish standards for emissions of NO<sub>x</sub>, PM, HC, and CO from heavy-duty engines and vehicles. Section 202(a)(3)(A) requires that such standards “reflect the greatest degree of emission reduction achievable through the application of technology which the Administrator determines will be available for the model year to which such standards apply, giving appropriate consideration to cost, energy, and safety factors associated with the application of such technology.” Section 202(a)(3)(B) allows EPA to take into account air quality information in revising such standards. Section 202(a)(3)(C) provides that standards shall apply for a period of no less than three model years beginning no earlier than the model year commencing four years after promulgation. CAA section 202(a)(3)(A) is a technology-forcing provision and reflects Congress’ intent that standards be based on projections of future advances in pollution control capability, considering costs and other statutory factors.<sup>96</sup> CAA section 202(a)(3)

<sup>96</sup> See *National Petrochemical & Refiners Association v. EPA*, 287 F.3d 1130, 1136 (D.C. Cir. 2002) (explaining that EPA is authorized to adopt “technology-forcing” regulations under CAA section 202(a)(3)); *NRDC v. Thomas*, 805 F.2d 410, 428 n.30 (D.C. Cir. 1986) (explaining that such statutory language that “seek[s] to promote technological advances while also accounting for cost does not detract from their categorization as technology-forcing standards”); see also *Husqvarna AB v. EPA*, 254 F.3d 195 (D.C. Cir. 2001) (explaining that CAA sections 202 and 213 have similar language and are technology-forcing standards).

neither requires that EPA consider all the statutory factors equally nor mandates a specific method of cost-analysis; rather EPA has discretion in determining the appropriate consideration to give such factors.<sup>98</sup>

Section II, and Chapter 4 of the draft RIA, describe EPA’s analysis of information regarding heavy-duty engines’ contribution to air pollution and how that pollution adversely impacts public health and welfare. Section I.G, with more detail in Section III and Chapter 4 of the draft RIA, discusses our feasibility analysis of the standards and useful life periods for both proposed Options. Our evaluation shows that the standards and useful life periods in both steps of proposed Option 1 are feasible and would result in the greatest emission reductions achievable for the model years to which they are proposed to apply, pursuant to CAA section 202(a)(3), giving appropriate consideration to costs, lead time, and other factors. Our analysis further shows that the standards and useful life periods in proposed Option 2 are feasible in the 2027 model year, but would result in lower levels of emission reductions compared to proposed Option 1. As explained further in Section III and Chapter 3 of the draft RIA, we expect that additional data from EPA’s ongoing work to demonstrate the performance of emission control technologies, as well as information received in public comments, will allow us to refine our assessments and consideration of the feasibility of the combination of the standards and useful life periods, particularly for the largest CI engines (HHDEs), in proposed Options 1 and 2, after consideration of lead time, costs, and other factors. Therefore, we are co-proposing Options 1 and 2 standards and useful life periods, and the range of options in between them, as the options that may

<sup>97</sup> In this context, the term “technology-forcing” has a specific legal meaning and is used to distinguish standards that may require manufacturers to develop new technologies (or significantly improve existing technologies) from standards that can be met using off-the-shelf technology alone. Technology-forcing standards such as those in this proposed rule do not require manufacturers to use specific technologies.

<sup>98</sup> See, e.g., *Sierra Club v. EPA*, 325 F.3d 374, 378 (D.C. Cir. 2003) (explaining that similar technology-forcing language in CAA section 202(1)(2) “does not resolve how the Administrator should weigh all [the statutory] factors in the process of finding the ‘greatest emission reduction achievable’”); *Husqvarna AB v. EPA*, 254 F.3d 195, 200 (D.C. Cir. 2001) (explaining that under CAA section 213’s similar technology-forcing authority that “EPA did not deviate from its statutory mandate or frustrate congressional will by placing primary significance on the ‘greatest degree of emission reduction achievable’” or by considering cost and other statutory factors as important but secondary).

potentially be appropriate to finalize pursuant to CAA section 202(a)(3) once EPA has considered that additional data and other information. We considered costs and lead time in designing the proposed program options, including in our analysis of how manufacturers would adopt advanced emission control technologies to meet the proposed standards for the applicable model years. For example, the first step of proposed Option 1 allows manufacturers to minimize costs by implementing a single redesign of heavy-duty engines for MY 2027, which is when both the final step of the HD GHG Phase 2 standards and the first step of the proposed Option 1 standards would start to apply. The second step of proposed Option 1 (MY 2031) would provide manufacturers the time needed to ensure that emission control components are durable enough for the proposed second step of revised standards and longer useful life periods.<sup>99 100</sup>

As described in Section III, we are proposing new test cycles for both pre-production and post-certification testing. Manufacturers demonstrate compliance over specified duty cycle test procedures during pre-production testing, which is conducted by EPA or the manufacturer. These data and other information submitted by the manufacturer as part of their certification application are the basis on which EPA issues certificates of conformity pursuant to CAA section 206. Under CAA section 203, sales of new vehicles are prohibited unless the vehicle is covered by a certificate of conformity. Compliance with standards is required not only at certification but throughout the useful life period of the engine and vehicle, based on post-certification testing. Post-certification testing can include both specific duty cycle test procedures and off-cycle test procedures that are conducted with undefined duty cycles either on the road or in the laboratory (see Sections III.A and IV.K for more discussion on for testing at various stages in the life of an engine).

As described in Section IV, we are proposing to lengthen regulatory useful life and emission warranty periods to better reflect the mileages and time periods over which heavy-duty engines are driven today. CAA section 202(d) directs EPA to prescribe regulations under which the useful life of vehicles

and engines are determined and establishes minimum values of 10 years or 100,000 miles, whichever occurs first, unless EPA determines that a period of greater duration or mileage is appropriate. EPA may apply adjustment factors to assure compliance with requirements in use throughout useful life (CAA section 206(a)). CAA section 207(a) requires manufacturers to provide an emissions warranty, which EPA last updated in its regulations for heavy-duty engines in 1983 (see 40 CFR 86.085–2).<sup>101</sup>

## 2. Statutory Authority for Targeted Revisions to the Heavy-Duty GHG Phase 2 Program

In addition, as discussed in Section XI, EPA is proposing a limited set of revisions to MY 2027 Phase 2 GHG emissions standards under its CAA section 202(a) authority described in this section (Section I.F). We have developed an approach to propose targeted updates to HD GHG Phase 2 standards that take into consideration the growing HD electric vehicle market without fundamentally changing the HD GHG Phase 2 program as a whole. In addition, we are requesting comment on potential changes to the advanced technology incentive program for electric vehicles beginning in MY 2024.

### G. Basis of the Proposed Standards

Our approach to further reduce air pollution from highway heavy-duty engines and vehicles through the proposed program features several key provisions. The primary provisions address criteria pollutant emissions from heavy-duty engines. In addition, this proposal would make targeted updates to the existing Heavy-Duty Greenhouse Gas Emissions Phase 2 program, proposing that further GHG reductions in the MY 2027 timeframe are appropriate considering lead time, costs, and other factors, including market shifts to zero-emission technologies in certain segments of the heavy-duty vehicle sector.

#### 1. Basis of the Proposed Criteria Pollutant Standards

Heavy-duty engines across the U.S. emit NO<sub>x</sub>, PM, VOCs, and CO that contribute to ambient levels of ozone, PM, NO<sub>x</sub>, and CO; these pollutants are linked to premature death, respiratory illness (including childhood asthma), cardiovascular problems, and other adverse health impacts. In addition, these pollutants reduce visibility and negatively impact ecosystems. Data show that NO<sub>x</sub> emissions from heavy-

duty engines are important contributors to concentrations of ozone and PM<sub>2.5</sub> and their resulting threat to public health.<sup>102 103</sup> As discussed in Section II, we estimate that heavy-duty engines will continue to be one of the largest contributors to mobile source NO<sub>x</sub> emissions nationwide in the future, representing 32 percent of the mobile source and 89 percent of the onroad NO<sub>x</sub> emission inventories in calendar year 2045.<sup>104 105</sup> For the reasons summarized here and explained further in those sections, EPA concludes that revised standards are warranted to address the emissions of these pollutants and their contribution to national air pollution.

As required by CAA section 202(a)(3), EPA is proposing new NO<sub>x</sub>, PM, HC, and CO emission standards for heavy-duty engines that reflect the greatest degree of emission reduction achievable through the application of technology that we have determined would be available for the model years to which the proposed standards would apply. In doing so we have given appropriate consideration to additional factors, namely lead time, cost, energy, and safety. Our technical assessments are primarily based on results from diesel engine demonstration testing conducted by CARB at Southwest Research Institute,<sup>106</sup> heavy-duty gasoline and diesel engines testing conducted at EPA's National Vehicle and Fuel Emissions Laboratory (NVFEL), heavy-duty engine certification data submitted to EPA by manufacturers, ANPR comments, and other data submitted by industry stakeholders or studies conducted by EPA, as more specifically identified in the sections that follow. We expect that additional data from EPA's ongoing work to demonstrate the performance of emission control technologies will allow us to refine our assessments and consideration of the feasibility of the combination of

<sup>102</sup> Zawacki et al. 2018. Mobile source contributions to ambient ozone and particulate matter in 2025. *Atmospheric Environment*, Vol 188, pg 129–141. Available online: <https://doi.org/10.1016/j.atmosenv.2018.04.057>.

<sup>103</sup> Davidson et al. 2020. The recent and future health burden of the U.S. mobile sector apportioned by source. *Environmental Research Letters*. Available online: <https://doi.org/10.1088/1748-9326/ab3a8>.

<sup>104</sup> U.S. Environmental Protection Agency (2021). 2016v1 Platform. <https://www.epa.gov/air-emissions-modeling/2016v1-platform>.

<sup>105</sup> Han, Jaehoon. Memorandum to the Docket EPA–HQ–OAR–2019–0055: “MOVES Modeling-Related Data Files (MOVES Code, Input Databases and Runspecs) for the Proposed Heavy-Duty 2027 Standards”. February 2022.

<sup>106</sup> See Section III.B and draft RIA Chapter 3.1 for more details and discussion on data from diesel engine demonstration testing.

<sup>99</sup> The second step of the proposed Option 1 standards in MY 2031 provides four years of stability following the first step of the program.

<sup>100</sup> See Section III for details on our proposed test cycles and standards, and Section IV for our proposed compliance provisions.

<sup>101</sup> 48 FR 52170, November 16, 1983.



standards and useful life periods in proposed Options 1 and 2, after consideration of lead time, costs, and other factors. Therefore, we are co-proposing Options 1 and 2 to illustrate a broader range of potential options. We also present an alternative (the Alternative) that we considered in the development of this proposal but for which we currently lack information to conclude would be feasible throughout the useful periods included in this alternative and in the model year in which the standards would begin. As outlined in this section and detailed in Sections III and IV, we solicit comment on the proposed Options 1 and 2, the Alternative presented, or other alternatives within and outside the range of options.

As noted in the Executive Summary and discussed in Section III, the proposed Options 1 and 2 standards and the Alternative would each begin to apply in MY 2027. We selected this model year for two reasons. First, as explained in Section I.F, the CAA requires EPA to provide at least four years of lead time from the promulgation of a final rule. We expect to finalize this rulemaking in 2022, such that MY 2027 would be the earliest model year the new requirements could apply. Second, the timing of the final stage of the HD GHG Phase 2 program in MY 2027 leads us to believe that MY 2027 is the appropriate time for the proposed standards to begin since this would allow manufacturers to design a single engine platform that complies with both HD GHG Phase 2 and the criteria pollutant requirements. We expect that a single engine design for both rulemakings would minimize costs and improve reliability of the emission control components by integrating design changes for both rules (see Section III.A for more discussion on MY 2027 as the first implementation year for the proposed program).

The MY 2031 standards in proposed Option 1 would begin four model years after the MY 2027 standards in proposed Option 1, which is an additional year beyond the CAA requirement for at least three years of stability.<sup>107</sup> Both steps of the proposed Option 1 standards reflect the greatest degree of emission reductions achievable in each model year when combined with the proposed longer useful life periods, new test cycles, and other compliance provisions that start in each model year. We expect that the changes to useful life in proposed

Options 1 and 2 would improve component durability, but additional increases in useful life, such as those associated with the proposed MY 2031 standards in proposed Option 1, may take manufacturers more time to develop (see Section IV for more discussion). Therefore, proposed Option 1 includes a two-step approach to allow additional lead time for manufacturers to develop emission control components durable enough for the proposed longer useful life periods. In Section III.A we request comment on the two-step approach in proposed Option 1.

In Sections III and IV, we present the details of the two-step proposed Option 1 (MYs 2027 and 2031) and the proposed Option 2 that would occur in a single step (MY 2027). We also present details of the Alternative, which would also occur in a single step (MY 2027). Overall, proposed Option 2 is less stringent than the MY 2031 standards in proposed Option 1 due to higher numeric levels of the NO<sub>x</sub> emission standards and shorter useful life periods in proposed Option 2. For our proposed Options 1 and 2 standards, we project that the emission control technologies used in MY 2027 would build on those used in light- and heavy-duty engines today. For heavy-duty CI engines, under both the proposed Option 1 MY 2031 standards and the proposed Option 2 standards, we project the use of the valvetrain engine technology combined with updates to the SCR system configuration that builds on what is used in current light-duty trucks and heavy-duty engines. For heavy-duty SI engines, the technologies we are evaluating that would achieve the standards in the proposed Options 1 and 2 largely build on the three-way catalyst-based emission control strategies used in heavy-duty SI chassis certified engine products.

The Alternative we considered includes lower (more stringent) numeric NO<sub>x</sub> emission levels for Heavy HDEs, and lower HC emission levels for all CI and SI engine classes, combined with longer useful life periods and shorter lead time compared to the MY 2031 standards in proposed Option 1. The test data we currently have from our engine demonstration program is not sufficient to conclude that the Alternative standards would be feasible in the MY2027 timeframe; we would need additional data before we could project that the Alternative is feasible for the MY 2027 timeframe.

We continue to believe it is appropriate for SI and CI engines to have numerically identical standards for the criteria pollutants. As described in Section III, the proposed standards for

each pollutant are primarily based on the engine type (CI and SI) for which the particular emission standard is most challenging to achieve. The NO<sub>x</sub> standards in proposed Options 1 and 2 are based primarily on emission test data from CI engine demonstration work, while the HC and CO standards in the proposed Options 1 and 2 are based on the SI engine demonstration program. Currently available engine demonstration test data show that the heavy-duty CI engine technologies we are evaluating can achieve a 75 to 90 percent reduction from current NO<sub>x</sub> standards. These data indicate that the NO<sub>x</sub> standards for MY 2027 in proposed Options 1 and 2 are achievable for a useful life period of 600,000 miles, which encompasses the proposed Option 2 useful life periods for Light HDE and Medium HDEs. Our evaluation of the current data suggests that the proposed Option 2 standards would also be feasible out to the proposed Option 2 Heavy HDE useful life; we are continuing to collect data to confirm our extrapolation of data out to the longer HDE useful life mileage. As discussed in Section IV.A, useful life mileages for proposed Option 2 are higher than the MY 2027 useful life values in proposed Option 1, but lower than the MY 2031 useful life values in proposed Option 1. The useful life mileages included in the proposed Options 1 and 2 are based on the operational life of engines in the field today. Data show that heavy-duty engines are operating in the real world well beyond the useful life periods in our existing regulations, and thus we are proposing longer useful life periods to ensure that emission control systems are durable for an appropriate portion of their use in the real world (see Section IV for details). For the Alternative, data suggest that to meet the combination of numeric levels of the Alternative NO<sub>x</sub> emission standards and useful life periods for Light HDEs and Medium HDEs, it may be appropriate for EPA to consider providing manufacturers with additional lead time, beyond the MY 2027 implementation date of the Alternative. For Heavy HDEs, our evaluation of current data suggests that wholly different emission control technologies than we have evaluated to date (*i.e.*, not based on CDA and a dual SCR) would be needed to meet the Alternative NO<sub>x</sub> standards for Heavy HDEs; we request comment on this conclusion and on the availability, or potential development and timeline, of such additional technologies.

Our demonstration test data do show that CI engines can achieve the PM, HC, and CO standards in proposed Options

<sup>107</sup> The two alternative sets of standards that we present would each be implemented in a single step beginning in MY 2027.

1 and 2, each of which would result in at least a 50 percent reduction from current emission standards for PM, HC, and CO. The HC and CO standards in the proposed Options 1 and 2, are based on SI engine demonstration data with a catalyst aged beyond the useful life of those scenarios. Available data indicate that the combination of NO<sub>x</sub>, HC, and CO emission levels over the longer useful life period reflected in the SI standards of the Alternative would be very challenging to meet in the MY 2027 timeframe. In contrast, we believe the additional lead time provided by the second step of the MY 2031 standards in proposed Option 1, combined with the higher numeric standard for HC and the shorter useful life mileage, results in the MY 2031 standards in proposed Option 1 being both feasible and technology forcing.

We are also proposing to require onboard refueling vapor recovery (ORVR) for incomplete vehicles over 14,000 lb GVWR fueled by gasoline and other volatile fuels. Currently, hydrocarbon vapors from those vehicles are uncontrolled during refueling events, despite technology to control these emissions being widely adopted in vehicles in lower weight classes for almost 20 years. Recent data show this lack of emission control technology can result in refueling emissions that are more than 10 times current light-duty refueling standards (see Section III.D.2 for more discussion). We included ORVR in the analysis of both proposed Options 1 and 2, as well as the Alternative.

Our PM standards are based on certification test data that show the proposed 50 percent reduction in the current PM standard is achievable in CI and SI heavy-duty engines being certified today; the same reduction in PM standard is included in both proposed Options 1 and 2, as well as the Alternative. We believe lowering the PM standard to a level currently achievable through the use of emission control technology used in new engines being sold today is appropriate. EPA is not aware of any technology that is feasible to adopt in the 2027 timeframe that would reduce PM emissions further, and variability in PM measurement starts to increase at PM levels lower than the proposed standard. Nevertheless, we request comment on if there are technologies that EPA could consider that would enable a PM standard lower than 5 mg/hp-hr.

The proposed Options 1 and 2 generally represent the range of options, including the NO<sub>x</sub>, HC, and CO standards, useful life periods and lead time that we are currently considering

in this rule; we expect we may receive additional information through public comments or data we continue to collect on the feasibility, costs, and other impacts of the proposed Options 1 and 2.<sup>108</sup> In order to consider adopting the Alternative in the final rule, we would need additional information to be able to conclude that the Alternative is feasible in the MY 2027 timeframe. We request comment on all aspects of the proposal, including the revised emission standards and useful life and warranty periods, one and two-step approaches, model years of implementation in proposed Options 1 and 2, or other alternatives roughly within the range of options covered by the proposed Options 1 and 2, as well as other provisions described in this proposal. We also request comment, including relevant data and other information, related to the feasibility of the implementation model year, numeric levels of the emission standards, and useful life and warranty periods included in the Alternative, or other alternatives outside the range of options covered by the proposed Options 1 and 2.

As described in Section III, we are proposing new laboratory test duty cycles and standards in response to data that show a current lack of emission control under low-load conditions in CI heavy-duty engines, and under high-load in SI heavy-duty engines. As noted in Section VI, we project that without the proposed provisions, low- and high-load engine operations would account for 28 and 36 percent, respectively, of the heavy-duty NO<sub>x</sub> emission inventory in 2045.

Proposed Option 1 includes requirements for lowering the numeric level of the standard and lengthening useful life in two steps. Consistent with our approach for useful life, proposed Option 1 would lengthen emission warranty mileages in two steps, such that the proposed MY 2031 warranty would cover an appropriate portion of the proposed MY 2031 regulatory useful life (see Section IV.B for more discussion). The proposed Option 2 would lengthen emission warranty mileages in a single step, consistent with the proposed single step increase in useful life in proposed Option 2. While warranty periods do not directly impact the stringency of the proposed standards, we expect the proposed

<sup>108</sup>The numeric level of the standards for PM are consistent across the proposal and both alternatives since they are intended to ensure that the level of PM emissions from current engines does not increase as manufacturers make adjustments to further control NO<sub>x</sub>, CO<sub>2</sub> or other pollutants. See Section III.B.2 for more discussion.

lengthened warranty periods would improve air quality and we included them in our inventory and cost analyses of the proposed Option 1 and Option 2 standards.

We are also proposing additional compliance provisions that would begin in MY 2027, such as targeted provisions to help ensure that owners can efficiently maintain emissions performance over the operational life of the engine. We are proposing provisions to enhance communication with operators, including updated diagnostic requirements, a revised inducement policy for SCR-based aftertreatment systems, and improved access to service information (see Section IV.B for more discussion). We believe these proposed provisions could decrease the likelihood that owners tamper with (*i.e.*, remove or otherwise disable) emission control systems.

The emission reductions from the proposed program would increase over time as more new, cleaner vehicles enter the fleet. For example, by 2040 the proposed Option 1 would reduce heavy-duty NO<sub>x</sub> emissions by more than 55 percent, compared to projected 2040 emissions without the proposed rule. The proposed Option 2 would reduce heavy-duty NO<sub>x</sub> emissions by 44 percent in 2040 (see Section VI for details on projected emission reductions from proposed Option 1 or 2). These emission reductions would lower ambient concentrations of pollutants such as ozone and PM<sub>2.5</sub>. Our analysis shows that the proposed Option 1 would provide more emission reductions than proposed Option 2, and less reductions than the Alternative. Our air quality modeling analysis of Option 1's projected emission reductions shows widespread reductions in ambient concentrations of air pollutants in 2045, which is a year by which most of the regulated fleet would have turned over.<sup>109</sup> Our analysis shows that these emission reductions would result in significant improvements in ozone concentrations; ambient PM<sub>2.5</sub>, NO<sub>2</sub> and CO concentrations would also improve in 2045 (see Section VII for details). Based on our air quality analysis of PM<sub>2.5</sub> and ozone, we estimate that in 2045, the proposed Option 1 would result in total annual monetized health benefits of \$12 and \$33 billion at a 3 percent discount rate and \$10 and \$30 billion at a 7 percent discount rate (2017 dollars). We estimate that in 2045, the proposed Option 2 would result in total annual

<sup>109</sup>Due to resource constraints, we only conducted air quality modeling for the proposed Option 1.

monetized health benefits of \$9 and \$26 billion at a 3 percent discount rate and \$8 and \$23 billion at a 7 percent discount rate (2017 dollars) (see Section VIII for details).

In addition to projected health benefits, we considered several other factors in developing the proposed standards, including cost, energy, and safety. Our cost analysis, presented in Section V, accounts for costs to manufacturers and to truck owners. Costs to manufacturers include direct manufacturing costs (*i.e.*, new hardware/technology) and indirect costs (*e.g.*, emission warranty, R&D), while costs to truck owners include operating costs (*e.g.*, fuel, diesel exhaust fluid, emission control system repairs). Our analysis shows that direct manufacturing costs are the same for proposed Options 1 and 2; however, indirect costs result in total costs to manufacturers (*i.e.*, total technology costs) under the proposed Option 1 being slightly higher than under the proposed Option 2. The operating costs associated with the proposed Option 1 are estimated to be lower than those of proposed Option 2. The lower operating costs in proposed Option 1 (largely from lower repair costs) offset the higher technology costs (due to higher warranty and R&D driven indirect costs) in proposed Option 1, which results in a lower total cost of proposed Option 1 relative to proposed Option 2 when costs are summed for 2027 through 2045. For the Alternative, we have not determined the incremental direct manufacturing costs of the technology needed to meet the standards, and we would need additional data before we could project that the Alternative is feasible for the MY 2027 timeframe.

Section IX compares the benefits and costs of the proposed Options 1 and 2. Our analysis shows that while proposed Option 2 provides higher emission reductions in the early years of the program, it has lower net benefits than proposed Option 1 when considering the time period of 2027 through 2045; this is a result of both higher costs and lower emission reductions relative to proposed Option 1 in the later years of the program. As noted throughout this section and discussed in Sections III and IV, we do not currently have information to project that the Alternative standards as currently formulated are feasible in the MY 2027 timeframe with the emission control technologies we evaluated to date, and thus we are not presenting an analysis of the costs or benefits of the Alternative.

Our current evaluation of available data shows that the standards and

useful life periods in both steps of proposed Option 1 are feasible and that each step would result in the greatest degree of emission reduction achievable for the model years to which they are proposed to apply, pursuant to CAA section 202(a)(3), giving appropriate consideration to cost, lead time, and other factors. Our analysis further shows that the standards and useful life periods in proposed Option 2 are feasible in the 2027 model year, but would result in lower levels of emission reductions compared to proposed Option 1. Given the analysis we present in this proposal, we currently believe that proposed Option 1 may be a more appropriate level of stringency as it would result in a greater level of achievable emission reduction for the model years proposed, which is consistent with EPA's statutory authority under Clean Air Act section 202(a)(3). However, as further discussed in Section III and draft RIA Chapter 3, we expect that additional data from EPA's ongoing work to demonstrate the performance of emission control technologies, as well as information received in public comments, will allow us to refine our assessments and consideration of the feasibility of the combination of the standards and useful life periods, particularly for the largest CI engines (HHDEs), in proposed Options 1 and 2, after consideration of lead time, costs, and other factors. Therefore, we are co-proposing Options 1 and 2 standards and useful life periods, and the range of options in between them, as the options that may potentially be appropriate to finalize pursuant to CAA section 202(a)(3) once EPA has considered that additional data and other information.

Our analysis further shows that the proposed Option 1 and 2 standards would have no negative impacts on energy; as discussed in Section III, our evaluation of test engine data shows no change in energy consumption (*i.e.*, fuel) relative to a baseline engine. Similarly, we anticipate no negative impacts on safety due to the proposed program.

## 2. Basis of the Targeted Revisions to the HD GHG Phase 2 Program

In addition to the proposed criteria pollutant program provisions, we are proposing targeted updates to certain CO<sub>2</sub> standards for MY 2027 trucks, and we are requesting comment on updates to the advanced technology incentive program for electric vehicles. The transportation sector is the largest U.S. source of GHG emissions, representing

29 percent of total GHG emissions.<sup>110</sup> Within the transportation sector, heavy-duty vehicles are the second largest contributor, at 23 percent.<sup>111</sup> GHG emissions have significant impacts on public health and welfare as evidenced by the well-documented scientific record and as set forth in EPA's Endangerment and Cause or Contribute Findings under CAA section 202(a).<sup>112</sup> Therefore, continued emission reductions in the heavy-duty vehicle sector are appropriate.

We are at the early stages of a significant transition in the history of the heavy-duty on-highway sector—a shift to zero-emission vehicle technologies. This change is underway and presents an opportunity for significant reductions in heavy-duty GHG emissions. Major trucking fleets, manufacturers and U.S. states have announced plans to shift the heavy-duty fleet toward zero-emissions technology beyond levels we accounted for in setting the existing HD GHG Phase 2 standards, as detailed in Section XI. Specifically, we set the existing Phase 2 standards at levels that would require all conventional vehicles to install varying combinations of emission-control technologies (the degree and types of technology can differ, with some vehicles that have less being offset by others with more, which would lead to CO<sub>2</sub> emissions reductions). As discussed in Section XI, the rise in electrification beyond what we had anticipated when finalizing the HD GHG Phase 2 program (*e.g.*, the California Advanced Clean Trucks rulemaking) would enable manufacturers to produce some conventional vehicles without installing any of the GHG emission-reducing technologies that we projected in the HD GHG Phase 2 rulemaking, absent the changes we are proposing in this document.<sup>113 114</sup>

To address this issue, EPA is proposing under its authority in CAA section 202(a) to revise GHG emissions standards for a subset of MY 2027 heavy-duty vehicles. Specifically, we

<sup>110</sup> Inventory of U.S. Greenhouse Gas Emissions and Sinks: 1990–2019 (EPA–430–R–21–005, published April 2021).

<sup>111</sup> *Ibid.*

<sup>112</sup> 74 FR 66496, December 15, 2009; 81 FR 54422, August 15, 2016.

<sup>113</sup> CARB. “Notice of Decision: Advanced Clean Truck Regulation.” June 2020. Available online at: <https://ww3.arb.ca.gov/regact/2019/act2019/nod.pdf>.

For more information on this proposed rulemaking in California see: [https://ww2.arb.ca.gov/rulemaking/2019/advancedcleantrucks?utm\\_medium=email&utm\\_source=govdelivery](https://ww2.arb.ca.gov/rulemaking/2019/advancedcleantrucks?utm_medium=email&utm_source=govdelivery).

<sup>114</sup> EPA is currently reviewing a waiver request under CAA section 209(b) from California for the ACT rule.

propose to adjust HD Phase 2 vehicle GHG emission standards by sales-weighting the projected EV production levels of school buses, transit buses, delivery trucks, and short-haul tractors and by lowering the applicable GHG emission standards in MY 2027 accordingly. Our proposed approach adjusts 17 of the 33 MY 2027 Phase 2 vocational vehicle and tractor standards and does not change any MY 2021 or MY 2024 standards or any of the Class 2b/3 pickup truck and van standards. In addition, we are requesting comment on potential changes to the advanced technology incentive program for electric vehicles beginning in MY 2024.

Under CAA section 202(a), emission standards take effect “after such period as the Administrator finds necessary to permit the development and application of the requisite technology, giving appropriate consideration to the cost of compliance within such period.” Thus, in establishing or revising CAA section 202(a) standards, EPA must consider issues of technological feasibility, compliance cost, and lead time. The proposed revised standards are based on the same technology packages used to derive the current HD GHG Phase 2 standards, which we applied to the subset of the vehicles that would otherwise not require GHG-reducing technologies due to the higher projection of HD electric vehicles in MY 2027 and beyond and the incentive program. The HD GHG Phase 2 standards were based on adoption rates for technologies in technology packages that EPA regards as appropriate under CAA section 202(a) for the reasons given in the HD GHG Phase 2 rulemaking in Section III.D.1 for tractors and Section V.C.1 for vocational vehicles.<sup>115</sup> We continue to believe these technologies can be adopted at the estimated technology adoption rates for these proposed revised standards within the lead time that would be provided. The fleet-wide average cost per tractor projected to meet the proposed revised MY 2027 standards is approximately \$10,200 to \$10,500. The fleet-wide average cost per vocational vehicle to meet the proposed revised MY 2027 standards ranges between \$1,500 and \$5,700. These increased costs would be recovered in the form of fuel savings during the first two years of ownership for tractors and first four years for vocational vehicles, which we still consider to be reasonable.<sup>116</sup> In addition, manufacturers would retain leeway to develop alternative

compliance paths, increasing the likelihood of the proposed revised standards’ successful implementation. The targeted adjustments to the select standards we are proposing would result in modest CO<sub>2</sub> emissions reductions and climate-related benefits associated with these emission reductions. As described in more detail in Section XI, we believe this proposal considered feasibility, cost, lead time, emissions impact, and other relevant factors, and therefore these standards are appropriate under CAA section 202(a).

In addition to these proposed standard adjustments, we are requesting comment on options to update the advanced technology incentive program for electric and plug-in hybrid vehicles beginning in MY 2024. These changes may be appropriate to reflect that such levels of incentives for electrification may no longer be appropriate for certain segments of the HD EV market. We are interested in trying to balance providing incentives for the continued development of zero and near-zero emission vehicles without inadvertently undermining the GHG emission reductions expected from the existing HD GHG Phase 2 program with inappropriate incentives.

## II. Need for Additional Emissions Control

This proposal would reduce emissions from heavy-duty engines that contribute to ambient levels of ozone, PM, NO<sub>x</sub> and CO, which are all pollutants for which EPA has established health-based NAAQS. These pollutants are linked to premature death, respiratory illness (including childhood asthma), cardiovascular problems, and other adverse health impacts. Many groups are at greater risk than healthy people from these pollutants, including people with heart or lung disease, outdoor workers, older adults and children. These pollutants also reduce visibility and negatively impact ecosystems. This proposal would also reduce emissions of air toxics from heavy-duty engines. A more detailed discussion of the health and environmental effects associated with the pollutants affected by this proposed rule is included in Sections II.B and II.C and Chapter 4 of the draft RIA.

As further described in Sections II.B.7 and II.B.8, populations who live, work, or go to school near high-traffic roadways experience higher rates of numerous adverse health effects, compared to populations far away from major roads. In addition, there is substantial evidence that people who live or attend school near major

roadways are more likely to be people of color, Hispanic ethnicity, and/or low socioeconomic status.

Across the U.S., NO<sub>x</sub> emissions from heavy-duty engines are important contributors to concentrations of ozone and PM<sub>2.5</sub> and their resulting threat to public health.<sup>117 118</sup> The emissions modeling done for the proposed rule<sup>119</sup> (see Chapter 5 of the draft RIA) indicates that heavy-duty engines will continue to be one of the largest contributors to mobile source NO<sub>x</sub> emissions nationwide in the future, representing 32 percent of the mobile source NO<sub>x</sub> in calendar year 2045.<sup>120</sup> Furthermore, it is estimated that heavy-duty engines will represent 89 percent of the onroad NO<sub>x</sub> inventory in calendar year 2045.<sup>121</sup> The emission reductions that would occur from the proposed rule are projected to reduce air pollution that is (and is projected to continue to be) at levels that endanger public health and welfare.

Many state and local agencies across the country have asked the EPA to further reduce NO<sub>x</sub> emissions, specifically from heavy-duty engines, because such reductions will be a critical part of many areas’ strategies to attain and maintain the ozone and PM NAAQS. These state and local agencies anticipate challenges in attaining the NAAQS, maintaining the NAAQS in the future, and/or preventing nonattainment. Some nonattainment areas have already been “bumped up” to higher classifications because of challenges in attaining the NAAQS; others say they are struggling to avoid nonattainment.<sup>122</sup> Many state and local agencies commented on the ANPR that heavy-duty vehicles are one of their largest sources of NO<sub>x</sub> emissions. They

<sup>117</sup> Zawacki et al., 2018. Mobile source contributions to ambient ozone and particulate matter in 2025. *Atmospheric Environment*, Vol 188, pg 129–141. Available online: <https://doi.org/10.1016/j.atmosenv.2018.04.057>.

<sup>118</sup> Davidson et al., 2020. The recent and future health burden of the U.S. mobile sector apportioned by source. *Environmental Research Letters*. Available online: <https://doi.org/10.1088/1748-9326/ab83a8>.

<sup>119</sup> Sectors other than onroad were projected from 2016v1 Emissions Modeling Platform, <http://views.cira.colostate.edu/wiki/wiki/10202>.

<sup>120</sup> U.S. Environmental Protection Agency (2021). 2016v1 Platform. <https://www.epa.gov/air-emissions-modeling/2016v1-platform>.

<sup>121</sup> Han, Jaehoon. Memorandum to the Docket EPA–HQ–OAR–2019–0055: “MOVES Modeling-Related Data Files (MOVES Code, Input Databases and Runspecs) for the Proposed Heavy-Duty 2027 Standards”. February 2022.

<sup>122</sup> For example, in September 2019 several 2008 ozone nonattainment areas were reclassified from moderate to serious, including Dallas, Chicago, Connecticut, New York/New Jersey and Houston, and in January 2020, Denver. The 2008 NAAQS for ozone is an 8-hour standard with a level of 0.075 ppm, which the 2015 ozone NAAQS lowered to 0.070 ppm.

<sup>115</sup> 81 FR 73585 through 73613; 81 FR 73693 through 73719.

<sup>116</sup> 81 FR 73904.

commented that without action to reduce emissions from heavy-duty vehicles, they would have to adopt other potentially more burdensome and costly measures to reduce emissions from other sources under their state or local authority, such as local businesses. More information on the projected emission reductions and air quality impacts that would result from this proposed rule is provided in Sections VI and VII.

In their comments on the ANPR, environmental groups as well as state, local, and Tribal agencies supported additional NO<sub>x</sub> reductions from heavy-duty vehicles to address concerns about environmental justice and ensuring that all communities benefit from improvements in air quality. Commenters also supported additional NO<sub>x</sub> reductions from heavy-duty vehicles in order to address concerns about regional haze, and damage to terrestrial and aquatic ecosystems. They mentioned the impacts of NO<sub>x</sub> emissions on numerous locations, such as the Chesapeake Bay, Narragansett Bay, Long Island Sound, Joshua Tree National Park and the surrounding Mojave Desert, the Adirondacks, and other areas. Tribes and agencies commented that NO<sub>x</sub> deposition into lakes is harmful to fish and other aquatic life forms on which they depend for subsistence livelihoods. They also commented that regional haze and increased rates of weathering caused by pollution are of particular concern and can damage culturally significant archeological sites.

#### A. Background on Pollutants Impacted by This Proposal

##### 1. Ozone

Ground-level ozone pollution forms in areas with high concentrations of ambient NO<sub>x</sub> and VOCs when solar radiation is strong. Major U.S. sources of NO<sub>x</sub> are highway and nonroad motor vehicles, engines, power plants and other industrial sources, with natural sources, such as soil, vegetation, and lightning, serving as smaller sources. Vegetation is the dominant source of VOCs in the U.S. Volatile consumer and commercial products, such as propellants and solvents, highway and nonroad vehicles, engines, fires, and industrial sources also contribute to the atmospheric burden of VOCs at ground-level.

The processes underlying ozone formation, transport, and accumulation are complex. Ground-level ozone is produced and destroyed by an interwoven network of free radical reactions involving the hydroxyl radical

(OH), NO, NO<sub>2</sub>, and complex reaction intermediates derived from VOCs. Many of these reactions are sensitive to temperature and available sunlight. High ozone events most often occur when ambient temperatures and sunlight intensities remain high for several days under stagnant conditions. Ozone and its precursors can also be transported hundreds of miles downwind which can lead to elevated ozone levels in areas with otherwise low VOC or NO<sub>x</sub> emissions. As an air mass moves and is exposed to changing ambient concentrations of NO<sub>x</sub> and VOCs, the ozone photochemical regime (relative sensitivity of ozone formation to NO<sub>x</sub> and VOC emissions) can change.

When ambient VOC concentrations are high, comparatively small amounts of NO<sub>x</sub> catalyze rapid ozone formation. Without available NO<sub>x</sub>, ground-level ozone production is severely limited, and VOC reductions would have little impact on ozone concentrations. Photochemistry under these conditions is said to be “NO<sub>x</sub>-limited.” When NO<sub>x</sub> levels are sufficiently high, faster NO<sub>2</sub> oxidation consumes more radicals, dampening ozone production. Under these “VOC-limited” conditions (also referred to as “NO<sub>x</sub>-saturated” conditions), VOC reductions are effective in reducing ozone, and NO<sub>x</sub> can react directly with ozone resulting in suppressed ozone concentrations near NO<sub>x</sub> emission sources. Under these NO<sub>x</sub>-saturated conditions, NO<sub>x</sub> reductions can actually increase local ozone under certain circumstances, but overall ozone production (considering downwind formation) decreases and even in VOC-limited areas, NO<sub>x</sub> reductions are not expected to increase ozone levels if the NO<sub>x</sub> reductions are sufficiently large—large enough to become NO<sub>x</sub>-limited.

The primary NAAQS for ozone, established in 2015 and retained in 2020, is an 8-hour standard with a level of 0.07 ppm.<sup>123</sup> EPA recently announced that it will reconsider the previous administration’s decision to retain the ozone NAAQS.<sup>124</sup> The EPA is also implementing the previous 8-hour ozone primary standard, set in 2008, at a level of 0.075 ppm. As of May 31, 2021, there were 34 ozone nonattainment areas for the 2008 ozone NAAQS, composed of 151 full or partial counties, with a population of more than 99 million, and 50 ozone nonattainment areas for the 2015 ozone

NAAQS, composed of 205 full or partial counties, with a population of more than 122 million. In total, there are currently, as of May 31, 2021, 57 ozone nonattainment areas with a population of more than 122 million people.<sup>125</sup>

States with ozone nonattainment areas are required to take action to bring those areas into attainment. The attainment date assigned to an ozone nonattainment area is based on the area’s classification. The attainment dates for areas designated nonattainment for the 2008 8-hour ozone NAAQS are in the 2015 to 2032 timeframe, depending on the severity of the problem in each area. Attainment dates for areas designated nonattainment for the 2015 ozone NAAQS will be in the 2021 to 2038 timeframe, again depending on the severity of the problem in each area.<sup>126</sup> The proposed rule would begin to take effect in MY 2027 and would assist areas with attaining the NAAQS and may relieve areas with already stringent local regulations from some of the burden associated with adopting additional local controls.<sup>127</sup> The proposed rule could also provide assistance to counties with ambient concentrations near the level of the NAAQS who are working to ensure long-term attainment or maintenance of the NAAQS.

##### 2. Particulate Matter

Particulate matter (PM) is a complex mixture of solid particles and liquid droplets distributed among numerous atmospheric gases which interact with solid and liquid phases. Particles in the atmosphere range in size from less than 0.01 to more than 10 micrometers (μm) in diameter.<sup>128</sup> Atmospheric particles can be grouped into several classes according to their aerodynamic diameter and physical sizes. Generally, the three broad classes of particles include ultrafine particles (UFPs, generally

<sup>125</sup> The population total is calculated by summing, without double counting, the 2008 and 2015 ozone nonattainment populations contained in the Criteria Pollutant Nonattainment Summary report (<https://www.epa.gov/green-book/green-book-data-download>).

<sup>126</sup> <https://www.epa.gov/ground-level-ozone-pollution/ozone-naaqs-timelines>.

<sup>127</sup> While not quantified in the air quality modeling analysis for this proposed rule, the Early Adoption Incentives under the proposed program could encourage manufacturers to introduce new emission control technologies prior to the 2027 model year, which may help to accelerate some benefits of the proposed program (See Preamble Section IV.H for more details on the proposed Early Adoption Incentives).

<sup>128</sup> U.S. EPA. Policy Assessment (PA) for the Review of the National Ambient Air Quality Standards for Particulate Matter (Final Report, 2020). U.S. Environmental Protection Agency, Washington, DC, EPA/452/R-20/002, 2020.

<sup>123</sup> <https://www.epa.gov/ground-level-ozone-pollution/ozone-national-ambient-air-quality-standards-naaqs>.

<sup>124</sup> <https://www.epa.gov/ground-level-ozone-pollution/epa-reconsider-previous-administrations-decision-retain-2015-ozone>.

considered as particles with a diameter less than or equal to 0.1  $\mu\text{m}$  [typically based on physical size, thermal diffusivity or electrical mobility]), “fine” particles ( $\text{PM}_{2.5}$ ; particles with a nominal mean aerodynamic diameter less than or equal to 2.5  $\mu\text{m}$ ), and “thoracic” particles ( $\text{PM}_{10}$ ; particles with a nominal mean aerodynamic diameter less than or equal to 10  $\mu\text{m}$ ). Particles that fall within the size range between  $\text{PM}_{2.5}$  and  $\text{PM}_{10}$ , are referred to as “thoracic coarse particles” ( $\text{PM}_{10-2.5}$ , particles with a nominal mean aerodynamic diameter greater than 2.5  $\mu\text{m}$  and less than or equal to 10  $\mu\text{m}$ ). EPA currently has NAAQS for  $\text{PM}_{2.5}$  and  $\text{PM}_{10}$ .<sup>129</sup>

Most particles are found in the lower troposphere, where they can have residence times ranging from a few hours to weeks. Particles are removed from the atmosphere by wet deposition, such as when they are carried by rain or snow, or by dry deposition, when particles settle out of suspension due to gravity. Atmospheric lifetimes are generally longest for  $\text{PM}_{2.5}$ , which often remains in the atmosphere for days to weeks before being removed by wet or dry deposition.<sup>130</sup> In contrast, atmospheric lifetimes for UFP and  $\text{PM}_{10-2.5}$  are shorter. Within hours, UFP can undergo coagulation and condensation that lead to formation of larger particles in the accumulation mode, or can be removed from the atmosphere by evaporation, deposition, or reactions with other atmospheric components.  $\text{PM}_{10-2.5}$  are also generally removed from the atmosphere within hours, through wet or dry deposition.<sup>131</sup>

Particulate matter consists of both primary and secondary particles. Primary particles are emitted directly from sources, such as combustion-related activities (e.g., industrial activities, motor vehicle operation, biomass burning), while secondary particles are formed through atmospheric chemical reactions of gaseous precursors (e.g., sulfur oxides ( $\text{SO}_x$ ), nitrogen oxides ( $\text{NO}_x$ ) and volatile organic compounds (VOCs)).

<sup>129</sup> Regulatory definitions of PM size fractions, and information on reference and equivalent methods for measuring PM in ambient air, are provided in 40 CFR parts 50, 53, and 58. With regard to NAAQS which provide protection against health and welfare effects, the 24-hour  $\text{PM}_{10}$  standard provides protection against effects associated with short-term exposure to thoracic coarse particles (i.e.,  $\text{PM}_{10-2.5}$ ).

<sup>130</sup> U.S. EPA. Integrated Science Assessment (ISA) for Particulate Matter (Final Report, 2019). U.S. Environmental Protection Agency, Washington, DC, EPA/600/R-19/188, 2019. Table 2-1.

<sup>131</sup> U.S. EPA. Integrated Science Assessment (ISA) for Particulate Matter (Final Report, 2019). U.S. Environmental Protection Agency, Washington, DC, EPA/600/R-19/188, 2019. Table 2-1.

From 2000 to 2017, national annual average ambient  $\text{PM}_{2.5}$  concentrations have declined by over 40 percent,<sup>132</sup> largely reflecting reductions in emissions of precursor gases.

There are two primary NAAQS for  $\text{PM}_{2.5}$ : An annual standard (12.0 micrograms per cubic meter ( $\mu\text{g}/\text{m}^3$ )) and a 24-hour standard (35  $\mu\text{g}/\text{m}^3$ ), and there are two secondary NAAQS for  $\text{PM}_{2.5}$ : An annual standard (15.0  $\mu\text{g}/\text{m}^3$ ) and a 24-hour standard (35  $\mu\text{g}/\text{m}^3$ ). The initial  $\text{PM}_{2.5}$  standards were set in 1997 and revisions to the standards were finalized in 2006 and in December 2012 and then retained in 2020. On June 10, 2021, EPA announced that it will reconsider the previous administration’s decision to retain the PM NAAQS.<sup>133</sup>

There are many areas of the country that are currently in nonattainment for the annual and 24-hour primary  $\text{PM}_{2.5}$  NAAQS. As of May 31, 2021, more than 19 million people lived in the 4 areas that are designated as nonattainment for the 1997  $\text{PM}_{2.5}$  NAAQS. Also, as of May 31, 2021, more than 31 million people lived in the 14 areas that are designated as nonattainment for the 2006  $\text{PM}_{2.5}$  NAAQS and more than 20 million people lived in the 6 areas designated as nonattainment for the 2012  $\text{PM}_{2.5}$  NAAQS. In total, there are currently 17  $\text{PM}_{2.5}$  nonattainment areas with a population of more than 32 million people.<sup>134</sup> The proposed rule would take effect in MY 2027 and would assist areas with attaining the NAAQS and may relieve areas with already stringent local regulations from some of the burden associated with adopting additional local controls.<sup>135</sup> The proposed rule would also assist counties with ambient concentrations near the level of the NAAQS who are working to ensure long-term attainment or maintenance of the  $\text{PM}_{2.5}$  NAAQS.

### 3. Nitrogen Oxides

Oxides of nitrogen ( $\text{NO}_x$ ) refers to nitric oxide (NO) and nitrogen dioxide

<sup>132</sup> See <https://www.epa.gov/air-trends/particulate-matter-pm25-trends> and <https://www.epa.gov/air-trends/particulate-matter-pm25-trends#pmnat> for more information.

<sup>133</sup> <https://www.epa.gov/pm-pollution/national-ambient-air-quality-standards-naqs-pm>.

<sup>134</sup> The population total is calculated by summing, without double counting, the 1997, 2006 and 2012  $\text{PM}_{2.5}$  nonattainment populations contained in the Criteria Pollutant Nonattainment Summary report (<https://www.epa.gov/green-book/green-book-data-download>).

<sup>135</sup> While not quantified in the air quality modeling analysis for this proposed rule, the Early Adoption Incentives under the proposed program could encourage manufacturers to introduce new emission control technologies prior to the 2027 model year, which may help to accelerate some benefits of the proposed program (See Preamble Section IV.H for more details on the proposed Early Adoption Incentives).

( $\text{NO}_2$ ). Most  $\text{NO}_2$  is formed in the air through the oxidation of nitric oxide (NO) emitted when fuel is burned at a high temperature.  $\text{NO}_x$  is a criteria pollutant, regulated for its adverse effects on public health and the environment, and highway vehicles are an important contributor to  $\text{NO}_x$  emissions.  $\text{NO}_x$ , along with VOCs, are the two major precursors of ozone and  $\text{NO}_x$  is also a major contributor to secondary  $\text{PM}_{2.5}$  formation. There are two primary NAAQS for  $\text{NO}_2$ : An annual standard (53 ppb) and a 1-hour standard (100 ppb).<sup>136</sup> In 2010, EPA established requirements for monitoring  $\text{NO}_2$  near roadways expected to have the highest concentrations within large cities. Monitoring within this near-roadway network began in 2014, with additional sites deployed in the following years. At present, there are no nonattainment areas for  $\text{NO}_2$ .

### 4. Carbon Monoxide

Carbon monoxide (CO) is a colorless, odorless gas emitted from combustion processes. Nationally, particularly in urban areas, the majority of CO emissions to ambient air come from mobile sources.<sup>137</sup> There are two primary NAAQS for CO: An 8-hour standard (9 ppm) and a 1-hour standard (35 ppm). There are currently no CO nonattainment areas; as of September 27, 2010, all CO nonattainment areas have been redesignated to attainment. The past designations were based on the existing community-wide monitoring network. EPA made an addition to the ambient air monitoring requirements for CO during the 2011 NAAQS review. Those new requirements called for CO monitors to be operated near roads in Core Based Statistical Areas (CBSAs) of 1 million or more persons, in addition to the existing community-based network (76 FR 54294, August 31, 2011).

### 5. Diesel Exhaust

Diesel exhaust is a complex mixture composed of particulate matter, carbon dioxide, oxygen, nitrogen, water vapor, carbon monoxide, nitrogen compounds, sulfur compounds and numerous low-molecular-weight hydrocarbons. A number of these gaseous hydrocarbon components are individually known to be toxic, including aldehydes, benzene

<sup>136</sup> The statistical form of the 1-hour NAAQS for  $\text{NO}_2$  is the 3-year average of the yearly distribution of 1-hour daily maximum concentrations.

<sup>137</sup> U.S. EPA, (2010). Integrated Science Assessment for Carbon Monoxide (Final Report). U.S. Environmental Protection Agency, Washington, DC, EPA/600/R-09/019F, 2010. <http://cfpub.epa.gov/ncea/cfm/recordisplay.cfm?deid=218686>. See Section 2.1.

and 1,3-butadiene. The diesel particulate matter present in diesel exhaust consists mostly of fine particles (<2.5 µm), of which a significant fraction is ultrafine particles (<0.1 µm). These particles have a large surface area which makes them an excellent medium for adsorbing organics and their small size makes them highly respirable. Many of the organic compounds present in the gases and on the particles, such as polycyclic organic matter, are individually known to have mutagenic and carcinogenic properties.

Diesel exhaust varies significantly in chemical composition and particle sizes between different engine types (heavy-duty, light-duty), engine operating conditions (idle, acceleration, deceleration), and fuel formulations (high/low sulfur fuel). Also, there are emissions differences between on-road and nonroad engines because the nonroad engines are generally of older technology. After being emitted in the engine exhaust, diesel exhaust undergoes dilution as well as chemical and physical changes in the atmosphere. The lifetime of the components present in diesel exhaust ranges from seconds to days.

Because diesel particulate matter (DPM) is part of overall ambient PM, varies considerably in composition, and lacks distinct chemical markers that enable it to be easily distinguished from overall primary PM, we do not have direct measurements of DPM in the ambient air.<sup>138</sup> DPM concentrations are estimated using ambient air quality modeling based on DPM emission inventories. DPM emission inventories are computed as the exhaust PM emissions from mobile sources combusting diesel or residual oil fuel. DPM concentrations were estimated as part of the 2014 National Air Toxics Assessment (NATA).<sup>139</sup> Areas with high concentrations are clustered in the Northeast, Great Lake States, California, and the Gulf Coast States, with the highest impacts occurring in major urban cores, and are also distributed throughout the rest of the U.S. Approximately half of average ambient

<sup>138</sup> DPM in exhaust from a high-load, high-speed engine (e.g., heavy-duty truck engines) without aftertreatment such as a diesel particle filter (DPM) is mostly made of “soot,” consisting of elemental/black carbon (EC/BC), some organic material, and trace elements. At low loads, DPM in high-speed engine exhaust is mostly made of organic carbon (OC), with considerably less EC/BC. Low-speed diesel engines’ (e.g., large marine engines) exhaust PM is comprised of more sulfate and less EC/BC, with OC contributing as well.

<sup>139</sup> U.S. EPA (2018) Technical Support Document EPA’s 2014 National Air Toxics Assessment. <https://www.epa.gov/national-air-toxics-assessment/2014-nata-assessment-results>.

DPM in the U.S. can be attributed to heavy-duty diesel engines, with the remainder attributable to nonroad engines.

#### 6. Air Toxics

The most recent available data indicate that the majority of Americans continue to be exposed to ambient concentrations of air toxics at levels which have the potential to cause adverse health effects.<sup>140</sup> The levels of air toxics to which people are exposed vary depending on where people live and work and the kinds of activities in which they engage, as discussed in detail in EPA’s 2007 Mobile Source Air Toxics Rule.<sup>141</sup> According to the National Air Toxic Assessment (NATA) for 2014, mobile sources were responsible for over 40 percent of outdoor anthropogenic toxic emissions and were the largest contributor to national average cancer and noncancer risk from directly emitted pollutants.<sup>142 143</sup> Mobile sources are also significant contributors to precursor emissions which react to form air toxics.<sup>144</sup> Formaldehyde is the largest contributor to cancer risk of all 71 pollutants quantitatively assessed in the 2014 NATA. Mobile sources were responsible for more than 25 percent of primary anthropogenic emissions of this pollutant in 2014 and are significant contributors to formaldehyde precursor emissions. Benzene is also a large contributor to cancer risk, and mobile sources account for almost 70 percent of ambient exposure.

#### *B. Health Effects Associated With Exposure to Pollutants Impacted by This Proposal*

Heavy duty engines emit pollutants that contribute to ambient concentrations of ozone, PM, NO<sub>2</sub>, CO, and air toxics. A discussion of the

<sup>140</sup> U.S. EPA (2018) Technical Support Document EPA’s 2014 National Air Toxics Assessment. <https://www.epa.gov/national-air-toxics-assessment/2014-nata-assessment-results>.

<sup>141</sup> U.S. Environmental Protection Agency (2007). Control of Hazardous Air Pollutants from Mobile Sources; Final Rule. 72 FR 8434, February 26, 2007.

<sup>142</sup> U.S. EPA. (2018) 2014 NATA: Assessment Results. <https://www.epa.gov/national-air-toxics-assessment/2014-nata-assessment-results>.

<sup>143</sup> NATA also includes estimates of risk attributable to background concentrations, which includes contributions from long-range transport, persistent air toxics, and natural sources; as well as secondary concentrations, where toxics are formed via secondary formation. Mobile sources substantially contribute to long-range transport and secondarily formed air toxics.

<sup>144</sup> Rich Cook, Sharon Phillips, Madeleine Strum, Alison Eyth & James Thurman (2020): Contribution of mobile sources to secondary formation of carbonyl compounds, *Journal of the Air & Waste Management Association*, DOI: 10.1080/10962247.2020.1813839.

health effects associated with exposure to these pollutants, and a discussion on environmental justice, is included in this section of the preamble.

Additionally, children are recognized to have increased vulnerability and susceptibility related to air pollution and other environmental exposures; this is discussed further in Section XIII of the Preamble. Information on emission reductions and air quality impacts from this proposed rule are included in Section VI and VII of this preamble.

#### 1. Ozone

This section provides a summary of the health effects associated with exposure to ambient concentrations of ozone.<sup>145</sup> The information in this section is based on the information and conclusions in the April 2020 Integrated Science Assessment for Ozone (Ozone ISA).<sup>146</sup> The Ozone ISA concludes that human exposures to ambient concentrations of ozone are associated with a number of adverse health effects and characterizes the weight of evidence for these health effects.<sup>147</sup> The discussion below highlights the Ozone ISA’s conclusions pertaining to health effects associated with both short-term and long-term periods of exposure to ozone.

For short-term exposure to ozone, the Ozone ISA concludes that respiratory effects, including lung function decrements, pulmonary inflammation, exacerbation of asthma, respiratory-related hospital admissions, and mortality, are causally associated with ozone exposure. It also concludes that metabolic effects, including metabolic syndrome (i.e., changes in insulin or glucose levels, cholesterol levels, obesity and blood pressure) and complications due to diabetes are likely to be causally associated with short-term exposure to ozone and that evidence is suggestive of a causal relationship between cardiovascular

<sup>145</sup> Human exposure to ozone varies over time due to changes in ambient ozone concentration and because people move between locations which have notably different ozone concentrations. Also, the amount of ozone delivered to the lung is influenced not only by the ambient concentrations but also by the breathing route and rate.

<sup>146</sup> U.S. EPA. Integrated Science Assessment (ISA) for Ozone and Related Photochemical Oxidants (Final Report). U.S. Environmental Protection Agency, Washington, DC, EPA/600/R-20/012, 2020.

<sup>147</sup> The ISA evaluates evidence and draws conclusions on the causal relationship between relevant pollutant exposures and health effects, assigning one of five “weight of evidence” determinations: Causal relationship, likely to be a causal relationship, suggestive of a causal relationship, inadequate to infer a causal relationship, and not likely to be a causal relationship. For more information on these levels of evidence, please refer to Table II in the Preamble of the ISA.

effects, central nervous system effects and total mortality and short-term exposure to ozone.

For long-term exposure to ozone, the Ozone ISA concludes that respiratory effects, including new onset asthma, pulmonary inflammation and injury, are likely to be causally related with ozone exposure. The Ozone ISA characterizes the evidence as suggestive of a causal relationship for associations between long-term ozone exposure and cardiovascular effects, metabolic effects, reproductive and developmental effects, central nervous system effects and total mortality. The evidence is inadequate to infer a causal relationship between chronic ozone exposure and increased risk of cancer.

Finally, interindividual variation in human responses to ozone exposure can result in some groups being at increased risk for detrimental effects in response to exposure. In addition, some groups are at increased risk of exposure due to their activities, such as outdoor workers and children. The Ozone ISA identified several groups that are at increased risk for ozone-related health effects. These groups are people with asthma, children and older adults, individuals with reduced intake of certain nutrients (*i.e.*, Vitamins C and E), outdoor workers, and individuals having certain genetic variants related to oxidative metabolism or inflammation. Ozone exposure during childhood can have lasting effects through adulthood. Such effects include altered function of the respiratory and immune systems. Children absorb higher doses (normalized to lung surface area) of ambient ozone, compared to adults, due to their increased time spent outdoors, higher ventilation rates relative to body size, and a tendency to breathe a greater fraction of air through the mouth. Children also have a higher asthma prevalence compared to adults. Recent epidemiologic studies provide generally consistent evidence that long-term ozone exposure is associated with the development of asthma in children. Studies comparing age groups reported higher magnitude associations for short-term ozone exposure and respiratory hospital admissions and emergency room visits among children than for adults. Panel studies also provide support for experimental studies with consistent associations between short-term ozone exposure and lung function and pulmonary inflammation in healthy children. Additional children's vulnerability and susceptibility factors are listed in Section XIII of the Preamble.

## 2. Particulate Matter

Scientific evidence spanning animal toxicological, controlled human exposure, and epidemiologic studies shows that exposure to ambient PM is associated with a broad range of health effects. These health effects are discussed in detail in the Integrated Science Assessment for Particulate Matter (PM ISA), which was finalized in December 2019.<sup>148</sup> The PM ISA characterizes the causal nature of relationships between PM exposure and broad health categories (*e.g.*, cardiovascular effects, respiratory effects, etc.) using a weight-of-evidence approach.<sup>149</sup> Within this characterization, the PM ISA summarizes the health effects evidence for short- and long-term exposures to PM<sub>2.5</sub>, PM<sub>10-2.5</sub>, and ultrafine particles, and concludes that human exposures to ambient PM<sub>2.5</sub> are associated with a number of adverse health effects. The discussion below highlights the PM ISA's conclusions pertaining to the health effects evidence for both short- and long-term PM exposures. Further discussion of PM-related health effects can also be found in the 2020 Policy Assessment for the review of the PM NAAQS.<sup>150</sup>

EPA has concluded that recent evidence in combination with evidence evaluated in the 2009 PM ISA supports a "causal relationship" between both long- and short-term exposures to PM<sub>2.5</sub> and mortality and cardiovascular effects and a "likely to be causal relationship" between long- and short-term PM<sub>2.5</sub> exposures and respiratory effects.<sup>151</sup>

<sup>148</sup> U.S. EPA. Integrated Science Assessment (ISA) for Particulate Matter (Final Report, 2019). U.S. Environmental Protection Agency, Washington, DC, EPA/600/R-19/188, 2019.

<sup>149</sup> The causal framework draws upon the assessment and integration of evidence from across scientific disciplines, spanning atmospheric chemistry, exposure, dosimetry and health effects studies (*i.e.*, epidemiologic, controlled human exposure, and animal toxicological studies), and assess the related uncertainties and limitations that ultimately influence our understanding of the evidence. This framework employs a five-level hierarchy that classifies the overall weight-of-evidence with respect to the causal nature of relationships between criteria pollutant exposures and health and welfare effects using the following categorizations: Causal relationship; likely to be causal relationship; suggestive of, but not sufficient to infer, a causal relationship; inadequate to infer the presence or absence of a causal relationship; and not likely to be a causal relationship (U.S. EPA. (2019). Integrated Science Assessment for Particulate Matter (Final Report). U.S. Environmental Protection Agency, Washington, DC, EPA/600/R-19/188, Section P. 3.2.3).

<sup>150</sup> U.S. EPA. Policy Assessment (PA) for the Review of the National Ambient Air Quality Standards for Particulate Matter (Final Report, 2020). U.S. Environmental Protection Agency, Washington, DC, EPA/452/R-20/002, 2020.

<sup>151</sup> U.S. EPA. (2009). Integrated Science Assessment for Particulate Matter (Final Report).

Additionally, recent experimental and epidemiologic studies provide evidence supporting a "likely to be causal relationship" between long-term PM<sub>2.5</sub> exposure and nervous system effects, and long-term PM<sub>2.5</sub> exposure and cancer. In addition, EPA noted that there was more limited and uncertain evidence for long-term PM<sub>2.5</sub> exposure and reproductive and developmental effects (*i.e.*, male/female reproduction and fertility; pregnancy and birth outcomes), long- and short-term exposures and metabolic effects, and short-term exposure and nervous system effects resulting in the ISA concluding "suggestive of, but not sufficient to infer, a causal relationship."

As discussed extensively in the 2019 PM ISA, recent studies continue to support and extend the evidence base linking short- and long-term PM<sub>2.5</sub> exposures and mortality.<sup>152</sup> For short-term PM<sub>2.5</sub> exposure, recent multi-city studies, in combination with single- and multi-city studies evaluated in the 2009 PM ISA, provide evidence of consistent, positive associations across studies conducted in different geographic locations, populations with different demographic characteristics, and studies using different exposure assignment techniques. Additionally, the consistent and coherent evidence across scientific disciplines for cardiovascular morbidity, particularly ischemic events and heart failure, and to a lesser degree for respiratory morbidity, with the strongest evidence for exacerbations of chronic obstructive pulmonary disease (COPD) and asthma, provide biological plausibility for cause-specific mortality and ultimately total mortality.

In addition to reanalyses and extensions of the American Cancer Society (ACS) and Harvard Six Cities (HSC) cohorts, multiple new cohort studies conducted in the U.S. and Canada consisting of people employed in a specific job (*e.g.*, teacher, nurse), and that apply different exposure assignment techniques provide evidence of positive associations between long-term PM<sub>2.5</sub> exposure and mortality. Biological plausibility for mortality due to long-term PM<sub>2.5</sub> exposure is provided by the coherence of effects across scientific disciplines for cardiovascular morbidity, particularly for coronary heart disease (CHD), stroke and atherosclerosis, and for respiratory morbidity, particularly for the

U.S. Environmental Protection Agency, Washington, DC, EPA/600/R-08/139F.

<sup>152</sup> U.S. EPA. Integrated Science Assessment (ISA) for Particulate Matter (Final Report, 2019). U.S. Environmental Protection Agency, Washington, DC, EPA/600/R-19/188, 2019.



development of COPD. Additionally, recent studies provide evidence indicating that as long-term PM<sub>2.5</sub> concentrations decrease there is an increase in life expectancy.

A large body of recent studies examining both short- and long-term PM<sub>2.5</sub> exposure and cardiovascular effects supports and extends the evidence base evaluated in the 2009 PM ISA. Some of the strongest evidence from both experimental and epidemiologic studies examining short-term PM<sub>2.5</sub> exposures are for ischemic heart disease (IHD) and heart failure. The evidence for cardiovascular effects is coherent across studies of short-term PM<sub>2.5</sub> exposure that have observed associations with a continuum of effects ranging from subtle changes in indicators of cardiovascular health to serious clinical events, such as increased emergency department visits and hospital admissions due to cardiovascular disease and cardiovascular mortality. For long-term PM<sub>2.5</sub> exposure, there is strong and consistent epidemiologic evidence of a relationship with cardiovascular mortality. This evidence is supported by epidemiologic and animal toxicological studies demonstrating a range of cardiovascular effects including coronary heart disease, stroke, impaired heart function, and subclinical markers (e.g., coronary artery calcification, atherosclerotic plaque progression), which collectively provide coherence and biological plausibility.

Recent studies continue to provide evidence of a relationship between both short- and long-term PM<sub>2.5</sub> exposure and respiratory effects. Epidemiologic and animal toxicological studies examining short-term PM<sub>2.5</sub> exposure provide consistent evidence of asthma and COPD exacerbations, in children and adults, respectively. This evidence is supported by epidemiologic studies examining asthma and COPD emergency department visits and hospital admissions, as well as respiratory mortality. However, there is inconsistent evidence of respiratory effects, specifically lung function declines and pulmonary inflammation, in controlled human exposure studies. Epidemiologic studies conducted in the U.S. and abroad provide evidence of a relationship between long-term PM<sub>2.5</sub> exposure and respiratory effects, including consistent changes in lung function and lung function growth rate, increased asthma incidence, asthma prevalence, and wheeze in children; acceleration of lung function decline in adults; and respiratory mortality. The epidemiologic evidence is supported by animal toxicological studies, which

provide coherence and biological plausibility for a range of effects including impaired lung development, decrements in lung function growth, and asthma development.

Since the 2009 PM ISA, a growing body of scientific evidence examined the relationship between long-term PM<sub>2.5</sub> exposure and nervous system effects, resulting for the first time in a causality determination for this health effects category. The strongest evidence for effects on the nervous system come from epidemiologic studies that consistently report cognitive decrements and reductions in brain volume in adults. The effects observed in epidemiologic studies are supported by animal toxicological studies demonstrating effects on the brain of adult animals including inflammation, morphologic changes, and neurodegeneration of specific regions of the brain. There is more limited evidence for neurodevelopmental effects in children with some studies reporting positive associations with autism spectrum disorder (ASD) and others providing limited evidence of an association with cognitive function. While there is some evidence from animal toxicological studies indicating effects on the brain (i.e., inflammatory and morphological changes) to support a biologically plausible pathway, epidemiologic studies of neurodevelopmental effects are limited due to their lack of control for potential confounding by copollutants, the small number of studies conducted, and uncertainty regarding critical exposure windows.

Building off the decades of research demonstrating mutagenicity, DNA damage, and endpoints related to genotoxicity due to whole PM exposures, recent experimental and epidemiologic studies focusing specifically on PM<sub>2.5</sub> provide evidence of a relationship between long-term PM<sub>2.5</sub> exposure and cancer. Epidemiologic studies examining long-term PM<sub>2.5</sub> exposure and lung cancer incidence and mortality provide evidence of generally positive associations in cohort studies spanning different populations, locations, and exposure assignment techniques. Additionally, there is evidence of positive associations in analyses limited to never smokers. The epidemiologic evidence is supported by both experimental and epidemiologic evidence of genotoxicity, epigenetic effects, carcinogenic potential, and that PM<sub>2.5</sub> exhibits several characteristics of carcinogens, which collectively provides biological plausibility for cancer development.

For the additional health effects categories evaluated for PM<sub>2.5</sub> in the 2019 PM ISA, experimental and epidemiologic studies provide limited and/or inconsistent evidence of a relationship with PM<sub>2.5</sub> exposure. As a result, the 2019 PM ISA concluded that the evidence is “suggestive of, but not sufficient to infer a causal relationship” for short-term PM<sub>2.5</sub> exposure and metabolic effects and nervous system effects, and long-term PM<sub>2.5</sub> exposures and metabolic effects as well as reproductive and developmental effects.

In addition to evaluating the health effects attributed to short- and long-term exposure to PM<sub>2.5</sub>, the 2019 PM ISA also conducted an extensive evaluation as to whether specific components or sources of PM<sub>2.5</sub> are more strongly related with health effects than PM<sub>2.5</sub> mass. An evaluation of those studies resulted in the 2019 PM ISA concluding that “many PM<sub>2.5</sub> components and sources are associated with many health effects, and the evidence does not indicate that any one source or component is consistently more strongly related to health effects than PM<sub>2.5</sub> mass.”<sup>153</sup>

For both PM<sub>10-2.5</sub> and UFPs, for all health effects categories evaluated, the 2019 PM ISA concluded that the evidence was “suggestive of, but not sufficient to infer, a causal relationship” or “inadequate to determine the presence or absence of a causal relationship.” For PM<sub>10-2.5</sub>, although a Federal Reference Method (FRM) was instituted in 2011 to measure PM<sub>10-2.5</sub> concentrations nationally, the causality determinations reflect that the same uncertainty identified in the 2009 PM ISA with respect to the method used to estimate PM<sub>10-2.5</sub> concentrations in epidemiologic studies persists. Specifically, across epidemiologic studies, different approaches are used to estimate PM<sub>10-2.5</sub> concentrations (e.g., direct measurement of PM<sub>10-2.5</sub>, difference between PM<sub>10</sub> and PM<sub>2.5</sub> concentrations), and it remains unclear how well correlated PM<sub>10-2.5</sub> concentrations are both spatially and temporally across the different methods used.

For UFPs, the uncertainty in the evidence for the health effect categories evaluated across experimental and epidemiologic studies reflects the inconsistency in the exposure metric used (i.e., particle number concentration, surface area concentration, mass concentration) as well as the size fractions examined. In

<sup>153</sup> U.S. EPA. Integrated Science Assessment (ISA) for Particulate Matter (Final Report, 2019). U.S. Environmental Protection Agency, Washington, DC, EPA/600/R-19/188, 2019.

epidemiologic studies the size fraction can vary depending on the monitor used and exposure metric, with some studies examining number count over the entire particle size range, while experimental studies that use a particle concentrator often examine particles up to 0.3  $\mu\text{m}$ . Additionally, due to the lack of a monitoring network, there is limited information on the spatial and temporal variability of UFPs within the U.S., as well as population exposures to UFPs, which adds uncertainty to epidemiologic study results.

The 2019 p.m. ISA cites extensive evidence indicating that “both the general population as well as specific populations and life stages are at risk for  $\text{PM}_{2.5}$ -related health effects.”<sup>154</sup> <sup>155</sup> For example, in support of its “causal” and “likely to be causal” determinations, the ISA cites substantial evidence for (1) PM-related mortality and cardiovascular effects in older adults; (2) PM-related cardiovascular effects in people with pre-existing cardiovascular disease; (3) PM-related respiratory effects in people with pre-existing respiratory disease, particularly asthma exacerbations in children; and (4) PM-related impairments in lung function growth and asthma development in children. The ISA additionally notes that stratified analyses (*i.e.*, analyses that directly compare PM-related health effects across groups) provide strong evidence for racial and ethnic differences in  $\text{PM}_{2.5}$  exposures and in the risk of  $\text{PM}_{2.5}$ -related health effects, specifically within Hispanic and non-Hispanic Black populations. Additionally, evidence spanning epidemiologic studies that conducted stratified analyses, experimental studies focusing on animal models of disease or individuals with pre-existing disease, dosimetry studies, as well as studies focusing on differential exposure suggest that populations with pre-existing cardiovascular or respiratory disease, populations that are overweight or obese, populations that have particular genetic variants, populations that are of low socioeconomic status, and current/former smokers could be at increased risk for adverse  $\text{PM}_{2.5}$ -related health effects.

<sup>154</sup> U.S. EPA. Integrated Science Assessment (ISA) for Particulate Matter (Final Report, 2019). U.S. Environmental Protection Agency, Washington, DC, EPA/600/R-19/188, 2019.

<sup>155</sup> U.S. EPA. Policy Assessment (PA) for the Review of the National Ambient Air Quality Standards for Particulate Matter (Final Report, 2020). U.S. Environmental Protection Agency, Washington, DC, EPA/452/R-20/002, 2020.

### 3. Nitrogen Oxides

The most recent review of the health effects of oxides of nitrogen completed by EPA can be found in the 2016 Integrated Science Assessment for Oxides of Nitrogen—Health Criteria (Oxides of Nitrogen ISA).<sup>156</sup> The primary source of  $\text{NO}_2$  is motor vehicle emissions, and ambient  $\text{NO}_2$  concentrations tend to be highly correlated with other traffic-related pollutants. Thus, a key issue in characterizing the causality of  $\text{NO}_2$ -health effect relationships consists of evaluating the extent to which studies supported an effect of  $\text{NO}_2$  that is independent of other traffic-related pollutants. EPA concluded that the findings for asthma exacerbation integrated from epidemiologic and controlled human exposure studies provided evidence that is sufficient to infer a causal relationship between respiratory effects and short-term  $\text{NO}_2$  exposure. The strongest evidence supporting an independent effect of  $\text{NO}_2$  exposure comes from controlled human exposure studies demonstrating increased airway responsiveness in individuals with asthma following ambient-relevant  $\text{NO}_2$  exposures. The coherence of this evidence with epidemiologic findings for asthma hospital admissions and ED visits as well as lung function decrements and increased pulmonary inflammation in children with asthma describe a plausible pathway by which  $\text{NO}_2$  exposure can cause an asthma exacerbation. The 2016 ISA for Oxides of Nitrogen also concluded that there is likely to be a causal relationship between long-term  $\text{NO}_2$  exposure and respiratory effects. This conclusion is based on new epidemiologic evidence for associations of  $\text{NO}_2$  with asthma development in children combined with biological plausibility from experimental studies.

In evaluating a broader range of health effects, the 2016 ISA for Oxides of Nitrogen concluded that evidence is “suggestive of, but not sufficient to infer, a causal relationship” between short-term  $\text{NO}_2$  exposure and cardiovascular effects and mortality and between long-term  $\text{NO}_2$  exposure and cardiovascular effects and diabetes, birth outcomes, and cancer. In addition, the scientific evidence is inadequate (insufficient consistency of epidemiologic and toxicological evidence) to infer a causal relationship for long-term  $\text{NO}_2$  exposure with

<sup>156</sup> U.S. EPA. Integrated Science Assessment for Oxides of Nitrogen—Health Criteria (2016 Final Report). U.S. Environmental Protection Agency, Washington, DC, EPA/600/R-15/068, 2016.

fertility, reproduction, and pregnancy, as well as with postnatal development. A key uncertainty in understanding the relationship between these non-respiratory health effects and short- or long-term exposure to  $\text{NO}_2$  is copollutant confounding, particularly by other roadway pollutants. The available evidence for non-respiratory health effects does not adequately address whether  $\text{NO}_2$  has an independent effect or whether it primarily represents effects related to other or a mixture of traffic-related pollutants.

The 2016 ISA for Oxides of Nitrogen concluded that people with asthma, children, and older adults are at increased risk for  $\text{NO}_2$ -related health effects. In these groups and lifestyles,  $\text{NO}_2$  is consistently related to larger effects on outcomes related to asthma exacerbation, for which there is confidence in the relationship with  $\text{NO}_2$  exposure.

### 4. Carbon Monoxide

Information on the health effects of carbon monoxide (CO) can be found in the January 2010 Integrated Science Assessment for Carbon Monoxide (CO ISA).<sup>157</sup> The CO ISA presents conclusions regarding the presence of causal relationships between CO exposure and categories of adverse health effects.<sup>158</sup> This section provides a summary of the health effects associated with exposure to ambient concentrations of CO, along with the CO ISA conclusions.<sup>159</sup>

Controlled human exposure studies of subjects with coronary artery disease show a decrease in the time to onset of exercise-induced angina (chest pain) and electrocardiogram changes following CO exposure. In addition, epidemiologic studies observed associations between short-term CO exposure and cardiovascular morbidity, particularly increased emergency room visits and hospital admissions for

<sup>157</sup> U.S. EPA, (2010). Integrated Science Assessment for Carbon Monoxide (Final Report). U.S. Environmental Protection Agency, Washington, DC, EPA/600/R-09/019F, 2010. <http://cfpub.epa.gov/ncea/cfm/recordisplay.cfm?deid=218686>.

<sup>158</sup> The ISA evaluates the health evidence associated with different health effects, assigning one of five “weight of evidence” determinations: causal relationship, likely to be a causal relationship, suggestive of a causal relationship, inadequate to infer a causal relationship, and not likely to be a causal relationship. For definitions of these levels of evidence, please refer to Section 1.6 of the ISA.

<sup>159</sup> Personal exposure includes contributions from many sources, and in many different environments. Total personal exposure to CO includes both ambient and non-ambient components; and both components may contribute to adverse health effects.

coronary heart disease (including ischemic heart disease, myocardial infarction, and angina). Some epidemiologic evidence is also available for increased hospital admissions and emergency room visits for congestive heart failure and cardiovascular disease as a whole. The CO ISA concludes that a causal relationship is likely to exist between short-term exposures to CO and cardiovascular morbidity. It also concludes that available data are inadequate to conclude that a causal relationship exists between long-term exposures to CO and cardiovascular morbidity.

Animal studies show various neurological effects with in-utero CO exposure. Controlled human exposure studies report central nervous system and behavioral effects following low-level CO exposures, although the findings have not been consistent across all studies. The CO ISA concludes that the evidence is suggestive of a causal relationship with both short- and long-term exposure to CO and central nervous system effects.

A number of studies cited in the CO ISA have evaluated the role of CO exposure in birth outcomes such as preterm birth or cardiac birth defects. There is limited epidemiologic evidence of a CO-induced effect on preterm births and birth defects, with weak evidence for a decrease in birth weight. Animal toxicological studies have found perinatal CO exposure to affect birth weight, as well as other developmental outcomes. The CO ISA concludes that the evidence is suggestive of a causal relationship between long-term exposures to CO and developmental effects and birth outcomes.

Epidemiologic studies provide evidence of associations between short-term CO concentrations and respiratory morbidity such as changes in pulmonary function, respiratory symptoms, and hospital admissions. A limited number of epidemiologic studies considered copollutants such as ozone, SO<sub>2</sub>, and PM in two-pollutant models and found that CO risk estimates were generally robust, although this limited evidence makes it difficult to disentangle effects attributed to CO itself from those of the larger complex air pollution mixture. Controlled human exposure studies have not extensively evaluated the effect of CO on respiratory morbidity. Animal studies at levels of 50–100 ppm CO show preliminary evidence of altered pulmonary vascular remodeling and oxidative injury. The CO ISA concludes that the evidence is suggestive of a causal relationship between short-term CO exposure and respiratory morbidity, and inadequate to

conclude that a causal relationship exists between long-term exposure and respiratory morbidity.

Finally, the CO ISA concludes that the epidemiologic evidence is suggestive of a causal relationship between short-term concentrations of CO and mortality. Epidemiologic evidence suggests an association exists between short-term exposure to CO and mortality, but limited evidence is available to evaluate cause-specific mortality outcomes associated with CO exposure. In addition, the attenuation of CO risk estimates which was often observed in copollutant models contributes to the uncertainty as to whether CO is acting alone or as an indicator for other combustion-related pollutants. The CO ISA also concludes that there is not likely to be a causal relationship between relevant long-term exposures to CO and mortality.

##### 5. Diesel Exhaust

In EPA's 2002 Diesel Health Assessment Document (Diesel HAD), exposure to diesel exhaust was classified as likely to be carcinogenic to humans by inhalation from environmental exposures, in accordance with the revised draft 1996/1999 EPA cancer guidelines.<sup>160 161</sup> A number of other agencies (National Institute for Occupational Safety and Health, the International Agency for Research on Cancer, the World Health Organization, California EPA, and the U.S. Department of Health and Human Services) made similar hazard classifications prior to 2002. EPA also concluded in the 2002 Diesel HAD that it was not possible to calculate a cancer unit risk for diesel exhaust due to limitations in the exposure data for the occupational groups or the absence of a dose-response relationship.

In the absence of a cancer unit risk, the Diesel HAD sought to provide additional insight into the significance of the diesel exhaust cancer hazard by estimating possible ranges of risk that might be present in the population. An exploratory analysis was used to characterize a range of possible lung cancer risk. The outcome was that environmental risks of cancer from long-term diesel exhaust exposures could plausibly range from as low as 10<sup>-5</sup> to

as high as 10<sup>-3</sup>. Because of uncertainties, the analysis acknowledged that the risks could be lower than 10<sup>-5</sup>, and a zero risk from diesel exhaust exposure could not be ruled out.

Noncancer health effects of acute and chronic exposure to diesel exhaust emissions are also of concern to EPA. EPA derived a diesel exhaust reference concentration (RfC) from consideration of four well-conducted chronic rat inhalation studies showing adverse pulmonary effects. The RfC is 5 µg/m<sup>3</sup> for diesel exhaust measured as diesel particulate matter. This RfC does not consider allergenic effects such as those associated with asthma or immunologic or the potential for cardiac effects. There was emerging evidence in 2002, discussed in the Diesel HAD, that exposure to diesel exhaust can exacerbate these effects, but the exposure-response data were lacking at that time to derive an RfC based on these then-emerging considerations. The Diesel HAD states, "With [diesel particulate matter] being a ubiquitous component of ambient PM, there is an uncertainty about the adequacy of the existing [diesel exhaust] noncancer database to identify all of the pertinent [diesel exhaust]-caused noncancer health hazards." The Diesel HAD also notes "that acute exposure to [diesel exhaust] has been associated with irritation of the eye, nose, and throat, respiratory symptoms (cough and phlegm), and neurophysiological symptoms such as headache, lightheadedness, nausea, vomiting, and numbness or tingling of the extremities." The Diesel HAD notes that the cancer and noncancer hazard conclusions applied to the general use of diesel engines then on the market and as cleaner engines replace a substantial number of existing ones, the applicability of the conclusions would need to be reevaluated.

It is important to note that the Diesel HAD also briefly summarizes health effects associated with ambient PM and discusses EPA's then-annual PM<sub>2.5</sub> NAAQS of 15 µg/m<sup>3</sup>. In 2012, EPA revised the annual PM<sub>2.5</sub> NAAQS to 12 µg/m<sup>3</sup> and then retained that standard in 2020, as of June 10, 2021 EPA is reconsidering the PM<sub>2.5</sub> NAAQS.<sup>162</sup> There is a large and extensive body of human data showing a wide spectrum of adverse health effects associated with exposure to ambient PM, of which diesel exhaust is an important component. The PM<sub>2.5</sub> NAAQS is designed to provide protection from the

<sup>160</sup> U.S. EPA. (1999). Guidelines for Carcinogen Risk Assessment. Review Draft. NCEA-F-0644, July. Washington, DC: U.S. EPA. Retrieved on March 19, 2009 from <http://cfpub.epa.gov/ncea/cfm/recordisplay.cfm?deid=54932>.

<sup>161</sup> U.S. EPA (2002). Health Assessment Document for Diesel Engine Exhaust. EPA/600/8-90/057F Office of research and Development. Washington, DC. Retrieved on March 17, 2009 from <http://cfpub.epa.gov/ncea/cfm/recordisplay.cfm?deid=29060>. pp. 1-1 1-2.

<sup>162</sup> <https://www.epa.gov/pm-pollution/national-ambient-air-quality-standards-naaqs-pm>.

noncancer health effects and premature mortality attributed to exposure to PM<sub>2.5</sub>. The contribution of diesel PM to total ambient PM varies in different regions of the country and also, within a region, from one area to another. The contribution can be high in near-roadway environments, for example, or in other locations where diesel engine use is concentrated.

Since 2002, several new studies have been published which continue to report increased lung cancer risk associated with occupational exposure to diesel exhaust from older engines. Of particular note since 2011 are three new epidemiology studies which have examined lung cancer in occupational populations, for example, truck drivers, underground nonmetal miners and other diesel motor-related occupations. These studies reported increased risk of lung cancer with exposure to diesel exhaust with evidence of positive exposure-response relationships to varying degrees.<sup>163 164 165</sup> These newer studies (along with others that have appeared in the scientific literature) add to the evidence EPA evaluated in the 2002 Diesel HAD and further reinforce the concern that diesel exhaust exposure likely poses a lung cancer hazard. The findings from these newer studies do not necessarily apply to newer technology diesel engines (*i.e.*, heavy-duty highway engines from 2007 and later model years) since the newer engines have large reductions in the emission constituents compared to older technology diesel engines.

In light of the growing body of scientific literature evaluating the health effects of exposure to diesel exhaust, in June 2012 the World Health Organization's International Agency for Research on Cancer (IARC), a recognized international authority on the carcinogenic potential of chemicals and other agents, evaluated the full range of cancer-related health effects data for diesel engine exhaust. IARC concluded that diesel exhaust should be regarded as "carcinogenic to humans."<sup>166</sup> This designation was an

update from its 1988 evaluation that considered the evidence to be indicative of a "probable human carcinogen."

#### 6. Air Toxics

Heavy-duty engine emissions contribute to ambient levels of air toxics that are known or suspected human or animal carcinogens, or that have noncancer health effects. These compounds include, but are not limited to, benzene, formaldehyde, acetaldehyde, and naphthalene. These compounds were identified as national or regional risk drivers or contributors in the 2014 National-scale Air Toxics Assessment and have significant inventory contributions from mobile sources.<sup>167 168</sup> Chapter 4 of the draft RIA includes additional information on the health effects associated with exposure to each of these pollutants.

#### 7. Exposure and Health Effects Associated With Traffic

Locations in close proximity to major roadways generally have elevated concentrations of many air pollutants emitted from motor vehicles. Hundreds of such studies have been published in peer-reviewed journals, concluding that concentrations of CO, CO<sub>2</sub>, NO, NO<sub>2</sub>, benzene, aldehydes, particulate matter, black carbon, and many other compounds are elevated in ambient air within approximately 300–600 meters (about 1,000–2,000 feet) of major roadways. The highest concentrations of most pollutants emitted directly by motor vehicles are found at locations within 50 meters (about 165 feet) of the edge of a roadway's traffic lanes.

A large-scale review of air quality measurements in the vicinity of major roadways between 1978 and 2008 concluded that the pollutants with the steepest concentration gradients in vicinities of roadways were CO, ultrafine particles, metals, elemental carbon (EC), NO, NO<sub>x</sub>, and several VOCs.<sup>169</sup> These pollutants showed a large reduction in concentrations within 100 meters downwind of the roadway. Pollutants that showed more gradual reductions with distance from roadways

included benzene, NO<sub>2</sub>, PM<sub>2.5</sub>, and PM<sub>10</sub>. In the review article, results varied based on the method of statistical analysis used to determine the gradient in concentration. More recent studies continue to show significant concentration gradients of traffic-related air pollution around major roads.<sup>170 171 172 173 174 175 176 177</sup> There is evidence that EPA's regulations for vehicles have lowered the near-road concentrations and gradients.<sup>178</sup> Starting in 2010, EPA required through the NAAQS process that air quality monitors be placed near high-traffic roadways for determining concentrations of CO, NO<sub>2</sub>, and PM<sub>2.5</sub>

<sup>170</sup> McDonald, B.C.; McBride, Z.C.; Martin, E.W.; Harley, R.A. (2014) High-resolution mapping of motor vehicle carbon dioxide emissions. *J. Geophys. Res. Atmos.*, 119, 5283–5298, doi:10.1002/2013JD021219.

<sup>171</sup> Kimbrough, S.; Baldauf, R.W.; Hagler, G.S.W.; Shores, R.C.; Mitchell, W.; Whitaker, D.A.; Croghan, C.W.; Vallero, D.A. (2013) Long-term continuous measurement of near-road air pollution in Las Vegas: seasonal variability in traffic emissions impact on air quality. *Air Qual Atmos Health* 6: 295–305. DOI:10.1007/s11869-012-0171-x.

<sup>172</sup> Kimbrough, S.; Palma, T.; Baldauf, R.W. (2014) Analysis of mobile source air toxics (MSATs)—Near-road VOC and carbonyl concentrations. *Journal of the Air & Waste Management Association*, 64:3, 349–359, DOI:10.1080/10962247.2013.863814.

<sup>173</sup> Kimbrough, S.; Owen, R.C.; Snyder, M.; Richmond-Bryant, J. (2017) NO to NO<sub>2</sub> Conversion Rate Analysis and Implications for Dispersion Model Chemistry Methods using Las Vegas, Nevada Near-Road Field Measurements. *Atmos Environ* 165: 23–24.

<sup>174</sup> Hilker, N.; Wang, J.W.; Jong, C.-H.; Healy, R.M.; Sofowote, U.; Debosz, J.; Su, Y.; Noble, M.; Munoz, A.; Doerkson, G.; White, L.; Audette, C.; Herod, D.; Brook, J.R.; Evans, G.J. (2019) Traffic-related air pollution near roadways: discerning local impacts from background. *Atmos. Meas. Tech.*, 12, 5247–5261. <https://doi.org/10.5194/amt-12-5247-2019>.

<sup>175</sup> Grivas, G.; Stavroulas, I.; Liakakou, E.; Kaskaoutis, D.G.; Bougiatioti, A.; Paraskevopoulou, D.; Gerasopoulos, E.; Mihalopoulos, N. (2019) Measuring the spatial variability of black carbon in Athens during wintertime. *Air Quality, Atmosphere & Health* (2019) 12:1405–1417. <https://doi.org/10.1007/s11869-019-00756-y>.

<sup>176</sup> Apte, J.S.; Messier, K.P.; Gani, S.; Brauer, M.; Kirchstetter, T.W.; Lunden, M.M.; Marshall, J.D.; Portier, C.J.; Vermeulen, R.C.H.; Hamburg, S.P. (2017) High-Resolution Air Pollution Mapping with Google Street View Cars: Exploiting Big Data. *Environ Sci Technol* 51: 6999–7008. <https://doi.org/10.1021/acs.est.7b00891>.

<sup>177</sup> Dabek-Zlotorzynska, E.; Celo, V.; Ding, L.; Herod, D.; Jeong, C.-H.; Evans, G.; Hilker, N. (2019) Characteristics and sources of PM<sub>2.5</sub> and reactive gases near roadways in two metropolitan areas in Canada. *Atmos Environ* 218: 116980. <https://doi.org/10.1016/j.atmosenv.2019.116980>.

<sup>178</sup> Sarnat, J.A.; Russell, A.; Liang, D.; Moutinho, J.L.; Golan, R.; Weber, R.; Gao, D.; Sarnat, S.; Chang, H.H.; Greenwald, R.; Yu, T. (2018) Developing Multipollutant Exposure Indicators of Traffic Pollution: The Dorm Room Inhalation to Vehicle Emissions (DRIVE) Study. Health Effects Institute Research Report Number 196. [Online at: <https://www.healtheffects.org/publication/developing-multipollutant-exposure-indicators-traffic-pollution-dorm-room-inhalation>].

<sup>163</sup> Garshick, Eric, Francine Laden, Jaime E. Hart, Mary E. Davis, Ellen A. Eisen, and Thomas J. Smith. 2012. Lung cancer and elemental carbon exposure in trucking industry workers. *Environmental Health Perspectives* 120(9): 1301–1306.

<sup>164</sup> Silverman, D.T., Samanic, C.M., Lubin, J.H., Blair, A.E., Stewart, P.A., Vermeulen, R., & Attfield, M.D. (2012). The diesel exhaust in miners study: A nested case-control study of lung cancer and diesel exhaust. *Journal of the National Cancer Institute*.

<sup>165</sup> Olsson, Ann C., et al. "Exposure to diesel motor exhaust and lung cancer risk in a pooled analysis from case-control studies in Europe and Canada." *American journal of respiratory and critical care medicine* 183.7 (2011): 941–948.

<sup>166</sup> IARC [International Agency for Research on Cancer]. (2013). Diesel and gasoline engine exhausts

and some nitroarenes. IARC Monographs Volume 105. [Online at <http://monographs.iarc.fr/ENG/Monographs/vol105/index.php>].

<sup>167</sup> U.S. EPA (2018) Technical Support Document EPA's 2014 National Air Toxics Assessment. <https://www.epa.gov/national-air-toxics-assessment/2014-nata-assessment-results>.

<sup>168</sup> U.S. EPA (2018) 2014 NATA Summary of Results. [https://www.epa.gov/sites/production/files/2020-07/documents/nata\\_2014\\_summary\\_of\\_results.pdf](https://www.epa.gov/sites/production/files/2020-07/documents/nata_2014_summary_of_results.pdf).

<sup>169</sup> Karner, A.A.; Eisinger, D.S.; Niemeier, D.A. (2010). Near-roadway air quality: synthesizing the findings from real-world data. *Environ Sci Technol* 44: 5334–5344.

(in addition to those existing monitors located in neighborhoods and other locations farther away from pollution sources). The monitoring data for NO<sub>2</sub> indicate that in urban areas, monitors near roadways often report the highest concentrations of NO<sub>2</sub>.

For pollutants with relatively high background concentrations relative to near-road concentrations, detecting concentration gradients can be difficult. For example, many aldehydes have high background concentrations as a result of photochemical breakdown of precursors from many different organic compounds. However, several studies have measured aldehydes in multiple weather conditions and found higher concentrations of many carbonyls downwind of roadways.<sup>179 180</sup> These findings suggest a substantial roadway source of these carbonyls.

In the past 20 years, many studies have been published with results reporting that populations who live, work, or go to school near high-traffic roadways experience higher rates of numerous adverse health effects, compared to populations far away from major roads.<sup>181</sup> In addition, numerous studies have found adverse health effects associated with spending time in traffic, such as commuting or walking along high-traffic roadways.<sup>182 183 184 185</sup> The health outcomes with the strongest evidence linking them with traffic-associated air pollutants are respiratory effects, particularly in asthmatic children, and cardiovascular effects.

<sup>179</sup> Liu, W.; Zhang, J.; Kwon, J.I.; et al. (2006). Concentrations and source characteristics of airborne carbonyl compounds measured outside urban residences. *J Air Waste Manage Assoc* 56: 1196–1204.

<sup>180</sup> Cahill, T.M.; Charles, M.J.; Seaman, V.Y. (2010). Development and application of a sensitive method to determine concentrations of acrolein and other carbonyls in ambient air. *Health Effects Institute Research Report 149*. Available at <https://www.healtheffects.org/system/files/Cahill149.pdf>.

<sup>181</sup> In the widely-used PubMed database of health publications, between January 1, 1990 and August 18, 2011, 605 publications contained the keywords “traffic, pollution, epidemiology,” with approximately half the studies published after 2007.

<sup>182</sup> Laden, F.; Hart, J.E.; Smith, T.J.; Davis, M.E.; Garshick, E. (2007) Cause-specific mortality in the unionized U.S. trucking industry. *Environmental Health Perspect* 115:1192–1196.

<sup>183</sup> Peters, A.; von Klot, S.; Heier, M.; Trentinaglia, I.; Hörmann, A.; Wichmann, H.E.; Löwel, H. (2004) Exposure to traffic and the onset of myocardial infarction. *New England J Med* 351: 1721–1730.

<sup>184</sup> Zanobetti, A.; Stone, P.H.; Spelzer, F.E.; Schwartz, J.D.; Coull, B.A.; Suh, H.H.; Nearling, B.D.; Mittleman, M.A.; Verrier, R.L.; Gold, D.R. (2009) T-wave alternans, air pollution and traffic in high-risk subjects. *Am J Cardiol* 104: 665–670.

<sup>185</sup> Adar, S.; Adamkiewicz, G.; Gold, D.R.; Schwartz, J.; Coull, B.A.; Suh, H. (2007) Ambient and microenvironmental particles and exhaled nitric oxide before and after a group bus trip. *Environ Health Perspect* 115: 507–512.

ANPR commenters stress the importance of consideration of the impacts of traffic-related air pollution on children’s health.

Numerous reviews of this body of health literature have been published as well. In 2010, an expert panel of the Health Effects Institute (HEI) published a review of hundreds of exposure, epidemiology, and toxicology studies.<sup>186</sup> The panel rated how the evidence for each type of health outcome supported a conclusion of a causal association with traffic-associated air pollution as either “sufficient,” “suggestive but not sufficient,” or “inadequate and insufficient.” The panel categorized evidence of a causal association for exacerbation of childhood asthma as “sufficient.” The panel categorized evidence of a causal association for new onset asthma as between “sufficient” and “suggestive but not sufficient.” “Suggestive of a causal association” was how the panel categorized evidence linking traffic-associated air pollutants with exacerbation of adult respiratory symptoms and lung function decrement. It categorized as “inadequate and insufficient” evidence of a causal relationship between traffic-related air pollution and health care utilization for respiratory problems, new onset adult asthma, chronic obstructive pulmonary disease (COPD), non-asthmatic respiratory allergy, and cancer in adults and children. Currently, HEI is conducting another expert review of health studies associated with traffic-related air pollution published after the studies included in their 2010 review.<sup>187</sup> Other literature reviews have been published with conclusions generally similar to the 2010 HEI panel’s.<sup>188 189 190 191</sup> However, in 2014,

<sup>186</sup> Health Effects Institute Panel on the Health Effects of Traffic-Related Air Pollution. (2010). *Traffic-related air pollution: a critical review of the literature on emissions, exposure, and health effects*. HEI Special Report 17. Available at <http://www.healtheffects.org>.

<sup>187</sup> Health Effects Institute. (2019) Protocol for a Systematic Review and Meta-Analysis of Selected Health Effects of Long-Term Exposure to Traffic-Related Air Pollution. PROSPERO 2019 CRD42019150642 Available from: [https://www.crd.york.ac.uk/prospero/display\\_record.php?ID=CRD42019150642](https://www.crd.york.ac.uk/prospero/display_record.php?ID=CRD42019150642).

<sup>188</sup> Boothe, V.L.; Shendell, D.G. (2008). Potential health effects associated with residential proximity to freeways and primary roads: review of scientific literature, 1999–2006. *J Environ Health* 70: 33–41.

<sup>189</sup> Salam, M.T.; Islam, T.; Gilliland, F.D. (2008). Recent evidence for adverse effects of residential proximity to traffic sources on asthma. *Curr Opin Pulm Med* 14: 3–8.

<sup>190</sup> Sun, X.; Zhang, S.; Ma, X. (2014) No association between traffic density and risk of childhood leukemia: a meta-analysis. *Asia Pac J Cancer Prev* 15: 5229–5232.

<sup>191</sup> Raaschou-Nielsen, O.; Reynolds, P. (2006). Air pollution and childhood cancer: a review of the

researchers from the U.S. Centers for Disease Control and Prevention (CDC) published a systematic review and meta-analysis of studies evaluating the risk of childhood leukemia associated with traffic exposure and reported positive associations between “postnatal” proximity to traffic and leukemia risks, but no such association for “prenatal” exposures.<sup>192</sup> The U.S. Department of Health and Human Services’ National Toxicology Program (NTP) recently published a monograph including a systematic review of traffic-related air pollution (TRAP) and its impacts on hypertensive disorders of pregnancy. NTP concluded that exposure to TRAP is “presumed to be a hazard to pregnant women” for developing hypertensive disorders of pregnancy.<sup>193</sup>

Health outcomes with few publications suggest the possibility of other effects still lacking sufficient evidence to draw definitive conclusions. Among these outcomes with a small number of positive studies are neurological impacts (e.g., autism and reduced cognitive function) and reproductive outcomes (e.g., preterm birth, low birth weight).<sup>194 195 196 197</sup>

In addition to health outcomes, particularly cardiopulmonary effects, conclusions of numerous studies suggest mechanisms by which traffic-related air pollution affects health. Numerous studies indicate that near-roadway exposures may increase systemic inflammation, affecting organ systems,

epidemiological literature. *Int J Cancer* 118: 2920–9.

<sup>192</sup> Boothe, V.L.; Boehmer, T.K.; Wendel, A.M.; Yip, F.Y. (2014) Residential traffic exposure and childhood leukemia: a systematic review and meta-analysis. *Am J Prev Med* 46: 413–422.

<sup>193</sup> National Toxicology Program (2019) NTP Monograph n the Systematic Review of Traffic-related Air Pollution and Hypertensive Disorders of Pregnancy. NTP Monograph 7. [https://ntp.niehs.nih.gov/ntp/ohat/trap/mgraph/trap\\_final\\_508.pdf](https://ntp.niehs.nih.gov/ntp/ohat/trap/mgraph/trap_final_508.pdf).

<sup>194</sup> Volk, H.E.; Hertz-Picciotto, I.; Delwiche, L.; et al. (2011). Residential proximity to freeways and autism in the CHARGE study. *Environ Health Perspect* 119: 873–877.

<sup>195</sup> Franco-Suglia, S.; Gryparis, A.; Wright, R.O.; et al. (2007). Association of black carbon with cognition among children in a prospective birth cohort study. *Am J Epidemiol*. doi: 10.1093/aje/kwm308. [Online at <http://dx.doi.org>].

<sup>196</sup> Power, M.C.; Weisskopf, M.G.; Alexeeff, S.E.; et al. (2011). Traffic-related air pollution and cognitive function in a cohort of older men. *Environ Health Perspect* 2011: 682–687.

<sup>197</sup> Wu, J.; Wilhelm, M.; Chung, J.; et al. (2011). Comparing exposure assessment methods for traffic-related air pollution in and adverse pregnancy outcome study. *Environ Res* 111: 685–692.

including blood vessels and lungs.<sup>198 199 200 201</sup> Long-term exposures in near-road environments have been associated with inflammation-associated conditions, such as atherosclerosis and asthma.<sup>202 203 204</sup>

Several studies suggest that some factors may increase susceptibility to the effects of traffic-associated air pollution. Several studies have found stronger respiratory associations in children experiencing chronic social stress, such as in violent neighborhoods or in homes with high family stress.<sup>205 206 207</sup>

The risks associated with residence, workplace, or schools near major roads are of potentially high public health significance due to the large population in such locations. Every two years from 1997 to 2009 and in 2011, the U.S. Census Bureau's American Housing Survey (AHS) conducted a survey that includes whether housing units are within 300 feet of an "airport, railroad,

or highway with four or more lanes."<sup>208</sup> The 2013 AHS was the last AHS that included that question. The 2013 survey reports that 17.3 million housing units, or 13 percent of all housing units in the U.S., were in such areas. Assuming that populations and housing units are in the same locations, this corresponds to a population of more than 41 million U.S. residents in close proximity to high-traffic roadways or other transportation sources. According to the Central Intelligence Agency's World Factbook, based on data collected between 2012–2014, the United States had 6,586,610 km of roadways, 293,564 km of railways, and 13,513 airports. As such, highways represent the overwhelming majority of transportation facilities described by this factor in the AHS.

EPA also conducted a recent study to estimate the number of people living near truck freight routes in the United States.<sup>209</sup> Based on a population analysis using the U.S. Department of Transportation's (USDOT) Freight Analysis Framework 4 (FAF4) and population data from the 2010 decennial census, an estimated 72 million people live within 200 meters of these freight routes.<sup>210</sup> In addition, relative to the rest of the population, people of color and those with lower incomes are more likely to live near FAF4 truck routes. They are also more likely to live in metropolitan areas. Past work has also shown that, on average, Americans spend more than an hour traveling each day, bringing nearly all residents into a high-exposure microenvironment for part of the day.<sup>211</sup>

## 8. Environmental Justice

Executive Order 12898 (59 FR 7629, February 16, 1994) establishes federal executive policy on environmental justice. It directs federal agencies, to the

greatest extent practicable and permitted by law, to make achieving environmental justice part of their mission by identifying and addressing, as appropriate, disproportionately high and adverse human health or environmental effects of their programs, policies, and activities on minority populations and low-income populations in the United States. EPA defines environmental justice as the fair treatment and meaningful involvement of all people regardless of race, color, national origin, or income with respect to the development, implementation, and enforcement of environmental laws, regulations, and policies.<sup>212</sup>

Executive Order 14008 (86 FR 7619, February 1, 2021) also calls on federal agencies to make achieving environmental justice part of their respective missions "by developing programs, policies, and activities to address the disproportionately high and adverse human health, environmental, climate-related and other cumulative impacts on disadvantaged communities, as well as the accompanying economic challenges of such impacts." It declares a policy "to secure environmental justice and spur economic opportunity for disadvantaged communities that have been historically marginalized and overburdened by pollution and underinvestment in housing, transportation, water and wastewater infrastructure and health care."

Under Executive Order 13563 (76 FR 3821, January 18, 2011), federal agencies may consider equity, human dignity, fairness, and distributional considerations in their regulatory analyses, where appropriate and permitted by law.

<sup>212</sup> Fair treatment means that "no group of people should bear a disproportionate burden of environmental harms and risks, including those resulting from the negative environmental consequences of industrial, governmental and commercial operations or programs and policies." Meaningful involvement occurs when "(1) potentially affected populations have an appropriate opportunity to participate in decisions about a proposed activity [e.g., rulemaking] that will affect their environment and/or health; (2) the public's contribution can influence [the EPA's rulemaking] decision; (3) the concerns of all participants involved will be considered in the decision-making process; and (4) [the EPA will] seek out and facilitate the involvement of those potentially affected." A potential EJ concern is defined as "the actual or potential lack of fair treatment or meaningful involvement of minority populations, low-income populations, tribes, and indigenous peoples in the development, implementation and enforcement of environmental laws, regulations and policies." See "Guidance on Considering Environmental Justice During the Development of a Regulatory Action," Environmental Protection Agency, <https://www.epa.gov/environmentaljustice/guidance-considering-environmental-justice-during-development-action>. See also <https://www.epa.gov/environmentaljustice>.

<sup>198</sup> Riediker, M. (2007). Cardiovascular effects of fine particulate matter components in highway patrol officers. *Inhal Toxicol* 19: 99–105. doi:10.1080/08958370701495238

<sup>199</sup> Alexeef, SE; Coull, B.A.; Gryparis, A.; et al. (2011). Medium-term exposure to traffic-related air pollution and markers of inflammation and endothelial function. *Environ Health Perspect* 119: 481–486. doi:10.1289/ehp.1002560

<sup>200</sup> Eckel, S.P.; Berhane, K.; Salam, M.T.; et al. (2011). Residential Traffic-related pollution exposure and exhaled nitric oxide in the Children's Health Study. *Environ Health Perspect*. doi:10.1289/ehp.1103516.

<sup>201</sup> Zhang, J.; McCreanor, J.E.; Cullinan, P.; et al. (2009). Health effects of real-world exposure diesel exhaust in persons with asthma. *Res Rep Health Effects Inst* 138. [Online at <http://www.healtheffects.org>].

<sup>202</sup> Adar, S.D.; Klein, R.; Klein, E.K.; et al. (2010). Air pollution and the microvasculature: a cross-sectional assessment of in vivo retinal images in the population-based Multi-Ethnic Study of Atherosclerosis. *PLoS Med* 7(11): E1000372. doi:10.1371/journal.pmed.1000372. Available at <http://dx.doi.org>.

<sup>203</sup> Kan, H.; Heiss, G.; Rose, K.M.; et al. (2008). Prospective analysis of traffic exposure as a risk factor for incident coronary heart disease: The Atherosclerosis Risk in Communities (ARIC) study. *Environ Health Perspect* 116: 1463–1468. doi:10.1289/ehp.11290. Available at <http://dx.doi.org>.

<sup>204</sup> McConnell, R.; Islam, T.; Shankardass, K.; et al. (2010). Childhood incident asthma and traffic-related air pollution at home and school. *Environ Health Perspect* 1021–1026.

<sup>205</sup> Islam, T.; Urban, R.; Gauderman, W.J.; et al. (2011). Parental stress increases the detrimental effect of traffic exposure on children's lung function. *Am J Respir Crit Care Med*.

<sup>206</sup> Clougherty, J.E.; Levy, J.I.; Kubzansky, L.D.; et al. (2007). Synergistic effects of traffic-related air pollution and exposure to violence on urban asthma etiology. *Environ Health Perspect* 115: 1140–1146.

<sup>207</sup> Chen, E.; Schrier, H.M.; Strunk, R.C.; et al. (2008). Chronic traffic-related air pollution and stress interact to predict biologic and clinical outcomes in asthma. *Environ Health Perspect* 116: 970–5.

<sup>208</sup> The variable was known as "ETTRANS" in the questions about the neighborhood.

<sup>209</sup> U.S. EPA (2021). Estimation of Population Size and Demographic Characteristics among People Living Near Truck Routes in the Conterminous United States. Memorandum to the Docket.

<sup>210</sup> FAF4 is a model from the USDOT's Bureau of Transportation Statistics (BTS) and Federal Highway Administration (FHWA), which provides data associated with freight movement in the U.S. It includes data from the 2012 Commodity Flow Survey (CFS), the Census Bureau on international trade, as well as data associated with construction, agriculture, utilities, warehouses, and other industries. FAF4 estimates the modal choices for moving goods by trucks, trains, boats, and other types of freight modes. It includes traffic assignments, including truck flows on a network of truck routes. [https://ops.fhwa.dot.gov/freight/freight\\_analysis/faf/](https://ops.fhwa.dot.gov/freight/freight_analysis/faf/).

<sup>211</sup> EPA. (2011) Exposure Factors Handbook: 2011 Edition. Chapter 16. [Online at <https://www.epa.gov/sites/production/files/2015-09/documents/efh-chapter16.pdf>].

EPA's 2016 "Technical Guidance for Assessing Environmental Justice in Regulatory Analysis" provides recommendations on conducting the highest quality analysis feasible, recognizing that data limitations, time and resource constraints, and analytic challenges will vary by media and regulatory context.<sup>213</sup> When assessing the potential for disproportionately high and adverse health or environmental impacts of regulatory actions on minority populations, low-income populations, Tribes, and/or indigenous peoples, the EPA strives to answer three broad questions: (1) Is there evidence of potential environmental justice (EJ) concerns in the baseline (the state of the world absent the regulatory action)? Assessing the baseline will allow the EPA to determine whether pre-existing disparities are associated with the pollutant(s) under consideration (*e.g.*, if the effects of the pollutant(s) are more concentrated in some population groups). (2) Is there evidence of potential EJ concerns for the regulatory option(s) under consideration? Specifically, how are the pollutant(s) and its effects distributed for the regulatory options under consideration? And, (3) do the regulatory option(s) under consideration exacerbate or mitigate EJ concerns relative to the baseline? It is not always possible to quantitatively assess these questions.

EPA's 2016 Technical Guidance does not prescribe or recommend a specific approach or methodology for conducting an environmental justice analysis, though a key consideration is consistency with the assumptions underlying other parts of the regulatory analysis when evaluating the baseline and regulatory options. Where applicable and practicable, the Agency endeavors to conduct such an analysis. EPA is committed to conducting environmental justice analysis for rulemakings based on a framework similar to what is outlined in EPA's Technical Guidance, in addition to investigating ways to further weave environmental justice into the fabric of the rulemaking process.

EPA seeks to ensure that no group of people faces a disproportionate burden of exposure to mobile-source pollution. In general, we expect reduced tailpipe

emissions of NO<sub>x</sub> from heavy-duty diesel engines and reduced tailpipe emissions of NO<sub>x</sub>, CO, PM, and VOCs from heavy-duty gasoline engines. See Section VI.B for more detail on the emissions reductions from this proposal.

There is evidence that communities with EJ concerns are disproportionately impacted by the emissions associated with this proposal.<sup>214</sup> Numerous studies have found that environmental hazards such as air pollution are more prevalent in areas where people of color and low-income populations represent a higher fraction of the population compared with the general population.<sup>215 216 217</sup> Consistent with this evidence, a recent study found that most anthropogenic sources of PM<sub>2.5</sub>, including industrial sources and light- and heavy-duty vehicle sources, disproportionately affect people of color.<sup>218</sup> In addition, compared to non-Hispanic Whites, some minorities experience greater levels of health problems during some life stages. For example, in 2017–2019, about 14 percent of Black, non-Hispanic and 8 percent of Hispanic children were estimated to currently have asthma, compared with 6 percent of White, non-Hispanic children.<sup>219</sup>

As discussed in Section II.B.7 of this document, concentrations of many air pollutants are elevated near high-traffic roadways. In addition, numerous state and local commenters on the ANPR noted that truck trips frequently start and end around goods movement facilities including marine ports and warehouses, making consideration of truck emissions an important element of

addressing air quality experienced by populations living near those facilities.<sup>220</sup>

We conducted an analysis of the populations living in close proximity to truck freight routes as identified in USDOT's Freight Analysis Framework 4 (FAF4).<sup>221</sup> FAF4 is a model from the USDOT's Bureau of Transportation Statistics (BTS) and Federal Highway Administration (FHWA), which provides data associated with freight movement in the U.S.<sup>222</sup> Relative to the rest of the population, people living near FAF4 truck routes are more likely to be people of color and have lower incomes than the general population. People living near FAF4 truck routes are also more likely to live in metropolitan areas. Even controlling for region of the country, county characteristics, population density, and household structure, race, ethnicity, and income are significant determinants of whether someone lives near a FAF4 truck route.

We also reviewed existing scholarly literature examining the potential for disproportionate exposure among people of color and people with low socioeconomic status (SES), and we conducted our own evaluation of two national datasets: The U.S. Census Bureau's American Housing Survey for calendar year 2009 and the U.S. Department of Education's database of school locations. Numerous studies evaluating the demographics and socioeconomic status of populations or schools near roadways have found that they include a greater percentage of residents of color, as well as lower SES populations (as indicated by variables such as median household income). Locations in these studies include Los Angeles, CA; Seattle, WA; Wayne County, MI; Orange County, FL; and the

<sup>214</sup> Mohai, P.; Pellow, D.; Roberts Timmons, J. (2009) Environmental justice. *Annual Reviews* 34: 405–430. <https://doi.org/10.1146/annurev-environ-082508-094348>.

<sup>215</sup> Rowangould, G.M. (2013) A census of the near-roadway population: public health and environmental justice considerations. *Trans Res D* 25: 59–67. <http://dx.doi.org/10.1016/j.trd.2013.08.003>.

<sup>216</sup> Marshall, J.D., Swor, K.R.; Nguyen, N.P (2014) Prioritizing environmental justice and equality: diesel emissions in Southern California. *Environ Sci Technol* 48: 4063–4068. <https://doi.org/10.1021/es405167f>.

<sup>217</sup> Marshall, J.D. (2008) Environmental inequality: air pollution exposures in California's South Coast Air Basin. *Atmos Environ* 21: 5499–5503. <https://doi.org/10.1016/j.atmosenv.2008.02.005>.

<sup>218</sup> C. W. Tessum, D. A. Paoletta, S. E. Chambliss, J. S. Apte, J. D. Hill, J. D. Marshall, PM<sub>2.5</sub> pollutants disproportionately and systemically affect people of color in the United States. *Sci. Adv.* 7, eabf4491 (2021).

<sup>219</sup> [http://www.cdc.gov/asthma/most\\_recent\\_data.htm](http://www.cdc.gov/asthma/most_recent_data.htm).

<sup>220</sup> New York State Department of Environmental Conservation (2019) Albany South End Community Air Quality Study. Division of Air Resources. [Online at <https://www.dec.ny.gov/chemical/108978.html>].

<sup>221</sup> U.S. EPA (2021). Estimation of Population Size and Demographic Characteristics among People Living Near Truck Routes in the Conterminous United States. Memorandum to the Docket.

<sup>222</sup> FAF4 includes data from the 2012 Commodity Flow Survey (CFS), the Census Bureau on international trade, as well as data associated with construction, agriculture, utilities, warehouses, and other industries. FAF4 estimates the modal choices for moving goods by trucks, trains, boats, and other types of freight modes. It includes traffic assignments, including truck flows on a network of truck routes. [https://ops.fhwa.dot.gov/freight/freight\\_analysis/faf/](https://ops.fhwa.dot.gov/freight/freight_analysis/faf/).

<sup>213</sup> "Technical Guidance for Assessing Environmental Justice in Regulatory Analysis." Epa.gov, Environmental Protection Agency, [https://www.epa.gov/sites/production/files/2016-06/documents/ejtg\\_5\\_6\\_16\\_v5.1.pdf](https://www.epa.gov/sites/production/files/2016-06/documents/ejtg_5_6_16_v5.1.pdf). (June 2016).

State of California.<sup>223</sup> Such disparities may be due to multiple factors.<sup>229</sup>

People with low SES often live in neighborhoods with multiple stressors and health risk factors, including reduced health insurance coverage rates, higher smoking and drug use rates, limited access to fresh food, visible neighborhood violence, and elevated rates of obesity and some diseases such as asthma, diabetes, and ischemic heart disease. Although questions remain, several studies find stronger associations between air pollution and health in locations with such chronic neighborhood stress, suggesting that populations in these areas may be more susceptible to the effects of air pollution.<sup>230</sup>

Several publications report nationwide analyses that compare the demographic patterns of people who do or do not live near major roadways.<sup>234</sup> Three of

these studies found that people living near major roadways are more likely to be minorities or low in SES.<sup>240</sup> They also found that the outcomes of their analyses varied between regions within the U.S. However, only one such study looked at whether such conclusions were confounded by living in a location with higher population density and how demographics differ between locations nationwide.<sup>243</sup> In general, it found that higher density areas have higher proportions of low-income residents and people of color. In other publications based on a city, county, or state, the results are similar.<sup>244</sup>

We analyzed two national databases that allowed us to evaluate whether homes and schools were located near a

environmental justice considerations. Transportation Research Part D; 59–67.

<sup>235</sup> Tian, N.; Xue, J.; Barzyk, T.M. (2013) Evaluating socioeconomic and racial differences in traffic-related metrics in the United States using a GIS approach. *J Exposure Sci Environ Epidemiol* 23: 215–222.

<sup>236</sup> CDC (2013) Residential proximity to major highways—United States, 2010. *Morbidity and Mortality Weekly Report* 62(3): 46–50.

<sup>237</sup> Clark, L.P.; Millet, D.B.; Marshall, J.D. (2017) Changes in transportation-related air pollution exposures by race-ethnicity and socioeconomic status: Outdoor nitrogen dioxide in the United States in 2000 and 2010. *Environ Health Perspect* <https://doi.org/10.1289/EHP959>.

<sup>238</sup> Mikati, I.; Benson, A.F.; Luben, T.J.; Sacks, J.D.; Richmond-Bryant, J. (2018) Disparities in distribution of particulate matter emission sources by race and poverty status. *Am J Pub Health* <https://ajph.aphapublications.org/doi/abs/10.2105/AJPH.2017.304297?journalCode=ajph>.

<sup>239</sup> Alotaibi, R.; Bechle, M.; Marshall, J.D.; Ramani, T.; Zietsman, J.; Nieuwenhuijsen, M.J.; Khreis, H. (2019) Traffic related air pollution and the burden of childhood asthma in the continuous United States in 2000 and 2010. *Environ International* 127: 858–867. <https://www.sciencedirect.com/science/article/pii/S0160412018325388>.

<sup>240</sup> Tian, N.; Xue, J.; Barzyk, T.M. (2013) Evaluating socioeconomic and racial differences in traffic-related metrics in the United States using a GIS approach. *J Exposure Sci Environ Epidemiol* 23: 215–222.

<sup>241</sup> Rowangould, G.M. (2013) A census of the U.S. near-roadway population: Public health and environmental justice considerations. Transportation Research Part D; 59–67.

<sup>242</sup> CDC (2013) Residential proximity to major highways—United States, 2010. *Morbidity and Mortality Weekly Report* 62(3): 46–50.

<sup>243</sup> Rowangould, G.M. (2013) A census of the U.S. near-roadway population: Public health and environmental justice considerations. Transportation Research Part D; 59–67.

<sup>244</sup> Pratt, G.C.; Vadali, M.L.; Kvale, D.L.; Ellickson, K.M. (2015) Traffic, air pollution, minority, and socio-economic status: Addressing inequities in exposure and risk. *Int J Environ Res Public Health* 12: 5355–5372. <http://dx.doi.org/10.3390/ijerph120505355>.

<sup>245</sup> Sohrobi, S.; Zietsman, J.; Khreis, H. (2020) Burden of disease assessment of ambient air pollution and premature mortality in urban areas: The role of socioeconomic status and transportation. *Int J Env Res Public Health* doi:10.3390/ijerph17041166.

major road and whether disparities in exposure may be occurring in these environments. The American Housing Survey (AHS) includes descriptive statistics of over 70,000 housing units across the nation. The survey is conducted every two years by the U.S. Census Bureau.<sup>246</sup> The second database we analyzed was the U.S. Department of Education's Common Core of Data, which includes enrollment and location information for schools across the U.S.<sup>247</sup>

In analyzing the 2009 AHS, we focused on whether a housing unit was located within 300 feet, the distance provided in the AHS data, of a “4-or-more lane highway, railroad, or airport.”<sup>248</sup> We analyzed whether there were differences between households in such locations compared with those in locations farther from these transportation facilities.<sup>249</sup> We included other variables, such as land use category, region of country, and housing type. We found that homes with a non-White householder were 22–34 percent more likely to be located within 300 feet of these large transportation facilities than homes with White householders. Homes with a Hispanic householder were 17–33 percent more likely to be located within 300 feet of these large transportation facilities than homes with non-Hispanic householders. Households near large transportation facilities were, on average, lower in income and educational attainment and more likely to be a rental property and located in an urban area compared with households more distant from transportation facilities.

In examining schools near major roadways, we examined the Common Core of Data (CCD) from the U.S. Department of Education, which includes information on all public elementary and secondary schools and school districts nationwide.<sup>250</sup> To determine school proximities to major

<sup>246</sup> U.S. Department of Housing and Urban Development, & U.S. Census Bureau. (n.d.). Age of other residential buildings within 300 feet. In American Housing Survey for the United States: 2009 (pp. A–1). Retrieved from <https://www.census.gov/programs-surveys/ahs/data/2009/ahs-2009-summary-tables0/h150-09.html>.

<sup>247</sup> <http://nces.ed.gov/ccd/>.

<sup>248</sup> This variable primarily represents roadway proximity. According to the Central Intelligence Agency's World Factbook, in 2010, the United States had 6,506,204 km of roadways, 224,792 km of railways, and 15,079 airports. Highways thus represent the overwhelming majority of transportation facilities described by this factor in the AHS.

<sup>249</sup> Bailey, C. (2011) Demographic and Social Patterns in Housing Units Near Large Highways and other Transportation Sources. Memorandum to docket.

<sup>250</sup> <http://nces.ed.gov/ccd/>.

<sup>223</sup> Marshall, J.D. (2008) Environmental inequality: Air pollution exposures in California's South Coast Air Basin.

<sup>224</sup> Su, J.G.; Larson, T.; Gould, T.; Cohen, M.; Buzzelli, M. (2010) Transboundary air pollution and environmental justice: Vancouver and Seattle compared. *GeoJournal* 57: 595–608. doi:10.1007/s10708-009-9269-6

<sup>225</sup> Chakraborty, J.; Zandbergen, P.A. (2007) Children at risk: Measuring racial/ethnic disparities in potential exposure to air pollution at school and home. *J Epidemiol Community Health* 61: 1074–1079. doi:10.1136/jech.2006.054130

<sup>226</sup> Green, R.S.; Smorodinsky, S.; Kim, J.J.; McLaughlin, R.; Ostro, B. (2004) Proximity of California public schools to busy roads. *Environ Health Perspect* 112: 61–66. doi:10.1289/ehp.6566

<sup>227</sup> Wu, Y.; Batterman, S.A. (2006) Proximity of schools in Detroit, Michigan to automobile and truck traffic. *J Exposure Sci & Environ Epidemiol*. doi:10.1038/sj.jes.7500484

<sup>228</sup> Su, J.G.; Jerrett, M.; de Nazelle, A.; Wolch, J. (2011) Does exposure to air pollution in urban parks have socioeconomic, racial, or ethnic gradients? *Environ Res* 111: 319–328.

<sup>229</sup> Depro, B.; Timmins, C. (2008) Mobility and environmental equity: Do housing choices determine exposure to air pollution? Duke University Working Paper.

<sup>230</sup> Clougherty, J.E.; Kubzansky, L.D. (2009) A framework for examining social stress and susceptibility to air pollution in respiratory health. *Environ Health Perspect* 117: 1351–1358. Doi:10.1289/ehp.0900612

<sup>231</sup> Clougherty, J.E.; Levy, J.I.; Kubzansky, L.D.; Ryan, P.B.; Franco Suglia, S.; Jacobson Canner, M.; Wright, R.J. (2007) Synergistic effects of traffic-related air pollution and exposure to violence on urban asthma etiology. *Environ Health Perspect* 115: 1140–1146. doi:10.1289/ehp.9863

<sup>232</sup> Finkelstein, M.M.; Jerrett, M.; DeLuca, P.; Finkelstein, N.; Verma, D.K.; Chapman, K.; Sears, M.R. (2003) Relation between income, air pollution and mortality: A cohort study. *Canadian Med Assn J* 169: 397–402.

<sup>233</sup> Shankardass, K.; McConnell, R.; Jerrett, M.; Milam, J.; Richardson, J.; Berhane, K. (2009) Parental stress increases the effect of traffic-related air pollution on childhood asthma incidence. *Proc Natl Acad Sci* 106: 12406–12411. doi:10.1073/pnas.0812910106

<sup>234</sup> Rowangould, G.M. (2013) A census of the U.S. near-roadway population: Public health and



roadways, we used a geographic information system (GIS) to map each school and roadways based on the U.S. Census's TIGER roadway file.<sup>251</sup> We found that students of color were overrepresented at schools within 200 meters of the largest roadways, and schools within 200 meters of the largest roadways had higher than expected numbers of students eligible for free or reduced-price lunches.<sup>252</sup> For example, Black students represent 22 percent of students at schools located within 200 meters of a primary road, compared to 17 percent of students in all U.S. schools. Hispanic students represent 30 percent of students at schools located within 200 meters of a primary road, compared to 22 percent of students in all U.S. schools.

Overall, there is substantial evidence that people who live or attend school near major roadways are more likely to be of a non-White race, Hispanic, and/or have a low SES. Although proximity to an emissions source is an indicator of potential exposure, it is important to note that the impacts of emissions from tailpipe sources are not limited to communities in close proximity to these sources. For example, the effects of potential decreases in emissions from sources that would be affected by this proposal might also be felt many miles away, including in communities with EJ concerns. The spatial extent of these impacts depends on a range of interacting and complex factors including the amount of pollutant emitted, atmospheric lifetime of the pollutant, terrain, atmospheric chemistry and meteorology.

We also conducted an analysis of how the air quality impacts from this proposed rule would be distributed among different populations, specifically focusing on PM<sub>2.5</sub> and ozone concentrations in the contiguous U.S. This analysis assessed whether areas with the worst projected baseline air quality in 2045 have larger numbers of people of color living in them, and if those with the worst projected air quality would benefit more from the proposed rule. We found that in the 2045 baseline, nearly double the number of people of color live within areas with the worst air quality, compared to non-Hispanic Whites (NH-

Whites). We also found that the largest improvements in both ozone and PM<sub>2.5</sub> are estimated to occur in these areas with the worst baseline air quality. See Section VII.H for additional information on the demographic analysis.

In summary, we expect this proposed rule would result in reductions of emissions that contribute to ozone, PM<sub>2.5</sub>, and other harmful pollution. The emission reductions from this proposed rule would result in widespread air quality improvements, including in the areas with the worst baseline air quality, where a larger number of people of color are projected to reside.

#### *C. Environmental Effects Associated With Exposure to Pollutants Impacted by This Proposal*

This section discusses the environmental effects associated with pollutants affected by this proposed rule, specifically particulate matter, ozone, NO<sub>x</sub> and air toxics.

##### 1. Visibility

Visibility can be defined as the degree to which the atmosphere is transparent to visible light.<sup>253</sup> Visibility impairment is caused by light scattering and absorption by suspended particles and gases. It is dominated by contributions from suspended particles except under pristine conditions. Visibility is important because it has direct significance to people's enjoyment of daily activities in all parts of the country. Individuals value good visibility for the well-being it provides them directly, where they live and work, and in places where they enjoy recreational opportunities. Visibility is also highly valued in significant natural areas, such as national parks and wilderness areas, and special emphasis is given to protecting visibility in these areas. For more information on visibility see the final 2019 PM ISA.<sup>254</sup>

EPA is working to address visibility impairment. Reductions in air pollution from implementation of various programs associated with the Clean Air Act Amendments of 1990 provisions have resulted in substantial improvements in visibility and will continue to do so in the future. Because trends in haze are closely associated

with trends in particulate sulfate and nitrate due to the relationship between their concentration and light extinction, visibility trends have improved as emissions of SO<sub>2</sub> and NO<sub>x</sub> have decreased over time due to air pollution regulations such as the Acid Rain Program.<sup>255</sup>

In the Clean Air Act Amendments of 1977, Congress recognized visibility's value to society by establishing a national goal to protect national parks and wilderness areas from visibility impairment caused by manmade pollution.<sup>256</sup> In 1999, EPA finalized the regional haze program to protect the visibility in Mandatory Class I Federal areas.<sup>257</sup> There are 156 national parks, forests and wilderness areas categorized as Mandatory Class I Federal areas.<sup>258</sup> These areas are defined in CAA section 162 as those national parks exceeding 6,000 acres, wilderness areas and memorial parks exceeding 5,000 acres, and all international parks which were in existence on August 7, 1977.

EPA has also concluded that PM<sub>2.5</sub> causes adverse effects on visibility in other areas that are not targeted by the Regional Haze Rule, such as urban areas, depending on PM<sub>2.5</sub> concentrations and other factors such as dry chemical composition and relative humidity (*i.e.*, an indicator of the water composition of the particles). EPA revised the PM<sub>2.5</sub> NAAQS in 2012, retained it in 2020, and established a target level of protection that is expected to be met through attainment of the existing secondary standards for PM<sub>2.5</sub>.<sup>259</sup>

##### 2. Plant and Ecosystem Effects of Ozone

The welfare effects of ozone include effects on ecosystems, which can be observed across a variety of scales, *i.e.*, subcellular, cellular, leaf, whole plant, population and ecosystem. Ozone effects that begin at small spatial scales, such as the leaf of an individual plant, when they occur at sufficient magnitudes (or to a sufficient degree) can result in effects being propagated along a continuum to higher and higher levels of biological organization. For example, effects at the individual plant level, such as altered rates of leaf gas exchange, growth and reproduction,

<sup>251</sup> Pedde, M.; Bailey, C. (2011) Identification of Schools within 200 Meters of U.S. Primary and Secondary Roads. Memorandum to the docket.

<sup>252</sup> For this analysis we analyzed a 200-meter distance based on the understanding that roadways generally influence air quality within a few hundred meters from the vicinity of heavily traveled roadways or along corridors with significant trucking traffic. See U.S. EPA, 2014. Near Roadway Air Pollution and Health: Frequently Asked Questions. EPA-420-F-14-044.

<sup>253</sup> National Research Council, (1993). Protecting Visibility in National Parks and Wilderness Areas. National Academy of Sciences Committee on Haze in National Parks and Wilderness Areas. National Academy Press, Washington, DC. This book can be viewed on the National Academy Press website at <https://www.nap.edu/catalog/2097/protecting-visibility-in-national-parks-and-wilderness-areas>.

<sup>254</sup> U.S. EPA. Integrated Science Assessment (ISA) for Particulate Matter (Final Report, 2019). U.S. Environmental Protection Agency, Washington, DC, EPA/600/R-19/188, 2019.

<sup>255</sup> U.S. EPA. Integrated Science Assessment (ISA) for Particulate Matter (Final Report, 2019). U.S. Environmental Protection Agency, Washington, DC, EPA/600/R-19/188, 2019.

<sup>256</sup> See Section 169(a) of the Clean Air Act.

<sup>257</sup> 64 FR 35714, July 1, 1999.

<sup>258</sup> 62 FR 38680-38681, July 18, 1997.

<sup>259</sup> On June 10, 2021, EPA announced that it will reconsider the previous administration's decision to retain the PM NAAQS. <https://www.epa.gov/pm-pollution/national-ambient-air-quality-standards-naaqs-pm>.

can, when widespread, result in broad changes in ecosystems, such as productivity, carbon storage, water cycling, nutrient cycling, and community composition.

Ozone can produce both acute and chronic injury in sensitive plant species depending on the concentration level and the duration of the exposure.<sup>260</sup> In those sensitive species,<sup>261</sup> effects from repeated exposure to ozone throughout the growing season of the plant can tend to accumulate, so that even relatively low concentrations experienced for a longer duration have the potential to create chronic stress on vegetation.<sup>262</sup> Ozone damage to sensitive plant species includes impaired photosynthesis and visible injury to leaves. The impairment of photosynthesis, the process by which the plant makes carbohydrates (its source of energy and food), can lead to reduced crop yields, timber production, and plant productivity and growth. Impaired photosynthesis can also lead to a reduction in root growth and carbohydrate storage below ground, resulting in other, more subtle plant and ecosystems impacts.<sup>264</sup> These latter impacts include increased susceptibility of plants to insect attack, disease, harsh weather, interspecies competition and overall decreased plant vigor. The adverse effects of ozone on areas with sensitive species could potentially lead to species shifts and loss from the affected ecosystems,<sup>265</sup> resulting in a loss or reduction in associated ecosystem goods and services. Additionally, visible ozone injury to leaves can result in a loss of aesthetic value in areas of special scenic significance like national parks and wilderness areas and reduced use of sensitive ornamentals in landscaping.<sup>266</sup> In addition to ozone effects on vegetation, newer evidence suggests that ozone affects interactions between plants and insects by altering chemical

signals (e.g., floral scents) that plants use to communicate to other community members, such as attraction of pollinators.

The Ozone ISA presents more detailed information on how ozone affects vegetation and ecosystems.<sup>267</sup> The Ozone ISA reports causal and likely causal relationships between ozone exposure and a number of welfare effects and characterizes the weight of evidence for different effects associated with ozone.<sup>269</sup> The ISA concludes that visible foliar injury effects on vegetation, reduced vegetation growth, reduced plant reproduction, reduced productivity in terrestrial ecosystems, reduced yield and quality of agricultural crops, alteration of below-ground biogeochemical cycles, and altered terrestrial community composition are causally associated with exposure to ozone. It also concludes that increased tree mortality, altered herbivore growth and reproduction, altered plant-insect signaling, reduced carbon sequestration in terrestrial ecosystems, and alteration of terrestrial ecosystem water cycling are likely to be causally associated with exposure to ozone.

### 3. Atmospheric Deposition

The Integrated Science Assessment for Oxides of Nitrogen, Oxides of Sulfur, and Particulate Matter—Ecological Criteria documents the ecological effects of the deposition of these criteria air pollutants.<sup>270</sup> It is clear from the body of evidence that oxides of nitrogen, oxides of sulfur, and particulate matter contribute to total nitrogen (N) and sulfur (S) deposition. In turn, N and S deposition cause either nutrient enrichment or acidification depending on the sensitivity of the landscape or the species in question. Both enrichment and acidification are characterized by an alteration of the biogeochemistry and the physiology of organisms, resulting in harmful declines in biodiversity in

terrestrial, freshwater, wetland, and estuarine ecosystems in the U.S. Decreases in biodiversity mean that some species become relatively less abundant and may be locally extirpated. In addition to the loss of unique living species, the decline in total biodiversity can be harmful because biodiversity is an important determinant of the stability of ecosystems and their ability to provide socially valuable ecosystem services.

Terrestrial, wetland, freshwater, and estuarine ecosystems in the U.S. are affected by N enrichment/eutrophication caused by N deposition. These effects have been consistently documented across the U.S. for hundreds of species. In aquatic systems increased nitrogen can alter species assemblages and cause eutrophication. In terrestrial systems nitrogen loading can lead to loss of nitrogen-sensitive lichen species, decreased biodiversity of grasslands, meadows and other sensitive habitats, and increased potential for invasive species. For a broader explanation of the topics treated here, refer to the description in Chapter 4 of the draft RIA.

The sensitivity of terrestrial and aquatic ecosystems to acidification from nitrogen and sulfur deposition is predominantly governed by geology. Prolonged exposure to excess nitrogen and sulfur deposition in sensitive areas acidifies lakes, rivers, and soils. Increased acidity in surface waters creates inhospitable conditions for biota and affects the abundance and biodiversity of fishes, zooplankton and macroinvertebrates and ecosystem function. Over time, acidifying deposition also removes essential nutrients from forest soils, depleting the capacity of soils to neutralize future acid loadings and negatively affecting forest sustainability. Major effects in forests include a decline in sensitive tree species, such as red spruce (*Picea rubens*) and sugar maple (*Acer saccharum*).

Building materials including metals, stones, cements, and paints undergo natural weathering processes from exposure to environmental elements (e.g., wind, moisture, temperature fluctuations, sunlight, etc.). Pollution can worsen and accelerate these effects. Deposition of PM is associated with both physical damage (materials damage effects) and impaired aesthetic qualities (soiling effects). Wet and dry deposition of PM can physically affect materials, adding to the effects of natural weathering processes, by potentially promoting or accelerating the corrosion of metals, by degrading paints and by deteriorating building materials such as

<sup>260</sup> 73 FR 16486, March 27, 2008.

<sup>261</sup> 73 FR 16491, March 27, 2008. Only a small percentage of all the plant species growing within the U.S. (over 43,000 species have been catalogued in the USDA PLANTS database) have been studied with respect to ozone sensitivity.

<sup>262</sup> U.S. EPA. Integrated Science Assessment (ISA) for Ozone and Related Photochemical Oxidants (Final Report). U.S. Environmental Protection Agency, Washington, DC, EPA/600/R-20/012, 2020.

<sup>263</sup> The concentration at which ozone levels overwhelm a plant's ability to detoxify or compensate for oxidant exposure varies. Thus, whether a plant is classified as sensitive or tolerant depends in part on the exposure levels being considered.

<sup>264</sup> 73 FR 16492, March 27, 2008.

<sup>265</sup> 73 FR 16493–16494, March 27, 2008. Ozone impacts could be occurring in areas where plant species sensitive to ozone have not yet been studied or identified.

<sup>266</sup> 73 FR 16490–16497, March 27, 2008.

<sup>267</sup> U.S. EPA. Integrated Science Assessment (ISA) for Ozone and Related Photochemical Oxidants (Final Report). U.S. Environmental Protection Agency, Washington, DC, EPA/600/R-20/012, 2020.

<sup>268</sup> U.S. EPA. Integrated Science Assessment (ISA) for Ozone and Related Photochemical Oxidants (Final Report). U.S. Environmental Protection Agency, Washington, DC, EPA/600/R-20/012, 2020.

<sup>269</sup> The Ozone ISA evaluates the evidence associated with different ozone related health and welfare effects, assigning one of five “weight of evidence” determinations: Causal relationship, likely to be a causal relationship, suggestive of a causal relationship, inadequate to infer a causal relationship, and not likely to be a causal relationship. For more information on these levels of evidence, please refer to Table II of the ISA.

<sup>270</sup> U.S. EPA. Integrated Science Assessment (ISA) for Oxides of Nitrogen, Oxides of Sulfur and Particulate Matter Ecological Criteria (Final Report). U.S. Environmental Protection Agency, Washington, DC, EPA/600/R-20/278, 2020.

stone, concrete and marble.<sup>271</sup> The effects of PM are exacerbated by the presence of acidic gases and can be additive or synergistic due to the complex mixture of pollutants in the air and surface characteristics of the material. Acidic deposition has been shown to have an effect on materials including zinc/galvanized steel and other metal, carbonate stone (as monuments and building facings), and surface coatings (paints).<sup>272</sup> The effects on historic buildings and outdoor works of art are of particular concern because of the uniqueness and irreplaceability of many of these objects. In addition to aesthetic and functional effects on metals, stone and glass, altered energy efficiency of photovoltaic panels by PM deposition is also becoming an important consideration for impacts of air pollutants on materials.

#### 4. Environmental Effects of Air Toxics

Emissions from producing, transporting and combusting fuel contribute to ambient levels of pollutants that contribute to adverse effects on vegetation. Volatile organic compounds (VOCs), some of which are considered air toxics, have long been suspected to play a role in vegetation damage.<sup>273</sup> In laboratory experiments, a wide range of tolerance to VOCs has been observed.<sup>274</sup> Decreases in harvested seed pod weight have been reported for the more sensitive plants, and some studies have reported effects on seed germination, flowering and fruit ripening. Effects of individual VOCs or their role in conjunction with other stressors (e.g., acidification, drought, temperature extremes) have not been well studied. In a recent study of a mixture of VOCs including ethanol and toluene on herbaceous plants, significant effects on seed production, leaf water content and photosynthetic efficiency were reported for some plant species.<sup>275</sup>

<sup>271</sup> U.S. EPA. Integrated Science Assessment (ISA) for Particulate Matter (Final Report, 2019). U.S. Environmental Protection Agency, Washington, DC, EPA/600/R-19/188, 2019.

<sup>272</sup> Irving, P.M., e.d. 1991. Acid Deposition: State of Science and Technology, Volume III, Terrestrial, Materials, Health, and Visibility Effects, The U.S. National Acid Precipitation Assessment Program, Chapter 24, page 24-76.

<sup>273</sup> U.S. EPA. (1991). Effects of organic chemicals in the atmosphere on terrestrial plants. EPA/600/3-91/001.

<sup>274</sup> Cape JN, ID Leith, J Binnie, J Content, M Donkin, M Skewes, DN Price AR Brown, AD Sharpe. (2003). Effects of VOCs on herbaceous plants in an open-top chamber experiment. Environ. Pollut. 124:341-343.

<sup>275</sup> Cape JN, ID Leith, J Binnie, J Content, M Donkin, M Skewes, DN Price AR Brown, AD Sharpe. (2003). Effects of VOCs on herbaceous plants in an open-top chamber experiment. Environ. Pollut. 124:341-343.

Research suggests an adverse impact of vehicle exhaust on plants, which has in some cases been attributed to aromatic compounds and in other cases to nitrogen oxides.<sup>276 277 278</sup> The impacts of VOCs on plant reproduction may have long-term implications for biodiversity and survival of native species near major roadways. Most of the studies of the impacts of VOCs on vegetation have focused on short-term exposure and few studies have focused on long-term effects of VOCs on vegetation and the potential for metabolites of these compounds to affect herbivores or insects.

### III. Proposed Test Procedures and Standards

In applying heavy-duty criteria pollutant emission standards, EPA divides engines primarily into two types: Compression ignition (CI) (primarily diesel-fueled engines) and spark-ignition (SI) (primarily gasoline-fueled engines). The CI standards and requirements also apply to the largest natural gas engines. Battery-electric and fuel-cell vehicles are also subject to criteria pollutant standards and requirements. All heavy-duty highway engines are subject to brake-specific (g/hp-hr) exhaust emission standards for four criteria pollutants: Oxides of nitrogen (NO<sub>x</sub>), particulate matter (PM), hydrocarbons (HC), and carbon monoxide (CO).<sup>279</sup> In this section we describe two regulatory options for new emissions standards: Proposed Option 1 and proposed Option 2 and updates we are proposing to the test procedures that apply for these pollutants. Unless explicitly stated otherwise, the proposed provisions in this section and Section IV would apply to proposed Options 1 and 2, as well as the full range of options in between them.<sup>280</sup>

<sup>276</sup> Viskari E.-L. (2000). Epicuticular wax of Norway spruce needles as indicator of traffic pollutant deposition. Water, Air, and Soil Pollut. 121:327-337.

<sup>277</sup> Ugrekheldidze D, F Korte, G Kvesitadze. (1997). Uptake and transformation of benzene and toluene by plant leaves. Ecotox. Environ. Safety 37:24-29.

<sup>278</sup> Kammerbauer H, H Selinger, R Rommelt, A Ziegler-Jons, D Knoppik, B Hock. (1987). Toxic components of motor vehicle emissions for the spruce *Picea abies*. Environ. Pollut. 48:235-243.

<sup>279</sup> Reference to hydrocarbon (HC) standards includes nonmethane hydrocarbon (NMHC), nonmethane-nonethane hydrocarbon (NMNEHC) and nonmethane hydrocarbon equivalent (NMHCE). See 40 CFR 86.007-11.

<sup>280</sup> As detailed throughout Sections III and IV, we provide proposed regulatory text for the proposed Option 1. We expect that the proposed Option 2 regulatory text would be the same as text for the proposed Option 1 except for the number of steps and numeric values of the criteria pollutant standards and lengths of useful life and warranty periods.

#### A. Overview

In the following section, we provide an overview of our proposal to migrate and update our criteria pollutant regulations for model year 2027 and later heavy-duty highway engines, our proposed Options 1 and 2 standards and test procedures, and our analysis demonstrating the feasibility of the proposed standards. The sections that follow provide more detail on each of these topics. Section III.B and Section III.D include the proposed changes to our laboratory-based standards and test procedures for heavy-duty compression-ignition and spark-ignition engines, respectively. Section III.C introduces our proposed off-cycle standards and test procedures that extend beyond the laboratory to on-the-road, real-world conditions. Section III.E describes our proposal for new refueling standards for certain heavy-duty spark-ignition engines. Each of these sections include descriptions of the current standards and test procedures and our proposed updates, including our feasibility demonstrations and the data we relied on to support our proposals.

##### 1. Migration and Clarifications of Regulatory Text

As noted in Section I of this preamble, we are proposing to migrate our criteria pollutant regulations for model year 2027 and later heavy-duty highway engines from their current location in 40 CFR part 86, subpart A, to 40 CFR part 1036.<sup>281</sup> Consistent with this migration, the proposed compliance provisions discussed in this section refer to the proposed regulations in their new location in part 1036. In general, this migration is not intended to change the compliance program previously specified in part 86, except as specifically proposed in this rulemaking. See our memorandum to the docket for a detailed description of the proposed migration.<sup>282</sup> The proposal includes updating cross references to 40 CFR parts 86 and 1036 in several places to properly cite the new rulemaking provisions in this rule.

##### i. Compression- and Spark-Ignition Engines Regulatory Text

For many years, the regulations of 40 CFR part 86 have referred to “diesel

<sup>281</sup> As noted in the following sections, we are proposing some updates to 40 CFR parts 1037, 1065, and 1068 to apply to other sectors in addition to heavy-duty highway engines.

<sup>282</sup> Stout, Alan; Brakora, Jessica. Memorandum to docket EPA-HQ-OAR-2019-0055. “Technical Issues Related to Migrating Heavy-Duty Highway Engine Certification Requirements from 40 CFR part 86, subpart A, to 40 CFR part 1036”. October 1, 2021.

heavy-duty engines” and “Otto-cycle heavy-duty engines”; however, as we migrate the heavy-duty provisions of 40 CFR part 86, subpart A, to 40 CFR part 1036 in this proposal, we refer to these engines as “compression-ignition” (CI) and “spark-ignition” (SI), respectively, which are more comprehensive terms and consistent with existing language in 40 CFR part 1037 for heavy-duty motor vehicle regulations. In this section, and throughout the preamble, reference to diesel and Otto-cycle engines is generally limited to discussions relating to current test procedures and specific terminology used in 40 CFR part 86. We are also proposing to update the terminology for the primary intended service classes in 40 CFR 1036.140 to replace Heavy heavy-duty engine with Heavy HDE, Medium heavy-duty engine with Medium HDE, Light heavy-duty engine with Light HDE, and Spark-ignition heavy-duty engine with Spark-ignition HDE.<sup>283</sup> Our proposal includes revisions throughout 40 CFR parts 1036 and 1037 to reflect this updated terminology.

#### ii. Heavy-Duty Hybrid Regulatory Text

Similar to our updates to more comprehensive and consistent terminology for CI and SI engines, as part of this proposal we are also updating and clarifying regulatory language for hybrid engines and hybrid powertrains. We propose to update the definition of “engine configuration” in 40 CFR 1036.801 to clarify that an engine configuration would include hybrid components if it is certified as a hybrid engine or hybrid powertrain. We are proposing first to clarify in 40 CFR 1036.101(b) that regulatory references in part 1036 to engines generally apply to hybrid engines and hybrid powertrains. We are also proposing to clarify in 40 CFR 1036.101(b) that manufacturers may optionally test the hybrid engine and powertrain together, rather than testing the engine alone; this option would allow manufacturers to demonstrate emission performance of the hybrid technology that are not apparent when testing the engine alone.

To certify a hybrid engine or hybrid powertrain to criteria pollutant standards, we propose that manufacturers would declare a primary intended service class of the engine configuration using the proposed updated 40 CFR 1036.140. The current provisions of 40 CFR 1036.140 distinguish classes based on engine characteristics and characteristics of the

vehicles for which manufacturers intend to design and market their engines. Under this proposal, manufacturers certifying hybrid engines and hybrid powertrains would use good engineering judgment to identify the class that best describes their engine configuration.<sup>284</sup> Once a primary intended service class is declared, the engine configuration would be subject to all the criteria pollutant emission standards and related compliance provisions for that class.

We propose to update 40 CFR 1036.230(c) to include hybrid powertrains and are proposing that engine configurations certified as hybrid engine or hybrid powertrain may not be included in an engine family with conventional engines, consistent with the current provisions. We note that this provision would result in more engine families for manufacturers certifying hybrids. We request comment on our proposed clarification in 40 CFR 1036.101(b) that manufacturers may optionally test the hybrid engine and powertrain together, rather than testing the engine alone. Specifically, we are interested in stakeholder input on whether EPA should require all hybrid engines and powertrains to be certified together, rather than making it optional. We are interested in commenters’ views on the impact of additional engine/powertrain families if we were to require powertrain testing for all hybrid engine and powertrain engine configurations, including a manufacturers’ ability to conduct certification testing and any recommended steps EPA should take to address such effects. We are also interested in commenters’ views on whether the powertrain test always provides test results that are more representative of hybrid emission performance in the real world, or if for some hybrid systems the engine test procedure provides equally or more representative results. For instance, we solicit comment on whether for some hybrids, such as mild-hybrids, the powertrain test should continue to be an option, even if we were to require that all other hybrids must use the powertrain test.

We are also interested in stakeholder input on potential alternative approaches, such as if EPA were to add new, separate service classes for hybrid engines and powertrains in the final rule. Distinct service classes for hybrid engines and powertrains could allow

EPA to consider separate emission standards, useful life, and/or test procedures for hybrids based on unique performance attributes; however, it could also add burden to EPA and manufacturers by creating additional categories to track and maintain. We request that commenters suggesting separate primary intended service classes for hybrid engines and powertrains include data, if possible, to support an analysis of appropriate corresponding emission standards, useful life periods, and other compliance requirements.

#### iii. Heavy-Duty Electric Vehicles Regulatory Text

Similar to our updates to more comprehensive and consistent terminology, as part of this proposal we are also updating and consolidating regulatory language for battery-electric vehicles and fuel cell electric vehicles (BEVs and FCEVs). For BEVs and FCEVs, we are proposing to consolidate and update our regulations as part of a migration of heavy-duty vehicle regulations from 40 CFR part 86 to 40 CFR part 1037. In the GHG Phase 1 rulemaking, EPA revised the heavy-duty vehicle and engine regulations to make them consistent with our regulatory approach to electric vehicles (EVs) under the light-duty vehicle program. Specifically, we applied standards for all regulated criteria pollutants and GHGs to all heavy-duty vehicle types, including EVs.<sup>285</sup> Starting in MY 2016, criteria pollutant standards and requirements applicable to heavy-duty vehicles at or below 14,000 pounds GVWR in 40 CFR part 86, subpart S, applied to heavy-duty EVs above 14,000 pounds GVWR through the use of good engineering judgment (see current 40 CFR 86.016–1(d)(4)). Under the current 40 CFR 86.016–1(d)(4), heavy-duty vehicles powered solely by electricity are deemed to have zero emissions of regulated pollutants; this provision also provides that heavy-duty EVs may not generate NO<sub>x</sub> or PM emission credits. Additionally, part 1037 applies to heavy-duty EVs above 14,000 pounds GVWR (see current 40 CFR 1037.1).

In this rulemaking, we are proposing to consolidate certification requirements for BEVs and FCEVs over 14,000 pounds GVWR in 40 CFR part 1037 such that manufacturers of BEVs and FCEVs over 14,000 pounds GVWR would certify to meeting the emission standards and requirements of part 1037, as provided

<sup>283</sup> This proposed terminology for engines is also consistent with the “HDV” terminology used for vehicle classifications in 40 CFR 1037.140.

<sup>284</sup> For example, an engine configuration that includes an SI engine and hybrid powertrain intended for a Class 4 vehicle would certify to the proposed Spark-ignition HDE provisions.

<sup>285</sup> 76 FR 57106, September 15, 2011.

in the current 40 CFR 1037.1.<sup>286</sup> In the proposed 40 CFR 1037.102(b), we clarify that BEVs and FCEVs are subject to criteria pollutant standards as follows: Prior to MY 2027, the emission standards under the current 40 CFR 86.007–11 would apply, while the emission standards under the proposed 40 CFR 1036.104 would apply starting in MY 2027. As specified in the proposed 40 CFR 1037.205(q), starting in MY 2027, BEV and FCEV manufacturers could choose to attest that vehicles comply with the standards of 40 CFR 1037.102 instead of submitting test data.<sup>287</sup> As discussed in Section IV.I, we are proposing in 40 CFR 1037.616 that, starting in MY 2024, manufacturers may choose to generate NO<sub>x</sub> emission credits from BEVs and FCEVs if the vehicle meets durability requirements described in proposed 40 CFR 1037.102(b)(3).<sup>288</sup> Manufacturers choosing to generate NO<sub>x</sub> emission credits under proposed 40 CFR 1037.616 may attest to meeting durability requirements while also submitting test results required for calculating NO<sub>x</sub> emission credits and quantifying initial battery or fuel cell performance.<sup>289</sup> <sup>290</sup> We are proposing to continue to not to allow heavy-duty EVs to generate PM emission credits since we are proposing not to allow any manufacturer to generate PM emission credits for use in MY 2027 and later under the proposed averaging, banking, and trading program presented in Section IV.G.

<sup>286</sup> Manufacturers of battery-electric and fuel cell electric vehicles at or below 14,000 pounds GVWR would continue complying with the standards and requirements in CFR 40 part 86, subpart S, instead of the requirements in 40 CFR 1037.

<sup>287</sup> Prior to MY 2027, BEVs or FCEVs that are not used to generate NO<sub>x</sub> emission credits would continue to be deemed to have zero tailpipe emissions of criteria pollutants, as specified in current 40 CFR 86.016–1(d)(4). See Section IV.I and the proposed 40 CFR 1037.205(q)(2) for information relevant to manufacturers choosing to generate NO<sub>x</sub> emission credits from BEVs and FCEVs starting in MY 2024.

<sup>288</sup> Our proposal for how manufacturers could generate NO<sub>x</sub> emissions credits from BEVs and FCEVs would be available under any of the regulatory options that we are considering for revised NO<sub>x</sub> standards (see Section IV.I for details and requests for comments on this topic).

<sup>289</sup> As provided in the current 40 CFR 1037.150(f), no CO<sub>2</sub>-related emission testing is required for electric vehicles and manufacturers would continue to use good engineering judgment to apply other requirements of 40 CFR 1037.

<sup>290</sup> See the proposed 40 CFR 1037.205(q) for information required in a certification application for BEVs or FCEVs; Section III.B.2.v.c includes additional discussion on proposed test procedures for BEVs and FCEVs, with details included in 40 CFR 1037.552 or 40 CFR 1037.554 for BEVs or FCEVs, respectively.

## 2. Proposed Numeric Standards and Test Procedures for Compression-Ignition and Spark-Ignition Engines

EPA is proposing new NO<sub>x</sub>, PM, HC, and CO emission standards for heavy-duty engines that will be certified under 40 CFR part 1036.<sup>291</sup> <sup>292</sup> As noted in the introduction to this preamble, the highway heavy-duty vehicle market is largely segmented in that a majority of the lightest weight class vehicles are powered by gasoline-fueled spark-ignition engines and most of the heaviest weight class vehicles are powered by diesel-fueled compression-ignition engines. There is significant overlap in the engines installed in Class 4–6 applications.<sup>293</sup> Considering the interchangeable nature of these middle range vehicles, we have designed our proposed program options so that, regardless of what the market chooses (e.g., gasoline- or diesel-fueled engines), similar emission reductions would be realized over their expected operational lives. We believe it is appropriate to propose standards that are numerically fuel neutral yet account for the fundamental differences between CI and SI engines.<sup>294</sup> We believe this proposed approach would result in roughly equivalent implementation burdens for manufacturers. As described in this section, the proposed Options 1 and 2 NO<sub>x</sub> and PM standards are based on test data from our CI engine feasibility demonstration program. We also find that they are feasible for SI engines based on currently available technologies and we are adopting them for SI engines to maintain fuel neutral standards. The proposed Options 1 and

<sup>291</sup> See proposed 40 CFR 1036.104.

<sup>292</sup> We are proposing to migrate the current alternate standards available for engines used in certain specialty vehicles from 40 CFR 86.007–11 and 86.008–10 into 40 CFR 1036.605 without modification, and are requesting comment on alternative options to our proposal. See Section XII.B of this preamble for a discussion of these standards and further details regarding our request for comment.

<sup>293</sup> The heavy-duty highway engines installed in vehicles with a GVWR between 8,501 and 14,000 pounds (Class 2b and 3) that are not chassis-certified, are subject to standards defined in 40 CFR 86.007–11 and 40 CFR 86.008–10. For CI engines this is only small fraction of the Class 2b and 3 vehicles. For SI engines all Class 2b and 3 gasoline-fueled vehicles are chassis-certified and would not be affected by the proposals in this rulemaking.

<sup>294</sup> Current emission controls for heavy-duty engines largely target the emissions produced by the engine-specific combustion process. The combustion process of diesel-fueled CI engines inherently produces elevated NO<sub>x</sub> and PM that are controlled by selective catalytic reduction (SCR) and diesel particulate filter (DPF) technologies, while gasoline-fueled SI engines are more likely to produce higher levels of HC and CO that are controlled by three-way catalyst (TWC) technology. See Chapter 2 of the draft RIA for additional background on these emission control technologies.

2 HC and CO standards are based on HD SI engine emission performance. We also find that they are feasible for CI engines based on currently available technologies and we are adopting them for CI engines to maintain fuel neutral standards. We have not relied on the use of HEV, BEV, or FCEV technologies in the development of our proposed Options 1 and 2 or the Alternative standards; however, as discussed in Section IV, we are proposing to allow these technologies to generate NO<sub>x</sub> emission credits as a flexibility for manufacturers to spread out their investment and prioritize technology adoption to the applications that make the most sense for their businesses during their transition to meeting the proposed more stringent standards (see Sections IV.G, IV.H, and, IV.I for details on our proposed approach to NO<sub>x</sub> emission credits). We do not expect that current market penetration of BEVs (0.06 percent in MY 2019) or projected penetration rate in the MY 2027 timeframe (1.5 percent) would meaningfully impact our analysis for developing the numeric level of the proposed Options 1 and 2 standards;<sup>295</sup> however, as noted in III.B.5, we are requesting comment on whether to include HEV, BEV, and/or FCEV technologies in our feasibility analysis for the final rule and may re-evaluate our approach, especially if we receive information showing higher BEV/FCEV market penetration in the MY 2027 or later timeframe.<sup>296</sup>

Engine manufacturers historically have demonstrated compliance with EPA emission standards by measuring emissions while the engine is operating over precisely defined duty cycles in an emissions testing laboratory. The primary advantage of this approach is that it provides very repeatable emission

<sup>295</sup> As discussed in IV.I, we are proposing that BEVs and FCEVs can generate NO<sub>x</sub> credits that reflect the zero tailpipe emission performance of these technologies; however, the value of the NO<sub>x</sub> emission credits for BEVs and FCEVs relative to the difference in the proposed versus current NO<sub>x</sub> emission standards results in larger numbers of BEVs or FCEVs being needed to offset the projected improvement in NO<sub>x</sub> emission control from CI or SI engines relative to the number of BEVs or FCEVs needed to offset the projected improvement in CO<sub>2</sub> emission control. This difference in the magnitude of potential impact from BEVs or FCEVs on NO<sub>x</sub> versus CO<sub>2</sub> emission standards is further amplified by the advanced technology emission credit multipliers included in the HD GHG Phase 2 program, which we are choosing not to propose for NO<sub>x</sub> emission credits. In addition to this, we are proposing an FEL for cap for NO<sub>x</sub> emissions that would require all engines to certify below the current NO<sub>x</sub> emission standard.

<sup>296</sup> See Preamble XI for more discussion on BEV/FCEV market projections and our proposal to account for them in revised HD GHG Phase 2 standards.

measurements. In other words, the results should be the same no matter when or where the test is performed, as long as the specified test procedures are used. We continue to consider pre-production laboratory engine testing (and durability demonstrations) as the cornerstone of ensuring in-use emission standards compliance. However, tying each emission standard to a specific, defined test cycle leaves open the possibility of emission controls being designed more to the limited conditions of the test procedures than to the full range of in-use operation. Since 2004, we have applied additional off-cycle standards for diesel engines that allow higher emission levels but are not limited to a specific duty cycle, and instead measure emissions over real-world, non-prescribed driving routes that cover a range of in-use operation.<sup>297</sup> Our proposal includes new and updated heavy-duty engine test procedures and standards, both for duty cycle standards to be tested in an emissions testing laboratory and for off-cycle standards that can be tested on the road in real-world conditions, as described in the following sections.

### 3. Implementation of Proposed Program

As discussed in this section, we have evaluated the proposed standards in terms of technological feasibility, lead time, stability, cost, energy, and safety, consistent with the requirements in CAA section 202(a)(3). We are proposing standards based on our CI and SI engine feasibility demonstration programs, with Option 1 standards in two steps for MY 2027 and MY 2031 and Option 2 standards in one step starting in MY 2027. Our evaluation of available data shows that the standards and useful life periods in both steps of proposed Option 1 are feasible and would result in the greatest emission reductions achievable for the model years to which they are proposed to apply, pursuant to CAA section 202(a)(3), giving appropriate consideration to cost, lead time, and other factors. Our analysis further shows that the standards and useful life periods in proposed Option 2 are feasible in the 2027 model year, but would result in lower levels of emission reductions compared to proposed Option 1. As explained further in this section and Chapter 3 of the draft RIA, we expect that additional data from EPA's ongoing work to demonstrate the

performance of emission control technologies, as well as information received in public comments, will allow us to refine our assessments and consideration of the feasibility of the combination of the standards and useful life periods, particularly for the largest CI engines (HHDEs), in proposed Options 1 and 2, after consideration of lead time, costs, and other factors. Therefore, we are co-proposing Options 1 and 2 standards and useful life periods, and the range of options in between them, as the options that may potentially be appropriate to finalize pursuant to CAA section 202(a)(3) once EPA has considered that additional data and other information.

We are proposing MY 2027 as the first implementation year for both options to align with the final step of the HD GHG Phase 2 standards, which would provide at least four years of lead time from a final rulemaking in 2022. As discussed in Section I and detailed in this section, the four-year lead time for the proposed criteria pollutant standards allows manufacturers to develop and apply the emission control technologies needed to meet the proposed standards, and to ensure those technologies will be durable for the proposed longer useful life periods; four years of lead time is also consistent with the CAA requirements.

In the event that manufacturers start production of some engine families sooner than four years from our final rule, we are proposing an option to split the 2027 model year.<sup>298</sup> Specifically, we are proposing that a MY 2027 engine family that starts production within four years of the final rule could comply with the proposed MY 2027 standards for all engines produced for that engine family in MY2027 or could split the engine family by production date in MY 2027 such that engines in the family produced prior to four years after the final rule would continue to be subject to the existing standards.<sup>299</sup> This proposed option to split the first model year provides assurance that all manufacturers, regardless of when they start production of their engine families, will have four years of lead time to the proposed first implementation step in MY 2027.

For Option 1, the phased implementation would also provide four years of stability before increasing stringency again in MY 2031. Through comments received on our ANPR, we

have heard from manufacturers that given the challenge of implementing the third step of the HD GHG rules in MY 2027, they believe it would take closer to four years to adequately fine-tune and validate their products for a second step of more stringent criteria pollutant control that also extends useful life.<sup>300</sup> In response to this concern, and the general request by suppliers and environmental stakeholders for a nationally aligned criteria pollutant program, we are proposing MY 2031 for the final step of the proposed Option 1 standards to provide four additional years for manufacturers to design and build engines that will meet the proposed second step of the Option 1 standards and associated compliance provisions.<sup>301</sup> A MY 2031 final step would also align with the Omnibus.<sup>302</sup> We request comment on the general approach of a two-step versus one-step program, and the advantages or disadvantages of the proposed Option 1 two-step approach that EPA should consider in developing the final rule. For instance, we seek commenters' views on whether the Agency should adopt a first step of standards but defer any second step of standards to a planned future rulemaking on heavy-duty GHG emissions instead of adopting a second step of standards in this rulemaking.<sup>303</sup> We also request comment on whether there are additional factors that we should consider when setting standards out to the MY 2031 timeframe.

As explained in Section III.B.3, we have evaluated and considered the costs of these technologies in our assessment of the proposed Options 1 and 2 standards. The proposed Options 1 and 2 standards are achievable without increasing the overall fuel consumption and CO<sub>2</sub> emissions of the engine for each of the duty cycles (FTP, SET, and LLC) and the fuel mapping test procedures defined in 40 CFR 1036.535 and 1036.540, as discussed in the Chapter 3 of the draft RIA.<sup>304</sup> Finally,

<sup>300</sup> See comments from Volvo. Docket ID: EPA-HQ-OAR-2019-0055-0463.

<sup>301</sup> See comments from MECA, MEMA and Union of Concerned Scientists. Docket ID: EPA-HQ-OAR-2019-0055-0463.

<sup>302</sup> California Air Resources Board. Heavy-Duty Omnibus Regulation. Available online: <https://ww2.arb.ca.gov/rulemaking/2020/hdomnibuslownox>.

<sup>303</sup> As noted in the Executive Summary and discussed in Sections XI and XIII, this proposal is consistent with E.O. 14037, which also directs EPA to consider undertaking a separate rulemaking to establish new GHG emission standards for heavy-duty engines and vehicles to begin as soon as MY 2030.

<sup>304</sup> The proposed ORVR requirements discussed in Section III.E.2 would reduce fuel consumed from

<sup>297</sup> As discussed in Section IV.K, EPA regulations provide for testing engines at various stages in the life of an engine; duty cycle or off-cycle procedures may be used pre- or post-production to verify that the engine meets applicable duty cycle or off-cycle emission standards throughout useful life.

<sup>298</sup> We are proposing an option to split the 2027 model year for new MY 2027 criteria pollutant standards under any regulatory option with such standards in MY 2027 that EPA may adopt for the final rule.

<sup>299</sup> See 40 CFR 86.007-11.

the proposed Options 1 and 2 standards would have no negative impact on safety, based on the existing use of these technologies in light-duty vehicles and heavy-duty engines on the road today.

*B. Summary of Proposed Compression-Ignition Exhaust Emission Standards and Proposed Duty Cycle Test Procedures*

1. Current Duty Cycle Test Procedures and Standards

Current criteria pollutant standards must be met by compression-ignition engines over both the Federal Test

Procedure (FTP)<sup>305</sup> and the Supplemental Emission Test (SET) duty cycles. The FTP duty cycles, which date back to the 1970s, are composites of a cold-start and a hot-start transient duty cycle designed to represent urban driving. There are separate duty cycles for both SI and CI engines. The cold-start emissions are weighted by one-seventh and the hot-start emissions are weighted by six-sevenths.<sup>306</sup> The SET is a more recent duty cycle for diesel engines that is a continuous cycle with ramped transitions between the thirteen steady-state modes.<sup>307</sup> The SET does not include engine starting and is intended

to represent fully warmed-up operating modes not emphasized in the FTP, such as more sustained high speeds and loads.

Emission standards for criteria pollutants are currently set to the same numeric value for FTP and SET test cycles. Manufacturers of compression-ignition engines have the option to participate in our averaging, banking, and trading (ABT) program for NO<sub>x</sub> and PM as discussed in Section IV.G.<sup>308</sup> These pollutants are subject to family emission limit (FEL) caps of 0.50 g/hp-hr for NO<sub>x</sub> and 0.02 g/hp-hr for PM.<sup>309</sup>

TABLE III-1—CURRENT DIESEL-CYCLE ENGINE STANDARDS OVER THE FTP AND SET DUTY CYCLES

NO <sub>x</sub> <sup>a</sup> (g/hp-hr)	PM <sup>b</sup> (g/hp-hr)	HC (g/hp-hr)	CO (g/hp-hr)
0.20	0.01	0.14	15.5

<sup>a</sup> Engine families participating in the ABT program are subject to a FEL cap of 0.50 g/hp-hr for NO<sub>x</sub>.

<sup>b</sup> Engine families participating in the ABT program are subject to a FEL cap of 0.02 g/hp-hr for PM.

EPA developed powertrain and hybrid powertrain test procedures for the HD GHG Phase 2 Heavy-Duty Greenhouse Gas rulemaking (81 FR 73478, October 25, 2016) with updates in the HD Technical Amendments rule (86 FR 34321, June 29, 2021).<sup>310</sup> The powertrain and hybrid powertrain tests allow manufacturers to directly measure the effectiveness of the engine, the transmission, the axle and the integration of these components as an input to the Greenhouse gas Emission Model (GEM) for compliance with the greenhouse gas standards. As part of the technical amendments, EPA allowed the powertrain test procedure to be used beyond the current GEM drive cycles to include the FTP and SET engine-based test cycles and to facilitate hybrid powertrain testing (40 CFR 1036.505 and 1036.510 and 40 CFR 1037.550).

These heavy-duty diesel-cycle engine standards are applicable for a useful life period based on the primary intended service class of the engine.<sup>311</sup> For certification, manufacturers must demonstrate that their engines will meet these standards throughout the useful life by performing a durability test and applying a deterioration factor (DF) to their certification value.<sup>312</sup>

Additionally, manufacturers must adjust emission rates for engines with

exhaust aftertreatment to account for infrequent regeneration events accordingly.<sup>313</sup> To account for variability in these measurements, as well as production variability, manufacturers typically add margin between the DF and infrequent regeneration adjustment factor (IRAF) adjusted test result, and the family emission limit (FEL). A summary of the margins manufacturers have included for MY 2019 and newer engines is summarized in Chapter 3.1.2 of the draft RIA.

2. Proposed Test Procedures and Standards

EPA is proposing new NO<sub>x</sub>, PM, HC, and CO emission standards for heavy-duty compression-ignition engines that will be certified under 40 CFR part 1036.<sup>314 315</sup> We are proposing updates to emission standards for our existing laboratory test cycles (*i.e.*, FTP and SET) and proposing NO<sub>x</sub>, PM, HC and CO emission standards based on a new low-load test cycle (LLC) as described below.<sup>316</sup> The proposed standards for NO<sub>x</sub>, PM, and HC are in units of milligrams/horsepower-hour instead of grams/horsepower-hour because using units of milligrams better reflects the precision of the new standards, rather than adding multiple zeros after the

decimal place. Making this change would require updates to how manufacturers report data to the EPA in the certification application, but it does not require changes to the test procedures that define how to determine emission values. We describe compression-ignition engine technology packages that demonstrate the feasibility of achieving these proposed Options 1 and 2 standards in Section III.B.3.ii and provide additional details in Chapters 2 and 3 of the draft RIA for this rulemaking.

As part of this rulemaking, we are proposing two options to increase the useful life for each engine class as described in Section IV.A. The proposed Options 1 and 2 emission standards outlined in this section would apply for the longer useful life periods and manufacturers would be responsible for demonstrating that their engines will meet these standards as part of the proposed revisions to durability requirements described in Section IV.F. In Section IV.G, we discuss our proposed updates to the ABT program to account for our proposal of three laboratory cycles (FTP, SET and LLC) with unique standards.

As discussed in Section III.B.2, the proposal includes two sets of standards: Proposed Option 1 and proposed Option

gasoline fuel engines, but these fuel savings would not be measured on the duty cycles since the test procedures for these tests measure tailpipe emissions and do not measure emissions from refueling. We describe our estimate of the fuel savings in Chapter 7.2.2 of the draft RIA.

<sup>305</sup> EPA specifies different FTP duty cycles for compression-ignition and spark-ignition engines.

<sup>306</sup> See 40 CFR 86.007-11 and 40 CFR 86.008-10.

<sup>307</sup> See 40 CFR 86.1362.

<sup>308</sup> See 40 CFR 86.007-15.

<sup>309</sup> See 40 CFR 86.007-11.

<sup>310</sup> See 40 CFR 1037.550.

<sup>311</sup> 40 CFR 86.004-2.

<sup>312</sup> See 40 CFR 86.004-26(c) and (d) and 86.004-28(c) and (d).

<sup>313</sup> See 40 CFR 1036.501(d).

<sup>314</sup> See proposed 40 CFR 1036.104.

<sup>315</sup> See proposed 40 CFR 1036.605 and Section XII.B of this preamble for a discussion of our proposal for engines installed in specialty vehicles.

<sup>316</sup> See proposed 40 CFR 1036.104.

2. As described in Section III.B.3.ii, we believe the technology packages evaluated for this proposal can achieve our proposed Options 1 and 2 duty-cycle standards. For Option 1, we are proposing the standards in two steps in MY 2027 and MY 2031, because the proposed Option 1 program includes not only numerical updates to existing standards but also other new and revised standards and compliance provisions such as a new duty-cycle procedure and standards, revised off-cycle procedures and standards, longer useful life periods, and other proposed requirements that, when considered collectively, merit a phased approach to lead time. As discussed in Section I.G and in Section III.B.4, we also present an alternative set of standards (Alternative) that we also considered. The Alternative is more stringent than either the proposed Option 1 MY 2031 standards or proposed Option 2 because the Alternative has shorter lead time, lower numeric NO<sub>x</sub> emission standards and longer useful life periods. We note that we currently are unable to conclude that the Alternative is feasible in the MY 2027 timeframe over the useful life periods in this Alternative in light of deterioration in the emission control technologies that we have evaluated to date, and we expect that we would need additional supporting data or other information in order to determine that the Alternative is feasible in the MY 2027 timeframe to consider adopting it in the final rule.

The proposed options for NO<sub>x</sub> standards were derived to consider the range of options that may potentially be appropriate to adopt to achieve the maximum feasible emissions reductions from heavy-duty diesel engines considering lead time, stability, cost, energy and safety. To accomplish this, we evaluated what operation made up the greatest part of the inventory as discussed in Section VI.B and what technologies could be used to reduce emissions in these areas. As discussed in Section I, we project that emissions from operation at low power, medium-to-high power, and mileages beyond the current regulatory useful life of the engine would account for the majority of heavy-duty highway emissions in 2045. To achieve reductions in these three areas we identified options for cycle-specific standards to ensure that the maximum achievable reductions are seen across the operating range of the engine. As described in Section IV, we are proposing to increase both the regulatory useful life and the emission-related warranty periods to ensure these

proposed standards are met for a greater portion of the engine's operational life.

To achieve the goal of reducing emissions across the operating range of the engine, we are proposing two options for standards for three duty cycles (FTP, SET and LLC). In proposing these standards, we assessed the performance of the best available aftertreatment systems, which are more efficient at reducing NO<sub>x</sub> emissions at the higher exhaust temperatures that occur at high engine power, than they are at reducing NO<sub>x</sub> emissions at low exhaust temperatures that occur at low engine power. To achieve the maximum NO<sub>x</sub> reductions from the engine at maximum power, the aftertreatment system was designed to ensure that the downstream selective catalytic reduction (SCR) catalyst was properly sized, diesel exhaust fluid (DEF) was fully mixed with the exhaust gas ahead of the SCR catalyst and the diesel oxidation catalyst (DOC) was designed to provide a molar ratio of NO to NO<sub>2</sub> of near one. To reduce emissions under low power operation and under cold-start conditions, we selected standards for proposed Option 1, for the LLC and the FTP that would achieve an 80 to 90 percent, or more, reduction in emissions under these operating conditions as compared to current standards. The proposed Options 1 and 2 standards are achievable by utilizing cylinder deactivation (CDA), dual-SCR aftertreatment configuration and heated diesel exhaust fluid (DEF) dosing. To reduce emissions under medium to high power, we selected standards for proposed Option 1, for the SET that would achieve a greater than 80 percent reduction in emissions under these operating conditions. The proposed Options 1 and 2 SET standards are achievable by utilizing improvements to the SCR formulation, SCR catalyst sizing, and improved mixing of DEF with the exhaust. Further information about these technologies can be found in Chapters 1 and 3 of the draft RIA.

For the proposed Options 1 and 2 PM standards, they were set at a level to maintain the current emissions performance of diesel engines. For the proposed Options 1 and 2 standards for HC and CO, they were generally set at a level that is achievable by spark-ignition engines. Each of these standards are discussed in more detail in the following sections.

In proposed Option 1 for MY 2031 and later Heavy HDE, we are proposing NO<sub>x</sub> standards at an intermediate useful life (IUL) of 435,000 miles as discussed later in Section III.B.2. We believe that the proposed Option 1 useful life for these engines of 800,000 miles justifies

the need for standards at IUL. It could be many years after the engines are on the road before EPA could verify that the engines meet the standards out to useful life if there is no IUL standard. As discussed further in Section III.B.3.ii.a, IUL standards ensure that the emissions from the engine are as low as feasible for the entire useful life and provides an intermediate check on emission performance deterioration over the UL.

As discussed in Section III.B.3, we have assessed the feasibility of the proposed Options 1 and 2 standards for compression-ignition engines by testing a Heavy HDE equipped with cylinder CDA technology and dual-SCR aftertreatment configuration with heated DEF dosing. The demonstration work consisted of two phases. The first phase of the demonstration was led by CARB and is referred to as CARB Stage 3. In this demonstration the aftertreatment was chemically- and hydrothermally-aged to the equivalent of 435,000 miles. During this aging the emissions performance of the engine was assessed after the aftertreatment was degreened, at the equivalent of 145,000 miles, 290,000 miles and 435,000 miles. The second phase of the demonstration was led by EPA and is referred to as the EPA Stage 3 engine. In this phase, improvements were made to the aftertreatment by replacing the zone-coated catalyzed soot filter with a separate DOC and diesel particulate filter (DPF) that were chemically- and hydrothermally-aged to the equivalent of 800,000 miles and improving the mixing of the DEF with exhaust prior to the downstream SCR catalyst. The EPA Stage 3 engine was tested at an age equivalent to 435,000 and 600,000 miles. The EPA Stage 3 engine will be tested at an age equivalent of 800,000 miles. Additionally, we plan to test a second aftertreatment system referred to as "Team A" which is also a dual-SCR aftertreatment configuration with heated DEF dosing, but has greater SCR catalyst volume and a different catalyst washcoat formulation.

#### i. FTP

We are proposing new emission standards for testing over the FTP duty-cycle as shown in Table III-2.<sup>317</sup> These brake-specific FTP standards would apply across the primary intended service classes over the useful life periods shown in Table III-3. These Options 1 and 2 standards have been shown to be feasible for compression-ignition engines based on testing of the

<sup>317</sup> See 40 CFR 1036.510 for FTP duty-cycle test procedure.



CARB Stage 3 and EPA Stage 3 engine with a chemically- and hydrothermally-aged aftertreatment system.<sup>318</sup> At the time of this proposal, the catalyst was aged to an equivalent of 800,000 miles, but the test data at the equivalent of 800,000 miles was not yet available. EPA will continue to assess the feasibility of the proposed standards as additional demonstration data becomes available during the course of this

rulemaking. For example, the EPA Stage 3 engine, and EPA's Team A demonstration engine will be aged to and tested at the equivalent of 800,000 miles.<sup>319</sup> A summary of the data used for EPA's feasibility analysis can be found in Section III.B.3. To provide for additional margin, in our technology cost analysis we increased the SCR catalyst volume from what was used on the EPA and CARB Stage 3 engine. We

are proposing to continue an averaging, banking, and trading (ABT) program for NO<sub>x</sub> credits as a flexibility for manufacturers. Our proposal includes targeted revisions to the current ABT program, including new provisions to clarify how FELs apply for additional duty cycles, lower FEL caps for NO<sub>x</sub> and restrictions for using NO<sub>x</sub> emission credits (see Section IV.G for details on the ABT program).

TABLE III-2—PROPOSED COMPRESSION-IGNITION ENGINE STANDARDS OVER THE FTP DUTY CYCLE

	Model year	Primary intended service class	NO <sub>x</sub> <sup>a</sup> (mg/hp-hr)	PM (mg/hp-hr)	HC (mg/hp-hr)	CO (g/hp-hr)
Proposed Option 1 ..	2027–2030 .....	All HD Engines .....	35	5	60	6.0
	2031 and later .....	Light HDE and Medium HDE .....	20	5	40	6.0
	2031 and later .....	Heavy HDE through IUL .....	20	5	40	6.0
	2031 and later .....	Heavy HDE from IUL to FUL .....	40	5	40	6.0
Proposed Option 2 ..	2027 and later .....	All HD Engines .....	50	5	40	6.0

<sup>a</sup> Engine families participating in the ABT program would be subject to a NO<sub>x</sub> FEL cap, discussed in Section IV.G.3.

TABLE III-3—PROPOSED USEFUL LIFE PERIODS FOR HEAVY-DUTY COMPRESSION-IGNITION PRIMARY INTENDED SERVICE CLASSES

Primary intended service class	Current		Proposed Option 1				Proposed Option 2	
	Miles	Years	MY 2027–2030		MY 2031+		Miles	Years
			Miles	Years	Miles	Years		
Light HDE <sup>a</sup>	110,000	10	190,000	12	270,000	15	250,000	10
Medium HDE ...	185,000	10	270,000	11	350,000	12	325,000	10
Heavy HDE <sup>b</sup>	435,000	10	600,000	11	800,000 <sup>c</sup>	12	650,000	10

<sup>a</sup> Current useful life period for Light HDE for GHG emission standards is 15 years or 150,000 miles. See 40 CFR 1036.108(d).

<sup>b</sup> Proposed Option 1 includes an hours-based useful life for Heavy HDE of 32,000 operating hours for model year 2027 through 2030, and 40,000 operating hours for model year 2031 and later.

<sup>c</sup> For MY 2031 and later Heavy HDE under proposed Option 1, we are proposing intermediate useful life periods of 435,000 miles, 10 years, or 22,000 hours, whichever comes first. See Section III for a discussion of the Option 1 standards we propose to apply for the intermediate and full useful life periods.

The proposed Options 1 and 2, 5 mg/hp-hr (0.005 g/hp-hr) FTP standard for PM is intended to ensure that there is not an increase in PM emissions from future engines. As summarized in Section III.B.3.ii.b, manufacturers are submitting certification data to the agency for current production engines well below the proposed PM standard over the FTP duty cycle. Lowering the standard to 5 mg/hp-hr would ensure that future engines will maintain the low level of PM emissions of the current engines. Taking into account measurement variability of the PM measurement test procedure in the proposed PM standards, we believe that PM emissions from current diesel engines are at the lowest feasible level for MY 2027 and later engines. We request comment on whether 5 mg/hp-hr provides enough margin for particular engine designs. For example,

would 6 or 7 mg/hp-hr be a more appropriate standard to maintain current PM emissions levels while providing enough margin to account for the measurement variability of the PM measurement test procedure.

We are proposing two options HC and CO standards based on the feasibility demonstration for SI engines. As summarized in Section III.B.3.ii.b, manufacturers are submitting data to the agency that show emissions performance for current production CI engines is well below the current and proposed standards. Keeping standards at the same value for all fuels is consistent with the agency's approach to previous criteria pollutant standards. See Section III.C for more information on how the numeric values of these two options for proposed HC and CO standards were determined.

In the ANPR, we requested comment on changing the weighting factors for the FTP cycle for heavy-duty engines. The current FTP weighting of cold-start and hot-start emissions was promulgated in 1980 (45 FR 4136, January 21, 1980). It reflects the overall ratio of cold and hot operation for heavy-duty engines generally and does not distinguish by engine size or intended use. Specifically, we asked if FTP weighting factors should vary by engine class and any challenges manufacturers may encounter to implement changes to the weighting factors. We did not receive any comments to change the weighting and received comments from Roush and MECA that the current weighting factors are appropriate. After considering these comments, we are not proposing any changes to the weighting factors.

<sup>318</sup> See Section III.B.2 for a description of the engine.

<sup>319</sup> Data will be added to the public docket once it becomes available.

ii. SET

We are proposing new emissions standards for the SET test procedure as shown in Table III–4 over the same useful life periods shown in Table III–3. Consistent with our current standards, we are proposing the same numeric values for the standards over the FTP and SET duty cycles, and the brake-specific SET standards apply

across engine classes (primary intended service class). As with the FTP cycle, the Options 1 and 2 standards have been shown to be feasible for compression-ignition engines based on testing of the CARB Stage 3 and EPA Stage 3 engines with a chemically- and hydrothermally-aged aftertreatment system. At the time of this proposal, the catalyst was aged to an equivalent of 800,000 miles, but the test data at the equivalent of 800,000

miles was not yet available. EPA will continue to assess the feasibility of the proposed standards as additional data becomes available. To provide additional margin for meeting the SET standards, we have accounted for additional SCR catalyst volume in our cost analysis. A summary of the data used for EPA’s feasibility analysis can be found in Section III.B.3.

TABLE III–4—PROPOSED COMPRESSION-IGNITION ENGINE STANDARDS OVER THE SET DUTY CYCLE

	Model year	Primary intended service class	NO <sub>x</sub> (mg/hp-hr)	PM (mg/hp-hr)	HC (mg/hp-hr)	CO (g/hp-hr)
Proposed Option 1 ..	2027–2030 .....	All HD Engines .....	35	5	60	6.0
	2031 and later .....	Light HDE and Medium HDE .....	20	5	40	6.0
	2031 and later .....	Heavy HDE through IUL .....	20	5	40	6.0
	2031 and later .....	Heavy HDE from IUL to FUL .....	40	5	40	6.0
Proposed Option 2 ..	2027 and later .....	All HD Engines .....	50	5	40	6.0

As with the proposed PM standards for the FTP (see Section III.B.2.i), the proposed Options 1 and 2 P.M. standards for SET is intended to ensure that there is not an increase in PM emissions from future engines. We request comment on whether 5 mg/hp-hr provides enough margin for particular engine designs. For example, would 6 or 7 mg/hp-hr be a more appropriate standard to maintain current PM emissions levels while providing enough margin to account for the measurement variability of the PM measurement test procedure. As with the options for proposed HC and CO standards for the FTP (see Section III.B.2.i), we are proposing two options for standards for HC and CO based on the feasibility demonstration for SI engines (see Section III.C).

We have also observed an industry trend toward engine down-speeding—that is, designing engines to do more of their work at lower engine speeds where frictional losses are lower. To better reflect this trend in our duty cycle testing, in the HD GHG Phase 2 final rule, we promulgated new SET weighting factors for measuring CO<sub>2</sub> emissions (81 FR 73550, October 25, 2016). Since we believe these new weighting factors better reflect in-use operation of current and future heavy-duty engines, we are proposing to apply these new weighting factors to criteria pollutant measurement, as show in Table III–5, for NO<sub>x</sub> and other criteria pollutants as well. To assess the impact of the new test cycle on criteria pollutant emissions, we analyzed data from the EPA Stage 3 engine that was tested on both versions of the SET. The data summarized in Section III.B.3.ii.a

show that the NO<sub>x</sub> emissions from the EPA Stage 3 engine at an equivalent of 435,000 miles are slightly lower using the proposed SET weighting factors in 40 CFR 1036.505 versus the current SET procedure in 40 CFR 86.1362. The lower emissions using the proposed SET cycle weighting factors are reflected in the stringency of the proposed Options 1 and 2 SET standards.

TABLE III–5 PROPOSED WEIGHTING FACTORS FOR THE SET

Speed/% load	Weighting factor (%)
Idle .....	12
A, 100 .....	9
B, 50 .....	10
B, 75 .....	10
A, 50 .....	12
A, 75 .....	12
A, 25 .....	12
B, 100 .....	9
B, 25 .....	9
C, 100 .....	2
C, 25 .....	1
C, 75 .....	1
C, 50 .....	1
Total .....	100
Idle Speed .....	12
Total A Speed .....	45
Total B Speed .....	38
Total C Speed .....	5

iii. LLC

EPA is proposing the addition of a low-load test cycle and standard that would require CI engine manufacturers to demonstrate that the emission control system maintains functionality during low-load operation where the catalyst temperatures have historically been found to be below their operational

temperature (see Chapter 2.2.2 of the draft RIA). We believe the addition of a low-load cycle would complement the expanded operational coverage of our proposed off-cycle testing requirements (see Section III.C).

During “Stage 2” of their Low NO<sub>x</sub> Demonstration program, SwRI and NREL developed several candidate cycles with average power and duration characteristics intended to test current diesel engine emission controls under three low-load operating conditions: Transition from high- to low-load, sustained low-load, and transition from low- to high-load.<sup>320</sup> In September 2019, CARB selected the 92-minute “LLC Candidate #7” as the low load cycle they adopted for their Low NO<sub>x</sub> Demonstration program and subsequent Omnibus regulation.<sup>321 322</sup>

We are proposing to adopt CARB’s Omnibus LLC as a new test cycle, the LLC. This cycle is described in Chapter 2 of the draft RIA for this rulemaking and test procedures are specified in the proposed 40 CFR 1036.512. The proposed LLC includes applying the accessory loads defined in the HD GHG Phase 2 rule. These accessory loads are 1.5, 2.5 and 3.5 kW for Light HDE,

<sup>320</sup> California Air Resources Board. “Heavy-Duty Low NO<sub>x</sub> Program Public Workshop: Low Load Cycle Development”. Sacramento, CA. January 23, 2019. Available online: [https://ww3.arb.ca.gov/msprog/hdlownox/files/workgroup\\_20190123/02-llc\\_ws01232019-1.pdf](https://ww3.arb.ca.gov/msprog/hdlownox/files/workgroup_20190123/02-llc_ws01232019-1.pdf).

<sup>321</sup> California Air Resources Board. Heavy-Duty Omnibus Regulation. Available online: <https://ww2.arb.ca.gov/rulemaking/2020/hdomnibuslownox>.

<sup>322</sup> California Air Resources Board. “Heavy-Duty Low NO<sub>x</sub> Program: Low Load Cycle” Public Workshop. Diamond Bar, CA. September 26, 2019. Available online: [https://ww3.arb.ca.gov/msprog/hdlownox/files/workgroup\\_20190926/staff/03\\_llc.pdf](https://ww3.arb.ca.gov/msprog/hdlownox/files/workgroup_20190926/staff/03_llc.pdf).

Medium HDE, and Heavy HDE engines, respectively. To allow vehicle level technologies to be recognized on this cycle we are proposing the powertrain test procedure to include the LLC. More information on the powertrain test procedure can be found in Section III.A.2.v. For the determination of IRAF for the LLC, we are proposing the test procedures defined in 40 CFR 1036.522, which is the same test procedure that is used for the FTP and SET. We believe that the IRAF test procedures that apply to the FTP and SET are appropriate for the LLC, but we request comment on

whether to modify how the regeneration frequency value in 40 CFR 1065.680 is determined, to account for the fact that a regeneration frequency value is needed for three duty cycles and not just two.

Our proposed Options 1 and 2 emission standards for this proposed LLC are presented in Table III–6. The brake-specific LLC standards would apply across engine classes. As with the FTP cycle, the data from the EPA Stage 3 demonstration engine with an aged aftertreatment system shows that these proposed Options 1 and 2 standards are feasible with available margins between

the data and the proposed standards. In fact, the margin between the proposed Option 1 MY 2031 standards and the Stage 3 engine data is the largest on the LLC, suggesting that a lower numeric NO<sub>x</sub> standard would be feasible at 435,000 and 600,000 miles than included in the proposed Option 1 IUL NO<sub>x</sub> standard. The summary of this data can be found in Section III.B.3.

We request comment on the addition of a low-load test cycle and standard, as well as the proposed accessory loads, or other engine operation a low-load cycle should encompass, if finalized.

TABLE III–6—PROPOSED COMPRESSION-IGNITION ENGINE STANDARDS OVER THE LLC DUTY CYCLE

	Model year	Primary intended service class	NO <sub>x</sub> (mg/hp-hr)	PM (mg/hp-hr)	HC (mg/hp-hr)	CO (g/hp-hr)
Proposed Option 1 ..	2027–2030 .....	All HD Engines .....	90	5	140	6.0
	2031 and later .....	Light HDE and Medium HDE .....	50	5	60	6.0
	2031 and later .....	Heavy HDE through IUL .....	50	5	60	6.0
	2031 and later .....	Heavy HDE from IUL to FUL .....	100	5	60	6.0
Proposed Option 2 ..	2027 and later .....	All HD Engines .....	100	5	60	6.0

The proposed LLC standards for PM are based on the effectiveness of the diesel particulate filter (DPF) to reduce PM emissions across the operating range of the engine, including under low loads. We request comment on whether 5 mg/hp-hr provides enough margin for particular engine designs. For example, would 6 or 7 mg/hp-hr be a more appropriate standard for the LLC to maintain current PM emissions levels while providing enough margin to account for the measurement variability of the PM measurement test procedure. Since we are not proposing standards on the LLC for SI engines, the data from the CARB and EPA Stage 3 engine discussed in Section III.B.3 were used to assess the feasibility of the proposed CO and HC standards. For both proposed Option 1 and Option 2 standards, we are proposing the same numeric standards for CO on the LLC as we have respectively proposed in Option 1 and Option 2 for the FTP and SET cycles. This is because the demonstration data of the EPA Stage 3 engine shows that CO emissions on the LLC are in similar to CO emissions from the FTP and SET. For the proposed Options 1 and 2 for HC standards on the LLC, we are proposing standards that are different than the standards of the FTP and SET cycles, to reflect the performance of the EPA Stage 3 engine on the LLC. The data discussed in Section III.B.3 of the preamble shows that the proposed Options 1 and 2 standards are feasible for both current and future new engines.

iv. Idle

CARB currently has an idle test procedure and accompanying standard of 30 g/h of NO<sub>x</sub> for diesel engines to be “Clean Idle Certified”.<sup>323</sup> In the Omnibus rule the CARB lowered the NO<sub>x</sub> standard to 10 g/h for MY 2024 to MY 2026 engines and 5 g/h for MY 2027 and beyond. In the ANPR, we requested comment on the need or appropriateness of setting a federal idle standard for diesel engines. We received comments supporting action by EPA to adopt California’s Clean Idle NO<sub>x</sub> standard as a voluntary emission standard for federal certification.<sup>324</sup> For proposed Option 1 we are proposing an optional idle standard in 40 CFR 1036.104(b) and a new test procedure in 40 CFR 1036.514, based on CARB’s test procedure,<sup>325</sup> to allow compression-ignition engine manufacturers to voluntarily choose to certify (*i.e.*, it would be optional for a manufacturer to include the idle standard in an EPA certification but once included the idle standard would become mandatory and full compliance would be required) to an idle NO<sub>x</sub> standard of 30.0 g/hr for MY 2023, 10.0 g/hr for MY 2024 to MY 2026 and 5.0 g/hr for MY 2027 and

beyond. As part of this optional idle standard, we are proposing to require that the brake-specific HC, CO, and PM emissions during the Clean Idle test may not exceed measured emission rates from the idle segments of the FTP or the idle mode in the SET, in addition to meeting the applicable idle NO<sub>x</sub> standard.<sup>326</sup> For proposed Option 2 we are proposing an idle NO<sub>x</sub> standard of 10.0 g/hr for MY 2027 and beyond. We request comment on whether EPA should make the idle standards mandatory instead of voluntary for MY 2027 and beyond, as well as whether EPA should set clean idle standards for HC, CO, and PM emissions (in g/hr) rather than capping the idle emissions for those pollutants based on the measured emission levels during the idle segments of the FTP or the idle mode in the SET. We request comment on the need for EPA to define a label that would be put on the vehicles that are certified to the optional idle standard.

v. Powertrain

EPA recently finalized a separate rulemaking that included an option for manufacturers to certify a hybrid powertrain to the FTP and SET greenhouse gas engine standards by using a powertrain test procedure (86 FR 34321, June 29, 2021).<sup>327</sup> In this

<sup>323</sup> 13 CCR 1956.8 (a)(6)(C)—Optional NO<sub>x</sub> idling emission standard.

<sup>324</sup> See comments from CARB, Volvo, and Union of Concerned Scientists, and Eaton. Docket ID: EPA–HQ–OAR–2019–0055–0463.

<sup>325</sup> 86.1360–2007.B.4, California Exhaust Emission Standards and Test Procedures for 2004 and Subsequent Model Heavy-Duty Diesel Engines and Vehicles, April 18, 2019.

<sup>326</sup> See 40 CFR 1036.104(b).

<sup>327</sup> The powertrain test procedure was established in the GHG Phase 1 rulemaking but the recent rulemaking included adjustments to apply the test procedure to the engine test cycles.

rulemaking, we similarly propose to allow manufacturers to certify hybrid powertrains, BEVs, and FCEVs to criteria pollutant emissions standards by using the powertrain test procedure. In this section we describe how manufacturers could apply the powertrain test procedure to certify hybrid powertrains, and, separately, BEVs or FCEVs.

#### a. Development of Powertrain Test Procedures

Powertrain testing allows manufacturers to demonstrate emission benefits that cannot be captured by testing an engine alone on a dynamometer. For hybrid engines and powertrains, powertrain testing captures when the engine operates less or at lower power levels due to the use of the hybrid powertrain function; for BEVs and FCEVs powertrain testing allows the collection of data on work produced, energy used and other parameters that would normally be collected for an engine during a dynamometer test. However, powertrain testing requires the translation of an engine test procedure to a powertrain test procedure. Chapter 2 of the draft RIA describes how we translated the FTP, proposed SET for criteria pollutants, and proposed LLC engine test cycles to the proposed powertrain test cycles.<sup>328</sup> The two primary goals of this process were to make sure that the powertrain version of each test cycle was equivalent to each respective engine test cycle in terms of positive power demand versus time and that the powertrain test cycle had appropriate levels of negative power demand. To achieve this goal, over 40 engine torque curves were used to create the powertrain test cycles. We request comment on ways to further improve the proposed powertrain test procedures, including approaches to apply the proposed procedures to powertrains that include a transmission as part of the certified configuration to make the idle accessory load more representative.

#### b. Testing Hybrid Engines and Hybrid Powertrains

As noted in the introduction of this Section III, we are proposing to clarify

in 40 CFR 1036.101 that manufacturers may optionally test the hybrid engine and hybrid powertrain to demonstrate compliance. We propose that the powertrain test procedures specified in 40 CFR 1036.505 and 1036.510, which were previously developed for demonstrating compliance with GHG emission standards on the SET and FTP test cycles, are applicable for demonstrating compliance with criteria pollutant standards on the SET and FTP test cycles. In addition, for GHG emission standards we are proposing updates to 40 CFR 1036.505 and 1036.510 to further clarify how to carry out the test procedure for plug-in hybrids. We have done additional work for this rulemaking to translate the proposed LLC to a powertrain test procedure, and we are proposing that manufacturers could similarly certify hybrid engines and hybrid powertrains to criteria pollutant emission standards on the proposed LLC using the proposed test procedures defined in 40 CFR 1036.512.

We thus propose to allow manufacturers to use the powertrain test procedures to certify hybrid engine and powertrain configurations to all MY 2027 and later criteria pollutant engine standards. We also propose to allow manufacturers to begin using powertrain test procedures to certify hybrid configurations to criteria pollutant standards in MY 2023. Manufacturers could choose to use either the SET duty-cycle in 40 CFR 86.1362 or the proposed SET in 40 CFR 1036.505 in model years prior to 2027.<sup>329 330</sup>

We are proposing to allow these procedures starting in MY 2023 for plug-in hybrids and, to maintain consistency with the requirements for LD plug-in hybrids, we are proposing that the applicable criteria pollutant standards must be met under the worst case condition, which is achieved by testing and evaluating emission under both charge depleting and charge sustaining operation. This is to ensure that under all drive cycles the powertrain meets the criteria pollutant standards and is not based on an assumed amount of zero emissions range. We are proposing changes to the test procedures defined in 40 CFR 1036.505 and 1036.510 to clarify how to

weight together the charge depleting and charge sustaining greenhouse gas emissions for determining the greenhouse gas emissions of plug-in hybrids for the FTP and SET duty cycles. This weighting would be done using an application specific utility factor curve that is approved by EPA. We are also proposing to not apply the cold and hot weighting factors for the determination of the FTP composite emission result for greenhouse gas pollutants because the charge depleting and sustaining test procedures proposed in 40 CFR 1036.510 include both cold and hot start emissions by running repeat FTP cycles back-to-back. By running back-to-back FTPs, the proposed test procedure captures both cold and hot emissions and their relative contribution to daily greenhouse gas emissions per unit work, removing the need for weighting the cold and hot emissions. We request comment on our proposed approach to the FTP duty cycle for plug-in hybrids and the proposed approach to the determination of the FTP composite emissions result, including whether EPA should instead include cold and hot weighting factors for the latter. If you comment that EPA should include the cold and hot weighting factors, we request that you also include an example of how these calculations would be carried out with such an approach (how the calculations would include both the weighting of charge sustaining and charge depleting emissions in conjunction with the weighting of the cold and hot emissions results).

We propose to limit this test procedure to hybrid powertrains to avoid having two different testing pathways for non-hybrid engines for the same standards. On the other hand, there may be other technologies where the emissions performance is not reflected on the engine test procedures, so we request comment on whether this test procedure should be available to other powertrains, and if so how to define those powertrains.

Finally, for all pollutants, we request comment on if we should remove 40 CFR 1037.551 or limit the use of it to only selective enforcement audits (SEA). 40 CFR 1037.551 was added as part of the Heavy-Duty Phase 2 GHG rulemaking to provide flexibility for an SEA or a confirmatory test, by allowing just the engine of the powertrain to be tested. Allowing just the engine to be tested over the engine speed and torque cycle that was recorded during the powertrain test enables the testing to be conducted in more widely available engine dynamometer test cells, but this

<sup>328</sup> As discussed in Section III.B.1, as part of the technical amendments rulemaking, EPA allowed the powertrain test procedure to be used for GHG emission standards on the FTP and SET engine-based test cycles. In this rulemaking we are proposing to allow the powertrain test procedure to be used for criteria emission standards on these test cycles and the proposed LLC. As discussed in Section 2.ii, we are proposing new weighting factors for the engine-based SET procedure for criteria pollutant emissions, which would be reflected in the SET powertrain test cycle.

<sup>329</sup> We proposing to allow either the SET duty-cycle in 40 CFR 86.1362 or 40 CFR 1036.505 because the duty cycles are similar and as shown in Chapter 3.1.2 of the Draft RIA the criteria pollutant emissions level of current production engines is similar between the two cycles.

<sup>330</sup> Prior to MY 2027, only manufacturers choosing to participate in the Early Adoption Incentive Program would need to conduct LLC powertrain testing (see Section IV.H for details on the Early Adoption Incentive Program).

flexibility could increase the variability of the test results. If you submit comment in support of removing or limiting the use of 40 CFR 1037.551 to just SEA, we request that you include data supporting your comment.

#### c. Testing Battery-Electric and Fuel Cell Electric Vehicles

As noted in the introduction to this Section III, and detailed in Section IV.I, we are proposing to recognize the zero tailpipe emission benefits of BEV and FCEV technologies by allowing manufacturers to generate NO<sub>x</sub> emission credits with these technologies.<sup>331</sup> We are further proposing that manufacturers who choose to generate NO<sub>x</sub> emission credits from BEVs or FCEVs would be required to conduct testing to measure work produced over a defined duty-cycle test, and either useable battery energy (UBE) for BEVs or fuel cell voltage (FCV) for FCEVs (see Section IV.I for details).

To conduct the testing necessary for generating NO<sub>x</sub> emission credits from BEVs or FCEVs, we are proposing that manufacturers would use the powertrain test procedures for the FTP, proposed SET and proposed LLC. Specifically, for BEVs, manufacturers would run a series of powertrain FTP, SET and LLC tests over a defined sequence referred to as a “Multicycle Test” (MCT), which is specified in proposed 40 CFR 1037.552. For FCEVs, manufacturers would operate the powertrain over an FTP, SET, and LLC and determine the average fuel cell voltage (FCV) by taking the average of the FCV when the fuel cell current is between 55 percent and 65 percent of rated fuel cell current, as specified in proposed 40 CFR 1037.554.<sup>332</sup>

The MCT for BEVs consists of a fixed number of dynamic drive cycles combined with constant-speed driving phases. The heavy-duty transient cycle (HDT) described in current 40 CFR 1036.510(a)(4), LLC described in proposed 40 CFR 1036.512, and SET

described in proposed 40 CFR 1036.505 are used to determine the energy consumption associated with specific and established driving patterns. These dynamic drive cycles make up a combined 57.92 miles of driving distance. The constant speed cycles (CSC), which are located in the middle and the end of the test, are intended to: Reduce test duration by depleting the battery more rapidly than the established certification drive schedules; improve the robustness of the energy determination by minimizing the impact of drive style variation; and prevent inconsistent triggering of end-of-test criteria that can occur at high power-demand points when a BEV is following a dynamic drive schedule at low states-of-charge.

The CSC middle phase is located after the initial run through two HDTs, one LLC, and one SET. This CSC depletes the battery and allows determination of the vehicle’s performance on the HDT, LLC, and SET for both high and low states of charge. The distance traveled during the CSC middle phase that is determined by this procedure ensures that the second run through two HDTs, one LLC, and one SET is conducted at a substantially lower state of charge. The target distance traveled over the CSC end phase is 20 percent or less of the total driven distance for the combined initial and second runs through the HDT, LLC, or SET cycles.

The MCT for FCEVs consists of running a powertrain on the FTP, LLC, and SET to determine the FCV when the fuel cell current (FCC) is between 55 percent and 65 percent of rated FCC. Work is also measured during the second HDT in the FTP and used in the determination of the FCEV conversion factor (CF) value for credit generation in proposed 40 CFR 1037.616.

We request comment on our proposed approach to powertrain testing for BEVs and FCEVs, and specifically whether any modifications of the FTP, SET and LLC powertrain test cycles would be needed for BEVs and FCEVs. We further request comment on whether the MCT, as defined in proposed 40 CFR 1037.552, would require modifications to accurately measure work produced over the FTP cycle or the measure of UBE. We request comment on whether the procedure in proposed 40 CFR 1037.554 is appropriate for determining FCV. Finally, we request comment on if current 40 CFR 1036.527 should be used to determine rated FCC.

#### vi. Closed Crankcase

During combustion, gases can leak past the piston rings sealing the cylinder

and into the crankcase. These gases are called blowby gases and generally include unburned fuel and other combustion products. Blowby gases that escape from the crankcase are considered crankcase emissions (see 40 CFR 86.402–78). Current regulations restrict the discharge of crankcase emissions directly into the ambient air. Blowby gases from gasoline engine crankcases have been controlled for many years by sealing the crankcase and routing the gases into the intake air through a positive crankcase ventilation (PCV) valve. However, in the past there have been concerns about applying a similar technology for diesel engines. For example, high PM emissions venting into the intake system could foul turbocharger compressors. As a result of this concern, diesel-fueled and other compression-ignition engines equipped with turbochargers (or other equipment) were not required to have sealed crankcases (see 40 CFR 86.007–11(c)). For these engines, manufacturers are allowed to vent the crankcase emissions to ambient air as long as they are measured and added to the exhaust emissions during all emission testing to ensure compliance with the emission standards.

Because all new highway heavy-duty diesel engines on the market today are equipped with turbochargers, they are not required to have closed crankcases under the current regulations. Manufacturer compliance data indicate approximately one-third of current highway heavy-duty diesel engines have closed crankcases, indicating that some heavy-duty engine manufacturers have developed systems for controlling crankcase emissions that do not negatively impact the turbocharger. EPA is proposing provisions in 40 CFR 1036.115(a) to require a closed crankcase ventilation system for all highway compression-ignition engines to prevent crankcase emissions from being emitted directly to the atmosphere starting for MY 2027 engines.<sup>333</sup> These emissions could be routed upstream of the aftertreatment system or back into the intake system. Unlike many other standards, this standard is a design standard rather than a performance standard.

Our reasons for proposing a requirement for closed crankcases are twofold. While the exception in the current regulations for certain compression-ignition engines requires manufacturers to quantify their engines’

<sup>331</sup> See Section IV.I, proposed 40 CFR 1037.616, and proposed 40 CFR 1036.741 for details on the proposed NO<sub>x</sub> emission credits for BEVs and FCEVs. Briefly, manufacturers would generate vehicle emissions credits, which would then be fungible between vehicle and engine certification programs, such that NO<sub>x</sub> credits generated through the vehicle program could be applied to the proposed engine ABT program described in Section IV.G and specified in proposed 40 CFR 1036.705.

<sup>332</sup> The MCT for BEVs (specified in 40 CFR 1037.552) and FCEVs (specified in 40 CFR 1037.554) use the same foundational powertrain test procedures for the FTP, SET, and LLC test cycles; however, the MCT for BEVs includes additional iterations of the test cycles that are needed to deplete the battery and measure UBE, while the MCT for FCEVs includes the measurement of FCV, rather than UBE.

<sup>333</sup> We are proposing to move the current crankcase emissions provisions to a new paragraph (u) in the interim provisions of 40 CFR 1036.150, which would apply through model year 2026.

crankcase emissions during certification, they report non-methane hydrocarbons in lieu of total hydrocarbons. As a result, methane emissions from the crankcase are not quantified. Methane emissions from diesel-fueled engines are generally low; however, they are a concern for compression-ignition-certified natural gas-fueled heavy-duty engines because the blowby gases from these engines have a higher potential to include methane emissions. EPA proposed to require that all natural gas-fueled engines have closed crankcases in the Heavy-Duty Phase 2 GHG rulemaking, but opted to wait to finalize any updates to regulations in a future rulemaking, where we could then propose to apply these requirements to natural gas-fueled engines and to the diesel fueled engines that many of the natural gas-fueled engines are based off of (81 FR 73571, October 25, 2016).

In addition to our concern of unquantified methane emissions, we believe another benefit to closed crankcases would be better in-use durability. We know that the performance of piston seals reduces as the engine ages, which would allow more blowby gases and could increase crankcase emissions. While crankcase emissions are included in the durability tests that estimate an engine's deterioration, those tests were not designed to capture the deterioration of the crankcase. These unquantified age impacts continue throughout the operational life of the engine. Closing crankcases could be a means to ensure those emissions are addressed long-term to the same extent as other exhaust emissions.

Chapter 1.1.4 of the draft RIA describes EPA's recent test program to evaluate the emissions from open crankcase systems on two modern heavy-duty diesel engines. Results suggest THC and CO emitted from the crankcase can be a notable fraction of overall tailpipe emissions. By closing the crankcase, those emissions would be rerouted to the engine or aftertreatment system to ensure emission control.

### 3. Feasibility of the Diesel (Compression-Ignition) Engine Standards

#### i. Summary of Technologies Considered

Our proposed Options 1 and 2 standards for compression-ignition engines are based on the performance of technology packages described in Chapters 1 and 3 of the draft RIA for this rulemaking. Specifically, we are evaluating the performance of next-generation catalyst formulations in a

dual SCR catalyst configuration with a smaller SCR catalyst as the first substrate in the aftertreatment system for improved low-temperature performance, and a larger SCR catalyst downstream of the diesel particulate filter to improve NO<sub>x</sub> conversion efficiency during high power operation and to allow for passive regeneration of the particulate filter.<sup>334</sup> Additionally, the technology package includes CDA that reduces the number of active cylinders, resulting in increased exhaust temperatures for improved catalyst performance under light-load conditions and can be used to reduce fuel consumption and CO<sub>2</sub> emissions. The technology package also includes the use of a heated DEF injector for the upfront SCR catalyst; the heated DEF injector allows DEF injection at temperatures as low as approximately 140 °C. The heated DEF injector also improves the mixing of DEF and exhaust gas within a shorter distance than with unheated DEF injectors, which enables the aftertreatment system to be packaged in a smaller space. Finally, the technology package includes hardware needed to close the crankcase of diesel engines.

#### ii. Summary of Feasibility Analysis

##### a. Projected Technology Package Effectiveness and Cost

Based upon preliminary data from EPA's diesel demonstration research and the CARB Heavy-duty Low NO<sub>x</sub> Stage 3 Research Program (see Chapter 3.1.1.1 and Chapter 3.1.3.1 of the draft RIA), Heavy HDE NO<sub>x</sub> reductions of 90 percent from current NO<sub>x</sub> standards are technologically feasible when using CDA or other valvetrain-related air control strategies in combination with dual SCR systems. EPA has continued to evaluate aftertreatment system durability via accelerated aging of advanced emissions control systems as part of EPA's diesel engine demonstration program that is described in Chapter 3 of the draft RIA. In assessing the feasibility of our proposed standards, we have taken into consideration the proposed level of the standards, the additional emissions from infrequent regenerations, the proposed longer useful life, and lead time for manufacturers.

Manufacturers are required to design engines that meet the duty cycle and off-cycle standards throughout their useful life. In recognition that emissions performance will degrade over time, manufacturers design their engines to

perform significantly better than the standards when first sold to ensure that the emissions are below the standard throughout useful life even as the emissions controls deteriorate. As discussed below and in Chapter 3 of the draft RIA, manufacturer margins can range from less than 25 percent to 100 percent of the FEL. For Option 1, for Heavy HDEs that have the longest proposed useful life, we are proposing intermediate useful life standards that ensure that engines do not degrade in performance down to the duty cycle and off-cycle standards too quickly and allow for an intermediate check on emissions performance deterioration over the useful life.

To assess the feasibility of the proposed Option 1 MY 2031 standards for heavy HDE at the IUL of 435,000 miles, the data from the EPA Stage 3 engine was used. As discussed in Section III.B.2 the EPA Stage 3 engine includes improvements beyond the CARB Stage 3 engine, namely replacing the zone-coated catalyzed soot filter with a separate DOC and DPF and improving the mixing of the DEF with exhaust for the downstream SCR. These improvements lowered the emissions on the FTP, SET and LLC below what was measured with the CARB Stage 3 engine. The emissions for the EPA Stage 3 engine on the FTP, SET and LLC aged to an equivalent of 435,000 and 600,000 miles are shown in Table III-7 and Table III-8. To assess the feasibility of the proposed Option 1 NO<sub>x</sub> standards for MY 2027 and MY 2031 for Heavy HDE at the respective proposed Option 1 useful life periods, the data from the EPA Stage 3 engine was used. The data from the EPA Stage 3 engine was used because it included emission performance with the aftertreatment at the equivalent age of 435,000 and 600,000 miles. Having data at multiple points allowed us to use linear regression to project out the performance of the EPA Stage 3 engine at 800,000 miles.<sup>335</sup> To account for the IRAF for both particulate matter and sulfur on the aftertreatment system, we relied on an analysis by SwRI that is summarized in Chapter 3 of the draft RIA. In this analysis SwRI determined the IRAF at 2 mg/hp-hr for both the FTP and SET cycles and 5 mg/hp-hr for the LLC. Based on our analysis, the proposed Option 1 MY 2027 and MY 2031 emissions standards for Heavy HDE are feasible at the respective proposed useful life periods. To provide for additional margin, in our technology

<sup>334</sup> As described in Chapter 3 of the draft RIA, we are evaluating 3 different aftertreatment systems that contain different catalyst formulation.

<sup>335</sup> See Chapter 3.1.3 of the draft RIA for our analysis on projecting emissions performance beyond 600,000 miles.

cost analysis we increased the SCR catalyst volume from what was used on the EPA and CARB Stage 3 engine. The increase in total SCR catalyst volume relative to the EPA and CARB Stage 3 SCR was approximately 23.8 percent. We believe this further supports our conclusion that the proposed Option 1 standards are achievable for the proposed useful life of 800,000 miles for MY 2031 Heavy HDE. In addition to NO<sub>x</sub>, the proposed Option 1 HC and CO standards are feasible for CI engines on all three cycles. This is shown in Table III-7, where the demonstrated HC and CO emissions results are below the

proposed Option 1 standards discussed in Section III.B.2. The proposed Option 1 standards for PM of 5 mg/hp-hr for the FTP, SET and LLC, continue to be feasible with the additional technology and control strategies needed to meet the proposed Option 1 NO<sub>x</sub> standards, as seen by the PM emissions results in Table III-7 below. As discussed in Section III.B.2, taking into account measurement variability of the PM measurement test procedure, we believe that PM emissions from current diesel engines are at the lowest feasible level for MY 2027 and later engines. We request comment on whether 5 mg/hp-

hr provides enough margin for particular engine designs or for any of the duty cycles (FTP, SET, or LLC). For example, would 6 or 7 mg/hp-hr be a more appropriate standard for the LLC to maintain current PM emissions levels while providing enough margin to account for the measurement variability of the PM measurement test procedure. In addition, we request comment on if there are technologies that EPA could consider that would enable a PM standard lower than 5 mg/hp-hr. Commenters requesting a higher standard are encouraged to provide data supporting such comments.

TABLE III-7—STAGE 3 ENGINE EMISSIONS AT 435,000 MILE EQUIVALENT TEST POINT WITHOUT ADJUSTMENTS FOR IRAF

Duty cycle	NO <sub>x</sub> (mg/hp-hr)	PM (mg/hp-hr)	NMHC (mg/hp-hr)	CO (g/hp-hr)	CO <sub>2</sub> (g/hp-hr)	N <sub>2</sub> O (g/hp-hr)
FTP .....	20	2	12	0.141	514	0.076
SET <sup>a</sup> .....	17	1	1	0.030	455	0.024
LLC .....	29	3	35	0.245	617	0.132

<sup>a</sup> Using the weighting factors in our proposed test procedures (40 CFR 1036.505).

TABLE III-8—STAGE 3 ENGINE EMISSIONS AT 600,000 MILE EQUIVALENT TEST POINT WITHOUT ADJUSTMENTS FOR IRAF

Duty cycle	NO <sub>x</sub> (mg/hp-hr)	PM (mg/hp-hr)	NMHC (mg/hp-hr)	CO (g/hp-hr)	CO <sub>2</sub> (g/hp-hr)	N <sub>2</sub> O (g/hp-hr)
FTP .....	27	1	9	0.144	519	0.058
SET <sup>a</sup> .....	24	1	1	0.015	460	0.030
LLC .....	33	4	16	0.153	623	0.064

<sup>a</sup> Using the weighting factors in our proposed test procedures (40 CFR 1036.505).

As additional data is received from the EPA led demonstration project, the demonstration data will inform whether the proposed Option 1 IUL standards for MY 2031 are needed. For example, if the demonstration data shows much lower emissions for the first half of useful life than for the second half of useful life, then this would confirm our assumption that the proposed Option 1 IUL standard would ensure that the emission reductions during the earlier portion of an engine's useful life are achieved, while preserving sufficient margin for deterioration during the second half of useful life. On the other hand, if we find that the emissions values are relatively constant through useful life, this may support that an IUL standard may not be needed. This data will also inform whether the proposed Option 1 IUL standard of 20 mg/hp-hr at 435,000 miles is appropriate for Heavy HDE in MY 2031 and whether an IUL standard is also needed for MY 2027 to account for deterioration out to the proposed Option 1 600,000-mile useful life for MY 2027.

Our analysis also shows that the proposed Option 2 standards could be met starting in MY 2027 with CDA and dual-SCR with heated dosing (see draft RIA Chapter 3 for details of our analysis) as shown in Table III-7. The proposed Option 2 includes a higher (less stringent) NO<sub>x</sub> emission level for all CI engine classes over the FTP and SET compared to either step of our proposed Option 1 NO<sub>x</sub> FTP and SET standards. The FTP and SET standards in proposed Option 2 for PM, HC, and CO are numerically equivalent to our proposed Option 1 MY 2031 standards. As shown in Table III-7, we currently have data demonstrating that the proposed Option 2 standards could be met out to 600,000 miles. These data show the proposed Option 2 standards are feasible through the proposed Option 2 useful life periods for Light HDE, Medium HDEs. Our evaluation of the current data suggests that the proposed Option 2 standards would also be feasible out to the proposed Option 2 Heavy HDE useful life; we are continuing to collect data to confirm our extrapolation of data out to the longer

useful life mileage. As discussed in Section IV.A, useful life mileages for proposed Option 2 are higher than our MY 2027 proposed useful life, but lower than our proposed Option 2 useful life values for MY 2031.

In addition to evaluating the feasibility of the new criteria pollutant standards, we also evaluated how CO<sub>2</sub> was impacted on the CARB Stage 3 engine. To do this we evaluated how CO<sub>2</sub> emissions changed from the base engine on the FTP, SET, and LLC, as well as the fuel mapping test procedures defined in 40 CFR 1036.535 and 1036.540. For all three cycles the Stage 3 engine emitted CO<sub>2</sub> with no measurable difference compared to the base 2017 Cummins X15 engine. Specifically, we compared the CARB Stage 3 engine including the 0-hour (degreened) aftertreatment with the 2017 Cummins X15 engine including degreened aftertreatment and found the percent reduction in CO<sub>2</sub> for the FTP, SET and LLC, was 1, 0 and 1 percent

respectively.<sup>336</sup> We note that after this data was taken SwRI made changes to the thermal management strategies of the CARB Stage 3 engine to improve NO<sub>x</sub> reduction at low SCR temperatures. The data from the EPA Stage 3 engine at the equivalent age of 435,000 miles includes these calibration changes, and although there was an increase in CO<sub>2</sub>, which resulted in the CO<sub>2</sub> emissions for the EPA Stage 3 engine being higher than the 2017 Cummins X15 engine for the FTP, SET and LLC of 0.6, 0.7 and 1.3 percent respectively, this was not a direct comparison because the 2017 Cummins X15 aftertreatment had not been aged to an equivalent of 435,000 miles. As discussed in Chapter 3 of the draft RIA, aging the EPA Stage 3 engine included exposing the aftertreatment to ash, that increased the back pressure on the engine, which contributed to the increase in CO<sub>2</sub> emissions from the EPA Stage 3. To evaluate how the technology on the CARB Stage 3 engine compares to the 2017 Cummins X15 with respect to the HD GHG Phase 2 vehicle CO<sub>2</sub> standards, both engines were tested on the fuel mapping test procedures defined in 40 CFR 1036.535 and 1036.540. These test procedures define how to collect the fuel consumption data from the engine for use in GEM. For these tests the CARB Stage 3 engine was tested with the development aged aftertreatment.<sup>337</sup> The fuel maps from these tests were run in GEM and the results from this analysis showed that the Stage 3 engine emitted CO<sub>2</sub> at the same rate as the 2017 Cummins X15. The details of this analysis are described in Chapter 3.1 of the draft RIA. The technologies included in the EPA

demonstration engine were selected to both demonstrate the lowest criteria pollutant emissions and have a negligible effect on GHG emissions. Manufacturers may choose to use other technologies to meet the proposed standards, but manufacturers will still also need to comply with the GHG standards that apply under HD GHG Phase 2.<sup>338</sup> Because of this we have not projected an increase in GHG emissions resulting from compliance with the proposed standards.

Table III–9 summarizes the incremental technology costs for the proposed Options 1 and 2 standards, from the baseline costs shown in Table III–13. While the standards vary between the proposed Option 1 and the proposed Option 2 standards, we are evaluating the same technologies to assess the feasibility of the two sets of standards. These values include aftertreatment system and CDA costs. The details of this analysis can be found in Chapter 3 of the draft RIA. Differences in the useful life and warranty periods between the proposed Options 1 and 2 are accounted for in the indirect costs as discussed in Chapter 7.1.2 of the draft RIA.<sup>339</sup>

TABLE III–9—INCREMENTAL DIRECT MANUFACTURING COST OF PROPOSED OPTIONS 1 AND 2 STANDARDS FOR THE AFTERTREATMENT AND CDA TECHNOLOGY

[2019 \$]

Light HDE	Medium HDE	Heavy HDE	Urban bus
\$1,685 ...	\$1,648	\$2,266	\$1,684

As described in Chapter 3.1 of the draft RIA, we have estimated the incremental technology cost for closed crankcase filtration systems for all CI engines to be \$37 (2017 \$), noting that these technologies are on some engines available in the market today.

b. Baseline Emissions and Cost

The basis for our baseline technology assessment is the data provided by manufacturers in the heavy-duty in-use testing program. This data encompasses in-use operation from nearly 300 LHD, MHD, and HHD vehicles. Chapter 5 of the draft RIA describes how the data was used to update the MOVES model emissions rates for HD diesel engines. Chapter 3 of the draft RIA summarizes the in-use emissions performance of these engines.

We also evaluated the certification data submitted to the agency. The data includes test results adjusted for IRAF and FEL that includes adjustments for deterioration and margin. The certification data, summarized in Table III–10, shows that manufacturers vary in their approach to how much margin is built into the FEL. Some manufacturers have greater than 100 percent margin built into the FEL, while other manufacturers have less than 25 percent.

TABLE III–10—SUMMARY OF CERTIFICATION DATA FOR FTP CYCLE

	NO <sub>x</sub> (g/hp-hr)	PM (g/hp-hr)	NMHC (g/hp-hr)	CO (g/hp-hr)	N <sub>2</sub> O (g/hp-hr)
Average .....	0.13	0.00	0.01	0.18	0.07
Minimum .....	0.05	0.00	0.00	0.00	0.04
Maximum .....	0.18	0.00	0.04	1.10	0.11

TABLE III–11—SUMMARY OF CERTIFICATION DATA FOR SET CYCLE

	NO <sub>x</sub> (g/hp-hr)	PM (g/hp-hr)	NMHC (g/hp-hr)	CO (g/hp-hr)	N <sub>2</sub> O (g/hp-hr)
Average .....	0.11	0.00	0.01	0.00	0.06
Minimum .....	0.00	0.00	0.00	0.00	0.00
Maximum .....	0.18	0.00	0.04	0.20	0.11

<sup>336</sup> See Chapter 3 of the draft RIA for the CO<sub>2</sub> emissions of the 2017 Cummins X15 engine and the CARB Stage 3 engine.

<sup>337</sup> The CARB Stage 3 0 hour (degreased) aftertreatment could not be used for these tests,

because it had already been aged past the 0 hour point when these tests were conducted.

<sup>338</sup> As explained in Section XI, EPA is also proposing targeted updates to the Phase 2 Heavy-Duty Greenhouse Gas Emissions program.

<sup>339</sup> See Table III–3 for the proposed useful life values and Section IV.B.1 for the proposed emissions warranty periods for each option.



In addition to analyzing the on-cycle certification data submitted by manufacturers, we tested three modern HD diesel engines on an engine dynamometer and analyzed the data. These engines were a 2018 Cummins B6.7, 2018 Detroit DD15 and 2018

Navistar A26. These engines were tested on cycles that range in power demand from the creep mode of the Heavy Heavy-Duty Diesel Truck (HHDDT) schedule to the HD SET cycle defined in 40 CFR 1036.505. Table III–12 summarizes the range of results from

these engines on the FTP, SET and LLC. As described in Chapter 3 of the draft RIA, the emissions of current production Heavy-Duty engines vary from engine to engine but the largest difference in NO<sub>x</sub> between engines is seen on the LLC.

TABLE III–12—RANGE OF NO<sub>x</sub> EMISSIONS FROM MY2017 TO MY2019 HEAVY-DUTY DIESEL ENGINES

NO <sub>x</sub> (g/hp-hr)	FTP composite	SET in 40 CFR 86.1333	SET in 40 CFR 1036.505	LLC
Minimum .....	0.10	0.01	0.01	0.35
Maximum .....	0.15	0.12	0.05	0.81
Average .....	0.13	0.06	0.03	0.59

Table III–13 summarizes the baseline sales-weighted total aftertreatment cost of Light HDE, Medium HDE, Heavy HDE and urban bus engines. The details of this analysis can be found in Chapter 3 of the draft RIA.

TABLE III–13—BASELINE DIRECT MANUFACTURING AFTERTREATMENT COST  
[2019 \$]

Light HDE	Medium HDE	Heavy HDE	Urban bus
\$ 2,804 ..	\$ 2,877	\$ 4,587	\$ 2,929

4. Potential Alternative

We evaluated one alternative (the Alternative) to our proposed HD CI exhaust emission standards (summarized in Table III–14, Table III–15, and Table III–16). As discussed in this section and based on information we have collected to date, we do not project that the Alternative standards are feasible in the MY 2027 timeframe with the technology we have evaluated (Table III–9).

The Alternative we considered includes lower (more stringent) numeric NO<sub>x</sub> emission levels for Heavy HDEs, and lower HC emission levels for all CI

engine classes, combined with longer useful life periods and shorter lead time compared to the proposed Option 1 MY 2031 standards. As shown in Table III–7, the test data we currently have from the EPA Stage 3 engine is not sufficient to conclude that the Alternative standards would be feasible in the MY 2027 timeframe. Specifically, our data suggest that the numeric level of the FTP and SET NO<sub>x</sub> emission standards would be very challenging to meet through 435,000 miles (see draft RIA Chapter 3.1). For Light HDEs and Medium HDEs, these data suggest that to meet the combination of numeric levels of the NO<sub>x</sub> emission standards and useful life periods of the Alternative, it may be appropriate for EPA to consider providing manufacturers with additional lead time, beyond the MY 2027 implementation date of the Alternative. For Heavy HDEs, our extrapolation of the data from 600,000 miles through the 850,000 miles useful life period of the Alternative suggests that the numeric level of the NO<sub>x</sub> emission control in the Alternative could not be maintained through the Alternative useful life period (see draft RIA Chapter 3.1 for details on available data and our evaluation). Wholly different emission

control technologies than we have evaluated to date (*i.e.*, not based on CDA and a dual SCR) would be needed to meet the Alternative standards for Heavy HDEs; we request comment on this conclusion and on the availability, or potential development and timeline, of such additional technologies. We also note that the Alternative is significantly more stringent than the CARB Omnibus because of the combination of numeric level of the NO<sub>x</sub> emission standards and useful life periods in the Alternative compared to the CARB Omnibus. Specifically, for heavy HDEs, the Alternative includes a 20 mg/hp-hr standard at a useful life of 850,000 miles, whereas for MYs 2027 through 2030 the CARB Omnibus includes a 20 mg/hp-hr standard at 435,000 miles and a 35 mg/hp-hr standard at 600,000 miles for heavy HDEs. Thus, the heavy HDE useful life period of the Alternative is substantially longer than the CARB Omnibus useful life periods that start in MY 2027, particularly when comparing the useful life period for the 20 mg/hp-hr standard. Starting in MY 2031, the CARB Omnibus NO<sub>x</sub> standard for heavy HDEs is 40 mg/hp-hr at a useful life of 800,000 miles, which is again a higher numeric level of the standard at a shorter useful life than the Alternative.

TABLE III–14—PROPOSED AND ALTERNATIVE COMPRESSION-IGNITION ENGINE STANDARDS FOR THE FTP TEST PROCEDURE

	Model year	Primary intended service class	NO <sub>x</sub> (mg/hp-hr)	PM (mg/hp-hr)	HC (mg/hp-hr)	CO (g/hp-hr)
Proposed Option 1 ..	2027–2030 .....	All HD Engines .....	35	5	60	6.0
	2031 and later .....	Light HDE and Medium HDE .....	20	5	40	6.0
	2031 and later .....	Heavy HDE .....	40 <sup>a</sup>	5	40	6.0
Proposed Option 2 ..	2027 and later .....	All HD Engines .....	50	5	40	6.0
	Alternative .....	2027 and later .....	All HD Engines .....	20	5	10

<sup>a</sup> Proposed Option 1 MY 2031 and later IUL NO<sub>x</sub> standard for Heavy HDE is 20 mg/hp-hr.

TABLE III-15—PROPOSED AND ALTERNATIVE COMPRESSION-IGNITION ENGINE STANDARDS FOR THE SET TEST PROCEDURE

	Model year	Primary intended service class	NO <sub>x</sub> (mg/hp-hr)	PM (mg/hp-hr)	HC (mg/hp-hr)	CO (g/hp-hr)
Proposed Option 1 ..	2027–2030 .....	All HD Engines .....	35	5	60	6.0
	2031 and later .....	Light HDE and Medium HDE .....	20	5	40	6.0
	2031 and later .....	Heavy HDE .....	<sup>a</sup> 40	5	40	6.0
Proposed Option 2 ..	2027 and later .....	All HD Engines .....	50	5	40	6.0
	Alternative .....	2027 and later .....	All HD Engines .....	20	5	10

<sup>a</sup>Proposed Option 1 MY 2031 and later IUL NO<sub>x</sub> standard for Heavy HDE is 20 mg/hp-hr.

TABLE III-16—PROPOSED AND ALTERNATIVE COMPRESSION-IGNITION ENGINE STANDARDS FOR THE LLC TEST PROCEDURE

	Model year	Primary intended service class	NO <sub>x</sub> (mg/hp-hr)	PM (mg/hp-hr)	HC (mg/hp-hr)	CO (g/hp-hr)
Proposed Option 1 ..	2027–2030 .....	All HD Engines .....	90	5	140	6.0
	2031 and later .....	Light HDE and Medium HDE .....	50	5	60	6.0
	2031 and later .....	Heavy HDE .....	<sup>a</sup> 100	5	60	6.0
Proposed Option 2 ..	2027 and later .....	All HD Engines .....	100	5	60	6.0
	Alternative .....	2027 and later .....	All HD Engines .....	100	5	60

<sup>a</sup>Proposed Option 1 MY 2031 and later IUL NO<sub>x</sub> standard for Heavy HDE is 50 mg/hp-hr.

For the optional idle NO<sub>x</sub> standard, the Alternative includes a standard of 10.0 g/hr for MY 2027 and beyond. The proposed Options 1 and 2 standards generally represent the range of options, including the standards, regulatory useful life and emission-related warranty periods and lead time provided, that we are currently considering in this rule, depending in part on any additional information we receive on the feasibility, costs, and other impacts of the proposed Options 1 and 2 standards. In order to consider adopting the Alternative in the final rule, we would need additional data to project that the Alternative is feasible for the MY 2027 time frame. As discussed in Section III.B.5, we are soliciting comment on the feasibility of the Alternative and other alternatives outside the range of options covered by the proposed Options 1 and 2 standards.

5. Summary of Requests for Comment on the Stringency of the CI Duty Cycle Standards

We request comment on the following items related to the proposed CI duty cycle standards. First, we request comment on the numeric value of each proposed, or alternative, standard for each duty cycle and off-cycle emissions and the proposed Option 1 two step, or the proposed Option 2 one step, approach and implementation timetable, as well as other standards or approaches recommended by the commenter, within the approximate range of the proposed Options 1 and 2 standards. We request comment,

including relevant data and other information, on the feasibility of the implementation model year, numeric levels of the emission standards, and useful life and warranty periods included in the Alternative, or other alternatives outside the range of options covered by the proposed Options 1 and 2 standards. We request comment on if a margin between the demonstrated emissions performance and the proposed standards should be included and if so, we request comment on if a specific margin should be used and what that value should be. Commenters requesting a specific margin are encouraged to provide data and analysis to support the numeric value of the margin(s).

We request comment on whether a lower numeric standard for NO<sub>x</sub> should be set for the LLC based on the emission levels achieved with the CARB Stage 3 engine or EPA Stage 3 engine. We request comment on whether EPA should make the idle standards mandatory for MY 2027 and beyond. We request comment on whether the test procedures defined in 40 CFR 1036.522 for IRAF should be applied to the LLC or if alternative procedures should be considered. We request comment on whether the proposed PM standards of 5 mg/hp-hr for the FTP, SET and LLC provide enough margin to account for the measurement variability of the PM measurement test procedure, while ensuring that the PM emissions from HD CI engines do not increase. We are requesting comment on whether we

should include HEV, BEV, and/or FCEV technologies in our feasibility analysis for the final rule.

As discussed in Section III.B.2.v, EPA requests comment on the proposed powertrain test procedure, including any additional requirements that are needed to ensure that the engine and respective powertrain cycles are equivalent. We request comment on other improvements that could be made specifically to make the idle accessory load more representative for powertrains that include a transmission as part of the certified configuration. EPA requests comment on whether the powertrain test procedure option is needed for specific non-hybrid powertrains where the engine test procedure is not representative of in-use operation of the powertrain in a vehicle, and if so how should we define these powertrains so that the powertrain test option is only available for these powertrains. We request comment on our proposed approach to powertrain testing for BEVs and FCEVs, and specifically whether any modifications of the FTP, SET and LLC powertrain test cycles would be needed for BEVs and FCEVs. We further request comment on whether the MCT as defined in 40 CFR 1037.552 would require modifications to accurately measure work produced over the FTP cycle or the measure of useable battery energy (UBE). We request comment on whether the procedure in 40 CFR 1037.554 is appropriate for determining fuel cell voltage (FCV). In addition, we request

comment on if 40 CFR 1036.527 should be used to determine rated FCC.

Finally, we request comment on whether the standards should be expressed in units of milligrams per kilowatt-hour, so that each value of the standards is in the international system of units (SI units), as we have done for the HD nonroad and locomotive standards.

### C. Summary of Compression-Ignition Off-Cycle Standards and In-Use Test Procedures

#### 1. Current NTE Standards and Need for Changes to Off-Cycle Test Procedures

Heavy-duty CI engines are currently subject to Not-To-Exceed (NTE) standards that are not limited to specific test cycles, which means they can be evaluated not only in the laboratory but also in-use. NTE standards and test procedures are generally referred to as “off-cycle” standards and test procedures. These off-cycle emission limits are 1.5 (1.25 for CO) times the laboratory certification standard or family emission limit (FEL) for NO<sub>x</sub>, HC, PM and CO and can be found in 40 CFR 86.007–11. NTE standards have been successful in broadening the types of operation for which manufacturers design their emission controls to remain effective, including steady cruise operation. However, there remains significant operation not covered by NTE standards.

Compliance with an NTE standard is based on emission test data (whether collected in a laboratory or in use) analyzed pursuant to 40 CFR 86.1370 to identify NTE events, which are intervals of at least 30 seconds when engine speeds and loads remain in the NTE control area or “NTE zone”. The NTE zone excludes engine operation that falls below certain torque, power, and speed values.<sup>340</sup> The NTE procedure also excludes engine operation that occurs in certain ambient conditions (*i.e.*, high altitudes, high intake manifold humidity), or when aftertreatment temperatures are below 250°C. Collected data is considered a valid NTE event if it occurs within the NTE zone, lasts at least 30 seconds, and does not occur during any of the exclusion conditions (ambient conditions, or aftertreatment temperature).

The purpose of the NTE test procedure is to measure emissions during engine operation conditions that could reasonably be expected to occur

<sup>340</sup> Specifically, engine operations are excluded if they fall below 30 percent of maximum torque, 30 percent of maximum power, or 15 percent of the European Stationary Cycle speed.

during normal vehicle use; however, only data in a valid NTE event is then compared to the NTE emission standard. Our analysis of existing heavy-duty in-use vehicle test data indicates that less than ten percent of a typical time-based dataset are part of valid NTE events, and hence subject to the NTE standards; the remaining test data are excluded from consideration. We also found that emissions are high during many of the excluded periods of operation, such as when the aftertreatment temperature drops below the 250°C exclusion criterion. Our review of in-use data indicates that extended time at low load and idle operation results in low aftertreatment temperatures, which in turn lead to diesel engine SCR-based emission control systems not functioning over a significant fraction of real-world operation.<sup>341 342 343</sup> Test data collected as part of EPA’s manufacturer-run in-use testing program indicate that low-load operation could account for greater than 50 percent of the NO<sub>x</sub> emissions from a vehicle over a given workday.<sup>344</sup>

For example, 96 percent of tests in response to 2014, 2015, and 2016 EPA in-use testing orders passed with NO<sub>x</sub> emissions for valid NTE events well below the 0.3 g/hp-hr NO<sub>x</sub> NTE standard. When we used the same data to calculate NO<sub>x</sub> emissions over all operation measured, not limited to valid NTE events, the NO<sub>x</sub> emissions were more than double those within the valid NTE events (0.5 g/hp-hr).<sup>345</sup> The results were even higher when we analyzed the data to consider only NO<sub>x</sub> emissions that occur during low load events.

EPA and others have compared the performance of US-certified engines and those certified to European Union emission standards and concluded that the European engines’ NO<sub>x</sub> emissions are lower in low-load conditions, but

<sup>341</sup> Hamady, Fakhri, Duncan, Alan. “A Comprehensive Study of Manufacturers In-Use Testing Data Collected from Heavy-Duty Diesel Engines Using Portable Emissions Measurement System (PEMS)”. 29th CRC Real World Emissions Workshop, March 10–13, 2019.

<sup>342</sup> Sandhu, Gurdas, et al. “Identifying Areas of High NO<sub>x</sub> Operation in Heavy-Duty Vehicles”. 28th CRC Real-World Emissions Workshop, March 18–21, 2018.

<sup>343</sup> Sandhu, Gurdas, et al. “In-Use Emission Rates for MY 2010+ Heavy-Duty Diesel Vehicles”. 27th CRC Real-World Emissions Workshop, March 26–29, 2017.

<sup>344</sup> Sandhu, Gurdas, et al. “Identifying Areas of High NO<sub>x</sub> Operation in Heavy-Duty Vehicles”. 28th CRC Real-World Emissions Workshop, March 18–21, 2018.

<sup>345</sup> Hamady, Fakhri, Duncan, Alan. “A Comprehensive Study of Manufacturers In-Use Testing Data Collected from Heavy-Duty Diesel Engines Using Portable Emissions Measurement System (PEMS)”. 29th CRC Real World Emissions Workshop, March 10–13, 2019.

comparable to US-certified engines subject to MY 2010 standards under city and highway operation.<sup>346</sup> This suggests that manufacturers are responding to the European certification standards by designing their emission controls to perform well under low-load operations, as well as highway operations.

The European Union “Euro VI” emission standards for heavy-duty engines require manufacturers to check for “in-service conformity” by operating their engines over a mix of urban, rural, and motorway driving on prescribed routes using portable emission measurement system (PEMS) equipment to measure emissions.<sup>347 348</sup> Compliance is determined using a work-based windows approach where emissions data are evaluated over segments or “windows.” A window consists of consecutive 1 Hz data points that are summed until the engine performs an amount of work equivalent to the European transient engine test cycle (World Harmonized Transient Cycle).

EPA is proposing an approach similar to the European in-use program, with key distinctions that build upon the Euro VI approach, as discussed below.

#### 2. Proposed Off-Cycle Standards and Test Procedures

As described in Section III.C.1, our current NTE test procedures were not designed to capture low-load operation. We are proposing to replace the NTE test procedures and standards (for NO<sub>x</sub>, PM, HC and CO) for model year 2027 and later engines. Engine operation and emissions test data would be assessed in 300-second moving average windows (MAWs) of continuous engine operation.<sup>349</sup> In contrast to the current NTE approach that divides engine operation into two categories (in the NTE zone and out of the NTE zone), the proposed approach would divide engine operation into three categories (or “bins”) based on the time-weighted average engine power of each MAW of

<sup>346</sup> Rodriguez, F.; Posada, F. “Future Heavy-Duty Emission Standards An Opportunity for International Harmonization”. The International Council on Clean Transportation. November 2019. Available online: [https://theicct.org/sites/default/files/publications/Future%20HDV\\_standards\\_opportunity\\_20191125.pdf](https://theicct.org/sites/default/files/publications/Future%20HDV_standards_opportunity_20191125.pdf).

<sup>347</sup> COMMISSION REGULATION (EU) No 582/2011, May 25, 2011. Available online: <https://eur-lex.europa.eu/legal-content/EN/TXT/PDF/?uri=CELEX:02011R0582-20180118&from=EN>.

<sup>348</sup> COMMISSION REGULATION (EU) 2018/932, June 29, 2018. Available online: <https://eur-lex.europa.eu/legal-content/EN/TXT/PDF/?uri=CELEX:32018R0932&from=EN>.

<sup>349</sup> Our evaluation includes our current understanding that shorter windows are more sensitive to measurement variability and longer windows make it difficult to distinguish between duty cycles.

engine data as described in more detail below.

Although the proposed program has similarities to the European approach, we are not proposing to limit our standards to operation on prescribed routes. Our current NTE program is not limited to prescribed routes and we would consider it an unnecessary step backward to change that aspect of the procedure.

In Section IV.G, we discuss our proposed updates to the ABT program to account for our proposal of unique off-cycle standards.

#### i. Bins

We are proposing two options of off-cycle standards for three bins of operation that cover the range of operation included in the duty cycle test procedures and operation that is outside of the duty cycle test procedures for each regulated pollutant (NO<sub>x</sub>, HC, CO, and PM). The three bins represent three different domains of emission performance. The idle bin represents extended idle operation and other very low load operation where engine exhaust temperatures may drop below the optimal temperature for aftertreatment function. The medium/high load bin represents higher power operation including much of the operation currently covered by the NTE. Operation in the medium/high load bin naturally involves higher exhaust temperatures and catalyst efficiencies. The low load bin represents intermediate operation and could include a large fraction of urban driving. Because the proposed approach divides 300 second windows into bins based on time-averaged engine power of the window, any of the bins could include some idle or high power operation. Like the duty cycle standards, we believe that more than a single standard is needed to apply to the entire range of operation that heavy-duty engines experience. A numerical standard that would be technologically feasible under worst case conditions such as idle would necessarily be much higher than the levels that are achievable when the aftertreatment is functioning optimally. Similarly, since the low load bin will consist of operation either between the idle and medium/high load bins or be an average of the operation in the two bins, the work specific emissions of the low load bin will generally be lower than the idle bin and higher than the

medium/high load bin. Section III.C.2.iii includes the proposed Options 1 and 2 off-cycle standards.

Given the challenges of measuring engine power directly in-use, we are proposing to use the CO<sub>2</sub> emission rate (grams per second) as a surrogate for engine power in defining the bins for an engine. We are further proposing to normalize CO<sub>2</sub> emission rates relative to the nominal maximum CO<sub>2</sub> rate of the engine. So, if an engine with a maximum CO<sub>2</sub> emission rate of 50 g/sec was found to be emitting CO<sub>2</sub> at a rate of 10 g/sec, its normalized CO<sub>2</sub> emission rate would be 20 percent. We are proposing that the maximum CO<sub>2</sub> rate be defined as the engine's rated maximum power multiplied by the engine's family certification level (FCL) for the FTP certification cycle. We request comment on whether the maximum CO<sub>2</sub> mass emission rate should instead be determined from the steady-state fuel mapping procedure in 40 CFR 1036.535 or the torque mapping procedure defined in 40 CFR 1065.510. We propose the bins to be defined as follows:

- *Idle bin*: 300 second windows with normalized average CO<sub>2</sub> rate ≤ 6 percent
- *Low-load bin*: 300 second windows with normalized average CO<sub>2</sub> rate > 6 percent and ≤ 20 percent
- *Medium/high-load bin*: 300 second windows with normalized average CO<sub>2</sub> rate > 20 percent

The proposed bin cut points of six and twenty percent are near the average power of the proposed low-load cycle and the FTP, respectively. We request comment on whether the cut points should be defined at different power levels or if other metrics should be used to define the bins. We also request comment on whether it would be more appropriate to divide in-use operation into two bins rather than three bins and, if so, what the cut point should be.

To ensure that there is adequate data in each of the bins to compare to the off-cycle standards, we are proposing a minimum of 2,400 moving average windows per bin. We are proposing that if during the first shift day each of the bins does not include at least 2,400 windows, then the engine would need to be tested for additional day(s) until the minimum requirement is met. We are also proposing that the engine can be idled at the end of the shift-day to meet the minimum window count

requirement for the idle bin. This is to ensure that even for duty cycles that do not include significant idle operation the minimum window count requirement for the idle bin can be met without testing additional days. We request comment on whether 2,400 windows is the appropriate minimum to sufficiently reduce variability in the results while not requiring an unnecessary number of shift-days to be tested to meet the requirement.

#### ii. Off-Cycle Test Procedures

We are proposing to measure off-cycle emissions using the existing test procedures that specify measurement equipment and the process of measuring emissions during field testing in 40 CFR part 1065. We are proposing in part 1036 subpart F the process for recruiting test vehicles, how to test over the shift-day, how to evaluate the data, what constitutes a valid test, and how to determine if an engine family passes. Measurements may use either the general laboratory test procedures in 40 CFR 1065, or the field test procedures in 40 CFR part 1065, subpart J. However, we are proposing special calculations for low load and medium/high load bins in 40 CFR 1036.515 that would supersede the brake-specific emission calculations in 40 CFR part 1065. The proposed test procedures would require second-by-second measurement of the following parameters:

- Molar concentration of CO<sub>2</sub> (ppm)
- Molar concentration of NO<sub>x</sub> (ppm)
- Molar concentration of HC (ppm)
- Molar concentration of CO (ppm)
- Concentration of PM (g/m<sup>3</sup>)
- Exhaust flow rate (m<sup>3</sup>/s)

Mass emissions of CO<sub>2</sub> and each regulated pollutant would be separately determined for each 300-second window and would be binned based on the normalized CO<sub>2</sub> rate for each window.

The standards described in Section III.C.2.iii are expressed in units of g/hr for the idle bin and g/hp-hr for the low and medium/high load bins. However, unlike most of our exhaust standards, the hp-hr values for the off-cycle standards do not refer to actual brake work. Rather, they refer to nominal equivalent work calculated proportional to the CO<sub>2</sub> emission rate. Thus, we are proposing in 40 CFR 1036.515 that the NO<sub>x</sub> emissions ("e") in g/hp-hr would be calculated as:

$$e \left( \frac{g}{hp \cdot hr} \right) = \frac{\text{Sum of Window NO}_x \text{ mass per Bin}}{\text{Sum of Window CO}_2 \text{ mass per Bin}} \cdot \frac{\text{FTP CO}_2 \text{ mass}}{\text{FTP work}}$$

We are proposing a limited number of exclusions that would exclude some data from being subject to the off-cycle standards. The first exclusion is for data collected during periodic PEMS zero and span drift checks or calibrations, where the emission analyzers are not available to measure emissions during that time and these checks/calibrations are needed to ensure the robustness of the data. Data would also be excluded anytime the engine is off during the course of the shift-day, including engine off due to automated start/stop, as no exhaust emissions are being generated by the engine while it is not operating. We are also proposing to exclude data when ambient temperatures are below -7 °C, or when ambient temperatures are above the altitude-based value determined using Equation 40 CFR 1036.515-1. The colder temperatures can significantly inhibit the engine's ability to maintain aftertreatment temperature above the minimum operating temperature of the SCR catalyst while the higher temperature conditions at altitude can limit the mass airflow through the engine, which can adversely affect the engine's ability to reduce engine out NO<sub>x</sub> through the use of exhaust gas recirculation (EGR). In addition to affecting EGR, the air-fuel ratio of the engine can decrease under high load, which can increase exhaust temperatures above the conditions where the SCR catalyst is most efficient at reducing NO<sub>x</sub>. Data would also be excluded for operation at altitudes greater than 5,500 feet above sea level for the same reasons as for high temperatures at altitude. We would also exclude data when any approved Auxiliary Emission Control Device (AECD) for emergency vehicles are active because the engines are allowed to exceed the emission standards while these AECDs are active. Data collected

during infrequent regeneration events would also be excluded due to the fact that the data collected may not include enough operation during the infrequent regeneration to properly weight the emissions rates during an infrequent regeneration event with emissions that occur without an infrequent regeneration event. We request comment on the appropriateness of these exclusions and whether other exclusions should be included. We request comment on whether emissions during infrequent regeneration should be included in determining compliance with the proposed off-cycle standards and if so, how these emissions should be included such that the emissions are properly weighted with the emissions when infrequent regenerations are not occurring. While data is excluded when any approved ACEDs for emergency vehicles are active, data generated while other approved ACEDs are active may not be excluded from the emissions calculations under the proposed 40 CFR 1036.515.

To reduce the influence of environmental conditions on the accuracy and precision of the PEMS, we are proposing additional requirements in 40 CFR 1065.910(b). These requirements are to minimize the influence of temperature, pressure, electromagnetic frequency, shock, and vibration on the emissions measurement. If the design of the PEMS or the installation of the PEMS does not minimize the influence of these environmental conditions the PEMS must be installed in an environmental chamber during the off-cycle test.

iii. Off-Cycle Standards

For NO<sub>x</sub> and HC, we are proposing separate standards for distinct modes of operation. To ensure that the proposed duty-cycle NO<sub>x</sub> standards and the proposed off-cycle NO<sub>x</sub> standards are

set at the same relative stringency level for each option, the idle bin standard is proportional to the voluntary Idle standard discussed in Section III.B.2.iv, the low load bin standard is proportional to the proposed LLC standard discussed in Section III.B.2.iii and the medium/high load bin standard is proportional to the proposed SET standard discussed in Section III.B.2.ii. For HC for each option the proposed low load bin standards are set at values proportional to the LLC standard and the medium/high load bin standard is proportional to the SET proposed standard. For PM and CO for each option the standards for the FTP, SET and LLC are the same numeric value, so the low load and medium/high load bin have the same standards. The proposed Options 1 and 2 off-cycle standards for the low load and medium/high load bin are shown in Table III-17. For the idle bin, the proposed Option 1 NO<sub>x</sub> emission standard for all CI primary intended service classes is 10.0 g/hr starting in model years 2027 through 2030 and 7.5 g/hr starting in model year 2031. For proposed Option 2, the idle bin NO<sub>x</sub> standard for all CI primary intended service classes is 15.0 g/hr starting in model year 2027. For PM, HC and CO we are not proposing standards for the idle bin because the emissions from these pollutants are very small under idle conditions and idle operation is extensively covered by the FTP, SET and LLC duty cycles discussed in Section III.B.2. We request comment on appropriate scaling factors or other approaches to setting off-cycle standards. Finally, we request comment on whether there is a continued need for measurement allowances in an in-use program such as described below. A discussion of the measurement allowance values can be found in Section III.C.5.iii.

TABLE III-17—PROPOSED OFF-CYCLE LOW LOAD AND MEDIUM/HIGH LOAD STANDARDS

Option/MY	Primary intended service class	Bin	NO <sub>x</sub> (mg/hp-hr)	PM (mg/hp-hr)	HC (mg/hp-hr)	CO (g/hp-hr)
Proposed Option 1 MY 2027-2030	All HD Engines	Low load	180	10	280	12
		Medium/high load	70			
Proposed Option 1 MY 2031 and later	Light HDE and Medium HDE	Low load	75	8	90	9
		Medium/high load	30			
Proposed Option 2 MY 2027 and later	All HD Engines	Low load	<sup>a</sup> 150	8	90	9
		Medium/high load	<sup>b</sup> 60			
Proposed Option 1 MY 2027-2030	All HD Engines	Low load	150	8	90	9
		Medium/high load	75			

<sup>a</sup> Proposed Option 1 2031 and later low load bin IUL NO<sub>x</sub> standard is 75 mg/hp-hr for Heavy HDE.

<sup>b</sup> Proposed Option 1 2031 and later medium/high load bin IUL NO<sub>x</sub> standard is 30 mg/hp-hr for Heavy HDE.

3. Feasibility of the Diesel (Compression-Ignition) Off-Cycle Standards

i. Technologies

As a starting point for our determination of the appropriate numeric levels of our proposed off-cycle emission standards, we considered whether manufacturers could meet the duty-cycle standard corresponding to the type of engine operation included in a given bin, as follows:

- Idle bin operation is generally similar to operation at idle and the lower speed portions of the LLC.
- Low load bin operation is generally similar to operation over the LLC and the FTP.
- Medium/high load bin operation is generally similar to operation over the FTP and much of the SET.

An important question is whether the proposed off-cycle standards would require technology beyond what we are projecting would be necessary to meet the duty-cycle standards. As described below, we do not expect our proposed Options 1 and 2 off-cycle standards to require different technologies. However, the proposed Option 1 standard for the medium/high load bin would likely require manufacturers to increase the volume of the SCR catalyst.

This is not to say that we expect manufacturers to be able to meet these proposed Options 1 and 2 standards with no additional work. Rather, we project that the proposed Options 1 and 2 off-cycle standards could be met primarily through additional effort to calibrate the duty-cycle technologies to function properly over the broader range of in-use conditions. We also recognize that manufacturers could choose to include additional technology, if it provided a less expensive or otherwise preferred option.

When we evaluated the technologies discussed in Section III.B.3.i with emissions controls that were designed to cover a broad range of operation, it was clear that we should set the off-cycle standards to higher numerical values than the duty-cycle standards for the off-cycle test procedures being proposed. Section III.C.3.ii explains how the technology and controls performed when testing with the off-cycle test procedures over a broad range of operation. The data presented in Section III.C.3.ii shows that even though there are similarities in the operation between the duty cycles (LLC, FTP, and SET) and the off-cycle bins (Idle bin, Low load bin, and Medium/high load bin), the broader range of operation covered by the off-cycle test procedure results in a broader range in emissions performance, which justifies the need for higher off-cycle standards than the corresponding duty cycle standards. In addition to this, the off-cycle test procedures and standards cover a broader range of ambient temperature and pressure, which can also increase the emissions from the engine as discussed in Section III.C.2.ii. Commenters supporting lower or higher numerical standards are encouraged to consider the proposed level of the standards in the full context of the test procedures and compliance provisions. See Section III.C.6.

ii. Summary of Feasibility Analysis

To identify appropriate numerical levels for the off-cycle standards, we evaluated the performance of the EPA Stage 3 engine in the laboratory on five different cycles that were created from field data of HD engines that cover a range of off-cycle operation. These cycles are the CARB Southern Route Cycle, Grocery Delivery Truck Cycle, Drayage Truck Cycle, Euro-VI ISC Cycle (EU ISC) and the Advanced

Collaborative Emissions Study (ACES) cycle. The CARB Southern Route Cycle is dominantly highway operation with elevation changes resulting in extended motoring sections followed by high power operation. The Grocery Delivery Truck Cycle represents goods delivery from regional warehouses to downtown and suburban supermarkets and extended engine-off events characteristic of unloading events at supermarkets. Drayage Truck Cycle includes near dock and local operation of drayage trucks, with extended idle and creep operation. Euro-VI ISC Cycle is modeled after Euro VI ISC route requirements with a mix of 30 percent urban, 25 percent rural and 45 percent highway operation. ACES Cycle is a 5-mode cycle developed as part of ACES program. Chapter 3 of the draft RIA includes figures that show the engine speed, engine torque and vehicle speed of the cycles.

The engine was initially calibrated to minimize NO<sub>x</sub> emissions for the proposed duty cycles (FTP, SET, and LLC). It was then further calibrated to achieve more optimal performance over the off-cycle operation. Although the engine did not include the SCR catalyst volume that is included in our cost analysis and that would enable lower medium/high load bin NO<sub>x</sub> emissions, the test results shown in Table III–18 provide a reasonable basis for evaluating the feasibility of controlling off-cycle emissions to a useful life of 435,000 miles. Using this data along with the data from the CARB Stage 3 that was measured at multiple points in the age of the aftertreatment to project out the emissions level to 800,000 miles, the proposed Options 1 and 2 off-cycle NO<sub>x</sub> standards at each respective useful life value are shown to be feasible. The summary of the results is in Chapter 3 of the draft RIA.

TABLE III–18—EPA STAGE 3 NO<sub>x</sub> EMISSIONS OFF-CYCLE OPERATION

Bin	CARB southern route	Grocery delivery cycle	ACES	EU ISC	Drayage
Idle bin (g/hr) .....	0.7	1.0	0.9	0.4	0.3
Low load bin (mg/hp-hr) .....	41	25	29	25	15
Medium/high load bin (mg/hp-hr) .....	30	18	16	33	23

a. Idle Bin Evaluation

The proposed idle bin would include the idle operation and some of the lower speed operation that occurs during the LLC and FTP. However, it would also include other types of low-load operation observed with in-use vehicles, such as operation involving longer idle

times than occur in the LLC. To ensure that the idle bin standard would be feasible, we set the proposed Option 1 idle bin standard in MY 2027 and MY 2031 at the level projected to be achievable engine-out with exhaust temperatures below the light-off temperature. As can be seen from

the results in Table III–18, the EPA Stage 3 engine performed well below the proposed Options 1 and 2 NO<sub>x</sub> standards. The summary of the results is located in Chapter 3 of the draft RIA.

b. Low and Medium/High Load Bin Evaluations

As can be seen from the results in Table III–18, the emissions from the Stage 3 engine in the low load bin were below the proposed Options 1 and 2 standards for each of the off-cycle standards. The HC and CO emissions measured for each of these off-cycle duty cycles was well below the proposed Options 1 and 2 off-cycle standards for the low and medium/high load bins. The summary of the results is located in Chapter 3 of the draft RIA.

For the medium/high load bin, four of the five off-cycle duty cycles had emission results below the proposed Option 1 NO<sub>x</sub> standard for MY 2031 of 30 mg/hp-hr shown in Table III–17. As mentioned, in Section III.B.2 the engine did not include the SCR catalyst volume that is included in our cost analysis, so we will continue to evaluate the emissions performance from the EPA Stage 3 engine and we will evaluate an aftertreatment that includes this additional SCR volume referred to as EPA Team A. In addition, we will conduct testing with these aftertreatments after they have been aged to the equivalent of 800,000 miles to further evaluate the feasibility of the proposed Option 1 off-cycle standards for the full proposed MY 2031 useful life period. For the proposed Option 2 medium/high load standards, our extrapolation of the data from 435,000

miles to the 650,000 useful life of proposed Option 2 indicates that the standards would be feasible starting in MY 2027.

We request comment on the proposed Options 1 and 2 off-cycle standards, as well as the overall structure of the off-cycle program. We also request comment on the need for fewer or more than 3 bins. As described in Section III.C.3.ii, the emissions from CARB Stage 3 engine have been demonstrated to be very similar across the three bins, which may indicate that some or all bins can be combined. On the other hand, this data was generated on the EPA Stage 3 engine with aftertreatment that was chemically- and hydrothermally-aged to the equivalent of 435,000 miles and as the aftertreatment is aged beyond 435,000 miles it may show a larger difference in NO<sub>x</sub> emissions performance between the bins. See Chapter 3 of the draft RIA for more information on how the FTP, SET, and LLC NO<sub>x</sub> emissions performance has changed from the degreened system to the aftertreatment aged to an equivalent of 600,000 miles.

4. Potential Alternatives

Following our approach for duty-cycle standards, we evaluated one set of alternative off-cycle exhaust emission standards (the Alternative) for CI HDE. These alternative off-cycle standards were derived using the same approach as the proposed off-cycle standards.

(i.e., by setting the alternative off-cycle standards as a multiple of the alternative certification duty-cycle standards). These off-cycle standards for the Alternative are set at 1.5 times the Clean Idle test standard (NO<sub>x</sub> only) for the idle bin, 1.5 times the LLC standard for the low load bin, and 1.5 times the SET standard for the medium/high load bin. This approach resulted in the same standards in the Alternative and the proposed Options 1 and 2 standards for PM, but different standards for NO<sub>x</sub>, HC and CO.

For the Alternative, data in Table III–18 show that the medium/high load bin off-cycle NO<sub>x</sub> standard would be challenging to meet at a useful life of 435,000 miles. Our extrapolation of the data out to the 850,000 useful life for Heavy HDEs in this alternative suggests that this off-cycle standard is not feasible in the MY 2027 timeframe. We expect that wholly different emission control technologies than we have evaluated to date (i.e., not based on CDA and a dual SCR) would be needed to meet the standards in the Alternative; we request comment on this conclusion and on the availability, or potential development and timeline, of such additional technologies.

As with the proposed standards, the data presented in Chapter 3 of the draft RIA shows that the Alternative PM, HC and CO standards are feasible for CI engines in MY 2027.

TABLE III–19—OFF-CYCLE STANDARDS FOR THE ALTERNATIVE

Model year	Bin	NO <sub>x</sub> (g/hr) for idle, (mg/hp-hr) for low and medium/high load	PM (mg/hp-hr)	HC (mg/hp-hr)	CO (g/hp-hr)
2027 and later	Idle	15.0	No Standard	No Standard	No Standard
	Low load	150	8	90	9.
	Medium/high load	30		15.	

5. Compliance and Flexibilities for Off-Cycle Standards

Given the similarities of the proposed off-cycle standards and test procedures to the current NTE requirements that we are proposing they would replace starting in MY 2027, we have evaluated the appropriateness of applying the current NTE compliance provisions for the proposed Options 1 and 2 off-cycle standards, as discussed below. We are also requesting comment on a possible broadening of our in-use compliance strategy to cover more engines and more operation.

i. Relation of Off-Cycle Standards to Defeat Devices

CAA section 203 prohibits bypassing or rendering inoperative a certified engine's emission controls. When the engine is designed or modified to do this, the engine is said to have a defeat device. With today's engines, the greatest risks with respect to defeat devices involve manipulation of the electronic controls of the engine. EPA refers to an element of design that manipulates emission controls as an Auxiliary Emission Control Device

(AECDD).<sup>350</sup> Unless explicitly permitted by EPA, AECDDs that reduce the effectiveness of emission control systems under conditions which may reasonably be expected to be encountered in normal vehicle operation and use are prohibited as defeat devices under current 40 CFR 86.004–2.

<sup>350</sup> 40 CFR 86.082–2 defines Auxiliary Emission Control Device (AECDD) to mean “any element of design which senses temperature, vehicle speed, engine RPM, transmission gear, manifold vacuum, or any other parameter for the purpose of activating, modulating, delaying, or deactivating the operation of any part of the emission control system.”

For certification, EPA requires manufacturers to identify and describe all AECDs.<sup>351</sup> For any AECD that reduces the effectiveness of the emission control system under conditions which may reasonably be expected to be encountered in normal vehicle operation and use, manufacturers must provide a detailed justification.<sup>352</sup> We are proposing to migrate the definition of defeat device from 40 CFR 86.004–2 to 40 CFR 1036.115(h) and clarify that an AECD is not a defeat device if such conditions are substantially included in the applicable procedure for duty-cycle testing as described in 40 CFR 1036, subpart F. “Duty-cycle testing” in 40 CFR 1036.115(h)(1)(i) would not include the proposed off-cycle test procedure in 40 CFR 1036.515, since it is an off-cycle test procedure and not a duty-cycle test procedure for the purposes of this provision.

#### ii. Heavy-Duty In-Use Testing Program

Under the current manufacturer-run heavy-duty in-use testing (HDIUT) program, EPA annually selects engine families to evaluate whether engines are meeting current emissions standards. Once we submit a test order to the manufacturer to initiate testing, it must contact customers to recruit vehicles that use an engine from the selected engine family. The manufacturer generally selects five unique vehicles that have a good maintenance history, no malfunction indicators on, and are within the engine’s regulatory useful life for the requested engine family. The tests require use of portable emissions measurement systems (PEMS) that meet the requirements of 40 CFR 1065, subpart J. Manufacturers collect data from the selected vehicles over the course of a day while they are used for their normal work and operated by a regular driver, and then submit the data to EPA. Compliance is evaluated with respect to the NTE standards.

We are proposing to continue the HDIUT program, with compliance with respect to the new off-cycle standards and test procedures that would be added to the program beginning with MY 2027 engines. We are also proposing to not carry forward the Phase 2 HDIUT requirements in 40 CFR 86.1915 beginning with MY 2027. Under the current NTE based off-cycle test program, if you are required to test ten engines under Phase 1 testing and less than 8 fully comply with the vehicle pass criteria in 40 CFR 86.1912, then we

could require you to initiate Phase 2 HDIUT testing which would require you to test an additional 10 engines. We are proposing that compliance with the off-cycle standards would be determined by testing a maximum of 10 engines, which was the original limit under Phase 1 HDIUT testing in 40 CFR 86.1915. Similar to the current Phase 1 HDIUT requirements in 40 CFR 86.1912, the proposed 40 CFR 1036.425 requires initially testing five engines. If all five engines pass, you are done testing and your engine family is in compliance. If one of those engines does not comply fully with the off-cycle bin standards, you would then test a sixth engine. If five of the six engines tested pass, you are done testing and your engine family is in compliance. If two of the six engines tested do not comply fully with the off-cycle bin standards, you would then test four more for a total of 10 engines. The engine family would fail off-cycle standards if the arithmetic mean of the sum-over-sum emissions from the ten engines for any of the 3 bins for any of the pollutants is above the off-cycle bin standards. In regard to the averaging of data from the ten engines, we are proposing to take the arithmetic mean of the results by bin for each of the 10 engines determined in 40 CFR 1036.515(h) for each of the pollutants, thus creating mean bin results of each pollutant for each bin for the 10 engines. We request comment on determining this value by using all of the windows in a given bin for a given pollutant over all 10 of the engines tested.

We are also proposing to allow manufacturers to test a minimum of 2 engines using PEMS, in response to a test order program, provided they measure and report in-use data collected from the engine’s on-board NO<sub>x</sub> measurement system. This proposed option would be available only where a manufacturer receives approval based on the requirements in 40 CFR 1036.405(g).

We are proposing to not carry forward the provision in 40 CFR 86.1908(a)(6) that considers an engine misfueled if operated on a biodiesel fuel blend that is either not listed as allowed or otherwise indicated to be an unacceptable fuel in the vehicle’s owner or operator manual. We are proposing in 40 CFR 1036.415(c)(1) to allow vehicles to be tested for compliance with the new off-cycle standards on any commercially available biodiesel fuel blend that meets the specifications for ASTM D975 or ASTM D7467. The proposal to make this change is based on the availability of biodiesel blends up to B20 throughout the United States

and thus its use as a motor fuel in the heavy-duty fleet and the fact that engines must comply with the emission standards when operated on both neat ultra-low sulfur diesel (ULSD) and these biodiesel fuel blends.

Finally, we request comment on the need to measure PM emissions during in-use testing of new or existing engines subject to in-use testing if they are equipped with DPF. PEMS measurement is more complicated and time-consuming for PM measurements than for gaseous pollutants such as NO<sub>x</sub> and eliminating it for some or all of in-use testing would provide significant cost savings. Commenters are encouraged to address whether there are less expensive alternatives for ensuring that engines meet the PM standards in use.

#### iii. PEMS Accuracy Margin

EPA worked with engine manufacturers on a joint test program to establish measurement allowance values to account for the measurement uncertainty associated with in-use testing in the 2008-time frame for gaseous emissions and the 2010-time frame for PM emissions to support NTE in-use testing.<sup>353 354 355</sup> PEMS measurement allowance values in 40 CFR 86.1912 are 0.01 g/hp-hr for HC, 0.25 g/hp-hr for CO, 0.15 g/hp-hr for NO<sub>x</sub>, and 0.006 g/hp-hr for PM. We are proposing to maintain the same values for HC, CO, and PM in this rulemaking. For NO<sub>x</sub> we are proposing off-cycle NO<sub>x</sub> accuracy margin (formerly known as measurement allowance) that is 10 percent of the off-cycle standard for a given bin. This accuracy margin was based on the Joint Research Council Real Driving Emissions (RDE): 2020 Assessment of Portable Emissions Measurement Systems (PEMS) Measurement Uncertainty. In this study, JRC arrived at an accuracy margin of 23 percent. They note that their Real Driving Emissions (RDE) program does not include linear drift correction of the emission measurements over the course of the shift-day. They have analytically determined that if they implement a

<sup>353</sup> Feist, M.D.; Sharp, C.A.; Mason, R.L.; and Buckingham, J.P. Determination of PEMS Measurement Allowances for Gaseous Emissions Regulated Under the Heavy-Duty Diesel Engine In-Use Testing Program. SwRI 12024, April 2007.

<sup>354</sup> Feist, M.D.; Mason, R.L.; and Buckingham, J.P. Additional Analyses of the Monte Carlo Model Developed for the Determination of PEMS Measurement Allowances for Gaseous Emissions Regulated Under the Heavy-Duty Diesel Engine In-Use Testing Program. SwRI® 12859, July 2007.

<sup>355</sup> Khalek, I.A.; Bougher, T.L.; Mason, R.L.; and Buckingham, J.P. PM- PEMS Measurement Allowance Determination. SwRI Project 03.14936.12. June 2010.

<sup>351</sup> See 40 CFR 86.094–21(b)(1)(i)(A).

<sup>352</sup> See definition of “defeat device” in 40 CFR 86.004–2.



linear zero drift correction over the course of the shift-day, the NO<sub>x</sub> accuracy margin would be reduced to 10 percent. It should be noted that our off-cycle test procedures already include a linear zero and span drift correction over at least the shift day, and we are proposing to require at least hourly zero drift checks over the course of the shift day on purified air that, we believe, will result in measurement error that is on par with the analytically derived JRC value of 10 percent.<sup>356</sup>

We are also in the process of further assessing the gaseous PEMS accuracy margin values for NO<sub>x</sub>. There have been improvements made to the PEMS NO<sub>x</sub> analyzers that were used in the emission original measurement allowance value determinations and some of these improvements were implemented in the testing that resulted in the 10 percent value derived by JRC and some were implemented after. Based on information from the on-going PEMS test program using the most current PEMS NO<sub>x</sub> analyzers, we may make further revisions to the PEMS accuracy margin for NO<sub>x</sub> for the off-cycle NO<sub>x</sub> standards. This may result in finalizing a different accuracy margin or separate accuracy margins for each off-cycle bin NO<sub>x</sub> standard that could be higher or lower than what we have proposed. As results become available from this study, we will add them to the docket.

These accuracy margins can be found in the proposed 40 CFR 1036.420. We request comment on our proposed approach to PEMS accuracy margins for assessing in-use compliance with NO<sub>x</sub> and other pollutant standards.

As part of the PEMS measurement uncertainty analysis we will be

continuing to evaluate proposed test procedure options that could further reduce the uncertainty of PEMS measurements. This evaluation includes the test procedures that define the drift check and drift correction, linearity requirements for the analyzers, and the requirements that define how the analyzer is zeroed and spanned throughout the test. We have proposed updates to 40 CFR 1065.935 to require hourly zeroing of the PEMS analyzers using purified air for all analyzers. We are also proposing to update the drift limits for NO<sub>x</sub> analyzers to improve data quality. Specifically, for NO<sub>x</sub> analyzers, we are proposing an hourly or more frequent zero verification limit of 2.5 ppm, a zero-drift limit over the entire shift day of 10 ppm, and a span drift limit between the beginning and end of the shift-day or more frequent span verification(s) of ±4 percent of the measured span value. We request comment on the proposed test procedure updates in 40 CFR 1065.935 and any changes that would reduce the PEMS measurement uncertainty.

iv. Demonstrating Off-Cycle Standards for Certification

Consistent with current certification requirements in 40 CFR 86.007–21(p)(1), we are proposing a new paragraph in 40 CFR 1036.205(p) that would require manufacturers to provide a statement in their application for certification that their engine complies with the off-cycle standards. Our proposal would require manufacturers to maintain record of any test data or engineering analysis they used as a basis for their statement but would not require manufactures to submit that information as part of their

application. We request comment on our proposal to continue the practice of manufacturers submitting a statement without test data as a means of demonstrating compliance with off-cycle standards at certification.

For commenters suggesting manufacturers submit test data, we request comment on defining a specific test for manufacturers to demonstrate that they meet off-cycle standards at certification. The proposed off-cycle standards were designed to apply in-use when engines may not be operating on EPA’s defined duty cycles. We are proposing that manufacturers use the off-cycle test procedure of 40 CFR 1036.515 when evaluating their in-use emission performance relative to the off-cycle standards. We request comment on demonstrating compliance with off-cycle standards by applying the off-cycle test procedure proposed in 40 CFR 1036.515 to one or more test cycles performed on an engine dynamometer. We solicit comment on alternatively demonstrating compliance with a field test using 40 CFR 1036.515.

6. Summary of Requests for Comment on the Stringency of the Off-Cycle Standards

The effective stringency of the proposed off-cycle standards is inherently tied to the way in which these standards are applied. To assist commenters in considering the stringency of the standards in the full context of the test procedures and compliance provisions, we have summarized these factors in Table III–20 below.

TABLE III–20—SUMMARY OF OFF-CYCLE TEST PROCEDURE VALUES AND COMPLIANCE PROVISIONS

Issue	Increasing effective stringency	Decreasing effective stringency
Numerical value .....	Lower value .....	Higher value.
Window length .....	Shorter windows .....	Longer windows.
Test conditions .....	Broader conditions .....	Narrower conditions.
Operation type .....	Broader operation .....	Narrower operation.

These factors can be considered individually, but commenters are encouraged to consider the tradeoffs between them. For example, commenters supporting a broader range of test conditions, could address the potential need for provisions to offset the stringency impact, such as higher standards.

We are proposing to sum the total mass of emissions for a given pollutant

and divide by the sum of CO<sub>2</sub> mass emissions per bin once all the data has been separated into bins. This “sum-over-sum” approach would account for all emissions; however, it would require the measurement system (PEMS or a NO<sub>x</sub> sensor) to provide accurate measurements across the complete range of emissions concentrations. We specifically request comments on the numeric values for the bin cut-points,

the number of bins, the definition of the bin cut-point and the reference cycle for each bin. The importance of each of these values that define the proposed test procedure can be seen from the NO<sub>x</sub> emissions achieved on the EPA Stage 3 engine which is summarized in Section III.B.3. This data shows that the emissions from this engine are relatively flat as a function of engine power. This data could suggest that either fewer bins

<sup>356</sup> Giechaskiel B., Valverde V., Clairotte M. 2020 Assessment of Portable Emissions Measurement

Systems (PEMS) Measurement Uncertainty.

JRC124017, EUR 30591 EN. <https://publications.europa.eu/en/publications>.

are needed, for example combining the idle and low-load bin or that a different bin definition other than window average power should be used to bin the data.

We also request comment on the advantages and disadvantages of other statistical approaches that evaluate a percentile window(s) within each of the bins instead of the full data set as discussed in Chapter 3.2.3 in the draft RIA.

*D. Summary of Spark-Ignition Heavy-Duty Engine Exhaust Emission Standards and Test Procedures*

This section summarizes current exhaust emission standards and test procedures for certain spark-ignition (SI) heavy-duty engines and our proposed updates, as well as the feasibility demonstration and data that support our proposed changes.

Heavy-duty SI engines are largely produced by integrated vehicle manufacturers. These vehicle manufacturers sell most of their engines as part of complete vehicles but may also sell incomplete vehicles (*i.e.*, an engine and unassembled chassis components) to secondary vehicle manufacturers.<sup>357</sup> In the latter case,

secondary manufacturers, sometimes referred to as “finished vehicle builders,” complete the body and sell the final commercial vehicle product to the customer. Under current industry practice, the incomplete vehicle manufacturer (*i.e.*, chassis manufacturer) certifies both the engine and incomplete vehicle pursuant to all exhaust and evaporative emission requirements, performs testing to demonstrate compliance with the standards and provides the secondary manufacturer with build instructions to maintain compliance with the standards and to prevent the secondary manufacturer from performing modifications that would result in an un-certified configuration. Original chassis manufacturers and secondary manufacturers share responsibility for ensuring that the exhaust and evaporative emission control equipment is maintained in the final product delivered to the end customer.<sup>358</sup>

1. Current Exhaust Emission Standards and Test Procedures

Current Otto-cycle (spark-ignition) heavy-duty engine exhaust emission standards in 40 CFR 86.008–10 apply to engines as provided in 40 CFR 86.016–

1.<sup>359</sup> The test procedure for these exhaust standards is the heavy-duty Federal Test Procedure (FTP), which includes an engine dynamometer schedule that represents urban driving. This test procedure is used for certification, SEA, and in-use emissions testing.<sup>360</sup> Similar to the FTP duty cycle for CI engines, SI engine manufacturers evaluate their HD engines for exhaust emission standards by performing the FTP duty cycle under cold-start and hot-start conditions and determine a composite emission value by weighting the cold-start emission results and the hot-start emission results as specified in 40 CFR 86.008–10(a)(2)(v). This test cycle and cold/hot-start weighting was developed based on the typical operation of spark-ignition engines and differs from its compression-ignition counterpart in the normalized speed and torque setpoints, as well as the length of the cycle. The current SI engine exhaust emission standards for this duty cycle are identical to those for CI engines, as shown in Table III–21, consistent with the principle of fuel neutrality applied in recent light-duty vehicle criteria pollutant standards rulemakings.<sup>361</sup>

TABLE III–21—CURRENT OTTO-CYCLE ENGINE EXHAUST EMISSION STANDARDS OVER THE FTP DUTY-CYCLE

	NO <sub>x</sub> <sup>a</sup> (g/hp-hr)	PM (g/hp-hr)	HC <sup>b</sup> (g/hp-hr)	CO (g/hp-hr)
0.20 .....		0.01	0.14	14.4

<sup>a</sup> Engine families participating in the ABT program are subject to a FEL cap of 0.50 g/hp-hr for NO<sub>x</sub>.

<sup>b</sup> Engine families participating in the ABT program are subject to a FEL cap of 0.30 g/hp-hr for HC.

To generate specific duty cycles for each engine configuration, engine manufacturers identify the maximum brake torque versus engine speed using the engine mapping procedures of 40 CFR 1065.510. The measured torque values are intended to represent the maximum torque the engine can achieve under fully warmed-up operation when using the fuel grade recommended by the manufacturer (*e.g.*, regular unleaded, 87 octane fuel) across the range of engine speeds expected in real-world conditions. The mapping procedure is intended to stabilize the engine at discrete engine speed points ranging from idle to the electronically-limited highest RPM before recording the peak

engine torque values at any given speed. The provision in 40 CFR 1065.510(b)(5)(ii) allows manufacturers to perform a transient sweep from idle to maximum rated speed, which requires less time than stabilizing at each measurement point.

The HD Technical Amendments rulemaking migrated some heavy-duty highway engine test procedures from 40 CFR part 86 to part 1036.<sup>362</sup> In addition to migrating the heavy-duty FTP drive schedule for SI engines from paragraph (f) of appendix I to part 86 to paragraph (b) of appendix II to part 1036, we added vehicle speed and road grade to the duty-cycle, which are needed to facilitate powertrain testing of SI

engines for compliance with the HD Phase 2 GHG standards. As part of the drive schedule migration, negative normalized vehicle torque values over the HD FTP SI duty-cycle were removed.

2. Proposed Exhaust Emission Standards and Test Procedures

We are proposing to migrate the existing provisions for heavy-duty Otto-cycle engines from 40 CFR part 86, subpart A, into part 1036, with the migrated part 1036 provisions applying to heavy-duty SI engines starting in MY 2027.<sup>363</sup> We are also proposing additional revisions as noted in this section.

<sup>357</sup> See *e.g.*, the definitions of “vehicle” and “secondary vehicle manufacturer” in 40 CFR 1037.801.

<sup>358</sup> Responsibilities for multiple manufacturers are described in 40 CFR 1037.620(b).

<sup>359</sup> These engines include SI engines installed in vehicles above 14,000 lb GVWR or incomplete vehicles at or below 14,000 lb GVWR, but do not include engines installed in incomplete vehicles at

or below 14,000 lb GVWR that are voluntarily certified under 40 CFR 86, subpart S.

<sup>360</sup> This duty cycle is summarized in Chapter 2.1.3 of the draft RIA. The driving schedule can be found in paragraph (f)(1) of Appendix I to 40 CFR part 86.

<sup>361</sup> See 65 FR 6728 (February 10, 2000) and 79 FR 23454 (April 28, 2014).

<sup>362</sup> 86 FR 34311, June 29, 2021.

<sup>363</sup> Under the proposed migration into part 1036, Spark-ignition HDE produced before model year 2027 would remain subject to existing part 86 requirements, including the exhaust and crankcase emission standards specified in 40 CFR 86.008–10(a) and (c).

Our proposed revisions to 40 CFR 1036.1 include migrating and updating the applicability provisions of 40 CFR 86.016–1. The provisions proposed in this section would apply for SI engines installed in vehicles above 14,000 lb GVWR and incomplete vehicles at or below 14,000 lb GVWR, but do not include engines voluntarily certified to or installed in vehicles subject to 40 CFR part 86, subpart S. We propose to update the primary intended service classes currently defined in 40 CFR 1036.140 to refer to new acronyms such that the proposed requirements in this section apply to the “Spark-ignition HDE” primary intended service class. Additionally, we are proposing updated Spark-ignition HDE exhaust emission standards in a new 40 CFR 1036.104. The proposal includes two sets of options for these standards: Proposed Option 1 and proposed Option 2. Proposed Option 1 would apply in two steps, with a first step in MY 2027 and a second step in MY 2031. Proposed Option 2 would apply in a single step starting in MY 2027. The two proposed options generally represent the range of lead time, standards, regulatory useful

life periods, and emission-related warranty periods we are currently considering in this rule for HD SI engines.

As described in the following sections, Spark-ignition HDE certification would continue to be based on emission performance in lab-based engine dynamometer testing, with a proposed new SET duty cycle to address high load operation and idle emission control requirements to supplement our current FTP duty cycle.<sup>364</sup> We are proposing two options to lengthen useful life and emissions warranty periods for all heavy-duty engines, including Spark-ignition HDE, as summarized in the following sections and detailed in Sections IV.A and IV.B.1 of this preamble.<sup>365</sup> Engine manufacturers would continue to have the flexibility to participate in EPA’s ABT program. We are proposing to update our ABT provisions in part 1036, subparts B and H, to reflect our proposed standards and useful life periods (see Section IV.G of this preamble). We are also proposing family emission limit (FEL) caps for NO<sub>x</sub> in

our proposed ABT program as described in the following sections.

i. Proposed Updates to the Federal Test Procedure and Standards

We propose to update 40 CFR part 1036, including the test procedure provisions of part 1036, subpart F, to apply for criteria pollutant testing. We propose that manufacturers would use the current FTP drive schedule of Appendix II of part 1036.<sup>366</sup> As part of migrating the FTP drive schedule from part 86 to part 1036 in the recent HD Technical Amendment rulemaking,<sup>367</sup> negative torque values were replaced with closed throttle motoring but there was no change to the weighting factors or drive schedule speed values. As shown in Table III–22, we are co-proposing two options to update our Spark-ignition HDE exhaust standards for the FTP duty cycle. The proposed Spark-ignition HDE exhaust standards maintain our fuel-neutral approach with standards that are numerically identical to the two steps of the proposed compression-ignition engine standards over our proposed lengthened Spark-ignition HDE useful life periods.<sup>368</sup>

TABLE III–22—PROPOSED SPARK-IGNITION HDE EXHAUST EMISSION STANDARDS OVER THE FTP DUTY CYCLE

Scenario	Model year	NO <sub>x</sub> <sup>a</sup> (mg/hp-hr)	PM (mg/hp-hr)	HC (mg/hp-hr)	CO (g/hp-hr)	Useful life (miles/years)
Proposed Option 1 .....	2027–2030 .....	35	5	60	6.0	155,000/12
	2031 and later .....	20	5	40	6.0	200,000/15
Proposed Option 2 .....	2027 and later .....	50	5	40	6.0	150,000/10

<sup>a</sup> Engine families participating in the ABT program would be subject to a NO<sub>x</sub> FEL cap of 150 mg/hp-hr for MYs 2027–2030 under proposed Option 1 or for MYs 2027 and later under proposed Option 2, and 50 mg/hp-hr for MYs 2031 and later under proposed Option 1.

Our analysis of recent SI HDE certification data suggests that the proposed Options 1 and 2 standards are already nearly achievable for the existing useful life mileage values using emission control technologies available today. All SI heavy-duty engines currently on the market use a three-way catalyst (TWC) to simultaneously control NO<sub>x</sub>, HC, and CO emissions.<sup>369</sup> We project manufacturers would continue to use TWC technology and would adopt advanced catalyst washcoat technologies and refine their existing catalyst thermal protection (fuel

enrichment) strategies to prevent damage to engine and catalyst components over our proposed longer useful life. Our feasibility analysis in Section III.D.3 describes the derivation of the proposed standards, including results from our SI technology demonstration program showing the feasibility of meeting these standards up to and beyond our proposed Options 1 and 2 useful life mileage values.

ii. Proposed Updates to Engine Mapping Test Procedure

As noted in Section III.D.1, manufacturers use the engine fuel mapping procedures of 40 CFR 1065.510 for certification. In Chapter 2.3.2 of our draft RIA, we describe torque variability that can result from the electronic controls used in SI engines. We are proposing updates to the engine mapping test procedure for heavy-duty engines to require that the torque curve established during the mapping procedure for highway heavy-duty engines be representative of the highest

<sup>364</sup> CARB’s HD Omnibus rulemaking included “in-use thresholds” (*i.e.*, “off-cycle standards” in this proposal) for heavy-duty Otto-cycle engines. We request comment on setting off-cycle standards for Spark-ignition HDE. We are not proposing a manufacturer-run in-use testing program for Spark-ignition HDE at this time, though we may consider it in future rulemakings. See California Air Resources Board. Staff Report: Initial Statement of Reasons-Public Hearing to Consider the Proposed Heavy-Duty Engine and Vehicle Omnibus Regulation and Associated Amendments. June 23,

2020. page III–33. Available online: <https://ww2.arb.ca.gov/rulemaking/2020/hdomnibuslownox>.

<sup>365</sup> We are proposing to migrate the current alternate standards for engines used in certain specialty vehicles from 40 CFR 86.007–11 and 86.008–10 into 40 CFR 1036.605 without modification. See Section XII.B of this preamble for a discussion of these standards and options for which we are requesting comment.

<sup>366</sup> Note that we are proposing to rename this appendix to Appendix B to part 1036.

<sup>367</sup> 86 FR 34311, June 29, 2021.

<sup>368</sup> Our proposed useful life periods are based on the operational life of the engines and differ by primary intended service class. See Section IV.A of this preamble for a discussion of our proposed useful life periods.

<sup>369</sup> See Chapter 1.2 of the draft RIA for a detailed description of the TWC technology and other strategies HD SI manufacturers use to control criteria emissions.

torque level possible when using the manufacturer's recommended fuel grade (e.g., regular unleaded, 87 octane). Specifically, our proposed update to 40 CFR 1065.510(b)(5)(ii) would require manufacturers to disable any electronic controls that they report to EPA as an auxiliary emission control device (AECD) that would impact peak torque during the engine mapping procedure.<sup>370</sup> We are proposing these updates to apply broadly for all engines covered under part 1065 (see 40 CFR 1065.1). Section XII.I of this preamble includes a discussion of proposed revisions to part 1065.

### iii. Proposed Supplemental Emission Test and Standards

As discussed in Chapter 1 of the draft RIA, SI engines maintain stoichiometric air-fuel ratio control for a majority of the points represented on a fuel map. However, engine manufacturers program power enrichment and catalyst protection enrichment commands to trigger additional fuel to be delivered to the engine when either the engine requires a power boost to meet a load demand or high exhaust temperatures activate thermal protection for the catalyst. Generally, these strategies temporarily allow the engine to deviate from its "closed loop" control of the air-fuel ratio to increase the fraction of fuel (i.e., fuel enrichment) and lower exhaust temperatures or increase engine power. Fuel enrichment is an effective means to protect the catalyst and increase engine power, but frequent enrichment events can lead to high criteria pollutant emissions and excessive fuel consumption not captured in existing test cycles. In Chapter 2.2 of the draft RIA, we highlight the opportunities to reduce emissions in high-load operating conditions where engines often experience enrichment for either catalyst protection or a power boost. Our feasibility discussion in Section III.D.3 presents thermal management, catalyst design, and engine control strategies engine manufacturers can implement to reduce enrichment frequency and associated emissions to meet our proposed standards.

Manufacturers implement enrichment strategies in real world operation when engines are above about 90 percent throttle for a duration that exceeds

certain thresholds determined by the manufacturer. The FTP duty cycle currently used for engine certification does not capture prolonged operation in those regions of the engine map. Historically, in light of the limited range of applications and sales volumes of SI heavy-duty engines, especially compared to CI engines, we believed the FTP duty cycle was sufficient to represent the high-load and high-speed operation of SI engine-powered heavy-duty vehicles. As the market for SI engines increases for use in larger vehicle classes, these engines are more likely to operate under extended high-load conditions, causing us to more closely examine the adequacy of the test cycle in ensuring emissions control under real world operating conditions.

The existing supplemental emission test (SET) duty cycle, currently only applicable to CI engines, is a ramped modal cycle covering 13 steady-state torque and engine speed points that is intended to exercise the engine over sustained higher load and higher speed operation. We believe the SET procedure, including updates proposed in this rule, could be applied to SI engines and we are proposing to add the SET duty cycle and co-proposing two options for new SET emission standards for the Spark-ignition HDE primary intended service class.<sup>371</sup> This new cycle would ensure that emission controls are properly functioning in the high load and speed conditions covered by that duty cycle. The proposed SET standards for Spark-ignition HDE are based on the same SET procedure, with the same proposed updates, as for heavy-duty CI engines, and we request comment on the need for any SI-specific provisions. Specifically, we request comment on the appropriateness of the CI-based weighting factors that determine the time spent (i.e., dwell period) at each cycle mode. We encourage commenters to submit data to support any alternative dwell periods we should consider for SI engines.

We received comments in response to our ANPR discussion of the potential addition of an SET test cycle for HD SI engines.<sup>372</sup> The commenter suggested that additional test cycles to capture sustained high load operation are not necessary and deviations from the FTP emission control strategies are

addressed through the case-by-case AECD review process. While we agree that this process is available during the certification of an engine or vehicle, we believe it is more effective to evaluate the emission control system over measured test cycles with defined standards, where such test cycles are available, rather than relying solely on case-by-case identification by the manufacturer and review by EPA of the AECDs for each engine family. The commenter describes a high load enrichment AECD, which potentially increases CO, NMHC and PM emissions (see RIA Ch 3.2). However, the agency is also concerned about the potential for increased NO<sub>x</sub> emissions during high load stoichiometric operation, where the enrichment AECD is not active. The current FTP transient cycle does not sufficiently represent these high load conditions, and we believe that the SET cycle is appropriate for evaluating this type of operation.

Similar to our fuel-neutral approach for FTP, we are proposing to align the SET standards for CI and SI engines, as shown in Table III-23. Specifically, we propose to adopt the SI HDE SET standards for NO<sub>x</sub> and PM emissions based on the demonstrated ability of CI engines to control these emissions under high load conditions. The proposed Options 1 and 2 Spark-ignition HDE standards for HC and CO emissions on the SET cycle are numerically equivalent to the respective proposed FTP standards and are intended to ensure that SI engine manufacturers utilize emission control hardware and calibration strategies that maintain effective control of emissions during high load operation.<sup>373</sup> We believe the proposed SET duty cycle and standards would accomplish this goal, and the level of our proposed Options 1 and 2 HC and CO standards are feasible over our proposed Options 1 and 2 useful life mileages based on our HD SI technology demonstration program summarized in Section III.D.3.ii.b. We request comment on the proposed SET test cycle and standards for Spark-ignition HDE, and any modifications we should consider to adapt the current CI-based SET duty cycle to SI HDEs.

<sup>370</sup> AECDs are defined in 40 CFR 1036.801 and described in our proposed, migrated new paragraph 1036.115(h). Manufacturers report AECDs in their application for certification as specified in our proposed, migrated and updated § 1036.205(b).

<sup>371</sup> See our proposed updates to the SET test procedure in 40 CFR 1036.505.

<sup>372</sup> See comments from Roush CleanTech (EPA-HQ-OAR-2019-0055-0303) in our docket.

<sup>373</sup> Test results presented in Chapter 3.2.3 of the draft RIA and summarized in Section III.D.3 indicate that these standards are achievable when the engine controls limit fuel enrichment and maintain closed loop control of the fuel-air ratio.

TABLE III–23—PROPOSED SPARK-IGNITION HDE EXHAUST EMISSION STANDARDS OVER THE SET DUTY-CYCLE

Scenario	Model year	NO <sub>x</sub> (mg/hp-hr)	PM (mg/hp-hr)	HC (mg/hp-hr)	CO (g/hp-hr)	Useful life (miles/years)
Proposed Option 1 .....	2027–2030 .....	35	5	60	6.0	155,000/12
	2031 and later .....	20	5	40	6.0	200,000/15
Proposed Option 2 .....	2027 and later .....	50	5	40	6.0	150,000/10

We are also considering other approaches to address emissions from enrichment events during high load operation. Our current provisions in 40 CFR 86.004–28(j) require engine manufacturers to account for emission increases that are associated with aftertreatment systems that infrequently regenerate.<sup>374</sup> Compression-ignition engine manufacturers currently apply these infrequent regeneration adjustment factor (IRAF) provisions to account for emission increases that may occur when the DPFs used for PM control on their engines require regenerations. These infrequent regeneration events use additional fuel to temporarily heat the DPF and clean the filter. Similar to the approach for infrequent regeneration events, the agency seeks comment on whether to require manufacturers to apply adjustment factors to SI FTP and/or SET emission test results to quantify the HC, CO, NO<sub>x</sub>, and PM emission increases that occur due to enrichment AECs. These factors would be quantified in a manner similar to that used in developing IRAFs, where they are based on the estimated real-world frequency and the measured emissions impact of these events.

iv. Proposed Idle Control for Spark-Ignition HDE

As described in Chapter 3.2 of the draft RIA, an idle test would assess whether the main component of the SI engine emission control system, the catalyst, remains effective during prolonged idle events. Heavy-duty SI engines can idle for long periods during loading or unloading of the vehicle cargo or to maintain cabin comfort (*i.e.*, heating or cooling) when the vehicle is parked.

Our primary concern for extended idle operation is that prolonged idling events may allow the catalyst to cool and reduce its efficiency resulting in emission increases including large emission increases on the driveway until the catalyst temperatures increase. As discussed in the draft RIA, our recent HD SI test program showed idle events that extend beyond four minutes allow

the catalyst to cool below the light-off temperature of 350 °C. The current heavy-duty FTP and proposed SET duty cycles do not include sufficiently long idle periods to represent these real-world conditions where the exhaust system cools below the catalyst’s light-off temperature. We are proposing in a new paragraph at 40 CFR 1036.115(j)(1) to require the catalyst bed used in SI HDEs to maintain a minimum temperature of 350 °C to ensure emission control during prolonged idle; manufacturers would also be able to request approval of alternative strategies to prevent increased emissions during idling. We believe this minimum temperature requirement would sufficiently ensure emission control is maintained during idle, while addressing ANPR commenter concerns that our proposed idle requirements should not require significant additional test and certification costs.<sup>375</sup> We request comment on this proposal, as well as additional or alternative strategies, such as an idle test cycle and standard, that are capable of representing real-world operation and would address idle emissions not observed or measured on the current and proposed duty cycles. Commenters are encouraged to include data that represents engines expected to be available in the MY 2027 and later timeframe.

We recognize that over the next decade there may be an added incentive to generally reduce idling as a compliance strategy to meet EPA’s heavy-duty greenhouse gas standards. Widespread adoption of idle reduction technologies, such as engine stop-start, may reduce the frequency and duration of prolonged idle and reduce the need for exhaust temperature thresholds. However, these idle reduction strategies may also cause emission increases when the engine is restarted, where the catalyst and oxygen sensors may have cooled and require a warm-up period. We request comment, including relevant data, on the expected adoption rate of idle reduction technologies (*e.g.*, stop-start) in the heavy-duty sector and the

impact on criteria pollutant emissions when these technologies are in use.

v. Proposed Powertrain Testing Option for Hybrids

As summarized in Section III.B, we are proposing to expand the existing powertrain test procedures in 40 CFR 1037.550 to allow hybrid manufacturers to certify their products as meeting EPA’s criteria pollutant standards.<sup>376</sup> The procedure updates are intended to apply to both CI and SI-based hybrid systems, but many of the default vehicle parameters are based on CI systems. We request comment on the need for SI-specific vehicle parameters such as vehicle mass, drag coefficients, and rolling resistance coefficients.

vi. Proposed Thermal Protection Temperature Modeling Validation

Manufacturers utilize some form of catalyst or critical exhaust component temperature modeling within the ECM to determine when to activate fuel enrichment strategies to protect engine and catalyst hardware from excessive temperatures that may compromise durability. Manufacturers typically design these models during the engine development process by monitoring the actual temperatures of exhaust system components that have been instrumented with thermocouples during dynamometer testing. In these controlled testing conditions, manufacturers can monitor temperatures and stop the test to protect components from damage from any malfunctions and resulting excessive temperatures. The accuracy of these models used by manufacturers is critical in both ensuring the durability of the emission control equipment and preventing excessive emissions that could result from unnecessary or premature activation of thermal protection strategies.

The existing regulations require any catalyst protection strategies adopted by HD SI engine manufacturers to be reported to EPA in the application for certification as an AEC.<sup>377</sup> The engine

<sup>374</sup> We are proposing to migrate the current IRAF provisions into a new section 40 CFR 1036.522.

<sup>375</sup> Roush comments (EPA–HQ–OAR–2019–0055–3003).

<sup>376</sup> See Chapter 2 of the draft RIA for a detailed description of the powertrain test procedure.

<sup>377</sup> See 40 CFR 86.094–21(b)(1)(i) and our proposed migration of those provisions to 40 CFR 1036.205(b).

controls used to implement these strategies often rely on a modeling algorithm to predict high exhaust temperatures and to disable the catalyst, which can change the emission control strategy and directly impact real world emissions. During the certification process, manufacturers typically disclose the temperature thresholds of the critical components that need thermal protection and the parameter values (e.g., time and temperature) at which the model activates the protection strategy. The agency has historically determined the appropriateness of these temperature limits based on information from engine manufacturers and component suppliers. We are proposing to standardize the process during certification of how a manufacturer discloses and validates a thermal protection model's performance.

In order to ensure that a manufacturer's model accurately estimates the temperatures at which thermal protection modes are engaged, the agency is proposing a validation process in a new paragraph 40 CFR 1036.115(j)(2) that would document the model performance during certification testing. The proposed validation process would require manufacturers to record component temperatures during engine mapping and the FTP and proposed SET duty cycles and a second-by-second comparison of the modeled temperature and the actual component temperature applications and submit as part of their certification. We propose that manufacturers must show that the measured component temperatures and the software-derived temperature model estimates are within 5 °C. This limitation on temperature differential is proposed to prevent model-based AECs from being overly conservative in their design such that catalyst protection and resulting emissions increases due to fuel enrichment is triggered at lower temperatures than necessary. Manufacturers would be exempt from this model validation requirement for all engines that continuously monitor component temperatures via temperature sensors in lieu of thermal protection modeling.

As described in Section IV.C, we are proposing to expand the list of OBD parameters accessible using a generic scan tool. We are proposing that SI engine manufacturers monitoring component temperatures to engage thermal protection modes would make the component temperature parameters (measured and modeled, if applicable) publicly available, as specified in a new 40 CFR 1036.110(c)(4).

The agency seeks comment on this model validation proposal, including data that shows the frequency of preventable enrichment occurrences. We request comment on our proposed temperature allowance of 5 °C and whether we should require a specific type of thermocouple to measure the component temperatures. We also request comment on whether we should specify a method to filter temperature data to account for transient engine speed conditions. The agency also seeks comment on requiring manufacturers to incorporate temperature sensors on all production engines to continuously measure the temperature of any exhaust component that is currently protected by use of an enrichment strategy instead of relying on software models to estimate temperature. Currently, temperature sensors are used in production compression-ignition emission control systems and some light-duty SI applications.

#### vii. Proposed OBD Flexibilities

We recognize that there can be some significant overlap in the technologies and control systems adopted for products in the chassis-certified and engine-certified markets. These vehicles may share common engine designs and components, and their emission control systems may differ only in catalyst sizing and packaging and the calibration strategies used to meet the chassis- or engine-based emission standards.

We are proposing to further incentivize HD SI engine manufacturers to adopt their chassis-certified technologies and approaches in their engine-certified products so that the emission control strategies of their two product lines are more closely aligned. Specifically, we are proposing to limit the need for duplicate OBD certification testing if a manufacturer's chassis- and engine-certified technology packages are sufficiently similar. The current regulations in 40 CFR part 86 distinctly separate the OBD requirements based on GVWR. Under 40 CFR 86.007–17, engines used in vehicles at or below 14,000 lb GVWR are subject to the chassis-based OBD provisions of 40 CFR 86.1806. Engines in vehicles above 14,000 lb GVWR are subject to the engine-based provisions of 40 CFR 86.010–18 and there is no pathway for these larger vehicles to certify using the chassis-based OBD provisions.

In addition to the general heavy-duty OBD provisions proposed in new section 40 CFR 1036.110, we are proposing to allow vehicle manufacturers the option to request approval to certify the OBD of their spark-ignition, engine-certified products

using data from similar chassis-certified Class 2b and Class 3 vehicles that meet the provisions of 40 CFR 86.1806–17. As part of the approval request, manufacturers would show that the engine- and chassis-certified products use the same engines and generally share similar emission controls (i.e., are "sister vehicles"). Under this proposal, manufacturers would still be required to submit a separate application for certification for their engine-certified products, but EPA may approve the use of OBD testing data from sister vehicles at or below 14,000 lb GVWR class for the engine-certified products. We request comment on any additional provisions or limitations we should consider adopting related to aftertreatment characteristics, chassis configurations, or vehicle classes when evaluating a manufacturer's request to share OBD data between engine- and chassis-certified product lines. Specifically, we request comment, including data, on the impact of varying vehicle components such as transmissions, axle ratios, and fuel tank sizes on the OBD system. Finally, we request comment on additional compliance provisions, beyond OBD, that could be streamlined for these sister vehicles.

#### viii. Potential Off-Cycle Standards for Spark-Ignition HDE

As described in Section III.C, CI engines have been subject to not-to-exceed (NTE) standards and in-use testing requirements for many years. In Section III.C.2, we propose new off-cycle standards and updated in-use test procedures for CI engines. The proposed in-use test procedures in 40 CFR part 1036, subpart E, include the steps to perform the manufacturer-run field testing program for CI engines as migrated and updated from 40 CFR part 86, subpart T. The in-use procedures are based on a new moving average window (MAW) procedure in 40 CFR 1036.515 that separates in-use operation into idle, low load and medium/high load bins.

For SI engines, we request comment on setting off-cycle standards that would be based on an approach similar to the one taken by CARB in their HD Omnibus rulemaking.<sup>378</sup> The Omnibus rule includes "in-use thresholds" (i.e., off-cycle standards) for HD Otto cycle engines based on the laboratory-run FTP and SET duty cycles, and manufacturers

<sup>378</sup> California Air Resources Board, Staff Report: Initial Statement of Reasons-Public Hearing to Consider the Proposed Heavy-Duty Engine and Vehicle Omnibus Regulation and Associated Amendments, June 23, 2020, page III–33. Available online: <https://ww2.arb.ca.gov/rulemaking/2020/hdomnibuslownox>.

may comply by attesting to meeting the in-use thresholds in their application for CARB certification. The CARB in-use thresholds apply to emissions measured over a shift day and processed into a single bin of operation. The thresholds from the single HD Otto cycle engine bin match CARB’s standards in the medium/high load in-use bin for CI engines.

We are not proposing to include Spark-ignition HDE in our manufacturer-run field testing program at this time, and we currently lack in-use data to assess the feasibility of doing so, but we may consider it in a future

rulemaking. We request comment on adopting in-use provisions similar to those for HD Otto cycle engines in CARB’s program. Specifically, we request comment on allowing SI HDE manufacturers to attest to compliance with off-cycle standards in the application for certification and on not including SI HDE in our manufacturer-run field testing program. We request comment, including data, on the appropriate level of off-cycle standards we should consider for Spark-ignition HDE. Table III–24 presents a potential set of single bin off-cycle standards for

Spark-ignition HDE that match the medium/high load in-use bin standards of proposed Options 1 and 2 for CI engines and similarly apply conformity factors to the proposed FTP and SET duty cycle standards for each pollutant (*i.e.*, 2.0 for MY 2027 through 2030 and 1.5 for MY 2031 and later under Option 1, and 1.5 for MY 2027 and later under Option 2). We request comment on these or other off-cycle standards we should consider for Spark-ignition HDE, including whether we should include additional in-use bins if we finalize LLC or other duty cycles in the future.

TABLE III–24—POTENTIAL OFF-CYCLE EXHAUST EMISSION STANDARDS FOR SPARK-IGNITION HDE

Scenario	Model year	NO <sub>x</sub> (mg/hp-hr)	PM (mg/hp-hr)	HC (mg/hp-hr)	CO (g/hp-hr)
Proposed Option 1 .....	2027–2030 .....	70	10	120	12.0
	2031 and later .....	30	8	60	9.0
Proposed Option 2 .....	2027 and later .....	75	8	60	9.0

While we are not proposing off-cycle standards or a manufacturer-run in-use testing program for Spark-ignition HDE, we are soliciting comment on draft regulatory text that could be included in 40 CFR 1036.104 and 1036.515 and in 40 part CFR 1036, subpart E, with potential in-use provisions for Spark-ignition HDE.<sup>379</sup> Even without a regulatory requirement for manufacturers to perform field testing, these test procedures would be valuable for Spark-ignition HDE manufacturers or EPA to compare in-use emissions to the duty cycle standards. Manufacturers could also use the procedures to verify their DF under the proposed PEMS testing option in 40 CFR 1036.246. We request comment on adopting in-use test procedures and setting off-cycle standards for Spark-ignition HDE, including data to support the appropriate level of the standards.

ix. Potential Low Load Cycle and Standards

Heavy-duty gasoline engines are currently subject to FTP testing, and we are proposing a SET procedure to evaluate emissions performance of HD SI engines under the sustained high speeds and loads that can produce high emissions. We are also considering whether a low-load cycle could address the potential for high emissions from SI engines when catalysts may not maintain sufficient internal temperature to remain effective.

Section III.B of this preamble describes the LLC duty cycle and standards we are proposing for HD compression-ignition engines.<sup>380</sup> In our ANPR, we requested comment on the need for a low-load or idle cycle in general, and suitability of CARB’s diesel-targeted low-load and clean idle cycles for evaluating the emissions performance of heavy-duty gasoline engines. One commenter suggested the higher exhaust temperatures of SI engines made catalyst deactivation less of a concern so that a low load cycle was not warranted.<sup>381</sup>

As described in Section III.D.2.iv, we believe the proposed catalyst temperature control would effectively address idle emissions, but we recognize the value of demonstrating catalyst effectiveness during periods of prolonged idle and at low load, including when the vehicle accelerates from a stopped idle condition to higher speeds. We are soliciting comment on adopting a LLC duty cycle and standards for HD SI engines in addition to or in place of the idle control proposed in Section III.D.2.iv. We currently do not have test results demonstrating HD SI engine performance over the LLC duty cycle.

In considering Spark-ignition HDE standards over the LLC duty cycle, we solicit comment on applying LLC standards over the useful life periods of proposed Options 1 and 2 for the other

Spark-ignition HDE standards. We also solicit comment on adopting the same numeric level of the standards for the same pollutants under proposed Options 1 and 2 for CI engines over the proposed Spark-ignition HDE useful life periods. We request comment on the benefits and challenges of an LLC standard for HD SI compliance, and encourage commenters to include emission performance data over the LLC duty cycle or other cycles that they believe would cause manufacturers to improve the emissions performance of their heavy-duty SI engines under lower load operating conditions.

3. Feasibility Analysis for the Proposed Exhaust Emission Standards

This section describes the effectiveness and projected costs of the control technologies that we analyzed in developing our proposed Spark-ignition HDE exhaust emission standards. In evaluating technology feasibility, we considered impacts on energy by monitoring CO<sub>2</sub> emissions, the lead time manufacturers need to develop and apply control strategies and implement performance demonstrations, and the need to maintain utility and safety of the engines and vehicles.

Our feasibility analyses for the proposed Options 1 and 2 FTP and SET exhaust emission standards are based on the HD SI technology demonstration program summarized in this section and detailed in Chapter 3.2.2.3 of the draft RIA. Feasibility of the proposed FTP standards is further supported by compliance data submitted by manufacturers for the 2019 model year.

<sup>379</sup> Brakora, Jessica. Memorandum to Docket EPA–HQ–OAR–2019–0055. “Draft regulatory text for potential off-cycle standards and in-use test procedures for Spark-ignition HDE” July 21, 2021.

<sup>380</sup> See 40 CFR 1036.104 for the proposed LLC standards and § 1036.512 for the proposed test procedure.

<sup>381</sup> Roush comments (EPA–HQ–OAR–2019–0055–0303).

We also support the feasibility of the proposed Options 1 and 2 SET standards using engine fuel mapping data from a test program performed by the agency as part of the HD GHG Phase 2 rulemaking. See Chapter 3.2 of the draft RIA for more details related to these datasets.

i. Summary of Exhaust Emission Technologies Considered

This section summarizes the specific technologies and emission control strategies we considered as the basis for our proposed exhaust emission standards. The technologies presented in this section are described in greater detail in Chapters 1 and 3 of the draft RIA.

Our proposed Options 1 and 2 Spark-ignition HDE exhaust emission standards are based on the performance of the technology packages widely adopted for SI engines in chassis-certified vehicles today. We project manufacturers would meet our proposed standards by building on their existing TWC-based emission control strategies. Our technology demonstration evaluated advanced catalyst formulations, catalyst design changes including light-off catalysts located closer to the engine, engine down-speeding, and engine calibration

strategies that can minimize enrichment during high-load and accelerate light-off for lower load and idle operations.

The catalyst system and related exhaust components have progressed in recent light-duty applications and are currently able to tolerate significantly higher exhaust gas temperatures while still maintaining emission control over the current useful life. We expect that improved materials, such as the advanced catalyst formulations evaluated in our technology demonstration, along with more robust temperature management would result in significant emission reductions and engines that are able to meet the proposed standards. The advanced catalyst formulations we evaluated were aged to 250,000 miles, which is longer than the useful life mileages that would apply under proposed Options 1 and 2 for Spark-ignition HDE.<sup>382</sup>

Engine down speeding can help avoid the high speed, high exhaust gas temperature conditions that typically result in fuel enrichment due to engine component durability and catalyst thermal concerns. With the integration of modern multi-speed electronically controlled transmissions, this down speeding approach is extremely feasible and likely to also reduce engine wear

and improve fuel consumption with little perceptible effect on performance for commercial vehicle operation. In our demonstration program, we reduced the base engine's manufacturer-stated maximum test speed of 4715 RPM to 4000 RPM to evaluate the impact of engine down-speeding.

ii. Projected Exhaust Emission Technology Package Effectiveness

a. Technology Effectiveness Over the FTP Duty Cycle

Our HD SI technology demonstration program evaluated several pathways manufacturers could use to achieve the proposed Options 1 and 2 standards. As shown in Table III–25, use of advanced catalysts provided substantial NO<sub>x</sub> emission reductions over the FTP duty cycle beyond the performance demonstrated by technologies on recently certified engines.<sup>383</sup> Engine down-speeding further decreased CO emissions while maintaining NO<sub>x</sub>, NMHC, and PM control. Engine down-speeding also resulted in a small improvement in brake specific fuel consumption over the FTP duty cycle reducing from 0.46 to 0.45 lb/hp-hr. See Chapter 3.2.3 of the draft RIA for an expanded description of the test program and results.

TABLE III–25—EXHAUST EMISSION RESULTS FROM FTP DUTY CYCLE TESTING IN THE HD SI TECHNOLOGY DEMONSTRATION

	NO <sub>x</sub> (mg/hp-hr)	PM (mg/hp-hr)	NMHC (mg/hp-hr)	CO (g/hp-hr)
Proposed Option 1 Standards (MY 2027–2030) .....	35	5	60	6.0
Proposed Option 1 Standards (MY 2031 and later) .....	20	5	40	6.0
Proposed Option 2 Standards (MY 2027 and later) .....	50	5	40	6.0
Base Engine with Advanced Catalyst <sup>a</sup> .....	19	4.8	32	4.9
Down-spiced Engine with Advanced Catalyst <sup>b</sup> .....	18	4.5	35	0.25

<sup>a</sup> Base engine's manufacturer-stated maximum test speed is 4,715 RPM; advanced catalyst aged to 250,000 miles.

<sup>b</sup> Down-spiced engine's maximum test speed lowered to 4,000 RPM; advanced catalyst aged to 250,000 miles.

We expect manufacturers could achieve similar emission performance by adopting other approaches, including a combination of calibration changes, optimized catalyst location, and fuel control strategies that EPA was unable to evaluate in our demonstration program due to limited access to proprietary engine controls.

In addition to our demonstration program, we evaluated the feasibility of the proposed Options 1 and 2 FTP standards by considering the

performance of recently-certified engines. As detailed in Chapter 3.2.3.1 of the draft RIA, MY 2019 compliance data over the FTP duty cycle included the performance of six HD SI engine families from four manufacturers, representing the emission performance of all gasoline-fueled HD SI engines certified in MY 2019 as incomplete vehicles (*i.e.*, engine certified).

Table III–26 presents the manufacturer-reported MY 2019 levels for the three pollutants addressed by

TWCs: NO<sub>x</sub>, NMHC and CO.<sup>384</sup> PM emissions for most of these SI engines were undetectable and reported as zero for certification. In the table, we identify the six certified engines by descending NO<sub>x</sub> level and note that three of the six engines, representing over 70 percent of the MY 2019 engine-certified, gasoline-fueled HD SI engines, achieve a NO<sub>x</sub> level that is less than half the current standard of 0.20 g/hp-hr (*i.e.*, 200 mg/hp-hr). When calibrating their engines, SI manufacturers experience tradeoffs in

<sup>382</sup> Proposed Option 1 includes a useful life of 155,000 miles or 12 years for model years 2027 through 2030 and 200,000 miles or 15 years for model years 2031 and later. Proposed Option 2 includes a useful life of 150,000 miles or 10 years for model years 2027 and later. See Section IV.A.

for the development of our proposed useful life periods.

<sup>383</sup> As presented later in this section, MY 2019 gasoline-fueled HD SI engine certification results included NO<sub>x</sub> levels ranging from 29 to 160 mg/hp-hr at a useful life of 110,000 miles.

<sup>384</sup> U.S. EPA. "Heavy-Duty Highway Gasoline and Diesel Certification Data (Model Years: 2015–Present)". Available online: <https://www.epa.gov/sites/production/files/2020-01/heavy-duty-gas-and-diesel-engines-2015-present.xlsx>. Accessed June 2020.



TWC performance for the three pollutants and each manufacturer may optimize their emission controls differently while complying with

applicable emission standards. As expected, the certification results show no clear relationship between NMHC or CO emissions and the level of reduced

NO<sub>x</sub> among the various engine calibrations.

TABLE III–26—FTP DUTY CYCLE EMISSION LEVELS REPORTED FOR SIX ENGINE-CERTIFIED, GASOLINE-FUELED HD SI ENGINES IN MY 2019

	Cert Engine 1	Cert Engine 2	Cert Engine 3	Cert Engine 4	Cert Engine 5	Cert Engine 6
NO <sub>x</sub> (mg/hp-hr) <sup>a</sup> .....	160	120	104	89	70	29
NMHC (mg/hp-hr) <sup>a</sup> .....	50	60	80	42	80	42
CO (g/hp-hr) .....	3.7	6.6	8.6	1.5	12.7	2.3
Fraction of MY 2019 HD SI Gasoline-Fueled Engine Sales .....	2%	20%	4%	20%	48%	5%

<sup>a</sup> NO<sub>x</sub> and NMHC values are converted from g/hp-hr to mg/hp-hr to match the units of our proposed standards for NO<sub>x</sub> and HC, respectively.

To evaluate the NMHC and CO emissions, we calculated an overall average for each pollutant that includes all engines, and separately averaged a

smaller subset of the three engines (*i.e.*, Cert Engines 4–6) with the lowest NO<sub>x</sub> levels. Table III–27 compares these two averages with the EPA 2010 standards

and results from the engine family with the best NO<sub>x</sub> emission performance of the MY 2019 compliance data.

TABLE III–27—AVERAGE EMISSION PERFORMANCE FOR ENGINE-CERTIFIED, GASOLINE-FUELED HD SI ENGINES IN MY 2019

Pollutant	EPA 2010 standard	Overall average	Subset average	Best NO <sub>x</sub> performance
NO <sub>x</sub> (mg/hp-hr) <sup>a</sup> .....	200	95	63	29
NMHC (mg/hp-hr) <sup>a</sup> .....	140	59	55	42
CO (g/hp-hr) .....	14.4	5.9	5.5	2.3

<sup>a</sup> NO<sub>x</sub> and NMHC values are converted from g/hp-hr to mg/hp-hr to match the units of our proposed standards for NO<sub>x</sub> and HC, respectively.

Comparing the results in Table III–26 to the averages in Table III–27, we see that the overall average NMHC level of 59 mg/hp-hr and CO level of 5.9 g/hp-hr for the six engines are met by three engine families today. We expect at least one additional family could achieve the overall average NMHC and CO levels with calibration changes to adjust cold start catalyst light-off timing and refine the catalyst protection fuel enrichment levels. The NMHC and CO emissions averages for these MY 2019 engines align with our MY 2027 proposed Options 1 and 2 standards for those pollutants. The emission levels of the engine with the best NO<sub>x</sub> performance are approaching the levels we are proposing for our Option 1 MY 2031 standards. While these recent

certification results suggest it may be feasible for some manufacturers to meet the proposed Option 1 standards with current engine technology, it is less clear if the same emission levels could be maintained at the proposed useful life periods. We believe the combination of our proposed Option 1 standards and lengthened useful life would force some level of improved component durability or increased catalyst volumes beyond what is available on current HD SI engines and it will take additional time for manufacturers to develop their approach to complying.

b. Technology Effectiveness Over the SET Duty Cycle

As noted in Section III.D.2.iii, we are proposing Spark-ignition HDE standards

for the SET duty cycle to ensure emissions are controlled under high load and speed conditions. Our HD SI technology demonstration program evaluated emission performance over the SET duty cycle. As shown in Table III–28, the NO<sub>x</sub> and NMHC emissions over the SET duty cycle were substantially lower than the emissions from the FTP duty cycle (see Table III–25). Engine down-speeding improved CO emissions significantly, while NO<sub>x</sub>, NMHC, and PM remained low. Engine down-speeding also resulted in a small improvement in brake specific fuel consumption over the SET duty cycle reducing from 0.46 to 0.44 lb/hp-hr. See Chapter 3.2.3 of the draft RIA for an expanded description of the test program and results.

TABLE III–28—EXHAUST EMISSION RESULTS FROM SET DUTY CYCLE TESTING IN THE HD SI TECHNOLOGY DEMONSTRATION

	NO <sub>x</sub> (mg/hp-hr)	PM (mg/hp-hr)	NMHC (mg/hp-hr)	CO (g/hp-hr)
Proposed Option 1 Standards (MY 2027–2030) .....	35	5	60	6.0
Proposed Option 1 Standards (MY 2031 and later) .....	20	5	40	6.0
Proposed Option 2 Standards (MY 2027 and later) .....	50	5	40	6.0
Base Engine with Advanced Catalyst <sup>a</sup> .....	8	7	6	36.7
Down-spiced Engine with Advanced Catalyst <sup>b</sup> .....	5	3	1	7.21

<sup>a</sup> Base engine’s manufacturer-stated maximum test speed is 4,715 RPM; advanced catalyst aged to 250,000 miles.

<sup>b</sup> Down-spiced engine’s maximum test speed lowered to 4,000 RPM; advanced catalyst aged to 250,000 miles.

Similar to our discussion related to the FTP standards, we expect manufacturers could achieve similar emission performance over the SET duty cycle by adopting other approaches, including a combination of calibration changes, optimized catalyst location, and fuel control strategies that EPA was unable to evaluate due to limited access to proprietary engine controls.

To evaluate the impact of fuel enrichment and supplement our SET feasibility analysis, we created a surrogate array of SET test points using HD SI engine fuel mapping data from a HD GHG Phase 2 test program (see Chapter 3.2.3 of the draft RIA). The test

program tested a V10 gasoline engine on an early version of EPA’s steady-state fuel mapping procedure that requires the engine to be run for 90 seconds at each of nearly 100 speed and torque points.<sup>385</sup> The first 60 seconds at each point allowed the engine and fuel consumption to stabilize and the last 30 seconds were averaged to create the fuel map point.

For this analysis, we evaluated three subsets of the emissions data (NO<sub>x</sub>, NMHC, and CO) over the range of engine speeds and torque values. The first subset of data included conditions where the engine went into power enrichment, as indicated by the air-fuel ratio. The second subset of data

included conditions where the engine controller activated a catalyst protection fuel enrichment strategy before a power enrichment strategy was enabled. The third subset included only conditions where the engine maintained stoichiometric air-fuel ratio.

Peak torque points for each of these data subsets were used to calculate the A, B and C speeds and create three unique sets of surrogate SET test points. Emission rates for NO<sub>x</sub>, NMHC, and CO shown in Table III–29 were calculated by interpolating the data subsets at each of the SET test points. Finally, the results were weighted according to the existing CI-based weighting factors outlined in 40 CFR 86.1362.

TABLE III–29—EMISSION RATES CALCULATED FOR SURROGATE SET TEST POINTS FOR EACH DATA SUBSET

	NO <sub>x</sub> (mg/hp-hr)	NMHC (mg/hp-hr)	CO (g/hp-hr)
Proposed Option 1 Standards (MY 2027–2030) .....	35	60	6.0
Proposed Option 1 Standards (MY 2031 and later) .....	20	40	6.0
Proposed Option 2 Standards (MY 2027 and later) .....	50	40	6.0
Power Enrichment Allowed .....	11	110	45.2
Catalyst Protection with No Power Enrichment .....	19	30	11.4
Stoichiometric Operation .....	28	10	0.97

As observed in the surrogate SET test data, any enrichment mode, whether for power or catalyst protection purposes, resulted in substantial NMHC and CO emission increases from stoichiometric operation. When the engine was commanded into power enrichment mode and no longer maintained stoichiometric operation, NMHC and CO emissions rose 10 and 50 times higher, respectively. These results suggest that it is feasible for manufacturers to achieve low emission levels over the 13 modes of an SET duty cycle if their engines maintain stoichiometric operation. This can be accomplished with engine calibrations to optimize the TWC tradeoffs and fuel-air control strategies to limit preventable fuel enrichment.

iii. Derivation of the Proposed Standards

We are maintaining fuel neutrality of the proposed standards by applying the same numerical standards across all primary intended service classes. The proposed Options 1 and 2 NO<sub>x</sub> and PM levels for the FTP and SET duty cycles are based on the emission performance of technologies evaluated in our HD CI engine technology demonstration program.<sup>386</sup> We are basing the proposed Options 1 and 2 FTP and SET standards

for HC and CO on HD SI engine performance as described in Section III.D.3.ii and summarized in this section.

Results from our HD SI technology demonstration program (see Table III–25 and Table III–28) show that the proposed NO<sub>x</sub> standards based on our CI engine feasibility analysis are also feasible for HD SI engines over the FTP and SET duty cycles for both options. The proposed Option 1 MY 2031 NO<sub>x</sub> standard was achieved by implementing an advanced catalyst with minor catalyst system design changes, and NO<sub>x</sub> levels were further improved with engine down-speeding. The emission control strategies that we evaluated did not specifically target PM emissions, but we note that PM emissions remained low in our demonstration. We project HD SI engine manufacturers would be able to maintain near-zero PM levels with limited effort. We request comment on challenges manufacturers may experience to maintain effective PM control, including duty cycles other than FTP.

For proposed Option 1, starting in model year 2027, we are proposing to lower the HC and CO FTP standards consistent with the overall average NMHC and CO levels achieved by engine-certified, gasoline-fueled HD SI

engines over the FTP cycle today (see Table III–27). We note that the MY 2019 engine certified with the lowest NO<sub>x</sub> (*i.e.*, Cert Engine #6) is below our proposed MY 2027 NO<sub>x</sub> standard (35 mg/hp-hr) and maintains NMHC and CO emissions below those average levels on the FTP cycle. We are proposing the same standards of 60 mg HC/hp-hr and 6.0 g CO/hp-hr would apply over the new SET duty cycle starting in MY 2027. We believe emission levels based on average engine performance today would be a low cost step to update and improve emission performance across all certified Spark-ignition HDE, and serve as anti-backsliding standards as manufacturers optimize their TWCs, implement a new duty cycle, and improve component durability in response to the proposed longer useful life periods. CO levels in our SET demonstration were above the proposed standard, but manufacturers have opportunities to reduce CO below our proposed standard by optimizing their TWC calibrations and maintaining stoichiometric conditions over more of their high load operation (see Table III–29).

Proposed Option 2 (MY 2027 and later) and step 2 of proposed Option 1 (MY 2031 and later) include the same proposed numeric HC standards of 40

<sup>385</sup> The final version of this test procedure is outlined in 40 CFR 1036.535.

<sup>386</sup> Our assessment of the projected technology package for compression-ignition engines is based on both CARB’s and EPA’s technology

demonstration programs. See Section III.B for a description of those technologies and test programs.

mg HC/hp-hr and 6.0 g CO/hp-hr for the FTP and SET duty cycles. For the FTP duty cycle, results of our demonstration program show that the proposed HC standard would be achievable without compromising NO<sub>x</sub> or CO emission control (see Table III–25). For the SET duty cycle, lower levels of NMHC were demonstrated, but at the expense of increased CO emissions in those higher load operating conditions (see Table III–28). The considerably lower NO<sub>x</sub> and HC in our SET duty cycle demonstration results leave enough room for manufacturers to calibrate the tradeoff in TWC emission control of NO<sub>x</sub>, HC, and CO to reduce CO below our proposed CO standard. For these reasons, we are proposing the FTP standard of 40 mg HC/hp-hr standard apply over the SET duty cycle. Proposed Options 1 and 2 generally represent the range of lead time, standards, and useful life periods we are currently considering in this rule for HD SI engines.

We request comment on the proposed Spark-ignition HDE FTP and SET standards, including the appropriateness of applying the same numeric emission levels for both duty cycles. Commenters suggesting more stringent standards are encouraged to provide data showing lower standards are achievable at their suggested useful life periods. We also request comment on our approaches to maintain fuel neutrality by proposing numerically identical standards for heavy-duty CI and SI engines.

iv. Summary of Costs To Meet the Proposed Exhaust Emission Standards

To project costs for HD SI technology packages manufacturers could adopt to meet the proposed standards, we combined manufacturers' HD SI MY

2019 compliance data into sales-weighted averages by vehicle category to account for aftertreatment system differences by engine. The discussion below summarizes our estimate of the technology costs to meet our proposed Spark-ignition HDE standards. See Chapter 3.2.3 of the draft RIA for an expanded description of the projected sales-weighted average catalyst volumes, PGM loadings, and other factors used to calculate our costs for HD SI engines and Section V of this preamble for a summary of how these technology costs are included in the overall cost of this proposal.

We calculated aftertreatment system costs for four categories of SI engines. The largest category, liquid-fueled SI engines, includes engines fueled by gasoline, ethanol, and ethanol blends, and represents the majority of HD SI engines on the market today. The second category, gaseous-fueled SI engines, includes engines fueled by compressed natural gas (CNG) or liquified petroleum gas (LPG). In addition to the general gaseous-fueled SI engines, we separately analyzed two subsets of gaseous-fueled SI engines (HHD and urban bus) that have unique market shares and distinct aftertreatment demands.

Table III–30 summarizes the projected technology costs for HD SI engines to meet our proposed standards. Chapter 3.2.3 of the draft RIA contains a more detailed breakdown of the costs. Our projected costs for the liquid-fueled SI engines are based on the aftertreatment system used in our HD SI technology demonstration program (see Section III.D.3). As shown in our demonstration program, liquid-fueled SI engine manufacturers could use the same catalyst systems in both proposed

Options, including both steps (MY 2027 and 2031) of Option 1 to meet the proposed exhaust emission standards, so we projected a single cost. We request comment, including data, regarding calibration costs for manufacturers to optimize their Option 1 MY 2027 systems to meet the proposed Option 1 MY 2031 standards and costs for manufacturers to reprogram the existing electronics and software to down-speed their multi-speed transmissions. For this analysis, we assumed these costs would be part of the general research and development costs for the rule and did not separately quantify them. We did not make any additional cost adjustments to account for the proposed lengthened useful life, since the aftertreatment system used in the demonstration program represented catalysts aged to 250,000 miles.

We projected that most of the gaseous-fueled SI engines would include similar aftertreatment system upgrades as the liquid-fueled SI engines to meet the proposed standards and those costs are also summarized in Table III–30 and detailed in the draft RIA. The HHD and urban bus gaseous-fueled SI engine categories in our analysis had lower projected technology costs to meet the proposed standards. These two subsets include engines that were certified in MY 2019 to California's optional and more stringent 0.02 g/hp-hr NO<sub>x</sub> standard. We assumed no additional technology would be needed for these engines to meet the proposed standards in future model years. Our projected costs for these engines were limited to durability improvements to the catalyst substrate support structure (can material, mat, seals, etc.) to meet the requirements of our proposed lengthened useful life mileages.

TABLE III–30—SUMMARY OF SPARK-IGNITION HDE DIRECT MANUFACTURING PACKAGE COSTS

Cost packages (2019\$)	Liquid fueled SI engine	Gaseous fueled		
		SI engine	SI HHD	SI urban bus
Baseline Technology .....	\$322	\$365	\$3,348	\$2,511
Projected Technology .....	732	646	3,376	2,531
<i>Projected Technology Incremental</i> .....	<i>410</i>	<i>281</i>	<i>28</i>	<i>20</i>

4. Potential Alternative

We also considered the emissions impact of an alternative (the Alternative) that is more stringent than our proposed Option 1 MY 2031 standards when considering the combination of numeric level of the standards, length of useful life, and lead time (see Table III–31 through Table III–33). The Alternative matches our

proposed Option 1 MY 2031 FTP and SET standards for NO<sub>x</sub>, PM, and CO, but has lower (more stringent) HC standards, and starts four years earlier for all pollutant standards, in MY 2027. The useful life and warranty mileages for the Alternative are also longer than those of proposed Option 1 for MYs 2031 and later SI engines. As shown in Table III–25 and Table III–28, available data indicate that the combination of

NO<sub>x</sub>, HC, and CO emission levels over the longer useful life period reflected in the Alternative standards would be very challenging to meet in the MY 2027 timeframe.

We believe the additional lead time provided by the second step of the proposed Option 1 MY 2031 standards, combined with the higher numeric standard for HC and the shorter useful life mileage, results in the proposed

Option 1 standards being both feasible and technology forcing. Proposed Option 1 represents the most stringent range of lead time, standards, regulatory useful life periods, and emission-related warranty periods we are currently considering in this rule for HD SI engines unless we receive additional data to support a conclusion that the Alternative standards are feasible in the MY 2027 timeframe.

TABLE III-31—COMPARISON OF FTP STANDARDS IN THE HD SI ENGINE PROPOSED OPTIONS AND ALTERNATIVE

Scenario	Model years	NO <sub>x</sub> (mg/hp-hr)	PM (mg/hp-hr)	HC (mg/hp-hr)	CO (g/hp-hr)
Proposed Option 1 .....	2027–2030 .....	35	5	60	6.0
	2031 and later .....	20	5	40	6.0
Proposed Option 2 .....	2027 and later .....	50	5	40	6.0
	Alternative .....	20	5	10	6.0

TABLE III-32—COMPARISON OF SET STANDARDS IN THE HD SI ENGINE PROPOSED OPTIONS AND ALTERNATIVE

Scenario	Model years	NO <sub>x</sub> (mg/hp-hr)	PM (mg/hp-hr)	HC (mg/hp-hr)	CO (g/hp-hr)
Proposed Option 1 .....	2027–2030 .....	35	5	60	6.0
	2031 and later .....	20	5	40	6.0
Proposed Option 2 .....	2027 and later .....	50	5	40	6.0
	Alternative .....	20	5	10	6.0

TABLE III-33—COMPARISON OF USEFUL LIFE AND EMISSIONS WARRANTY MILEAGES IN THE HD SI ENGINE PROPOSED OPTIONS AND ALTERNATIVE

Scenario	Model years	Useful life mileage	Warranty mileage
Proposed Option 1 .....	2027–2030 .....	155,000	110,000
	2031 and later .....	200,000	160,000
Proposed Option 2 .....	2027 and later .....	150,000	110,000
	Alternative .....	250,000	200,000

See Section 5.2.2. for more details on how we used MOVES to model our proposed options and alternative scenarios for the inventory analysis. We projected the same HD SI technology costs would apply for proposed Options 1 and 2. We believe the range of the proposed Options 1 and 2 standards could be achieved with the same advanced catalyst system from our demonstration program with complete access to calibration controls. That same catalyst system was aged to cover the range of useful life mileages included in the proposed options. See Section V of this preamble and Chapter 7 of the draft RIA for a description of the overall costs of the proposed options. Since we do not currently have information to indicate that the Alternative standards are feasible in the MY 2027 timeframe with the emission control technologies we evaluated, we are not presenting an analysis of the costs of the Alternative.

5. Summary of Requests for Comment

For heavy-duty SI engines, we are requesting comment regarding the cost, feasibility, and appropriateness of our proposed Options 1 and 2 standards, duty cycles, and test procedure updates. See the previous sections for specific

requests for comment on each of those topics. When submitting comments, we request that commenters provide data, where possible, or additional references to support their positions.

We request comment on the implementation years of the program, the numeric levels of our proposed standards for FTP and SET duty cycles, and our approach to propose the same numeric standards for the two duty cycles and for both CI and SI engines.

We request comment on the proposed changes to test procedures, including the addition of the SET duty cycle and the disabling of AECs that impact peak torque during engine mapping. We request commenters to include data to support recommended modifications to the CI-based SET duty cycle or powertrain test procedures for SI engine testing. We also seek comment on whether adjustment factors, similar to IRAFs used for CI engines, should be applied to SI duty cycle results to account for the HC, CO, NO<sub>x</sub>, and PM emission increases that may occur due to enrichment AECs.

We introduced several proposals in this section intended to achieve emission reductions without the need for manufacturers to perform additional

tests. We are not proposing HD SI standards over the low load cycle or an idle test, but request comment on the need for these emission performance demonstrations in addition to or to replace our proposed procedures. We request comment on our proposed requirement that manufacturers maintain a catalyst temperature above 350 °C to ensure effective idle emission control or if an idle test procedure would be a better approach. Our proposed process to validate the accuracy of catalyst protection models is based on a 5 °C temperature allowance. We request comment on that allowance, the need for more specific procedures or technology specifications, and whether we should require continuous monitoring using temperature sensors instead of allowing the use of models. We are proposing flexibilities in OBD certifications for integrated engine manufacturers and request comment on additional flexibilities or restrictions we should consider.

*E. Summary of Spark-Ignition Heavy-Duty Vehicle Refueling Emission Standards and Test Procedures*

Compliance with evaporative and refueling emission standards is

demonstrated at the vehicle level. The vehicle manufacturers that produce HD SI engines sell complete vehicles and, in some instances, sell incomplete vehicles to secondary manufacturers. As noted in the following section, we are proposing refueling emission standards for incomplete vehicles above 14,000 lb GVWR under both proposed Options 1 and 2. These proposed standards would apply over a useful life of 15 years or 150,000 miles, whichever occurs first, consistent with existing evaporative emission standards for these vehicles. Evaporative and refueling emission standards currently apply for complete vehicles and we are not reopening or proposing to change those requirements in this rulemaking.

### 1. Current Refueling Emission Standard and Test Procedures

Spark-ignition engines generally operate with volatile liquid fuel (such as gasoline or ethanol) or gaseous fuel (such as natural gas or LPG) that have the potential to release high levels of evaporative and refueling HC emissions. As a result, EPA has issued evaporative emission standards that apply to vehicles powered by these engines.<sup>387</sup> Refueling emissions are evaporative emissions that result when the pumped liquid fuel displaces the vapor in the vehicle tank. Without refueling emission controls, most of those vapors are released into the ambient air. The HC emissions emitted are a function of temperature and the Reid Vapor Pressure (RVP).<sup>388</sup> The emissions control technology which collects and stores the vapor generated during refueling events is the Onboard Refueling Vapor Recovery (ORVR) system.

Light-duty vehicles and chassis-certified complete heavy-duty vehicles that are 14,000 lbs GVWR and under have been meeting evaporative and refueling requirements for many years. ORVR requirements for light-duty vehicles started phasing in as part of EPA's National Low Emission Vehicle (NLEV) and Clean Fuel Vehicle (CFV) programs in 1998.<sup>389</sup> In EPA's Tier 2 vehicle program, all complete vehicles with a GVWR of 8,500 to 14,000 lbs were required to phase-in ORVR requirements between 2004 and 2006

model years.<sup>390</sup> In the Tier 3 rulemaking, all complete vehicles were required to meet a more-stringent standard of 0.20 grams of HC per gallon of gasoline dispensed by MY 2022 (see 40 CFR 86.1813–17(b)).<sup>391</sup> Engine-certified incomplete heavy-duty vehicles that run on volatile liquid fuels have evaporative emission standards that phase in over model years 2018 through 2022, but the refueling standards were optional for incomplete vehicles.<sup>392</sup>

The current evaporative and refueling emissions test procedures in 40 CFR part 1066, subpart J, require that testing occur in a sealed housing evaporative determination (SHED) enclosure containing the complete vehicle. This procedure is used by all light-duty and heavy-duty complete vehicles subject to the refueling standards, and manufacturers have designed and built the SHEDs at their test facilities for these vehicles. Since evaporative and refueling emission control systems in heavy-duty vehicles are often larger versions of those used in light-duty vehicles, EPA's regulations allow manufacturers to certify their vehicles above 14,000 lb GVWR using an engineering analysis in lieu of providing test data.<sup>393</sup>

During a recent test program, EPA learned that very few SHEDs are available that could fit vehicles over 14,000 lb GVWR, as the length and height of these vehicles exceed the dimensions of most SHEDs.<sup>394 395</sup> Additionally, the limited number of large-volume SHEDs available at third-party laboratories have challenges in accurately measuring refueling emissions because of the very large volume inside the enclosures.<sup>396</sup> These measurement challenges do not currently impact manufacturers' ability to demonstrate compliance for current evaporative emissions standards

because the regulations allow manufacturers to submit an engineering analysis to demonstrate compliance in lieu of testing their heavier vehicles, and currently no HD SI engine manufacturers certify complete vehicles in the over-14,000 lb GVWR vehicle class where testing is required.

### 2. Proposed Updates to Refueling Requirements

As HD SI engines continue to improve in their ability to reduce exhaust emissions, evaporative emissions become an increasingly significant contributor to overall HC emissions. In response to our ANPR, ORVR suppliers commented in support of refueling requirements for incomplete heavy-duty vehicles, noting the industry's experience improving, testing, and implementing the technology.<sup>397</sup> We are proposing refueling emission standards for incomplete vehicles above 14,000 lb GVWR starting in model year 2027 (see 40 CFR 1037.103). We propose that these standards apply for a useful life of 15 years or 150,000 miles, whichever occurs first, consistent with the current useful life for evaporative emission standards in 40 CFR 86.1805. We are not proposing any change to the evaporative emission standards or the useful life for the evaporative standards. Since the refueling and evaporative emission standards are based on the use of similar fuel system-based technologies, it is appropriate that the useful life for the refueling standards be the same as the useful life for evaporative standards. This approach to useful life for our proposed refueling standards is consistent with the ORVR suppliers' comments.

Current refueling requirements are limited to complete vehicles, and all current heavy-duty SI engines for the over-14,000 lb GVWR vehicle classes are being certified as part of incomplete vehicles. As a result, hydrocarbon vapors from the largest HD SI engines are uncontrolled each time these vehicles are refueled. Results from a recent EPA test program found refueling emissions of more than 10 times the current light-duty ORVR standard for the two uncontrolled HD gasoline-fueled vehicles tested.<sup>398 399</sup> ORVR

<sup>390</sup> 65 FR 6698 (February 10, 2000).

<sup>391</sup> 79 FR 23414 (April 28, 2014) and 80 FR 0978 (February 19, 2015).

<sup>392</sup> Complete heavy-duty vehicles above 14,000 lb GVWR are subject to refueling standards starting in model year 2022. EPA has not yet received any certification applications for complete vehicles over 14,000 lb GVWR.

<sup>393</sup> 40 CFR 1037.103(c).

<sup>394</sup> SGS-Aurora, Eastern Research Group, "Light Heavy-Duty Gasoline Vehicle Evaporative Emissions Testing," EPA-420-R-19-017, December 2019.

<sup>395</sup> U.S. Environmental Protection Agency, "Summary of 'Light Heavy-Duty Gasoline Vehicle Evaporative Emissions Test Program'" EPA-420-S-19-002, December 2019.

<sup>396</sup> See Chapter 2.3 of the draft RIA for a summary of this test program and the challenges of applying a test procedure originally developed for light-duty vehicles to much larger chassis that are certified as incomplete vehicles.

<sup>397</sup> See comments from the Manufacturers of Emission Controls Association (EPA-HQ-OAR-2019-0055-0365) and Ingevity Corporation (EPA-HQ-OAR-2019-0055-0271).

<sup>398</sup> SGS-Aurora, Eastern Research Group, "Light Heavy-Duty Gasoline Vehicle Evaporative Emissions Testing," EPA-420-R-19-017, December 2019.

<sup>399</sup> U.S. Environmental Protection Agency, "Summary of 'Light Heavy-Duty Gasoline Vehicle Evaporative Emissions Test Program'" EPA-420-S-19-002, December 2019.

<sup>387</sup> 40 CFR 1037.103.

<sup>388</sup> E.M. Liston, American Petroleum Institute, and Stanford Research Institute. A Study of Variables that Effect the Amount of Vapor Emitted During the Refueling of Automobiles. Available online: [https://books.google.com/books/about/A\\_Study\\_of\\_Variables\\_that\\_Effect\\_the\\_Amo.html?id=KW2IGwAACAAJ](https://books.google.com/books/about/A_Study_of_Variables_that_Effect_the_Amo.html?id=KW2IGwAACAAJ).

<sup>389</sup> 62 FR 31192 (June 6, 1997) and 63 FR 926 (January 7, 1998).

systems include mature technologies that have been widely adopted in vehicles below 8,500 lb GVWR since model year 2000.<sup>400</sup> As we present in our feasibility discussion in Section III.E.3.ii, the fuel systems of these larger heavy-duty engines are similar to their chassis-certified counterparts and we expect manufacturers would generally be able to scale their existing light-duty systems to meet the needs of the larger fuel tanks in their heavy-duty engine products.

i. Proposed ORVR Test Procedure and HC Standard

We are proposing a refueling emission standard of 0.20 grams HC per gallon of liquid fuel for incomplete vehicles above 14,000 lb GVWR, which is the same as the existing refueling standard for complete vehicles.<sup>401</sup> We note that this proposed refueling emission standard would apply to all liquid-fueled Spark-ignition HDE, including gasoline and ethanol blends.<sup>402</sup> As described in Section III.D.3, we believe it is feasible for manufacturers to achieve this standard by adopting large-scale versions of the technology in use on complete vehicles. We request comment on our proposed standard.

The current provision in 40 CFR 1037.103(c) allows vehicles above 14,000 lb GVWR to demonstrate they meet evaporative and optional refueling standards using an engineering analysis that compares the system to one certified in a full-scale SHED demonstration. We propose to continue to allow manufacturers to demonstrate they meet the proposed refueling standards using an engineering analysis, and manufacturers would continue to use this provision in light of the SHED testing challenges summarized in Section III.E.1 and in Chapter 2.3 of the draft RIA. Nonetheless, in general we continue to view full-scale, vehicle SHED testing as the most accurate representation of real world evaporative and refueling emissions and consider it the preferred means of demonstrating refueling emission control performance for certification.

We are considering updates to adapt the current test procedures to accommodate vehicles in the greater

than 14,000 lb GVWR classes and to address the challenges highlighted in EPA's test program.<sup>403</sup> The light-duty procedures require full-scale vehicle testing using complete vehicles in SHED enclosures. The current test procedures and most existing SHED facilities were designed to test passenger vehicles and heavy-duty complete vehicles that are much smaller than commercial vehicles in the over-14,000 lb GVWR classes. While a limited number of third-party laboratories are available with larger SHED facilities, we identified two key updates needed to accurately adapt the current refueling procedures to larger SHEDs that would fit vehicles above 14,000 lb GVWR. As discussed in Chapter 2.3 of the draft RIA, we need to extend the mixing time for the larger volume of ambient air to reach a homogeneous distribution and identify a means to accurately calculate the diverse vehicle volumes that displace air in the enclosure. We currently have limited data to inform these updates and request comment, including data, on appropriate mixing times and approaches to calculating air displacement in larger SHED enclosures. Additionally, we request comment on other aspects of the current test procedures that could be improved for evaluating vehicles above 14,000 lb GVWR.

We also request comment on the conditioning procedure to prepare the canister for testing. The current preparatory cycle used by complete HD vehicles is modeled after light-duty vehicle driving patterns and vehicles typically with much smaller fuel tanks and canisters.<sup>404</sup> The current conditioning procedure is designed to challenge the purge system in scenarios such as heavy traffic, slow speeds and start-stop events over shorter drive distances and time. Heavy-duty vehicles, with larger fuel tanks and canisters, may drive more miles and longer time periods and have greater power demands that may help purge the larger canisters more easily than allowed in the current light duty vehicle test. Commercial vehicles typically experience more daily operation in traffic and on roads delivering goods but generally drive more miles and hours daily and operate under higher loads, which can accelerate the removal of vapors stored in the canister system from a diurnal or prior refueling event. We request comment on a specific canister conditioning cycle or adjustments to the current conditioning

cycle that would better represent real world loading for heavy-duty vehicles entering a refueling event.

We also request comment on additional ORVR performance demonstrations EPA should consider adopting. One option would be to allow manufacturers to evaluate the entire ORVR system of an incomplete vehicle (e.g., fuel tank, filler pipe, canister, control valves) separate from the vehicle body and chassis. Using an approach of only testing refueling components, manufacturers could use existing, widely-available chassis testing SHED enclosures, since there would no longer be a need to design expanded test cell volumes to accommodate the larger and more diverse vehicle configurations produced as incomplete vehicles. Similarly, an ORVR components test could also be performed in a smaller scale SHED (sometimes referred to as a "mini-SHED" or "rig SHED"), which is allowed by CARB for certain evaporative tests and was incorporated by reference as a phase-in option for evaporative emissions testing in our Tier 3 light-duty rulemaking.<sup>405</sup> A smaller SHED enclosure provides a simpler test methodology with further reduced variability. Since testing the refueling-related components independent of the vehicle eliminates the challenge of minimizing other hydrocarbon sources not associated with fuel or the fuel system (e.g., tires, plastics, paints), we request comment on the appropriate numeric level for the standard if evaluated using this simpler testing option, as the proposed standard is currently based on a full-vehicle test procedure. We request comment on these component-focused options or other alternatives, including specific test procedures, numeric standards, and appropriate canister conditioning cycles that we should consider to represent real world operation for these heavy-duty vehicles.

ii. Impact on Secondary Manufacturers

For incomplete vehicles above 14,000 lb GVWR, the chassis manufacturer performs the evaporative emissions testing and obtains the vehicle certificate from EPA. When the chassis manufacturer sells the incomplete vehicle to a secondary vehicle manufacturer, the chassis manufacturer provides specific instructions to the secondary manufacturer indicating what they must do to maintain the certified configuration, how to properly install components, and what, if any, modifications may be performed. For the evaporative emission system, a

<sup>400</sup> 65 FR 6698 (February 10, 2000).

<sup>401</sup> See our proposed updates to 40 CFR 1037.103.

<sup>402</sup> We are not proposing changes to the current refueling requirements that apply for gaseous-fueled Spark-ignition HDE. Vehicles above 14,000 lb GVWR that are fueled by CNG or LNG would continue to meet the fueling connection requirements (see 40 CFR 1037.103(d)) and fuel tank hold-time requirements (see 40 CFR 1037.103(e)), respectively, and would be deemed to comply with the newly applicable proposed refueling standard.

<sup>403</sup> Chapter 2.3 of the draft RIA summarizes this test program.

<sup>404</sup> 40 CFR 86.132–00.

<sup>405</sup> 40 CFR 86.1813–17(g)(3).

chassis manufacturer may require specific tube lengths and locations of certain hardware, and modifications to the fuel tank, fuel lines, evaporative canister, filler tube, gas cap and any other certified hardware would likely be limited.

We expect that the addition of any ORVR hardware and all ORVR-related aspects of the certified configuration would continue to be managed and controlled by the chassis manufacturer that holds the vehicle certificate. The engineering associated with all aspects of the fuel system design, which would include the ORVR system, is closely tied to the engine design, and the chassis manufacturer is the most qualified party to ensure its performance and compliance with applicable standards. Example fuel system changes the OEM may implement include larger canisters bracketed to the chassis frame close to the fuel tanks. Additional valves may be necessary to route the vapors to the canister(s) during refueling. Most other evaporative and fuel lines would remain in the same locations to meet existing evaporative requirements. There may be slightly different filler neck tube designs (smaller fuel transfer tube) as well as some additional tubes and valves to allow proper fuel nozzle turn-off (click off) at the pump, but this is not expected to include relocating the filler neck. Based on the comments received on the ANPR, we believe these changes would not adversely impact the secondary manufacturers finishing the vehicles.<sup>406</sup>

The instructions provided by the chassis manufacturer to the secondary manufacturer to meet our proposed refueling standards should include new guidelines to maintain the certified ORVR configuration. We do not expect the new ORVR system to require significant changes to the vehicle build process, since chassis manufacturers would have a business incentive to ensure that the ORVR system integrates smoothly in a wide range of commercial vehicle bodies. Accordingly, we do not expect that addition of the ORVR hardware would result in any appreciable change in the secondary manufacturer's obligations or require secondary builders to perform significant modifications to their products.

### 3. Feasibility Analysis for the Proposed Refueling Emission Standards

This section describes the effectiveness and projected costs of the

<sup>406</sup> See comments from the Manufacturers of Emission Controls Association (EPA-HQ-OAR-2019-0055-0365) and Ingevity Corporation (EPA-HQ-OAR-2019-0055-0271).

emissions technologies that we analyzed for our proposed refueling standards. Feasibility of the proposed refueling standard of 0.20 grams of HC per gallon is based on the widespread adoption of ORVR systems used in the light-duty and complete heavy-duty vehicle sectors. As described in this section, we believe manufacturers can effectively scale the technologies to larger engine applications to meet the proposed standard. For our inventory analysis, we assumed all heavy-duty gasoline-fueled vehicles that are identified as LHD, MHD and HHD regulatory subcategories in MOVES would implement ORVR systems starting in MY 2027 and we adjusted the refueling emission rates for those subcategories to reflect 100 percent implementation of a 0.20 grams of HC per gallon of gasoline rate in MY 2027. See Chapter 5.2.2 of the draft RIA for a discussion of our inventory model updates. The proposed refueling controls would lower refueling VOC and benzene emissions by 88.5 percent by 2045 for heavy duty gasoline vehicles over 14,000 lb GVWR. See the discussion and table in Chapter 5.3.3 of the draft RIA.

#### i. Summary of Refueling Emission Technologies Considered

This section summarizes the specific technologies we considered as the basis for our analysis of the proposed refueling emission standards. The technologies presented in this section are described in greater detail in Chapter 1.2.3 of the draft RIA.

Instead of releasing HC vapors into the ambient air, ORVR systems capture HC emissions during refueling events when liquid fuel displaces HC vapors present in the vehicle fuel tank as the tank is filled. These systems recover the HC vapors and store them for later purging from the system and use as fuel to operate the engine. An ORVR system consists of four main components that are incorporated into the existing fuel system: Filler pipe and seal, flow control valve, carbon canister, and purge system.

The filler pipe is the section of line from the fuel tank to where fuel enters the fuel system from the fuel nozzle. The filler pipe is typically sized to handle the maximum fill rate of liquid fuel allowed by law and integrates either a mechanical or liquid seal to prevent fuel vapors from exiting through the filler pipe to the atmosphere. The flow control valve senses that the fuel tank is getting filled and triggers a unique low-restriction flow path to the canister. The carbon canister is a container of activated charcoal designed to effectively capture and store fuel

vapors. Carbon canisters are already a part of HD SI fuel systems to control evaporative emissions. Fuel systems with ORVR would require additional capacity, by increasing either the canister volume or the effectiveness of the carbon material. The purge system is an electro-mechanical valve used to redirect fuel vapors from the fuel tank and canister to the running engine where they are burned in the combustion chamber.<sup>407</sup>

The fuel systems on over-14,000 lb GVWR incomplete heavy-duty vehicles are similar to those on complete heavy-duty vehicles that are currently subject to refueling standards. These incomplete vehicles may have slightly larger fuel tanks than most chassis-certified (complete) heavy-duty vehicles and are somewhat more likely to have dual fuel tanks. These differences may necessitate greater ORVR system storage capacity and possibly some unique accommodations for dual tanks (*e.g.*, separate fuel filler locations), as commented by ORVR suppliers in response to our ANPR.<sup>408</sup>

#### ii. Projected Refueling Emission Technology Packages

The ORVR emission controls we projected in our feasibility analysis build upon four components currently installed on incomplete vehicles above 14,000 lb GVWR to meet the Tier 3 evaporative emission standards: The carbon canister, flow control valves, filler pipe and seal, and the purge system. For our feasibility analysis, we assumed a 70-gallon fuel tank to represent an average tank size of HD SI incomplete vehicles above 14,000 lb GVWR. A summary of the projected technology updates and costs are presented below. See Chapter 3.2 of the draft RIA for additional details.

In order to capture the vapor volume of fuel tanks during refueling, we project manufacturers would increase canister vapor or "working" capacity of their liquid-sealed canisters by 15 to 40 percent depending on the individual vehicle systems. If a manufacturer chooses to increase the canister volume using conventional carbon, we project a canister meeting Tier 3 evaporative emission requirements with approximately 5.1 liters of conventional carbon would need up to an additional

<sup>407</sup> This process displaces some amount of the liquid fuel that would otherwise be used from the fuel tank and results in a small fuel savings. See Chapter 7.2.2 of the draft RIA for our estimate of the fuel savings from our proposed refueling standards.

<sup>408</sup> See comments from the Manufacturers of Emission Controls Association (EPA-HQ-OAR-2019-0055-0365) and Ingevity Corporation (EPA-HQ-OAR-2019-0055-0271).

1.8 liters of carbon to capture refueling emissions from a 70-gallon fuel tank. A change in canister volume to accommodate additional carbon would result in increased costs for retooling and additional canister plastic, as well as design considerations to fit the larger canister on the vehicle. Alternatively, a manufacturer could choose to add a second canister for the extra carbon volume to avoid the re-tooling costs. We estimate projected costs for both a single larger canister and two canisters in series. Another approach, based on discussions with canister and carbon manufacturers, could be for manufacturers to use a higher adsorption carbon and modify compartmentalization within the existing shell to increase the canister working capacity. We do not have data to estimate the performance or cost of higher adsorption carbon and so did not include this additional approach in our analysis.

The projected increase in canister volumes assume manufacturers would use a liquid seal in the filler pipe, which is less effective than a mechanical seal. For a manufacturer that replaces their liquid seal with a mechanical seal, we assumed an approximate 20 percent reduction in the necessary canister volume. Despite the greater effectiveness of a mechanical seal, manufacturers in the past have not preferred this approach because it introduces another wearable part that can deteriorate, introduces safety concerns, and may require replacement during the useful life of the vehicle. To meet the proposed ORVR standards, manufacturers may choose the mechanical seal design to avoid retooling charges and we included it in

our cost analysis. We assumed a cost of \$10.00 per seal for a manufacturer to convert from a liquid seal to a mechanical seal. We assumed zero cost in our analysis for manufacturers to maintain their current liquid seal approach for filler pipes. While some of the largest vehicle applications with unique tank locations or designs without filler necks may need additional hardware modifications to provide enough back pressure to stop the nozzle flow and avoid spitback, we believe the cost is similar to converting to a mechanical seal, and we did not differentiate these low volume applications in our cost analysis.

In order to manage the large volume of vapors during refueling, manufacturers' ORVR updates would include flow control valves integrated into the roll-over/vapor lines. We assumed manufacturers would, on average, install one flow control valve per vehicle that would cost \$6.50 per valve. And lastly, we project manufacturers would update their purge strategy to account for the additional fuel vapors from refueling. Manufacturers may add hardware and optimize calibrations to ensure adequate purge in the time allotted over the preconditioning drive cycle of the demonstration test.

Table III-34 presents the ORVR system specifications and assumptions used in our cost analysis, including key characteristics of the baseline incomplete vehicle's evaporative emission control system. Currently manufacturers size the canisters of their Tier 3 evaporative emission control systems based on the diurnal test and the Bleed Emission Test Procedure (BETP).<sup>409</sup> During the diurnal test, the

canister is loaded with hydrocarbons over two or three days, allowing the hydrocarbons to load a conventional carbon canister (1500 GWC, gasoline working capacity) at a 70 percent efficiency. In contrast, a refueling event takes place over a few minutes, and the ORVR directs the vapor from the gas tank onto the carbon in the canister at a canister loading efficiency of 50 percent. For our analysis, we added a design safety margin of 10 percent extra carbon to our ORVR systems. While less overall vapor mass may be vented into the canister from the fuel tank during a refueling event compared to the three-day diurnal test period, a higher amount of carbon is needed to contain the faster rate of vapor loaded at a lower efficiency during a refueling event. These factors were used to calculate the canister volumes for the two filler neck options in our cost analysis.

The assumed purge system updates are also shown in Table III-34. The diurnal drive cycle duration is 30 minutes and targets 200 bed volumes of purge to clean the canister before the evaporative emissions test. The bed volumes of purge are multiplied by the canister volume to calculate the total target purge volume. The total purge volume divided by the number of minutes driving gives us the average purge rate. An ORVR demonstration would also require conditioning of the canister in preparation for the ORVR test. The current conditioning cycle used by complete vehicles consists of a 97-minute drive cycle to prepare the canister.<sup>410</sup> However, as indicated in the table, a larger target bed volume may be needed to purge the larger canister capacity required for ORVR.

TABLE III-34—ORVR SPECIFICATIONS AND ASSUMPTIONS USED IN THE COST ANALYSIS FOR HD SI INCOMPLETE VEHICLES ABOVE 14,000 LB GVWR

	Tier 3 Baseline	ORVR Filler Neck Options	
	Diurnal	ORVR	
		Mechanical seal	Liquid seal
Diurnal Heat Build .....	72–96 °F	80 °F	.....
RVP .....	9 psi	.....	.....
Nominal Tank Volume .....	70 gallons	.....	.....
Fill Volume .....	40%	10% to 100%	.....
Air Ingestion Rate .....	.....	0%	13.50%
Mass Vented per heat build, g/d .....	120	.....	.....
Mass Vented per refueling event .....	.....	255	315
Hot Soak Vapor Load .....	5	.....	.....
Mass vented over 48-hour test .....	227.2	.....	.....
Mass vented over 72-hour test .....	323.3	.....	.....
1500 GWC, g/L (Efficiency) <sup>a</sup> .....	70	50	50

<sup>409</sup> 40 CFR 86.1813–17(a).

<sup>410</sup> Trucks with larger fuel tanks typically will drive more miles in a day and between refueling events. As noted in Section III.E.2, we are

requesting comment on updating our canister preconditioning driving procedure in order to better represent the operation of these larger vehicles.



TABLE III-34—ORVR SPECIFICATIONS AND ASSUMPTIONS USED IN THE COST ANALYSIS FOR HD SI INCOMPLETE VEHICLES ABOVE 14,000 LB GVWR—Continued

	Tier 3 Baseline	ORVR Filler Neck Options	
	Diurnal	ORVR	
		Mechanical seal	Liquid seal
Excess Capacity .....	10%	10%	10%
Estimated Canister Volume Requirement, liters <sup>b</sup>			
48-hour Evaporative only .....	3.6		
72-hour Evaporative only .....	5.1		
Total of 72-hour + ORVR <sup>c</sup> .....		5.6	6.9
Limiting Drive Cycle, minutes .....	30	97	97
Target Bed Volumes of Purge <sup>d</sup> .....	200	646	646
Total Purge Volume, liters <sup>e</sup> .....	1020	3618	4457
Average Purge Rate, LPM <sup>f</sup> .....	34	37	46
BETP Purge .....		37	46

<sup>a</sup> Efficiency of conventional carbon.

<sup>b</sup> Canister Volume = 1.1(mass vented)/1500 GWC (Efficiency).

<sup>c</sup> ORVR adds .5 liters and 1.8 liters for Mechanical Seal and Liquid Seal respectively.

<sup>d</sup> ORVR estimated volumes based on ratio of increased driving distance in ORVR procedure and not necessarily reflective of necessary volumes to sufficiently purge canister.

<sup>e</sup> Total Purge Volume, Liters = canister volume, liters \* Bed Volumes Purge.

<sup>f</sup> Average Purge Rate, LPM = Total Purge Volume, liters/Limiting Drive Cycle, minutes.

The ORVR components described in this section represent technologies that we think most manufacturers would adopt to meet our proposed refueling requirements. It is possible that manufacturers may choose a different approach, or that unique fuel system characteristics may require additional hardware modifications not described here, but we do not have reason to believe costs would be significantly higher than presented here. We request comment, including data, on our

assumptions related to the increased canister working capacity demands, the appropriateness of our average fuel tank size, the technology costs for the specific ORVR components considered and any additional information that can improve our cost projections in the final rule analysis.

iii. Summary of Costs To Meet the Proposed Refueling Emission Standards

Table III-35 shows cost estimations for the different approaches evaluated.

In calculating the overall cost of our proposed program, we used \$25, the average of both approaches, to represent the cost for manufacturers to adopt the additional canister capacity and hardware to meet our proposed refueling emission standards for incomplete vehicles above 14,000 lb GVWR. See Section V of this preamble for a summary of our overall program cost and Chapter 7 of the draft RIA for more details.

TABLE III-35—SUMMARY OF PROJECTED PER-VEHICLE COSTS TO MEET THE PROPOSED REFUELING EMISSION STANDARDS

	Liquid seal		Mechanical seal	
	New canister	Dual existing canisters in series	New canister	Dual existing canisters in series
Additional Canister Costs .....	\$20	\$15	\$8	\$8
Additional Tooling <sup>a</sup> .....	0.50		0.50	
Flow Control Valves .....	6.50		6.50	
Seal .....	0	0	10	
Total <sup>b</sup> .....	27	22	25	

<sup>a</sup> Assumes the retooling costs are spread over a five-year period.

<sup>b</sup> Possible additional hardware for spitback requirements.

Incomplete vehicles above 14,000 lb GVWR with dual fuel tanks may require some unique accommodations to adopt ORVR systems. A chassis configuration with dual fuel tanks would need separate canisters and separate filler pipes and seals for each fuel tank. Depending on the design, a dual fuel tank chassis configuration may require a

separate purge valve for each fuel tank. We assume manufacturers would install one additional purge valve for dual fuel tank applications that also incorporate independent canisters for the second fuel tank/canister configuration and manufacturers adopting a mechanical seal in their filler pipe would install an anti-spitback valve for each filler pipe.

See Chapter 1.2.4.5 of the draft RIA for a summary of the design considerations for these fuel tank configurations. We did not include an estimate of the population or impact of dual fuel tank vehicles in our cost analysis of our proposed refueling emission standards.

#### 4. Summary of Requests for Comment

We are requesting comment regarding the cost, feasibility, and appropriateness of our proposed refueling emission standard for incomplete vehicles above 14,000 lb GVWR. The proposed standard is based on the current refueling standard that applies to complete heavy-duty gasoline-fueled vehicles. We are proposing that compliance with these standards may be demonstrated under an existing regulatory provision by using an engineering analysis due to uncertainties related to testing these larger vehicles. We request comment on approaches to adapt the current test procedures used by lower GVWR vehicles for vehicles above 14,000 lb GVWR. Specifically, we are interested in comments including data or established procedures to calculate appropriate mixing times and air displacement in larger SHED enclosures. We also request comment on the appropriate conditioning procedure for these larger vehicles. Finally, we request comment on other testing options we should consider for manufacturers to demonstrate the effectiveness of their ORVR systems on incomplete vehicles above 14,000 lb GVWR.

#### IV. Compliance Provisions and Flexibilities

EPA certification is a fundamental requirement of the Clean Air Act for manufacturers of heavy-duty highway engines. EPA has employed significant discretion over the past several decades in designing and updating many aspects of our heavy-duty engine and vehicle certification and compliance programs. In the following sections, we discuss several proposed provisions that we believe would increase the effectiveness of our regulations, including some opportunities to streamline existing requirements. Unless explicitly stated otherwise, the proposed provisions in this Section IV would apply to proposed Options 1 and 2, as well as the full range of options in between them.

As noted in Section I, we are proposing to migrate our criteria pollutant regulations for model years 2027 and later heavy-duty highway engines from their current location in 40 CFR part 86, subpart A, to 40 CFR part 1036.<sup>411</sup> Consistent with this migration, the proposed compliance provisions discussed in this section refer to the proposed regulations in their new

location in part 1036. In general, this migration is not intended to change the compliance program previously specified in part 86, except as specifically proposed in this rulemaking. See our memorandum to the docket for a detailed description of the proposed migration.<sup>412</sup>

##### A. Regulatory Useful Life

In addition to emission standards and test procedures discussed in Section III, appropriate regulatory useful life periods are critical to assure emission performance of heavy-duty highway engines. Our regulations require manufacturers to perform durability testing to demonstrate that engines will meet emission standards not only at certification but also over the full useful life periods specified by EPA. Useful life represents the period over which emission standards apply for certified engines, and, practically, any difference between the regulatory useful life and the generally longer operational life of in-use engines represents miles and years of operation without an assurance that emission standards will continue to be met.

In this section, we describe our estimates of the length of operational lives of heavy-duty highway engines, which are almost double the current useful life mileages in EPA's regulations for all primary intended service classes. EPA is proposing to increase the regulatory useful life mileage values for new heavy-duty engines to better reflect real-world usage, extend the emissions durability requirement for heavy-duty engines, and improve long-term emission performance. Our proposed longer useful life periods for heavy-duty engines vary by engine class to reflect the different lengths of their estimated operational lives. As described in Section III, the proposed numeric levels of the standards are the same across engine classes and are based on the feasibility of achieving those standards at the proposed useful life mileages. Proposed Option 1 useful life periods would apply in two steps in MY 2027 and MY 2031 and proposed Option 2 useful life periods would apply in a single step in MY 2027.

For CI engines, the proposed Option 1 useful life mileage values for MY 2031 and later are based on data on the average periods to the first out-of-frame rebuild for these engines. Our CI engine demonstration, which is based on the

emission performance of an engine in the Heavy HDE class, projects the engine can achieve the proposed standards for MY 2031 at the proposed useful life mileage.<sup>413</sup> Our demonstration data does not currently show that it is feasible to achieve the proposed Option 1 MY 2027 standards at the MY 2031 useful life mileages, and the proposed Option 1 useful life mileage values for MY 2027 through 2030 are approximately a midpoint between the current useful life mileages and our proposed Option 1 MY 2031 and later mileages.

Similarly, the proposed Option 1 would increase useful life mileages in two steps for the proposed standards for heavy-duty SI engines that are not chassis-certified. Our proposed Option 1 first step for these SI engines in MY 2027 through 2030 would better align with the current useful life mileages for GHG emission standards applicable to these engines and for chassis-certified complete vehicles containing these engines. The proposed Option 1 second step for these SI engines in MY 2031 and later would be based on the expected engine service life for heavy-duty gasoline engines in the market today. The SI demonstration program showed that the proposed Option 1 standards are feasible over the proposed Option 1 useful life mileages.

In our ANPR, we presented CI engine rebuild data and noted that we intended to propose useful life mileage values for all categories of heavy-duty engines that are more reflective of real-world usage. Comments received on the ANPR included varied support for increasing engine useful life values. Environmental organizations and state, local, and Tribal air agencies largely supported lengthened useful life, and many supported aligning with CARB's HD Omnibus rulemaking. Among the sixteen state, local, and Tribal governments and related associations that expressed support, the National Tribal Air Association stated that longer useful life requirements would lead to longer design life targets for emissions systems commensurate with actual vehicle service lengths.<sup>414</sup> The International Council on Clean Transportation (ICCT) commented that EPA should harmonize useful life requirements with California and stated that it could be possible to double the

<sup>413</sup> Demonstrating feasibility for the Heavy HDE class indicates feasibility for the smaller CI engine classes, Medium HDE, and Light HDE, which could adopt similar technologies to meet the standards and have shorter proposed useful life periods over which to demonstrate the performance.

<sup>414</sup> See comments from NTAA, Docket ID EPA-HQ-OAR-2019-0055-0282.

<sup>411</sup> As noted in the following sections, we are proposing some updates to 40 CFR parts 1037, 1065, and 1068 to apply to other sectors in addition to heavy-duty highway engines.

<sup>412</sup> Stout, Alan; Brakora, Jessica. Memorandum to docket EPA-HQ-OAR-2019-0055. "Technical Issues Related to Migrating Heavy-Duty Highway Engine Certification Requirements from 40 CFR part 86, subpart A, to 40 CFR part 1036". October 1, 2021.

useful life of the emission control systems with available technologies.<sup>415</sup>

Other commenters expressed cautious support. The Manufacturers of Emission Controls Association (MECA) and Motor and Equipment Manufacturers Association (MEMA) supported extending useful life with a phased approach that allows suppliers time to design, test, and address issues with their components' durability beyond today's requirements.<sup>416 417</sup> Several commenters expressed concern related to the cost of extending longer useful life periods. The American Truck Dealers Division of the National Automobile Dealers Association (NADA) stated that longer useful life periods may be warranted given the increasing number of miles heavy-duty engines accumulate prior to engine rebuild.<sup>418</sup> NADA asked EPA to carefully assess higher up-front engine costs associated with longer useful life periods and the potential for reduced maintenance and repair costs resulting from increased useful life. Volvo stated that more durable components are not available "to pull from the shelf" and costs to extend the life of those components could result in significant costs either to improve the components or incorporate a replacement as part of the manufacturer's scheduled maintenance.<sup>419</sup> Volvo also expressed concern that second and third owners may use the vehicles for applications that could stress the engine and its systems and threaten emissions compliance within a lengthened useful life. The Truck and Engine Manufacturers Association (EMA) and Cummins commented that EPA should carefully evaluate the benefits of extending the useful life period.<sup>420 421</sup> EMA stated a longer useful life could require the replacement of aftertreatment systems during the lengthened period.

We note that as manufacturers develop compliance strategies to meet our proposed emission standards and

lengthened useful life periods, they have the ability to design for increased durability of their engine and emission controls and to create maintenance instructions describing how to clean, repair, or replace emission components at specified intervals subject to the limitations in our proposed maintenance provisions.<sup>422</sup> To address the feasibility of meeting the proposed standards over the proposed useful life periods, the technology demonstration projects described in Section III of this preamble include demonstrating the durability and emissions performance of CI and SI engines over mileages that cover the range of useful life mileages being considered. We believe our proposed useful life periods are feasible and would not require manufacturers to adopt component replacement as part of their critical emission-related maintenance strategies.

#### 1. History of Regulatory Useful Life

The Clean Air Act specifies that emission standards under section 202(a) "shall be applicable to such vehicles and engines for their useful life . . . whether such vehicles and engines are designed as complete systems or incorporate devices to prevent or control such pollution." Practically, this means that to receive an EPA certificate of conformity under the CAA, a manufacturer must demonstrate that an engine or vehicle, including the aftertreatment system, will meet each applicable emission standard, including accounting for deterioration, over the useful life period specified in EPA's regulations. In addition, CAA section 207(c) requires manufacturers to recall and repair vehicles or engines if the Administrator determines that "a substantial number of any class or category of vehicles or engines, although properly maintained and used, do not conform to the regulations prescribed under [section 202(a)], when in actual use throughout their useful life (as determined under [section 202(d)])." Taken together, these sections define two critical aspects of regulatory useful life: (1) The period over which the manufacturer must demonstrate compliance with emissions standards to obtain EPA certification, and (2) the period for which the manufacturer is subject to in-use emissions compliance liability, *e.g.*, for purposes of recall. Manufacturers perform durability

testing to demonstrate that engines will meet emission standards over the full useful life. Manufacturers may perform scheduled maintenance on their test engines only as specified in the owner's manual. As part of the certification process, EPA approves such scheduled maintenance, which is also subject to minimum maintenance intervals as described in the regulation. See Section IV.F for a description of the current and proposed durability requirements and Section IV.B.5 for more information on our current and proposed maintenance provisions. Manufacturer obligations under recall are specified in 40 CFR 1068, subpart F, and we are not proposing to update our recall provisions.

EPA prescribes regulations under CAA section 202(d) for determining the useful life of vehicles and engines. CAA section 202(d) provides that the minimum useful life for heavy-duty vehicles and engines is a period of 10 years or 100,000 miles, whichever occurs first. This section authorizes EPA to adopt longer useful life periods that we determine to be appropriate. Under this authority, we established useful life periods for heavy-duty engines by primary intended service class. As introduced in Section I, heavy-duty highway engine manufacturers identify the primary intended service class for each engine family by considering the vehicles for which they design and market their engines.<sup>423</sup> Heavy-duty compression-ignition engines are distinguished by their potential for rebuild and the weight class of the final vehicles in which the engines are expected to be installed.<sup>424</sup> Heavy-duty spark-ignition engines are generally classified as a single "spark-ignition" service class unless they are designed or intended for use in the largest heavy-duty vehicles and are thereby considered heavy heavy-duty engines.<sup>425</sup>

<sup>415</sup> See comments from ICCT, Docket ID EPA-HQ-OAR-2019-0055-0304.

<sup>416</sup> See comments from MECA, Docket ID EPA-HQ-OAR-2019-0055-0365.

<sup>417</sup> See comments from MEMA, Docket ID EPA-HQ-OAR-2019-0055-0462.

<sup>418</sup> See comments from NADA, Docket ID EPA-HQ-OAR-2019-0055-0369.

<sup>419</sup> See comments from Volvo, Docket ID EPA-HQ-OAR-2019-0055-0463.

<sup>420</sup> See comments from EMA, Docket ID EPA-HQ-OAR-2019-0055-0273.

<sup>421</sup> See comments from Cummins, Docket ID EPA-HQ-OAR-2019-0055-0359.

<sup>422</sup> See Section IV.B.5 of this preamble and proposed 40 CFR 1036.125.

<sup>423</sup> See 40 CFR 1036.140 as referenced in the definition of "primary intended service class" in 40 CFR 86.090-2.

<sup>424</sup> As specified in the current 40 CFR 1036.140(a), light heavy-duty engines are not designed for rebuild and are normally installed in vehicles at or below 19,500 pounds GVWR; medium heavy-duty engines may be designed for rebuild and are normally installed in vehicles from 19,501 to 33,000 lbs GVWR; heavy heavy-duty engines are designed for multiple rebuilds and are normally installed in vehicles above 33,000 pounds GVWR.

<sup>425</sup> See 40 CFR 1036.140(b).

The following useful life periods currently apply to the criteria pollutant emission standards for heavy-duty highway engines:<sup>426 427</sup>

- 110,000 miles or 10 years for heavy-duty spark-ignition engines and light heavy-duty compression-ignition engines
- 185,000 miles or 10 years for medium heavy-duty compression-ignition engines
- 435,000 miles, 10 years, or 22,000 hours for heavy heavy-duty compression-ignition engines

In our 1983 rulemaking, which first established class-specific useful life values for heavy-duty engines and vehicles, EPA adopted the principle that useful life mileage values should reflect the typical mileage to the first rebuild of the engine (or scrappage of the engine if that occurs without rebuilding).<sup>428</sup> Significantly, this approach was adopted at a time when diesel engine emission control strategies relied mainly on in-cylinder engine combustion controls.

Over time, mileage values became the primary metric for useful life duration. This is because, due to advancements in general engine durability, nearly all heavy-duty engines reach the mileage value in-use long before 10 years have elapsed. The age (years) value has meaning for only a small number of low-annual-mileage applications, such as refuse trucks. Also, manufacturer durability demonstrations generally target the mileage values, since deterioration is a function of engine work and hours rather than years in service and a time-based demonstration would be significantly longer in duration than one based on applicable mileage value.

In the 1997 rulemaking that most recently increased heavy-duty engine useful life, EPA included an hours-

based useful life of 22,000 hours for the heavy heavy-duty engine intended service class. This unique criterion was added to address the concern that urban vehicles, particularly urban buses, equipped with heavy heavy-duty engines had distinctly different driving patterns compared to the line-haul trucks from which the agency based its useful life value of 435,000 miles.<sup>429</sup> Commenters in that rulemaking indicated that urban bus average speed was near 13 miles per hour. Considering that speed, many of these bus engines would reach the end of their operational life or be candidates for rebuild before the applicable mileage value or the 10-year criterion is reached. The 22,000 hours value was adopted in lieu of a proposed minimum useful life value of 290,000 miles for heavy heavy-duty engines. Considering the current 435,000 useful life mileage for heavy heavy-duty engines, the 22,000-hour useful life value only has significance for the small subset of vehicles equipped with heavy heavy-duty engines with an average speed of less than 20 miles per hour.

In the Phase 1 GHG rulemaking, we promulgated useful life periods for the GHG emission standards for heavy-duty highway engines and their corresponding heavy-duty vehicles that aligned with the current useful life periods for criteria pollutant emission standards.<sup>430</sup> In the HD Phase 2 GHG rulemaking, we extended the useful life for Light HDV, light heavy-duty engines, and spark-ignition engines for the GHG emission standards to 15 years or 150,000 miles to align with the useful life of chassis-certified heavy-duty vehicles subject to the Tier 3 standards.<sup>431</sup> See 40 CFR 1036.108 and 40 CFR 1037, subpart B, for the GHG useful life periods that apply for heavy-duty highway engines and vehicles, respectively. We are not proposing changes to the useful life periods for GHG emission standards in this rulemaking.

## 2. Identifying Appropriate Useful Life Periods

Emission standards apply for the engine's useful life and manufacturers must demonstrate the durability of

engines to maintain certified emission performance over their useful life. Thus, the proposed emission standard options presented in Section III must be considered together with their associated proposed useful life periods. Larger useful life mileage values would require manufacturers to demonstrate emission performance over a longer period and should result in effective emission control over a greater proportion of an engine's operational (sometimes referred to as "service") life. Consistent with our approach to adopting useful life mileages in the 1983 rulemaking, we continue to consider a comprehensive out-of-frame rebuild to represent the end of a heavy-duty CI engine's "first life" of operation. For SI engines that are less commonly rebuilt, engine replacement would be a more appropriate measure of an engine's operational life. Our proposed Option 1 useful life values are based on the expected operational life of the engine or, for CI engines, an estimate of the point at which an engine is typically rebuilt. We expand on this approach in the following sections. We discuss the basis of proposed Option 2 useful life values in Section IV.A.3.

### i. Compression-Ignition Engine Rebuild Data

In 2013, EPA commissioned an industry characterization report on heavy-duty diesel engine rebuilds.<sup>432</sup> The report relied on existing data from MacKay & Company surveys of heavy-duty vehicle operators. In this report, an engine rebuild was categorized as either an in-frame overhaul (where the rebuild occurred while the engine remained in the vehicle) or an out-of-frame overhaul (where the engine was removed from the vehicle for more extensive service).<sup>433</sup> The study showed that the mileage varied depending on the type of rebuild. Rebuilding an engine while the block remained in the frame was typically done at lower mileage than rebuilding an engine removed from the vehicle. The results of the study by vehicle weight class are presented in Table IV-1.

<sup>432</sup> ICF International, "Industry Characterization of Heavy Duty Diesel Engine Rebuilds" EPA Contract No. EP-C-12-011, September 2013.

<sup>433</sup> Note that these mileage values reflect replacement of engine components, but do not include aftertreatment components. At the time of the report, the population of engines equipped with DPF and SCR technologies was limited to relatively new engines that were not candidates for rebuild.

<sup>426</sup> See 40 CFR 86.004-2. EPA adopted useful life values of 110,000, 185,000, and 290,000 miles for light, medium, and heavy heavy-duty engines, respectively, in 1983 (48 FR 52170, November 16, 1983). The useful life for heavy heavy-duty engines was subsequently increased to 435,000 miles for 2004 and later model years (62 FR 54694, October 21, 1997).

<sup>427</sup> The same useful life periods apply for heavy-duty engines certifying to the greenhouse gas emission standards, except that the spark-ignition standards and the standards for model year 2021 and later light heavy-duty engines apply over a useful life of 15 years or 150,000 miles, whichever comes first. See 40 CFR 1036.108(d).

<sup>428</sup> U.S. EPA, "Summary and Analysis of Comments on the Notice of Proposed Rulemaking for Revised Gaseous Emission Regulations for 1984 and Later Model Year Light-Duty Trucks and Heavy-Duty Engines", July 1983, p 43.

<sup>429</sup> U.S. EPA, "Summary and Analysis of Comments: Control of Emissions of Air Pollution from Highway Heavy-Duty Engines", EPA-420-R-97-102, September 1997, pp 43-47.

<sup>430</sup> 76 FR 57181, September 15, 2011.

<sup>431</sup> See 79 FR 23414, April 28, 2014 and 81 FR 73496, October 25, 2016.

TABLE IV-1—AVERAGE MILEAGE AND AGE AT FIRST REBUILD FOR HEAVY-DUTY CI ENGINES FROM 2013 EPA REBUILD INDUSTRY CHARACTERIZATION REPORT

Vehicle weight class	In-frame rebuild		Out-of-frame rebuild	
	Mileage	Years	Mileage	Years
Class 3 .....	216,900	9.5	256,000	9.5
Class 4 .....	236,800	11.6	346,300	10.3
Class 5 .....	298,300	10.9	344,200	11.9
Class 6 .....	332,200	13.0	407,700	10.6
Class 7 .....	427,500	15.8	509,100	13.2
Class 8 .....	680,200	11.9	909,900	8.9

McKay & Company does not collect information on aftertreatment systems (e.g., diesel oxidation catalysts, SCR systems, or three-way catalysts), so neither EPA’s 2013 report nor CARB’s more recent report for their HD Omnibus rulemaking include aftertreatment system age information.<sup>434</sup> We consider the mileage at rebuild or replacement of an engine to represent the operational life of that engine, including any aftertreatment components that were part of its original

certified configuration. We have no data to indicate aftertreatment systems lose functionality before engines are rebuilt or replaced, and our technology demonstrations in Section III show aftertreatment catalysts are able to maintain performance when bench-aged to beyond the equivalent of current useful life mileages.<sup>435</sup>

We averaged the mileages for these vehicle classes according to EPA’s primary intended service classes for heavy-duty CI engines as defined in 40

CFR 1036.140. Specifically, we averaged Classes 3, 4, and 5 to represent Light HDE, Classes 6 and 7 to represent Medium HDE, and Class 8 to represent Heavy HDE. These values are shown in Table IV-2 with the current useful life mileages that apply to each intended service class. As seen in the tables, the study reported typical engine rebuild mileages that are more than double the current useful life mileages for those classes.

TABLE IV-2—AVERAGE MILEAGE AT FIRST REBUILD FOR HEAVY-DUTY CI ENGINES BASED ON EPA INTENDED SERVICE CLASSES

Primary intended service class	Mileage at first in-frame rebuild	Mileage at first out-of-frame rebuild	Current useful life mileage
Light HDE (Vehicle Classes 3–5) .....	250,667	315,500	<sup>a</sup> 110,000
Medium HDE (Vehicle Classes 6–7) .....	379,850	458,400	185,000
Heavy HDE (Vehicle Class 8) .....	680,200	909,900	435,000

<sup>a</sup> The useful life mileage that applies for Light HDE for GHG emission standards is 150,000 miles. See 40 CFR 1036.108(d).

We note that Light HDE intended for smaller vehicle classes are not designed with cylinder liners to facilitate rebuilding, suggesting they are more likely to be scrapped at the end of their operational life. The rebuilding report notes that seven percent of the diesel-fueled engines in the 2012 Class 3 vehicle population were removed from the vehicle to be rebuilt, but does not include data on the corresponding number of engines or vehicles scrapped in that year. We assume the mileage at which an engine has deteriorated enough to consider rebuilding would be similar to the mileage of an engine

eligible for scrappage and both similarly represent the operational life of an engine for the purpose of this analysis.

ii. Spark-Ignition Engine Service Life Data

The useful life mileage that applies for GHG emission standards for Spark-ignition HDE is 150,000 miles, which is longer than the current useful life of 110,000 miles for criteria pollutant emission standards for those same engines.<sup>436</sup> For our proposed Option 1 updates to the useful life for Spark-ignition HDE criteria pollutant emission standards, we considered available data to represent the operational life of

recent heavy-duty SI engines. A review of market literature for heavy-duty gasoline engines showed that at least one line of engine-certified products is advertised with a service life of 200,000 miles.<sup>437</sup> Compliance data for MY 2019 indicate that the advertised engine model represents 20 percent of the Spark-ignition HDE certified for MY 2019. Additionally, CARB’s HD Omnibus rulemaking cited heavy-duty Otto-cycle engines (i.e., Spark-ignition HDE) for vehicles above 14,000 lb GVWR that were replaced during calendar years 2012 through 2018 as reaching more than 217,000 miles on

<sup>434</sup> See Section IV.A.2.iii for a summary of the CARB report that reflects engine rebuilds and replacements occurring between calendar years 2012 and 2018.

<sup>435</sup> See Section IV.F for a summary of catalyst bench-aging procedures we are considering in this proposal.

<sup>436</sup> See 40 CFR 1036.108(d) for the GHG useful life, and the definition of “useful life” in 40 CFR 86.004-2 for the criteria pollutant useful life.

<sup>437</sup> See, e.g., Isuzu Truck web page. “Isuzu Commercial Vehicles: N-Series Gas Trucks.” Available online: [www.isuzucv.com/en/nseries/nseries\\_gas](http://www.isuzucv.com/en/nseries/nseries_gas). Accessed February 28, 2020.

average.<sup>438</sup> The mileages in these two examples are almost double the current useful life for Spark-ignition HDE, indicating many miles of operation beyond the current useful life.

iii. CARB HD Omnibus Useful Life Values

The CARB HD Omnibus rulemaking, finalized in August 2020, lengthens useful life for heavy-duty CI and SI engines in two steps.<sup>439</sup> As part of their rule, CARB analyzed recent MacKay & Company survey data from calendar

years 2012 through 2018 and reported rebuild mileages for CI engine categories that were similar to those described in the Section IV.A.2.i. CARB also included average replacement mileage information for heavy-duty Otto-cycle (HD SI) engines.<sup>440</sup> The CARB/MacKay & Company data is summarized in Table IV-3.

TABLE IV-3—SUMMARY OF CARB/MACKAY & COMPANY ENGINE REBUILD AND REPLACEMENT MILEAGES FOR THE HD OMNIBUS REGULATION<sup>a</sup>

Engine class	Average mileage at rebuild or replacement
HD Otto (Spark-ignition HDE) (All Vehicle Classes above 14,000 lb GVWR) .....	217,283
LHDD (Light HDE) (Vehicle Classes 4-5) .....	326,444
MHDD (Medium HDE) (Vehicle Classes 6-7) .....	432,652
HHDD (Heavy HDE) (Vehicle Class 8) .....	854,616

<sup>a</sup> CARB's naming conventions for HD engines differ from the those in this proposal; corresponding EPA names are noted in parentheses

Although the CARB HD Omnibus program begins in MY 2024, the program maintains the current useful life values through MY 2026. Table IV-

4 summarizes the useful life values finalized in the HD Omnibus rule for heavy-duty Otto-cycle engines (HDO), and light heavy-duty diesel (LHDD),

medium heavy-duty diesel (MHDD), and heavy heavy-duty diesel (HHDD) engines.

TABLE IV-4—CARB USEFUL LIFE MILEAGES FOR HEAVY-DUTY ENGINES IN THE HD OMNIBUS RULEMAKING<sup>a</sup>

Model year	HDO (spark-ignition HDE)	LHDD (light HDE)	MHDD (medium HDE)	HHDD (heavy HDE) <sup>b</sup>
2024-2026 .....	110,000 miles ..... 10 years .....	110,000 miles ..... 10 years .....	185,000 miles ..... 10 years .....	435,000 miles. 10 years. 22,000 hours.
2027-2030 .....	155,000 miles ..... 12 years .....	190,000 miles ..... 12 years .....	270,000 miles ..... 11 years .....	600,000 miles. 11 years. 30,000 hours.
2031 and later .....	200,000 miles ..... 15 years .....	270,000 miles ..... 15 years .....	350,000 miles ..... 12 years .....	800,000 miles. 12 years. 40,000 hours.

<sup>a</sup> CARB's naming conventions for HD engines differ from the those in this proposal; corresponding EPA names are noted in parentheses.

<sup>b</sup> CARB adopted an intermediate useful life mileage of 435,000 miles for MY 2027 and later HHDD engines. See Section III.B for a discussion of the standards at the intermediate and full useful life mileages.

As seen in the table, CARB's Omnibus increases useful life first in MY 2027 with a second step in MY 2031. The final useful life mileages in the CARB regulation are the result of stakeholder engagement throughout the development of CARB's HD Omnibus rulemaking. In two 2019 public workshops, CARB staff presented useful life mileage values under consideration that were longer than these final mileages and, in their September 2019 presentation, very close to the engine rebuild mileages.<sup>441</sup> In response to

feedback from stakeholders indicating concerns with availability of data for engines and emission controls at those mileages, CARB shortened their final useful life mileages for MY 2031 and later engines from the values presented in 2019, and the MY 2027 values were chosen to be approximately the mid-point between the current and final useful life mileages.<sup>442</sup> Additionally, CARB finalized an intermediate useful life mileage for MY 2027 and later HHDD engines that correspond to the current useful life of 435,000 miles. See

Section III.B for a discussion of the standards at the intermediate and full useful life mileages. Consistent with current useful life periods, CARB finalized hours values for the HHDD engine class based on the useful life mileage and an average vehicle speed of 20 miles per hour.

Similar to the useful life mileage values, CARB's useful life values in years were also adjusted from the values presented in their public workshops based on stakeholder feedback. In particular, emission controls

<sup>438</sup> California Air Resources Board/MacKay & Company, "CARB Summary Report on the Analysis of the MacKay & Company Data on Heavy-Duty Engine Rebuilds and Replacements", March 2019.

<sup>439</sup> California Air Resources Board, Heavy-Duty Omnibus Regulation. Available online: <https://ww2.arb.ca.gov/rulemaking/2020/hdomnibuslownox>.

<sup>440</sup> California Air Resources Board/MacKay & Company, "CARB Summary Report on the Analysis of the MacKay & Company Data on Heavy-Duty Engine Rebuilds and Replacements", March 2019.

<sup>441</sup> Brakora, Jessica. Memorandum to Docket: EPA-HQ-OAR-2019-0055. CARB 2019 Public Workshop Presentations Related to Regulatory

Useful Life and Emissions Warranty. March 19, 2021.

<sup>442</sup> California Air Resources Board. Staff Report: Initial Statement of Reasons—Public Hearing to Consider the Proposed Heavy-Duty Engine and Vehicle Omnibus Regulation and Associated Amendments. June 23, 2020. Page III-57.

manufacturers recommended CARB consider replacing the 18-year useful life presented in their September 2019 workshop with a useful life of 12 years for heavy-duty engines.<sup>443</sup> CARB agreed that 12 years was reasonable for MHDD and HHDD, but adopted a 15 year useful life for HDO and LHDD based on the useful life in years that applies to chassis-certified engines.

3. Proposed Regulatory Useful Life Periods

In this section, we introduce our proposed regulatory useful life periods for heavy-duty highway engines as specified in the new 40 CFR 1036.104(e). Our CI and SI engine technology demonstrations in Section III support our conclusion that it is feasible for manufacturers to meet our proposed standards for the proposed useful life periods of Options 1 and 2. We note that our technology demonstrations rely on an accelerated aging process for the catalyst-based aftertreatment systems and we are proposing to update our durability demonstration provisions to allow manufacturers to similarly

accelerate the aging of their catalysts for certification. See Section IV.F for a description of our durability demonstration proposal.

We are proposing useful life mileage and years values for all primary intended service classes that are based on our current estimate of the operational lives of the engines in those classes. The useful life values described in this section apply for exhaust emission standards for criteria pollutants, as well as evaporative and refueling emission standards, OBD, and requirements related to crankcase emissions. Proposed Option 1 includes an hours specification for the Heavy HDE class, which has the longest useful life mileages, to address vehicles that frequently operate at idle or lower speeds. The proposed Option 1 useful life periods generally align with those in the CARB HD Omnibus regulation. We request comment on our proposal, including whether it is appropriate to fully harmonize the federal and CARB regulatory useful life periods in light of the authority and requirements of

section 202, and any concerns if EPA were to finalize values that are or are not aligned with CARB for a given engine class or range of model years.

i. Proposed Useful Life by Primary Intended Service Class

Data indicate heavy-duty highway engines remain on the road well beyond the current regulatory useful life periods and compliance with emission standards is uncertain for a large portion of engine operational lives today. We are proposing to lengthen the useful life periods to cover a larger fraction of the operational life of these engines. Our proposed useful life periods for Spark-ignition HDE, Light HDE, Medium HDE, and Heavy HDE classes are presented in Table IV–5 and specified in a proposed new 40 CFR 1036.104(e).<sup>444</sup> In Section III, we discuss the feasibility of meeting the emission standards at the useful life values of proposed Options 1 and 2. In Section IV.A.4, we introduce an alternative set of useful life periods we considered in addition to our proposed values as part of our feasibility analysis.

TABLE IV–5—PROPOSED OPTIONS 1 AND 2 USEFUL LIFE PERIODS BY PRIMARY INTENDED SERVICE CLASSES

Primary intended service class	Current		Proposed Option 1				Proposed Option 2	
	Miles	Years	MY 2027–2030		MY 2031+		Miles	Years
			Miles	Years	Miles	Years		
Spark-ignition HDE <sup>a</sup> .....	110,000	10	155,000	12	200,000	15	150,000	10
Light HDE <sup>a</sup> .....	110,000	10	190,000	12	270,000	15	250,000	10
Medium HDE .....	185,000	10	270,000	11	350,000	12	325,000	10
Heavy HDE <sup>b</sup> .....	435,000	10	600,000	11	<sup>c</sup> 800,000	12	650,000	10

<sup>a</sup> Current useful life period for Spark-ignition HDE and Light HDE for GHG emission standards is 15 years or 150,000 miles. See 40 CFR 1036.108(d).  
<sup>b</sup> Proposed Option 1 includes an hours-based useful life for Heavy HDE of 32,000 operating hours for model year 2027 through 2030, and 40,000 operating hours for model year 2031 and later.  
<sup>c</sup> For MY 2031 and later Heavy HDE under proposed Option 1, we are proposing intermediate useful life periods of 435,000 miles, 10 years, or 22,000 hours, whichever comes first. See Section III for a discussion of the Option 1 standards we propose to apply for the intermediate and full useful life periods.

We consider a comprehensive out-of-frame rebuild to represent the end of a heavy-duty CI engine’s “first life” of operation. The proposed Option 1 useful life periods for all engine classes align with the final values adopted by CARB in their HD Omnibus regulation and cover a larger fraction of the expected operational lives of these engines. Consistent with previous rulemakings, we believe we could justify proposing useful life requirements equivalent to the operational life data presented in Section IV.A.2, but are proposing somewhat shorter (less stringent) values in proposed Option 1 considering the

effect of useful life on the feasibility of meeting the proposed Option 1 standards.<sup>445</sup> The useful life mileages of proposed Option 2 generally correspond to the average mileages at which CI engines undergo the first in-frame rebuild as described in Section IV.A.2.i. At these mileages, CI engine owners could be expected to replace some critical components, but would be able to accrue many additional miles before a comprehensive rebuild. The out-of-frame rebuild data indicates that these engines can last well beyond the in-frame rebuild mileages, and we are unlikely to finalize a single step

program with useful life mileages that are lower than proposed Option 2.<sup>446</sup>

For SI engines that are less commonly rebuilt, engine replacement more appropriately marks the end of its operational life. The estimated operational life data presented in Section IV.A.2 indicate that heavy-duty highway engines can operate for nearly double their current regulatory useful lives. As described in Section III, our SI engine demonstration program evaluated emission performance at an equivalent 250,000 miles (beyond the SI HDE service life and replacement mileage information presented in Section IV.A.2). Emission results from

<sup>443</sup> Manufacturers of Emission Controls Association. “Preliminary Suggestions for Future Warranty and FUL Requirements.” Presentation to CARB, September 5, 2019.

<sup>444</sup> We are proposing to migrate the current alternate standards for engines used in certain

specialty vehicles from 40 CFR 86.007–11 and 86.008–10 into 40 CFR 1036.605 without modification. See Section XII.B of this preamble for a discussion of these standards and options for which we are requesting comment.

<sup>445</sup> 61 FR 33446 (June 27, 1996).

<sup>446</sup> If our CI demonstration program is unable to achieve the proposed standards beyond 600,000 miles, we expect to adjust the numeric value of the standards to address feasibility concerns before lowering useful life below in-frame rebuild mileages.

our demonstration program were lower than the proposed Option 1 MY 2031 standards for all pollutants on the FTP duty cycle, and for all but CO on the SET duty cycle. We project the proposed Option 1 MY 2031 CO standard would be met by optimizing emission control calibrations. For Option 1, we are proposing a MY 2031 useful life of 200,000 miles (50,000 miles shorter than the equivalent mileage of the engine in our demonstration program), which we believe would ensure the proposed Option 1 MY 2031 standards are feasible for Spark-ignition HDE. For Option 1, we are proposing shorter useful life mileages along with the less stringent proposed Option 1 standards for MY 2027 to allow manufacturers appropriate time to prepare their engines to meet standards on the proposed new SET cycle, adopt our proposed idle controls, and address other proposed compliance requirements. For SI engines, the useful life mileage in proposed Option 2 aligns with the current useful life mileage that applies for these engines for GHG standards and represents the lowest useful life mileage we are currently considering for Spark-ignition HDE. Commenters supporting the SI engine useful life mileages for proposed Option 2 are encouraged to provide data, since proposed Option 2 useful life mileages currently apply for GHG standards and our SI engine test program has demonstrated most of the proposed standards are achievable well beyond the proposed Option 2 mileage.

Our CI engine demonstration evaluated emissions at mileages that correspond to the Light HDE and Medium HDE operational life mileages presented, and we continue to evaluate higher mileages that would cover a greater portion of the operational life of Heavy HDE. The uncertainty of emission performance at mileages close to Heavy HDE rebuild mileages, coupled with the lack of aftertreatment performance information in the rebuild data, has led us to propose Option 1 MY 2031 useful life mileages that cover a majority of the estimated operational life mileages, but less than the full rebuild mileages presented in Section IV.A.2. Since the EPA rebuild mileages are similar to the rebuild mileages in CARB's recent rebuild analysis, we are proposing CI HDE useful life mileages that align with CARB.

We request comment on the proposed approach to base these mileages on the data presented. We request additional data to inform our consideration of appropriate useful life mileages, including rebuilding, replacement, and

scrapage data, or other data that may represent the operational life of a heavy-duty highway engine. We also request comment on what portion of an engine's operational life should be covered by the regulatory useful life and whether it should depend on specific characteristics of the engine (e.g., primary intended service class).

As seen in Table IV–5, our proposed Option 1 would increase the years-based useful life values intended to address engines that accumulate fewer miles annually. Our proposed increased useful life in years for Option 1 would also occur in two steps that align with the values finalized in CARB's HD Omnibus regulation.<sup>447</sup> Proposed Option 1 would increase Heavy HDE and Medium HDE useful life years to 11 years in MY 2027 and 12 years in MY 2031. The 12-year useful life value is consistent with the recommendation by MECA.<sup>448</sup> Proposed Option 1 would also increase Spark-ignition and Light HDE useful life years to 12 years in MY 2027 and 15 years in MY 2031. A 15-year useful life value would be consistent with the existing useful life in years for these engines for GHG emission standards. We propose to maintain the existing years-based useful life of 10 years for all primary intended service classes under proposed Option 2.

Proposed Option 1 also includes updates to the hours-based useful life criteria for the Heavy HDE class to align with the proposed mileage steps.<sup>449</sup> Historically, EPA included a unique hours specification for the Heavy HDE class to account for engines that operated frequently, but accumulated relatively few miles due to lower vehicle speeds.<sup>450</sup> The 22,000-hour useful life value that currently applies for Heavy HDE corresponds to an average vehicle speed of 20 miles per hour.

Consistent with our original approach to defining an hour-based useful life value, we are proposing to update the useful life hours of operation value for the Heavy HDE primary intended service class based on a 20 mile per hour speed threshold and the proposed

useful life mileages.<sup>451</sup> For model year 2027 through 2030 Heavy HDE in Option 1, we propose a useful life period of 11 years, 600,000 miles, or 32,000 hours, whichever comes first. Similarly, for model year 2031 and later Heavy HDE in Option 1, we propose 12 years, 800,000 miles, or 40,000 miles, whichever comes first.

We request comment on the need for a useful life hours criterion for Heavy HDE and whether we should include one for other primary intended service classes. If we were to include a useful life hours criterion for other or all heavy-duty highway engines, we request comment whether to use a speed other than 20 miles per hour for engines intended for lower GVWR class vehicles.

We are proposing not to migrate paragraph (4)(iv) from the existing definition of “useful life” in 40 CFR 86.004–2 to proposed 40 CFR 1036.104. It is our understanding that all modern ECMs contain time counters, so it is reasonable to assume that manufacturers can reliably access that information to document an engine's hours of operation and the requirement for an “accurate hours meter” is unnecessary. We request comment on the need to include an accurate hours meter requirement as part of a useful life hours criterion in part 1036.

As introduced in Section III.A.1, we are proposing to clarify how hybrid engines and powertrains can certify they meet criteria pollutant regulations, which includes demonstrating that they meet emission standards throughout the regulatory useful life.<sup>452</sup> We propose that manufacturers certifying hybrid engines and powertrains declare the primary intended service class of their engine family using 40 CFR 1036.140, which is partially based on the GVWR of the vehicle in which the engine configuration is intended to be used. Once a primary intended service class is declared the engine configuration would be subject to the corresponding emission standards and useful life values from 40 CFR 1036.104(e). Our proposed approach to clarify that hybrid components could be part of an engine configuration provides truck owners and operators with consistent assurance

<sup>447</sup> See Section IV.A.2.iii.

<sup>448</sup> Manufacturers of Emission Controls Association. “Preliminary Suggestions for Future Warranty and FUL Requirements”. September 5, 2019.

<sup>449</sup> Table 4 of proposed 40 CFR 1036.104(e) includes a statement migrated from the current definition of “useful life” in 40 CFR 86.004–2 that the useful life for an individual engine is no shorter than 10 years or 100,000 miles, whichever occurs first, regardless of operating hours, as required by CAA section 202(d).

<sup>450</sup> See background in Section IV.A.1.

<sup>451</sup> This approach for the hours criterion is consistent with the approach adopted in our 1997 rulemaking where we last increased HHD engine useful life. See Section IV.A.1.

<sup>452</sup> As outlined in Section III.A, we are proposing to clarify in 40 CFR 1036.101(b) that regulatory references to engines in part 1036 generally apply to hybrid powertrains. We also propose to update the definition of “engine configuration” in 40 CFR 1036.801 to clarify that an engine configuration would include hybrid components if it is certified as a hybrid engine or hybrid powertrain.



of durability based on the intended vehicle application. Our proposed approach is similar to the CARB Omnibus rule requirements for hybrid powertrains to meet useful life based on primary intended service class, though we are proposing flexibility for manufacturers to identify the appropriate service class for their engine configurations.<sup>453</sup>

Our proposal does not mean that a specific component of the certified configuration, such as a hybrid battery, is required to last the full useful life indicated by its primary intended service class. Manufacturers continue to have options to address the repair or replacement of components within the useful life, both in the durability demonstration for certification and in-use, as specified in the maintenance provisions of 40 CFR 1036.125. See Section IV.B.5 for a discussion of our proposals related to maintenance. We request comment on our proposed approach for manufacturers certifying hybrid engines and powertrains to declare a primary intended service class and meet the corresponding emission standards and useful life periods.

#### ii. Proposed Useful Life for Heavy-Duty Electric Vehicles

As discussed in Section III.A, we are proposing clarifications and updates to our regulations for heavy-duty electric vehicles, including battery electric vehicles (BEVs) and fuel cell electric vehicles (FCEVs). Our proposal clarifies how the proposed useful life provisions for criteria pollutant emission standards would apply to each of these types of electric vehicles. Immediately below, we discuss the specifics and rationale of our proposed approach to useful life periods for BEVs and FCEVs. Additional information on our proposal and requests for comment are included in the following subsections: IV.B.1.iv.b (BEV and FCEV warranty requirements), IV.B.3.iii (request for comment on maintenance and operational information to improve electric vehicle serviceability), and IV.I (compliance options for generating NO<sub>x</sub> emission credits from electric vehicles).

As noted in Section III.A and discussed in Section IV.I, we are proposing a change from our current approach under 40 CFR 86.016–1(d)(4) that would allow manufacturers to generate NO<sub>x</sub> emission credits from

BEVs and FCEVs starting in MY 2024, as specified in the proposed 40 CFR 1037.616, if they conduct testing and meet durability requirements in the proposed 40 CFR 1037.102(b).<sup>454</sup> We propose that manufacturers who choose to generate NO<sub>x</sub> emission credits from BEVs or FCEVs would certify to the emission standards and useful life values of an engine-based primary intended service class, as specified in proposed 40 CFR 1037.102(b). Proposed 40 CFR 1037.102(b) specifies that for MYs 2024 through 2026, manufacturers choosing to generate NO<sub>x</sub> emission credits from BEVs or FCEVs would apply the useful life periods in current 40 CFR 86.001–2; starting in MY 2027 manufacturers would apply the useful life periods in proposed 40 CFR 1036.104. We also propose that starting in MY 2027, manufacturers who choose not to generate NO<sub>x</sub> emission credits from BEVs or FCEVs could alternatively choose to certify to a shorter useful life period that is the same as those for GHG emissions standards for the appropriate service class in the current 40 CFR 1037.105(e).<sup>455</sup>

Manufacturers who choose not to generate NO<sub>x</sub> emission credits from BEVs or FCEVs may choose to attest that their vehicle complies with the standards in proposed 40 CFR 1037.102 instead of submitting test data for MY 2027 and later, as specified in the proposed 40 CFR 1037.205(q)(1).<sup>456</sup> Manufacturers who choose to generate NO<sub>x</sub> emission credits from BEVs or FCEVs as early as MY 2024 may also attest that their BEV or FCEV meets the durability requirements described in proposed 40 CFR 1037.102(b)(3) based on an engineering analysis of measured values and other information, consistent with good engineering judgment, instead of testing at the end of the useful life; however they would also be required to submit additional information as specified in the proposed

<sup>454</sup> See Section III.A.1 for discussion on the current approach under 40 CFR part 86 for BEV and FCEV certification requirements. Briefly, no testing is required and neither BEVs nor FCEVs may generate NO<sub>x</sub> or PM emission credits.

<sup>455</sup> We are not proposing any changes to the current useful life periods for GHG emissions. As specified in the current 40 CFR 1037.150(f), all BEV and FCEV manufacturers would continue to use good engineering judgment to apply useful life requirements for GHG standards.

<sup>456</sup> Prior to MY 2027, manufacturers who chose not to generate NO<sub>x</sub> emission credits would apply the useful life periods specified in the current 40 CFR 86.001–2; however, EPA would continue the current approach of deeming these vehicles to have zero emissions and allow manufacturers to apply good engineering judgment to comply with requirements of the current 40 CFR 86 subpart A.

40 CFR 1037.205(q)(2) and discussed in Section IV.I.

The purpose of requiring BEV and FCEV manufacturers who choose to generate NO<sub>x</sub> emission credits to meet durability requirements is to ensure that manufacturers design the BEV and FCEV products to be at least as durable as the engine products that would rely on the NO<sub>x</sub> emission credits to comply with applicable NO<sub>x</sub> standards. Since manufacturers would be able to use NO<sub>x</sub> emissions credits from BEVs or FCEVs to produce other engines with NO<sub>x</sub> emissions above the proposed standards for MYs 2027 and later, we believe it is imperative that these technologies provide zero-tailpipe emission performance throughout the useful life period to which they certify and for which they generate NO<sub>x</sub> emission credits.<sup>457</sup> This approach would help to ensure that these zero-tailpipe emission technologies can operate for the same periods as the engine products that rely on the NO<sub>x</sub> emission credits. We also note that data from transit buses show BEVs are capable of operating more than 10 million miles and over 30 years of normal service in a typical transit bus duty-cycle.<sup>458 459 460</sup> Similarly, the DOE has set heavy-duty FCEV durability target at 1 million miles by 2030.<sup>461</sup> Both the transit bus data and DOE target support BEV and FCEVs technologies being capable of meeting the useful life requirements of proposed Options 1 and 2 for CI engines in the 2027 and beyond timeframe. Nevertheless, we recognize that BEV and FCEV technologies, and the batteries and fuel cells that power them, are still developing; thus, we propose to allow BEV and FCEV manufacturers not participating in the

<sup>457</sup> See Section IV.G for discussion on proposed restrictions that would limit emissions above the proposed standards when using NO<sub>x</sub> emission credits.

<sup>458</sup> (BYD, 2019) “BYD Receives Largest Battery-Electric Bus Order in U.S. History,” BYD Motors, November 13, 2019, accessed February 10, 2022. [https://en.byd.com/news/byd-receives-largest-battery-electric-bus-order-in-u-s-history/#:~:text=BYD%20\(Build%20Your%20Dreams\)%20announced,date%20in%20the%20United%20States](https://en.byd.com/news/byd-receives-largest-battery-electric-bus-order-in-u-s-history/#:~:text=BYD%20(Build%20Your%20Dreams)%20announced,date%20in%20the%20United%20States).

<sup>459</sup> (Mass Transit, 2015) “BYD Announces 12 year Battery Warranty,” Mass Transit Magazine, March 26, 2015, accessed August 3, 2021. <https://www.masstransitmag.com/home/press-release/12058920/byd-motors-l1byd-announces-12-year-battery-warranty>.

<sup>460</sup> (Metro, 2019) “Idaho’s YRT to add Proterra battery-electric buses, charging infrastructure,” Metro Magazine, October 25, 2019, accessed August 3, 2021. <https://www.metro-magazine.com/zero-emissions/news/736104/idaho-s-yrt-toproterra-battery-electric-buses-charging-infrastructure>.

<sup>461</sup> DOE, 2020. FC135: FC–PAD: Fuel Cell Performance and Durability Consortium; [https://www.hydrogen.energy.gov/pdfs/review20/fc135\\_borup\\_weber\\_2020\\_o.pdf](https://www.hydrogen.energy.gov/pdfs/review20/fc135_borup_weber_2020_o.pdf).

<sup>453</sup> California Air Resources Board. Staff Report: Initial Statement of Reasons—Public Hearing to Consider the Proposed Heavy-Duty Engine and Vehicle Omnibus Regulation and Associated Amendments. June 23, 2020. Page III–60. Available at: <https://ww2.arb.ca.gov/sites/default/files/barcu/regact/2020/hdomnibuslownox/isor.pdf>.

NO<sub>x</sub> engine ABT program to certify to criteria pollutant useful life requirements that are equivalent to the current requirements for certifying to the GHG emission standards.<sup>462</sup>

We request comment on our proposal to align BEV and FCEV useful life periods with those for an engine-based service class for manufacturers who choose to generate NO<sub>x</sub> emission credits. We further request comment on allowing manufacturers who choose not to generate NO<sub>x</sub> emission credits from BEVs or FCEVs to certify to criteria pollutant useful life periods that are equivalent to the current useful life periods for the GHG emission standards. We are also interested in other approaches identified or recommended by commenters. Commenters are encouraged to provide data on current BEV and FCEV durability, as well as any additional information EPA should consider when setting useful life periods and related requirements for BEVs and FCEVs in the final rulemaking.

iii. Proposed Useful Life for Incomplete Vehicle Refueling Emission Standards

As described in Section III.E., proposed Options 1 and 2 include refueling standards for incomplete vehicles above 14,000 lb GVWR. Manufacturers would meet the proposed refueling emission standards by installing onboard refueling vapor recovery (ORVR) systems. ORVR

systems are based on the same carbon canister technology that manufacturers currently use to control evaporative emissions on these incomplete vehicles. Since both the evaporative and refueling emission control systems are part of the same fuel system, and due to the similarity of many of the components, we propose to align the useful life periods for the two systems (see our proposed updates to 40 CFR 1037.103(f)). Specifically, proposed Options 1 and 2 include a useful life of 15 years or 150,000 miles, whichever comes first, for refueling standards for incomplete vehicles above 14,000 lb GVWR.

Evaporative emission control systems are currently part of the fuel system of incomplete vehicles, and manufacturers are meeting applicable standards and useful life requirements for these systems today. ORVR is a mature technology that has been installed on complete vehicles for many years, and incomplete vehicle manufacturers have experience with ORVR systems through their complete vehicle applications. Considering the manufacturers' experience with evaporative emission standards for incomplete vehicles, and their familiarity with ORVR systems, we believe it would be feasible for manufacturers to apply the same evaporative emission standard useful life periods to our proposed refueling standards.

We request comment on our proposal to align the useful life for refueling standards with the existing useful life periods for evaporative emission standards and whether we should instead consider aligning with the broader useful life periods proposed for Spark-ignition HDE (e.g., the proposed Option 1 useful life periods of 12 years/155,000 miles for MY 2027 through 2030 and 15 years/200,000 miles for MY 2031 and later), or whether we should take another approach. We also request comment on the need for a transitional useful life step for refueling standards for MY 2027 through 2030, including concerns with component durability or testing that would require additional lead time to address. Commenters are encouraged to include ORVR system data at their recommended useful life values. Finally, we request comment on any concerns about having different useful life values for refueling standards compared to the useful life values for either evaporative emission standards or Spark-ignition HDE standards.

4. Potential Alternative Useful Life Mileages

We considered an alternative set of useful life mileages (Alternative), which would each apply in a single step beginning in MY 2027. Table IV-6 presents a comparison of the current useful life mileages and the useful life mileages of the proposed Options and Alternative.

TABLE IV-6—COMPARISON OF USEFUL LIFE MILEAGES CONSIDERED

Primary intended service class	Current	Proposed Option 1		Proposed Option 2	Alternative
		MY 2027–2030	MY 2031+		
Spark-ignition HDE .....	110,000	155,000	200,000	150,000	250,000
Light HDE .....	110,000	190,000	270,000	250,000	350,000
Medium HDE .....	185,000	270,000	350,000	325,000	450,000
Heavy HDE .....	435,000	600,000	800,000	650,000	850,000

The useful life mileages that we considered in the Alternative are longer than the proposed Option 1 MY 2031 useful life mileages. The useful life mileages of this alternative match those presented in CARB's September 2019 Public Workshop for their Heavy-Duty Low NO<sub>x</sub> program as early CARB staff-level thinking; these draft mileages were then lowered in the 2020 Omnibus program approved by CARB governing board.<sup>463</sup> While the CI engine mileages for the Alternative are closer to the average mileage at which most CI

engines undergo an out-of-frame rebuild, currently available data indicate that the Alternative standards presented in Section III would be very challenging to meet at those useful life mileages for Light HDEs and Medium HDEs, and thus data suggest that it may be appropriate for EPA to consider providing manufacturers with additional lead time, beyond the MY 2027 implementation date of the Alternative. For Heavy HDEs, our extrapolation of the data from 435,000 miles through the 850,000 mile useful

life of the Alternative suggests that the numeric level of the NO<sub>x</sub> emission control in the Alternative could not be maintained through the Alternative useful life period (see Section III for details).

The SI mileage for the Alternative represents the equivalent mileage of the bench-aged three-way catalyst used in the SI technology demonstration for this rulemaking, but currently available data suggest it would be very challenging to achieve the standards of this alternative for all pollutants in the MY 2027

<sup>462</sup> 40 CFR 1037, subpart B.

<sup>463</sup> Brakora, Jessica. Memorandum to Docket: EPA-HQ-OAR-2019-0055. CARB 2019 Public Workshop Presentations Related to Regulatory

Useful Life and Emissions Warranty. March 19, 2021.

timeframe. For both CI and SI engines, we would need additional data to be able to conclude that the standards combined with the useful mileages included in the Alternative are feasible in the MY 2027 timeframe, and thereby consider finalizing these useful life mileages in this rule. We did not evaluate alternative useful life mileages for HD SI refueling standards. As noted in Section IV.A.3.iii, we would consider transitional useful life mileages for our refueling standards in the early years of the program or longer useful life mileages that align with those for the final Spark-ignition HDE class if we receive comment and data supporting alignment.

Our analyses of the emission impacts of the Alternative standards and Alternative useful life mileage values are presented in Section VI. We do not present an analysis of the costs of the Alternative since we currently do not have information to conclude that the Alternative standards are feasible in the MY 2027 timeframe with the emission control technologies we have evaluated to date. We are also considering other approaches that build on the relationship between useful life and emissions warranty periods as described in Section IV.B.1.

#### 5. Summary of the Requests for Comment on the Useful Life Proposal

We request comment on our proposed useful life values, including the appropriateness of the data on which we base our proposals, or other bases identified in this section or by the commenters. Specifically, we request comment on our approaches to base useful life mileages for CI engines on data on average mileage to first out-of-frame rebuild for proposed Option 1 and average mileage to first in-frame rebuild for proposed Option 2. We also request comment on whether to finalize a consistent fraction of the estimated rebuild mileage across the three CI service classes. For SI engines, we request comment on our proposed Option 1 approach to update the MY 2031 useful life mileage based on the advertised service life of a certified SI engine in the market today, which is consistent with SI engine mileage from recent CARB study, or the proposed Option 2 approach to update the criteria pollutant useful life to be closer to the useful life mileage that applies for GHG pollutants. As noted in this section and discussed in Section III, proposed Options 1 and 2 reflect the general ranges of mileages we are currently considering for each engine class, but we request comment on a different set of mileages within those ranges that

may be appropriate. Commenters, especially if suggesting different useful life mileages than EPA's proposed values, are encouraged to support their comments by addressing feasibility and cost for their recommended mileage values.

We request comment on our proposal to increase the useful life years and to update Heavy HDE useful life hours-based values proportional to the increased mileages for proposed Option 1. Commenters supporting useful life hours for Heavy HDE are encouraged to address whether EPA should apply a useful life hours criterion to other engine service classes and if a 20 mile per hour average speed is appropriate to represent "low speed" applications for each engine class. As noted in this section, proposed Option 1 is largely aligned with useful life periods adopted in the CARB HD Omnibus regulation. We request comment our proposal, including whether it is appropriate to fully harmonize the federal and CARB regulatory useful life periods in light of the authority and requirements of section 202, and any concerns if EPA were to finalize aspects of useful life that are or are not aligned with CARB for a given engine class or range of model years.

#### *B. Ensuring Long-Term In-Use Emissions Performance*

In the ANPR, we introduced several ideas for an enhanced, comprehensive strategy to ensure in-use emissions performance over more of an engine's operational life, based on five areas:

- Warranties that cover an appropriate fraction of engine operational life.
- Improved, more tamper-resistant electronic controls.
- Serviceability improvements for vehicles and engines.
- Education and potential incentives.
- Engine rebuilding practices that ensure emission controls are functional.
- This section discusses proposed provisions for emissions warranty, ECM security, and serviceability. Taken together, they are intended to increase the likelihood that engine emission controls will be maintained properly through more of the service life of heavy-duty engines and vehicles, including beyond useful life. Our proposal also expands on this suite of measures to include updated maintenance provisions, which are described in Section IV.B.5. We are not including specific proposals related to education and incentives, but request comment on options we could consider in the future. As noted in Section IV.B.4, we are also not proposing new

or modified rebuilding provisions in this rule. However, we intend to continue to monitor rebuilding practices and may update our rebuilding regulatory provisions in a future rulemaking.

#### 1. Emission-Related Warranty Periods

EPA is proposing to lengthen the regulatory emission-related warranty periods for all primary intended service classes to cover a larger portion of the operational lives of new heavy-duty engines. In this section we summarize the history of emissions warranty, introduce our principles for lengthening the warranty periods, and present our proposed values and alternatives considered.

##### i. EPA Regulatory Emission Warranty Background

The regulatory emission warranty period is the period over which CAA section 207 requires an engine manufacturer to warrant to a purchaser that the engine is designed, built, and equipped so as to conform with applicable regulations under CAA section 202 and is free from defects in materials or workmanship which would cause the engine not to conform with applicable regulations for the warranty period. If an emission-related component fails during the regulatory emission warranty period, the manufacturer is required to pay for the cost of repair or replacement. A manufacturer's general emissions warranty responsibilities are currently set out in 40 CFR 1068.115. Note that while an emission warranty provides protection to the owner against emission-related repair costs during the warranty period, the owner is responsible for properly maintaining the engine (40 CFR 1068.110(e)), and the manufacturer may deny warranty claims for failures that have been caused by the owner's or operator's improper maintenance or use (40 CFR 1068.115(a)).

Regulatory warranty provisions were first included in the 1970 amendments to the Clean Air Act, as a new section 207(a) ("the manufacturer of each new motor vehicle and new motor vehicle engine shall warrant to the ultimate purchaser and each subsequent purchaser that such vehicle or engine is (1) designed, built, and equipped so as to conform at the time of sale with applicable regulations under section 202, and (2) free from defects in materials and workmanship which cause such vehicle or engine to fail to conform with applicable regulations for

its useful life . . .”).<sup>464</sup> Those amendments also instructed the Administrator in section 202(b) to “prescribe regulations which shall require manufacturers to warrant *the emission control device or system* of each new motor vehicle or new motor vehicle engine to which a regulation under section 202 applies . . .” (emphasis added). The 1977 CAA amendments modified the section 207(b) requirements, specifying that “for the period after twenty-four months or twenty-four thousand miles (whichever first occurs) the term ‘emission control

device or system’ means a catalytic converter, thermal reactor, or other component installed on or in a vehicle for the sole or primary purpose of reducing vehicle emissions.”<sup>465</sup> EPA’s first heavy-duty truck regulations, promulgated in 1983, set a specific warranty period of 5 years or 50,000 miles, whichever occurred first, for light-duty trucks, gasoline heavy-duty engines, and light heavy-duty diesel engines, and 5 years or 100,000 miles, whichever occurred first, for all other heavy-duty diesel engines.<sup>466</sup> These emission warranty periods were carried

over in each subsequent revision of the emission control program (see 40 CFR 86.084–2, 86.085–2, 86.90–2, 86.94–2, 86.096–2, 86.004–2) and persist to this day, even as the engine useful life periods were increased.<sup>467</sup> Today, there is a considerable difference between useful life and emission warranty periods, as illustrated in Table IV–7. The proposed changes to the useful life periods described in Section IV.A would increase this difference in the absence of an accompanying change to emissions warranty periods.

TABLE IV–7—COMPARISON OF CURRENT EMISSIONS WARRANTY AND REGULATORY USEFUL LIFE PERIODS

Engine class	Emissions warranty		Useful life <sup>a</sup>	
	Miles	Years	Miles	Years
Spark-ignition HDE .....	50,000	5	110,000	10
Light HDE .....	50,000	5	110,000	10
Medium HDE .....	100,000	5	185,000	10
Heavy HDE .....	100,000	5	435,000	10

<sup>a</sup> The useful life periods that apply for Spark-ignition HDE and Light HDE for GHG emission standards are 150,000 miles and 15 years. See 40 CFR 1036.108(d).

Today, the warranty mileage for Spark-ignition HDE, Light HDE, and Medium HDE covers about half of the corresponding useful life for those engines; the warranty mileage for Heavy HDE covers about a quarter of useful life. The proposal to lengthen engine useful life means that the warranty period would cover a smaller portion of useful life unless the warranty period is also increased. In the following section, we describe ways in which emission warranty periods can impact long-term emission performance, which we believe justifies proposing emissions warranties that cover more of the operational life of the engine.

ii. Lengthening the Regulatory Emission Warranty Period To Improve Long-Term Emission Performance

As illustrated in Table IV–7, EPA’s current emissions-related warranty periods range from 22 percent to 54 percent of regulatory useful life; the warranty periods have not changed since 1983 even as the useful life periods were lengthened.<sup>468</sup> As EPA is proposing to lengthen the useful life periods in this rulemaking, we are also proposing to lengthen the emission warranty periods and increase the portion of useful life miles covered under warranty. These proposed revised

warranty periods are expected to result in better engine maintenance and less tampering, helping to maintain the benefits of the emission controls. In addition, longer regulatory warranty periods may lead engine manufacturers to simplify repair processes and make them more aware of system defects that need to be tracked and reported to EPA.

Longer regulatory warranty periods that are more consistent with EPA’s useful life periods are expected to lead owners to better maintain their engines and vehicles over a longer period of time so as to not void their emission warranty coverage. This is because existing warranty provisions specify that owners are responsible for properly maintaining their engines (40 CFR 1068.110(e)), and manufacturers may deny warranty claims for failures that have been caused by the owner’s or operator’s improper maintenance or use (40 CFR 1068.115(a)).<sup>469</sup> A longer warranty period is expected to lead to better engine emission performance overall due to less mal-maintenance (see Chapter 5 of the draft RIA for a discussion of mal-maintenance effects in our emission inventory estimates). Similarly, longer regulatory emission warranty periods are expected to reduce the likelihood of tampering, which would also result in better engine

emission performance (see Chapter 5 of the draft RIA for a discussion of tampering effects in our emission inventory estimates). Since emission-related repairs would be covered for a longer period of time, the owner will be more likely to have systems repaired and, consequently, may be less likely to tamper to avoid the cost of a repair that is no longer covered by a warranty. Owners may also be less likely to install defeat devices that are marketed to boost engine performance since installing such a device would void the engine warranty.

Emission-related repair processes may get more attention from manufacturers if they are responsible for repairs over a longer period of time. As manufacturers try to remain competitive, longer emission warranty periods may lead manufacturers to simplify repair processes and provide better training to technicians in an effort to reduce their warranty repair costs. Simplifying repair processes could include modifying emission control components in terms of how systems are serviced and how components are replaced. The current, relatively short warranty period provides little incentive for manufacturers to specify repairs be made at the lowest possible level of complexity, since the owner pays for the

<sup>464</sup> Public Law 91–604, December 31, 1970.

<sup>465</sup> Public Law 95–95, August 7, 1977.

<sup>466</sup> 48 FR 52170, November 16, 1983.

<sup>467</sup> These same warranty periods apply in our GHG emission reduction programs. 76 FR 57106,

September 15, 2011 and 81 FR 73672, October 25, 2016; see 40 CFR 1037.102(b).

<sup>468</sup> The useful life for heavy heavy-duty engines was increased from 290,000 miles to 435,000 miles

for 2004 and later model years (62 FR 54694, October 21, 1997).

<sup>469</sup> See our proposal in Section IV.B.5 to update our allowable maintenance provisions.

repairs after the warranty period ends. One way to reduce warranty repair costs may be to design modular sub-assemblies that could be replaced individually, resulting in a quicker, less expensive repair. For example, if a DEF level sensor fails, repair practices may call for the DEF sensor assembly to be replaced in its entirety (including level sensor, quality sensor, lines, and even heaters) instead of only the faulty part. Improved technician training may also reduce warranty repair costs by improving identification and diagnosing component failures more quickly and accurately, thus avoiding repeated failures or misdiagnoses of failures and higher costs from repeat repair events at service facilities. These improvements may also encourage owners to have repairs made because down time is reduced.

Finally, longer regulatory emission warranty periods would increase the period over which the engine manufacturer would be made aware of emission-related defects. Manufacturers are currently required to track and report defects to the Agency under the defect reporting provisions of 40 CFR part 1068. Under 40 CFR 1068.501(b), manufacturers investigate possible defects whenever a warranty claim is submitted for a component. Therefore, manufacturers can easily monitor defect information from dealers and repair shops who are performing those warranty repair services, but after the warranty period ends, the manufacturer would not necessarily know about these events, since repair facilities are less likely to be in contact with the manufacturers and they are less likely to use OEM parts. A longer warranty period would allow manufacturers to have access to better defect information over a period of time more consistent with engine useful life.

The impact of a longer emissions warranty period may be slightly

different for SI engines. Spark-ignition engine systems rely on mature technologies, including evaporative emission systems and three-way catalyst-based emission controls, that have been consistently reliable for light-duty and heavy-duty vehicle owners.<sup>470</sup> We expect lengthened emission warranty periods to help enhance long-term in-use emissions performance of SI engines over time by reducing mal-maintenance and tampering. Similar to CI engine owners, we believe a longer warranty period would encourage owners of vehicles powered by SI engines to follow manufacturer-prescribed maintenance procedures for a longer period of time, as failure to do so would void the warranty. From a tampering perspective, SI engine owners may not be motivated to tamper with their catalyst systems to avoid repairs, but they may be less inclined to purchase defeat devices intended to disable emission controls to boost the performance of SI engines since installing such a device would void the engine warranty.

EPA seeks comment on all aspects of our proposal to lengthen emissions warranty periods for all primary intended service classes. We encourage stakeholders to submit any available data on emission control system repairs during and after heavy-duty engine emission warranty periods, including frequency of incidents, costs of repairs, and associated downtime.

iii. CARB’s Recent Heavy-Duty Engine Emissions Warranty Updates

CARB recently finalized two regulatory programs to update emissions warranty periods for heavy-duty engines as summarized in this section. We considered the warranty updates adopted by CARB when developing the proposed warranty periods for this rulemaking.

CARB’s “Step 1” warranty program for heavy-duty engines sold in California was finalized in 2019 and applied to MY 2022 heavy-duty diesel engines.<sup>471</sup> CARB increased the warranty mileage values for heavy-duty diesel engines, but did not update the years-based warranty periods during the Step 1 update. The Step 1 program also formally linked warranty requirements to the HD OBD system by specifying that failures that cause the vehicle’s OBD MIL to illuminate are considered warrantable conditions. CARB justified this linkage as helping to ensure that repairs of malfunctioning emission-related parts would be performed in a timelier manner during the lengthened warranty periods.

CARB included a second step of warranty updates in their HD Omnibus rulemaking that was approved by the Board in 2020.<sup>472</sup> In the Omnibus regulation, CARB lengthened the warranty periods for MY 2027 through MY 2030 and further lengthened the warranty periods for MY 2031 and later heavy-duty diesel engines. The Omnibus regulation also lengthened warranty periods for heavy-duty Otto cycle engines, and similarly linked HD OBD MIL triggers to warrantable conditions, for the same model years. The Omnibus also requires hybrid configurations to meet the same warranty periods as the diesel or Otto cycle engine service class to which they are certified. In addition, the Omnibus included warranty periods for BEVs and FCEVs of 3 years or 50,000 miles. The warranty periods adopted in the Omnibus included updated years- and hours-based warranty periods. The hours-based values were generally based on a 20 miles per hour vehicle speed and the warranty mileage for each engine class. Table IV–8 summarizes the emissions warranty periods from CARB’s recent updates.

TABLE IV–8—SUMMARY OF CARB’S EMISSION-RELATED WARRANTY PERIODS

CARB engine class <sup>a</sup>	Pre-MY 2022	Step 1 (MY 2022–2026)	HD Omnibus (MY 2027–2030)	HD Omnibus (MY 2031+)
HD Otto (Spark-ignition HDE).	50,000 miles .....	50,000 miles .....	110,000 miles .....	160,000 miles.
	5 years .....	5 years .....	7 years .....	10 years.
LHDDE (Light HDE) .....	50,000 miles .....	110,000 miles .....	6,000 hours .....	8,000 hours.
	5 years .....	5 years .....	150,000 miles .....	210,000 miles.
			7 years .....	10 years.
			7,000 hours .....	10,000 hours.

<sup>470</sup> The last U.S. EPA enforcement action against a manufacturer for three-way catalysts was settled with DaimlerChrysler Corporation Settlement on December 21, 2005. Available online: <https://www.epa.gov/enforcement/daimlerchrysler-corporation-settlement>.

<sup>471</sup> California Air Resources Board, “HD Warranty 2018”. Effective date: October 1, 2019. Available online: <https://ww2.arb.ca.gov/rulemaking/2018/hd-warranty-2018>.

<sup>472</sup> California Air Resources Board, “Heavy-Duty Omnibus Regulation”. Available online: <https://ww2.arb.ca.gov/rulemaking/2020/hdomnibuslownox>.

TABLE IV-8—SUMMARY OF CARB'S EMISSION-RELATED WARRANTY PERIODS—Continued

CARB engine class <sup>a</sup>	Pre-MY 2022	Step 1 (MY 2022–2026)	HD Omnibus (MY 2027–2030)	HD Omnibus (MY 2031+)
MHDDE (Medium HDE) ....	100,000 miles ..... 5 years .....	150,000 miles ..... 5 years .....	220,000 miles ..... 7 years ..... 11,000 hours .....	280,000 miles. 10 years. 14,000 hours.
HHDE ..... (Heavy HDE) .....	100,000 miles ..... 5 years .....	350,000 miles ..... 5 years .....	450,000 miles ..... 7 years ..... 22,000 hours .....	600,000 miles. 10 years. 30,000 hours.

<sup>a</sup> CARB's naming conventions for HD engines differ from the those in this proposal; corresponding EPA names are noted in parentheses.

CARB's warranty updates were partially motivated by evidence that emission-related component failures occur after the end of the current emission warranty periods, when manufacturers are no longer responsible for repair or replacement costs under the warranty provisions, but before the end of the engine's regulatory useful life, through which time engines are certified by the manufacturer to meet the emission standards. According to the Updated Informative Digest prepared for CARB's Amendments to California Emission Control System Warranty Regulations and Maintenance Provisions, "CARB's test programs have identified numerous heavy-duty vehicles with mileages within their applicable regulatory useful life periods, but beyond their warranty period, that have NO<sub>x</sub> emission levels significantly above their applicable certification standards."<sup>473</sup> These incidents may not be frequent enough to trigger an emission recall under California's program, but CARB noted concern about engine-specific emission equipment failures not covered by warranty. In addition, a survey of owners and repair shops performed for CARB with respect to downtime for repairs found that over half of the owners surveyed experienced downtime to address repairs, and more than 60 percent of those repairs were not covered by emission warranties.<sup>474</sup>

The market for extended warranties suggests that some truck purchasers are concerned enough about out-of-warranty repairs to be willing to purchase additional warranty coverage,

<sup>473</sup> California Air Resources Board, "HD Warranty 2018 Staff Report: Initial Statement of Reasons", May 2018. Available here: <https://ww2.arb.ca.gov/sites/default/files/barcu/regact/2018/hdwarranty18/isor.pdf>. See also the ANPR comments of the California Air Resources Board, EPA-HQ-OAR-2019-0055-0471.

<sup>474</sup> California Air Resources Board, "Survey and Analysis of Heavy-Duty Vehicle Warranties in California", December 2017; see pages 6–7, Available online: <https://ww2.arb.ca.gov/sites/default/files/barcu/regact/2018/hdwarranty18/apph.pdf>.

either directly from the manufacturers or from independent third parties. According to a survey conducted on behalf of CARB in support of their heavy-duty warranty program, approximately 40 percent of all new heavy-duty vehicle buyers "purchase or receive" an extended warranty under which the coverage is extended to 417,000 miles on average.<sup>475 476</sup> This survey data correlates with information provided to CARB by the Truck and Engine Manufacturers Association, which indicated that 50 percent of new heavy-duty Class 8 vehicles are sold with a 500,000 mile extended warranty.<sup>477</sup>

#### iv. Proposed Emissions Warranty Provisions

This section describes the proposed regulatory emissions warranty provisions, including the lengthened warranty periods we are proposing, by engine category and the components covered. Our proposed warranty provisions are in a new 40 CFR 1036.120. We request comment on the proposed warranty mileage values, as well as the corresponding age-based criteria. Commenters also are encouraged to address whether warranty periods should be a consistent fraction of the final useful life periods and whether we should align with CARB's Omnibus program when considering warranty periods for the final rule.

#### a. Proposed Warranty Periods by Primary Intended Service Class

We are proposing to update our emissions warranty periods for

<sup>475</sup> California Air Resources Board, "Survey and Analysis of Heavy-Duty Vehicle Warranties in California", December 2017; see page 17, Available online: <https://ww2.arb.ca.gov/sites/default/files/barcu/regact/2018/hdwarranty18/apph.pdf>.

<sup>476</sup> Some of these extended warranties may be purchased by the owners; others may be added by the dealer as part of the sales package.

<sup>477</sup> California Air Resources Board, "Staff Report: Initial Statement of Reasons" May 2018, see page II-7. Available here: <https://ww2.arb.ca.gov/sites/default/files/barcu/regact/2018/hdwarranty18/isor.pdf>.

emission-related components designed to reduce criteria pollutant emissions, beginning with model year 2027 and later heavy-duty engines.<sup>478</sup> Following our approach for the proposed useful life periods, we are proposing two options (proposed Options 1 and 2) and our proposed warranty periods vary by primary intended service class to reflect the difference in average operational life of each class.<sup>479</sup>

When a manufacturer's certified configuration includes hybrid system components (e.g., batteries, electric motors, and inverters), those components are considered emission-related components, which would be covered under the proposed warranty requirements in new 40 CFR 1036.120.<sup>480</sup> Similar to the proposed approach for useful life in Section IV.A, we are proposing that a manufacturer certifying a hybrid engine or hybrid powertrain would declare a primary intended service class for the engine family and apply the corresponding warranty periods in the proposed 40 CFR 1036.120 when certifying the engine configuration.<sup>481</sup>

<sup>478</sup> We are proposing that components installed to control both greenhouse gas (i.e., CO<sub>2</sub>, N<sub>2</sub>O, and CH<sub>4</sub>) and criteria pollutant emissions would be subject to the proposed warranty periods. See proposed 40 CFR 1036.150(w) and Section XII.B for additional warranty considerations related to greenhouse gas emissions.

<sup>479</sup> All engines covered by a primary intended service class would be subject to the corresponding warranty period, regardless of fuel used.

<sup>480</sup> See our proposed new definition of "emission-related component" in 40 CFR 1036.801. Defects or failures of hybrid system components can result in the engine operating more, and thus increase emissions.

<sup>481</sup> See proposed updates to 40 CFR 1036.140 for the primary intended service classes that are partially based on the GVWR of the vehicle in which the configuration is intended to be used. See also the proposed update to definition of "engine configuration" in 40 CFR 1036.801 to clarify that an engine configuration would include hybrid components if it is certified as a hybrid engine or hybrid powertrain.

Also similar to our proposal for useful life, our proposed approach to clarify that hybrid components are part of the broader engine configuration provides truck owners and operators with consistent warranty coverage based on the intended vehicle application.

Currently, emission warranties for most HD engine classes (Spark-ignition HDE, Light HDE, and Medium HDE) cover about half of the respective useful life mileages. As mentioned in Section IV.B.1.ii, we believe that fewer incidents of mal-maintenance and tampering occur during the warranty period, and thus fewer would occur overall if the warranty period is lengthened. Consistent with our current requirements, we believe it is appropriate to propose to lengthen the warranty mileage to continue to cover at

least half of the useful life mileage for all engine classes.

More specifically, we are proposing two options that generally represent the range of revised emission warranty periods we are considering adopting in the final rule. Proposed Option 1 includes warranty periods that are aligned with the MY 2027 and MY 2031 periods adopted by CARB, which are close to 80 percent of useful life.<sup>482</sup> At this time, we assume most manufacturers would continue to certify 50-state compliant engines in MY 2027 and later, and it would simplify the certification process if there is consistency between CARB and federal requirements. The warranty periods of proposed Option 2 would apply in a single step beginning in model year 2027, and would match CARB's Step 1

warranty periods that will already be in effect beginning in model year 2022 for engines sold in California.<sup>483</sup> The proposed Option 2 mileages cover 40 to 55 percent of the proposed Option 1 MY 2031 useful life mileages and represent an appropriate lower end of the range of the revised regulatory emission warranty periods we are considering. Our proposed emissions warranty periods for heavy-duty engines are presented in Table IV-9.<sup>484</sup> We estimated the emissions impacts of the proposed warranty periods in our inventory analysis, which is summarized in Section VI and discussed in detail in Chapter 5 of our draft RIA. In Section V, we estimated indirect and operating costs associated with the proposed warranty periods.

TABLE IV-9—PROPOSED OPTIONS 1 AND 2 EMISSIONS WARRANTY PERIODS

Primary intended service class	Current <sup>a</sup>	Proposed Option 1				Proposed Option 2 <sup>a</sup>	
		MY 2027–2030 <sup>b</sup>		MY 2031+ <sup>c</sup>			
	Miles	Miles	Hours	Miles	Hours	Miles	Hours
Spark-Ignition HDE .....	50,000	110,000	6,000	160,000	8,000	110,000	5,500
Light HDE .....	50,000	150,000	7,000	210,000	10,000	110,000	5,500
Medium HDE .....	100,000	220,000	11,000	280,000	14,000	150,000	7,000
Heavy HDE .....	100,000	450,000	22,000	600,000	30,000	350,000	17,000

<sup>a</sup> Current and proposed Option 2 warranty period is the stated miles or 5 years, or hours if applicable, whichever comes first.

<sup>b</sup> The proposed Option 1 warranty period for model years 2027–2030 is the stated miles, hours, or 7 years, whichever comes first.

<sup>c</sup> The proposed Option 1 warranty period for model years 2031 and later is the stated miles, hours, or 10 years, whichever comes first.

While we believe a majority of engines would reach the warranty mileage in a reasonable amount of time, some applications may have very low annual mileage due to infrequent use or low speed operation; these engines may not reach the warranty mileage for many years. To ensure manufacturers are not indefinitely responsible for components covered under emissions warranty in these situations, we are proposing revised years-based warranty periods and new hours-based warranty periods for proposed Option 1 and new hours-based warranty periods for proposed Option 2. Consistent with current warranty provisions, the warranty period would be whichever warranty value (*i.e.*, mileage, hours, or years) occurs first.

For the years-based period, which would likely be reached first by engines with lower annual mileage due to infrequent use, proposed Option 1

would increase the current period from 5 years to 7 years for MY 2027 through 2030, and to 10 years starting with MY 2031. We are also proposing to add an hours-based warranty period to both proposed options, as shown in Table IV-9, to cover engines that operate at low speed and/or are frequently in idle mode. In contrast to infrequent use, low speed and idle operation can strain emission control components and we believe it is appropriate to factor that gradually-accumulated work into a manufacturer's warranty obligations. We are proposing warranty hours for all primary intended service classes based on a 20 mile per hour average vehicle speed threshold to convert from the proposed mileage values.<sup>485</sup> We note that applying a consistent 20 miles per hour conversion factor to the proposed mileage periods would result in a variable number of years of warranty coverage across classes and, in some

cases, fewer years than the years-based period for a given model year. We request comment on applying a different conversion speed for all classes or a unique speed to each engine class to calculate the hours-based periods.

Consistent with existing regulations, our proposed warranty provisions in new 40 CFR 1036.120(c) identify the components covered by emission warranty as the general emission-related components listed in 40 CFR 1068, appendix A, and any other components a manufacturer may develop to control emissions. The emission-related components listed in Appendix A are broad categories of components and systems that affect emissions. We request comment on the completeness of this list and whether we should consider adding other or more specific components or systems. We also request comment on whether it is appropriate to expand the list of components covered

<sup>482</sup> CARB's Omnibus MY 2031 warranty mileages for the range of HD engine classes span 78 percent to 80 percent of the proposed Option 1 useful life mileages presented in Section IV.A.

<sup>483</sup> For SI engines, the proposed Option 2 warranty mileage matches the current useful life for

those engines, consistent with the approach for Light HDE proposed Option 2 warranty.

<sup>484</sup> We are proposing to migrate the current alternate standards for engines used in certain specialty vehicles from 40 CFR 86.007–11 and 86.008–10 into 40 CFR 1036.605 without modification. See Section XII.B of this preamble for

a discussion of these standards and options for which we are requesting comment.

<sup>485</sup> As noted in Section IV.A, we are proposing hours-based useful life values for the Heavy HDE class in proposed Option 1 based on the same 20 mile per hour average vehicle speed conversion factor.

by emission warranty to include any component whose failure causes the vehicle's OBD MIL to illuminate, as adopted by CARB.<sup>486</sup> While we agree that an OBD MIL could be used by an owner or technician to identify an underperforming or failed emission-related component that should be replaced under warranty, we currently have concerns that not all OBD MILs are tied directly to an emission-related component. If we were to finalize a link between warranty and OBD MILs, we expect the cost of expanding the list of warrantable components to include all components that may trigger an OBD MIL, regardless of their direct impact on emissions, would be unreasonable.

#### b. Proposed Warranty for Heavy-Duty Electric Vehicles

Similar to the proposed approach for BEV and FCEV useful life periods, described in IV.A, we are proposing in 40 CFR 1037.120(b)(2) that BEV and FCEV manufacturers apply the warranty periods corresponding to an engine-based primary intended service class, as specified in the proposed 40 CFR 1037.120(b).<sup>487 488</sup> The proposed 40 CFR 1037.120(b)(2) specifies that prior to MY 2027 manufacturers choosing to generate NO<sub>x</sub> emission credits in MYs 2024 through 2026 would apply the warranty periods in the current 40 CFR 86.001-2; starting in MY 2027 manufacturers would apply the warranty periods specified in the proposed 40 CFR 1036.104. Manufacturers choosing not to generate NO<sub>x</sub> emission credits with their BEVs or FCEVs could alternatively choose in MY 2027 or later to certify to the existing emission warranty requirements for GHGs, as specified in the current 40 CFR 1037.120(b)(1).<sup>489</sup> As specified in the existing 40 CFR 1037.120(e), all manufacturers would continue to describe in their owners' manual the

<sup>486</sup> California Air Resources Board. "Staff Report: Initial Statement of Reasons-Public Hearing to Consider the Proposed Heavy-Duty Engine and Vehicle Omnibus Regulation and Associated Amendments". June 23, 2020. Page III-52. Available online: <https://ww2.arb.ca.gov/sites/default/files/barcu/regact/2020/hdomnibuslownox/isor.pdf>.

<sup>487</sup> Manufacturers would identify a primary intended service class as specified in proposed 40 CFR 1037.102(b)(1).

<sup>488</sup> The warranty periods included in the Alternative would similarly apply to BEVs and FCEVs; see Section IV.B.1.vi for more discussion on the Alternative warranty periods considered for this proposal.

<sup>489</sup> Prior to MY 2027, manufacturers who chose not to generate NO<sub>x</sub> emission credits would apply the warranty periods specified in the current 40 CFR 86.001-2, which are equivalent to those specified in the current 40 CFR 1037.120(b)(1).

warranty provisions that apply to the vehicle.

As discussed in Section IV.A, data from BEV transit buses and DOE research and development work on FCEVs suggest that BEV and FCEV technologies will be capable of operating over mileages or time periods similar to CI engines in the 2027 and beyond timeframe; thus, we believe it is appropriate for the same criteria pollutant warranty requirements to apply to BEV and FCEV technologies as those specified for CI engines for those manufacturers who choose to generate NO<sub>x</sub> emission credits.

We further recognize that repeated repair or maintenance issues with a BEV or FCEV could increase vehicle operating costs and lead owners to purchase a vehicle powered by a CI or SI engine instead, which would result in higher emissions than a zero-emission tailpipe battery or fuel cell electric vehicle. Our proposed BEV and FCEV warranty requirements for manufacturers who choose to generate NO<sub>x</sub> emission credits from BEVs or FCEVs are expected to decrease those operating costs in two ways. First, by encouraging owners to conduct vehicle maintenance that ensures continued warranty coverage and maintains the benefits of the zero-tailpipe emission performance. Second, by encouraging manufacturers to simplify repair processes and provide better training to technicians in an effort to reduce their warranty repair costs.

As specified in the proposed 40 CFR 1037.120(c), we propose to clarify that batteries and fuel cells in BEVs and FCEVs, respectively, are considered covered components and would be subject to the proposed warranty requirements in 40 CFR 1037.120(b)(2) for manufacturers choosing to generate NO<sub>x</sub> emission credits. Our proposed approach for component coverage reflects that defects or failures of batteries or fuel cells could render the vehicle inoperable, and thus the vehicle would cease to provide zero tailpipe emission performance over the full useful life period despite having generated emission credits for the full useful life period. We note that our proposed approach is less comprehensive than the CARB Zero Emission Powertrain ("ZEP") Certification approach, which defines "warranted part" as "any powertrain component" in the case of zero-emission powertrains.<sup>490</sup> At the end of

<sup>490</sup> See Attachment C, "Proposed, California Standards and Test Procedures for New 2020 and Subsequent Model Heavy-Duty Zero-Emissions Powertrains", p. 17 for details on warranty

this subsection we request comment on our proposed approach for component coverage relative to the CARB ZEP Certification approach.

In developing our proposal for the duration of the warranty period for BEVs and FCEVs, we considered two other options: (1) Align with CARB Omnibus emission warranty requirements for BEVs and FCEVs of 3 years or 50,000 miles, or (2) align criteria pollutant warranty periods with the periods specified for GHG emissions in the current 40 CFR 1037.120 for all manufacturers. The CARB Omnibus warranty requirements for BEVs and FCEVs match what manufacturers are already required to offer if they participate in the California Heavy-duty Vehicle Incentive Program (HVIP), and are less than industry standards for warranty periods based on information submitted to CARB through the certification process.<sup>491</sup> The second option we considered, aligning criteria pollutant and GHG warranty periods for BEVs and FCEVs would be a simplistic approach, but would not recognize the use of these technologies to generate NO<sub>x</sub> emission credits; under the proposed ABT program, we would allow these NO<sub>x</sub> emission credits to be used to produce higher-emitting engines with longer warranty period requirements.<sup>492</sup> As such we are proposing that only manufacturers who choose not to generate NO<sub>x</sub> emission credits with BEVs or FCEVs could choose to certify to criteria pollutant warranty requirements equivalent to the existing GHG emission warranty requirements.

We request comment on our proposed approach for BEV and FCEV warranty requirements to match those of the engine-based primary intended service class for manufacturers who choose to generate NO<sub>x</sub> emission credits from BEVs or FCEVs. Commenters are encouraged to provide information and data on whether such requirements would help to ensure the zero-emission tailpipe performance of these technologies, or if they would hinder the integration of these technologies

requirements. Available at: <https://ww2.arb.ca.gov/sites/default/files/barcu/regact/2019/zepercrt/15dayattc.pdf> (last accessed August 24, 2021).

<sup>491</sup> California Air Resources Board. Staff Report: Initial Statement of Reasons for Proposed Alternative Certification Requirements and Test Procedures for Heavy-Duty Electric and Fuel Cell Vehicles and Proposed Standards and Test Procedures for Zero-Emission Powertrains (Zero-Emission Powertrain Certification Regulation), December 31, 2018. Available online: <https://ww3.arb.ca.gov/regact/2019/zepercrt/isor.pdf>.

<sup>492</sup> See Section IV.G for details on the proposed ABT program, which includes restrictions for the extent to which engines could emit emissions above the proposed standards.



into the heavy-duty vehicle market. If commenters suggest that we should finalize another alternative to our proposed approach, then we request information and data supporting their views on how such an alternative would support the environmental benefits of zero-emission tailpipe technologies. We further request comment on our proposed approach that batteries and fuel cells in BEVs and FCEVs, respectively, are covered under warranty for manufacturers choosing to generate NO<sub>x</sub> emission credits. If commenters suggest that we include additional components in the final rule, such as the CARB ZEP Certification approach, we request that commenters provide a list of which specific components should be covered (e.g., electric motor, axles), along with a rationale for why those components should be covered under emission warranty.

#### c. Proposed Warranty for Incomplete Vehicle Refueling Emission Standards

As noted in Section III.E, proposed Options 1 and 2 include refueling emission standards for Spark-ignition HDE that are certified as incomplete vehicles above 14,000 lb GVWR.<sup>493</sup> Our proposed refueling standards are equivalent to the refueling standards that are in effect for light- and heavy-duty complete Spark-ignition HDVs. We project manufacturers would adapt the existing onboard refueling vapor recovery (ORVR) systems from those complete vehicle systems to meet our proposed refueling standards.

As noted in Section III.E, we are not reopening or proposing to change evaporative emission requirements that currently apply for all SI engines or refueling emission standards that currently apply for complete vehicles. Because the onboard refueling vapor recovery systems necessary to meet the proposed refueling standards are expected to build on existing evaporative systems, proposed Options 1 and 2 would require that Spark-ignition HDE manufacturers provide a warranty for the ORVR systems of incomplete vehicles above 14,000 lb GVWR for the same warranty periods that currently apply for evaporative emission control components on these vehicles.<sup>494</sup> Our proposal to apply the existing warranty periods for evaporative emission control systems to

the ORVR systems is similar to our approach to the regulatory useful life periods associated with our proposed refueling standards discussed in Section IV.A.

#### v. Additional Considerations for Components Covered and Warranty Claims

Consistent with existing regulations, our proposed warranty provisions in new 40 CFR 1036.120(c) identify the components covered by emission warranty as the general emission-related components listed in 40 CFR 1068, appendix A, and any other components a manufacturer may develop to control emissions. The emission-related components listed in appendix A are broad categories of components and systems that affect emissions. We request comment on the completeness of this list and whether we should consider adding other systems or more specific components of systems.

As mentioned in Section IV.B.1.iii, CARB recently expanded their list of components covered by emission warranty to include any component whose failure causes the vehicle's OBD MIL to illuminate to ensure malfunctioning components were repaired in a timely manner.<sup>495</sup> We believe the proposed lengthened warranty periods would effectively encourage prompt maintenance without the need to expand the list of components covered beyond those specifically identified as emission-related components. We are also including several other proposed updates to improve access to valuable maintenance information for certain emission-related components. We are proposing to require manufacturers to update their owner's manuals to improve serviceability (Section IV.B.3) and to expand the list of OBD parameters available to the public (Section IV.C).

As specified in the current 40 CFR 1068.115 and referenced in proposed 40 CFR 1036.120(d), manufacturers may deny warranty claims if the engine was improperly maintained or used. In proposed 40 CFR 1036.125(h)(2), manufacturers would describe the documentation they require for owners to demonstrate their engines are properly maintained.<sup>496</sup> ANPR commenters suggest that DEF quality

sensor data alone is an incomplete indicator of an owner's commitment to maintaining high-quality DEF. EPA received comments describing incidents where DEF quality faults were triggered repeatedly despite flushing the system and filling the tank with new DEF, suggesting a fault with a system sensor.<sup>497</sup> A recent online discussion indicates that some OEMs may be denying warranty claims on the basis of using poor quality DEF.<sup>498</sup> While this may be justified for repeated DEF quality faults or extremely low urea concentrations (e.g., using water), DEF quality sensor readings may also indicate only slightly abnormal urea concentrations due to unintentionally long storage periods or unpredicted improper storage temperatures. In either case, we expect a DEF quality-triggered engine derate would induce a user to address the DEF quality issue before it would cause a problem downstream.

We note that current 40 CFR 1068.115 allows manufacturers to deny a warranty claim only if they show that a component failure was due to improper maintenance or use by the owner or operator, by accidents for which the manufacturer has no responsibility, or by acts of God subject to certain limitations. For example, 40 CFR 1068.115(b)(3) does not allow a manufacturer to deny a warranty claim based on action or inaction by the operator unrelated to the warranty claim. In proposed 40 CFR 1036.120(d), we propose to further clarify that, as described in 40 CFR 1068.115, for highway heavy-duty engines a manufacturer may deny warranty claims if the operator caused the problem through improper maintenance or use. In other words, a manufacturer must use more than just the presence of a system fault before denying a warranty claim for improper maintenance and would have to show that a component failure was directly connected to that fault. We request comment on the availability of high-quality DEF and whether EPA should explicitly state that manufacturers cannot deny warranty claims based on the use of commonly available DEF, as is currently specified for fuel in 40 CFR 1068.115(b)(6). Commenters are encouraged to suggest if a commonly available DEF provision should be limited to heavy-duty highway engines in 40 CFR 1036.120 or

<sup>493</sup> See our proposed updates to 40 CFR 1037.103.

<sup>494</sup> Warranty periods for refueling emissions components on incomplete Light HDV would be 5 years or 50,000 miles, and 5 years or 100,000 miles for components on incomplete Medium HDV and Heavy HDV. See our proposed updates to 40 CFR 1037.120.

<sup>495</sup> California Air Resources Board. Staff Report: Initial Statement of Reasons—Public Hearing to Consider the Proposed Heavy-Duty Engine and Vehicle Omnibus Regulation and Associated Amendments. June 23, 2020. Page III–52. Available online: <https://ww2.arb.ca.gov/sites/default/files/barcu/regact/2020/hdomnibuslownox/isor.pdf>.

<sup>496</sup> See our discussion in Section IV.B.5.

<sup>497</sup> See the comments of the National Association of Small Trucking Companies ("NASTC"), EPA-HQ-OAR-2019-0055-0456.

<sup>498</sup> Wallace, Sam. "Keep Your Diesel Exhaust Fluid From Voiding Your Warranty", Mitchell1 ShopConnection, August, 2015. Available online: <https://mitchell1.com/shopconnection/keep-your-diesel-exhaust-fluid-from-voiding-your-warranty/>.

if it should be broadly applied to all sectors covered under part 1068.

vi. Analysis of Proposed Emission Warranty Periods and Alternatives

Consistent with our useful life discussion in Section IV.A.4, we considered an alternative set of warranty periods (the Alternative) that would apply as a single step beginning in model year 2027. The warranty mileages for the Alternative are longer

than the proposed Option 1 MY 2031 useful life mileages. The Alternative mileages align with the warranty mileages presented in CARB's September 2019 Public Workshop for their Heavy-Duty Low NO<sub>x</sub> program and cover up to 94 percent of the useful life mileages considered for the Alternative.<sup>499</sup> The warranty mileages of the Alternative would place an even greater emphasis on the importance of holding manufacturers responsible for

emission control defects for a period of time that aligns more closely with the operational life of the engine. However, we believe it would be inappropriate to consider warranty mileages equal to or beyond the proposed Option 1 MY 2031 useful life mileages, which are the maximum useful life mileages we consider to be feasible given the level of emission standards evaluated in this proposal based on available data.

TABLE IV-10—COMPARISON OF WARRANTY MILEAGES CONSIDERED

Primary intended service class	Current	Proposed Option 1		Proposed Option 1	Alternative
		MY 2027–2030	MY 2031+		
Spark-Ignition HDE .....	50,000	110,000	160,000	110,000	200,000
Light HDE .....	50,000	150,000	210,000	110,000	280,000
Medium HDE .....	100,000	220,000	280,000	150,000	360,000
Heavy HDE .....	100,000	450,000	600,000	350,000	800,000

The Alternative warranty mileages are equivalent to or longer than the useful life mileages included in the proposed Options 1 and 2. Since we do not believe that the emission warranty period should be equal to or greater than the useful life period, we focus on the warranty values of proposed Options 1 and 2 and the range in between them for this proposal. We expect that we would need additional data before we could project that the standards and useful life values of the Alternative are feasible for the MY 2027 timeframe in order to consider adopting them, or the Alternative warranty mileages, in the final rule.

We estimated the emissions impacts of the Alternative warranty periods in our inventory analysis, which is summarized in Section VI and discussed in detail in Chapter 5 of our draft RIA. We do not present an analysis of the costs of the Alternative, since those warranty periods are out of the range of mileages we are currently considering without additional information to indicate that the standards and useful life values of the Alternative are feasible in the MY 2027 timeframe.

vii. Other Approaches To Ensure Long-Term In-Use Emission Performance

Under our current and proposed warranty provisions, parts and labor for emission-related components are equally and fully covered over the

entirety of the warranty period. A graduated warranty coverage approach, which was introduced as a topic in the ANPR to this rule and is described in more detail below, may provide a similar assurance of long-term emission performance with a smaller impact on the purchase price.

Manufacturers are responsible for repairing or replacing emission-related components that are found to be defective within the specified warranty period. Manufacturers include warranty repairs in the price of an engine or vehicle, and the Agency considers the warranty cost implications of all our emission control rules.<sup>500</sup> In Section V, we provide the cost impacts of the proposed warranty periods. The impact that a longer warranty would have on the purchase price of an individual engine will vary by factors such as a manufacturer's estimate of the risk for an engine, their presumed competition in the market, and their relationship with the purchaser.

In the current market, purchasers desiring greater warranty protection can buy extended warranties, either from the engine manufacturers or third-party companies. The experience with extended warranties reveals information about the range of owner preferences with respect to bearing the costs of out-of-warranty repairs. Some of the estimated 40 percent of purchasers obtaining extended warranties may be large companies that purchase extended

warranty coverage because they have comprehensive in-house service facilities and a business relationship with engine manufacturers that allows them to perform warranty repairs in-house. Other owners may be reliant on the engine manufacturer for warranty repairs but prefer to purchase extended warranties for insurance against the cost of out-of-warranty repairs, in essence paying for those repairs up-front. Of the 60 percent of purchasers that decline to purchase extended warranties, some companies may reduce the risk of out-of-warranty repair costs by selling their vehicles near the point when the warranty period ends. Others may prefer to pay for out-of-warranty repairs when and if they occur. Still others may choose to not make out-of-warranty repairs at all. It is clear that lengthening the warranty period would remove some of a purchaser's flexibility to address out-of-warranty repair costs. We request comment on the extent to which emissions warranty period is an important aspect of purchasers' business decisions, and the specific impacts purchasers anticipate for the range of emissions warranty periods we are considering in this rule. For instance, we are interested in how a longer regulatory emissions warranty may impact the timing of an engine or truck purchase, how long an engine or vehicle is kept, and/or how well an engine is maintained.

<sup>499</sup> Brakora, Jessica. Memorandum to Docket: EPA-HQ-OAR-2019-0055. CARB 2019 Public Workshop Presentations Related to Regulatory

Useful Life and Emissions Warranty. March 19, 2021.

<sup>500</sup> A manufacturer estimates the expected costs of warranty repairs actuarially, and these costs are

added to the purchase price of the engine or vehicle, spreading the predicted repair costs over the number of engines or vehicles sold.

In the ANPR, we described two different potential approaches to graduated warranties. Under one approach, there could be longer, prorated warranties that provide different levels of warranty coverage based on a vehicle's age or mileage. Alternatively, the warranty could be limited to include only certain parts during specified warranty periods, and/or exclude labor for some, or even all, of the duration of coverage. We received feedback from several stakeholders in response to the ANPR. Allison Transmission supported EPA considering prorated parts and labor as an approach to lengthening warranty periods.<sup>501</sup> Volvo suggested that applying the longer warranty periods to only critical components could be a way to reduce manufacturer costs.<sup>502</sup> NADA recommended that longer warranty periods be proposed in a manner that varies by class of component or system and include the approaches EPA presented in the ANPR such as limited component and/or prorated warranties.<sup>503</sup>

We are not proposing and did not analyze a graduated warranty approach for this proposal. However, we may consider a graduated warranty as a viable alternative to our proposed warranty periods if we receive additional information that would support such an approach. A graduated warranty approach could extend beyond our proposed warranty periods in mileage, hours, and years, to cover more of the operational life of the engine, but it could be based on different phases of varying coverage. These could include, for example:

- Phase 1: Full parts and labor coverage for all emission-related components,
- Phase 2: Parts and labor coverage for limited emission-related components, and
- Phase 3: Parts-only coverage for limited emission-related components.

We request comment on whether EPA should adopt a phased approach for a longer emission warranty period. Supporters of such an approach should comment on the number of phases, the length of each phase, and the components to include in the set of limited emission-related components under such an approach. With respect to Phase 1, which would be similar to a traditional warranty with full parts and labor coverage, EPA may consider the

<sup>501</sup> See comments from Allison, Docket ID EPA-HQ-OAR-2019-0055-0461.

<sup>502</sup> See comments from Volvo, Docket ID EPA-HQ-OAR-2019-0055-0463.

<sup>503</sup> See comments from NADA, Docket ID EPA-HQ-OAR-2019-0055-0369.

warranty mileages in proposed Option 2 as the minimum lower bound. For the other phases, commenters are encouraged to include data to support their suggested mileage, hours, and years of coverage. When considering the set of limited parts to be covered in the other phase(s), EPA may consider including components that are relatively high-cost components, or components that are labor-intensive (and thus expensive) to replace. We request data to support the set of limited emission-related components that should be included in the other phase(s), including failure rates, component costs, and labor costs to replace specific components. We note that our proposed maintenance provisions in 40 CFR 1036.125 include two categories of components we could consider as the set of limited emission-related components covered in the graduated warranty approach. As described in Section IV.B.5, these two categories of components include a proposed list of specific components with minimum maintenance intervals, and criteria to identify components that can only be replaced as part of scheduled maintenance if the manufacturer covers the cost.

Finally, we request comment on whether a graduated warranty approach would achieve the goals set out in Section IV.B.1.ii: Providing an extended period of protection for purchasers, encouraging proper maintenance, discouraging tampering, and incentivizing manufacturers to design emission control components that are less costly to repair.

## 2. Electronic Control Module Security

CAA section 203(a)(3)(B) and 40 CFR 1068.101(b)(2) prohibit selling, offering to sell, or installing any part or component whose principal effect is to bypass, defeat, or render inoperative a motor vehicle emission control device or element of design (*i.e.*, a “defeat device”), where the person knows or should know that the part is being offered for sale, installed for such use or put to such use. Once installed, defeat devices can result in significant tailpipe emissions increases, and with the long service life of heavy-duty vehicles, would produce a disproportionate amount of lifetime emissions, compared to a vehicle with properly functioning emission controls. One of the key enablers of defeat devices with modern engines is the unauthorized modification, or tampering, with certified calibration parameters and/or software within the electronic control module (“ECM”). Tampering with the ECM can introduce a different

calibration that allows the engine to produce power at higher emission rates, or it can bypass or disable inducement algorithms intended to ensure proper functioning of SCR systems. The EPA Office of Enforcement and Compliance Assurance (OECA) has found extensive evidence of tampering with the emission control systems on heavy-duty engines and vehicles nationwide, although EPA lacks robust data on the exact rate of tampering.<sup>504</sup> Recently, OECA announced a new National Compliance Initiative (“NCI”) to address the manufacture, sale, and installation of defeat devices on vehicles and engines through civil enforcement.<sup>505</sup>

EPA has for decades had regulations to address the “physically adjustable parameters” on heavy-duty highway engines that can alter emissions performance.<sup>506</sup> These regulations require the manufacturer, subject to review by EPA, to identify the appropriate range of adjustment on the operating parameters or physical settings on an engine that could potentially increase emissions and the adequacy of limits, stops, seals, or other mechanical means of limiting or prohibiting adjustment outside of these appropriate ranges. Parameters such as injection timing on a diesel engine were once physically adjustable with common tools and clearly an adjustable parameter. With a modern ECM, many of these parameters are now electronically adjustable through changes to software and calibration settings. As discussed in Section XII.A.2, we are proposing to revise our regulations by adding 40 CFR 1068.50 to specifically address electronically adjustable parameters and require that manufacturers attest that they are using sufficient measures to secure the ECM, thereby limiting adjustment or alteration beyond those used in the certified configuration.

ECM tampering is often designed to avoid detection, where the software, controls, and onboard diagnostics are intentionally manipulated so commonly available scan tools cannot detect the presence of a defeat device. This complicates the efforts of state

<sup>504</sup> U.S. EPA. “Tampered Diesel Pickup Trucks: A Review of Aggregated Evidence from EPA Civil Enforcement Investigations”, November 20, 2021, Available online: <https://www.epa.gov/enforcement/tampered-diesel-pickup-trucks-review-aggregated-evidence-epa-civil-enforcement>.

<sup>505</sup> U.S. EPA. National Compliance Initiative: Stopping Aftermarket Defeat Devices for Vehicles and Engines. Available online: <https://www.epa.gov/enforcement/national-compliance-initiative-stopping-aftermarket-defeat-devices-vehicles-and-engines>.

<sup>506</sup> 40 CFR 86.094–22.

inspection and maintenance programs to identify and address tampered vehicles. ECM tampering is also a concern for manufacturers, because changes to the engine controls can adversely impact the durability of the engine and lead to premature failure. If ECM tampering remains undetected and a failure occurs within the warranty period, the manufacturer would be responsible for the repair costs. Manufacturers have been implementing measures to prevent tampering with software in the engine's ECM, but manufacturers of defeat devices continue to find ways to work around these security measures. Unauthorized access to the ECM and other control modules on a vehicle is also a public safety concern, as malicious tampering could affect the operation of the advanced braking, stability, and cruise control systems found on modern heavy-duty vehicles.<sup>507</sup>

To address the safety, financial liability, operational, and privacy concerns that can result from tampering, manufacturers, industry organizations, and regulators have been working to develop standards and design principles that would improve vehicle cybersecurity, including ECMs. Three such efforts where cybersecurity guidelines and procedures are either under development or already in publication are ISO/SAE J21434, UNECE WP29 Cybersecurity Regulation, and SAE J3061.<sup>508 509 510</sup> Manufacturers may choose to utilize different mixes of technical standards or principles that these organizations recommend. A one-size-fits-all approach with detailed requirements for ECM security for all engines would be neither practical nor prudent. Manufacturers need the flexibility to quickly implement measures to address new or emerging threats and vulnerabilities. Considering this need for flexibility and noting that the security principles in these efforts are constantly evolving as new threats are identified, we are not proposing to

adopt any of these specific guidelines as requirements for manufacturers.

In 40 CFR 1036.205(s), we propose that manufacturers describe all adjustable parameters in their application for certification, which would include electronically controlled parameters. Electronically controlled parameters may be considered practically adjustable as described in proposed 40 CFR 1068.50(d)(2). This would include user-selectable operating modes and modifications that owners can make with available tools. We are proposing that manufacturers describe their approach to limiting access to electronic controls in the certification application. We retain the right to evaluate a manufacturer's determination in their application considering the measures they are using (whether proprietary standards, industry technical standards, or a combination of both), to prevent access to the ECM. At a minimum, this documentation should describe in sufficient detail the measures that a manufacturer has used to: prevent unauthorized access; ensure that calibration values, software, or diagnostic features cannot be modified or disabled; and respond to repeated, unauthorized attempts at reprogramming or tampering.<sup>511</sup> Section XII.A.2 of this preamble describes our proposed new section 40 CFR 1068.50 to codify a set of provisions that are consistent with current industry best practices with respect to adjustable parameters. Additional discussion can be found in Chapter 2 of the draft RIA.

### 3. Serviceability

Defective designs and tampering can contribute significantly to increased in-use emissions. EPA has warranty provisions and tampering prohibitions in place to address such issues. Mal-maintenance, which includes delayed or improper repairs and delayed or unperformed maintenance, also increases in-use emissions and can be intentional (e.g., deferring repairs due to costs) or unintentional (e.g., not being able to diagnose the actual problem and make the proper repair). Mal-maintenance (by owners or repair facilities) can result from:

- Difficulty and high costs to diagnose and repair
- Inadequate troubleshooting guides and maintenance instructions

<sup>511</sup> We are proposing that engines are not in the certified configuration if they are produced with adjustable parameters set outside the range specified in their application for certification or produced with other operating parameters that do not conform to the certified configuration. See Section XII and proposed 40 CFR 1068.50(i).

- Limited access to maintenance information and specialized tools to make repairs

Vehicle owners, repair technicians, and manufacturers all play important and distinct roles in achieving intended in-use emission system performance and preventing mal-maintenance. Vehicle owners are expected to properly maintain the engines, which includes performing preventative maintenance, scheduled maintenance (e.g., maintaining adequate DEF supply for their diesel engines' aftertreatment), and completing repairs when components or systems degrade or fail. Repair technicians are expected to properly diagnose and repair malfunctioning emission systems. Finally, manufacturers play a key role in providing both owners and repair technicians with access to the information they need to perform such expected maintenance and repairs.

EPA published several rules between 1993 and 2003 that improved service information access and required onboard diagnostic (OBD) systems for light-duty vehicles up to 14,000 lb GVWR.<sup>512</sup> In 2009, EPA finalized similar requirements for the heavy-duty industry to ensure that manufacturers make diagnostic and service information available to any person repairing or servicing heavy-duty vehicles and engines (74 FR 8309, February 24, 2009).<sup>513</sup> The service information requirements include information necessary to make use of the OBD system and instructions for making emission-related diagnoses and repairs, training access, technical service bulletins, and other information generally available to their franchised dealers or other persons engaged in the repair, diagnosing or servicing of motor vehicles. Since this time, manufacturers have entered into a service-related agreement through trade associations representing the aftertreatment repair industry and truck and engine manufacturers, highlighting concerns over intellectual property and their continued need for proprietary tools.<sup>514</sup> EPA is not proposing changes to service

<sup>512</sup> See 58 FR 9468 (February 19, 1993); 60 FR 40474 (August 9, 1995); 65 FR 59896 (Oct 6, 2000); and 68 FR 38428 (June 27, 2003).

<sup>513</sup> See 40 CFR 86.010–38(j) for the current service information requirements. We are not proposing to migrate the service information provisions at this time and these provisions will remain in part 86. We are proposing to name the service information provisions as an additional requirement in proposed 40 CFR 1036.601(b). EPA may consider migrating these provisions in a future rulemaking.

<sup>514</sup> Memorandum of Understanding National Commercial Vehicle Service Information. August 2015. Available online: <https://www.etools.org/Heavy-Duty-MOU-2015>.

<sup>507</sup> Stachowski, S., Bielowski, R., Weimerskirch, A. Cybersecurity Research Considerations for Heavy Vehicles (Report No. DOT HS 812 636). Washington, DC: National Highway Traffic Safety Administration. December 2018.

<sup>508</sup> "Road vehicles — Cybersecurity engineering", ISO/SAE FDIS 21434, <https://www.iso.org/standard/70918.html>.

<sup>509</sup> United Nations Economic Commission for Europe, "UNECE WP29 Automotive Cybersecurity Regulation", Available online: <https://argus-sec.com/unece-wp29-automotive-cybersecurity-regulation/>.

<sup>510</sup> Society of Automotive Engineers, "Cybersecurity Guidebook for Cyber-Physical Vehicle Systems". SAE J3061, Available online: [https://www.sae.org/standards/content/j3061\\_201601/](https://www.sae.org/standards/content/j3061_201601/).

information regulations at this time. While the service information regulations were an important first step in improving serviceability, as emission control systems have continued to develop, it has become necessary to consider other improvements that can be made to support in-use maintenance and repair practices. CAA section 207(c)(3)(A) requires manufacturers to provide instructions for the proper maintenance and use of a vehicle or engine by the ultimate purchaser and requires such instructions to correspond to EPA regulations. Section 207(c)(3)(A) also requires manufacturers to provide notice in those instructions that maintenance, replacement, or repair of emission control devices and systems may be performed by any automotive repair establishment or individual using any automotive part which has been certified as provided in section 207(a)(2). Section 207(c)(3)(B) requires that these instructions shall not include any condition on the ultimate purchaser's using, in connection with such vehicle or engine, any component or service (other than a component or service provided without charge under the terms of the purchase agreement) which is identified by brand, trade, or corporate name; or directly or indirectly distinguishing between service performed by the franchised dealers of such manufacturer or any other service establishments with which such manufacturer has a commercial relationship, and service performed by independent automotive repair facilities with which such manufacturer has no commercial relationship; unless EPA finds the vehicle or engine will function properly only if the component or service so identified is used in connection with such vehicle or engine, and that such a waiver is in the public interest.

Section 207(c)(3)(C) states that manufacturers must affix a permanent label indicating that the vehicle or engine is covered by a certificate of conformity and containing other information relating to control of motor vehicle emissions as prescribed by EPA regulations. Finally, section 202(m)(5) clarifies that manufacturers must provide this information promptly to anyone engaged in the repairing or servicing of motor vehicles or engines, except as specified. This section describes proposed regulatory amendments under these statutory provisions and are intended to improve serviceability, reduce mal-maintenance, and ensure owners are able to maintain emission performance throughout the entire in-use life of heavy-duty engines.

#### i. Current Repair and Maintenance Experiences

Continued maintenance issues can result in, among other things, owner dissatisfaction, which may cause some owners to remove or bypass emission controls. Any actions we can take to reduce maintenance issues could reduce incidents of tampering. In the ANPR, EPA requested comment on experiences with serviceability and received comment in three general categories: (1) Frustrations related to advanced emission control system reliability; (2) misdiagnosis and improper repair by professional facilities which lead to repeated trips to repair facilities and significant downtime, and (3) limited access to maintenance information which leads to the inability to self-diagnose problems.

Serviceability concerns affect all trucking operations, although different types of operators may experience these impacts in different ways. EPA received comments from trade organizations representing very large trucking fleets (e.g., the American Trucking Associations, "ATA"), small fleets (e.g., National Association of Small Trucking Companies, "NASTC"), and owner-operators (e.g., Owner-Operator Independent Drivers Association, "OOIDA"), as well as from independent commenters, indicating that serviceability issues are one of the top concerns when operating trucks with advanced emission control systems. ATA commented that current emission control systems are still causing concerns for fleets and noted that in a recent study by ATA's Truck Maintenance Council, aftertreatment maintenance issues, serviceability, and ease of diagnostics were identified as major areas of concern by their members.<sup>515</sup> NASTC submitted comments directly from their members indicating a number of concerns related to serviceability.<sup>516</sup> OOIDA commented that their members have encountered various problems with emissions systems which have had a dramatic impact on their businesses including expensive visits to dealers, lost productivity, poor efficiency, and towing costs.<sup>517</sup> A number of other commenters described their experiences and how improvements can be made to

<sup>515</sup> See the comments of the American Trucking Association, Docket ID EPA-HQ-OAR-2019-0055-0357.

<sup>516</sup> See the comments of the National Association of Small Trucking Companies, Docket ID EPA-HQ-OAR-2019-0055-0456.

<sup>517</sup> See the comments of the Owner-Operator Independent Drivers Association, Docket ID EPA-HQ-OAR-2019-0055-0397.

reduce cost and frustration.<sup>518</sup> Trucking companies participating in a round table discussion in EPA's Region 7 expressed similar concerns about impacts to business as a result of delayed or missed deliveries, including lost customers, and possible legal or contract consequences.<sup>519</sup>

In addition to operators, EPA received comments from state and local agencies supportive of improving access of maintenance information and service tools for fleets and owner-operators.<sup>520 521</sup> For example, NACAA stated that EPA should work to increase access to the information and tools needed to repair the emission control systems on aging trucks, which is especially important for small businesses, small fleets, independent owner/operators, and rural operations, where access to dealer service networks can be a challenge.

#### a. Reliability of EPA 2010 Engines

We are keenly aware of significant discontent expressed by owners concerning their experiences with emission systems on engines compliant with EPA 2010 standards. EPA has also identified numerous Technical Service Bulletins submitted by OEMs to NHTSA's website documenting issues such as no trouble found, wiring concerns, or minor corrosion on connectors which can lead to inducement.<sup>522</sup> Although significant improvements have been made to these systems since they were first introduced into the market, reliability and serviceability continue to cause concern. ATA commented that their members are experiencing problems with a wide variety of issues such as: Aftertreatment wiring harness failures, DEF nozzles plugging or over-injecting, NO<sub>x</sub> sensor failures, defective DEF pumps and level sensors, systems being less reliable in rain and cold weather, more frequent required cleaning of DPFs, and problems related to DEF

<sup>518</sup> For example, see the comments of Swanny's Trucking, Docket ID EPA-HQ-OAR-2019-0055-0252.

<sup>519</sup> Kopin, Amy. Memorandum to docket EPA-HQ-OAR-2019-0055. "EPA Region 7 Heavy-Duty NO<sub>x</sub> ANPR Roundtable Discussion—Serviceability and Inducement-Related Concerns". October 1, 2021.

<sup>520</sup> See the comments of the National Association of Clean Air Agencies, Docket EPA-HQ-OAR-2019-0055-0283.

<sup>521</sup> See the comments of the Northeast States for Coordinated Air Use Management, Docket EPA-HQ-OAR-2019-0055-0288.

<sup>522</sup> See NHTSA Service Bulletins: ID Number 10058856, available here: <https://static.nhtsa.gov/odi/tsbs/2015/SB-10058856-6479.pdf> and ID Number 10154333, available here: <https://static.nhtsa.gov/odi/tsbs/2019/MC-10154333-9999.pdf>.

build-up.<sup>523</sup> ATA also stated that their members have reported that mechanics at dealerships sometimes clear codes with no associated repairs being made. Many of these issues can also lead to severe engine derate and towing costs (see Section IV.D for further information on proposed inducement provisions, including revisions to policy currently in guidance). OOIDA commented that some of its members have experienced emission technology failures that caused their engines to quickly derate, placing truckers and other motorists in unsafe situations.<sup>524</sup>

In addition to the comments highlighting problems related to wiring harness issues and sensor failures, a number of published articles have presented similar findings. For example, “Dealing with Aftertreatment Issues” in Fleet Equipment Magazine discusses how at least one OEM is focusing on improving issues with wiring and sensors “which are often the culprits in aftertreatment downtime.”<sup>525</sup> A recent article from Transport Topics highlights how fleets are experiencing wiring issues and sensor failures that are creating problems that even sophisticated diagnostic tools cannot solve easily.<sup>526</sup>

#### b. Misdiagnosis and Improper Repairs

Misdiagnosis can lead to the unnecessary replacement of parts without properly addressing the problem, which can result in additional breakdowns and tows with return trips to repair facilities for diagnostic service. ATA commented that several fleets are reporting the need for ‘comeback’ repairs and that while emissions-related training for diagnosis and repair work has improved, it is still severely lagging behind expectations. The NASTC describes problems some owners have experienced with repeated emission system component failures.<sup>527</sup> In one example, an owner had to replace four NO<sub>x</sub> sensors, two diesel exhaust fluid

(DEF) filters, a DEF pump, a DPF, and a diesel oxidation catalyst (DOC) within only 6 months of purchasing a new truck. NASTC also described problems other owners experienced due to failures of NO<sub>x</sub> sensors, DPF filters, DOCs, other emission-related sensors, and wiring harnesses, as well as repeated DEF doser injector pumps and valve failures. Other NASTC commenters described improper repair experiences resulting in trucks being down for weeks at a time. An independent commenter stated that repeated repairs in a 6-month time period resulted in loss of his truck and the ability to continue as an owner-operator.<sup>528</sup>

#### c. Limited Access to Repair Facilities, Maintenance Information, and Service Tools

In response to the ANPR, EPA received numerous comments on difficulties associated with repairs of emission control systems. Many commenters indicated there is a substantial wait time to get a vehicle into a specialized repair facility, which, in some cases, was more than a week in addition to the time required to repair the vehicle.<sup>529</sup> This wait time may be manageable if the vehicle remains operational, but can have a significant impact on an owner’s ability to generate income from a vehicle if the truck is subject to an inducement and they are unable to use the vehicle until the repair is made.<sup>530</sup> EPA received comments from the National Tribal Air Association and Keweenaw Bay Indian Community suggesting that service information and tools are not readily available and affordable for individual owners to diagnose and fix their own vehicles, and improved access can be especially important for small businesses, Tribes, and those in rural areas with less ready access to original equipment manufacturer dealer networks.<sup>531</sup>

EPA received a number of comments on difficulties getting the right information or tools to repair vehicles outside of specialized repair facilities. ATA commented that their members report that in order to ensure proprietary tools are used, some manufacturers lock out certain

diagnostic programs needed to further diagnose and reset systems after repairs, which ATA believes is a barrier to owners quickly diagnosing emission control system problems. ATA added that while some large fleets have added laptops in the field to help troubleshoot issues, fleets with more than one brand of truck may face significant expense to acquire multiple OEM software/diagnostic packages for these laptops. NASTC members noted that there are very few independent repair facilities that will repair emission systems problems, and given the long lead times at traditional repair facilities, a single fault code can remove a truck from service for more than a week. NASTC members also commented that diagnostic tools for owners are not affordable but are currently the only way to access diagnostic codes outside of a trip to a repair facility. OOIDA commented that according to a 2018 survey, 73 percent of their members perform repairs and maintenance on their own trucks.<sup>532</sup> OOIDA added that being able to diagnose problems and repair equipment outside of dealerships is important for owner-operators and allows them to save time, avoid downtime, and reduce operating costs; however, they believe that restrictions built into existing trucks are preventing this practice. OOIDA supported an emphasis on serviceability improvements so that professional drivers can independently identify and repair problems with their engines and aftertreatment as much as possible.

#### ii. Proposed Maintenance Information for Improved Serviceability

In addition to labeling, diagnostic, and service information requirements, EPA is proposing to require important maintenance information be made available in the owner’s manual.<sup>533</sup> The owner’s manual is a document or collection of documents prepared by the engine or vehicle manufacturer for the owner or operator to describe appropriate engine maintenance, applicable warranties, and any other information related to operating or maintaining the engine or vehicle. EPA is proposing to require additional maintenance information in the owner’s manual as a way to improve factors that may contribute to mal-maintenance, resulting in better service experiences for independent repair technicians,

<sup>523</sup> See the comments of the American Trucking Association, Docket ID EPA-HQ-OAR-2019-0055-0357.

<sup>524</sup> See the comments of the Owner-Operator Independent Drivers Association, Docket ID EPA-HQ-OAR-2019-0055-0397.

<sup>525</sup> Crissey, Alex. Fleet Equipment Magazine. “Dealing with Aftertreatment Issues”. November 27, 2017. Available online: <https://www.fleetequipmentmag.com/dealing-aftertreatment-issues/>.

<sup>526</sup> Frantz, Gary. Transport Topics. “Diesel Engine Makers Tackle Challenges Posed by Stricter Emission Standards”. May 11, 2020. Available here: <https://www.tnews.com/articles/class-8-engine-makers-tackle-challenges-posed-stricter-emission-standards>.

<sup>527</sup> See the comments of the National Association of Small Trucking Companies (“NASTC”), EPA-HQ-OAR-2019-0055-0456.

<sup>528</sup> See the comments of J. Johnson, Docket ID EPA-HQ-OAR-2019-0055-0265.

<sup>529</sup> See the comments of J. Sibley, Docket ID EPA-HQ-OAR-2019-0055-0397 and those of the National Association of Small Trucking Companies, Docket ID EPA-HQ-OAR-2019-0055-0456.

<sup>530</sup> See Section IV.D for proposed inducement provisions, which include revisions to policy currently in guidance.

<sup>531</sup> See the comments of the National Tribal Air Association, Docket ID EPA-HQ-OAR-2019-0055-0282.

<sup>532</sup> See the comments of the Owner-Operator Independent Drivers Association, Docket ID EPA-HQ-OAR-2019-0055-0397.

<sup>533</sup> Miller, Neil; Kopin, Amy. Memorandum to docket EPA-HQ-OAR-2019-0055. “Serviceability and Additional Maintenance Information”. October 1, 2021.

specialized repair technicians, owners who repair their own equipment, and possibly vehicle inspection and maintenance technicians.<sup>534</sup> Combined with our proposed modifications to onboard diagnostic requirements and proposed provisions for inducements, we expect these proposed serviceability provisions would improve owner experiences operating and maintaining heavy-duty engines and provide greater assurance of long-term in-use emission reductions by reducing likelihood of occurrences of tampering.<sup>535</sup>

EPA is proposing changes to owner's manual and label requirements that would be mandatory for MY 2027 and later engines. The existing proposal would be voluntary for earlier model years, but we are seeking comment on making all or parts of this proposal mandatory as soon as MY 2024. We expect these changes would increase owner understanding of emission control systems, improve experiences at repair facilities, provide better access to information to help identify concerns, and enable owners to self-diagnose problems (especially important for aging trucks). Our proposal is intended to ensure consistent access to emission systems diagrams and part number information across the range of commercial vehicle engines and improve clarity in the information presented in those diagrams. Owner's manuals today include very detailed descriptions of systems such as radios and infotainment centers, fuse box and relay diagrams, and troubleshooting guides for phone connectivity features, but generally include limited information on emission control system operations. Given the importance and complexity of emission control systems and the impact to drivers for failing to maintain such systems (e.g., inducements), EPA believes including additional information about emission control systems in the owner's manual is critical.

We are proposing to require manufacturers to provide more information concerning the emission control system in both the owner's manual and the emissions label. Our

<sup>534</sup> EPA is also proposing changes to existing useful life periods to incentivize improved component durability (see Section IV.A.), onboard diagnostic requirements intended to make emission system faults more easily diagnosed (see Section IV.C), and is proposing inducement provisions for DEF replenishment, DEF quality and certain SCR-related tamper-resistant design intended to ensure manufacturers can meet adjustable parameter and critical emission-related scheduled maintenance requirements (see Section IV.D).

<sup>535</sup> See Section IV.C for discussion on proposed changes to onboard diagnostic requirements and Section IV.D for proposed inducement provisions.

proposal would require the owner's manual to include descriptions of how the emissions systems operate, troubleshooting information, and diagrams. The emissions label would include an internet link to obtain this additional information. EPA has had similar requirements in the past, such as when EPA required vacuum hose diagrams to be included on the emission label to improve serviceability and help inspection and maintenance facilities identify concerns.<sup>536</sup>

Specifically, as a part of the new 40 CFR 1036.125(h)(3)–(9) and (11), we propose that manufacturers provide the following additional information in the owner's manual:

- A description of how the owner can use the OBD system to troubleshoot problems and access emission-related diagnostic information and codes stored in onboard monitoring systems including information about the role of the proposed health monitor to help owners service their engines before components fail.

- A general description of how the emission control systems operate.

- One or more diagrams of the engine and its emission-related components with the following information:

- The flow path for intake air and exhaust gas.

- The flow path of evaporative and refueling emissions for spark-ignition engines, and DEF for compression-ignition engines, as applicable.

- The flow path of engine coolant if it is part of the emission control system described in the application for certification.

- The identity, location, and arrangement of relevant sensors, wiring, and other emission-related components in the diagram. Terminology to identify components would be required to be consistent with codes you use for the OBD system.

- Expected pressures at the particulate filter and exhaust temperatures throughout the aftertreatment system.

- Exploded-view drawings to allow the owner to identify the part numbers and basic assembly requirements for turbochargers, aftercoolers, and all components required for proper functioning of EGR and aftertreatment devices including enough detail to allow a mechanic to replace any of those components.

- A basic wiring diagram for aftertreatment-related components including enough detail to allow a mechanic to detect improper functioning of those components.

<sup>536</sup> See 53 FR 7675, March 9, 1988 and 55 FR 7177, February 29, 1990 for more information.

- Statement instructing owners or service technicians where to find emission recall and technical repair information available without charge from the National Highway Traffic Safety Administration.<sup>537</sup>

- Troubleshooting guide to address DEF dosing- and DPF regeneration-related warning signals that would be displayed in the cab or with a generic scan tool, including a description of the fault condition, the potential causes, the remedy, and the consequence of continuing to operate without remedy including a list of all codes that cause derate or inducement (e.g., list SPN/FMI combinations and associated operating restrictions, see proposed requirements in 40 CFR 1036.110(b)(9)(vi)).

- For the DPF system, instructions on how to remove DPF for cleaning, criteria for cleaning the DPF including pressure drop across the filter, clean filter weight, pre-installed filter weight, a statement that DPF inlet and outlet pressures are available with a generic scan tool, and information on maintenance practices to prevent damage to DPFs.

We propose to include these eight additional provisions for all engine configurations, including hybrids, where applicable.<sup>538</sup> EPA is seeking comment on these eight proposed additional provisions or other approaches to improve the serviceability of heavy-duty engine emission control systems. Finally, in 40 CFR 1036.135(c), EPA is proposing that manufacturers include a Quick Response Code or “QR Code” on the emission label that would direct repair technicians, owners, and inspection and maintenance facilities to a website which provides critical emissions systems information at no cost including: A digital copy of the owner's manual (or just the emissions section of the manual), engine family information, emission control system identification, and fuel and lubricant requirements (see proposed revisions in 40 CFR 1036.135). Many manufacturers already make digital owner's manuals

<sup>537</sup> In 2016, NHTSA issued a **Federal Register** notice (81 FR 16270, March 25, 2016) stating it would post all Technical Service Bulletins and communications to dealers on defects in vehicles, regardless of whether the defects were safety related to comply with the Congressional mandate in the “Moving Ahead for Progress in the 21st Century Act” (MAP-21) enacted on July 6, 2012. More information is available here: <https://www.autosafety.org/how-to-find-technical-service-bulletins-and-other-manufacturer-communications-via-nhtsas-search-portal/>.

<sup>538</sup> See Section IV.B.3.iii for discussion on potential serviceability requirements for BEV and FCEV technologies on which we are seeking comment. Section IV.I also discusses potential maintenance requirements for manufacturers who choose to generate NO<sub>x</sub> emission credits from BEVs or FCEVs.

available online.<sup>539</sup> EPA recognizes that there may be a need to accommodate different information formats relating to the QR code link and requests comment on whether to include different options to achieve the same goals, and if so, what those options should be. The maintenance information we are proposing to add to the owner's manual is critical to making necessary information available promptly to any person performing emissions-related maintenance.

Including the proposed additional information in the owner's manual and emission label can increase an owner's understanding of emission systems operation and fault conditions. Providing owners and repair technicians access to diagrams describing system layout and operation can help reduce confusion where manufacturers may have different system configurations. For example, some configurations may have the DPF in front of the SCR catalyst, while others may have it behind the SCR catalyst.<sup>540</sup> Lack of easily accessible diagrams can lead to mal-maintenance and improper repair where components that need to be replaced are not identified properly. For example, some manufacturers label exhaust gas temperature (EGT) sensors generically such as EGT1 and EGT2 and the positioning of these sensors may differ or be reversed for the same engine model installed on vehicles with slightly different frame configurations.<sup>541</sup> If a technician is unfamiliar with this change, they may replace the wrong EGT which would likely result in a repeat visit to a repair facility. Similarly, a DPF temperature sensor may be generically labeled "Exhaust Temperature Sensor" and may be shown on an EGR parts diagram rather than a DPF parts diagram, making it difficult to correctly identify replacement parts. With an easily accessible parts diagram, owners, parts counter specialists, and repair technicians can more quickly identify the correct parts to replace which would save time and eliminate frustration, especially where a truck is in an inducement. EPA is also seeking comment on the need to require

standardization of terminology for certain components in the proposed labeling and owner's manual provisions to further reduce confusion for owners and technicians performing repairs. For example, some manufacturers call the DOC outlet temperature a DPF inlet temperature. Lack of standardization, including naming conventions and data output parameter scaling (e.g., NO<sub>x</sub> sensor output scaling may vary between manufacturers), may lead to confusion and inefficiencies when seeking replacement parts and performing troubleshooting and repairs. SAE J2403 "Medium-Heavy Duty E/E System Diagnosis Nomenclature" is designed to standardize nomenclature of components and how systems with multiple sensors (e.g., multiple EGT sensors) should be numbered starting from the same place (e.g., starting at the engine). CARB requires that, to the extent possible, certification documentation shall use SAE J1930 or J2403 terms, abbreviations, and acronyms. EPA is seeking comment on whether this standard should be incorporated and required for use in naming certain emission components such as exhaust temperature sensors as a part of certification, maintenance instructions, diagnostic, or other serviceability-related requirements.

EPA seeks comment on other pertinent information that should be included in owner's manuals so that owners can more easily understand advanced emission control system operation and precautions that should be taken in order to maintain them. To the extent EPA can ensure this information is harmonized among manufacturers, we believe this could improve owner, operators, parts counter specialist, and repair technician experiences and reduce frustration which can lead to an incentive to tamper.

### iii. Request for Comments on Maintenance and Operational Information for Improved Serviceability of Electric Vehicles

EPA is requesting comment on several potential serviceability requirements for BEV and FCEV technologies. Many of these potential serviceability provisions are similar to those proposed in Section IV.B.3.ii for CI and SI engines but are specific to these technologies that do not require a combustion engine or emissions aftertreatment system. As noted in the introduction of Section III.A, under 40 CFR 86.016–1(d)(4), heavy-duty BEV and FCEV manufacturers currently use good engineering judgment to apply the criteria pollutant requirements of part

86, Subpart S, including maintenance provisions.

We are requesting comment on seven categories of potential requirements for BEV and FCEV serviceability: (1) Labeling, (2) purchaser guidance, (3) maintenance information, (4) maintenance information requirements concerning the use of a standardized connector and making malfunction codes and powertrain parameters accessible, (5) onboard vehicle signals for service and repair technicians, (6) information on battery energy used per trip, and (7) battery information to facilitate battery recycling. We request comment on whether each of these categories individually or in combination should be finalized to support owners and repair technicians in maintaining and repairing BEV and FCEV technologies, or if alternative provisions suggested by commenters would better support these technologies while minimizing burden to manufacturers. Each of these categories of potential requirements is based on provisions of the 2019 CARB Zero Emissions Powertrain Certification (ZEP Certification), which imposes requirements on manufacturers choosing to generate NO<sub>x</sub> emission credits under the CARB Omnibus rule.<sup>542</sup> We believe that adopting an approach based on the CARB ZEP Certification program would provide manufacturers with consistency across the country. Consistent with the ZEP Certification requirements, EPA believes that the maintenance and operational information described in this section could help potential BEV and FCEV purchasers to understand the possible operational impacts of these technologies on their businesses, as well as ensure the vehicles are supported during their use in the field. Each of the areas in which we are requesting comment is briefly discussed immediately below.

For the first area (labeling), as specified in the current 40 CFR 1037.125, all vehicle manufacturers currently must affix a label to each vehicle with information such as manufacturer name, vehicle certification family, and build date; however, some of the information is specific to vehicles propelled by an engine (e.g., 40 CFR 1037.125(c)(6) requires manufacturers to specify the emission control system).

<sup>542</sup> CARB (2019) "Final Statement of Reasons for Rulemaking, Proposed Alternative Certification Requirements and Test Procedures for Heavy-Duty Electric and Fuel Cell Vehicles and Proposed Standards and Test Procedures for Zero Emission Powertrains." <https://ww2.arb.ca.gov/sites/default/files/barcu/regact/2019/zepcert/fjsor.pdf> (accessed August 5, 2021).

<sup>539</sup> Montoya, Ronald, "How to Find Your Car Owner's Manual Online." October 18th, 2013. Available online at: <https://www.edmunds.com/how-to/how-to-find-your-car-owners-manual-online.html>.

<sup>540</sup> Powerstrokehub.com, "6.7L Power Stroke Emissions Control System." Available here: <http://www.powerstrokehub.com/6.7-power-stroke-emissions.html>.

<sup>541</sup> Earlywine, Brad, "6.7L Power Stroke EGT Replacement." Available here: <https://www.expertswrite.net/article/67l-powerstroke/changing-egt-sensors/>.



We request comment on whether there is additional information specific to BEVs and FCEVs that would be useful to include on the vehicle label for repair technicians, owners, and inspection and maintenance professionals. We also request input from commenters on whether we should require a QR code on BEV and FCEV labels, similar to the proposed QR code requirement in 40 CFR 1036.135(c). Specifically, the BEV or FCEV label could include a QR code to a website which would direct repair technicians, owners, or inspection and maintenance facilities to a website with information including: A digital copy of the owner's manual, vehicle family information, and powertrain identification. Commenters are encouraged to provide details on how any suggestions for additional information would help vehicle owners with the repair and maintenance of BEVs or FCEVs, as well as the potential burden to manufacturers to include such information on the vehicle label.

For the second area (purchaser guidance), we request comment on whether EPA should require BEV and FCEV manufacturers to provide purchaser guidance information to potential owners on aspects of BEV or FCEV ownership that may differ from owning a vehicle with a CI or SI engine. Immediately below, we provide several examples of the types of information that manufacturers could provide in purchaser guidance if we were to finalize such a requirement in this rule or another future rulemaking. For instance, purchaser guidance could include the range the vehicle is capable of driving over a specified duty-cycle, top speed, and maximum grade. As another example, manufacturers could describe how vehicle load, ambient temperatures, and battery degradation impact range, top speed, or maximum grade. Manufacturers could also provide potential purchasers estimates of the time required for maintenance and repairs of common malfunctions, as well as potential vehicle transportation costs. Finally, manufacturers could clearly describe any warranty coverage of the battery and other key powertrain components that would be covered (see Section IV.B.1.iv.b for our proposed warranty requirements).<sup>543</sup> To minimize

<sup>543</sup> As noted in Section IV.B.1.iv.b, the existing 40 CFR 1037.120(e) requires all manufacturers to describe in their owner's manuals the warranty provisions that apply to the vehicle; manufacturers could also provide the same information in purchaser guidance such that it could help inform potential owners prior to their purchase (*i.e.*, prior to having an owner's manual for the vehicle). Per discussion in IV.B.1.iv.b, the proposed warranty requirements differ for manufacturers choosing to generate NO<sub>x</sub> emission credits from BEVs or FCEVs

manufacturer burden, EPA could provide an example statement in 40 CFR part 1037 that manufacturers could choose to use if they attest that the statement is accurate for their vehicle; the example statement could largely mirror the statement that was proposed by CARB under the 2019 CARB ZEP Certification and subsequently adopted into current CARB regulations for GHG emissions from 2014 and later model vehicles.<sup>544</sup> While an example statement provided by EPA would minimize manufacturer burden, it would also, by necessity, be more generic and not reflect parameters specific to a given vehicle model (*e.g.*, range). We encourage commenters to provide input on the potential benefits of manufacturers providing such purchaser guidance relative to the potential burden to manufacturers to provide such guidance.

For the third area (maintenance information), we request comment on whether EPA should require BEV and FCEV manufacturers to make additional maintenance information available to owners and repair technicians. Under the current 40 CFR 1037.125(f) manufacturers make the service manual and any required service tools available to third-party repair facilities at reasonable cost; however, we request comment on any information specific to BEVs or FCEVs that would be important for repair technicians in maintaining and repairing BEV and FCEV technologies. In addition, we request comment on whether EPA should require manufacturers to describe in their certification application the monitoring and diagnostic strategies they use for the BEV or FCEV; these strategies would also be included in their service manuals. In addition to being similar to existing requirements for vehicles powered by an engine, this potential provision would be consistent with the ZEP Certification requirements.<sup>545</sup>

For the fourth area (standardized connector and accessible malfunction codes and powertrain parameters), we request comment on whether EPA

versus manufacturers choosing not to generate NO<sub>x</sub> emission credits from these vehicles.

<sup>544</sup> See Attachment B, "California Greenhouse Gas Exhaust Emission Standards and Test Procedures for 2014 and Subsequent Model Heavy-Duty Vehicles", 3.17 Sales Disclosures, <https://ww2.arb.ca.gov/sites/default/files/classic/regact/2019/zepcert/froattb.pdf> (accessed 8/5/2021).

<sup>545</sup> See Attachment C, "Proposed, California Standards and Test Procedures for New 2021 and Subsequent Model Heavy-Duty Zero-Emissions Powertrains" for details of CARB serviceability provisions available here: <https://ww2.arb.ca.gov/sites/default/files/barcu/regact/2019/zepcert/froattc.pdf>.

should require that BEV and FCEV manufacturers use a standardized connector that is compatible with automotive scan tools, and further that all malfunction codes and key powertrain parameters must be readable by a generic automotive scan tool. Commenters are encouraged to provide information on whether the use of a standardized connector would facilitate repair of BEVs and FCEVs, and the utility of making all malfunction codes and key powertrain parameters readable by a generic scan tool. We also request stakeholder input on the potential burden to manufacturers to make the standardized connector, malfunction codes, and key powertrain parameters accessible.

For the fifth area (onboard vehicle signals), we request comment on whether EPA should require manufacturers to make powertrain monitoring or diagnostic signals publicly accessible to repair and service technicians to facilitate BEV and FCEV maintenance or repair. In Section IV.I we request comment on whether and how manufacturers who choose to generate NO<sub>x</sub> emission credits could make information on battery or fuel cell durability readily accessible; here we request comment on other potential parameters that may be useful for maintaining and repairing BEVs and FCEVs:

- Energy Storage System State of Charge (SOCE)
  - Function: Indicate the remaining energy left in the battery(ies). Would allow users to identify battery degradation or failure that may require maintenance or repair of the battery or powertrain systems.
- Energy Storage System State of Range (SOCR)
  - Function: Indicate the remaining range of the battery(ies). Would allow users to identify battery degradation or failure that may require maintenance or repair of the battery or powertrain systems.
- Drive Motor System Efficiency
  - Function: Compare the energy use of the drive motor from the current state to the as manufactured state to see degradation over time (*e.g.*, 100 percent being as manufactured and decreasing as the performance of the drive motor decreases), or failure. Would allow first owner and secondhand buyers to identify degradation in the electric motor.
- Battery Temperature
  - Function: Identify battery temperature. Would inform repair technicians about when battery

thermal management system may need repair (e.g., identify when battery thermal management system degradation impacts range or charge rate).

- Percent Regenerative Braking
  - Function: Measure the amount of regenerative braking relative to total capacity for capturing energy from regenerative braking. Information could provide insight on when potential maintenance or repair is needed for systems related to regenerative braking, as well as feedback to users on driving behavior that results in greater energy capture from regenerative braking.
- Charging Rate
  - Function: Check performance of the inverter/converter and batteries. Would allow service repair technicians to identify when inverter/converter, batteries or other components may need repair.
- Charging System Performance
  - Function: Identify current charge rate at optimal battery temperature relative to charge rate at the time of manufacture. Would allow service technicians to identify degradation or failure in key components of the charging system.

Commenters are encouraged to provide input on whether each of the listed parameters would be useful, or if there are additional parameters that would be informative. We request that commenters provide any additional specifics of why each signal would be useful for EPA to include in the final rule, or as part of other future rulemakings. We also invite stakeholder input on whether EPA should recommend a common language for BEV and FCEV communication protocols (e.g., J1979–2). Note that we are not requesting comment on whether and how manufacturers would utilize signals or a common communication protocol to monitor or diagnose problems. Commenters are encouraged to provide information on why additional onboard vehicle information would be important for BEV and FCEV repairs, and how EPA suggesting a common communication protocol would, or would not, be useful for the industry.

For the sixth area (battery energy used per trip), we request comment on whether manufacturers already utilize onboard vehicle sensors that could provide estimates of energy consumption per trip, and whether manufacturers could readily provide energy consumption per trip information through a dashboard

display. We further request comment on whether battery energy used per trip would support users understanding normal variance in battery performance due to factors such as terrain, driving behavior, and temperature, versus battery performance degradation that would necessitate maintenance or repair of the powertrain. EPA will consider information provided by commenters to evaluate the potential benefits of users understanding when a battery may need repair relative to the potential burden to manufacturers to make such information available to users.

For the seventh area, we request comment (battery information) on the utility and feasibility of adding a battery information requirement for BEVs and FCEVs. If we were to include a battery information requirement in the final rule, then manufacturers would: (1) Briefly describe in their owner's manual how to handle the battery after it is no longer capable of providing sufficient energy or power to the vehicle (e.g., identify alternative uses and safe disposal methods for the battery), and (2) affix a label on the battery, and include in the owner's manual, information necessary to recycle the battery (e.g., manufacturer, chemistry, voltage, hazard statement, QR code to a website for additional details). We believe such battery information would be important for users to appropriately re-purpose, recycle, or otherwise dispose of the battery, and thereby minimize total environmental impact of the BEV or FCEV. Commenters are encouraged to provide information on whether such battery information would facilitate users identifying alternative uses for the battery or otherwise recycling the battery. We are also interested in information on the feasibility of vehicle manufacturers having sufficient information from battery suppliers to provide information on battery handling at the end of its life in a vehicle. EPA will consider information provided in comments and weigh the potential environmental benefits of users having battery information with the potential burden to manufacturers to provide such information.

#### iv. Other Emission Controls Education Options

In addition to our proposals to provide more easily accessible service information for users, we are seeking comment on whether educational programs and voluntary incentives could lead to better maintenance and real-world emission benefits. We received comments in response to the ANPR supportive of improving such

educational opportunities to promote an understanding of how advanced emission control technologies function and the importance of emissions controls as they relate to the broader economy and the environment. Some commenters were generally supportive of using educational programs and incentives to improve maintenance practices. Commenters generally agreed that there are actions EPA could take to reduce the misinformation surrounding advanced emission control systems and that any action that EPA could take to improve access to easily-understandable maintenance information would be helpful.<sup>546</sup> NADA commented that they would “welcome new emission control outreach and incentives to combat misperceptions that can lead to emissions tampering or mal-maintenance.”<sup>547</sup> The Motor and Equipment Manufacturers Association (MEMA) commented that priority should be given to improving education and training offered to service facilities and technicians to reduce the misdiagnoses of faulty emission components where “it is a common diagnostic technique in service repair shops to continually swap out emissions components until the problem goes away.”<sup>548</sup> Lubrizol suggested that EPA provide education to ensure fleets understand the proper lubricants required to maintain engines.<sup>549</sup>

We seek comment on the potential benefits of educational and/or voluntary, incentive-based programs such as EPA's SmartWay program and how such a program could be designed and implemented.<sup>550</sup>

#### 4. Rebuilding

Clean Air Act section 203(a)(3) prohibits removing or rendering inoperative a certified engine's emission controls which typically includes being paired with properly functioning aftertreatment devices. The regulation at 40 CFR 1068.120 describes how this tampering prohibition applies for engine rebuilding and other types of engine maintenance. The regulation generally

<sup>546</sup> See the comments of the Oregon Department of Environmental Quality, Docket ID EPA–HQ–OAR–2019–0055–0464; Georgia Department of Natural Resources, Docket ID EPA–HQ–OAR–2019–0055–0267; and the anonymous comments in Docket ID EPA–HQ–OAR–2019–0055–0306.

<sup>547</sup> See the comments of the National Automobile Dealers Association, Docket ID EPA–HQ–OAR–2019–0055–0369.

<sup>548</sup> See the comments of the Motor & Equipment Manufacturers Association, Docket ID EPA–HQ–OAR–2019–0055–0462.

<sup>549</sup> See the comments of Lubrizol, Docket ID EPA–HQ–OAR–2019–0055–0454.

<sup>550</sup> Learn about SmartWay. Available online at: <https://www.epa.gov/smartway/learn-about-smartway>. Accessed October 3, 2019.

requires that rebuilders return a certified engine to its original configuration and keep records to document that the rebuilder had a reasonable technical basis for believing that the rebuilt engine's emission control system performs at least as well as the original design.

Since the rebuilding provisions in 40 CFR 1068.120 broadly apply to everyone involved in restoring a rebuilt engine to its certified configuration, to the extent that vehicle owners or others remove an engine from and install a rebuilt engine in a heavy-duty highway vehicle, we consider those steps to be part of the rebuilding process.

We are not proposing new or modified rebuilding provisions in this rule. However, we intend to continue to monitor rebuilding practices and may develop updated regulatory provisions in a future rulemaking.

#### 5. Maintenance

Consistent with the CAA and existing regulations, our proposed standards would apply over the applicable useful life. Manufacturers perform testing to demonstrate that engines will meet emission standards over the full useful life. Manufacturers may perform scheduled maintenance on their test engines only as specified in the owner's manual. As part of the certification process, manufacturers must get EPA approval for such scheduled maintenance, which is also subject to minimum maintenance intervals as described in the regulations. In this section, we describe the updated maintenance provisions we are proposing for heavy-duty highway engines. Section IV.F of this preamble summarizes the current the durability demonstration requirements and our proposed updates.

Our proposed maintenance provisions, in a new section 40 CFR 1036.125, combine and amend the existing criteria pollutant maintenance provisions from 40 CFR 86.004–25 and 86.010–38. Similar to other part 1036 sections we are adding in this proposal, the structure of the new 40 CFR 1036.125 is consistent with the maintenance sections in the standard-setting parts of other sectors (*e.g.*, nonroad compression-ignition engines in 40 CFR 1039.125).<sup>551</sup> In 40 CFR 1036.205(i), we are proposing to codify the current manufacturer practice of including maintenance instructions in

their application for certification such that approval of those instructions would be part of a manufacturer's certification process.<sup>552</sup> We are also proposing a new paragraph 40 CFR 1036.125(h) outlining several owner's manual requirements, including migrated and updated provisions from 40 CFR 86.010–38(a). For example, proposed 40 CFR 1036.125(h)(2) expands on the current requirement for manufacturers to describe the documentation owners need to provide to show maintenance occurred, by specifying that maintenance instructions must clearly state how to “properly maintain and use” the engine. The new paragraph (h)(2) provides a clearer connection to the regulatory requirements for warranty and defect reporting.

This section summarizes maintenance updates recently adopted by CARB and introduces our proposed provisions to clarify the types of maintenance, update the options for demonstrating critical emission-related maintenance will occur and the minimum scheduled maintenance intervals for certain components, and outline specific requirements for maintenance instructions.

#### i. Recent Updates to CARB Maintenance Regulations

In two recent rulemakings, CARB updated their maintenance regulations and we considered CARB's approach when designing our maintenance provisions for this proposal. In its Step 1 warranty program, CARB lengthened the minimum allowable maintenance intervals for heavy-duty diesel engines to reflect current industry norms for scheduling replacement of emissions-related parts.<sup>553</sup> CARB stated that this change limits manufacturers' ability to transfer the liability for part replacements to vehicle owners for emissions-related parts during the lengthened warranty periods, further strengthening warranty coverage.

CARB staff surveyed owner's manuals for all 2016 California-certified on-road heavy-duty diesel engines and compiled the intervals manufacturers published for specific emission-related components. The maintenance intervals published in the owner's manuals were at or above the minimum intervals that currently apply for emission-related components. For MY 2022 and later HD

diesel engines, CARB updated their minimum scheduled maintenance intervals to match the shortest (*i.e.*, most frequent) interval from those published values for each component. If no manufacturer published an interval for a given component, CARB set the minimum maintenance interval for that component to match the current useful life mileage (*i.e.*, 435,000 miles for HHDD engines). CARB's Step 1 program also provides that manufacturers cannot schedule replacements for turbochargers, DPF elements, catalyst beds, or exhaust gas recirculation systems during the useful life of the engine unless the manufacturer agrees to pay for the replacements. These four emission-related components were chosen due to their direct emissions impact or high cost to replace. Furthermore, CARB clarified that there shall be no scheduled maintenance interval throughout the applicable useful life for sensors or actuators that are integrated with the turbocharger or exhaust gas recirculation (EGR) valve/cooler components, as these parts cannot easily be replaced without removing the larger systems from the engine. Other sensors and actuators that are necessary for the proper function of other emissions-critical systems or are not integrated with the turbocharger or EGR systems can be included on a maintenance schedule at a minimum interval of 150,000 miles.

CARB's HD Omnibus rulemaking did not include further updates to the maintenance provisions for diesel engines but addressed HD Otto-cycle engines and hybrid vehicles.<sup>554</sup> Similar to their strategy to identify maintenance intervals for diesel engines, CARB surveyed owner's manuals for 2018 California-certified HD Otto-cycle engines and updated the minimum maintenance intervals for MY 2024 and later HD Otto-cycle engines based on the shortest intervals published. For gasoline vehicles, EGR systems and catalyst beds were designated “not replaceable” components. CARB further clarified that the same minimum intervals apply to diesel- and Otto-cycle engines used in hybrid vehicles.

#### ii. Types of Maintenance

Our proposed new 40 CFR 1036.125 clarifies that maintenance includes any inspection, adjustment, cleaning, repair, or replacement of components and, consistent with 40 CFR 86.004–25(a)(2), broadly classifies maintenance as

<sup>552</sup> See the current submission of maintenance instructions provisions in 40 CFR 86.079–39.

<sup>553</sup> California Air Resources Board. HD Warranty 2018 Staff Report: Initial Statement of Reasons. May 8, 2018. p III–9. Available online: <https://ww2.arb.ca.gov/rulemaking/2018/hd-warranty-2018>.

<sup>554</sup> California Air Resources Board. Staff Report: Initial Statement of Reasons-Public Hearing to Consider the Proposed Heavy-Duty Engine and Vehicle Omnibus Regulation and Associated Amendments. June 23, 2020. Page III–49.

<sup>551</sup> Stout, Alan; Brakora, Jessica. Memorandum to docket EPA–HQ–OAR–2019–0055. “Technical Issues Related to Migrating Heavy-Duty Highway Engine Certification Requirements from 40 CFR part 86, subpart A, to 40 CFR part 1036”. October 1, 2021.

emission-related or non-emission-related and scheduled or unscheduled. We propose to define the following five types of maintenance that manufacturers may choose to schedule:

- Critical emission-related maintenance
- Recommended additional maintenance
- Special maintenance
- Noncritical emission-related maintenance
- Non-emission-related maintenance

We are proposing to define these maintenance categories to distinguish between the types of maintenance manufacturers may choose to recommend to owners in maintenance instructions, identify the requirements that apply to maintenance performed during certification durability demonstrations, and clarify the relationship between the different types of maintenance, emissions warranty requirements, and in-use testing requirements. The proposed provisions described in this section specify the conditions for scheduling each of these five maintenance categories. Unscheduled maintenance (i.e., repair of failed components) is unpredictable and would not be included in a manufacturer's durability instructions or durability demonstration.<sup>555</sup>

A primary focus of the current and proposed maintenance provisions is critical emission-related maintenance. Critical emission-related maintenance includes any adjustment, cleaning, repair, or replacement of emission-related components that manufacturers identify as having a critical role in the emission control of their engines.<sup>556</sup> Consistent with the current 40 CFR 86.004–25(b)(6)(ii), our proposed 40 CFR 1036.125(a)(1) allows manufacturers to schedule critical emission-related maintenance in their maintenance instructions based on the manufacturer meeting two conditions: The manufacturer demonstrates the maintenance is reasonably likely to occur on in-use engines, and the recommended intervals are at least as long as the minimum intervals set by

<sup>555</sup> The current provisions of 40 CFR part 1068 describe a manufacturer's requirements relating to failed emission-related components with respect to emission-related warranty (40 CFR 1068.110(e)) and defect and recall (1068, subpart F). We are proposing to note in a new paragraph 40 CFR 1036.125(h)(2) that manufacturers may identify failure to repair critical emission-related components as improper maintenance if the repairs are related to an observed defect.

<sup>556</sup> See Section IV.B.5.iv for our proposed definition of critical emission-related components and a list of common critical emission-related components for which we are proposing to specify minimum scheduled maintenance intervals.

EPA. We describe our proposed conditions for demonstrating critical emission-related maintenance will occur in Section IV.B.5.iii. In Section IV.B.5.iv, we describe our proposal to update the minimum maintenance intervals currently specified in 40 CFR 86.004–25(b)(3) and (4) for certain critical emission-related components. For new technology, not included in the list of proposed components with specified minimum maintenance intervals, we are proposing to migrate and update the process specified in 40 CFR 86.094–25(b)(7), as described in Section IV.B.5.v.

The four other types of maintenance would require varying levels of EPA approval. In 40 CFR 1036.125(b), we propose to define recommended additional maintenance as maintenance that manufacturers recommend owners perform for critical emission-related components in addition to what is approved for those components under 40 CFR 1036.125(a). A manufacturer may recommend that owners replace a critical emission-related component at a shorter interval than the manufacturer received approval to schedule for critical emission-related maintenance; however, the manufacturer would have to clearly distinguish their recommended intervals from the critical emission-related scheduled maintenance in their maintenance instructions. As described below, recommended additional maintenance is not performed in the durability demonstration and cannot be used to deny a warranty claim, so manufacturers would not be limited by the minimum maintenance intervals or need the same approval from EPA by demonstrating the maintenance would occur. Special maintenance, proposed in 40 CFR 1036.125(c), would be more frequent maintenance approved at shorter intervals to address special situations, such as atypical engine operation. Manufacturers would clearly state that the maintenance is associated with a special situation in the maintenance instructions provided to EPA and owners. Our proposed definition of noncritical emission-related maintenance, which is based on 40 CFR 86.010–38(d), includes inspections and maintenance that is performed on emission-related components but is considered “noncritical” because emission control will be unaffected. As specified in proposed 40 CFR 1036.125(d), manufacturers may recommend noncritical emission-related inspections and maintenance in their maintenance instructions if they clearly state that it

is not required to maintain the emissions warranty. Finally, we define “non-emission-related maintenance” as maintenance unrelated to emission controls (e.g., oil changes) in proposed 40 CFR 1036.125(e). We propose that manufacturers' maintenance instructions can include any amount of nonemission-related maintenance that is needed for proper functioning of the engine.

Maintenance instructions play an important role in the service accumulation portion of a manufacturer's durability demonstration. We currently require that all emission-related scheduled maintenance during durability testing occur on the same schedule as specified in the maintenance instructions for the purchaser.<sup>557</sup> When accumulating equivalent miles on an engine, manufacturers are currently allowed to perform maintenance according to their maintenance instructions. In this proposal, we clarify how this relates to the specific types of maintenance in proposed 40 CFR 1036.125. Consistent with current maintenance provisions, we propose that manufacturers can perform critical emission-related maintenance at their approved schedules during a durability demonstration. Since the proposed recommended additional maintenance provisions do not include the same requirement to demonstrate the maintenance will occur in-use, manufacturers could not perform recommended additional maintenance during their durability demonstration. Special maintenance would also not be performed during a durability demonstration, since laboratory-based testing does not reflect atypical operation. We propose that manufacturers may perform noncritical emission-related inspections on their engines during their durability demonstration at any frequency, but could only adjust, clean, repair, or replace a component in response to an inspection if scheduled maintenance is approved for that component. We propose manufacturers can perform any amount of nonemission-related maintenance that is needed for proper functioning of the engine during durability testing.

The current general warranty requirements of 40 CFR 1068.115(a) allow a manufacturer to deny warranty claims for failures resulting from improper maintenance or use. We are proposing a new owner's manual requirement for manufacturers to specifically identify the steps an owner

<sup>557</sup> See 40 CFR 86.094–25(b).

must take to properly maintain the engine, including documentation a manufacturer may require for an owner to demonstrate the maintenance occurred. In 40 CFR 1036.125, we propose to clarify the relationship between the different types of maintenance and emissions warranty requirements, and specify when manufacturers must note in their maintenance instructions (i.e., owner's manual) if a maintenance type cannot be used as the basis to deny a warranty claim. We expect manufacturers would only schedule critical emission-related maintenance and make the effort to demonstrate the maintenance is likely to occur in-use for components that they recognize are strongly connected to emission performance. As a result, our current maintenance provisions allow, and our proposed provisions would continue to allow, manufacturers to deny warranty claims if owners do not perform critical emission-related maintenance at the recommended schedule, as specified in 40 CFR 1068.115. Failure to perform recommended additional maintenance could potentially impact emissions, but manufacturers would not be able to deny a warranty claim if owners do not perform it, because manufacturers would not have taken the extra steps to have it approved as critical. Manufacturers would be able to deny warranty claims if an owner did not perform the special maintenance after it was determined that the engine was operated in conditions that meet the special situation described in the maintenance instructions. In contrast, manufacturers would not be able to deny a warranty claim citing "improper maintenance or use" for atypical operation if an owner follows the corresponding special maintenance instructions. We propose that failure to perform noncritical emission-related maintenance and nonemission-related maintenance cannot be used to deny emissions warranties.

Since failure to perform maintenance may also impact emissions when the engine is in use, we have also identified the relationship between the maintenance types and in-use testing. Compression-ignition engine manufacturers are subject to off-cycle standards for in-use engines. As part of the proposed manufacturer-run testing program in subpart E, we specify that manufacturers can select vehicles and engines for testing based on proper maintenance and use (see 40 CFR 1036.410(b)(2)). In 40 CFR 1036.125, we propose that if recommended additional maintenance or noncritical emission-

related maintenance is not performed on an engine, it does not disqualify the engine from in-use testing. Manufacturers may reject an engine for in-use testing if the other types of maintenance (i.e., critical emission-related maintenance, special maintenance, or nonemission-related maintenance) were not performed, consistent with current provisions in 40 CFR 86.1908.

#### iii. Critical Emission-related Maintenance Demonstration

One of the current conditions for allowing scheduled maintenance to be performed during the durability demonstration is that manufacturers demonstrate the maintenance is reasonably likely to be performed in-use.<sup>558</sup> For critical emission-related scheduled maintenance, we are generally including these same requirements in our proposed new paragraph 40 CFR 1036.125(a)(1), with clarifications noted below.

Under proposed 40 CFR 1036.125(a)(1)(i), manufacturers could demonstrate that the critical maintenance is reasonably likely to occur in-use on the recommended schedule by providing data showing that the engine's performance unacceptably degrades if the maintenance is not performed, consistent with 40 CFR 86.004–25(a)(6)(ii)(A). In this proposal, we clarify that this paragraph is intended to cover emission control technologies that have an inherent performance degradation that coincides with emission increases, such as back pressure resulting from a clogged DPf, and is not intended to apply to inducements where a manufacturer-specified performance derate is triggered in response to a detected or predicted emission increase. We are proposing a separate statement in 40 CFR 1036.125(a)(1) that points to the new proposed inducement provisions noting that we would accept DEF replenishment as reasonably likely to occur if an engine meets the specifications in proposed 40 CFR 1036.111.

Under proposed 40 CFR 1036.125(a)(1)(ii) and consistent with 40 CFR 86.004–25(a)(6)(ii)(C), manufacturers could demonstrate a reasonable likelihood that the critical maintenance will be performed in-use by including a system that displays a visible signal to alert drivers that maintenance is due. We are proposing additional criteria for use of this visible signal, including that it be continuously displayed while the

engine is operating and not easily eliminated without performing the specified maintenance. We request comment on this proposal and any additional criteria we should consider before approving a visible signal as a method to ensure critical emission-related scheduled maintenance is performed.

Under proposed 40 CFR 1036.125(a)(1)(iii), manufacturers could present survey data showing that 80 percent of engines in the field receive the specified maintenance. We are maintaining this existing option (see paragraphs (B) and (D) of 40 CFR 86.004–25(a)(6)(ii)) in our proposal but note that manufacturers have not presented survey data related to scheduled maintenance in recent years. We request comment on this option and any updates we should consider, including how telematic data could be applied and if 80 percent continues to be an appropriate threshold.

We are also proposing in 40 CFR 1036.125(a)(1)(iv) to continue an existing provision in 40 CFR 86.004–25(a)(6)(ii)(E) that a manufacturer may rely on a clear statement in their maintenance instructions for owners that it will provide the critical maintenance free of charge. Finally, we propose to continue to allow manufacturers to present other options for approval by EPA to demonstrate that critical emission-related maintenance is reasonably likely to occur (see proposed 40 CFR 1036.125(a)(1)(v) and current 40 CFR 86.004–25(a)(6)(ii)(F)).

#### iv. Emission-Related Components and Minimum Maintenance Intervals

Manufacturers, with EPA approval, may define scheduled maintenance for emission-related components, which would be included in maintenance instructions directing owners to adjust, clean, or replace components at specified intervals. The current regulations in 40 CFR 86.004–25(b) specify minimum maintenance intervals for emission-related components, such that manufacturers may not specify more frequent maintenance than we allow. We propose to migrate and update the minimum maintenance intervals from part 86, subpart A to 40 CFR 1036.125(a). These proposed minimum intervals would apply for the scheduled adjustment, cleaning, or replacement of many common critical emission-related components, as described in this section. We are proposing not to migrate the list of critical emission-related components currently specified in 40 CFR 86.004–25, and instead are proposing a new definition of "critical emission-related

<sup>558</sup> See 40 CFR 86.004–25 and 86.094–25.

component” in 40 CFR 1068.30 that refers to 40 CFR part 1068, appendix A.

As part of the migration to part 1036, we are proposing to update the lists of components with minimum maintenance intervals to more accurately reflect components in use today. We are not including carburetors, idle mixture, and particulate trap oxidizers in the proposed 40 CFR 1036.125 as these components are obsolete. Our proposed language replaces the part 86 diesel particulate trap intervals with a more general “particulate filtration system” that can apply to particulate filters intended for SI or CI engines. We also no longer specify an interval for electronic engine control units as we are unaware of any scheduled maintenance for those components. Our proposed minimum maintenance intervals for each emission-related component or system continue to apply to any associated sensors or actuators. We are further proposing that these intervals also apply to any hoses, valves, and wiring connected to the component or system, such that manufacturers would ensure that all parts necessary to keep the component functional, including wires and wiring harnesses, remain durable throughout useful life or schedule appropriate maintenance to address any durability concerns.

We propose not to migrate the 100,000-mile minimum interval for Spark-ignition HDE evaporative emission canister to 40 CFR 1036.125, since evaporative emission control systems are covered under the vehicle provisions of part 1037. Similarly, we propose that components in the refueling emission control system that would be used to meet the proposed refueling standards for certain SI HDE, including the carbon canisters, filler

pipes and seals, refueling flow controls, purge systems, and related wiring, actuators, and sensors, would also be covered under the maintenance provisions of part 1037.

We are proposing to add minimum scheduled replacement intervals for other components and systems that correspond to technologies we expect to be considered by manufacturers for meeting our proposed standards. In general, the proposed minimum replacement intervals are set at the current useful life for each engine class, since we do not have data indicating that manufacturers are scheduling maintenance for these components within the current useful life. We are proposing NO<sub>x</sub> sensor minimum intervals at the current useful life mileages for the Light, Medium, and Heavy HDE classes. We also propose to add minimum intervals for replacing a rechargeable energy storage system (RESS) in hybrid vehicles. Our proposed minimum intervals for RESS equal the current useful life for the primary intended service classes of the engines that these electric power systems are intended to supplement or replace. We are not specifying distinct minimum intervals for the electric power system components of BEVs and FCEVs; instead, manufacturers could request approval for an interval using 40 CFR 1037.125(a).

Considering our proposed lengthened useful life periods, we reevaluated the current minimum maintenance intervals for replacing components and are proposing to extend the replacement intervals such that they reflect the scheduled maintenance of components today. Table IV–11 summarizes the minimum replacement interval mileages we are proposing in a new table in 40 CFR 1036.125(a). Similar to the

minimum maintenance interval approach adopted by CARB in their recent rulemakings (see Section IV.B.5.i), we are proposing to base our revised minimum replacement intervals on the scheduled maintenance submitted by engine manufacturers for certifying recent model year engines.<sup>559</sup> We believe it is appropriate to account for replacement intervals that manufacturers have already identified and demonstrated will occur for these components and we are proposing replacement intervals for these components that align with the shortest mileage interval (*i.e.*, most frequent maintenance) of the published values. We propose to update the minimum replacement mileages for remaining components that currently do not have specified maintenance intervals in the current list from the current 100,000 or 150,000 miles to the current useful life mileage for each primary intended service class. Since manufacturers are not scheduling replacement of these other components within the current useful life of their engines today, we do not expect manufacturers would have a technical need to do so in the future. We are not proposing to update the maintenance intervals for adjusting or cleaning critical emission-related components. These intervals are proposed to be migrated, with updated component names consistent with the proposed replacement intervals, from 40 CFR 86.004–25 into a proposed new table in 40 CFR 1036.125(a). Consistent with current regulations, our proposed 40 CFR 1036.125(a) would continue to allow manufacturers to seek advance approval for new emission-related maintenance they wish to include in maintenance instructions and perform during durability demonstration.

TABLE IV–11—PROPOSED MINIMUM SCHEDULED MAINTENANCE INTERVALS FOR REPLACING CRITICAL EMISSION-RELATED COMPONENTS IN 40 CR 1036.125

Component	Accumulated miles (hours) for components			
	Spark-ignition HDE	Light HDE	Medium HDE	Heavy HDE
Spark plugs .....	25,000 (750)	NA	NA	NA
DEF filters .....	NA	100,000 (3,000)	120,000 (3,600)	175,000 (5,250)
Crankcase ventilation valves and filters .....	60,000 (1,800)	60,000 (1,800)	60,000 (1,800)	60,000 (1,800)
Oxygen sensors .....	80,000 (2,400)	NA	NA	NA
Ignition wires .....	100,000 (3,000)	NA	NA	NA
Air injection system components .....	110,000 (3,300)	NA	NA	NA
Particulate filtration system (other than filter elements) .....	100,000 (3,000)	100,000 (3,000)	250,000 (7,500)	250,000 (7,500)
Catalyst systems (other than catalyst beds); Fuel injectors; Electronic control modules; Evaporative emission canisters; Turbochargers; EGR system components (including filters and coolers) .....	110,000 (3,300)	110,000 (3,300)	185,000 (5,550)	435,000 (13,050)

<sup>559</sup> Brakora, Jessica. Memorandum to docket EPA–HQ–OAR–2019–055. “Approved Scheduled

Maintenance Intervals for MY 2019 Certified Heavy-Duty Engines”, April 27, 2021.

TABLE IV–12—PROPOSED MINIMUM SCHEDULED MAINTENANCE INTERVALS FOR ADJUSTING AND CLEANING CRITICAL EMISSION-RELATED COMPONENTS IN 40 CR 1036.125

Components and systems <sup>a</sup>	Accumulated miles (hours) for components			
	Spark-ignition HDE	Light HDE	Medium HDE	Heavy HDE
Spark plugs .....	25,000 (750)	NA	NA	NA
EGR-related filters and coolers; Fuel injectors; Crankcase ventilation valves and filters .....	50,000 (1,500)	50,000 (1,500)	50,000 (1,500)	50,000 (1,500)
DEF filters .....	NA	50,000 (1,500)	50,000 (1,500)	50,000 (1,500)
Ignition wire; Idle mixture .....	50,000 (1,500)	NA	NA	NA
Oxygen sensors .....	80,000 (2,400)	NA	NA	NA
Air injection system components .....	100,000 (3,000)	NA	NA	NA
Catalyst system components; EGR system components (other than filters or coolers); Particulate filtration system components; Turbochargers .....	100,000 (3,000)	100,000 (3,000)	150,000 (4,500)	150,000 (4,500)

The minimum maintenance intervals presented in Table IV–11 and Table IV–12 are based on mileage, since equivalent mileage accumulation is the parameter used for the durability demonstration. Consistent with our current maintenance provisions, we are proposing corresponding minimum hours values based on a 33 miles per hour vehicle speed (e.g., 150,000 miles would equate to 4,500 hours). We request comment on the conversion factor between mileage and hours, noting that hours would not apply to the manufacturers’ durability demonstrations, but may impact the frequency of scheduled maintenance for owners with lower speed vehicle applications.<sup>560</sup> Consistent with the current maintenance intervals specified in part 86, we are not proposing year-based minimum intervals; OEMs can use good engineering judgment if they choose to include a scheduled maintenance interval based on years in their owner’s manuals, which is expected to only be used by a small number of infrequently operated vehicles. We request comment on the need to specify a minimum year-based interval, including data on average annual mileages to convert the minimum mileage intervals to years for each of the primary intended service classes.

We request comment on all components and systems presented in Table IV–11 and Table IV–12 and the corresponding minimum scheduled maintenance intervals. Specifically, we request data to support different interval values or specific components that should have intervals distinct from presented systems. We request comment on our proposal to update the list of

components and systems, whether additional components should be considered, and if any of the listed components or systems should be more clearly defined. Additionally, if a commenter believes there is value in prioritizing or otherwise grouping emission control components, we encourage them to suggest criteria to classify the components. We request comment on the numeric values of the replacement intervals proposed, and our proposal to preserve the current minimum intervals for adjusting and cleaning components. Manufacturers and suppliers have shown an interest in developing modular emission controls that can be serviced more easily. We request comment on the specific emission control systems that may use modular components, criteria for defining “modular”, and adjustments to the proposed minimum maintenance intervals or replacement restrictions we should consider to account for improved serviceability of modular components.

v. Critical Emission-Related Maintenance for New Technology

Current provisions of 40 CFR 86.094–25(b)(7) outline a process for manufacturers to seek approval for new scheduled maintenance that includes an EPA announcement of the maintenance interval in the **Federal Register**. Regarding new scheduled maintenance on existing technology, we are proposing not to migrate the provision in 40 CFR 86.094–25(b)(7)(i) for maintenance practices that existed before 1980. Instead, the maintenance demonstration and minimum maintenance interval provisions we are proposing in the new 40 CFR 1036.125(a) would cover the current process for new maintenance on critical emission-related components currently in use.

Regarding scheduled maintenance on new technology, the provision currently in 40 CFR 86.094–25(b)(7)(ii) provides a process for approval of new critical emission-related maintenance associated with new technology. We recognize that new emission control technology may be developed in the future and it is important to retain a public process for approving maintenance associated with new technology. We are proposing to migrate and update 40 CFR 86.094–25(b)(7)(ii) into a new 40 CFR 1036.125(a)(3) for scheduled critical emission-related maintenance associated with new technology. We are proposing to use model year 2020 as the reference point for considering whether technology is new. Manufacturers using new technology would request a recommended maintenance interval, including data to support the need for the maintenance, and demonstrate that the maintenance is likely to occur at the recommended interval using one of the conditions proposed in 40 CFR 1036.125(a)(1). We are also proposing to continue our responsibility to communicate such a decision on maintenance for new technology. As such, we propose to retain EPA’s obligation to publish a **Federal Register** notice based on information manufacturers submit and any other available information to announce that we have established new allowable minimum maintenance intervals.

Manufacturers would also continue to have the option currently specified in 40 CFR 86.094–25(b)(7)(iii) to ask for a hearing if they object to our decision. Hearing procedures are specified in 40 CFR 1036.820 and 40 CFR part 1068, subpart G, including proposed new provisions in 40 CFR part 1068. We request comment on our proposed maintenance provisions for new technology, including our proposal to

<sup>560</sup> We are proposing a 20 miles per hour average vehicle speed to distinguish low speed vehicles in our emissions warranty proposal (see Section IV.B.1) and in our inducement proposal (see Section IV.D).

use model year 2020 to distinguish “new” technology.

vi. Payment for Scheduled Maintenance

The minimum maintenance intervals specified in Table IV–11 would apply for replacement of the listed components and systems. While we are proposing replacement intervals for other components in the catalyst and particulate filtration systems, current maintenance provisions in 40 CFR 86.004–25(b)(4)(iii) state that only adjustment and cleaning are allowed for catalyst beds and particulate filter elements and that replacement is not allowed during the useful life. Current 40 CFR 86.004 25(i) clarifies that these components could be replaced or repaired if manufacturers demonstrate the maintenance will occur and the manufacturer pays for it. We propose to continue to restrict replacement of catalyst beds and particulate filter elements, requiring that manufacturers pay for the repair or replacement of catalyst beds and particulate filter elements, if needed, within the regulatory useful life.

We are proposing to identify these and other components with limited replacement using four criteria based on current provisions that apply for nonroad compression-ignition engines.<sup>561</sup> Our proposed 40 CFR 1036.125(g) states that manufacturers would pay for scheduled maintenance, including parts and labor, if all the following criteria are met:

- Each affected component was not in general use on similar engines before 1980,
- The primary function of each affected component is to reduce emissions,
- The cost of the scheduled maintenance is more than 2 percent of the price of the engine, and
- Failure to perform the maintenance would not significantly degrade the engine’s performance.

Scheduled maintenance for the replacement of catalyst beds and particulate filter elements meets the four criteria of 40 CFR 1036.125(g). We estimate that EGR valves, EGR coolers, and RESS also meet the 40 CFR 1036.125(g) criteria and, under this proposal, manufacturers would only be able to schedule replacement of these three components if the manufacturer pays for it. In the HD Omnibus rulemaking, CARB included turbochargers in their list of components “not replaceable” during the regulatory useful life. Under the proposed criteria specified in 40 CFR

1036.125(g), scheduled turbocharger maintenance would not meet all four criteria of the 40 CFR 1036.125(g), since a turbocharger’s primary function is not to reduce emissions and an underperforming or failed turbocharger would degrade engine performance. We request comment on including turbochargers as components that should have limited replacement irrespective of the four 40 CFR 1036.125(g) criteria. We also request comment on other components that meet the criteria, or other criteria EPA should consider when determining which components should have limited replacement during the scheduled maintenance approval process.

vii. Source of Parts and Repairs

CAA section 207(c)(3) prohibits manufacturers from requiring maintenance work be completed only by OEM-authorized dealers. We are proposing a new paragraph 40 CFR 1036.125(f) to clarify that manufacturers cannot limit the source of parts and repairs for maintenance.<sup>562</sup> This paragraph would require manufacturers to clearly state in their maintenance instructions that owners can choose any repair shop or person to perform maintenance. Furthermore, the manufacturers cannot specify a particular brand, trade, or corporate name for components or service and cannot deny a warranty claim due to “improper maintenance” based on owners choosing not to use a franchised dealer or service facility or a specific brand of part. The existing and proposed provisions allow manufacturers to specify a particular service facility and brand of parts only if they are providing the service or component to the owner without charge or if the manufacturer convinces EPA during the approval process that the engine will only work properly with the identified service or component.

viii. Maintenance Instructions

Our proposed 40 CFR 1036.125 preserves the requirement that the manufacturer provide written instructions for properly maintaining and using the engine and emission control system. We are proposing a new 40 CFR 1036.125(h) to describe the information that would be required in an owner’s manual. The proposed 40 CFR 1036.125(h) generally migrates the existing maintenance instruction provisions specified in 40 CFR 86.010–38(a) through (i) with updates as

described in Sections IV.B.3 and IV.C of this preamble. As noted in Section IV.B.3, our serviceability proposal supplements the current service information provisions currently specified in 40 CFR 86.010–38(j). We are not proposing to migrate the service information provisions into part 1036; rather, we would preserve their current location in 40 CFR 86.010–38(j), with updated references to any sections migrated to the new part 1036.

While 40 CFR 1036.120(d) allows manufacturers to deny warranty claims for improper maintenance and use, owners have expressed concern that it is unclear what recordkeeping is needed to document proper maintenance and use. Consistent with the current 40 CFR 86.010–38(a)(2), we propose that manufacturers describe in the owner’s manual the documentation they consider appropriate to demonstrate the engine and emission control system are properly maintained (see 40 CFR 1036.125(h)(2)). Manufacturers should be able to identify specific examples of maintenance practices they would consider improper, and to identify their expectations for documenting routine maintenance and repairs related to warranty claims. If a manufacturer requires a maintenance log as part of their process for reviewing warranty claims, we expect the owner’s manual would provide an example log that includes the required maintenance tasks and intervals and clearly states that warranty claims require an up-to-date maintenance record. We would be able to review the manufacturers information describing the parameters and documentation for demonstrating proper maintenance before granting certification for an engine family.

ix. Performing Scheduled Maintenance on Test Engines

Current provisions defining the limits on maintenance that can be performed during testing are specified in 40 CFR 86.004–25(e) and (f). We are not migrating those provisions into part 1036; instead, we are proposing that the general provisions currently in 40 CFR 1065, subpart E, would apply for criteria pollutant standards for model year 2027 and later engines.<sup>563</sup>

We are proposing to update 40 CFR 1065.410(c) to clarify that inspections performed during testing include electronic monitoring of engine parameters, such as prognostic systems. Manufacturers that include prognostic

<sup>562</sup> This provision has been adopted in the standard-setting parts of several other sectors, including heavy-duty vehicles (see 1037.125(f)).

<sup>563</sup> We believe the idle speed adjustments, currently 40 CFR 86.004–25(e)(1), are obsolete, since idle is usually set by the ECM and it would not need to be adjusted prior to testing.

<sup>561</sup> See 40 CFR 1039.125(g).



systems as part of their engine packages to identify or predict malfunctioning components may use those systems during durability testing and would include any maintenance performed as a result of those systems, consistent with 40 CFR 1065.410(d), in their application for certification. We note that, in order to apply these electronic monitoring systems in testing, the inspection tool (e.g., prognostic system) must be available to all customers or accessible at dealerships and other service outlets.

### C. Onboard Diagnostics

As used here, the terms “onboard diagnostics” and “OBD” refer to systems of electronic controllers and sensors required by regulation to detect malfunctions of engines and emission controls. EPA’s existing OBD regulations for heavy-duty engines are contained in 40 CFR 86.010–18, which were initially promulgated February 24, 2009 (74 FR 8310). EPA’s OBD requirements promulgated in 2009 were harmonized with CARB’s OBD program then in place. Since 2009, CARB has revised their OBD requirements, while EPA’s requirements have not changed. EPA’s existing OBD program allows manufacturers to demonstrate how the OBD system they have designed to comply with California OBD requirements for engines used in applications greater than 14,000 pounds also complies with the intent of existing EPA OBD requirements.<sup>564</sup> When applying for EPA 50-state certification, all manufacturers currently seek OBD approval from CARB for OBD systems in engine families and then demonstrate compliance with EPA’s OBD regulations through this provision. Currently all heavy-duty manufacturers are certifying to the revised CARB OBD regulations that took effect in 2019.<sup>565</sup>

As part of our effort to evaluate EPA compliance programs, we are proposing to update our OBD regulations both to better address newer diagnostic methods and available technologies and to streamline provisions where possible. These revised regulations are being proposed in 40 CFR 1036.110.

#### 1. Incorporation of California OBD Regulations by Reference

CARB OBD regulations for heavy-duty engines are codified in title 13, California Code of Regulations, sections 1968.2, 1968.5, 1971.1 and 1971.5. These regulations have been updated by

CARB several times since EPA initially promulgated HD OBD regulations in 2009. The most recent updates were in October of 2019 and start to phase in with MY 2022.<sup>566</sup> It is possible that CARB could further update their heavy-duty OBD regulations prior to the final rulemaking for this program. In July 2021, CARB proposed changes to their OBD program.<sup>567</sup> These amendments may include adding the use of Unified Diagnostic Services (“UDS”) to address the concern about the limited number of remaining, undefined 2-byte diagnostic trouble codes and the need for additional codes for hybrid vehicles. These amendments may also modify freeze frame requirements, in-use monitoring performance ratio requirements, and expand readiness group lists. As discussed below, our proposal intends to harmonize with the majority of CARB’s existing OBD regulations, as appropriate and consistent with the CAA. EPA also seeks comment on harmonizing with any future OBD amendments that may result from this proposal.

In response to the ANPR, EPA received a number of comments supportive of EPA’s adoption of the revised CARB OBD program including the 2019 rule amendments.<sup>568</sup> In particular, many commenters were supportive of the new tracking requirements contained in CARB’s updated OBD program, known as the Real Emissions Assessment Logging (“REAL”) program to track real-world emissions systems performance of heavy-duty engines. This update requires the collection of onboard data using existing OBD sensors and other vehicle performance parameters, which would allow the assessment of real-world, in-use emission performance relative to laboratory performance beginning in the 2022 model year.

In developing the ANPR, we considered proposing to update the current text in 40 CFR 86.010–18 and migrate it into the new 40 CFR 1036.110. However, given industry’s familiarity with the current CARB regulations, we have decided instead to

propose incorporating by reference in 40 CFR 1036.110 the existing CARB OBD regulations updated in 2019 as the starting point for our updated OBD regulations. EPA’s proposed OBD requirements are closely aligned with CARB’s existing requirements with a few exceptions. We are proposing to exclude certain provisions that are not appropriate for a federal program and to include additional elements to improve on the usefulness of OBD systems for users.<sup>569</sup> We are taking comment on whether and to what extent we should harmonize with CARB’s next expected update to their OBD regulations, or whether the proposed language in 40 CFR 1036.110(b) is sufficient to accommodate any future divergence in CARB and EPA OBD requirements. EPA anticipates that this language would allow for EPA approval of OBD systems that meet certain parts of updated CARB requirements (e.g., updated communication protocols), as long as such provisions meet the intent of EPA OBD requirements.

#### i. OBD Threshold Requirements

The most essential component of the OBD program is the threshold requirement. Heavy-duty engine emission control components can contribute to an increase in emissions if they malfunction and therefore, they must be monitored by OBD systems. Existing OBD requirements specify how OBD systems must monitor certain components and indicate a fault code prior to when emissions would exceed emission standards by a certain amount, known as an emission threshold. Emission thresholds for these components are generally either an additive value above the exhaust emission standard, or a multiple of the standard. Reductions to emission standards mean that without additional action, OBD thresholds would also be reduced proportionally.

The CARB Omnibus Amendments to the HD OBD regulation include a provision that will not proportionally reduce NO<sub>x</sub> and PM OBD threshold requirements that correspond to the new lower emission standards.<sup>570</sup> This

<sup>566</sup> The most recent updates for 13 CCR 1971.1 and 13 CCR 1971.5 are available here <https://ww2.arb.ca.gov/resources/documents/heavy-duty-obd-regulations-and-rulemaking>.

<sup>567</sup> CARB 2021 OBD II and Heavy-Duty OBD (HD OBD) Regulatory Documents Public Notice for OBD Regulations Update, July 22, 2021. Available here: <https://ww2.arb.ca.gov/resources/documents/obd-ii-regulations-and-rulemaking>.

<sup>568</sup> For example, see comments from Roush, Docket ID EPA–HQ–OAR–2019–0555–0303; International Council on Climate Change, Docket ID EPA–HQ–OAR–2019–0555–0304; and the Metropolitan Washington Council of Governments, Docket ID EPA–HQ–OAR–2019–0555–0286.

<sup>569</sup> The legal effect of incorporation by reference is that the material is treated as if it were published in the **Federal Register** and CFR. This material, like any other properly issued rule, has the force and effect of law. Congress authorized incorporation by reference in the Freedom of Information Act to reduce the volume of material published in the **Federal Register** and CFR. (See 5 U.S.C. 552(a) and 1 CFR part 51). See <https://www.archives.gov/federal-register/cfr/ibr-locations.html> for additional information.

<sup>570</sup> California Air Resources Board, Heavy-Duty Omnibus Regulation. Available online: <https://ww2.arb.ca.gov/rulemaking/2020/hdomnibuslownox>.

<sup>564</sup> See 40 CFR 86.010–18(a)(5).

<sup>565</sup> CARB Final Rulemaking Package took effect on October 3, 2019, available here: <https://ww2.arb.ca.gov/resources/documents/heavy-duty-obd-regulations-and-rulemaking>.

means the future numerical values of OBD NO<sub>x</sub> and PM thresholds would remain unchanged from today's numerical thresholds as a part of that rulemaking. CARB noted in the Omnibus rule that more time is needed to fully evaluate the capability of HD OBD monitors to accommodate lower thresholds that would correspond to lower emission levels. EPA is proposing to harmonize with this policy and not lower OBD NO<sub>x</sub> and PM threshold levels in our proposed OBD regulations at this time. EPA may consider updating threshold requirements in a separate action which may align with a future CARB action. Specifically, we are proposing that heavy-duty compression-ignition engines would be subject to NO<sub>x</sub> and PM thresholds of 0.4 g/hp-hr and 0.03 g/hp-hr, respectively, for operation on the FTP and SET duty cycles. For spark ignition engines, we are proposing the following thresholds to align with CARB: 0.30 g/hp-hr for monitors detecting a malfunction before NO<sub>x</sub> emissions exceed 1.5 times the applicable standard, 0.35 g/hp-hr for monitors detecting a malfunction before NO<sub>x</sub> emissions exceed 1.75 times the applicable standard, and 0.60 g/hp-hr for monitors detecting a malfunction before NO<sub>x</sub> emissions exceed 3.0 times the applicable standard. For spark ignition engines, we are also proposing a 0.015 g/hp-hr threshold for PM emissions to align with CARB. EPA is seeking comment on this proposed action, or whether thresholds should be modified as a part of this proposal.<sup>571</sup>

ii. CARB OBD Provisions Revised or Not Included in the Proposed Federal Program

EPA is proposing to adopt the majority of the CARB OBD program. However, we are proposing that some provisions may not be appropriate for the federal regulations.<sup>572</sup> As part of CARB's development of the 2019 OBD program, a number of stakeholders submitted comments to CARB.<sup>573</sup> In developing this proposal, we have reviewed the concerns raised by stakeholders to CARB to help us

<sup>571</sup> California Air Resources Board. Staff Report: Initial Statement of Reasons-Public Hearing to Consider the Proposed Heavy-Duty Engine and Vehicle Omnibus Regulation and Associated Amendments. June 23, 2020. <https://ww3.arb.ca.gov/regact/2020/hdomnibuslownox/isor.pdf>.

<sup>572</sup> Note that we are making no determination in this proposal about the appropriateness of these provisions for CARB regulation.

<sup>573</sup> Kopin, Amy. Memorandum to docket EPA-HQ-OAR-2019-0055. "Comments submitted to the California Air Resources Board during the development of updated heavy-duty OBD requirements." October 1, 2021.

determine what provisions may not be appropriate in a federal program. In a new 40 CFR 1036.110(b), we are proposing clarifications and changes to the 2019 CARB regulations we are otherwise incorporating by reference, including provisions related to:

1. Providing flexibilities to delay compliance up to three model years for small manufacturers who have not previously certified an engine in California,
2. Allowing good engineering judgment to correlate the CARB OBD standards with EPA OBD standards,
3. Clarifying that engines must comply with OBD requirements throughout EPA's useful life as specified in 40 CFR 1036.104, which may differ from CARB for some model years,
4. Clarifying that the purpose and applicability statements in 13 CCR 1971.1(a) and (b) do not apply,
5. Specifying NO<sub>x</sub> and PM threshold requirements,
6. Not requiring the manufacturer self-testing and reporting requirements in 13 CCR 1971.1(i)(2.3) and 1971.1(i)(2.4),
7. Retaining and migrating our existing deficiency policy into proposed 40 CFR 1036.110(d), and specifying that the deficiency provisions in 13 CCR 1971.1(k) do not apply,
8. Requiring additional freeze frame data requirements,
9. Requiring additional data stream parameters for compression- and spark-ignition engines, and
10. Providing flexibilities to reduce redundant demonstration testing requirements for engines certified to CARB OBD requirements.

Manufacturers indicated concern with the existing manufacturer self-testing ("MST") requirements in 13 CCR 1971.1(i)(2.3 and 2.4). This provision requires manufacturers to obtain vehicles that have reached their full useful life and remove the engine for extensive testing to quantify emission performance and deterioration of the system elements in a manner that allows comparison to deterioration and performance levels achieved with the manufacturer's accelerated aging process. In 2009, when EPA initially promulgated OBD regulations for the heavy-duty industry, we were concerned about the difficulty and expense of removing an in-use engine from a vehicle for engine dynamometer testing, and we did not adopt such a requirement at that time.<sup>574</sup> EPA continues to be concerned that the cost of this testing may be significant and is not warranted for the federal program. Further, we believe that the information

<sup>574</sup> 74 FR 8347, February 24, 2009.

CARB gains from this program can be shared with EPA and would help inform us of the ongoing progress manufacturers are making with OBD compliance. Therefore, while we are proposing to exclude this CARB OBD provision from the EPA OBD regulations at this time, we are proposing that manufacturers submit the results of any MST testing performed for CARB to EPA.

EPA requests comments and information on whether there are opportunities for further reducing OBD compliance and certification costs of the federal program through increasing the use of modeling or other calculation-based methods as a part of the certification process which could potentially replace certain testing requirements. Examples could include test-out provisions or testing required for infrequent adjustment factors. CARB's OBD program includes provisions that may allow for certain components to meet specific test-out criteria which would exempt them from monitoring requirements. For example, 13 CCR 1971.1(e)(3.2.6)(B) describes how EGR catalysts would be exempt from monitoring if manufacturers can show that both of the following criteria are satisfied: (1) No malfunction of the EGR catalyst can cause emissions to increase by 15 percent or more of the applicable NMHC, NO<sub>x</sub>, CO, or PM standard as measured from an applicable emission test cycle; and (2) no malfunction of the EGR catalyst can cause emissions to exceed the applicable NMHC, NO<sub>x</sub>, CO, or PM standard as measured from an applicable emission test cycle. EPA is seeking comment on whether manufacturers could use modeling or other calculation-based methods to determine if such test-out criteria are met.

Another example where the use of modeling or other calculation-based methods could reduce testing requirements is for the calculation of infrequent regeneration adjustment factors for engines equipped with emission controls that experience infrequent regeneration events. These adjustment factors are used to account for emissions from regeneration events when determining compliance with EPA standards. Manufacturers must conduct testing to develop these adjustment factors using the same deteriorated component(s) used to determine if the test-out criteria are being met. EPA is seeking comment on whether it is possible and appropriate to consider modeling- or calculation-based methods to replace certain hardware-based test methods in these or other

areas of certification to reduce costs without reducing the functionality of the existing OBD requirements.

EPA is seeking comment on how these or other provisions in the existing or any potential upcoming CARB OBD regulation could be modified to better suit the federal OBD program.<sup>575</sup> It is important to emphasize that by not incorporating certain existing CARB OBD requirements (e.g., the in-use engine test program) into our regulations, we are not waiving our authority to require such testing on a case-by-case basis. CAA section 208 gives EPA broad authority to require manufacturers to perform testing not specified in the regulations in such circumstances. Thus, should we determine in the future that such testing is needed, we would retain the authority to require it pursuant to CAA section 208.

EPA is proposing to retain our existing deficiency provisions in 40 CFR 86.010–18(n) and not harmonize with CARB's deficiency provisions in 13 CCR 1971.1(k).<sup>576</sup> In the 2009 OBD rule, EPA stated that having a deficiency provision is important “because it facilitates OBD implementation by allowing for certification of an engine despite having a relatively minor shortfall,” and that while the CARB OBD regulations have a provision to charge fees associated with OBD deficiencies, EPA has “never had and will continue not to have any such fee provisions.” EPA is requesting comment on retaining our existing deficiency requirements in its entirety or if any changes should be made. EPA also seeks comment on how and for what reasons OEMs have utilized CARB's deficiency policy, how this may impact compliance with the new EPA and CARB requirements and how this may be impacted by any future changes in OBD emission thresholds.<sup>577</sup>

CARB's 2019 OBD update to 13 CCR 1971.1 also includes significant changes applicable to hybrid vehicles. We are aware that current OBD requirements necessitate close cooperation between engine and hybrid powertrain system manufacturers for certification, which can present a significant challenge for introducing heavy-duty hybrids into the marketplace. To learn more about this potential challenge, EPA requested

<sup>575</sup> CARB intends to propose changes to their HD OBD program, as mentioned in the CARB Workshop for 2020 OBD Regulations Update, February 27, 2020. Available here: [https://ww3.arb.ca.gov/msprog/obdprog/obd\\_feb2020wspresentation.pdf](https://ww3.arb.ca.gov/msprog/obdprog/obd_feb2020wspresentation.pdf).

<sup>576</sup> We are proposing to migrate the existing deficiency provisions of 40 CFR 86.010–18(n) into 40 CFR 1036.110(d).

<sup>577</sup> California Code of Regulations, Title 13, section 1971.1(k)

input in the ANPR. We learned from commenters that no manufacturers have pursued a certification flexibility that CARB put in place in 2016 through the Innovative Technology Rule (ITR). The ITR provided short-term certification flexibilities, such as allowing hybrid manufacturers to use Engine Manufacturers Diagnostics (EMD), rather than heavy-duty OBD for two to four consecutive model years depending on the all-electric range of the vehicle.<sup>578 579 580</sup> We also heard from at least one hybrid manufacturer suggesting that onboard NO<sub>x</sub> sensors could be used in lieu of OBD for heavy-duty hybrids. The potential use of onboard sensors to meet some OBD requirements for any heavy-duty vehicle, including hybrids, is discussed in Section IV.C.2.ii below. We continue to be interested in understanding from commenters and request comment on whether and how OBD may present a barrier to the adoption of heavy-duty hybrid systems, and any potential opportunities for EPA to address such barriers. We have prepared a memorandum that further explores these regulatory issues, with a discussion of a range of possible options that we are considering for hybrid systems in heavy-duty specialty vehicles, but which could apply more broadly to all heavy-duty hybrid systems.<sup>581</sup>

Finally, EPA is seeking comment on whether improvements could be made to OBD to monitor inducement conditions. For example, while individual components responsible for inducements currently are monitored (e.g., DEF level sensors), there is no requirement that inducements themselves be monitored to ensure a false inducement did not occur or that such events are tracked for remediation. EPA seeks comment on whether OBD systems should monitor the inducement process and detect system malfunctions prior to a failure (e.g., for deterioration of the DEF delivery system) to improve emission system performance by providing opportunities for repairs to be made prior to complete failures and by preventing inducements that either

<sup>578</sup> Heavy-duty EMD requires diagnostic monitoring of the performance and durability of the fuel system, exhaust gas recirculation system (if so equipped), particulate trap, and other emission-related electronic components.

<sup>579</sup> California Code of Regulations, Title 13, section 2208.1

<sup>580</sup> See the comments of the California Air Resources Board, Docket ID EPA–HQ–OAR–2019–0055–0471.

<sup>581</sup> Stout, Alan. Memorandum to Docket EPA–HQ–OAR–2019–0055. “Draft Amendments Related to Alternate Engine Standards for Specialty Vehicles”. January 31, 2022.

should not have occurred or could have been avoided.

### iii. Additional OBD Provisions in the Proposed Federal Program

EPA received comments on the ANPR from a wide variety of stakeholders describing difficulties diagnosing problems with and maintaining proper functionality of advanced emission technologies and the important role accessible and robust diagnostics play in this process. The California Air Pollution Control Officers Association and NACAA commented on the need for EPA to develop and maintain a robust OBD program with diagnostic specificity that would ensure OBD continues to accurately detect system failures for lower emission standards and inform the person performing the repair of what the problem is and the cause, so it can be promptly, proficiently and cost-effectively repaired, as well as to facilitate the development of comprehensive enforcement programs.<sup>582 583</sup> The Pennsylvania Department of Environmental Protection commented that EPA should evaluate how advances in OBD technology could be applied to enhance operations, monitoring and maintenance capabilities of heavy-duty diesel aftertreatment systems and how current and future technologies may use OBD technologies to inform operators and repair technicians as to the in-use efficacy of those systems across multiple duty cycles.<sup>584</sup> ATA commented that ease of diagnostics for emission component failures is a significant concern for their members.<sup>585</sup> NASTC members expressed significant frustration with the inability to use existing diagnostics to understand problems with emission components.<sup>586</sup>

As a part of our effort to update our OBD program and respond to these concerns, EPA is proposing to include additional requirements as well as modify certain CARB OBD requirements to better address newer diagnostic methods and technologies and to ensure that OBD can be used to properly diagnose and maintain emission control

<sup>582</sup> See the comments of the California Air Pollution Control Officers Association, Docket ID EPA–HQ–OAR–2019–0555–0275.

<sup>583</sup> See the comments of the National Association of Clean Air Agencies, Docket ID EPA–HQ–OAR–2019–0055–0283.

<sup>584</sup> See the comments of The Pennsylvania Department of Environmental Protection, Docket ID EPA–HQ–OAR–2019–0055–0455.

<sup>585</sup> See the comments of the American Trucking Association, Docket ID EPA–HQ–OAR–2019–0055–0357.

<sup>586</sup> See the comments of the National Association of Small Trucking Companies, Docket ID EPA–HQ–OAR–2019–0055–0456.

systems to avoid increased real-world emissions. EPA intends to continue to accept CARB OBD approval where a manufacturer can demonstrate that the CARB program meets the intent of EPA OBD requirements (see section IV.C.2.i.b. for further discussion), and manufacturers would submit documentation as specified in proposed 40 CFR 1036.110(c)(5) to show that they meet the additional requirements proposed here.

In this section we describe the following proposed additional EPA certification requirements in 40 CFR 1036.110 for OBD systems:

1. Health monitors for the SCR, DPF, and EGR systems
2. Display health monitor and inducement-related information in the cab
3. Diagnostic testing to measure the effectiveness of DEF dosing must be made available for use with either a generic scan tool or an equivalent alternative method

Enhanced OBD systems that provide more information and value to the operator can play an important role in ensuring expected in-use emission reductions are achieved long-term. For example, in comments to the ANPR, CARB stated that their test programs have identified numerous heavy-duty vehicles with mileages within their applicable regulatory useful life periods, but beyond their warranty periods, that had NO<sub>x</sub> emission levels significantly above the applicable certification standards.<sup>587</sup> CARB also stated that some stakeholders such as fleet owners, retrofit installers, and equipment operators have communicated to CARB that they are experiencing significant vehicle downtime due to parts failures.

Increasing the transparency and usefulness of OBD systems can help to improve maintenance and repair experiences and also serve as a mechanism to reduce owner frustration (which otherwise could provide motivation to tamper). EPA is specifically proposing to improve the robustness and usefulness of OBD systems by including emission system health monitors, increasing the number of publicly available data parameters, increasing the freeze frame data, and enabling certain self-testing capabilities for owners. These changes will benefit the environment by helping to reduce malfunctioning emission systems in-use through access to additional data that may be useful for service technicians, state and local inspection and

maintenance operations, and owners. These capabilities are also important to enable owners to avoid potential inducement conditions that can result from certain component failures.

#### a. Emissions Systems Health Monitor

The purpose of OBD is to reduce motor vehicle and motor vehicle engine emissions by monitoring the systems in-use, detecting malfunctions, informing the operator, and assisting with diagnosis of emission system problems. One concept EPA is proposing to incorporate into our updated OBD regulations is the development of “health monitors” for specific emission control technologies on CI engines to provide vehicle owners information on the overall health of important emissions systems at a given point in time. While OBD systems are highly proficient in monitoring emission systems and components, the historic purpose of OBD has been to monitor systems but only notify operators generically (e.g., through the Malfunction Indicator Light or “MIL”) once there is a failure or malfunction, rather than to use monitored data to proactively provide the operator with information on the functionality and status of such systems. However, existing OBD monitors and data parameters could also be used in a different way to generate aftertreatment health monitors. This could be accomplished by evaluating data indicating how much a system has been used or how close a system is to exceeding an OBD threshold. While most large fleets have already begun to use similar measures by using big data and telematics to implement predictive maintenance, this concept is different in that it would be focused on using a particular vehicle’s data to evaluate system status as opposed to using data from thousands of trucks to predict system status.<sup>588</sup> Predictive maintenance relies on analytics that examine existing data to identify potential risks of failure on particular trucks or components prior to the failures occurring in the field.<sup>589</sup> Predictive maintenance can enable operators to replace components later than when utilizing a traditional preventative maintenance approach and can essentially increase the service life

of certain emission system components, prevent breakdowns, and reduce total operating costs. Predictive maintenance could also result in components being changed more frequently to avoid or reduce breakdowns and downtime, thereby also reducing total operating costs. An emissions system health monitor, while not as comprehensive of a tool as predictive maintenance, could provide similar types of benefits resulting in more uptime for emission control systems. Health monitors could also provide critical insight on the status of a vehicle’s emissions systems for buyers considering purchasing used trucks. EPA is proposing that the health monitors’ status would need to be made available on the dash or other display for access to the data without the use of a scan tool. The purpose of the health monitor is not to guarantee the performance of an emissions system in the future, but instead to provide status information on the functioning of the relevant system at the moment in time. In addition, such a monitor could be used to warn users of potential upstream failures that can cause damage to aftertreatment components resulting in expensive repairs. EPA worked with Environment and Climate Change Canada (“ECCC”) to develop this concept. Using an emissions system health monitor to improve and make more efficient heavy-duty engine and vehicle maintenance practices could provide environmental benefits by helping to sustain system performance long-term.

In discussions with ECCC about how to develop a health monitor concept, they suggested that a single value representing the performance of the vehicle’s emission system as a whole would be less effective than two or three individual “health monitors”, and EPA agrees. EPA is proposing, and seeking comment on the benefits of, specific methods for CI engines to inform a vehicle operator of the general health of the DPF, SCR, and EGR systems. There are two main approaches EPA could use to achieve this goal: (1) A broad requirement that leaves the identification and implementation of the specific methodologies up to each manufacturer, or (2) a specific requirement that prescribes the methodologies to be used by all manufacturers. EPA is proposing the first alternative, and seeks comment on the second alternative, or any other alternative that commenters believe would be more beneficial or less costly and that would still provide benefits to the owner and resulting environmental benefits from better performing

<sup>588</sup> Park, Jim. September 7, 2018. “How Data Is Changing Predictive Maintenance.” Available here: <https://www.truckinginfo.com/312738/how-data-is-changing-predictive-maintenance>.

<sup>589</sup> Lockridge, Deborah. May 31, 2019. “How One Fleet is Closing in on Predictive Maintenance.” Available here: <https://www.truckinginfo.com/332946/how-one-truck-fleet-is-closing-in-on-true-predictive-maintenance>.

<sup>587</sup> See the comments of the California Air Resources Board, Docket ID EPA-HQ-OAR-2019-0055-0471.

emissions controls systems. Under any approach, we are interested in emissions system health monitors that better enable owners to understand emission system functionality, help avoid potential breakdowns, and reduce incentives to tamper with emission control systems as a result of experiencing unplanned and catastrophic emission system failures. A prescriptive approach may be more useful in that it would provide consistency between manufacturers which could result in more useful and stable data for users, however, a broad requirement that allows manufacturers to better capitalize on their existing OBD system design may also achieve the goals of this health monitor proposal. This proposal focuses on leveraging existing OBD requirements in new ways to develop health monitors for DPF, SCR, and EGR systems to avoid costs that could be associated with an entirely new monitoring requirement. EPA seeks comment on whether additional monitors could be developed utilizing existing OBD requirements which can further help prevent downtime, such as additional upstream health indicators (*e.g.*, preventing excessive internal oil leaks) to proactively prevent damage to expensive aftertreatment components.

#### (1) Proposed DPF Health Monitor

For the DPF system, EPA has identified essential information that users should have access to for ensuring that proper maintenance and use can occur. Having continuous access to DPF health information can provide important insight on DPF system status. EPA is proposing that users have access to the following information available for display in the cab, which together would form the DPF health monitor: (1) A value that indicates general system wear, for example a counter for the total number of passive and active regeneration (“regen”) events that have taken place on the existing DPF, (2) a value that indicates the average active and passive regen frequency and a method for operators to track changes in these values, (3) a value estimating (in miles or hours) when the DPF needs to be cleaned to remove accumulated ash, and (4) notification when active regens have been disabled by the system (even temporarily) if accompanied by a derate, as well as the reason it was disabled. While not specifically a part of the DPF health monitor, EPA is proposing additional DPF maintenance information be made available to users to improve serviceability experiences, see section IV.B.3.ii. for more discussion on these proposed requirements.

Providing users with a general indicator of system wear can help users make informed maintenance decisions. EPA would expect that a manufacturer would allow this monitor to be reset if a DPF is replaced. Manufacturers could in part utilize work that may be done to meet CARB OBD requirements to implement this proposal. For example, the 2019 CARB OBD program that we are proposing to harmonize with includes a provision for MY 2024 that requires a lifetime counter of DPF regens (see 13 CCR 1971.1(h)(5.8.2)). EPA is seeking comment on the use of CARB’s required lifetime counter to meet this proposed requirement, or what alternative information manufacturers could use to meet this requirement and whether this information should be standardized.

Providing users with an indication of the total average regen frequency (active and passive) and with a method that could be used to detect recent changes in system function can allow users to familiarize themselves with proper system operation. For example, this could be achieved by displaying the average regen frequency per a fixed number of miles or hours and providing a resettable counter to show the most recent average regen frequency. Such a feature would enable owners to monitor the number of regens occurring over a particular route to detect changes (*e.g.*, a significant increase in the number of regeneration events) which could inform them of the need to address failures upstream of the DPF, clean the DPF, or service the DPF system. In particular, EPA seeks to alert operators to potential conditions that could indicate an upstream problem (*e.g.*, an oil leak) that can damage sensitive aftertreatment components prior to a catastrophic failure or result in the need for costly repairs to aftertreatment systems. Manufacturers may be able to utilize existing work already being done to meet the frequent regeneration requirements in 13 CCR 1971.1(e)(8.2.2) to inform owners when regen frequency exceeds a certain level that may indicate an upstream issue. As discussed earlier, EPA is proposing that the health monitors’ status would need to be made available on the dash or other display for access to the data without the use of a scan tool. EPA would expect that operators would be able to access this information on demand, and that manufacturers would not have the health monitor tied to the MIL to avoid any confusion. EPA is seeking comment on whether this component of the DPF health monitor is important enough to require that it be communicated when

the frequency of regens reaches a particular level that may indicate the need for inspection and possibly repair, what this level would be, and what such a warning system should look like.

Having access to information that indicates an estimate of when the DPF needs to be cleaned would allow operators to plan ahead for critical maintenance and reduce downtime. We are not proposing a specific method manufacturers would use to generate the estimated time to perform such a cleaning, rather we would leave it to manufacturers to determine the best method of implementation.

Finally, providing operators with notification of when active regens have been disabled by the system (even temporarily) as well as the reason it was disabled would provide benefits to operators and repair technicians. Manufacturers generally implement severe derates when DPF system faults occur that prevent active regens from occurring. Providing owners with information on the cause of a DPF-related derate would reduce frustration and may reduce downtime by allowing repairs to be made more quickly, increasing in-use emission system performance.

EPA is seeking comment on how manufacturers could lessen the effects of duty cycle related regens frequency variability in the health monitor (*e.g.*, vehicles that operate more at lower speeds would likely experience more active regens than those that operate at higher steady-state speeds), through normalizing the reported data or focusing on specific regions of operation where regens occur with more regularity. For example, this DPF health monitor parameter could include only passive regens that occur during certain vehicle operation, such as operation that occurs in OBD REAL Bin 14. EPA is seeking comment on whether the DPF health monitor should provide this information on demand, and if it should also notify users of potential concerns.

#### (2) Proposed SCR Health Monitor

For the SCR system, EPA has identified essential information that users should have access to for ensuring that proper preventive maintenance occurs. EPA is proposing that the SCR health monitors’ status would need to be made available on the dash or other display for access to the data without the use of a scan tool. Having access to SCR health information on demand can provide important insight on SCR system status and help operators prevent inducements from occurring. EPA is proposing that users have access to the following information for the SCR

health monitor: (1) Indicator of average DEF consumption and a method for operators to track changes in this value, (2) warnings before blockages in the DEF line or dosing valve actually occur and an inducement would be triggered, and (3) information on when DEF dosing has been disabled by the system (even temporarily) if accompanied by a derate as well as the reason it was disabled. EPA is not proposing specific methods manufacturers would use to meet these requirements and would be leaving it up to manufacturers to develop the most appropriate method based on their product designs. We are taking comment on this approach, or if instead we should specify the way the SCR health monitor should be implemented, which would ensure consistency across the fleet.

Providing users with an indication of average DEF consumption and with a method that could be used to detect recent changes in that value can allow users to familiarize themselves with proper system operation. This could be achieved for example by manufacturers providing the lifetime average DEF used per gallon of fuel and a recent or resettable counter to show the most recent average DEF consumption value. Such a feature would enable owners to develop a high-level understanding of proper SCR function and operation, can alert the operator to changes that may indicate a problem before there is a failure resulting in a breakdown and corresponding downtime, and enable owners to monitor the data over a particular route (or after a particular repair) to detect system changes (or evaluate the effectiveness of a recent repair).

EPA is seeking comment on how manufacturers could lessen the effects of duty cycle related DEF consumption variability in the health monitor, through normalizing the reported data or focusing on specific regions of operation where DEF consumption should be more stable. For example, this SCR health monitor parameter could include provide average DEF consumption that occurs during certain vehicle operations, such as operation that occurs in OBD REAL Bin 14.

The SCR health monitor proposal also includes a requirement for manufacturers to provide information to the operator regarding potential plugging of the DEF line or dosing valve prior to a blockage actually occurring. Manufacturers have likely developed strategies to monitor such blockages in response to EPA's existing inducement guidance.<sup>590</sup> DEF can crystallize over

time and build up in SCR components such as the injector, which in some cases could also result in a false inducement being triggered for conditions that appear to be caused by tampering, which this health monitor can help prevent.<sup>592</sup> Further, it is critical to ensuring that DEF restrictions are promptly addressed to maintain proper SCR system function. Finally, EPA is proposing that the health monitor provide information on when DEF dosing has been disabled by the system (even temporarily) as well as the reason it was disabled if accompanied by a derate. Having access to this information is critical to ensuring operators can perform maintenance timely, and potentially prior to a vehicle going into inducement. EPA is seeking comment on whether the SCR health monitor should provide this information on demand, and if it should also notify users of potential concerns.

Finally, EPA is seeking comment on alternative methods to develop a health monitor for SCR systems, for example including one that would use DEF dosing trim values (*i.e.*, DEF dosing rates at particular operating points such as within NTE operating zones or REAL bins) and compare the dosing rate that is occurring in real-time to what the dosing rate was when the vehicle was new. The idea is that as components wear and SCR performance deteriorates, the system may compensate by increasing the DEF dosing rate at a particular operating point; using the information contained in the engine controller software could help alert operators to such changes and allow them to perform repairs or maintenance prior to the vehicle experiencing a catastrophic failure. This method, especially if combined with ammonia slip information, could offer a better indication of system performance.

### (3) Proposed EGR Health Monitor

For the EGR system, EPA has identified essential information that users should have access to for ensuing proper maintenance and use can occur. In particular, we expect access to information indicating EGR valve coking or EGR cooler failure, which are the two main failure conditions, may avoid devastating impacts on downstream aftertreatment components.<sup>593</sup> We are proposing to

require manufacturers to provide an indication of EGR valve health. For example, they could use existing OBD signals to provide an indication of the health of an EGR valve by looking at the difference between commanded and actual EGR valve position to indicate valve coking. The intent of this health monitor is to enable operators to understand when the EGR valve is becoming plugged and allow them to perform preventative maintenance prior to a catastrophic failure.

In addition, EPA is proposing a health monitor for the EGR cooler. Manufacturers could in part utilize work already being done to meet existing CARB requirements in 13 CCR 1971.1(e) for EGR cooler performance monitoring to satisfy this requirement. These requirements specify that manufacturers design their system to monitor the cooler system for insufficient cooling malfunctions, including the individual electronic components (*e.g.*, actuators, valves, sensors). The OBD system must detect a malfunction of the EGR cooler system prior to a reduction from the manufacturer's specified cooling performance that would cause an engine's NMHC, CO, or NO<sub>x</sub> emissions to exceed 2.0 times any of the applicable standards or the engine's PM emissions to exceed the applicable standard plus 0.02 g/hp-hr. EPA is seeking comment on these or other strategies that can help inform operators of the functionality of the EGR system to help prevent breakdowns due to EGR system failures, including whether or how to monitor for EGR cooler leaks or plugging, such as through the use of pressure or temperature sensors, and whether today's engines are equipped with sensors in the EGR system that could be used for this purpose. We are also seeking comment on whether fault codes related to incidents of engine derate due to EGR-related failures should be displayed in the cab as a part of this health monitor, similar to what is being proposed for SCR and DPF-related derate issues.

Annual Meeting & EXPO. Titled "DPF Maintenance: Avoid the Five Most Common Mistakes." Available here: <https://www.apta.com/wp-content/uploads/Resources/mc/annual/previous/2017annual/LZpresentations/Learning%20Zone%20Presentations/Anderson,%20Jeremy.pdf>.

<sup>594</sup> Stanton, Bob. April 4, 2017. "Aftertreatment System: A New System Not to be Overlooked." Available here: <https://www.worktruckonline.com/157340/aftertreatment-system-a-new-system-not-to-be-overlooked>.

<sup>590</sup> See Section IV.D.4. for further discussion on proposed inducement-related requirements for blocked DEF lines.

<sup>592</sup> For example, see NHTSA Service Bulletin available here: <https://static.nhtsa.gov/odi/tsbs/2019/MC-10153679-9999.pdf>.

<sup>593</sup> Anderson, Jeremy. 2017 presentation at American Public Transportation Association 2017

<sup>590</sup> See CJS09-04 REVISED.

### b. Expanded List of Public OBD Parameters

In another area for improvement in the OBD program, EPA proposes to harmonize with the revised list of data parameters CARB has developed for MY 2024 through our incorporation by reference of CARB's revised OBD regulations and to further expand the list of OBD parameters that manufacturers are required to make publicly available. 13 CCR 1971.1(4.2) data stream requirements state that the listed signals be made available on demand through the "standardized data link connector" (OBD port) in accordance with J1979/J1939 specifications. The requirements also specify that the actual signal value must be used, the default or limp home value cannot be used. Until MY 2024, CARB regulations require a list of 91 signals that must be made publicly available, of which approximately ten are related to aftertreatment and primarily include measures of the pressure and temperature of the DPF. CARB updated these requirements in 2019 such that additional aftertreatment-related signals will be added in MY 2022 and MY 2024. EPA is proposing to adopt CARB's parameter list through our incorporation by reference of their updated 2019 OBD regulations, to add signals to the list, and to specifically require the addition of all parameters related to fault conditions that trigger vehicle inducement to be made readily available using generic scan tools if the engine is so equipped (see Section IV.D for more discussion on inducements). EPA would expect that each of these additional requirements would need to be addressed even where manufacturers relied in part on a CARB OBD approval to meet the intent of our proposed OBD regulations. The purpose of including additional parameters is to make it easier to identify malfunctions of critical aftertreatment related components, especially where failure of such components would trigger an inducement. In addition, the proposed additional information can make the repairs themselves easier by allowing for immediate access to fault codes, which could alleviate the long wait times associated with specialized emission repair facilities or where facilities are not available when an inducement occurs (such as on the weekend or in a remote location). In response to the ANPR, EPA received comments supportive of such changes, for example from the National Tribal Air Association ("NTAA") who noted that service information and tools should be made easily available and affordable for

individual owners to diagnose and fix their own vehicles, which can be especially important for small businesses, Tribes, and those in rural areas with less ready access to original equipment manufacturer dealer networks.<sup>595</sup>

We are proposing a general requirement to make such parameters available if they are used as the basis for an inducement response that interferes with the operation of the engine or vehicle. For example, if the failure of an open-circuit check for a DEF quality sensor leads to an engine inducement, the owner/operator would be able to identify this fault condition using a generic scan tool. This proposal should be enabled in part by a change to the comprehensive component monitoring requirements in CARB's 2019 OBD regulations. CARB now specifies that for MY 2024 and later, comprehensive component monitoring must include any electronic powertrain component/system that either provides input to (directly or indirectly) or receives commands from an on-board computer or smart device, which is also used as an input to an inducement strategy or other engine derate (see 13 CCR 1971.1(g)(3.1.1)). We are also proposing some new parameters for HD SI engines, as mentioned in Section III.D.2. We are proposing that manufacturers make additional parameters available for all engines so equipped, including:

- For Compression Ignition engines:
  - Inlet DOC and Outlet DOC pressure and temperature
  - DPF Filter Soot Load (for all installed DPFs)
  - DPF Filter Ash Load (for all installed DPFs)
  - Engine Exhaust Gas Recirculation Differential Pressure
  - DEF quality
  - Parking Brake, Neutral Switch, Brake Switch, and Clutch Switch Status
  - Aftertreatment Dosing Quantity Commanded and Actual
  - Wastegate Control Solenoid Output
  - Wastegate Position Commanded
  - DEF Tank Temperature
  - Injection Control Pressure Commanded and Actual
  - DEF System Pressure
  - DEF Pump Commanded Percentage
  - DEF Coolant Control Valve Control Position Commanded and Actual
  - DEF Line Heater Control Outputs
  - For Spark Ignition Engines:
    - A/F Enrichment Enable flags: Throttle based, Load based, Catalyst protection based

<sup>595</sup> See comments of the National Tribal Air Association, Docket ID EPA-HQ-OAR-2019-0555-0282.

- Percent of time not in stoichiometric operation (including per trip, and since new)

- Catalyst or component temperature parameters (measured and modeled, if applicable) specifically used for thermal protection control strategies as proposed in Section III.D.2.

EPA is seeking comment on whether any additional signals should be included in this list to help ensure in-use emission benefits occur as expected, and whether any other signals should be included such as any signals related to maintenance derates (outside of inducements). Although CARB currently requires a list of signals that must be made public, EPA encountered difficulty accessing many of these signals in recent testing on in-use trucks. EPA, working closely with Environment and Climate Change Canada, used a number of generic scan tools on a variety of vehicle makes and models and were unable to see all of the publicly required data. While this could indicate a problem with a specific generic scan tool design, none of the scan tools from a range of price points was able to display the complete set of signals; some tools read less than a third of the required signals. Some parameters read "No Response" or "Not Available" or were missing a signal in its entirety. This situation can cause frustration for owners who own generic scan tools and are unable to access any required data when trying to repair vehicles. EPA requests comment on operator experiences with obtaining data using generic scan tools from trucks in-use.

### c. Expanding Freeze Frame Data Parameters

One of the more useful features in the CARB OBD program for diagnosing and repairing emissions components is the requirement for "freeze frame" data to be stored by the system. To comply with this requirement, manufacturers must capture and store certain data parameters (e.g., vehicle operating conditions such as the NO<sub>x</sub> sensor output reading) within 10 seconds of the system detecting a malfunction. The purpose of storing this data is in part to record the likely area of malfunction. CARB has identified a list of approximately 63 parameters that must be captured in the freeze frame data for gasoline engines and 69 parameters for diesel engines. Currently, the freeze frame data does not include additional signals for aftertreatment systems. While existing CARB freeze frame data requirements include some DPF-related parameters (e.g., inlet and outlet pressure and temperature), there is essentially no SCR information, which

EPA believes is essential for proper maintenance. We are therefore proposing that EPA's updated OBD requirements include the additional parameters proposed in section IV.C(1)(ii)(b) of this preamble and those included in the following section of CARB's regulations sections 13 CCR 1971.1(h)(4.2.1)(D), 1971.1(h)(4.2.2)(H), 1971.1(h)(4.2.3)(F), 1971.1(h)(4.2.3)(G), 1971.1(h)(4.2.2)(I). We welcome comment on this proposal, including whether additional data parameters should be included in the freeze frame data to enable those diagnosing and repairing vehicles to more effectively identify the source of the malfunction and increase the usefulness of freeze frame data, especially for conditions that result in inducement.

#### d. System Commanded Tests To Facilitate Inducement-Related Diagnoses and Repairs

Today's vehicle control systems have built-in tests that can be used to command components to perform a particular function in order to confirm that they are working properly.<sup>596</sup> An equally important element of an effective OBD program is ensuring owners have the ability to run certain engine or vehicle tests and view the results, especially where they can be used by owners in diagnosing and repairing problems that may result in inducement. If, for example, the problem was caused by a faulty DEF pump, this type of repair likely does not require specialized training to complete but is difficult to detect without access to such a test. More immediate diagnosis and repair of faulty components such as this would result in reduced costs for owners and increased long-term environmental benefits through improved emission control function.

Today, vehicle software scan tools can be designed to command a DEF pump to operate, which allows a person diagnosing a DEF injection issue to measure how much DEF is pumped during a certain time interval and compare this amount to the specifications to determine whether or not the pump and injector are functioning properly. Performing the test would allow diagnosis of the vehicle and a quick determination of whether the DEF pump is working, the DEF injector is not faulty, there are no wiring-related issues, and DEF is being sprayed properly (both in terms of

amount and spray pattern). Due to the importance of the DEF pump in maintaining full functionality of a vehicle (*i.e.*, avoiding inducement), EPA is proposing that the DEF dosing test be made available for use with either a generic scan tool (be made available on demand through the OBD port in accordance with J1979/J1939 specifications) or an alternative method (*e.g.*, an option commanded through a vehicle system menu).

Another important test that is used today is an SCR performance test that some OEMs offer through their proprietary scan tools. This type of test causes the diagnostic system to run the engine through a specific operating cycle to check certain SCR parameters, providing a pass/fail result and indicating what potential problems may exist. In particular, this test allows for a repeatable method to be used to compare a known set of engine operating parameters and SCR performance specifications to verify that SCR performance is as-expected and to narrow the scope of any existing problems that need to be fixed. There are currently non-OEM scan tools that also can conduct the same test, but the engine's diagnostic system may not allow the generic scan tool to access the pass/fail results. The results of this test could be especially helpful for users or technicians, may help avoid unexpected breakdowns, and may improve in-use emissions. Running an SCR performance test can enable the owner or technician to monitor system parameters during the test (*e.g.*, by watching SCR inlet and outlet temperatures during a particular operating cycle) to evaluate if certain components are functioning properly during the test and may reduce the need for regens to be run instead, which can reduce wear on the DPF system. We are requesting comment on whether EPA should make SCR performance tests available via generic scan tool or other on-vehicle method. EPA is also requesting comment on the need to make other self-tests accessible with generic scan tools to improve in-use emission systems maintenance and performance, for example being able to command that the evaporative system on SI engines be sealed to allow for leak testing or including the ability to perform manual regens for DPF systems.

#### 2. Other OBD Provisions

In addition to our proposal to update our OBD regulations by incorporating much of the CARB OBD program by reference, we are also requesting comment on other improvements to our OBD program. The improvements

would be intended to make the program more effective at improving maintenance of in-use engines and vehicles, as well as reducing the compliance burdens for manufacturers. We welcome comments suggesting other ways to improve our OBD program.

#### i. OBD Provisions From the Recent HD Technical Amendment Rule

EPA recently revised our OBD regulations to harmonize with certain CARB requirements in our HD Technical Amendments (HDTA) rulemaking (86 FR 34340, June 29, 2021). This rule finalized four updated OBD provisions including: (1) Revising the misfire threshold, (2) adopting updated misfire flexibilities, (3) revising our in-use minimum ratios, and (4) allowing the use of CARB OBD reporting templates for EPA OBD requirements. EPA did not take final action at that time on two proposed revisions related to OBD demonstration testing and carry-over of OBD certification. The following sections summarize the revisions previously proposed and the concerns expressed in comments.<sup>597 598</sup>

#### a. Demonstration Testing Requirements

One of the provisions EPA did not take final action on in the HDTA rulemaking was related to determining the number of engines required to undergo demonstration testing. The existing requirements of 40 CFR 86.010–18(l) and 13 CCR 1971.1(l) specify the number of test engines for which a manufacturer must submit monitoring system demonstration emissions data. Specifically, a manufacturer certifying one to five engine families in a given model year must provide emissions test data for a single test engine from one engine rating, a manufacturer certifying six to ten engine families in a given model year must provide emissions test data for a single test engine from two different engine ratings, and a manufacturer certifying eleven or more engine families in a given model year must provide emissions test data for a single test engine from three different engine ratings.

The HDTA proposed rulemaking (85 FR 28152, May 12, 2020) proposed to allow CARB certified configurations to not count as separate engine families for the purposes of determining OEM demonstration testing requirements for

<sup>597</sup> See 85 FR 28152, May 12, 2020.

<sup>598</sup> EPA, "Improvements for Heavy-Duty Engine and Vehicle Test Procedures, and other Technical Amendments Response to Comments," December 2020, Docket EPA-HQ-OAR-2019-0307, Publication Number: EPA-420-R-20-026 (see discussion starting on page 80).

<sup>596</sup> Morgan, Jason. January 21, 2019. "What the right data can tell you about aftertreatment issues." Available here: <https://www.fleetequipmentmag.com/heavy-duty-truck-aftertreatment-service-issues-data/>.



EPA OBD approval. EPA received adverse comment on this proposal stating that it was inconsistent for EPA to not include CARB-only families when determining demonstration testing requirements for 49-state EPA families, but to accept demonstration test data from CARB-only families to meet 49-state EPA certification. There were additional concerns that the proposal did not include the criteria that EPA would use to approve or deny the request to not count certain families, and that this proposal applied to “special families” which were not defined by EPA. In the HDTA final rulemaking, EPA explained that this provision required additional consideration and did not take final action on it at that time.

We stated in the HDTA final rulemaking that we intended to review this issue as a part of the HD 2027 proposal. EPA recently issued guidance for certain cases, where an OBD system designed to comply with California OBD requirements is being used in both a CARB proposed family and a proposed EPA-only family and the two families are also identical in all aspects material to expected emission characteristics. EPA anticipates that a manufacturer would be able to demonstrate to EPA that the intent of 40 CFR 86.010–18(l) is met for the EPA-only family by providing proof that CARB has determined the monitoring system demonstration requirements for the corresponding CARB proposed family have been met.<sup>599</sup> We are proposing to codify this as a provision in 40 CFR 1036.110(b)(11). We are requesting comment on this provision, including whether additional restrictions should be included to ensure engine families are appropriately counted. EPA is also seeking comment on allowing a similar provision for cases where equivalent engine families differ only in terms of inducement strategies (see section IV.D.6 for further discussion). Finally, EPA is seeking comment on whether we should include revisions beyond those proposed to address this situation.

#### b. Use of CARB OBD Approval for EPA OBD Certification

EPA did not take final action on the proposed reordering of 40 CFR 86.010–18(a)(5) in the HDTA final rulemaking. These existing EPA OBD regulations allow manufacturers seeking an EPA

certificate of conformity to comply with the federal OBD requirements by demonstrating to EPA how the OBD system they have designed to comply with California OBD requirements also meets the intent behind federal OBD requirements, as long as the manufacturer complies with certain certification documentation requirements. EPA has implemented these requirements by allowing a manufacturer to submit an OBD approval letter from CARB for the equivalent engine family where a manufacturer can demonstrate that the CARB OBD program has met the intent of the EPA OBD program. In other words, EPA has interpreted these requirements to allow OBD approval from CARB to be submitted to EPA for approval.

We are proposing to migrate the language from 40 CFR 86.010–18(a)(5) to 40 CFR 1036.110(a) to allow manufacturers to continue to use a CARB OBD approval letter to demonstrate compliance with federal OBD regulations for an equivalent engine family where manufacturers can demonstrate that the CARB OBD program has met the intent of the EPA OBD program. In the case where a manufacturer chooses not to include information showing compliance with additional EPA OBD requirements in their CARB certification package (e.g., not including the additional EPA data parameters in their CARB certification documentation), EPA would expect manufacturers to provide separate documentation along with the CARB OBD approval letter to show they have met all EPA OBD requirements. This process would also apply in the case where CARB has further modified their OBD requirements such that they are different from but meet the intent of existing EPA OBD requirements. For example, if CARB finalizes the use of a different communication protocol than EPA’s requirements call for, as long as it meets the intent of EPA’s communication protocol requirements (e.g., can still be used with a generic scan tool to read certain parameters), the proposed process would apply. EPA expects manufacturers to submit all documentation as is currently required by 40 CFR 86.010–18(m)(3), detailing how the system meets the intent of EPA OBD requirements, why they have chosen the system design, and information on any system deficiencies. As a part of this update to EPA OBD regulations, we are clarifying in 40 CFR 1036.110(c)(4) that we can request that manufacturers send us information needed for us to evaluate how they meet

the intent of our OBD program using this pathway. This would most often mean sending EPA a copy of documents submitted to CARB during the certification process.

#### c. Potential Use of the J1979–2 Communications Protocol

In a February 2020 workshop, CARB indicated their intent to propose allowing the use of Unified Diagnostic Services (“UDS”) through the SAE J1979–2 communications protocol for heavy-duty OBD with an optional implementation as early as MY 2022.<sup>600</sup> CARB stated that engine manufacturers are concerned about the limited number of remaining undefined 2-byte diagnostic trouble codes (“DTC”) and the need for additional DTCs for hybrid vehicles. J1979–2 provides 3-byte DTCs, significantly increasing the number of DTCs that can be defined. In addition, this change would provide additional features for data access that improve the usefulness of generic scan tools to repair vehicles.

Section IV.C.1. of this preamble asks for comment on whether EPA should harmonize with any updated CARB OBD amendments finalized prior to the issuing of this final rulemaking; however, it is not clear if CARB’s amendment including UDS would be finalized in time for EPA to include it in this final rule. We will monitor the development of the CARB OBD update and are seeking comment on whether we should finalize similar provisions if CARB does not finalize their update before we complete this final rule. CARB is expected to allow the optional use of the J1979–2 protocol as soon as MY 2023. If manufacturers want to certify their engine families for nationwide use, we would need to establish a process for reviewing and approving manufacturers’ requests to comply using the alternative communications protocol. While we support adoption of J1979–2 and are clarifying and proposing pathways to accommodate its use, we are seeking comment on potential challenges associated with this change.

While EPA believes our existing requirements in 40 CFR 86.010–18(a)(5) allow us to accept OBD systems using J1979–2 that have been approved by CARB, there may be additional considerations prior to the finalization of this rule for OEMs that want to obtain

<sup>599</sup> EPA Guidance Document CD–2021–04 (HD Highway), April 26, 2021, “Information on OBD Monitoring System Demonstration for Pairs of EPA and CARB Families Identical in All Aspects Other Than Warranty.” Available here: [https://iaspub.epa.gov/otaqpub/display\\_file.jsp?docid=52574&flag=1](https://iaspub.epa.gov/otaqpub/display_file.jsp?docid=52574&flag=1).

<sup>600</sup> SAE J1979–2 was issued on April 22, 2021 and is available here: [https://www.sae.org/standards/content/j1979-2\\_202104/](https://www.sae.org/standards/content/j1979-2_202104/).

<sup>601</sup> CARB Workshop for 2020 OBD Regulations Update, February 27, 2020. Available here: [https://ww3.arb.ca.gov/msprog/obdprog/obd\\_feb2020wspresentation.pdf](https://ww3.arb.ca.gov/msprog/obdprog/obd_feb2020wspresentation.pdf).

a 49-state certificate for engines that do not have CARB OBD approval. For model years prior to MY 2027, since our proposed OBD revisions would take effect in MY 2027 if finalized, EPA is proposing to include interim provisions in 40 CFR 1036.150(v) to allow the use of J1979-2 for manufacturers seeking EPA OBD approval. Finally, once EPA's proposed updated OBD requirements would be in effect for MY 2027, we expect to be able to allow the use of J1979-2 based on the proposed language in 40 CFR 1036.110(b). We are seeking comment on these pathways to approval and on whether any additional changes need to be made to our existing or proposed OBD requirements to accommodate the use of J1979-2.

While there are expected environmental benefits associated with the use of this updated protocol, we are seeking comment on whether the use of this alternative protocol could have negative impacts on our existing OBD program. In addition to potential impacts on EPA's OBD program, EPA is seeking comment on any potential impacts this change could have on our service information requirements (see Section IV.B.3.ii. for more background on these provisions). CAA section 202(m)(4)(C) requires that the output of the data from the emission control diagnostic system through such connectors shall be usable without the need for any unique decoding information or device, and it is not expected that the use of J1979-2 would conflict with this requirement. Further, CAA section 202(m)(5) requires manufacturers to provide promptly to any person engaged in the repairing or servicing of motor vehicles or motor vehicle engines, and the Administrator for use by any such persons, with any and all information needed to make use of the emission control diagnostics system prescribed under this subsection and such other information including instructions for making emission related diagnosis and repairs. Manufacturers who choose to voluntarily use J1979-2 as early as MY 2022 would need to provide access to systems using this alternative protocol at that time and meet all of the relevant requirements in 40 CFR 86.010-18.

EPA believes that the software and hardware changes needed to accommodate J1979-2 are minimal, and that these changes would not impact an OEM's ability to make vehicle data available at a fair and reasonable cost. We seek comment on how tool vendors would be affected, whether they would be able to support the new services and data available in J1979-2, and if there are any concerns tool manufacturers

have regarding access to vehicle data at a fair and reasonable cost.

While the move to UDS has been discussed by OEMs in the past with CARB, a proposal was expected to be released last year, but is now expected this year, and while SAE is working on a new standard, J1978-2 to specify the scan tool requirements to interface with J1979-2, this standard is not yet available.<sup>602</sup> <sup>603</sup> EPA is seeking comment on the impact to generic scan tool manufacturers of the timing of the voluntary allowance for the use of J1979-2 in MY 2023 and whether scan tool manufacturers can provide updated tools for use to diagnose and repair vehicles as well as for inspection and maintenance facilities in time for MY 2023, or if this protocol should not be allowed for use until a later model year and if so what the appropriate timing is. Specifically, EPA is seeking comment on the following issues related to generic scan tools:

- Will vendors be able to meet the MY 2023 timeframe?
- Can existing tools be updated to accommodate the new protocol or do new scan tools need to be developed to utilize J1979-2?
- Will any additional hardware changes be required to accommodate J1979-2?
- Do tool vendors expect the price of tools that can utilize J1979-2 to be comparable to tools that utilize J1979?
- Do state inspection and maintenance facilities require additional time to be able to modify or update equipment to handle J1979-2?
- Will generic scan tools be able to read both J1979-2 and J1979 or will separate tools be required?
- Will generic scan tool functionality be the same or better with the implementation of J1979-2?
- Will users require specialized training to use J1979-2 tools?
- Is development going to be delayed until the adoption of SAE J1978-2?

#### ii. Use of Tailpipe Emission Sensors

EPA is seeking comment on whether and how to allow manufacturers to use onboard emission sensors to help reduce test burden associated with OBD certification. In particular, EPA would like comment on ways to reduce test cell time associated with component threshold testing, such as ways to use NO<sub>x</sub> sensor data instead of test cycle NO<sub>x</sub> measurements (provided those

sensors meet the proper specifications). There are further complications for testing outside of a test cell to demonstrate compliance that need careful consideration (as it is assumed that testing that relies on onboard NO<sub>x</sub> sensors would happen outside of a test cell), including:

- What alternative testing methods are reasonable and would provide assurances that they are creating robust diagnostic systems?
- For what operating conditions and over what time frame should this testing occur?
- What NO<sub>x</sub> values should be considered (*e.g.*, average NO<sub>x</sub> over a certain period of time, or for a particular set of operating conditions?)
- What ambient and vehicle operating conditions should be considered?
- How can this methodology ensure repeatable results?
- How would EPA verify this methodology for compliance assurance?

This type of strategy could potentially reduce compliance costs because it would reduce the amount of emission testing manufacturers need to perform in a test cell during OBD development. We request comment on this and other aspects of the OBD program that could be improved through the use of emissions sensors. EPA is also seeking comment on alternative methods to use onboard emission sensors that could be used to generate and provide real-world data that may enable improved diagnostics, assess the function of emissions critical components and assess the implementation of dynamic AEC inputs. Such a program could be voluntary and provide additional data that could be used in the future to analyze whether changes to the OBD program should be made to improve compliance demonstrations and reduce test cell burden.

#### 3. Cost Impacts

Heavy-duty engine manufacturers currently certify their engines to meet CARB's OBD regulations before obtaining EPA certification for a 50-state OBD approval. We anticipate most manufacturers would continue to certify with CARB and that they would certify to CARB's 2019 updated OBD regulations well in advance of the EPA program taking effect; therefore, we anticipate the incorporation by reference of CARB's 2019 OBD requirements would not result in any additional costs. EPA does not believe the additional OBD requirements described here would result in any significant costs, as there are no requirements for new monitors, new data parameters, new hardware, or new

<sup>602</sup> IM Solutions, IM Solutions OBD Communication Update Webinar, June 10, 2020. Available here: <https://www.obdclearinghouse.com/Files/viewFile?fileID=2239>.

<sup>603</sup> SAE, J1978-2 available here: <https://www.sae.org/standards/content/j1978-2/>.

testing included in this rule. However, EPA has accounted for possible additional costs that may result from the proposed expanded list of public OBD parameters and expanded scan tool tests in the “Research and Development Costs” of our cost analysis in Section V. EPA recognizes that there could be cost savings associated with reduced OBD testing requirements; however, we did not quantify the costs savings associated with proposed changes to the CARB’s OBD testing requirements. We seek comment on our approach to including costs for OBD and the savings associated with each proposed OBD testing modification.

#### D. Inducements

##### 1. Background

The 2001 final rule that promulgated the criteria pollutant standards for MY 2010 and later heavy-duty highway engines included a detailed analysis of available technologies for meeting the new emission standards.<sup>604</sup> Manufacturers ultimately deployed urea-based SCR systems instead of catalyzed particulate traps and NO<sub>x</sub> absorbers as EPA had projected in 2001. SCR is very different from these other emission control technologies in that it requires operators to maintain an adequate supply of diesel exhaust fluid (DEF), which is generally a water-based solution with 32.5 percent urea. Operating an SCR-equipped engine without the DEF would cause NO<sub>x</sub> emissions to increase to levels comparable to having no NO<sub>x</sub> controls at all.

As manufacturers prepared to certify their SCR-equipped engines to the EPA 2010 standards, EPA was concerned that operators might not take the necessary steps to maintain a supply of DEF to keep the emission controls working properly. To address concerns regarding the design and operation of SCR-equipped heavy-duty highway diesel engines and vehicles, between 2007 and 2012 EPA published three guidance documents, two notices and one request for comment in the **Federal Register**, and participated in a joint public workshop with CARB.<sup>605</sup> These documents focused on the following three main categories of relevant regulatory requirements in the context of the use of DEF in SCR-equipped engines: (1) Critical emissions-related

scheduled maintenance requirements, (2) adjustable parameters requirements, and (3) auxiliary emission control device (AECD) requirements. The EPA guidance identify possible approaches to meeting these regulations for heavy-duty diesel engines using SCR systems; however, the approaches were not required to be used and EPA explained that no determination was made in the guidance on whether the engine and vehicle designs that use the approaches are acceptable for certification, since that determination must be made based on the design of particular engines or vehicles. We broadly refer to this engine derate guidance as an inducement policy and design strategy. Throughout this preamble we refer to engine derates that derive from DEF-related triggers as “inducements.” This section discusses the relevant prior development and use of an inducement policy and design strategy for heavy-duty highway vehicles and engines, including comments we received on operators’ experiences with inducements under that strategy in our Advanced Notice of Proposed Rulemaking, principles for updating inducement approaches for heavy-duty highway vehicles and engines, and proposed inducement provisions for heavy-duty highway vehicles and engines.<sup>606</sup>

##### i. DEF Replenishment as Critical Emissions-Related Scheduled Maintenance

EPA regulations at 40 CFR 86.004–25 limit the emission-related scheduled maintenance that may be performed by manufacturers for purposes of durability testing and specify criteria for inclusion in manufacturers’ maintenance instructions provided to purchasers of new motor vehicles and new motor vehicle engines. Of particular relevance here, the regulations in 40 CFR 86.004–25(a)(2) specify that maintenance performed on vehicles, engines, subsystems, or components used in the determination of emission deterioration factors is classified as either emission-related or non-emission-related, and either scheduled or un-scheduled. Emission-related scheduled maintenance must be technologically necessary to assure in-use compliance with the emission standards and must meet the specified allowable minimum maintenance intervals, as provided in 40 CFR 86.004–25(b) (including cross-referenced 40 CFR 86.094–25(b)(7)).<sup>607</sup> Additionally, to ensure that emission

controls used in the durability demonstration do not under-perform in-use as a result of vehicle owners failing to perform scheduled maintenance, manufacturers must show that all critical emission-related scheduled maintenance have a reasonable likelihood of being performed in-use (see 40 CFR 86.004–25(b)(6)(ii)).

In the guidance document Cisd–07–07 signed on March 27, 2007, EPA stated that the use of DEF is consistent with the definition of critical emission-related maintenance and therefore these requirements would apply to the replenishment of the DEF tank. EPA stated that manufacturers wanting to use SCR technology would likely have to request a change to scheduled maintenance requirements per 40 CFR 86.094–25(b)(7), as the existing minimum maintenance intervals were 100,000 miles for medium-duty and 150,000 miles for heavy-duty diesel engines. Following the completion of the guidance, EPA received several requests for new maintenance intervals for SCR-equipped motor vehicles and motor vehicle engines. EPA granted these requests for model years 2009 through 2011 for heavy-duty engines in a notice that was published in the **Federal Register** (74 FR 57671, November 9, 2009). Engine and vehicle manufacturers provided additional requests for new maintenance intervals for vehicles and engines in model years not covered by the November 9, 2009 **Federal Register** notice.

In the November 9, 2009 **Federal Register** notice and the guidance document Cisd–09–04–REVISED (Cisd–09–04R), regarding the requirement that manufacturers must show that all critical emission-related scheduled maintenance have a reasonable likelihood of being performed in-use, the document explained that manufacturers could make such a showing by satisfying at least one of the conditions listed in the then-applicable 40 CFR 86.094–25(b)(6)(ii)(A–F). In particular, the guidance focused on two of the methods in the regulation: (1) Presenting information establishing a connection between emissions and vehicle performance such that as emissions increase due to lack of maintenance the vehicle performance will deteriorate to a point unacceptable for typical driving; and (2) installing a clearly displayed visible signal system approved by EPA to alert the driver that maintenance is due. In the Cisd–09–04R guidance, EPA identified possible approaches to show a reasonable likelihood that DEF in a vehicle’s tank will be maintained at acceptable levels.

<sup>604</sup> 66 FR 5002, January 18, 2001; see Section I of the preamble for more information on the history of emission regulations for this sector.

<sup>605</sup> Kopin, Amy. Memorandum to Docket: EPA–HQ–OAR–2019–0055. Inducement-Related Guidance Documents and Workshop Presentation, October 1, 2021.

<sup>606</sup> See 85 FR 3306.

<sup>607</sup> See Section IV.B.5 for our proposal to migrate and update the maintenance provisions from 40 CFR 86.004–25 and 86.010–38 to 40 CFR 1036.125.

For the first method, CISD-09-04R suggested that performance that deteriorates to a point unacceptable for typical driving would be sufficiently onerous to discourage operation without DEF. EPA suggested in CISD-09-04R that a possible approach could be for the manufacturer to include a derate of the engine's maximum available engine torque of a sufficient magnitude for the operator to notice decreased operation, explaining that a derate of at least 25 percent is likely to be needed for such an effect, and a progression to further degradation to severely restrict operation. For the second method, CISD-09-04R suggested that a clearly displayed visible signal system could include a DEF level indicator, messages in the instrument cluster, a DEF indicator, engine shutdown lamp, or audible warnings to warn the driver that maintenance is due (DEF refill is needed). The CISD-09-04R guidance reiterated that these are possible general approaches to meet the requirement that the critical maintenance is reasonably likely to occur in use, but EPA will evaluate all approaches taken by manufacturers at the time of certification, and such evaluation will be based on the requirements in the regulations.

On January 5, 2012 (77 FR 488), EPA updated and extended its approval of maintenance intervals for the refill of DEF tanks for heavy-duty engines for 2011 and later model years. In a separate rulemaking in 2014, EPA added DEF tank size (which dictates DEF replenishment rate) to the list of scheduled emission-related maintenance for diesel-fueled motor vehicles and motor vehicle engines in 40 CFR 86.004-25(b)(4)(v).<sup>608</sup> We are proposing to migrate this provision into new 40 CFR 1036.115(i).

EPA also added a limitation in 40 CFR 86.004-25(b)(5)(ii) for DEF replenishment (a critical emission-related scheduled maintenance item), requiring that manufacturers must satisfy paragraph (b)(6)(ii)(A) or (F) to be accepted as having a reasonable likelihood of the maintenance item being performed in-use. EPA explained that the criteria in (b)(6)(ii)(B)–(E) were not sufficiently robust for DEF replenishment, and therefore would not be sufficient for demonstrating that DEF replenishment is reasonably likely to occur in use. We are proposing that the proposed inducement requirements in 40 CFR 1036.111 will ensure the reasonable likelihood of DEF

replenishment being performed in-use. EPA is not proposing any changes to DEF refill intervals. We are proposing to exclude the alternative option in (b)(6)(ii)(F) to demonstrate DEF replenishment is reasonably likely to be performed in-use, but are seeking comment on whether this provision should instead be preserved. EPA is otherwise proposing to migrate the provisions in 40 CFR 86.004-25(b)(5)(ii) to 40 CFR 1036.125(a)(1) (section IV.D.3. describes the proposal in detail).

#### ii. DEF as an Adjustable Parameter

EPA regulations in 40 CFR 86.094-22(e) require that manufacturers comply with emission standards over the full adjustable range of “adjustable parameters” and state that we will determine the adequacy of the limits, stops, seals or other means used to inhibit adjustment.<sup>609</sup> For any parameter that has not been determined to be adequately limited, 40 CFR 86.094-22(e) authorizes the Administrator to adjust the parameter to any setting within the physical limits or stops during certification and other testing. In determining the parameters subject to adjustment, EPA considers the likelihood that settings other than the manufacturer's recommended setting will occur in-use, considering such factors as, but not limited to, the difficulty and cost of getting access to make an adjustment; damage to the vehicle if an attempt is made; and the effect of settings other than the manufacturer's recommended settings on engine performance. Adjustable parameters historically included things like physical settings that are controlled by a dial or screw.

In guidance document CISD-07-07, EPA provided clarification that an SCR system utilizing DEF that needs to be periodically replenished would meet the definition set forth in paragraphs 40 CFR 86.094-22(e)(1) and 86.1833-01(a)(1) and could be considered an adjustable parameter by the Agency. EPA is confirming that DEF is considered an adjustable parameter because it is both physically capable of being adjusted and significantly affects emissions. In particular, DEF level and quality are parameters that can physically be adjusted and may significantly affect emissions. SCR system designs rely on storing DEF in a tank located on the vehicle, the operator refilling the tank with quality DEF, and quality DEF being available. This design depends on the vehicle operator being

made aware that DEF needs to be replaced through the use of warnings and vehicle performance deterioration. The EPA guidance CISD-07-07 described that without a mechanism to inform the vehicle operator that the DEF needs to be replaced, there is a high likelihood that the adjustable parameter will be circumvented or exceeded in-use and therefore EPA would not consider the system to be adequately inaccessible or sealed. EPA stated in CISD-07-07 that we would not prescribe a specific driver inducement design, but that the options identified in the guidance could be utilized to demonstrate that the driver inducement design was robust and onerous enough to ensure that engines will not be operated without DEF in the vehicle (e.g., if the operator ignored or deactivated the warning system). In addition, the guidance stated that the driver inducement mechanism should not create undue safety concerns, but should make sure vehicle operators are adding DEF when appropriate by having the vehicle performance degraded in a manner that would be safe but would be onerous enough to discourage vehicles from being operated without DEF. EPA stated that the key challenge of this approach is to determine what would constitute an acceptable performance degradation strategy.

EPA guidance document CISD-09-04R re-emphasized that under the adjustable parameter requirements, EPA makes a determination at certification whether the engine is designed to prevent operation without quality DEF. The guidance suggested a similar strategy for both DEF level and quality could be used, which would alert the operator to the problem and then use a gradually more onerous inducement strategy to either fill the tank or correct the poor-quality DEF and discourage its repeated use. CISD-09-04R also provided more detail on the potential use of inducements with tamper resistant designs to reduce the likelihood that the adjustable parameters will be circumvented in use, noting that in particular, manufacturers should be careful to review the tamper resistance of the system to prevent the disconnection of certain components (e.g., DEF pump or dosing valve). EPA did not determine in CISD-07-07 what specific amount of time or mileage would be necessary for an inducement policy. EPA guidance document CD-13-13 was issued in November 2013 in response to concerns that operators may dilute DEF with water to reduce

<sup>608</sup> 79 FR 46356, August 8, 2014. “Emergency Vehicle Rule—SCR Maintenance and Regulatory Flexibility for Nonroad Equipment.”

<sup>609</sup> Section XII.A.2 describes how we are proposing to update regulatory provisions in 40 CFR 1068.50 related to adjustable parameters.

costs.<sup>610</sup> CD-13-13 provides guidance to manufacturers of heavy-duty on-highway engines on how EPA expects to determine the physical range of adjustment of DEF quality for certification testing. EPA explained that we generally would consider the range of adjustment for emission testing to span the change in urea concentration from 32.5 percent (unadulterated DEF) to the point at which poor DEF quality can be detected. This guidance also provides possible measures manufacturers may take, such as inducements, to sufficiently restrain the adjustment of DEF quality to limit the need for testing outside the manufacturer's specified range. EPA is proposing to adopt certain performance degradation strategy requirements that must be met for EPA to make a determination at certification that the engine is designed to prevent operation without quality DEF under the adjustable parameter requirements (section IV.D.3. describes the proposal in detail).

### iii. DEF Usage and Auxiliary Emission Control Devices (AECs)

In CISC-09-04R EPA discussed that under extreme temperature conditions DEF may freeze and not immediately flow to the SCR system. There are, however, systems and devices that can be utilized to ensure the flow of DEF. These systems are evaluated as AECs (see 40 CFR 86.082-2) and manufacturers must describe this AEC and show that the engine design does not incorporate strategies that reduce emission control effectiveness compared to strategies used during the applicable Federal emissions test procedures. EPA examines systems during certification for ensuring proper dosing during extreme conditions such as cold weather operation. CISC-09-04R provided an example of a test procedure that could be used for ensuring the SCR system has adequate DEF freeze protection. Under this example, SCR systems that are capable of fully functional dosing at the conclusion of the test procedure might be considered acceptable. EPA is not proposing any changes to existing regulatory requirements for AECs or to supersede guidance with our proposed requirements, if finalized, except as explicitly identified in section 40 CFR 1036.111.

<sup>610</sup> Kopin, Amy. Memorandum to Docket: EPA-HQ-OAR-2019-0055. Inducement-Related Guidance Documents, and Workshop Presentation, October 1, 2021.

### iv. Tamper-Resistance Design

The existing EPA guidance and this section discuss inducements as a tamper-resistant design strategy in the context of steps manufacturers can take to prevent operation without quality DEF. Under the CAA, engines must meet emission standards promulgated under section 202(a) throughout useful life. Engines that do not meet those standards throughout useful life may result in increased emissions that fundamentally undermine EPA's emission control program and prevent us from realizing the intended improvements in air quality. Tamper-resistant design in engines can be an important part of a manufacturer's compliance strategy to ensure that emissions standards are met in-use throughout useful life. In addition to the reasons described in the cited guidance documents, an inducement strategy for SCR-system tamper-resistance can be part of a manufacturer's demonstration at certification that engines will be built to meet emission standards in-use throughout useful life.

The Agency believes that combining detection of open-circuit fault conditions for SCR components (*i.e.*, disconnection of SCR components) with inducements would decrease the likelihood that the SCR system will be circumvented through tampering.

### 2. ANPR Comments on the EPA's Inducement Guidance

The ANPR requested comment on EPA's existing guidance related to SCR and DEF. A majority of the comments expressed concern that despite the use of high-quality DEF and in the absence of tampering, in-use vehicles are experiencing inducements for reasons outside of the operator's control. Commenters stated that the reasons for these types of inducements are often difficult to diagnose and can lead to repeat trips to a repair facility and additional costs. Commenters also stated that the existing schedule and speeds are not necessary to achieve EPA's compliance goals, and instead the severe nature of these concerns may be leading to unusual tampering rates. This section summarizes the submitted comments.

Several commenters described problems with repeated occurrences of inducements even with the use of a sufficient quantity of high-quality DEF and in the absence of tampering (*i.e.*, a "false inducement"). They reported that some of these cases were traceable to incidents where the system detected a problem that did not exist and did not create emission concerns, for example a

vehicle with a full DEF tank experienced an inducement due to a faulty DEF level sensor which reported an empty tank. Commenters stated that false inducements can occur, for example, as a result of software glitches, wiring harness problems, minor corrosion of terminals, or faulty sensors, even if those problems have no effect on the function of the emission control system.<sup>611</sup>

Commenters stated that "no trouble found" events were common where repair technicians were unable to diagnose a system fault after the engine triggered an inducement. This condition has also been documented by manufacturers who have issued technical service bulletins ("TSBs") discussing such concerns. EPA has identified a significant number of TSBs documenting in-use problems that cause erratic fault codes which can lead to inducements or engine derate despite operators using high-quality DEF and not tampering.<sup>612</sup> For example, some TSBs describe faulty wire harness routing problems that can cause inducements and recommend fixes that include adding extra zip ties or tape. Commenters noted that erratic system problems can lead to "defensive repairs" as a diagnostic strategy for returning the vehicle to service, which could result in repair expenses for replacing parts that are not faulty and add risk of future costs if the problem reoccurs, repeated tows are required, further diagnosis is done, and more repairs are attempted. Commenters expressed a particular concern for intermittent fault conditions that make diagnosis especially difficult. To alleviate such concerns, ATA commented that EPA should eliminate inducements for reasons other than maintaining an adequate supply of high-quality DEF. ANPR commenters also expressed a concern that technicians might repair a defective part without addressing the root problem that caused the part to fail, which again leads to repeated experiences of towing and repairing to restore an engine to proper functioning.

Commenters stated that, despite their continued diligence to use high-quality DEF, they have repeated experiences with inducements resulting in very onerous costs. Some commenters noted they were subject to the most severe restrictions multiple times per year even though DEF tanks were properly filled.

<sup>611</sup> For example, see the comments of the National Association of Small Trucking Companies, Docket ID EPA-HQ-OAR-2019-0055-0456.

<sup>612</sup> Miller, Neil; Kopin, Amy. Memorandum to docket EPA-HQ-OAR-2019-0055. "TSB Aftertreatment Faults." September 9, 2021.

OOIDA commented that inducement-related costs can severely jeopardize owner-operators' ability to stay in business, citing costs that included towing and lost income from downtime in addition to diagnosis and repair. Commenters were especially concerned with long-distance routes, which might involve a vehicle that is several days distant from the base of operations. Other commenters highlighted that service information and tools should be made easily available and affordable for individual owners to diagnose and fix their own vehicles, which can be important for small businesses, Tribes, and those in rural areas with less ready access to original equipment manufacturer dealer networks.<sup>613</sup> While these comments did not specifically discuss inducements, EPA also considers these comments relevant to vehicles that are in an inducement condition. Other commenters added that false inducements in these situations can necessitate having engines serviced at an unfamiliar repair facility that has no information on a given vehicle's repair history, which can result in improper repairs and increased travel expenses for drivers to return home.<sup>614</sup>

Commenters stated that the four hours of operation before engines reach final inducement is poorly matched with typical wait times of three or four days before repair technicians can look at and attempt to diagnose the problem with their vehicles, plus additional time is needed to complete the repairs. Commenters further stated that repair technicians are often unable to diagnose the problem, repairs can take several days in any case, with additional time lost if there is a need to order parts and wait for shipment, and there are frequently "come-back" repairs for vehicles not fixed properly the first time.

Commenters stated that the money needed for a tow would be better spent on repairs.<sup>615</sup> Some commenters emphasized that a speed restriction of 5 mph caused the need for towing, even though a less restrictive inducement would accomplish the same purpose without incurring towing expenses.

Commenters described experiences of sudden inducements restricting vehicle speed to 5 mph which they stated

caused highway safety problems for truck drivers and nearby vehicles.<sup>616</sup> Others described having safety concerns when a vehicle is stranded, such as having buses carrying passengers parked along the highway or freeway.<sup>617</sup>

Some commenters stated that in addition to monetary costs, there are other business impacts such as missing critical deadlines, loss of customer trust and credibility, and loss of future contracts. Other comments indicate that EPA's existing inducement policy, especially where application of it has resulted in false inducements, may have created a strong incentive to either tamper with SCR systems (*e.g.*, installing "delete kits") and may be leading to owners extending the life of older vehicles; they further asserted that these behaviors were causing trucks to fail to accomplish the intended emission reduction goal. For example, the American Truck Dealers division of National Auto Dealers Association commented that in addition to emission-related maintenance and repair issues, improperly functioning SCR derate maintenance inducements have also led to emissions tampering.<sup>618</sup>

It is worth noting that in comments on CARB's Omnibus rule both the California Trucking Association and ATA member companies requested CARB work with EPA to further investigate the efficacy of progressive de-rate inducements typically associated with low-volume or empty DEF tanks or the use of poor-quality DEF. They added that the safety and environmental implications of these types of de-rate occurrences need additional evaluation and study prior to enacting additional NO<sub>x</sub> controls. Further, they commented that following more than a decade of experience, de-rates not related to low DEF levels or inferior DEF quality continue to occur, and that among a sampling of fleets operating more than 10,000 trucks, nearly 80 percent of de-rates in 2019 were attributed to other causes such as sensor failures, electrical defects and SCR component issues. ATA stated that many of these causes are not associated with the emissions performance of the SCR system and yet are initiating operational restrictions. After the ANPR was issued, EPA received a letter from charter bus companies detailing their concerns and difficulties experienced

with existing inducements. Specifically, they mentioned the inadequate timeframe for which to resolve problems, the safety risk to passengers, the high cost of towing, other costs incurred due to breakdowns such as reimbursements owed for tickets to missed shows or flights, and the cost to their reputation despite their efforts to maintain their fleets and keep the emissions systems functioning properly.<sup>619</sup>

### 3. Principles for Updating Inducement Provisions

In general, emission control technology is integrated into engine and vehicle systems in ways that do not require routine operator interaction. However, ensuring that on-highway engines using SCR are designed, consistent with our regulations, to prevent operation without quality DEF through and dependent upon steps performed by operators in-use presents unique challenges. Crafting an inducement policy includes complex technological questions on how manufacturers should demonstrate that SCR system standards and related requirements will be met and challenging policy decisions on how to appropriately motivate or restrict certain types of human behavior that are either necessary for or directly impact in-use compliance with emissions standards. EPA recognizes and commenters have highlighted that the existing inducement policy and its implementation have resulted in a complex mix of incentives and behaviors. Policymaking for inducements therefore presents itself not as an engineering problem with a single solution.

EPA is proposing to codify inducement provisions, which include adjustments as compared to our existing inducement guidance after consideration of manufacturer designs and operator experiences with SCR. We recognize that SCR technology has continued to mature, and appropriate designs for heavy-duty engines using SCR systems have evolved over the past decade. EPA continues to believe that designing SCR-equipped engines with power derating is an effective and reasonable measure to ensure that operators perform critical emissions-related scheduled maintenance on the SCR system and to demonstrate to EPA that it is reasonable to anticipate, consistent with requirements for

<sup>613</sup> For example, see the comments of the Keweenaw Bay Indian Community, Docket ID AX-20-000-3862.

<sup>614</sup> Miller, Neil; Kopin, Amy. Memorandum to docket EPA-HQ-OAR-2019-0055. "ANPR Inducement Comment Summary." August 5, 2021.

<sup>615</sup> Commenters suggested the cost of a tow starts at \$800, which could approximately cover the cost to replace a faulty NO<sub>x</sub> sensor. Others noted that the cost of a tow and related repairs is estimated to be around \$7500-8000.

<sup>616</sup> For example, see the anonymous comments in Docket ID EPA-HQ-OAR-2019-0055-0426.

<sup>617</sup> See the comments of Theilen Bus Lines, Docket ID EPA-HQ-OAR-2019-0055-0521.

<sup>618</sup> See the comments of the National Automotive American Truck Dealers division of National Auto Dealers Association, Docket ID EPA-HQ-OAR-2019-0055-0369.

<sup>619</sup> Kopin, Amy. Memorandum to docket EPA-HQ-OAR-2019-0055. "Letter to EPA from Bus and Motorcoach Operators Regarding Inducement Experiences In-Use." November 17, 2021.

adjustable parameters, that the engine would normally be operated using quality DEF. We are proposing inducement requirements whose objective is to ensure that emission controls function and emission reductions occur in-use while reducing potential impacts to operators through the consideration of the following key principles.

EPA's inducement approach should result in:

1. Operators maintaining an adequate supply of high-quality DEF while discouraging tampering of SCR systems,

2. a speed derating schedule for inducement that balances impacts to operators while still achieving required emission control,

3. unique inducement schedules for different categories of vehicles that reflect different primary operating conditions to ensure that the final inducement speed is effective while acknowledging operating constraints,

4. ensuring that the inducement condition is warranted,

5. clear communication of SCR system problems to the operator,

6. avoiding the need for intervention at a dealer or other specialized service center where possible, and

7. reduced likelihood of in-use tampering based on a more targeted inducement approach.

Development of regulatory inducement requirements that reflect these key principles requires consideration of potentially competing concerns. A minimally restrictive approach might result in increased emissions because of extensive operation without scheduled maintenance being performed and circumvention of the limit on the adjustable range (*i.e.*, without use of sufficient high-quality DEF). In contrast, an overly restrictive approach might impose unnecessary costs and pose a threat to operators' livelihoods, as well as leading to potentially increased tampering with engines or reduced fleet turnover rates that would lead to increased emissions.

The principles described here are those EPA used to develop the proposed inducement provisions in 40 CFR 1036.111 and are discussed later in this section for heavy-duty engines certified under 40 CFR part 1036 that use SCR systems. These principles are based on our existing guidance but include important adjustments. The first principle is to develop an effective inducement proposal that ensure that all critical emission-related scheduled maintenance has a reasonable likelihood of being performed and allows manufacturers to demonstrate an

acceptable performance degradation strategy at the time of certification to meet adjustable parameter requirements. This principle should result in a proposal that would ensure operators will add high-quality DEF and would help prevent tampering with the SCR system by requiring increased levels of inducement to occur in stages for reasons related to insufficient quantity of high-quality DEF or tampering with the SCR system. This approach creates an immediate and increasing incentive to remedy the problem. Operators would keep tanks full of high-quality DEF prior to the inducement process starting and avoid tampering with the SCR system.

Our second principle seeks to identify an appropriate speed derating schedule for inducements that reflects experience gained over the past decade with SCR. This schedule would better balance impacts to operators while ensuring that all critical emission-related scheduled maintenance has a reasonable likelihood of being performed and allow manufacturers to demonstrate an acceptable performance degradation strategy at the time of certification to meet adjustable parameter requirements. An appropriate inducement speed and schedule should be low enough to ensure that operators maintain a supply of high-quality DEF, while allowing engines to operate at a limited speed over a restricted timeframe that restricts commercial operation (*e.g.*, highway operation) but allows for safely operating the vehicle to return home for repair and to perform the necessary post-repair diagnostic checks to avoid "come-back" repairs. Almost all heavy-duty vehicles are engaged in commercial activity for which it would be completely unacceptable to operate indefinitely at vehicle speeds that do not allow for travel on limited-access highways. This principle should result in an inducement schedule that would allow a reduced level of operation over a sufficient period of time for operators when there is a need to get a driver home from a distance, deliver critical freight (*e.g.*, passengers, livestock, or concrete) or for scheduling repairs in a time or area of limited openings in repair shops. Establishing an inducement policy that would be consistent among manufacturers would improve operator experiences. For example, today manufacturer strategies may differ in ways that potentially may have significant effects on operators (*e.g.*, some manufacturers implement a final severe inducement only after a vehicle is stopped, others implement it immediately while a vehicle is in

motion). EPA believes another important aspect of this principle is to set an inducement schedule that would include additional stages of derated engine power that would be tied to drive-time to create a predictable schedule of increasing incentive to repair the engine. We also believe that our proposed approach, including the proposed inducement speeds and schedules, would be the most effective way to minimize operational disruptions due to potential supply chain problems such as component or DEF shortages.

The third principle is to recognize the diversity of the real-world fleet and that one inducement schedule may not be appropriate for the entire fleet. Instead, separate inducement speeds and schedules should apply to vehicles that primarily operate at low- or high-speeds to ensure an appropriate final inducement is applied. Certain vocational vehicles, such as utility trucks, local delivery vehicles, refuse trucks, cement mixers, and urban buses do not operate fast enough to be effectively constrained by the same inducement speed that would be appropriate for trucks with extended highway driving. Similarly, applying a low final inducement speed to the entire fleet would overly constrain vehicles that spend the majority of their time at highway speeds. Rather than the EPA identifying a different inducement schedule for each type of vehicle, vehicles would be subject to an alternative inducement schedule based on the average vehicle speed history recorded in the onboard computer.

The fourth principle would not apply an inducement if there is a fault code flagged by the system but the SCR system is still controlling NO<sub>x</sub> emissions. Under this principle, putting a vehicle into an inducement for a condition that does not result in a failure of the engine to comply with emission standards would be inconsistent with the goal of an inducement policy. To apply inducements consistent with this principle, manufacturers would design their diagnostic system to override a detected fault condition if NO<sub>x</sub> sensors confirm that the SCR system is in fact appropriately reducing NO<sub>x</sub> emissions. The diagnostic system depends on multiple sensors and complex algorithms to detect fault conditions. This override feature could be helpful to reduce false inducements that can occur when the fault is not due to tampering or the absence of high-quality DEF in the system (*e.g.*, a faulty DEF level sensor in a tank full of DEF). An inducement approach that includes a

backup check would address problems with faulty sensors or part shortages that can strand owners.<sup>620</sup> Under CARB's updated 2019 OBD regulations, which apply under CARB's regulations starting with MY 2023 compliant OBD systems would be able to query data in the most recent "active 100-hour array", which monitors and records the most recent engine and emission control parameters at discrete operating conditions to confirm that appropriate NO<sub>x</sub> reductions are occurring. We are proposing to incorporate by reference these updated CARB OBD requirements and to make them mandatory for MY 2027 and later, while manufacturers could voluntarily choose to certify to these requirements prior to that (see section IV.C.1. for further discussion on OBD).

The fifth principle seeks to improve the type and amount of information operators receive from the truck to help avoid or quickly remedy a problem that is causing an inducement. This could include manufacturers providing information on the dashboard or other display to indicate when the first (and next) stage of derating will start in addition to identifying the current (and next) restricted speed. It is important for operators to understand what is happening to the truck as well as whether or not they can make it back home or to a preferred repair facility and reduce anxiety that can occur when an inducement or engine derate occurs. The indicator would also show the fault condition that caused the inducement. This status information would help to prevent an unsafe condition resulting from an unexpected step down in speed, and it would give operators important information for planning routes to arrange for repairs.

The sixth principle includes allowing operators to perform an inducement reset by using a generic scan tool or allowing for the engine to self-heal through the completion of a drive cycle that will warm up the SCR system to operating temperature and permit the system to automatically reset the inducement condition as appropriate. This approach would allow vehicle owners much more discretion to perform repairs themselves or select appropriate repair facilities for their vehicles. This flexibility becomes increasingly important as vehicles get older, especially for second or third owners, who typically depend on simpler maintenance procedures to keep

operating costs low enough for viable operation. Any system reset that does not follow the fault condition being addressed would require the engine to immediately return to the stage of inducement that applied before the reset, which would address the risk of improper resets. Together with allowing more time to diagnose and repair a vehicle, this provision would help to address comments from Tribal interests stating that Tribes and others operating in remote areas often have limited access to dealers or specialized repair facilities for repairing engines including vehicles that are in an inducement condition. These provisions would increase options available to all vehicle owners and small fleets who perform their own repair and maintenance and may be unable to service their own vehicles if the fault condition occurs any distance from the home base. A higher proposed final inducement speed would also allow the OBD system to run an internal diagnostic check to confirm that the fault condition is no longer active and that the SCR catalyst is again reducing NO<sub>x</sub> emissions. This would be especially important for vehicle owners that do their own repair work on older vehicles or for operators in remote areas with limited access to dealers and specialized tools.

The seventh principle seeks to develop an inducement schedule that will ensure scheduled maintenance has a reasonable likelihood of being performed and allow manufacturers to demonstrate they meet adjustable parameter requirements at the time of certification while addressing operator frustration with false inducements and severe inducement speed restrictions that may potentially lead to in-use tampering of the SCR system. We are concerned that engine designs that may have been intended to be responsive to the existing SCR guidance may have resulted in high levels of false inducement and overly restrictive speed limitations and may have increased in-use tampering.<sup>621</sup> For example, there are many technical support bulletins that have been released by manufacturers that detail inducements occurring for reasons outside of operator control, such as minor corrosion on electrical connectors.<sup>622</sup> In addition, we received comments on the ANPR regarding false inducements leading to emissions

tampering.<sup>623</sup> EPA is aware there are products available in the marketplace to facilitate tampering through the removal of SCR systems, which might be being unlawfully used by vehicle owners who are adversely affected by false inducements. After a decade of experience with SCR-equipped engines and existing EPA guidance, several of the initial concerns with the use of SCR that formed the basis of some elements of the existing guidance have been resolved. DEF is widely available and the cost of DEF at the pump is not that different from the cost of distilled water. A less restrictive approach could be equally effective at encouraging operators to maintain a supply of DEF, without causing problems that may be leading to increased in-use tampering. A less restrictive inducement schedule would allow operators more flexibility for on-time delivery, reduce operator costs by allowing vehicles to be driven to repair shops thereby avoiding towing fees, and allow more time for proper diagnosis and repair to reduce the need for repeat visits to repair shops.

These seven principles, which include improved diagnostic fault communication, NO<sub>x</sub> override checks, and revised inducement speeds and schedules that reflect more realistic vehicle operations, would result in a program that more effectively maintains in-use emission reductions. We believe the proposed provisions described in the following section would provide a net benefit to fleet operators, small businesses, and the environment.

#### 4. Proposed Inducement Provisions

Consistent with the seven principles described in Section IV.D.3. EPA is proposing to specify in 40 CFR 1036.125(a)(1) that manufacturers must meet the specifications in 40 CFR 1036.111 to demonstrate that DEF replenishment is reasonably likely to occur at the recommended intervals on in-use engines and that adjustable parameter requirements will be met. We are proposing to exclude the alternative option in 40 CFR 86.004–25(b)(6)(ii)(F) to demonstrate DEF replenishment is reasonably likely to be performed in use and are seeking comment on whether manufacturers should be allowed to ask for approval to use an alternative method of compliance to meet these requirements. Consistent with the existing guidance, the proposed requirements would codify that SCR-equipped engines must meet critical emission-related scheduled maintenance requirements and limit the

<sup>620</sup> July 10, 2021. De Maris, Russ, "Will a DEF head problem ruin your trip?" Available here: <https://www.rvtravel.com/def-head-problem-ruin-trip/>.

<sup>621</sup> See section IV.D.1. for further discussion on existing inducement guidance documents including: Cisd–07–07 and Cisd–09–04 REVISED.

<sup>622</sup> Miller, Neil; Kopin, Amy. Memorandum to docket EPA–HQ–OAR–2019–0055. "TSB Aftertreatment Faults." September 9, 2021.

<sup>623</sup> See comments from NADA, Docket ID EPA–HQ–OAR–2019–0055–0369.



physically adjustable range under the adjustable parameter requirements by triggering inducements. EPA is proposing to adopt requirements that inducements be triggered for fault conditions including: (1) DEF supply is low, (2) DEF quality does not meet manufacturer specifications, or (3) tampering with the SCR system. EPA is also proposing separate inducement schedules for low- and high-speed vehicles. The proposed inducement requirements would include a NO<sub>x</sub> override to prevent false inducements. EPA is proposing to require manufacturers to improve information provided to operators regarding inducements. The proposal also includes a provision to allow operators to remove inducement conditions after repairing the engine either through the use of a generic scan tool or through a drive cycle to ensure that repairs have been properly made. EPA is proposing that if multiple repeat fault conditions are detected that the inducement schedule would not restart with each new fault.

The proposed inducement provisions include several aspects. The first three described here relate to proposed inducement triggers in 40 CFR 1036.111. First, EPA is proposing to require inducements related to DEF quantity to ensure that high-quality DEF is used, similar to the approach described in our existing guidance. Specifically, we propose that SCR-equipped engines must trigger the start of an inducement when the amount of DEF in the tank has been reduced to a level corresponding to three hours of engine operation.

Second, EPA proposes to require inducements related to DEF quality to ensure that high-quality DEF is used, similar to the approach described in our existing guidance. There was a concern when SCR was first introduced into the market a decade ago that DEF availability may be limited and some operators may choose to use poor quality DEF, or, for example, dilute DEF with water to reduce operating costs. DEF quickly became widely available and today is conveniently available even in pump form (e.g., next to diesel pumps at refueling stations) to refill DEF tanks while refilling diesel tanks. Modern engines are designed with feedback controls to increase or decrease DEF flow as the system detects that a greater or lesser quantity of DEF is needed to supply the amount of urea needed to keep the SCR catalyst working properly or trigger an inducement. This DEF dosing feedback removes any practical incentive for diluting DEF, as any such attempt

would result in more volume of DEF being consumed and trigger an inducement when emissions control is no longer possible. Further, OEMs have made clear to operators that using water without urea would cause extensive engine damage and void the warranty. Today, the per-gallon price of DEF at the pump is closer to the price of a gallon of distilled water. Given an operator's ability to physically adjust DEF quality and the increase in NO<sub>x</sub> emissions that would result if they do so, EPA maintains that DEF quality is an adjustable parameter and is proposing to require inducements when DEF quality fails to meet manufacturer concentration specifications. Due to widespread DEF availability and familiarity with operators, EPA believes operators would readily find and use high-quality DEF to avoid inducements. As discussed in Section IV.D.1.ii, CD-13-13 provides guidance on DEF quality as an adjustable parameter. The guidance states that EPA generally considers the range of adjustment for emission testing to span the change in urea concentration from 32.5 percent (unadulterated DEF) to the point at which poor DEF quality can be detected. This point represents the limit for DEF quality adjustment because it is the first point at which a manufacturer is able to implement inducements to prevent sustained engine or vehicle operation with poor quality DEF. EPA is not proposing changes to this guidance.

Third, EPA is proposing to require inducements to ensure that SCR systems are designed to be tamper-resistant to reduce the likelihood that the SCR system would be circumvented, similar to the approach described in our existing guidance. CISC-09-04R discusses tamper-resistant design with respect to a list of engine components in the SCR system and suggests that manufacturers could design these components to be physically difficult to access in addition to using warnings and inducements if they are disconnected. We are proposing to require monitoring for and triggering of an inducement for tampering with the components listed in CISC-09-04R, as well as for a limited number of other components. Specifically, we are proposing that open-circuit fault conditions for the following components trigger inducements if detected, to prevent disconnection through tampering: (1) DEF tank level sensor, (2) DEF pump, (3) DEF quality sensor, (4) SCR wiring harness, (5) NO<sub>x</sub> sensors, (6) DEF dosing valve, (7) DEF tank heater, and (8) aftertreatment control module (ACM). Monitoring the

DEF tank heater is important to ensure AECD requirements are met. We are not proposing to include the language from CISC-09-04R that such components should be designed to be physically difficult to access because an inducement condition would be triggered upon the unplugging of a component (i.e., an open-circuit condition).<sup>624</sup> Similar to the approach described in CISC-09-04R which specified that disconnection of the SCR wiring harness could trigger inducements as a tamper-resistant design strategy, we are proposing to specify that the ACM also be monitored for disconnection. In addition to proposing to require detection of open-circuit conditions for certain components to prevent tampering, EPA is also proposing to require that manufacturers trigger an inducement for blocked DEF lines or dosing valves similar to the approach described in CISC-09-04R.<sup>625</sup> EPA is proposing that all inducement-related diagnostic data parameters be made available with generic scan tools (see section IV.C.1.iii.b. for further information). Finally, EPA is proposing to require that manufacturers monitor for a missing catalyst (see OBD requirements for this monitor in 13 CCR 1971.1(i)(3.1.6)) and trigger an inducement if this condition is found.

As indicated in ANPR comments summarized in Section IV.D.2, many operators report experiencing false inducements from faulty hardware that are not a result of tampering. These experiences may indicate that the existing triggers for inducements in engines may be too aggressive, or that OEMs may not be able to clearly distinguish between tampering and faulty hardware. EPA reviewed various manufacturer's inducement strategies in their certification documents and compared those to our existing guidance. Some manufacturers have certified engines with nearly 200 different reasons for an engine to go into a derate condition, including nearly 50 reasons for an SCR-related inducement. Many of the derates are for engine protection, and we are not proposing to make any changes to these types of derates. However, we are adopting a list of SCR system inducement triggers for

<sup>624</sup> An Open-Circuit is a fault where the resistance of a circuit has increased to the point where electrical current will no longer flow through it, and is typically caused by a blown fuse, broken wire, or removal of circuit components.

<sup>625</sup> We are proposing in 40 CFR 1036.110(b)(8)(i) that manufacturers notify operators of problems before blockages actually occur to allow operators an opportunity to perform repairs and avoid an inducement.

meeting critical emissions-scheduled maintenance and adjustable parameter requirements that focus on specific emission control components and conditions that owners can control such as disconnecting a DEF pump or other SCR-related emission control hardware. The proposed list includes the tamper-resistance inducement triggers included in C1SD-09-04R as well as additional components. We believe that standardizing the list of tampering inducement triggers would aid owners, operators, and fleets in the repair of their vehicles by reducing the cost and time required to diagnose the reason for inducement.

Fourth, we are proposing separate four-step derate schedules and final inducement speeds for vehicles that operate at low and high speeds as shown in Table IV-13. We are proposing that the application of low-speed inducements (LSI) and high-speed inducements (HSI) be based on an individual vehicle's operating profile. In particular, vehicles that have a stored average vehicle speed below 20 mph during the previous 30 hours of engine operation (not including idle time) would be considered low-speed vehicles and be subject to an LSI. Excluding idle from the calculation of vehicle speed allows us to more effectively evaluate each vehicle's speed profile, not time spent idling, which does not impact the effectiveness of a final inducement speed. EPA chose this speed based on an analysis of real-world vehicle speed activity data from the FleetDNA database maintained by the National Renewable Energy Laboratory (NREL).<sup>626</sup> Our analysis provided us with insight into the optimum way to characterize high-speed and low-speed vehicles in a way to ensure these categories received appropriate inducements that would not be ineffective or overly restrictive.

EPA is proposing to require specific inducement schedules for low-speed and high-speed vehicles. We are proposing to codify progressively increasing inducement derate schedules that allow the owner to efficiently address conditions that trigger inducements. Table IV-13 shows the proposed default four-step inducement schedules in cumulative hours. The time spent in each stage of inducement would include time spent idling. The initial inducement of either 50 mph or 65 mph would apply immediately when the OBD system detects: (1) There is

approximately three hours-worth of DEF remaining in the tank, (2) DEF quality fails to meet manufacturers' concentration specifications, or (3) when certain SCR system tampering events have occurred. The inducement schedule would then step down over time to result in a final inducement speed of either 35 mph or 50 mph depending on individual vehicle operating profiles. In determining the appropriate final inducement speeds for this proposal, EPA also relied in part on analysis of data in the NREL FleetDNA database. Analyzing potential impacts of final inducement speeds based on vehicle applications involves a number of different considerations, beyond how much time a particular application spent at different speeds. For example, the ability to achieve higher speeds may be critical to many different duty cycles and logistics necessary for commercial activities. Inducements are intended to reduce/eliminate the ability to perform work such that operators will replenish the tank with high-quality DEF and not tamper with the SCR system. For example, our data show that combination long-haul vehicles spend nearly almost 40 percent of their driving time over 65 mph. Based on this operation, an inducement speed of 65 mph will cause a significant impact on the ability of the vehicle to be used for commercial purposes, which means that any speed restriction below this threshold is less likely to further incentivize operators to keep emissions systems compliant. In addition, there were other segments that may operate at lower average speeds, but when looking at their duty cycle, it is clear that they depend on being able to complete their work by achieving high rates of speed frequently, although not for sustained periods (e.g., delivery vehicles that return to a warehouse multiple times throughout the day to reload). These vehicles may travel at lower speeds with frequent stop and go operation during delivery but may need to travel on the highway to return to the warehouse in order to complete a certain number of operations in a day. Many vehicle segments in our sample exhibited this type of duty cycle with frequent higher speeds, for example, some single short-haul vehicles that had average speeds under 20 mph had duty cycles that reached 60-70 mph briefly every hour.

We are proposing that the inducement schedules for low- and high-speed vehicles include four stages that ramp down speeds to the final LSI and HSI. The first stepped decrease in speed would apply six hours after the initial inducement, which allows time for

operators to fill the DEF tank and resume operation in a way that allows the engine to confirm a proper DEF supply without starting the next stage of inducement. If the fault code is not resolved, the schedule continues to reduce the vehicle speed by 5 mph increments in two additional stages. One of the considerations in choosing the stepped speed decreases is allowing drivers time to safely adjust to operation at a lower speed while also adequately incentivizing action by vehicle owners and operators, and we are proposing that 5 mph increments achieve this balance. Commenters noted that even small changes in allowable speeds are sufficient incentive to use high quality DEF. Further, we believe the first step of our proposed inducement policy would result in the use of high-quality DEF. The proposed additional time would also allow for the diagnosis and repair of more extensive problems and intermittent conditions.

The low-speed vehicle schedule and the final LSI speed of 35 mph is designed for vehicles such as urban buses, school buses, and refuse haulers that have sustained operation at low speeds, but frequently travel at high speeds. Further, the final LSI speed would also apply to concrete trucks, street sweepers, or other utility vehicles that have low average speeds, but depend on higher speed operation to get to a job site. In part, because of this high-speed operation, the final LSI speed will be effective for compelling operators to properly maintain their aftertreatment systems. The high-speed vehicle schedule and the final HSI speed of 50 mph is designed for vehicles such as long-haul freight trucks that have sustained operation at high speeds. The final restricted speed of 50 mph prevents the vehicle from travel on most interstate highways with state laws regarding impeding traffic and may require the operator to use flashers to warn other vehicles of the reduced speed.

We expect that the proposed derate schedules would be no less effective than the current approach under existing guidance for ensuring operators properly maintain aftertreatment systems and that it would result in lower costs and impacts to operators and ultimately result in lower tampering rates. EPA recognizes that the fleet is very diverse, and believes that applying two inducement schedules and speeds is an effective and reasonable approach that is not too aggressive or too inconsequential to ensure operators maintain compliance. Our analysis and proposed LSI and HSI schedules are intended to achieve the proper balance

<sup>626</sup> Miller, Neil; Kopin, Amy. Memorandum to docket EPA-HQ-OAR-2019-0055. "Review and analysis of vehicle speed activity data from the FleetDNA database." October 1, 2021.

and limit unintended consequences such as increased tampering.

TABLE IV-13—PROPOSED INDUCEMENT SCHEDULES

Engine hours <sup>a</sup>	Maximum speed (mi/hr)	
	Low-speed vehicles	All other vehicles
0 .....	50	65
6 .....	45	60
12 .....	40	55
60 .....	35	50

<sup>a</sup>Hours start counting with the onset of the triggering condition specified in paragraph (b) of this section. For DEF supply, you may program the engine to reset the timer to three hours when the engine detects zero DEF flow.

Sixth, to reduce occurrences of false inducements, the proposed inducement approach would require a warning to be displayed to the operator to indicate a fault, but utilize a NO<sub>x</sub> override feature to prevent false inducement. We are proposing that an inducement would not be triggered if average data from the NO<sub>x</sub> sensor show that the catalyst is reducing NO<sub>x</sub> emissions consistent with stored OBD REAL Bin data within an estimated 10 percent margin of error due to limitations of in-use detection and measurement. A 10 percent reduction in NO<sub>x</sub> conversion efficiency has been selected because the accuracy of the NO<sub>x</sub> measurement can have errors as much as 10–20 percent based on a study conducted by SwRI.<sup>627</sup> This NO<sub>x</sub> sensor error increases as the NO<sub>x</sub> concentration is reduced. Using a 10 percent error is a reasonable threshold based on the work completed by SwRI and considering continuing advances in technology of on-board NO<sub>x</sub> sensors.

For vehicles subject to a HSI, this data would come from Bin 14 which holds data taken during operation at vehicle speeds greater than 40 mph and when the engine power output is greater than 50 percent of rated power. For vehicles subject to a Low Speed Inducement (LSI), this data would come from Bin 13 which holds data taken during operation at vehicle speeds greater than 25 mph and less than or equal to 40 mph and when the engine power output is greater than 50 percent of rated power. This data would indicate whether DEF is present in the system as zero NO<sub>x</sub> reductions would occur without DEF, and data showing reductions consistent with operation

prior to the condition would indicate that the operator is adding high-quality DEF. We propose that the NO<sub>x</sub> sensor data used to evaluate the need for inducement would come from the 100-hour active array, which would be reset at the time an initial inducement trigger occurred. Resetting the array at that time would ensure that the data used to evaluate whether sufficient high-quality DEF is present in the system would be taken after the initial inducement was triggered and not rely on historical data to make the assessment. The OBD system would continue to monitor the fault condition and provide a warning to the operator that an issue should be addressed, but an inducement would not be triggered unless NO<sub>x</sub> performance fell below the threshold of a 10 percent reduction in NO<sub>x</sub> conversion efficiency (e.g., indicating that the operator has not added DEF).

Seventh, as discussed in section IV.D.3, EPA is proposing in 40 CFR 1036.111(f) that manufacturers must display the condition that triggered the pending or active derate and a countdown timer to estimate the time or distance remaining before the next stage of derating. This display requirement would apply even if the engine overrides a detected fault condition based on NO<sub>x</sub> measurements, and the display should indicate that the derates will not apply as long as NO<sub>x</sub> sensors continue to show that emission controls are functioning properly. It is critical that operators have clear and ready access to information regarding inducements to reduce potential anxiety over progressive engine derates (which can lead to motivations to tamper) as well as to allow operators to make informed decisions.

Eighth, we are proposing that the system would remove the inducement and resume unrestricted engine operation once the OBD system detects the condition has been remedied. EPA would also expect manufacturers to enable the system to reset once the problem was repaired. EPA is proposing to require that generic scan tools be able to remove an inducement condition. This would allow owners who repair vehicles outside of commercial facilities to complete the repair without delay (e.g., flushing and refilling a DEF tank where contaminated DEF was discovered). However, if the same fault condition repeats within 80 hours of engine operation (e.g., in response to a DEF quantity fault an owner adds a small but insufficient quantity of DEF), we are proposing that the system would treat the reoccurring fault condition as the same triggering condition and immediately resume the derate at the

same point in the derate schedule where it was last deactivated. In addition, we are proposing that the Active 100 Hour Array would not be reset if an additional fault occurs before the first code is resolved. The 80 hour window should be long enough to prevent operators from applying temporary remedies, but not so long that operators are unfairly held to the schedule for a past fault condition when a new fault occurs. This repeat fault provision would prevent operators from circumventing requirements by not properly addressing the problem.

As discussed in Section IV.C, EPA is seeking comment on whether improvements could be made to OBD to monitor inducement conditions to ensure a false inducement did not occur and to track such inducements and the conditions that trigger them. Having access to additional OBD data for inducement-related conditions can help operators and repair technicians pinpoint and respond to conditions that currently are often leading to reports of ‘no trouble found’ or false inducements.

As noted in ANPR comments, vehicle operators have experienced inducements that do not seem to be keyed to detected fault conditions, and inducements have occurred on a different schedule than anticipated.<sup>628</sup> These problems may be caused by wear conditions, malfunctioning components, or inadequate system logic. Successful implementation of the proposed inducement provisions depends on production of engines that operate according to the engine manufacturers’ designs over a lifetime of in-use operation.

We believe this proposed approach minimizes potential adverse impacts on operators while meeting the fundamental objective that manufacturers design engines to ensure that operators maintain an adequate supply of DEF to keep the SCR emission control system functioning properly.

5. Requests for Comment

We are open to considering a wide range of adjustments to the proposed inducement provisions and request comment on all aspects of the proposal described in this section. We ask that commenters suggesting alternative approaches or specifications consider the principles identified in Section IV.D.3 to inform our development of the

<sup>627</sup> “Heavy-Duty Engine Low-Load Emission Control Calibration, Low Load Test Cycle Development, and Evaluation of Engine Broadcast Torque and Fueling Accuracy During Low-Load Operation.” Low NO<sub>x</sub> Demonstration Program—Stage 2, Christopher A. Sharp, Southwest Research Institute, SwRI Project No. 03.22496, Final Report, May 6, 2020.

<sup>628</sup> See the comments of the American Trucking Associations on the CARB Omnibus Rulemaking, “Proposed Heavy-Duty Engine and Vehicle Omnibus Regulation and Associated Amendments.” Available here: [https://www.arb.ca.gov/lists/com-attach/45-hdomnibus2020-U2EHMQ\\_Q3AGNSegZ1.pdf](https://www.arb.ca.gov/lists/com-attach/45-hdomnibus2020-U2EHMQ_Q3AGNSegZ1.pdf).

proposed provisions. We are interested in any alternative regulatory provisions and any different principles recommended by commenters, as well as commenters' views on how EPA applied the identified principles in developing the proposed inducement provisions.

We are also interested in whether commenters support adoption of inducement provisions that closely follow existing inducement strategies in-use, for example derating to 5 miles per hour within four hours of detecting certain fault conditions and, if so, whether such an approach would meet the principles we described or whether there are other principles that support such an approach.

While we believe the proposed derate schedule would effectively lead every vehicle owner to address certain detected fault conditions within the duration of the specified schedule, we invite comment and relevant information that would help to assess how vehicle operators in a wide variety of vehicle applications would respond to a derate at any specific level of operating speed restriction. Toward that end, we ask for comments in response to the following questions:

- Is the proposed initial speed restriction of 50 (for low-speed vehicles) and 65 miles per hour (for high-speed vehicles) immediately upon detecting a fault condition meaningful? For example, we may consider alternative initial speed restrictions of 40 and 55 mph to focus the operator's attention on addressing the fault condition since the remedy could be as simple as adding DEF or as extensive as making substantial repairs after a thorough diagnosis.
- Is the proposed final speed restriction of 35 (for low-speed vehicles) and 50 miles per hour (for high-speed vehicles) meaningful? For example, we may consider alternative final speed restrictions of 25 and 40 mph.
- Is it appropriate to create a fault condition that triggers inducement three hours before the DEF supply will be depleted? The engine could alternatively be designed to warn the operator when DEF supply is running low and start the inducement when the DEF supply is depleted.
- Is the proposed six hours of non-idle operation the right amount of time for the first stage of inducement to take effect at 50 or 65 miles per hour before progressing to the next stage of derating? A shorter time may be appropriate for simply refilling DEF, but in other situations that may frequently occur, the fault condition causing the inducement

requires diagnosing and repairing a defective component.

- Is the proposed schedule for successive derates after 12 and 60 hours appropriate? We may consider additional steps. As an example, we may also consider a longer schedule involving more time between stages such as 20 and 120 hours. Similarly, we may consider a shorter schedule reducing the time between stages such as 8 and 40 hours.

- Is the proposed 80 hours of operation without repeating a fault condition the appropriate length of time to distinguish between a new fault condition that restarts the inducement schedule at the initial derate speed and a repeated fault condition that resumes the previous inducement at the same point that the system deactivated the derate?

- Is the proposed schedule of derating speeds over time for high-speed vehicles from 65 to 50 miles per hour and from 50 to 35 miles per hour both reasonable and effective? Would a more or less aggressive schedule work to prevent operators from being content with restricted operation to avoid the cost or inconvenience of maintaining SCR systems? We request that commenters also explain whether any information provided would support an adjusted schedule consistent with the principles described in Section IV.D.3.

- Is the proposed average speed of 20 miles per hour over the preceding 30 hours of operation the appropriate threshold speed for a more restrictive derate schedule for low-speed vehicles? Is it appropriate to exclude idle from the low-speed vehicle determination?

- Should a high-speed vehicle that continues to operate at the final inducement speed eventually be treated like a low-speed vehicle if its average speed eventually falls to that level (20 miles per hour) based on its slower operation during inducement? Using the proposed values, this would cause a vehicle to eventually shift from a final inducement speed of 50 miles per hour down to a final inducement speed of 35 miles per hour. This question is fundamentally about whether there are any applications or scenarios for high-speed vehicles for which an inducement at 50 miles per hour (or another final inducement speed for high-speed vehicles in the final rule) is insufficient to compel corrective action.

- Monitoring for tampering due to a blocked DEF line or injector is intended to ensure that the line itself is not crimped or the injector plugged intentionally. However, EPA is aware that urea crystallization can mimic this type of tampering. OEMs can monitor

DEF line and injector pressures and know at what point they consider pressure changes to be indicative of tampering. They should be able to use these pressure readings to indicate that the system is plugging over time and warn operators well in advance of an inducement (see section IV.C.1.iii.2. for more information on this proposal). If practical, should we specify the amount of time that manufacturers should provide operators with advance notice of a blocked DEF line or dosing valve prior to an inducement occurring for those cases where the blockage is caused by plugging due to DEF crystallization as opposed to direct tampering?

We request comment on the proposed set of fault conditions for triggering inducements intended to address the unique aspect of SCR systems that depend on cooperation from vehicle operators. Toward that end, we raise the following questions:

- Is it necessary and appropriate to include DEF concentration as a fault condition, as proposed? There is an established practice of using DEF and engines now have built-in features to prevent diluting DEF or filling DEF tanks with water. Also, with the proposed warranty provisions, owners may be more likely to properly maintain their engines over longer periods, including use of DEF that meets the owner's manual specifications. We request comment on whether this concern about DEF quality continues to justify the additional complexity and the associated risk of false inducements.

- Are the proposed fault conditions of DEF fill level, DEF quality, and tampering associated with the SCR system the proper way to ensure an adequate supply of quality DEF in-use?

- Does the proposal properly define tampering conditions for inducement by identifying conditions that owners can control, such as open-circuit faults for disconnected DEF pump, SCR wiring harness, DEF dosing valve, DEF quality sensors, DEF tank heaters, DEF level sensors, aftertreatment control module, and NO<sub>x</sub> sensors?

- Is there a risk that the engine will incorrectly detect a tampering fault condition based on the specified open-circuit faults? For example, how likely is it that maintenance steps that require disconnecting or disassembling certain components as part of a repair will be identified as tampering? Or, how likely is it that a failing sensor will give an incorrect signal indicating that one of the specified components has been disconnected? The proposal addresses this, at least in part, by including an override feature based on measured

NO<sub>x</sub> emissions before and after the SCR catalyst.

- Should we allow or require additional fault conditions to ensure that SCR systems are working properly? We could identify numerous additional fault conditions based on OBD system monitoring that detects any number of SCR-related components that need to be adjusted or replaced. We have focused the proposal on things that owners can actually control consistent with the original focus of the existing guidance on ensuring an adequate supply of high-quality DEF paired with tamper-resistant SCR systems that focus on open-circuit conditions. We request comment on any additional OBD fault conditions that would be needed to ensure the functionality of the SCR system.

- Should EPA codify the DEF freeze protection guidance that describes how to meet EPA AECD requirements currently described in CD-13-13?

- Should EPA establish an acceptable range of DEF concentration for defining the limits of the inducement fault condition? Inducements for DEF quality are based on the change in urea concentration from 32.5 percent (unadulterated DEF) to the point at which poor DEF quality can be detected and inducements are triggered. Manufacturers design some tolerance into their SCR systems to adapt to and compensate for in-use DEF quality variances instead of triggering an inducement for minor concentration differences. For example, if a vehicle with DEF in the tank has not been driven for some time, some of the water in the DEF can evaporate, leaving a slightly higher concentration of urea in the DEF. We seek comment on the need to clarify in the regulations appropriate DEF quality inducement triggers to ensure that an acceptable tolerance is being designed into SCR systems consistently across manufacturers and that reflects real-world conditions. Further we seek comment on what an acceptable tolerance would be.

The proposed approach for overriding inducements based on NO<sub>x</sub> sensors showing that the SCR catalyst is working properly is an important feature to reduce the risk of false inducements. Operators would see a warning for a fault condition even if the override prevents a speed restriction, which should allow the operator to take the time necessary to address the fault condition. The override should be set at a level of NO<sub>x</sub> conversion efficiency to reliably indicate that an override is appropriate because the detected fault condition in fact does not prevent the SCR catalyst from working according to

design. We request comment on the proposed approach that allows for overriding inducement if the average data from the NO<sub>x</sub> sensor show that the catalyst is reducing NO<sub>x</sub> emissions consistent with stored OBD REAL Bin data within an estimated 10 percent margin of error due to limitations of in-use detection and measurement. Toward that end, we raise the following questions:

- Should the margin of error be more or less than 10 percent? NO<sub>x</sub> conversion efficiency is more stable at higher speed and load conditions and is generally greater than 90 percent, so overriding based on a greater margin of error should still be effective. Fault conditions such as depleted DEF or disconnected aftertreatment would cause NO<sub>x</sub> conversion efficiency to be at or near zero and would quickly impact the NO<sub>x</sub> conversion efficiency value due to the stored data array being reset at the time a trigger is detected. In such cases a less rigorous or stringent threshold value would be sufficient to evaluate the validity of the detected fault condition. Note however that some system defects may allow for partial NO<sub>x</sub> conversion.

- Are the (reset) Active 100 Hour Array and the specified Real Bins 13 and 14 the appropriate data to assess the NO<sub>x</sub> override, as proposed? The selected operating conditions are intended to be most favorable for a stable and repeatable current assessment of NO<sub>x</sub> conversion efficiency. Would the NO<sub>x</sub> override need to account for a wider range of vehicle operation to work properly for the full range of vehicle applications?

- Does the proposed final inducement speed in combination with the provision for NO<sub>x</sub> overrides provide a proper self-healing path for deactivating derates after correcting a fault condition? There are likely times when this may be a preferable option for operators for resolving an inducement instead of relying on scan tools.

EPA is seeking comment on provisions to accommodate equivalent engine families that are identical except for the diagnostic system adjustments needed to meet the different inducement protocols. If finalized, we would count two equivalent engine families as one for the purposes of determining the number of engine families that are subject to OBD demonstration testing requirements for certification. This would be analogous to the way we are proposing to treat engine families that have a California-only federal certificate because of differences such as warranty provisions

(see Section IV.C.2.i.a. for further discussion on this provision).

As described in Section IV.D.1, engine manufacturers have been producing engines for many years with inducement strategies that align with the potential approaches described in EPA guidance. If we replace the guidance documents with regulatory provisions that include new derating specifications, those specifications could be understood to represent an alternative design strategy for meeting the objectives described in guidance relative to requirements for maintenance specifications and adjustable parameters. It may accordingly be appropriate to allow engine manufacturers to modify earlier model year engines to align with the new regulatory specifications. We are not proposing to change the regulation to address this concern. We are seeking comment on whether and how manufacturers might use field-fix practices under EPA's field fix guidance to modify in-use engines with algorithms that incorporate some or all of the inducement provisions we include in the final rule.<sup>629</sup> For example, this approach could potentially allow engine manufacturers to change the final inducement speed from 5 miles per hour to 50 miles per hour over a 60-hour period.

Engine manufacturers may similarly be interested in modifying engines from the current model year by amending the application for certification. See Section XII.B.3 for additional discussion related to amending applications for certification.

Finally, EPA is seeking comment on whether existing manufacturer inducement strategies are causing certain vocational segments to transition from diesel to gasoline powertrains. For example, one school bus manufacturer introduced gasoline-powered buses in late 2016, which appear to have quickly come to represent nearly 25 percent of sales.<sup>630</sup> Another school bus manufacturer has indicated growing interest in alternative fuel powertrains such as gasoline or propane in response to SCR-related maintenance issues and downtime.<sup>631</sup>

<sup>629</sup> "Field Fixes Related to Emission Control-Related Components," EPA Advisory Circular, March 17, 1975.

<sup>630</sup> "Blue Bird delivers its 5,000th gasoline-powered school bus" March 13, 2019. Available here: <https://blue-bird.com/about-us/press-releases/146-blue-bird-delivers-its-5-000th-gasoline-powered-school-bus>.

<sup>631</sup> "Fleet Managers Rethinking Fuel Choice: Many Choosing New Engines That Reduce Budget Pressure and Maintenance Headaches" February 1, 2019. Available here: <https://>

### E. Certification Updates

In an effort to better serve the regulated community, EPA has taken a number of important steps to streamline the data collection processes that manufacturers use to apply for annual certificates of conformity from the agency. These streamlining efforts include numerous modifications and enhancements to improve the user experience, minimize manual data submission processes, and eliminate duplication of effort for manufacturers. Beginning with the overall process, EPA has made user-centered design a central theme when developing systems for manufacturers. Engaging manufacturers before and throughout the development process helps reduce incorrect assumptions about their business needs and ensures that systems are end-user tested for viability. We recently transitioned our compliance information system from the Verify System to a new Engines and Vehicles Compliance Information System (EV-CIS). This new platform incorporates manufacturer feedback and includes updates that help manufacturers work more efficiently while minimizing the need for costly fixes which can lead to rework. Although we have made significant progress to improve the certification process, we welcome comments suggesting additional improvements EPA could consider.

### F. Durability Testing

EPA regulations require that a heavy-duty engine manufacturer's application for certification include a demonstration that the engines will meet applicable emission standards throughout their regulatory useful life. This is often called the durability demonstration. Manufacturers typically complete this demonstration by following regulatory procedures to calculate a deterioration factor (DF). Deterioration factors are additive or multiplicative adjustments applied to the results from manufacturer testing to quantify the emissions deterioration over useful life.<sup>632</sup>

Currently, a DF is determined directly by aging an engine and exhaust aftertreatment system to useful life on an engine dynamometer. This time-consuming service accumulation process requires manufacturers to commit to product configurations well ahead of their pre-production certification testing to complete the

[thomasbuiltbuses.com/bus-advisor/articles/fleet-managers-rethinking-fuel-choice/](https://www.thomasbuiltbuses.com/bus-advisor/articles/fleet-managers-rethinking-fuel-choice/).

<sup>632</sup> See proposed 40 CFR 1036.240(c) and the definition of "deterioration factor" in 40 CFR 1036.801, which are proposed to be migrated and updated from 40 CFR 86.004–26 and 86.004–28.

durability testing so EPA can review the test results before issuing the certificate of conformity. Some manufacturers run multiple, staggered durability tests in parallel in case a component failure occurs that may require a complete restart of the aging process.<sup>633</sup>

EPA recognizes that durability testing over a regulatory useful life is a significant undertaking, which can involve more than a full year of continuous engine operation for Heavy HDE to test to the equivalent of the current useful life of 435,000 miles. Manufacturers have been approved, on a case-by-case basis, to age their systems to between 35 and 50 percent of full useful life on an engine dynamometer, and then extrapolate the test results to full useful life.<sup>634</sup> This extrapolation reduces the time to complete the aging process, but data from a test program shared with EPA show that while engine out emissions for SCR-equipped engines were predictable and consistent, actual tailpipe emission levels were higher by the end of useful life when compared to emission levels extrapolated to useful life from service accumulation of 75 or lower percent useful life.<sup>635</sup> <sup>636</sup> In response to the new data indicating DFs generated by manufacturers using service accumulation less than useful life may not be fully representative of useful life deterioration, EPA worked with manufacturers and CARB to address this concern through guidance for MY 2020 and later engines.

In this section, we describe our proposal to migrate and update the DF provisions for heavy-duty highway engines from their current location in 40 CFR 86.004–26(c) and (d) and 86.004–28(c) and (d) to 40 CFR 1036.245 and 1036.246. While the current DF guidance is specific to SCR-equipped engines, we are proposing to update our DF provisions to apply certain aspects of the current DF guidance to all engine families starting in model year 2027.<sup>637</sup> We also propose that manufacturers

<sup>633</sup> See 40 CFR 1065.415.

<sup>634</sup> See 40 CFR 86.004–26.

<sup>635</sup> U.S. EPA. "Guidance on Deterioration Factor Validation Methods for Heavy-Duty Diesel Highway Engines and Nonroad Diesel Engines equipped with SCR." CD–2020–19 (HD Highway and Nonroad). November 17, 2020.

<sup>636</sup> Truck and Engine Manufacturers Association. "EMA DF Test Program." August 1, 2017.

<sup>637</sup> As noted in Section III.A, the proposed update to the definition of "engine configuration" in 40 CFR 1036.801 would clarify that hybrid engines and powertrains would be part of a certified configuration and subject to all of the criteria pollutant emission standards and other requirements; thus the DF provisions for heavy-duty engines discussed in this subsection would apply to configurations that include hybrid components.

could optionally use these provisions to determine and verify their deterioration factors for earlier model years. As noted in the following section, we propose to continue the option for Spark-ignition HDE manufacturers to request approval of an accelerated aging DF determination, as is allowed in our current regulations (see 40 CFR 86.004–26(c)(2)), though our proposed provision would extend this option to all primary intended service classes. We are not proposing changes to the existing compliance demonstration provision in 40 CFR 1037.103(c) for evaporative and refueling emission standards. As introduced in Section III.E, our proposal would apply refueling emission standards to incomplete vehicles above 14,000 lb GVWR. Incomplete vehicle manufacturers certifying to the refueling emission standards for the first time under this proposal would have the option to use engineering analyses to demonstrate durability using the same procedures that apply for the evaporative systems on their vehicles today.

In Section IV.F.1, we propose two methods for determining DFs in a new 40 CFR 1036.245, including a new option to bench-age the aftertreatment system to limit the burden of generating a DF over the lengthened useful life periods proposed in Section IV.A.3. We also propose to codify the three DF verification options available to manufacturers in the recent DF guidance. As described in Section IV.F.2, the verification options in a new 40 CFR 1036.246 would confirm the accuracy of the DF values submitted by manufacturers for certification. In Section IV.F.3, we introduce a test program to evaluate a rapid-aging protocol for diesel catalysts that we may consider as an option for CI engine manufacturers to use in their durability demonstration.

We request comment on the proposed options for DF determination and verification, including other options we should consider. We further request comment on whether DF testing of the engine is sufficient for hybrid engines and powertrains, or if we should consider additional testing requirements for manufacturers to demonstrate durability of other key components included in a hybrid configuration (e.g., battery durability testing).

As described in Section XII.A.8, we are also proposing to allow manufacturers of nonroad engines to use the procedures described in this section to establish deterioration factors based on bench-aged aftertreatment, along with in-use verification testing.

1. Proposed Options for Determining Deterioration Factor

Accurate methods to demonstrate emission durability are key to ensuring certified emission levels represent real world emissions, and the efficiency of those methods is especially important in light of our proposal to lengthen useful life periods. To address these needs, we are proposing to migrate our existing regulatory options and include a new option for heavy-duty highway engine manufacturers to determine DFs for certification. We note that manufacturers apply these deterioration factors to determine whether their engines meet the duty cycle standards. For MY 2031 and later Heavy HDE, we are proposing separate duty cycle standards at an intermediate useful life, and are further proposing that a separate deterioration factor would apply for the intermediate useful life as well.

Consistent with existing regulations, proposed 40 CFR 1036.245 would allow manufacturers to continue the current practice of determining DFs based on engine dynamometer-based aging of the complete engine and aftertreatment system out to regulatory useful life. In addition, under our proposed new DF determination option, manufacturers would be able to perform dynamometer testing of an engine and aftertreatment system to a mileage that is less than regulatory useful life. Manufacturers would then bench age the aftertreatment system to regulatory useful life and combine the aftertreatment system with an engine that represents the engine family. Manufacturers would run the combined engine and bench-aged aftertreatment for at least 100 hours before collecting emission data for determination of the deterioration factor. Under this option, the manufacturer would propose a bench aging procedure and obtain prior approval from the Agency, which could be a bench aging procedure that is established today (e.g., procedures that apply for light-duty vehicles under 40 CFR part 86, subpart S).

We request comment on the options proposed for DF determination. Specifically, we ask commenters to consider if the proposed new bench-aged aftertreatment option accurately evaluates the durability of the emission-related components in a certified configuration. We are proposing to allow manufacturers to define and seek approval for a less-than-useful life mileage for the dynamometer portion of the bench-aging option. We request comment on the need to define a minimum number of engine hours of dynamometer testing beyond what is

required to stabilize the engine before bench-aging the aftertreatment.<sup>638</sup> We note that EPA’s bench-aging proposal focuses on deterioration of emission control components. We request comment on including a more comprehensive durability demonstration of the whole engine, such as the recent diesel test procedures from CARB’s Omnibus regulation that includes dynamometer-based service accumulation of 2,100 hours or more based on engine class and other factors.<sup>639</sup> We also request comment on whether EPA should prescribe a standardized aging cycle for the dynamometer portion, as was done by CARB in the Omnibus rule.<sup>640</sup> We also request cost and time data corresponding to the current DF procedures, and projections of cost and time for the options proposed in this section at the proposed useful life mileages. As discussed in Section IV.F.3, EPA is currently validating an accelerated aging protocol for heavy-duty diesel engine aftertreatment systems. We expect that if the protocol is validated, manufacturers could choose to use that protocol in lieu of developing their own for approval by EPA.

2. Proposed Options for Verifying Deterioration Factors

In proposed new 40 CFR 1036.246, manufacturers would annually verify an engine family’s deterioration factor for each duty cycle until all DFs are verified at 85 percent of useful life. We propose that a manufacturer could request to apply an approved DF to a future model year for that engine family, using the proposed updates to carryover engine data provisions in 40 CFR 1036.235(d), as long as the carryover data includes DF verification results for the production year of that new model year as specified in proposed 40 CFR 1036.246(b). Since emission performance is expected to be stable early in the life of the engine, we are proposing not to require DF verification in the first two calendar years following

<sup>638</sup> We are proposing to update the definition of “low-hour” in 40 CFR 1036.801 to include 300 hours of operation for engines with NO<sub>x</sub> aftertreatment to be considered stabilized.

<sup>639</sup> California Air Resources Board, “Appendix B-1 Proposed 30-Day Modifications to the Diesel Test Procedures”, May 5, 2021, Available online: <https://ww2.arb.ca.gov/sites/default/files/barcu/regact/2020/hdomnibuslownox/30dayappb1.pdf>, page 54.

<sup>640</sup> California Air Resources Board, “Staff Report: Initial Statement of Reasons for Proposed Rulemaking, Public Hearing to Consider the Proposed Heavy-duty Engine and Vehicle Omnibus Regulation and Associated Amendments,” June 23, 2020, Available online: <https://ww3.arb.ca.gov/regact/2020/hdomnibuslownox/isor.pdf>, page III-80.

a DF determination for an engine family. Starting in the third year, manufacturers would verify the DFs using an in-use engine with a mileage at or greater than 35 percent of the useful life for the original model year of that DF determination. Subsequent years after production would increase minimum mileages in 10 percent increments each year. Table IV-14 presents the minimum age we are proposing for each year after a DF is applied. We note that these are minimum values and manufacturers could complete the testing earlier if they recruit higher-mileage vehicles for verification testing. If a manufacturer is unable to find enough test vehicles that meet the mileage specifications, we propose that they would perform the testing using vehicles with the highest available mileage and describe how they would attempt to test properly qualified vehicles for later years. If this occurs in the eighth year, they would continue testing in future years until all tested vehicles have mileage that is at least 85 percent of the engine’s useful life.

TABLE IV-14—MINIMUM AGE FOR OBTAINING IN-USE ENGINES FOR DF VERIFICATION TESTING

Year of production following the initial model year that relied on the deterioration factors	Minimum engine service accumulation (percent of useful life)
1	None
2	None
3	35
4	45
5	55
6	65
7	75
8 or later	85

We include three testing options in our proposed DF verification provisions. For each option, manufacturers would select in-use engines meeting the criteria proposed in 40 CFR 1036.246(c), including the appropriate minimum mileage corresponding to the production year of the engine family. We request comment on the proposed number of engines to test under each of these three DF verification options, as well as the corresponding pass threshold.

In the first verification option, proposed in new 40 CFR 1036.246(d)(1), manufacturers would test at least two in-use engines over all duty cycles with brake-specific emission standards in 40 CFR 1036.104(a) by removing each engine from the vehicle to install it on an engine dynamometer and measure emissions. Manufacturers would

determine compliance with the emission standards after applying regeneration adjustment factors to their measured results. We propose that the engine family passes the DF verification if 70 percent or more of the engines tested meet the standards for each pollutant over all duty cycles. If a manufacturer chooses to test two engines under this option, both engines would have to meet the standards. We are proposing that the aftertreatment system, including all the associated wiring, sensors, and related hardware or software be installed on the test engine. We request comment on whether EPA should require approval for hardware or software used in testing that differs from those used for production engines and criteria EPA should consider for that approval.

Under our second proposed verification option in new 40 CFR 1036.246(d)(2), manufacturers would perform the testing on-board the vehicle using a PEMS. Manufacturers would bin and report the emissions following the in-use testing provisions in 40 CFR part 1036, subpart E. Compliance would be determined by comparing emission results to the off-cycle standards for each pollutant for each bin after adjusting for regeneration.<sup>641</sup> We propose the PEMS-based verification would require testing of at least five in-use engines to account for the increased variability of vehicle-level measurement. We also propose that the same 70 percent threshold be used to determine a passing result for this option, which is at least four engines if the manufacturer tests the minimum of five engines. In the event that a DF verification fails under the PEMS option, we propose that a manufacturer could reverse a fail determination and verify the DF using the engine dynamometer option in 40 CFR 1036.246(d)(1).

Our third proposed option to verify DF is to measure NO<sub>x</sub> emissions using the vehicle's on-board NO<sub>x</sub> measurement system (*i.e.*, a NO<sub>x</sub> sensor) according to 40 CFR 1036.246(d)(3). We expect manufacturers would only choose this option if they have a well-established infrastructure to access on-board data from a large number of vehicles (*e.g.*, telematics). Manufacturers choosing this option would verify their NO<sub>x</sub> measurement

<sup>641</sup> For Spark-ignition HDE, we are not proposing off-cycle standards; however, for the in-use DF verification options, manufacturers would compare to the duty cycle standards applying a 2.0 multiplier for model years 2027 through 2030, and a 1.5 multiplier for model years 2031 and later, or multipliers consistent with the corresponding medium/high load bin off-cycle standards for CI.

system meets 40 CFR 1065.920(b), is functional within 100 seconds of engine starting, and maintains functionality over the entire shift-day. Due to further uncertainty in measurement accuracy, and the fact that fewer pollutants would be monitored with a NO<sub>x</sub> sensor, we propose the on-board NO<sub>x</sub> measurement system option would require testing 50 percent of the production for that engine family with a 70 percent threshold to pass. Similar to the PEMS option, we propose that a manufacturer could reverse a fail determination and verify the DF using the engine dynamometer option in 40 CFR 1036.246(d)(1).

In the case of a failed result from any of these verification options, we proposed that manufacturers could request approval for a revised DF or retest to determine a new DF, but the affected engine families would not be able to generate emission credits using a DF that failed to pass verification. We propose to allow the manufacturer to continue to certify the engine family for one additional model year using the original deterioration factor to provide time for the manufacturer to change the engine and generate new DFs. We may require manufacturers to certify with revised family emission limits and apply revised DFs to retroactively adjust the family emission limits and recalculate emission credits from previous model years that used the invalidated DF. We note that a DF verification failure may result in an expanded discovery process that could eventually lead to recall under our existing provisions in 40 CFR part 1068, subpart F.

As part of the proposed new DF verification provisions, we include a new 40 CFR 1036.246(c) specifying how to select and prepare engines for testing. We are proposing to allow manufacturers to exclude selected engines from testing if they have not been properly maintained or used and require that the engine must be in a certified configuration, including its original aftertreatment components. Recognizing that manufacturers may schedule maintenance for emission-related components, we request comment on whether restricting engines to those with original components would considerably limit the number of candidate engines for testing.

### 3. Diesel Aftertreatment Rapid Aging Protocol

As discussed in Section IV.F.1, we are proposing that manufacturers could use engine dynamometer testing for less than full useful life in combination with an accelerated catalyst aging protocol in their demonstration of heavy-duty

diesel engine aftertreatment durability through full useful life. EPA has approved accelerated aging protocols for spark-ignition engine manufacturers to apply in their durability demonstrations for many years. While CI engine manufacturers could also propose an accelerated aging protocol for EPA approval, CI engine manufacturers have largely opted to seek EPA approval to use a service accumulation test with reduce mileage and extrapolate to determine their DF.

Other regulatory agencies have promulgated accelerated aging protocols,<sup>642 643</sup> and we are evaluating how these protocols could apply to our heavy-duty highway engine compliance program. EPA is in the process of validating a protocol that CI engine manufacturers could potentially choose to use in lieu of developing their own protocol as proposed in 40 CFR 1036.245. This validation program for a diesel aftertreatment rapid-aging protocol (DARAP) builds on existing rapid-aging protocols designed for light-duty gasoline vehicles (64 FR 23906, May 4, 1999) and heavy-duty engines.<sup>644</sup>

The objective of this validation program is to artificially recreate the three primary catalytic deterioration processes observed in field-aged aftertreatment components: Thermal aging based on time at high temperature, chemical aging that accounts for poisoning due to fuel and oil contamination, and deposits. The validation program has access to three baseline engines that were field-aged to the current useful life of 435,000 miles. For comparison, we are aging engines and their corresponding aftertreatment systems using our current, engine dynamometer-based durability test procedure. We are also aging the catalyst-based aftertreatment systems using a burner<sup>645</sup> in place of an engine. The validation test plan compares emissions at the following approximate intervals: 0 percent, 25 percent, 50 percent, 75 percent, and 100 percent of the current useful life of 435,000 miles.

<sup>642</sup> California Air Resources Board. California Evaluation Procedure For New Aftermarket Diesel Particulate Filters Intended As Modified Parts For 2007 Through 2009 Model Year On-Road Heavy-Duty Diesel Engines, March 1, 2017. Available online: <https://ww3.arb.ca.gov/regact/2016/aftermarket2016/amprcert.pdf>.

<sup>643</sup> European Commission. Amending Regulation (EU) No 583/2011, 20 September 2016. Available online: <https://eur-lex.europa.eu/legal-content/EN/TXT/PDF/?uri=CELEX:32016R1718&from=HU>.

<sup>644</sup> Eakle, S and Bartley, G (2014), "The DAAAC Protocol for Diesel Aftertreatment System Accelerated Aging".

<sup>645</sup> A burner is a computer controlled multi-fuel reactor designed to simulate engine aging conditions.



We include more details of our DARAP test program in a memo to the docket.<sup>646</sup>

The DARAP validation program is currently underway, and we have completed testing of one engine through the current useful life. Our memo to the docket includes a summary of the preliminary validation results from this engine. We will docket complete results from our validation program in a final report for the final rule. If the validation is successful, we would likely include an option for manufacturers to reference this protocol for DF determination and streamline approval under proposed 40 CFR 1036.245(b)(2). We request comment on improvements we should consider for the protocol outlined in our memo to the docket, including whether EPA should prescribe a standardized aging cycle, as was done by CARB in the Omnibus rule, for input to the DARAP.<sup>647</sup> We also request comment on the current proposal to require approval to use DARAP or if EPA should codify this protocol as a test procedure.

#### G. Averaging, Banking, and Trading

EPA established an averaging, banking, and trading (ABT) program for heavy-duty engines in 1990 (55 FR 30584, July 26, 1990). By offering the opportunity to use ABT credits and additional flexibilities we can design progressively more stringent standards that help meet our emission reduction goals at a faster and more cost-effective pace.<sup>648</sup> In Section III, we show that the proposed standards are feasible without the use of credits. However, we see value in maintaining an ABT program to provide flexibility for manufacturers to spread out their investment and prioritize technology adoption in the applications that make the most sense for their businesses during the transition to meeting new standards. An ABT program is also an important foundation for targeted incentives that we are proposing to encourage manufacturers to adopt advanced technology in

advance of required compliance dates.<sup>649</sup>

In Section IV.G.1, we introduce our proposal to continue allowing averaging, banking, and trading of NO<sub>x</sub> credits generated against applicable heavy-duty engine NO<sub>x</sub> standards. We also propose targeted revisions to the current ABT approach to account for specific aspects of the broader proposed program, which include discontinuing a credit program for HC and PM and new provisions to clarify how FELs apply for additional duty cycles. We recognize that ABT allows manufacturers to use generated emission credits (from engines produced with emission levels below the standards) to produce engines with emission levels above the standards. To limit the production of new engines with higher emissions than the standards, we are proposing restrictions for using emission credits generated in model years 2027 and later that include averaging sets (Section IV.G.2), FEL caps (Section IV.G.3), and limited credit life (Section IV.G.4). We are also proposing that credits generated as early as MY 2024 against current criteria pollutant standards could only be used in MY 2027 and later if they meet proposed requirements for the generation of transitional credits (Sections IV.G.5 and IV.G.6).

The existing ABT provisions that apply for GHG standards in 40 CFR part 1036, subpart H, were adapted for the Phase 1 GHG rulemaking from earlier ABT provisions for HD engines (*i.e.*, 40 CFR 86.007–15).<sup>650</sup> In this rulemaking and described in this section, we are proposing to revise 40 CFR part 1036, subpart H, to also apply for criteria pollutant standards.<sup>651</sup> We are also proposing a new paragraph at 40 CFR 1036.104(c) to specify how the ABT provisions would apply for MY 2027 and later heavy-duty engines subject to the proposed criteria pollutant standards in 40 CFR 1036.104(a). The proposed interim provision in 40 CFR 1036.150(a)(1) describes how manufacturers could generate credits in MY 2024 through 2026 that could be applied in MY 2027 and later.

We request comment on our proposed revisions to the ABT program. As discussed further below, we are particularly interested in stakeholder feedback on alternative approaches to accounting for multiple standards and

duty cycles, as well as our proposed approaches for restricting the use of credits that are generated for use in MY 2027 and later.

#### 1. Multiple Standards and Duty Cycles

Heavy-duty compression-ignition engine manufacturers currently must certify to FTP, SET, and off-cycle standards.<sup>652</sup> Based on FTP and SET test results, CI engine manufacturers participating in the ABT program declare FELs in their application for certification. Spark-ignition engine manufacturers that are only subject to FTP standards may also declare FELs based on the FTP duty cycle testing. An FEL replaces the standard and the manufacturer agrees to meet that FEL whenever the engine is tested over the FTP or SET duty cycle—whether for certification or a selective enforcement audit. The current NTE standards apply in-use whenever a CI engine is operating within the NTE applicability limits and are equal to 1.5 times the FTP and SET standards. The same 1.5 adjustment factor applies to the declared FEL for CI engine manufacturers participating in ABT.

We are not proposing changes to the following aspects of the ABT program currently specified in 40 CFR 86.007–15:

- Allow ABT credits for NO<sub>x</sub>
- Calculate NO<sub>x</sub> credits based on a single NO<sub>x</sub> Family Emission Limit (FEL) for an engine family
- Specify FELs to the same number of decimal places as the applicable standards
- Apply FEL caps for NO<sub>x</sub> to constrain maximum values for FELs
- Calculate credits based on the work and miles of the FTP cycle
- Limit credits to four averaging sets corresponding to the four primary intended service classes (detailed in Section IV.G.2)

As discussed in Section III, we are proposing to revise HC and PM standards for heavy-duty engines to levels that are feasible without the use of credits. We are proposing not to allow averaging, banking, or trading for HC (including NO<sub>x</sub>+NMHC) or PM for MY 2027 and later engines. This includes not allowing HC and PM emissions credits from prior model years to be used for MY 2027 and later engines. For engines certified to MY 2027 or later standards, manufacturers must demonstrate in their application for certification that they meet the proposed

<sup>646</sup> Memorandum to Docket EPA–HQ–OAR–2019–0055: “Diesel Aftertreatment Rapid Aging Program”. George Mitchell. May 5, 2021.

<sup>647</sup> California Air Resources Board, Staff Report: Initial Statement of Reasons for Proposed Rulemaking, “Public Hearing to Consider the Proposed Heavy-duty Engine and Vehicle Omnibus Regulation and Associated Amendments,” June 23, 2020. <https://ww3.arb.ca.gov/regact/2020/hdomnibuslownox/isor.pdf>, page III–80.

<sup>648</sup> See *NRDC v. Thomas*, 805 F. 2d 410, 425 (D.C. Cir. 1986) that upheld emissions averaging after concluding that “EPA’s argument that averaging will allow manufacturers more flexibility in cost allocation while ensuring that a manufacturer’s overall fleet still meets the emissions reduction standards makes sense”.

<sup>649</sup> See Section IV.H for our proposed early adoption incentives.

<sup>650</sup> 76 FR 57127 and 57238, September 15, 2011.

<sup>651</sup> Our proposal does not include substantive revisions to the existing GHG provisions in 40 CFR 1036, subpart H; our proposed revisions clarify whether paragraphs apply for criteria pollutant standards or GHG standards.

<sup>652</sup> As discussed in Section III, the current standards use the same numeric value for the FTP and SET cycles. The Not to Exceed (NTE) standard is an off-cycle standard that applies when an engine is not on a defined laboratory test cycle.

PM, HC, and CO emission standards in 40 CFR 1036.104(a) without using emission credits.

While we continue to consider the FTP duty cycle the appropriate reference cycle for generating NO<sub>x</sub> emission credits, we are proposing new provisions to ensure the NO<sub>x</sub> emission performance over the FTP is proportionally reflected in the range of cycles that we are proposing for these heavy-duty engines. Specifically, we propose that manufacturers would declare an FEL to apply for the FTP standards and then they would calculate a NO<sub>x</sub> FEL for the other applicable cycles by applying an adjustment factor based on their declared FEL<sub>FTP</sub>.<sup>653</sup> We propose the adjustment factor be a ratio of the declared NO<sub>x</sub> FEL<sub>FTP</sub> to the FTP NO<sub>x</sub> standard to scale the NO<sub>x</sub> FEL of the other duty cycle or off-cycle standards.<sup>654</sup> For example, if a manufacturer declares an FEL<sub>FTP</sub> of 30 mg NO<sub>x</sub>/hp-hr in MY 2031 for a Heavy HDE, where the proposed NO<sub>x</sub> standard is 40 mg/hp-hr, a ratio of 30/40 or 0.75 would be applied to calculate a FEL to replace each NO<sub>x</sub> standard that applies for these engines in the proposed 40 CFR 1036.104(a). Specifically, for this example, a Heavy HDE manufacturer would replace the intermediate and full useful life standards for SET, LLC, and the three off-cycle bins with values that are three-quarters of the proposed standards. For an SI engine manufacturer that declares an FEL<sub>FTP</sub> of 15 mg NO<sub>x</sub>/hp-hr compared to the proposed MY 2031 of 20 mg/hp-hr, a ratio of 15/20 or 0.75 would be applied to the SET duty cycle standard to calculate an FEL<sub>SET</sub>. Note that an FEL<sub>FTP</sub> can also be higher than the NO<sub>x</sub>

standard in an ABT program if it is offset by lower-emitting engines in an engine family that generates equivalent or more credits in the averaging set. For an FEL higher than the NO<sub>x</sub> standard, the adjustment factor would proportionally increase the emission levels allowed when manufacturers demonstrate compliance over the other applicable cycles.<sup>655</sup>

Under the current and proposed ABT provisions, FELs serve as the emission standards for the engine family for the respective testing. In our proposal, manufacturers would include test results to demonstrate their engines meet the declared and calculated FEL values for all applicable cycles (see proposed 40 CFR 1036.240(a)). CI engine manufacturers participating in ABT would use the FELs calculated for the off-cycle bins to replace the standards in the in-use testing provisions proposed in 1036, subpart E and PEMS-based DF verifications in the proposed 40 CFR 1036.246(2).<sup>656</sup> We expect manufacturers would base their final FEL<sub>FTP</sub> for credit generation on their engine family's emission performance on the most challenging cycle. For instance, if a CI engine manufacturer demonstrates NO<sub>x</sub> emissions on the FTP that is 25 percent lower than the standard but can only achieve 10 percent lower NO<sub>x</sub> emissions for the low load cycle, the declared FEL<sub>FTP</sub> would be based on that 10 percent improvement to ensure the proportional FEL<sub>LLC</sub> would be met. For the duty cycle standards at intermediate useful life, we are proposing that the DF determination data at the equivalent intermediate useful life mileage serve as a demonstration of emission control

performance for certification. For off-cycle standards, we are proposing that manufacturers may attest, rather than demonstrate, that all the engines in the engine family comply with the proposed off-cycle emission standards for all normal operation and use (see the proposed 40 CFR 1036.205(p)) in their application for certification.

Once FEL values are established, credits are calculated based on the FTP duty cycle. We are not proposing substantive revisions to the equation that applies for calculating emission credits in 40 CFR 1036.705, but we are proposing to update the variable names and descriptions to apply for both GHG and criteria pollutant calculations.<sup>657</sup> In Equation IV-1, we reproduce the equation of 40 CFR 1036.705 to emphasize how the FTP duty cycle applies for NO<sub>x</sub> credits. Credits are calculated as megagrams (*i.e.*, metric tons) based on the emission rate over the FTP cycle. The emission credit calculation represents the emission impact that would occur if an engine operated over the FTP cycle for its full useful life. The difference between the FTP standard and the family limit (*i.e.*, FEL for criteria pollutants) is multiplied by a conversion factor that represents the average work performed over the FTP duty cycle to get the per-engine emission rate over the cycle. This value is then multiplied by the production volume of engines in the engine family and the applicable useful life mileage. Credits are calculated at the end of the model year using actual production volumes for the engine family. The credit calculations are submitted to EPA as part of a manufacturer's ABT report (see 40 CFR 1036.730).

#### Equation IV-1

$$NO_x \text{ Emission Credit} = (Std_{FTP} - FEL) \cdot \frac{Work_{FTP}}{Miles_{FTP}} \cdot Volume \cdot UL \cdot (10^{-9})$$

Where:

Std<sub>FTP</sub> = the FTP duty cycle NO<sub>x</sub> emission standard, in mg/hp-hr, that applies for engines not participating in the ABT program

FEL = the engine family's FEL for NO<sub>x</sub>, in mg/hp-hr.

Work<sub>FTP</sub> = the total integrated horsepower-hour over the FTP duty cycle.

Miles<sub>FTP</sub> = the miles of the FTP duty cycle. For Spark-ignition HDE, use 6.3 miles. For Light HDE, Medium HDE, and Heavy HDE, use 6.5 miles.

Volume = the number of engine eligible to participate in the ABT program within the

given engine family during the model year, as described in 40 CFR 1036.705(c).

UL = the useful life for the standard that applies for a given engine family, in miles.

#### 2. Averaging Sets

EPA has historically allowed averaging, banking, and trading only

<sup>653</sup> Our proposed approach for calculating a NO<sub>x</sub> FEL is similar to the current approach for NTE standards; see Section III.C.1 for more description of the current NTE standards.

<sup>654</sup> We are proposing to require manufacturers to declare the NO<sub>x</sub> FEL for the FTP duty cycle in their application for certification. Manufacturers and EPA will calculate FELs for the other applicable cycles using the procedures specified in 40 CFR 1036.104(c)(3) to evaluate compliance with the

other cycles; manufacturers would not be required to report the calculated FELs for the other applicable cycles. As noted previously, manufacturers would demonstrate they meet the standards for PM, CO, and HC and would not calculate or report FELs for those pollutants.

<sup>655</sup> We are proposing in 40 CFR 1036.104(c) that manufacturers meet the PM, HC, and CO emission standards without generating or using credits; they

would not be required to calculate PM, HC, and CO FELs as is proposed for NO<sub>x</sub>.

<sup>656</sup> We are not proposing off-cycle standards for SI engines; SI engine manufacturers opting for PEMS-based DF verification in the proposed 40 CFR 1036.246(2) would use their FEL to calculate the effective in-use standard for those procedures.

<sup>657</sup> The emission credits equations in the proposed 40 CFR 1036.705 and the current 40 CFR 86.007-15(c)(1)(i) are functionally the same.

within specified “averaging sets” for its heavy-duty engine emission standards. This restriction is in place to avoid creating unfair competitive advantages or environmental risks due to credit inconsistency.<sup>658</sup> We propose to continue this approach, using engine averaging sets that correspond to the four primary intended service classes,<sup>659</sup> namely:

- Spark-ignition HDE
- Light HDE
- Medium HDE
- Heavy HDE

As discussed in Section IV.I, we are proposing that manufacturers could certify battery-electric and fuel cell electric vehicles to generate NO<sub>x</sub> emission credits. Manufacturers would include battery-electric and fuel cell electric vehicles in an averaging set based on a manufacturer-declared primary intended service class considering the GVWR of the vehicle.<sup>660</sup>

### 3. FEL Caps

EPA has historically capped FELs for a new criteria pollutant standard at the level of the previous emission standard to avoid engine technologies backsliding. FEL caps limit the amount that an individual engine can emit above the level of emission standard when manufacturers choose to use emission credits to comply with the standard. Without a FEL cap, manufacturers could choose to use emission credits to produce engines that emit at any numeric level for which they had sufficient credits, whereas, with a FEL cap in place, EPA can constrain the level of emissions from engines that are certified with the use of credits. By setting the FEL cap at the level of the previous emission standard EPA can ensure that all engines must at least maintain the current level of emission control performance.

In this section, we are proposing a new approach to setting FEL caps. We believe FEL caps continue to be critical to avoid backsliding through use of emission credits. Considering our proposal to allow manufacturers to

include BEVs or FCEVs in the NO<sub>x</sub> ABT program, we believe FEL cap levels below the previous standard are appropriate. The zero-tailpipe emissions performance of BEVs and FCEVs inherently provides the opportunity for manufacturers to generate more credits from these vehicles relative to conventional engines that produce emissions between zero and the level the standard. We believe that lower FEL caps would provide a necessary constraint on allowable emission levels from CI and SI engines that would use NO<sub>x</sub> credits generated from BEVs or FCEVs. See Section IV.I for more discussion on our proposal to allow manufacturers to generate NO<sub>x</sub> emission credits from BEVs and FCEVs.

As specified in the proposed 40 CFR 1036.104(c)(2), the maximum NO<sub>x</sub> FEL<sub>FTP</sub> values for model year 2027 through 2030 under proposed Option 1, or model year 2027 and later under proposed Option 2, would be 150 mg/hp-hr, which is consistent with the average NO<sub>x</sub> emission levels achieved by recently certified CI engines (see Chapter 3.1.2 of the draft RIA). We believe a cap based on the average NO<sub>x</sub> emission levels of recent engines is more appropriate than a cap at the current standard of 0.2 g/hp-hr (200 mg/hp-hr) when considering the potential for manufacturers to apply NO<sub>x</sub> credits generated from electric vehicles for the first time. For MY 2031 and later under Option 1, we propose a consistent 30 mg/hp-hr allowance for each primary intended service class applied to each full useful life standard. For Spark-ignition HDE, Light HDE, and Medium HDE, this proposed allowance would equate to a NO<sub>x</sub> FEL<sub>FTP</sub> cap of 50 mg/hp-hr compared to the proposed full useful life standard of 20 mg/hp-hr. Heavy HDE would have a separate NO<sub>x</sub> FEL<sub>FTP</sub> cap of 70 mg/hp-hr compared to the proposed 40 mg/hp-hr full useful life standard. For MY 2031 and later FEL caps under Option 1, we are proposing a 30 mg/hp-hr allowance in lieu of the proposed Option 1 MY 2027 standard of 35 mg/hp-hr for two reasons. First, we do not believe a 15 mg/hp-hr differential between the MY 2031 and MY 2027 standards would provide an appropriate incentive for Spark-ignition HDE, Light HDE, and Medium HDE manufacturers to develop advanced technologies in early model years. Second, the MY 2031 standard for Heavy HDE is higher than the MY 2027 standard to reflect deterioration over the longer useful life.

We request comment on our proposed FEL caps, including our approach to

base the cap for MY 2027 through 2030 under Option 1, or MY 2027 and later under Option 2, on the recent average NO<sub>x</sub> emission levels. We request comment on whether the NO<sub>x</sub> FEL<sub>FTP</sub> cap in MY 2027 should be set at a different value, ranging from the current federal NO<sub>x</sub> standard of 205 mg/hp-hr to the 50 mg/hp-hr standard that will be in place for engines subject to CARB’s HD Omnibus rule starting in MY 2024.<sup>661</sup> We also request comment on the proposal to set the proposed Option 1 MY 2031 NO<sub>x</sub> FEL caps at 30 mg/hp-hr above the full useful life standards. We request comment on whether different FEL caps should be considered if we finalize standards other than those proposed (*i.e.*, within the range between the standards of proposed Options 1 and 2 as described in the feasibility analysis of Section III).

### 4. Credit Life for Credits Generated for Use in MY 2027 and Later

In the original heavy-duty criteria pollutant ABT program (55 FR 30584, July 26, 1990), the recent Phase 2 heavy-duty GHG rulemaking (81 FR 73638, October 25, 2016), and the current CARB HD Omnibus rulemaking, a limited credit life was adopted to help encourage continued technology development to meet the proposed standards. We are proposing to update the existing credit life provisions in 40 CFR 1036.740(d) to apply for both CO<sub>2</sub> and NO<sub>x</sub> credits. As specified in the proposed 40 CFR 1036.740(d), NO<sub>x</sub> emission credits generated for use in MY 2027 and later could be used for five model years after the year in which they are generated.<sup>664</sup> For example, credits generated in model year 2025 could be used to demonstrate compliance with emission standards through model year 2030.

<sup>661</sup> California Air Resources Board, Staff Report: Initial Statement of Reasons for Proposed Rulemaking, “Public Hearing to Consider the Proposed Heavy-duty Engine and Vehicle Omnibus Regulation and Associated Amendments,” June 23, 2020. <https://ww3.arb.ca.gov/regact/2020/hdomnibuslownox/isor.pdf>, page III-4.

<sup>662</sup> Note that the current g/hp-hr emission standards are rounded to two decimal places, which allow emission levels to be rounded down by as much as 5 mg/hp-hr.

<sup>663</sup> As noted in Section I.D, EPA is reviewing a waiver request under CAA section 209(b) from California for the Omnibus rule; we may include consideration of engines meeting the Omnibus requirements as one of the factors in our determination of an appropriate FEL cap level for the final EPA rule.

<sup>664</sup> This includes credits generated by BEVs or FCEVs for use in MYs 2027 and later, as discussed in Section IV.I.

<sup>658</sup> 66 FR 5002 January 18, 2001 and 81 FR 73478 October 25, 2016.

<sup>659</sup> Primary intended service class is defined in 40 CFR 1036.140, which is referenced in the current 40 CFR 86.004-2.

<sup>660</sup> As specified in the proposed 40 CFR 1037.102(b)(1), battery-electric and fuel cell electric vehicles would certify to standards in the following engine categories: Light HDE, Medium HDE and Heavy HDE, and as such would only generate NO<sub>x</sub> emission credits in these averaging sets. The same restrictions would apply to averaging, banking, or trading these credits only within the averaging set in which they are generated (see the proposed 40 CFR 1036.741)

We are not proposing an expiration date for the ABT program, and manufacturers could continue to generate credits by adopting increasingly advanced technologies. However, we do not see a need for manufacturers to bank credits generated in a given model year indefinitely. We recognize the need to allow enough time for manufacturers to apply credits generated early to cover the transition to the more stringent standards of proposed Option 1 for MY 2031. We believe a five-year credit life adequately covers a transition period for that option, while continuing to encourage technology development in later years. We are not proposing to migrate 40 CFR 86.004–15(c)(1)(ii) that specifies a discount for credits that are banked or traded. Discounted credits were originally included to incentivize manufacturers to adopt new technology instead of relying on the use of older credits (62 FR 54703, October 21, 1997). We believe the proposed five-year credit life would provide the same incentive as a credit discount. We request comment on our proposed five-year credit life.

#### 5. Existing Credit Balances

Under the current HDE criteria pollutant ABT program, manufacturers have generated NO<sub>x</sub> emission credits with an unlimited credit life but have not used the credits in recent years. While emission credits generated prior to MY 2027 could continue to be used to meet the existing emission standards through MY 2026 under 40 CFR part 86, subpart A, we are proposing that these banked credits could not be used to meet the proposed MY 2027 and later standards for two reasons.

First, the credits were generated without demonstrating emissions control under all test conditions of the proposed program, and thus are not equivalent to credits that would be generated under the proposed program. Specifically, the existing credits were generated without demonstrating emission control on the proposed SET duty-cycle standard for SI engines, or the proposed low-load duty-cycle standard and proposed off-cycle standards and test procedures for CI engines. Second, EPA did not rely on the use of existing credit balances to demonstrate feasibility of the proposed standards (see Section III).

Taken together, these two factors lead us to believe that it would not be appropriate to allow the unlimited use in the proposed new NO<sub>x</sub> compliance program of credits generated under the existing program. We are proposing a new interim provision in 40 CFR 1036.150(a) that includes the options for

manufacturers to bank credits for use in MY 2027 and later. In paragraph (a)(1), we are proposing provisions to allow manufacturers to generate transitional NO<sub>x</sub> credits prior to MY 2027 that could be applied for MY 2027 and later based on an approach that combines the current NO<sub>x</sub> standards and the proposed test procedures (see Section IV.G.6). Paragraph (a)(2) includes our proposal to allow manufacturers to generate early adoption incentive credits by complying with the proposed MY 2027 standards (or MY 2031 standards, if applicable) before the required compliance date (see Section IV.H).<sup>665</sup> Paragraph (a)(3) would clarify that manufacturers must use one of these two options for generating credits prior to MY 2027 for use in MY 2027 and later.

#### 6. Transitional Credits Generated in MYs 2024 Through 2026

We are proposing an option for manufacturers to generate transitional credits in MYs 2024 through 2026 that could be applied in MYs 2027 and later. We propose these transitional credits as a flexibility that accounts for key differences between the current and proposed compliance programs, and incentivizes manufacturers to adopt the proposed test procedures earlier than required in MY 2027. As described below, the proposed approach bases the transitional credit calculation on the current NO<sub>x</sub> standards and useful life periods; therefore, manufacturers may not need to adopt new technologies or demonstrate durability over longer useful life periods, which would otherwise be needed to comply with the proposed more stringent emission standards and longer useful life periods.<sup>666</sup>

Specifically, we are proposing a new interim provision in 40 CFR 1036.150(a)(1) that manufacturers could use to generate transitional credits in model years 2024 through 2026. The transitional credits rely on the same structure as the general ABT provisions proposed in 40 CFR 1036.104(c) and subpart H, with differences noted in this section. Manufacturers would similarly declare a NO<sub>x</sub> FEL for operation over the FTP duty cycle. The FEL<sub>FTP</sub> would then be used to calculate FELs for operation over the other applicable duty

cycles and off-cycle bins for which there are no current standards. Manufacturers would calculate an FEL for each other applicable cycle by multiplying the corresponding MY 2027 standard for that cycle by the ratio of their declared FEL<sub>FTP</sub> to the MY 2027 FTP standard.

For an example model year 2025 Light HDE engine family, the proposed Option 1 MY 2027 NO<sub>x</sub> standards are 35 mg/hp-hr for FTP and SET, and 90 mg/hp-hr for LLC. If a Light HDE manufacturer declares an FEL<sub>FTP</sub> of 0.10 g/hp-hr, then the calculated MY 2025 FEL for LLC (FEL<sub>LLC</sub>) would equal 0.090 g/hp-hr multiplied by the ratio 0.10/0.035, *i.e.*, 0.26 g/hp-hr. The manufacturer would have to demonstrate that they can meet an LLC NO<sub>x</sub> emission level of 260 mg/hp-hr for certification. Similar to the general ABT program, the FELs calculated for these cycles would serve as the emission standards for the engine family for the respective testing, and manufacturers would demonstrate that they meet those FELs in their application for certification. Compared to the current ABT program, CI engine manufacturers opting to generate transitional credits under this proposal would have to show that they meet a calculated FEL<sub>LLC</sub> on the proposed LLC test procedure in 40 CFR 1036.512. SI engine manufacturers would have to show that they meet a calculated FEL<sub>SET</sub> on the proposed SET test procedure in 40 CFR 1036.505.

To calculate transitional credits, we propose that manufacturers would apply the declared FEL<sub>FTP</sub> in the emission credits equation in 40 CFR 1036.705(b)(1) (see Equation IV–1). We propose that the credits be calculated relative to the current FTP standard of 0.20 g/hp-hr and the current useful life that applies for the engine family as defined in 40 CFR 86.004–2.

Since transitional credits would be used in MYs 2027 or later, we are proposing that transitional credits would have the same five-year credit life as proposed for other credits generated for use in MYs 2027 and later. See proposed 40 CFR 1036.740(d). Similarly, to generate transitional NO<sub>x</sub> emission credits, manufacturers would be required to meet the applicable current PM, HC, and CO emission standards in 40 CFR 86.007–11 or 86.008–10 without generating or using emission credits. We propose that manufacturers would record the PM, HC, and CO emission levels during testing over the proposed new duty cycles, but they would not scale PM, HC, and CO as proposed for NO<sub>x</sub> over the other cycles.

We request comment on our proposed approach to offer transitional NO<sub>x</sub>

<sup>665</sup> Also see Section IV.I and the corresponding proposed provisions in 40 CFR 1037 for a description of how these options apply for manufacturers certifying electric vehicles.

<sup>666</sup> In Section IV.H, we propose early adoption incentives with credit multipliers for manufacturers who achieve the full proposed emission standards and compliance measures for engine families before MY 2027.

emission credits that incentivize manufacturers to adopt the proposed test procedures earlier than required in MY 2027. We request comment on if CI engines should be subject to off-cycle standards as proposed in 40 CFR part 1036, subpart E, to qualify for the transitional credits. We are specifically interested in comments on other approaches to calculating transitional credits before MY 2027 that would account for the differences in our current and proposed compliance programs. We also request comment on our proposal to apply a five-year credit life for transitional NO<sub>x</sub> emission credits.

#### H. Early Adoption Incentives

We are proposing an early adoption incentive program as an interim provision in 40 CFR 1036.150(a)(2). Manufacturers have four or more model years of lead time to meet the proposed criteria pollutant standards that would begin to apply in MYs 2027 and 2031 for proposed Option 1 or MY 2027 for proposed Option 2. However, we recognize that manufacturers have opportunities to introduce some technologies earlier than required and that public health and the environment would benefit from early introduction. Specifically, early introduction of new emission control technologies can accelerate the entrance of lower-emitting engines and vehicles into the heavy-duty vehicle fleet, thereby reducing NO<sub>x</sub> emissions from the heavy-duty sector and lowering its contributions to ozone and PM formation.

Early introduction of engines capable of meeting all of the proposed standards and requirements for MY 2027, or MY 2031 if applicable, would reduce emissions from heavy-duty trucks across operating modes and maintain that degree of emission control throughout a longer portion of the engine operational life. For example, our analysis shows that without the proposed standards, low-load emissions would account for 28 percent of the heavy-duty NO<sub>x</sub> emission inventory in calendar year 2045, which suggests that early introduction of technologies capable of reducing low-load emissions could help accelerate important reductions of this portion of the inventory. Similarly, our analysis shows that emissions attributable to deterioration of emission controls after the existing useful life

periods would account for 25 percent of the heavy-duty emission inventory in calendar year 2045, which again suggests that early adoption of technologies capable of reducing emissions for longer periods of time could have important impacts on this part of the heavy-duty emission inventory (see Section I.E for more details on Engine Operation and Processes Contributing to Heavy-Duty NO<sub>x</sub> Emission Inventory in 2045). As discussed in Section II, many state and local agencies have asked the EPA to further reduce NO<sub>x</sub> emissions, specifically from heavy-duty engines, because such reductions will be a critical part of many areas' strategies to attain and maintain the ozone and PM<sub>2.5</sub> NAAQS. Several of these areas are working to attain or maintain NAAQS in timeframes leading up to and immediately following the required compliance dates of the proposed standards, which underscores the importance of the early introduction of lower-emitting vehicles.

We are proposing an early adoption incentive program that would recognize the environmental benefits of lower-emitting engines and vehicles entering the fleet ahead of required compliance dates for the proposed standards. Under the proposed new interim provision in 40 CFR 1036.150(a)(2), this optional program would allow manufacturers who demonstrate early compliance with the proposed MY 2027, or MY 2031 if applicable, standards to generate more NO<sub>x</sub> credits for the relevant early compliance model years than under the proposed ABT program for the model years for which the standards are applicable (described in Section IV.G).

##### 1. Eligibility for Early Adoption Incentives

In MYs 2024 through 2026, manufacturers may choose to participate in the proposed early adoption incentive program by demonstrating compliance with all of the proposed MY 2027 (or, alternatively, MY 2031) standards and other requirements specified in proposed 40 CFR 1036.205.<sup>667</sup> Similarly, under proposed Option 1, manufacturers may participate in the proposed early adoption incentive program in MYs 2027 through

2030 by demonstrating compliance with all of the proposed Option 1 MY 2031 standards and other requirements. Early adoption credits generated under proposed 40 CFR 1036.150(a)(2) could be used to comply with the proposed NO<sub>x</sub> emission standards starting as early as MY 2027 as further specified in proposed 40 CFR part 1036, subpart H.

##### 2. Calculating Credits Under the Early Adoption Incentive Program

Our proposed early credit provisions in 40 CFR 1036.150(a)(2) recognize the benefits of early adoption of low-NO<sub>x</sub> technologies in two ways. First, we propose to reduce the declared FEL, for purpose of calculating credits, to provide appropriate credit for the additional years of emissions assurance that come with certifying to a longer useful life. Second, we proposed to apply a traditional credit multiplier to further incentivize early adoption of technologies that will meet our standards. Our proposed multipliers would be based on the current model year relative to the model year of the standards to which the engine is being certified, with a larger multiplier for meeting the MY 2031 requirements before MY 2027.

To calculate credits under the early adoption incentive program, we are proposing a manufacturer would multiply the engine family's declared FEL by a ratio of useful life period of the current model year relative to the longer useful life period of the model year to which the engine family is certified.<sup>668</sup> For example, a manufacturer certifying a MY 2027 Heavy HDE to proposed Option 1 MY 2031 standards would multiply the declared FELFTP by the ratio of 600,000 miles to 800,000 miles (*i.e.*, MY 2027 UL to MY 2031 UL for Heavy HDE under proposed Option 1). The manufacturer would then apply a multiplier to calculate the total early adoption credit for the engine family. Equation IV–2 illustrates how the Eq. 1036.705–1 would be updated to calculate early credits as proposed in 40 CFR 1036.150(a)(2). The proposed Early Adoption Multiplier (ECM) values are shown in Table IV–15.

<sup>667</sup> See Section IV.G.1 for discussion on the relationship of the FELFTP and demonstrating compliance with all duty-cycle standards.

<sup>668</sup> This approach is similar to the early compliance approach adopted by CARB in the 30-Day Modifications to the HD Omnibus regulation. See Appendix B–1 and Appendix B–2 available online: <https://ww2.arb.ca.gov/rulemaking/2020/hdomnibuslownox>.

Equation IV-2

$$Early\ Credit = \left( Std_{FTP} - FEL \cdot \frac{UL_{MY}}{UL} \right) \cdot \frac{Work_{FTP}}{Miles_{FTP}} \cdot Volume \cdot UL \cdot EAM \cdot (10^{-9})$$

Where:

Std<sub>FTP</sub> = the FTP duty cycle NO<sub>x</sub> emission standard, in mg/hp-hr, that applies for engines not participating in the ABT program

FEL = the engine family's FEL for NO<sub>x</sub>, in mg/hp-hr.

UL<sup>MY</sup> = the useful life, in miles, that applies for engines not participating in the ABT program in that model year.

UL = the useful life, in miles, for the standard that applies for the applicable primary intended service class.

Work<sup>FTP</sup> = the total integrated horsepower-hour over the FTP duty cycle.

Miles<sup>FTP</sup> = the miles of the FTP duty cycle. For Spark-ignition HDE, use 6.3 miles. For Light HDE, Medium HDE, and Heavy HDE, use 6.5 miles.

Volume = the number of engines eligible to participate in the ABT program within the given engine family during the model year, as described in the existing 40 CFR 1036.705(c).

EAM = early adoption multiplier based on model year of the engine family and the model year of the standard to which the engine family is being certified. See Table IV-15.

TABLE IV-15—PROPOSED EARLY ADOPTION MULTIPLIERS

Engine family model year <sup>a</sup>	Meet all requirements for model year	Early adoption multiplier
2024 through 2026	2027	1.5
2024 through 2026 <sup>b</sup>	2031	2.0
2027 through 2030 <sup>b</sup>	2031	1.5

<sup>a</sup>BEV and FCEV could generate NO<sub>x</sub> emission credits as described in Section IV.1.2.ii, but would not be eligible for early adoption multipliers.

<sup>b</sup>Early adoption multipliers for meeting MY 2031 standards would only apply under the two-step proposed Option 1.

Our proposal to reduce a manufacturer's declared FEL<sub>FTP</sub> in the early credit calculation would increase the number of credits relative to the general ABT credit calculation in proposed 40 CFR 1036.705. We believe it is appropriate to scale down the FEL using the useful life ratio for all primary intended service classes to reflect the durability improvements needed to meet the standards when the useful life mileages differ. This adjustment is particularly important to avoid negative credit values when calculating early credits for Heavy HDE in model years 2027 through 2030 under the two-step approach of proposed Option 1 when the proposed numeric value of the standard at full useful life is lower than the MY 2031 standard.<sup>669</sup>

We believe that the proposed 1.5 to 2.0 multipliers in the early adoption incentive program appropriately balance providing an incentive for manufacturers to develop and introduce lower-emitting technologies earlier than required while also considering that the credits could be used to produce higher-emitting engines in later model years. Our proposed multipliers would encourage early introduction to augment manufacturers' longer-term flexibility in product planning to meet the proposed standards. As discussed in Section IV.G,

we are proposing credit life limits and FEL caps to ensure that NO<sub>x</sub> emission credits generated through the early adoption incentive program do not compromise the environmental benefits expected from the proposal.

Specifically, our proposed NO<sub>x</sub> FEL caps would ensure significant emission reductions from all heavy-duty highway engines compared to today's products.

We have aligned both the compliance requirements and numeric value of our proposed early adoption multipliers with the Early Compliance Credit Multipliers included in the Omnibus for MY 2024 and later. We believe that aligning our approach with the CARB program provides manufacturers with a common set of requirements and incentives for the early introduction of lower emitting vehicles.<sup>670</sup>

3. Requests for Comment on Early Adoption Incentive Program

Our proposed approach would incentivize manufacturers to produce lower emitting vehicles prior to required compliance dates by offering more emission credits for early introduction of these cleaner technologies. EPA requests comment on all aspects of our proposed early adoption incentive program. Specifically, we are interested in stakeholder feedback on our

approach that engine families meet all proposed MY 2027, or MY 2031 if applicable, requirements in order to participate in the early adoption incentive program. The proposed eligibility criteria would ensure that products participating in the early adoption incentive program not only meet lower numeric levels of the standards, but also maintain emission control across a broad range of engine operations and over a longer duration of operational life, consistent with the proposed requirements. Nevertheless, we are aware that there may be aspects of the proposed requirements that are challenging to meet ahead of the required compliance dates, and thus EPA requests comment on any needed flexibilities that we should include in the early adoption incentive program in the final rule.

We are also interested in stakeholder feedback on the proposed numeric values of the credit multipliers in the early adoption incentive program; commenters recommending alternative numeric values for credit multipliers are encouraged to include data supporting why those values are appropriate. In addition, we are interested in whether EPA should further restrict the use of NO<sub>x</sub> credits generated under the early adoption incentive program. For instance, we could consider finalizing a shorter credit life for NO<sub>x</sub> emission credits generated under the early adoption incentive program. We could also consider finalizing a cap on the

<sup>669</sup> For example, without an FEL adjustment, the difference between the proposed NO<sub>x</sub> standard of 35 mg/hp-hr in MY 2027 through 2030 and an otherwise credit-generating FEL in the range of 36 to 40 mg/hp-hr would be negative (i.e., 35 mg/hp-hr - 40 mg/hp-hr = - 5 mg/hp-hr).

<sup>670</sup> We believe that aligning the proposed EPA early adoption incentive program and the CARB Early Compliance Credit Multipliers is useful for manufacturers even in the standards and other requirement of the EPA final rule do not fully align with the CARB Omnibus provisions.

number of engines with which a manufacturer could generate early adoption incentive credits, or a cap on the number of credits per model year that a manufacturer could generate.

Finally, we request comment on our approach to align the requirements and numeric values of the multipliers with the Early Compliance Credit Multipliers included in the Omnibus. In addition, we are interested in stakeholder input on whether EPA should adopt specific provisions that incentivize manufacturers to certify engine families that meet the MY 2024 Omnibus requirements.<sup>671</sup> As described in Section IV.G.6, we are proposing a transitional credit option for MY 2024 through 2026 that is calculated relative to the current standards. We may consider a multiplier or other incentive that reflects the CARB MY 2024 requirements being a step more stringent than the current standards, but less comprehensive than the proposed MY 2027 requirements. For instance, in MYs 2024 through 2026, EPA could offer an early adoption multiplier of 1.25 for manufacturers certifying 50-state engine families that meet all of the requirements of the MY 2024 Omnibus program. We request comment on incentivizing adoption of the MY 2024 Omnibus requirements, including suggested multipliers or other approaches we should consider.

### *I. Compliance Options for Generating NO<sub>x</sub> Emission Credits From Electric Vehicles*

The number of heavy-duty electric vehicles (EVs) in the form of hybrid electric vehicles (HEVs), battery electric vehicles (BEVs), and fuel cell electric vehicles (FCEVs) in the heavy-duty market today is a small percentage of the total heavy-duty fleet based on estimates from several sources.<sup>672 673 674 675</sup> However, growing

<sup>671</sup> As noted in Section I.D, EPA is reviewing a waiver request under CAA section 209(b) from California for the Omnibus rule; if we were to grant the waiver request for the CA Omnibus, then we may consider in the final EPA rule ways to incentivize manufacturers to produce engines that meet the Omnibus requirements and are available for sale outside of CA or other states that may adopt the Omnibus.

<sup>672</sup> North American Council for Freight Efficiency “Guidance Report: Viable Class 7½ Electric, Hybrid and Alternative Fuel Tractors”, available online at: <https://nacfe.org/downloads/viable-class-7-8-alternative-vehicles/>.

<sup>673</sup> UCS (2019) “Ready for Work: Now Is the Time for Heavy-Duty Electric Vehicles”; [www.ucsusa.org/resources/ready-work](http://www.ucsusa.org/resources/ready-work).

<sup>674</sup> Nadel, S. and Junga, E. (2020) “Electrifying Trucks: From Delivery Vans to Buses to 18-Wheelers”. American Council for an Energy-Efficient Economy White Paper, available online at: <https://aceee.org/white-paper/electrifying-trucks-delivery-vans-buses-18>.

numbers of these EV technologies are in production, in demonstration projects, or planned for production in the early 2020s (see Chapter 1.4 of the draft RIA for more discussion). Forecasting models and studies generally agree that HEV, BEV, and FCEV production volumes will grow, yet the predicted rate of growth ranges widely across various forecasts and partly depend on the specific market segments and time periods being evaluated, study methodologies, as well as underlying assumptions.<sup>676 677 678</sup> Many ANPR commenters asserted that EV technologies would continue to grow as part of the heavy-duty fleet; commenters generally focused on projected growth of BEVs based on their own production plans and/or customer orders for their products, although no specific data was provided by commenters.<sup>679</sup>

In the ANPR for this action we requested comment on any barriers or incentives that EPA should consider to better encourage emission reductions from HEVs, BEVs, and FCEVs.<sup>680</sup> Most but not all ANPR commenters were

<sup>675</sup> Smith, D. et al. (2019) “Medium- and Heavy-Duty Electrification An Assessment of Technology and Knowledge Gaps”. Oak Ridge National Laboratory and National Renewable Energy Laboratory. ORNL/SPR–2020/7

<sup>676</sup> Energy Information Association (2018) “Annual Energy Outlook; Table 50: Freight Transportation Energy Use”, available at: <https://www.eia.gov/outlooks/aeo/data/browser/#/?id=58-AEO2018&region=0-0&cases=ref2018&start=2016&end=2050&f=A&linechart=ref2018-d121317a.6-58-AEO2018-ref2018-d121317a.11-58-AEO2018-ref2018-d121317a.17-58-AEO2018-ref2018-d121317a.22-58-AEO2018-ref2018-d121317a.28-58-AEO2018-ref2018-d121317a.33-58-AEO2018&ctype=linechart&sid=ref2018-d121317a.22-58-AEO2018-ref2018-d121317a.11-58-AEO2018-ref2018-d121317a.33-58-AEO2018&sourcekey=0>

<sup>677</sup> Jadun, et al. (2017) “Electrification Futures Study: End-Use Electric Technology Cost and Performance Projections through 2050”. Golden, CO: National Renewable Energy Laboratory. NREL/TP–6A20–70485. <https://www.nrel.gov/docs/fy18osti/70485.pdf>.

<sup>678</sup> Brooker et al. (2021) “Vehicle Technologies and Hydrogen and Fuel Cell Technologies Research and Development Programs Benefits Assessment Report for 2020”. Golden, CO: National Renewable Energy Laboratory. NREL/TP–5400–79617. <https://www.nrel.gov/docs/fy21osti/79617.pdf>.

<sup>679</sup> For example, see Comments of Tesla Inc. “Control of Air Pollution from New Motor Vehicles: Heavy-Duty Engine Standards, Docket No. EPA–HQ–OAR–2019–0055, 85 Fed. Reg. 3306 (Jan. 21, 2020).” Docket EPA–HQ–OAR–2019–0055–0268.; Comments of Rivian. “Comments on the Control of Air Pollution From New Motor Vehicles: Heavy-Duty Engine Standards Advanced Notice of Proposed Rulemaking (EPA–HQ–OAR–2019–0055; FRL–10004–16–OAR).” Docket EPA–HQ–OAR–2019–0055–0272.; Comments of Volvo Group. “Comments of the Volvo Group; U.S. EPA Cleaner Trucks Initiative Advanced Notice of Proposed Rulemaking.” Docket EPA–HQ–OAR–2019–0055–0463.

<sup>680</sup> 85 FR 3306, January 21, 2020.

generally supportive of EPA following approaches used in the past of offering emission credits and credit multipliers for EV technologies.<sup>681</sup> Commenters also noted that making credits in an ABT program available for EV technologies, particularly credits available prior to MY 2027, would provide manufacturers with flexibility by providing additional time to develop the technologies to comply with the proposed emission standards.<sup>682</sup> However, under the current criteria pollutant program, manufacturers do not have a pathway to generate NO<sub>x</sub> emission credits for HEVs, BEVs, or FCEVs. For BEVs and FCEVs, current 40 CFR 86.016–1(d)(4) stipulates that these technologies may not generate NO<sub>x</sub> emission credits, and for HEVs, there has historically not been a test procedure available to demonstrate NO<sub>x</sub> emission performance of the technologies (see Sections III.A and III.B for discussion on the current regulatory provisions specific to heavy-duty electric vehicles, and test procedures for HEVs, respectively).<sup>683</sup> We outline in the subsections that follow how we propose to address these barriers to generating NO<sub>x</sub> emission credits for HEVs, and, separately, BEVs or FCEVs.

EPA is proposing to allow HEVs to generate NO<sub>x</sub> emission credits based on

<sup>681</sup> For example, see Comments of Tesla Inc. “Control of Air Pollution from New Motor Vehicles: Heavy-Duty Engine Standards, Docket No. EPA–HQ–OAR–2019–0055, 85 Fed. Reg. 3306 (Jan. 21, 2020).” Docket EPA–HQ–OAR–2019–0055–0268.; Comments of Rivian. “Comments on the Control of Air Pollution From New Motor Vehicles: Heavy-Duty Engine Standards Advanced Notice of Proposed Rulemaking (EPA–HQ–OAR–2019–0055; FRL–10004–16–OAR).” Docket EPA–HQ–OAR–2019–0055–0272.; Comments of Volvo Group. “Comments of the Volvo Group; U.S. EPA Cleaner Trucks Initiative Advanced Notice of Proposed Rulemaking.” Docket EPA–HQ–OAR–2019–0055–0463.; Comments of Edison Electric Institute. “Comments of the Edison Electric Institute on the U.S. Environmental Protection Agency’s Advanced Notice of Proposed Rulemaking Control of Air Pollution from New Motor Vehicles: Heavy-Duty Engine Standards.” Docket EPA–HQ–OAR–2019–0055–0293.; Note that one commenter did not support credit multipliers, see Comments of Eaton. “Eaton Comments to EPA Control of Air Pollution from New Motor Vehicles: Heavy-Duty Engine Standards Docket No. EPA–HQ–OAR–2019–0055.” Docket EPA–HQ–OAR–2019–0055–0452.

<sup>682</sup> Tesla Inc. “Control of Air Pollution from New Motor Vehicles: Heavy-Duty Engine Standards, Docket No. EPA–HQ–OAR–2019–0055, 85 Fed. Reg. 3306 (Jan. 21, 2020).” Docket EPA–HQ–OAR–2019–0055–0268.; Rivian. “Comments on the Control of Air Pollution From New Motor Vehicles: Heavy-Duty Engine Standards Advanced Notice of Proposed Rulemaking (EPA–HQ–OAR–2019–0055; FRL–10004–16–OAR).” Docket EPA–HQ–OAR–2019–0055–0272.; Volvo Group. “Comments of the Volvo Group; U.S. EPA Cleaner Trucks Initiative Advanced Notice of Proposed Rulemaking.” Docket EPA–HQ–OAR–2019–0055–0463.

<sup>683</sup> 40 CFR 86.016–1(d)(4) states: “Electric heavy-duty vehicles may not generate NO<sub>x</sub> or PM emission credits. Heavy-duty vehicles powered solely by electricity are deemed to have zero emissions of regulated pollutants.”

their near-zero tailpipe emissions and because they provide an opportunity for manufacturers to develop and refine transferable technologies to BEVs and FCEVs (e.g., batteries, electric motors). We are proposing to allow BEVs and FCEVs to generate NO<sub>x</sub> emission credits because of the zero-tailpipe emissions performance of these technologies and after consideration of ANPR comments.<sup>684</sup> We are further proposing to allow manufacturers to generate BEV and FCEV NO<sub>x</sub> emission credits starting in MY 2024 in response to ANPR comments concerning the importance of such credits in providing manufacturers with flexibility in their product planning. Some ANPR comments also supported emission credit multipliers for HEVs, BEVs, and FCEVs.<sup>685</sup> In developing our proposal, we considered whether to provide credit multipliers for these technologies in the early years of the proposed program; however, we are choosing not to propose NO<sub>x</sub> emission credit multipliers for HEVs, BEVs, or FCEVs due to the potential emission impacts of the use of credit multipliers and the current state of technology development and implementation (see Section IV.I.4 for more details on this topic).<sup>686</sup> The subsections that follow discuss: (1) How manufacturers can certify HEV, BEVs, and FCEVs to the proposed criteria pollutant standards, (2) proposed requirements for generating NO<sub>x</sub> emission credits for these technologies, (3) potential options for how EPA could approach NO<sub>x</sub> emission credits from BEVs and FCEVs in the long-term (e.g., post-MY 2031), and (4) our reasoning for not proposing credit multipliers for NO<sub>x</sub> emission credits generated from HEVs, BEVs, or FCEVs.

#### 1. Certification Provisions for Generating NO<sub>x</sub> Emission Credits From Electric Vehicles

As outlined in Section III.A, we are proposing to clarify in proposed 40 CFR 1036.101(b) that manufacturers may optionally test the hybrid engine and

<sup>684</sup> As noted in Section III.A, our proposal for how manufacturers could generate NO<sub>x</sub> emissions credits from BEVs and FCEVs would be available under any of the regulatory options that we are considering for revised NO<sub>x</sub> standards.

<sup>685</sup> Rivian. "Comments on the Control of Air Pollution From New Motor Vehicles: Heavy-Duty Engine Standards Advanced Notice of Proposed Rulemaking (EPA-HQ-OAR-2019-0055; FRL-10004-16-OAR)." Docket EPA-HQ-OAR-2019-0055-0272.; Volvo Group. "Comments of the Volvo Group; U.S. EPA Cleaner Trucks Initiative Advanced Notice of Proposed Rulemaking." Docket EPA-HQ-OAR-2019-0055-0463.

<sup>686</sup> As noted in Section IV.I.4, BEVs and FCEVs would not be eligible for Early Adoption Incentive credit multipliers (see Section IV.H for details of Early Adoption Incentives).

powertrain together, rather than testing the engine alone; this option would allow manufacturers to demonstrate emission performance of the hybrid technology that are not apparent when testing the engine alone.<sup>687</sup> To generate NO<sub>x</sub> emission credits with a hybrid engine or hybrid powertrain, manufacturers would conduct the emission testing described in Section IV.I.2.i and apply the results as specified for the proposed engine ABT program discussed in Section IV.G.

Similarly, we propose to clarify the procedures for certifying BEVs and FCEVs to criteria emission standards. As discussed in Section III.A, we are proposing to consolidate criteria pollutant and GHG emission certification requirements in 40 CFR part 1037 for BEVs and FCEVs with a GVWR over 14,000 pounds, as specified in the current 40 CFR 1037.1 and proposed 40 CFR 1037.102.<sup>688</sup> As noted in the introduction to this Section IV.I, we are also proposing that BEVs and FCEVs may generate NO<sub>x</sub> emission credits, as specified in proposed 40 CFR 1037.616. Manufacturers choosing to participate in the NO<sub>x</sub> ABT program would be required to conduct testing to measure work produced over a defined duty-cycle test, and either useable battery energy for BEVs or fuel cell voltage for FCEVs (see Section IV.I.2 for details). Manufacturers would generate vehicle emissions credits, which would then be fungible between vehicle and engine ABT programs, such that NO<sub>x</sub> credits generated through the vehicle program could be applied to the proposed engine ABT program described in Section IV.G.<sup>689</sup> See Sections IV.G.2, IV.G.3, IV.G.4, and IV.G.6 for details on proposed limitations on the use of NO<sub>x</sub> emission credits, including NO<sub>x</sub> emission credits generated from BEVs or FCEVs, within the engine ABT program, as specified in proposed 40 CFR 1036.741. Based on proposed 40 CFR 1037.102(b)(1) and proposed 40 CFR 1036.741, NO<sub>x</sub> emission credits generated by BEVs or FCEVs would be restricted to use in the CI engine averaging set in which those credits are generated; further below we request comment on this approach.

<sup>687</sup> We are also proposing to update the definition of "engine configuration" in 40 CFR 1036.801 to clarify that an engine configuration would include hybrid components if it is certified as a hybrid engine or hybrid powertrain.

<sup>688</sup> As specified in proposed 40 CFR 1037.102(b)(1), we are proposing that manufacturers apply the Light HDE provisions to Light HDV, apply the Medium HDE provisions to Medium HDV, and apply the Heavy HDE provisions to Heavy HDV.

<sup>689</sup> As described in proposed 40 CFR 1036.705 and 1036.741.

In developing our proposed approach of a vehicle certification pathway for BEV and FCEV criteria pollutant requirements, we considered two options: vehicle certification or powertrain certification. We are proposing to allow vehicle manufacturers, rather than powertrain manufacturers, to generate vehicle credits for BEVs or FCEVs because the vehicle certification pathway is already utilized for certifying BEVs and FCEVs to GHG standards, and thus would require fewer resources to implement and carryout for both manufacturers and EPA's certification program. We recognize that under our proposed approach powertrain manufacturers would need to partner with vehicle manufacturers in order to obtain an EPA certificate, and that EMA commented on the proposed CARB HD NO<sub>x</sub> Omnibus regulation that powertrain manufacturers, not vehicle manufacturers, should generate NO<sub>x</sub> credits generated from zero tailpipe emission vehicles.<sup>690</sup> We further recognize that the final CARB Heavy-Duty NO<sub>x</sub> Omnibus Regulation includes a powertrain certification pathway for BEVs and FCEVs, rather than a vehicle certification pathway. EPA believes that this incomplete alignment with the CARB Omnibus program would be minor and minimally disruptive to manufacturers since under the CARB Omnibus program NO<sub>x</sub> credits can be generated from BEVs and FCEVs only through MY 2026.<sup>691</sup> Further, we note that this concern does not apply to vertically integrated powertrain manufacturers and that non-vertically integrated powertrain manufacturers could develop their business arrangements with the vehicle manufacturers such that NO<sub>x</sub> credits are transferred to the powertrain manufacturer.

On balance, EPA believes that the vehicle certification pathway for BEVs and FCEVs leads to a lower burden to manufacturers and EPA's certification program, and thus is the preferable option. Immediately below we request comment on our proposed approach and broader concepts related to NO<sub>x</sub>

<sup>690</sup> California Air Resources Board, Responses to Comments on the Environmental Analysis for the Proposed Heavy-Duty Engine and Vehicle Omnibus Regulation and Association Amendments. EMA Comment on CARB Omnibus (see p. 132 of pdf at <https://ww3.arb.ca.gov/regact/2020/hdomnibuslownox/res20-23attbrtc.pdf>).

<sup>691</sup> Under the Omnibus, at the end of MY 2026 NO<sub>x</sub> credits can no longer be generated from BEVs and FCEVs, and existing NO<sub>x</sub> credits from BEVs and FCEVs can no longer be used, and thus the lack of alignment between the CARB and proposed EPA certification pathways for these technologies is only for a few model years.



emission credits for HEVs, BEVs, and FCEVs.

We request comment on the general proposed approach of allowing HEVs, BEVs and FCEVs to generate NO<sub>x</sub> credits, which can then be used in the heavy-duty ABT program. We also specifically request comment on our proposal to allow BEV and FCEV vehicle manufacturers to generate vehicle emission credits for NO<sub>x</sub>. We further request comment on whether and how EPA could extend the opportunity to generate NO<sub>x</sub> engine emission credits to other manufacturers in the BEV and FCEV production process (e.g., non-vertically integrated powertrain manufacturers in addition to or in lieu of vehicle manufacturers). In addition, we request comment on our proposed approach to limit the use of NO<sub>x</sub> emission credits generated from BEV or FCEVs to the Light HDE, Medium HDE and Heavy HDE averaging sets in which they are generated. In particular, we are interested in stakeholder input on allowing NO<sub>x</sub> emission credits generated by BEVs or FCEVs in the Light HDE or Medium HDE averaging sets to be used in SI engine averaging sets.

## 2. Electric Vehicle Testing and Other Requirements for Generating NO<sub>x</sub> Emission Credits

Similar to our approach for CI and SI engine manufacturers, EPA is proposing that manufacturers of HEVs, BEVs, and FCEVs would submit test data at the time of certification to support their calculation of NO<sub>x</sub> emission credits. Manufacturers would calculate the value of NO<sub>x</sub> emission credits generated from HEVs, BEVs, or FCEVs using the same equation provided for engine emission credits (see Equation IV-1 in Section IV.G.1). This equation relies on three key inputs: (1) The engine family's FEL for NO<sub>x</sub>, in mg/hp-hr, (2) work produced over the FTP duty-cycle, and (3) useful life mileage of the engine. Immediately below we describe how manufacturers would generate these three key inputs for HEVs, BEVs, and FCEVs, respectively.

### i. Hybrid Electric Vehicle Testing for NO<sub>x</sub> Emission Credits

For HEVs, we are proposing that starting in MY 2023 manufacturers could use powertrain testing procedures to certify hybrid configurations to criteria pollutant standards (see Section III.B.2 for more discussion on our proposal to allow powertrain testing for hybrid engines and powertrains).<sup>692</sup>

<sup>692</sup> As described in Section III.B.2, in a previous rulemaking we included an option for

Manufacturers would generate the engine family's FEL for NO<sub>x</sub>, in mg/hp-hr and work produced over the FTP duty-cycle using the powertrain test procedure for the FTP duty-cycle, as specified in the current 40 CFR 1036.510. By using the powertrain testing protocol, manufacturers could demonstrate NO<sub>x</sub> emissions performance of their hybrid powertrain technology and, where appropriate, generate NO<sub>x</sub> emission credits under the proposed ABT program described in Section IV.G. Manufacturers would complete their NO<sub>x</sub> credit calculation using the useful life mileage of the hybrid engine and powertrain configuration. As discussed in Section IV.A.3, we are proposing that hybrid engine and powertrain configurations certify to the same useful life requirements as the conventional engine that would typically be installed in the vehicle in order to provide truck owners and operators with similar assurance of durability regardless of the powertrain configuration they choose.

### ii. Battery and Fuel Cell Electric Vehicle Testing Requirements for NO<sub>x</sub> Emission Credits

We are proposing for the first input into the NO<sub>x</sub> emission credit calculation (NO<sub>x</sub> FEL for the engine family) that BEV and FCEV manufacturers would declare an FEL for NO<sub>x</sub>, in mg/hp-hr that represents the NO<sub>x</sub> emission standards that the vehicle will meet throughout useful life, as stated in proposed 40 CFR 1037.616(a)(2). For the second input (work produced over the FTP duty-cycle), we are proposing that manufacturers would use data generated by a powertrain test procedure for a series of duty-cycle tests (multicycle test, MCT) (see Section III.B and proposed 40 CFR 1037.552 and 1037.554 for details on the MCT for BEVs and FCEVs, respectively). One of the duty-cycle tests included in each MCT is the FTP, which provides the necessary input to the credit calculation (see Section IV.I.2.iii for additional information on data generated by the MCT). The third input (useful life mileage) is discussed in Section IV.A.3 and specified in proposed 40 CFR 1037.102(b)(2). Briefly, we are proposing that BEV and FCEV manufacturers meet the useful life period of an equivalent engine-based service class. As discussed in Section

manufacturers to use powertrain test procedures to certify a hybrid powertrain to the FTP and SET greenhouse gas engine standards; under this rulemaking we are proposing to allow manufacturers to use powertrain test procedures to certify hybrid powertrains to the proposed FTP, SET, and LLC criteria emission standards.

IV.A.3, we believe that current data support BEV and FCEV technologies being capable of meeting the same useful life requirements of CI engines in the MY 2027 and beyond timeframe.<sup>693</sup> We further believe that this approach provides truck owners and operators with equivalent durability expectations regardless of the powertrain they choose.

### iii. Battery and Fuel Cell Electric Vehicle Durability Requirements for NO<sub>x</sub> Emission Credits

The MCTs for BEVs and FCEVs would provide results that include work produced over the FTP duty-cycle, as well as initial useable battery energy (UBE) for BEVs, and initial fuel cell voltage (FCV) for FCEVs.<sup>694</sup> These additional measures (UBE and FCV) would provide information critical to understanding the durability of the BEV or FCEV. BEVs and FCEVs must be durable throughout the useful life period to which they are certified in order to provide the zero-tailpipe emissions performance for which they are generating NO<sub>x</sub> credits. For instance, if the batteries or fuel cells of a BEV or FCEV are only capable of propelling the vehicle through one half of the certified useful life, and thus the BEV or FCEV can only travel half of the miles used to calculate the NO<sub>x</sub> credits being generated, then the remaining half of the NO<sub>x</sub> emission credits could be used by manufacturers to produce higher emitting internal combustion engines without actually achieving the real-world emission reductions from a BEV or FCEV being used for the full useful life. In other words, the zero-tailpipe emission performance of a BEV or FCEV could turn out to be illusory if the BEV or FCEV is unable to operate, and is thereby unable to achieve zero tailpipe emission performance, for its full useful life. Where BEVs or FCEVs are used to generate emission credits and thereby enable higher-emitting vehicles to be produced, it is especially important for the manufacturer to provide an assurance that the BEV or FCEV will be durable for the full useful life period.

<sup>693</sup> As described in Section IV.A and specified in proposed 40 CFR 1037.102(b)(2), prior to MY 2027, manufacturers choosing to generate NO<sub>x</sub> emission credits with BEVs or FCEVs would apply the useful life periods specified in the current 40 CFR 86.001-2.

<sup>694</sup> Useable battery energy is defined as the energy capacity of the battery less any energy the manufacturer determines is necessary for protecting the battery (e.g., thermal management). Fuel cell voltage is defined as voltage measured when current is between 55 percent-65 percent of rated stack current.

To ensure that BEV and FCEV NO<sub>x</sub> credits are calculated accurately and reflect the environmental benefit of vehicles with zero tailpipe emissions over their full useful life, we are proposing that in MY 2024 and beyond, BEVs and FCEVs used to generate NO<sub>x</sub> emission credits must meet certain durability requirements. As specified in proposed 40 CFR 1037.102(b)(3), BEV or FCEV manufacturers would measure UBE or FCV at the start of useful life using the MCT procedures in proposed 40 CFR 1037.552 or 1037.554, respectively. BEV manufacturers could then attest, in lieu of demonstrating, that UBE remains at 70 percent or greater of the initial value throughout useful life. FCEV manufacturers could similarly attest, in lieu of demonstrating, that FCV remains at 80 percent or greater of the initial value throughout useful life. We recognize that BEV and FCEV technologies, and the batteries and fuel cells that power them, are in relatively nascent periods of development. Although we are proposing that starting in MY 2024 manufacturers must maintain the same percentage of UBE or FCV throughout useful life regardless of model year, the useful life periods are shorter in the proposed earlier model years. Specifically, the useful life period over which manufacturers must demonstrate, or attest, that UBE or FCV will be maintained at or above the proposed percentages are shorter for MYs 2024 through 2026 and increase for MYs 2027 through 2030, with a further increase for MYs 2031 and later (see proposed 40 CFR 1037.102(b)(2); see Section IV.A for our proposed useful life periods). We are not proposing a minimum requirement for UBE or FCV (i.e., manufacturers can design their products with an initial UBE or FCV value of their choosing). Further, there are multiple approaches that manufacturers could choose to use to meet the proposed requirements for UBE and FCV. For instance, manufacturers could choose to design the battery or fuel cell in their product to have a larger capacity at the start of the vehicle life and limit the extent to which the initial capacity is available for use; as the battery or fuel cell ages, the manufacturer could design the product to make more of the battery or fuel cell capacity available for use, and thereby maintain the same percent of UBE or FCV.<sup>695</sup> Another approach that could be taken is the manufacturer

<sup>695</sup> As specified in 40 CFR 1037.552 and 1037.554, manufacturers may declare a UBE or FCV lower than the measured value in order to account for degradation over useful life; however, the UBE or FCV available for operating the vehicle must be at least the value that is declared.

could declare a UBE or FCV that is lower than the result from running the respective test procedures. This approach would give the user access to the full UBE or FCV, but the manufacturer would only be accountable for meeting the requirements in 40 CFR 1037.102(b)(3) for the value that they declared. Alternatively, a manufacturer could choose to include battery or fuel cell maintenance or replacement as part of critical emission-scheduled maintenance; manufacturers choosing this option would need to demonstrate that the maintenance is reasonably likely to be done on in-use vehicles, as specified in the current 40 CFR 1037.125(a). As described in Section IV.I.2.iv, we are requesting comment on whether we should require manufacturers who choose this option to ensure that the maintenance is reasonably likely to be done by providing the maintenance free of charge and clearly stating so in their maintenance instructions, per the current 40 CFR 1037.125(a)(3).

We believe the proposed battery and fuel cell durability requirements are necessary to provide assurance that vehicles with these technologies would continue to provide the zero-tailpipe emissions performance throughout the useful life for which they are given credits. Our proposed approach for UBE and FCV as measures of durability builds on the ZEP Certification requirements and test procedures developed by CARB, work on light-duty vehicle battery durability under the United Nations Economic Commission for Europe (UNECE) Electric Vehicles and the Environment (EVE) Working Group for the Working Party on Pollution and Energy, and work on fuel cell durability by DOE.<sup>696 697 698 699</sup> EPA

<sup>696</sup> California Air Resources Board. "Attachment C: California Standards and Test Procedures for New 2021 and Subsequent Model Heavy-Duty Zero-Emissions Powertrains", available at: <https://ww2.arb.ca.gov/sites/default/files/barcu/regact/2019/zepercrt/froattc.pdf> (last accessed September 20, 2021); see Section D for details of CARB rated energy capacity test procedure requirements.

<sup>697</sup> Informal Working Group (IWG) on Electric Vehicles and the Environment (EVE). (July 2021) Proposal for a new UN GTR on In-vehicle Battery Durability for Electrified Vehicles. Available at: <https://wiki.unece.org/download/attachments/128420965/Based%20on%20GRPE-83-09%208%209%20July%202021%20EC%20US%20proposal.docx?api=v2> (last accessed August 6, 2021).

<sup>698</sup> Adams, J. (2020) DOE H2 Heavy Duty Truck Targets. Available at: <https://www.energy.gov/sites/prod/files/2020/02/f71/fcto-compressed-gas-storage-workshop-2020-adams.pdf> (last accessed on August 5, 2021).

<sup>699</sup> DOE. 2020. FC135: FC-PAD: Fuel Cell Performance and Durability Consortium. Available at: <https://www.hydrogen.energy.gov/pdfs/>

believes the proposed battery and fuel cell durability requirements for BEVs and FCEVs would not only provide necessary assurance of zero-tailpipe emission performance for emission credit calculations, but would also help to ensure consistency in product quality as these technologies become increasingly available in larger portions of the heavy-duty fleet. Consistent product quality is critical not only for potential purchasers to have confidence in selecting BEVs and FCEVs for use in their business, but also for ensuring continued environmental benefits from the technologies throughout their use in the field. We further believe that basing our proposal on the approach being developed for light-duty technologies allows manufacturers to leverage the research and experience of the light-duty industry. The proposed percentages for UBE durability over useful life are drawn from comparable percentages for light-duty battery durability UBE under the UNECE EVE.<sup>700</sup> Similarly, the proposed percentages for FCV durability are drawn from DOE targets for fuel cell durability in heavy-duty vehicles.<sup>701 702</sup> We also note that at least one BEV bus manufacturer currently provides warranty coverage for their battery degrading below 80 percent of initial capacity.<sup>703</sup> As discussed at the end of this subsection, we request comment on whether these percentages are appropriate for MY 2024 and later heavy-duty vehicles, and whether we should finalize different percentages for BEVs and FCEVs prior to MY 2027.

*review20/fc135\_borup\_weber\_2020\_o.pdf* (last accessed August 20, 2021).

<sup>700</sup> See Table 1 (Battery Energy based (SOCE) MPR) of Informal Working Group (IWG) on Electric Vehicles and the Environment (EVE). (July 2021) Proposal for a new UN GTR on In-vehicle Battery Durability for Electrified Vehicles. Available at: <https://wiki.unece.org/download/attachments/128420965/Based%20on%20GRPE-83-09%208%209%20July%202021%20EC%20US%20proposal.docx?api=v2> (last accessed August 6, 2021).

<sup>701</sup> Adams (2020) DOE H2 Heavy Duty Truck Targets. Available at: <https://www.energy.gov/sites/prod/files/2020/02/f71/fcto-compressed-gas-storage-workshop-2020-adams.pdf> (last accessed on August 5, 2021).

<sup>702</sup> Hydrogen and Fuel Cell Technologies Office (2014) DOE Technical Targets for Fuel Cell Transit Buses. Available at: <https://www.energy.gov/eere/fuelcells/doe-technical-targets-fuel-cell-transit-buses>. (last accessed on August 5, 2021).

<sup>703</sup> Blue Bird. (2019) Standard Limited Warranty. Available in the docket for this rule EPA-HQ-OAR-2019-0055.

iv. Alternatives Considered and Requests for Comment on Battery Electric and Fuel Cell Electric Vehicle Testing and Durability Requirements for NO<sub>x</sub> Emission Credits

EPA recognizes that requiring BEV and FCEV manufacturers to run the MCT to measure work produced over the FTP duty cycle and to measure UBE and FCV places an additional burden on manufacturers who choose to generate NO<sub>x</sub> emission credits. We considered two alternative data sources for work produced over the FTP duty cycle in order to allow BEV and FCEV manufacturers to calculate NO<sub>x</sub> emission credits: (1) EPA could assume FTP work based on BEVs and FCEVs performing comparable work to CI and SI heavy-duty engines in the same engine service class, or (2) EPA could modify the GEM model to calculate work performed by electric motors. EPA believes that both alternative options would provide less accurate assessments of FTP-work than our proposed approach due to variability between different powertrains. We believe the value of the greater accuracy of our proposed approach justifies the additional test burden to manufacturers.

Similarly, in addition to the proposed 70 percent UBE and 80 percent FCV durability provisions, we considered two alternative approaches for evaluating battery and fuel cell durability. Under the first alternative manufacturers would measure battery energy consumption using a battery bench test during which the battery would be depleted at a constant rate. While this option would have a lower test burden for manufacturers, depleting the battery at a constant rate would not provide information on useable battery energy under realistic driving conditions. The second alternative durability approach we considered was for manufacturers to measure UBE or FCV by driving their BEV or FCEV on a chassis dynamometer. While this option would provide data that is slightly more reflective of UBE or FCV during realistic driving conditions due to the inclusion of the full vehicle, it would result in a much higher test burden for manufacturers given the limited number of heavy-duty chassis dynamometers available for conducting this type of testing. Ultimately, we believe that our proposed powertrain test method for measuring UBE (for BEVs) or FCV (for FCEVs) would provide assurance when calculating NO<sub>x</sub> emission credits that the environmental benefits of zero tailpipe emission technologies would be maintained throughout useful life,

without imposing undue manufacturer test burden.

We request comment on our proposed approach, along with the suggested alternatives and other possible approaches for demonstrating the amount of work performed on the FTP duty-cycle by BEVs and FCEVs, as well as measuring UBE or FCV. We also request comment whether EPA should adopt different percentages than 70 and 80 percent, respectively, for the required percentage of UBE and FCV remaining at the end of the useful life period for the NO<sub>x</sub> emission credit calculation. We are also interested in input on whether manufacturers who choose to include battery or fuel cell scheduled maintenance or replacement as part of critical emission-related maintenance during the useful life period should be required to provide the maintenance free of charge and clearly state that in their maintenance instructions, per the current 40 CFR 1037.125(a)(3) (i.e., rather than choosing any of the conditions listed in current 40 CFR 1037.125(a), manufacturers including battery or fuel cell maintenance during the useful life period would be required to satisfy current 40 CFR 1037.125(a)(3)). We recognize that battery or fuel cell maintenance during the useful life period may be costly, and thus it may be necessary for manufacturers to provide the maintenance free of charge in order to ensure that the maintenance is reasonably likely to occur in-use and the vehicle continues to provide the zero-tailpipe emissions performance over the useful life period for which it is generating NO<sub>x</sub> credits. We are especially interested in comments and data on battery and fuel cell durability, and information on how manufacturers providing battery or fuel cell maintenance free of charge during the proposed useful life periods could impact the upfront purchase price of the vehicles.

We also request comment on whether to require manufacturers to make readily available to the operator onboard the vehicle a reading of the percent remaining UBE (for BEVs) or FCV (for FCEVs) relative to the value at the time of certification (e.g., 85 percent UBE relative to 100 percent UBE at the time of certification). Such information could support an understanding of UBE and FCV throughout useful life for both EPA and users but may be an additional burden for manufacturers. For instance, manufacturers could choose to display the remaining percentage of UBE or FCV on the dashboard or make the reading available through a generic scan tool. Manufacturers choosing to generate

NO<sub>x</sub> emission credits would measure initial UBE or initial FCV using the same MCT for certification; however, manufacturers could then utilize onboard vehicle sensors and an algorithm of their design (based on battery or fuel cell durability test data or good engineering judgment) to determine UBE (for BEVs) or FCV (for FCEVs) during vehicle operation. Under this option, manufacturers at the time of certification could choose to demonstrate or attest to the accuracy of their onboard vehicle sensor measurements combined with an algorithm, and EPA could measure UBE and FCV during any confirmatory testing.<sup>704</sup> As an alternative option, EPA could require manufacturers to provide data at the time of certification showing the accuracy of their algorithm. We believe that information on the remaining UBE or FCV would provide owners an understanding of battery and fuel cell durability over time. We further believe that an understanding of battery and fuel cell durability would allow users to identify unexpected battery or fuel cell degradation and plan for repairs in a manner that minimizes downtime. We encourage commenters to provide input on utility and feasibility of displaying, or otherwise making available to the operator, the percent remaining UBE or FCV, and whether such information would support BEV or FCEV maintenance and repair in the field.

### 3. Options for Long-Term Treatment of Emission Credits for Electric Vehicles

We are proposing to recognize the NO<sub>x</sub> emission benefits of HEVs, BEVs, and FCEVs by allowing these technologies to generate NO<sub>x</sub> emission credits. At the same time, we recognize that NO<sub>x</sub> emission credits from HEV, BEV, and FCEV technologies would enable manufacturers to use these credits to produce some CI and SI engines with higher NO<sub>x</sub> emissions. We are proposing to limit the potential impacts of this approach with revised FEL caps, which restrict how much CI and SI engines could exceed the NO<sub>x</sub> emission standard by relying on NO<sub>x</sub> credits (see Section IV.G.3 for details on our proposed FEL caps). Even with this restriction, there is the potential for a greater portion of CI engines to emit up to the level of the FEL cap due to NO<sub>x</sub>

<sup>704</sup> As described in Section IV.I.2.iii and specified in the proposed 40 CFR 1037.205(q), manufacturers could attest, in lieu of demonstrating, that UBE or FCV remains at or above the specified percentage of the initial value through useful life, in addition to attesting or demonstrating the accuracy of their algorithm for calculating UBE or FCV throughout useful life.

emission credits generated from BEVs or FCEVs relative to HEVs due to the zero emissions tailpipe performance of BEVs and FCEVs.<sup>705</sup> We therefore believe it is important to consider what impact NO<sub>x</sub> emission credits generated from BEVs and FCEVs might have on the NO<sub>x</sub> emission reductions expected from the proposed rulemaking and to evaluate potential restrictions for NO<sub>x</sub> emission credits from BEVs and FCEVs.

In the final rule or other future rulemakings, it may be appropriate to restrict NO<sub>x</sub> emission credits from BEVs and FCEVs in the longer term (*e.g.*, beyond MY 2031).<sup>706</sup> Long-term adjustments to the proposed NO<sub>x</sub> emission credit provisions for BEVs and FCEVs could include any of the following options: (1) Sunsetting BEV and FCEV NO<sub>x</sub> emission credits, (2) setting NO<sub>x</sub> emission standards for engines with consideration of the availability of BEV and FCEV technologies, or (3) further restricting the use of NO<sub>x</sub> emission credits from BEVs and FCEVs. We discuss each of these options immediately below and request stakeholder input on the appropriateness of each for the final rule or future rules.

Under the first option, we would sunset, *i.e.*, end, the generation and use of NO<sub>x</sub> emission credits for BEVs and FCEVs after a specified period of time (*e.g.*, ten years). Doing so would allow EPA to recognize the zero emission tailpipe benefits of BEVs and FCEVs as they transition into mainstream technologies in the heavy-duty market, and later revert back to a more limited scope of flexibilities for manufacturers to meet NO<sub>x</sub> emission standards within CI engine averaging sets. We may adopt BEV and FCEV NO<sub>x</sub> emission credit sunset provisions in the final rule, and we request comment on both the broad approach of sunsetting NO<sub>x</sub> emission credits for BEVs and FCEVs, as well as how EPA could determine a specific time period or other metric (*e.g.*, percentage of manufacturer sales that are BEVs or FCEVs, percentage of U.S. heavy-duty fleet that are BEVs or FCEVs) for ending NO<sub>x</sub> emission credit generation and use for BEVs and FCEVs.

<sup>705</sup> As noted in Section IV.I.1 and specified in proposed 40 CFR 1037.102(b)(1) and 40 CFR 1036.741, we are proposing that NO<sub>x</sub> emission credits generated from BEVs and FCEVs may only be used within Light HDE, Medium HDE and Heavy HDE averaging sets. We are requesting comment on whether to allow NO<sub>x</sub> emission credits generated by BEVs or FCEVs to be used for the SI engine service class, but do not expect NO<sub>x</sub> emission credits from BEVs and FCEVs to result in higher-emitting SI engines under our proposed approach.

<sup>706</sup> We use MY 2031 as an example here; we may finalize one or more of the options presented in this Section IV.I.3 for an earlier or later model year (see Section XI.C for more discussion).

Under the second option, we could establish or revise the numeric level of the NO<sub>x</sub> emission standards based in part on the availability of EV technology in the baseline fleet or in projected compliance options.<sup>707</sup> If, for example, the BEV and FCEV technologies were projected to reach a greater degree of market penetration than our current projections, we could incorporate that level of BEV and FCEV penetration into a calculation of an appropriate numerical standard to represent the combined benefits of achieving NO<sub>x</sub> control from engines along with zero tailpipe NO<sub>x</sub> emissions from BEV and FCEV technologies. Depending on achieved and forecasted future penetration rates and EPA decisions in the rulemaking, this option could lead to a more stringent NO<sub>x</sub> emission standard that would be achieved only if manufacturers develop and produce a certain number of powertrain technologies with zero-tailpipe NO<sub>x</sub> emissions. We request comment on both the broad principle of factoring BEV and FCEV penetration into an assessment of the feasibility of NO<sub>x</sub> emission standards in the final rule, or future rules, as well as data and methods that EPA could use to appropriately forecast market penetration levels and analyze cost and emissions impacts.

Under the third option, we could further restrict the generation and/or use of NO<sub>x</sub> emission credits from BEVs and FCEVs. Such restrictions could take one or more of the following forms. First, we could restrict NO<sub>x</sub> emission credits for BEVs and FCEVs to those powertrains that meet certain performance standards (*e.g.*, an energy efficiency standard). Alternatively, we could restrict the use of NO<sub>x</sub> emission credits from BEVs and FCEVs to a shorter period of time (*e.g.*, a credit life of two years for credits generated from BEVs and FCEVs, rather than the currently proposed five-year credit life). We request comment on the general concept of further restricting NO<sub>x</sub> emission credits from BEVs and FCEVs, as well as specific approaches that EPA could take to further restrict credits from these technologies.

<sup>707</sup> See Section III.A.2 for discussion on our decision not to rely on BEV or FCEV technologies in the development of our proposed standards for NO<sub>x</sub> emissions, as well as our current understanding of market projections for the MY 2027 timeframe and the type of information that may lead us to reevaluate our approach for the final rule. Section XI presents our analysis of EV market projections in the MY 2027 timeframe as they relate to the proposed revisions to HD GHG Phase 2 emission standards.

#### 4. Emission Credit Multipliers for Electric Vehicles

In some light-duty and heavy-duty vehicle ABT programs, EPA has provided for emission credit multipliers for advanced technologies such as HEVs, BEVs, and FCEVs. As discussed in Section XI, the HD GHG Phase 2 program currently provides multipliers of 3.5, 4.5, and 5.5 for HEVs, BEVs, and FCEVs, respectively. Emission credit multipliers are an approach to incentivize the investments that manufacturers make to develop and produce technologies that are considered “advanced” at the time of a rulemaking; however, the use of multipliers can result in the production of a larger number of higher emitting engines or vehicles than the number of lower emitting, advanced technology engines or vehicles on which the credits are based, since the multiplier inherently pairs one new advanced technology, low-emitting engine or vehicle with more than one new less-advanced higher emitting engine or vehicle.

For this proposal, we do not believe that advanced technology NO<sub>x</sub> emission credit multipliers are appropriate for HEVs, BEVs, or FCEVs. We are choosing not to propose NO<sub>x</sub> emission credit multipliers for several reasons. First, specific to HEVs, these technologies have the potential to generate NO<sub>x</sub> emissions, and those emissions can vary based on the duty-cycle, battery state of charge, payload, and other factors. The potential variability in NO<sub>x</sub> emissions, and the likelihood for hybrid technology to become a primary technology pathway for meeting heavy-duty emission standards leads us to propose that NO<sub>x</sub> emission credit multipliers are not appropriate for HEVs (plug-in or more mild hybrid configurations).<sup>708</sup>

For BEVs and FCEVs, we are not proposing emission credit multipliers for two reasons. First, multipliers inherently reduce the NO<sub>x</sub> emission benefits of the proposal to a greater extent than credits alone since the production of a single BEV or FCEV may be used to offset a greater number of CI engines emitting above the standard up to the FEL cap. We believe that the combination of FEL caps limiting the extent to which an engine could emit above the standard and the zero-tailpipe emission performance of BEVs and FCEVs warrant emission credits but not

<sup>708</sup> For more discussion on hybrid technology use in the heavy-duty fleet see MECA 2020, “Technology Feasibility for Heavy-Duty Diesel Trucks in Achieving 90% Lower NO<sub>x</sub> Standards in 2027”, available online at: [https://www.meca.org/wp-content/uploads/resources/MECA\\_2027\\_Low\\_NOx\\_White\\_Paper\\_FINAL.pdf](https://www.meca.org/wp-content/uploads/resources/MECA_2027_Low_NOx_White_Paper_FINAL.pdf).

credit multipliers. Second, the current state of technology development and implementation of HD BEVs and FCEVs leads us to believe that these technologies, while still relatively nascent compared to CI and SI engines, are mature enough not to warrant emission credit multipliers. For instance, numerous reports document growing numbers of BEVs and FCEVs entering the market over the next few model years (see draft RIA Chapter 1.4). In addition, a recent analysis shows that BEV technologies will reach parity in total cost of ownership with CI or SI engine technologies in most market segments by 2025 or earlier.<sup>709</sup> The emission credit multipliers in the HD GHG Phase 2 rule were calculated based on higher costs of the particular advanced technologies they were targeting relative to conventional vehicles. The expectations for growing adoption of BEV and FCEV technologies combined with expectations that the technologies will reach cost parity in the near-term with conventional technologies lead us to propose that NO<sub>x</sub> emission credit multipliers, in the form of advanced technology credit multipliers or Early Adoption Incentive credit multipliers described in Section IV.H, would not apply for BEVs and FCEVs for the proposed criteria pollutant standards.<sup>710</sup>

Although we are not proposing multipliers, we nonetheless request comment on whether to include NO<sub>x</sub> emission credit multipliers for HEVs, BEVs, or FCEVs in the final rule. We recognize that there may be alternative approaches to our proposal, including the alternatives detailed below with our request for comment. Commenters are encouraged to submit data supporting their suggested approaches (e.g., emissions impacts or manufacturing costs of advanced powertrain technologies).

For instance, EPA is interested in whether emission credit multipliers might be appropriate for specific market segments for which heavy-duty EV

technology development may be more challenging (e.g., extended range battery-electric or hydrogen fuel cell). We recognize that current heavy-duty EV technologies generally claim to offer a range of 250 miles or less prior to needing to recharge.<sup>711</sup> While there are a number of manufacturers with plans to produce or demonstrate BEVs or FCEVs with longer-range capabilities in next few model years, these longer-range capabilities would likely experience more challenges to market entry than shorter-range vehicles (e.g., charging/hydrogen refilling infrastructure, battery density, powertrain efficiency).<sup>712 713 714</sup> Based on these challenges, it could make sense to provide interim incentives such as multipliers for BEVs or FCEVs capable of driving longer ranges prior to recharging/refilling (e.g., 300+ miles). Under this approach, EPA could provide a multiplier for longer-range BEVs or FCEVs (e.g., no multiplier for vehicles capable of <300 miles, multiplier of 1.5 for vehicles capable of ≥300 to 500 miles, multiplier of 2 for vehicles capable of >500 miles). In any case, EPA anticipates that incentives associated with specific performance criteria like the capability of driving a certain distance prior to recharging or refilling would need to include a requirement for manufacturers to demonstrate that capability to ensure the performance for which they are generating credits. We encourage commenters who support an approach that incentivizes specific attributes or performance criteria to comment on what demonstration requirement would be appropriate.<sup>715</sup>

In addition, EPA solicits comment on whether emission credit multipliers for specific model years would be appropriate (e.g., 2 for MY 2023–2024;

1.5 for MY 2025–2026). We are also interested in commenters' views on whether BEVs and FCEVs should have different numeric multiplier values. Both technologies have knowledge and performance gaps to overcome in entering the market (e.g., battery density, charging/refilling infrastructure, duty cycle requirements analyses), and both technologies will likely be used in different applications across the heavy-duty market.<sup>716 717</sup> Nevertheless, there may be inherent differences that lead to treating BEVs and FCEVs differently regarding multipliers.

Similarly, we are choosing not to propose advanced technology credit multipliers for HEVs, including plug-in HEVs (PHEVs), due to inherent differences in tailpipe emission performance relative to BEVs and FCEVs; however, we request comment on whether PHEVs should be eligible for credit multipliers, and if so, how manufacturers could demonstrate real-world NO<sub>x</sub> emission reductions given differences in emissions based on factors such as driving behavior or charging rate or frequency.

We request comment on all of these alternative options (model year ranges, multiplier numeric value, common versus specific multiplier(s) for BEV and FCEV technologies, and potential PHEV multiplier), or additional alternatives commenters identify related to potential emission credit multipliers for HEVs, BEVs, and FCEVs. If commenters recommend that EPA include emission credit multipliers for HEVs, BEVs, and/or FCEVs, then we encourage them to provide input and submit data on how EPA should evaluate the potential emission impacts of any credit multipliers. Commenters are also encouraged to submit data and analyses relevant to BEV and FCEV sales projections, fleet turnover, and other relevant information for such an analysis.

### J. Fuel Quality

EPA has long recognized the importance of fuel quality on motor vehicle emissions and has regulated fuel quality to enable compliance with emission standards. In 1993, EPA limited diesel sulfur content to a maximum of 500 ppm and put into

<sup>709</sup> MJ Bradley (2021) "Medium- & Heavy-Duty Vehicles: Market structure, Environmental Impact, and EV Readiness. Available online at: <https://www.edf.org/sites/default/files/documents/EDFMHDEVFeasibilityReport22jul21.pdf> (last accessed August 21, 2021).

<sup>710</sup> See Section XI for discussion on our current thinking for emission credit multipliers under the HD GHG Phase 2 program. We are requesting comment on potential revisions to the emission credit multipliers under the GHG Phase 2 program and are proposing emission credit multipliers are not appropriate under the proposed criteria program based on current information. We are not proposing any changes to advanced technology credit multipliers already established for other programs or taking comment on emission credit multipliers offered in previous rulemakings.

<sup>711</sup> UCS (2019) "Ready for Work: Now Is the Time for Heavy-Duty Electric Vehicles"; [www.ucsusa.org/resources/ready-work](http://www.ucsusa.org/resources/ready-work).

<sup>712</sup> NACFE (2019) "Guidance Report: Viable Class 7/8 Electric, Hybrid and Alternative Fuel Tractors", available online at: <https://nacfe.org/downloads/viable-class-7-8-alternative-vehicles/>.

<sup>713</sup> Nadel, S. and Junga, E. (2020) "Electrifying Trucks: From Delivery Vans to Buses to 18-Wheelers". American Council for an Energy-Efficient Economy White Paper, available online at: <https://aceee.org/white-paper/electrifying-trucks-delivery-vans-buses-18>.

<sup>714</sup> Smith, D. et al. (2019) "Medium- and Heavy-Duty Electrification An Assessment of Technology and Knowledge Gaps". Oak Ridge National Laboratory and National Renewable Energy Laboratory. ORNL/SPR–2020/7.

<sup>715</sup> Similar to the discussion in Section III on in-use testing procedures, we encourage commenters to include suggestions for non-traditional demonstration mechanisms, such as the use of production or demonstration vehicle data if it could be supplied in sufficient quantity, quality, and representation of certification products.

<sup>716</sup> NACFE (2019) "Guidance Report: Viable Class 7/8 Electric, Hybrid and Alternative Fuel Tractors", available online at: <https://nacfe.org/downloads/viable-class-7-8-alternative-vehicles/>.

<sup>717</sup> Smith, D. et al. (2019) "Medium- and Heavy-Duty Electrification An Assessment of Technology and Knowledge Gaps". Oak Ridge National Laboratory and National Renewable Energy Laboratory. ORNL/SPR–2020/7.

place a minimum cetane index of 40. Starting in 2006 with the establishment of more stringent heavy-duty highway PM, NO<sub>x</sub> and hydrocarbon emission standards, EPA phased-in a 15-ppm maximum diesel fuel sulfur standard to enable heavy-duty diesel truck compliance with the more stringent emission standards.<sup>718</sup>

EPA continues to recognize the importance of fuel quality on heavy-duty vehicle emissions and is not currently aware of any additional diesel fuel quality requirements that would be necessary for controlling criteria pollutant emissions from these vehicles.

### 1. Biodiesel Fuel Quality

As discussed in Chapter 2.3.2 of the draft RIA, metals (*e.g.*, Na, K, Ca, Mg) can enter the biodiesel production stream and can adversely affect emission control system performance if not sufficiently removed during production. Our review of data collected by NREL, EPA, and CARB indicates that biodiesel is compliant with the ASTM D6751–18 limits for Na, K, Ca, and Mg. As such, we are not proposing to regulate biodiesel blend metal content at this time because the available data does not indicate that there is widespread off specification biodiesel blend stock or biodiesel blends in the marketplace.

While occasionally there are biodiesel blends with elevated levels of these metals, they are the exception. Data in the literature indicates that Na, K, Ca, and Mg levels in these fuels are less than 100 ppb on average. Data further suggest that the low levels measured in today's fuels are not enough to adversely affect emission control system performance when the engine manufacturer properly sizes the catalyst to account for low-level exposure.

Given the low levels measured in today's fuels, however, the ASTM is currently evaluating a possible revision to the measurement method for Na, K, Ca, and Mg in D6751–18 from EN14538 to a method that has lower detection limits (*e.g.*, UOP–389–15, ASTM D7111–16, or a method based on the ICP–MS method used in the 2016 NREL study). We anticipate that ASTM will likely specify Na, K, Ca, and Mg limits in ASTM 7467–19 for B6 to B20 blends that is an extrapolation of the B100 limits (see draft RIA Chapter 2.3.2 for additional discussion of ASTM test methods, as well as available data on levels of metal in biodiesel and potential impacts on emission control systems).

### 2. Compliance Issues Related to Biodiesel Fuel Quality

Given the concerns we raised in the ANPR regarding the possibility of catalyst poisoning from metals contained in biodiesel blends and specifically heavy-duty vehicles fueled on biodiesel blends, EPA requests comment on providing a process to receive EPA approval to exempt test results from in-use testing compliance and test results being considered for potential recall if an engine manufacturer can show that the vehicle was historically fueled with biodiesel blends whose B100 blend stock did not meet the ASTM D6751–20a limit for Na, K, Ca, and/or Mg metal (metals which are a byproduct of biodiesel production). The potential approach we are requesting comment on would include requiring the engine manufacturer to provide proof of historic misfueling with off-specification biodiesel blends, which would include an analysis of the level of the poisoning agents on the catalysts in the engine's aftertreatment system, to qualify for the test result exemption(s).

#### *K. Other Flexibilities Under Consideration*

##### 1. Overview of Verification Testing and Request for Comment on Interim In-Use Standards

To verify that heavy-duty engines are meeting emission standards and other certification requirements throughout useful life, EPA regulations provide for testing engines at various stages in the life of an engine. These compliance provisions are confirmatory testing, selective enforcement audit (SEA) testing, and in-use testing.<sup>719</sup> First, EPA may conduct confirmatory testing before an engine is certified to verify the manufacturer's test results with our own results.<sup>720</sup> If conducted, the EPA confirmatory test results become official test results and are compared against the manufacturer's FEL, or family certification limit (FCL) for CO<sub>2</sub>. Second, EPA may require a manufacturer to conduct SEA testing of engines that come off the production line.<sup>721</sup> Third, EPA and manufacturers can conduct in-use testing of engines that have already entered commerce.<sup>722</sup>

<sup>719</sup> In this section the phrase "in-use testing" refers to duty-cycle and off-cycle testing of field aged engines and does not refer solely to manufacturer run in-use testing.

<sup>720</sup> Confirmatory testing is addressed in proposed 40 CFR 1036.235.

<sup>721</sup> SEA testing is conducted according to current 40 CFR part 1068, subpart E.

<sup>722</sup> In-use testing is covered in the proposed 40 CFR part 1036, subpart E.

In-use testing is used to verify that the engine meets applicable duty cycle or off-cycle emission standards throughout useful life.

Typically, EPA sets the same standards for certification testing and in-use testing but, in a few cases, we have allowed temporary higher numerical in-use standards to give manufacturers time to gain experience with the new technology needed to meet the standards and reflect uncertainties about potential variabilities in performance during the early years of implementing new technology.<sup>723 724</sup> As discussed in Section III, we are proposing lower numerical standards and longer useful life periods for HD highway engines, which would require manufacturers to include additional technology on the engines they manufacture. As discussed in Section III.A.3, we are conducting extensive analyses on the performance of next-generation SCR systems and engine CDA technology that in combination can effectively reduce NO<sub>x</sub> emissions to meet the proposed standards out to at least 435,000 miles. While we expect the data that we are continuing to gather for the final rule would show that these technologies continue to be capable of meeting the proposed Option 1 numeric levels of the standards for Heavy HDEs out through 800,000 miles, we are considering the degree to which there is uncertainty in how the emissions control technologies deteriorate when the engine is installed in the wide variety of heavy-duty vehicle applications that exist in the marketplace and how to address such uncertainty.

Given the potential for uncertainty in how the emissions control technologies would deteriorate in the field and across different vehicle applications, we are soliciting comment on providing engine manufacturers with higher (numerical) standards for an interim period to gain experience with the additional emission control technologies needed to meet the proposed Heavy HDE NO<sub>x</sub> standards (and their rates of deterioration) while those technologies are operating in the field. Manufacturers could, for instance, use the interim period to collect data from field-aged engines in a range of applications to inform how the engines can be designed to meet the standards throughout useful life for all applications in which the engine is used.

In setting the duration of an interim period we would consider how long it would take manufacturers to collect

<sup>723</sup> See 81 FR 23479, April 28, 2014.

<sup>724</sup> See 66 FR 5002, January 18, 2001.

<sup>718</sup> 66 FR 5002 January 18, 2001.

field data from engines operating out to the useful life mileage ultimately finalized in this rule. For example, if we were to finalize a useful life mileage of 800,000 for Heavy HDEs and assume that vehicles with Heavy HDEs typically travel 100,000 miles per year, then we could consider that manufacturers who collect data from pre-production test fleets starting in 2025 would have field-aged parts out to 800,000 miles by 2033 (i.e., an eight-year period for data collection and a six-year interim period from the start of the proposed MY 2027 standards).

We understand that manufacturers generally aim to design and build

vehicles not only with a sufficient margin to ensure the emissions control technology is meeting the applicable standards throughout the full useful life, but also an additional margin to reflect the fact that not every vehicle manufactured and every vehicle application will perform identically to the laboratory tests.<sup>725</sup> This is particularly important, and challenging for manufacturers, when new technologies and test procedures are being implemented. Thus, if we observe as part of EPA’s engine demonstration study that the engine just meets the proposed standards including

accounting for deterioration then we may consider adopting higher temporary in-use standards than if we observe the engine performing better compared to the proposed Option 1 standards after being aged to the equivalent of 800,000 miles. In this rulemaking, we may consider adopting higher temporary in-use standards for all of the proposed duty-cycle and off-cycle NO<sub>x</sub> standards for Heavy HDEs in 40 CFR 1036.104. Table IV–16 and Table IV–17 present the range of interim in-use standards that we are considering for MY 2027 through MY 2033 Heavy HDEs under proposed Option 1.

TABLE IV–16—RANGE OF POTENTIAL INTERIM IN-USE NO<sub>x</sub> FTP, SET AND LLC STANDARDS FOR MY 2027 THROUGH 2033 HEAVY HDES UNDER PROPOSED OPTION 1

Range <sup>a</sup>	Model year	In-use FTP standards	In-use SET standards	In-use LLC standards
		NO <sub>x</sub> (mg/hp-hr)		
Low End of the Range .....	2027–2030 .....	49	49	126
	2031 and later through intermediate useful life .....	28	28	70
	2031 and later for full useful life .....	56	56	140
High End of the Range .....	2027–2030 .....	70	70	180
	2031 and later through intermediate useful life .....	40	40	100
	2031 and later for full useful life .....	80	80	200

<sup>a</sup> The table defines the range of in-use standards we are considering for proposed Option 1. We would only finalize one standard for each, not a range.

TABLE IV–17—RANGE OF POTENTIAL INTERIM IN-USE NO<sub>x</sub> IDLE, LOW-LOAD AND MEDIUM/HIGH LOAD OFF-CYCLE STANDARDS FOR MY 2027 THROUGH 2033 HEAVY HDES UNDER PROPOSED OPTION 1

Range <sup>a</sup>	Model year	In-use off-cycle idle standards	In-use off-cycle low load standards	In-use off-cycle medium/high load standards
		NO <sub>x</sub> (g/hr)	NO <sub>x</sub> (mg/hp-hr)	
Low End of the Range.	2027–2030 .....	14	252	98
	2031 and later through intermediate useful life .....	11	105	42
	2031 and later for full useful life .....	11	210	84
High End of the Range.	2027–2030 .....	20	360	140
	2031 and later through intermediate useful life .....	15	150	60
	2031 and later for full useful life .....	15	300	120

<sup>a</sup> The table defines the range of in-use standards we are considering for proposed Option 1. We would only finalize one standard for each, not a range.

We request comment on whether we should consider including in the final rule interim in-use standards to account for uncertainties about potential variabilities in performance during the early years of implementing new technology. Commenters are encouraged to provide input on what types of information we should consider when

setting the duration and level of any interim in-use standard, and whether the ones included in discussion in this section are appropriate, or if there are other considerations that would be important for setting an interim in-use standard. In particular we are seeking comment on whether, and if so how, to take into consideration the effects of

fuel quality of biodiesel blends discussed in Section IV.J.2 in establishing interim in-use standards, or whether that is unnecessary if we were to finalize both an interim in-use standard for heavy HDE NO<sub>x</sub> standards and an allowance to exempt test results from engines that have been historically misfueled with off specification

<sup>725</sup> As discussed in Chapter 3 of the draft RIA, manufacturer margins can range from less than 25 percent to 100 percent of the FEL.

biodiesel blends. We also request input on whether any interim in-use standard should apply to engine classes other than heavy HDEs under proposed Option 1, and whether we should consider including interim in-use standards for pollutants other than NO<sub>x</sub> under proposed Option 1. Finally, we request that commenters provide any available field data on deterioration of next-generation SCR emission controls, or other technologies that could achieve the proposed standards throughout the proposed useful life periods.

## 2. Production Volume Allowance for Model Years 2027 Through 2029

We are considering a flexibility allowing engine manufacturers, for model years 2027 through 2029 only, to certify up to 5 percent of their total production volume of heavy-duty highway compression-ignition (CI) engines in a given model year to the current, pre-MY 2027 engine provisions of 40 CFR part 86, subpart A. The allowance we are considering would be limited to Medium HDE or Heavy HDE engine families that manufacturers show would be used in low volume, specialty vocational vehicles. Such an allowance from the MY 2027 criteria pollutant standards may be necessary to provide engine and vehicle manufacturers additional lead time and flexibility to redesign some low sales volume products to accommodate the technologies needed to meet the proposed more stringent engine emission standards. One example of a low sales volume vocational vehicle type for which this flexibility could be appropriate is fire trucks, where the design cycles are typically longer than other HD on-highway products and packaging of new exhaust aftertreatment components within existing designs may potentially present a challenge to engine, chassis, and body manufacturers. Under this potential option, we are requesting comment on cases where packaging and design challenges are present, allowing specialty vocational vehicle manufacturers to install exempt engines, as long as the number of exempt engines installed does not exceed 5 percent of the engine manufacturer's total production volume.

We request comment on this potential option of a three-year allowance from the proposed MY 2027 criteria pollutant standards for engines installed in specialty vocational vehicles, including whether and why this flexibility is warranted and whether 5 percent of a manufacturer's engine production volume is an appropriate value for such an interim provision. In addition, we

request comment on whether this flexibility should be limited to specific vocational vehicle regulatory subcategories and the engines used in them.

## V. Proposed Program Costs

In Chapter 3 of the draft RIA, we present the direct manufacturing costs of the technologies we expect to be used to comply with the proposed standards. In this section we build upon those direct manufacturing costs to estimate the year-over-year costs going forward from the first year of each phase of implementation. We also present the indirect costs associated with the expected technologies. Like direct costs, indirect costs are expected to increase under the proposal, in large part due to the proposed warranty and useful life changes. The analysis also includes estimates of the possible operating costs associated with the proposed changes. We present total costs associated with proposed Options 1 and 2 in Section V.C. All costs are presented in 2017 dollars consistent with AEO 2018, unless noted otherwise.

We request comment on all aspects of the cost analysis. In particular, we request comment on our estimation of warranty and research and development costs via use of scalars applied to indirect cost contributors (see Section V.A.2) and our estimates of emission repair cost impacts (see Section V.B.3). We also request comments that include supporting data and/or alternative approaches that we might consider when developing estimates for the final rulemaking.

### A. Technology Package Costs

Technology costs are associated with the two phases of the proposed Option 1 standards in MY 2027 and MY 2031, and with the single phase of the proposed Option 2 standards in MY 2027 (see Chapter 3 of the draft RIA). Individual technology piece costs are presented in Chapter 3 of the draft RIA and, in general, consist of the direct manufacturing costs (DMC) estimated for the first year of each phase of the proposed Option 1, or the first year of Option 2 standards, and are used as a starting point in estimating program costs. Following each year of when costs are first incurred, we have applied a learning effect to represent the cost reductions expected to occur via the "learning by doing" phenomenon. This provides a year-over-year cost for each technology as applied to new engine sales. We then applied industry standard "retail price equivalent" (RPE) markup factors industry-wide, with adjustments discussed below, to

estimate indirect costs associated with each technology. Both the learning effects applied to direct costs and the application of markup factors to estimate indirect costs are consistent with the cost estimation approaches used in EPA's past transportation-related regulatory programs. The sum of the direct and indirect costs represents our estimate of technology costs per vehicle on a year-over-year basis where MY 2031 and later costs include costs associated with MY 2027 and later. These technology costs multiplied by estimated sales then represent the total technology costs associated with the proposed standards.

This cost calculation approach presumes that the expected technologies would be purchased by original equipment manufacturers (OEMs) from their suppliers. So, while the DMC estimates include the indirect costs and profits incurred by the supplier, the indirect cost markups we apply cover the indirect costs incurred by OEMs to incorporate the new technologies into their vehicles and to cover profit margins typical of the heavy-duty truck industry. We discuss the indirect cost markups in more detail below.

### 1. Direct Manufacturing Costs

To produce a unit of output, manufacturers incur direct and indirect costs. Direct costs include cost of materials and labor costs. Indirect costs are discussed in the following section. The direct manufacturing costs presented here include individual technology costs for emission-related engine components and exhaust aftertreatment systems (EAS).

Notably, for this analysis we include not only the marginal increased costs associated with the proposed Options 1 or 2, but also the emission control system costs for the baseline, or no action, case.<sup>726</sup> Throughout this discussion we refer to baseline case costs, or baseline costs, which reflect our cost estimate of engine systems—that portion that is emission-related—and the exhaust aftertreatment system absent impacts of this proposed rule. This inclusion of baseline system costs contrasts with EPA's approach in recent greenhouse gas rules or the light-duty Tier 3 criteria pollutant rule where we estimated costs relative to a baseline case, which obviated the need to

<sup>726</sup> See Section VI for more information about the emission inventory baseline and how that baseline is characterized. For this cost analysis, the baseline, or no action, case consists of engines and emission control systems meeting 2019 era criteria emission standards but in 2027 and later model years. Our rationale for including costs for the no action case is described in this section.



estimate baseline costs. We have included baseline costs in this analysis because under both of the proposed options the emissions warranty and regulatory useful life provisions are expected to have some impact on not only the new technology added to comply with the proposed standards, but also on emission control technologies already developed and in use.<sup>727</sup> The baseline direct manufacturing costs detailed below are intended to reflect that portion of baseline case engine hardware and aftertreatment systems for which new indirect costs would be incurred due to the proposed warranty and useful life provisions, even apart from changes in the level of emission standards.

We have estimated the baseline engine costs based on recently completed studies by the International Council on Clean Technology (ICCT) as discussed in more detail in Chapter 7 of the draft RIA. As discussed there, the baseline engine costs consist of turbocharging, fuel system, exhaust gas

recirculation, etc. These costs represent those for technologies that would be subject to extended warranty and useful life provisions under this proposal. For cylinder deactivation costs under the proposal, we have used FEV-conducted teardown-based cylinder deactivation costs as presented in Chapter 3 of the draft RIA.<sup>728</sup> As for the EAS costs, those are also presented in Chapter 3 of the draft RIA and, as discussed there, are based on an ICCT methodology with extensive revision by EPA. As discussed in draft RIA Chapter 3, we also have EAS cost estimates from a recent FEV-conducted teardown study.<sup>729</sup> As discussed in Chapter 3 of the draft RIA, these teardown-based estimated EAS costs are similar to the EPA-estimated costs and we may use those FEV-study teardown-based cost estimates in the final rule. The direct manufacturing costs for the baseline engine+aftertreatment and for the proposed Options 1 and 2 are shown for diesel engines in Table V–1, gasoline engines in Table V–2 and CNG engines

in Table V–3. Note that direct manufacturing costs for proposed Options 1 and 2 are equivalent because we expect that the same technologies would be needed to meet the standards in each option. Costs are shown for regulatory classes included in the cost analysis and follow the categorization approach used in our MOVES model. Please refer to Chapter 6 of the draft RIA for a description of the regulatory classes and why the tables that follow include or do not include each regulatory class. In short, where MOVES has regulatory class populations and associated emission inventories, our cost analysis estimates costs. Note also that, throughout this section, LHD = light heavy-duty, MHD = medium heavy-duty, HHD = heavy heavy-duty, CDPF = catalyzed diesel particulate filter, DOC = diesel oxidation catalyst, SCR = selective catalytic reduction, HC = hydrocarbon, and CNG = compressed natural gas.

TABLE V–1—DIESEL TECHNOLOGY AND PACKAGE DIRECT MANUFACTURING COSTS PER VEHICLE BY REGULATORY CLASS FOR PROPOSED OPTIONS 1 AND 2, MY2027, 2017 DOLLARS <sup>a</sup>

MOVES regulatory class	Technology	Baseline	Proposed Options 1 and 2 (MY2027 increment to baseline)
LHD2b3 .....	LHD2b3 Package .....	\$3,788	\$1,616
	Engine hardware .....	1,097	0
	Closed crankcase .....	0	0
	Cylinder deactivation .....	0	196
	CDPF .....	504	0
	DOC .....	350	0
	SCR .....	1,837	1,174
	Canning .....	0	30
	HC dosing .....	0	216
LHD45 .....	LHD45 Package .....	3,806	1,653
	Engine hardware .....	1,097	0
	Closed crankcase .....	18	37
	Cylinder deactivation .....	0	196
	CDPF .....	504	0
	DOC .....	350	0
	SCR .....	1,837	1,174
	Canning .....	0	30
	HC dosing .....	0	216
MHD67 .....	MHD67 Package .....	4,032	1,619
	Engine hardware .....	1,254	0
	Closed crankcase .....	18	37
	Cylinder deactivation .....	0	147
	CDPF .....	570	0
	DOC .....	316	0
	SCR .....	1,875	1,183
	Canning .....	0	36
	HC dosing .....	0	216
HHD8 .....	HHD8 Package .....	6,457	2,210
	Engine hardware .....	2,038	0

<sup>727</sup> The proposed warranty and useful life provisions would increase costs not only for the new technology added in response to the proposal, but also for the technology already in place (to which the new technology is added) because the proposed warranty and useful life provisions would

apply to the entire emission-control system, not just the new technology added in response to the proposed standards.

<sup>728</sup> Mamidanna, S. 2021. Heavy-Duty Engine Valvetrain Technology Cost Assessment. U.S. EPA Contract with FEV North America, Inc., Contract

No. 68HERC19D0008, Task Order No. 68HERH20F0041. Submitted to the Docket.

<sup>729</sup> Mamidanna, S. 2021. Heavy-Duty Vehicles Aftertreatment Systems Cost Assessment. Submitted to the Docket.

TABLE V-1—DIESEL TECHNOLOGY AND PACKAGE DIRECT MANUFACTURING COSTS PER VEHICLE BY REGULATORY CLASS FOR PROPOSED OPTIONS 1 AND 2, MY2027, 2017 DOLLARS <sup>a</sup>—Continued

MOVES regulatory class	Technology	Baseline	Proposed Options 1 and 2 (MY2027 increment to baseline)
	Closed crankcase .....	18	37
	Cylinder deactivation .....	0	206
	CDPF .....	1,067	0
	DOC .....	585	0
	SCR .....	2,750	1,681
	Canning .....	0	71
	HC dosing .....	0	216
Urban bus ....	Urban bus Package .....	4,082	1,653
	Engine hardware .....	1,254	0
	Closed crankcase .....	18	37
	Cylinder deactivation .....	0	147
	CDPF .....	567	0
	DOC .....	314	0
	SCR .....	1,929	1,469
	Canning .....	0	0
	HC dosing .....	0	0

TABLE V-2—GASOLINE TECHNOLOGY AND PACKAGE DIRECT MANUFACTURING COSTS PER VEHICLE BY REGULATORY CLASS FOR PROPOSED OPTIONS 1 AND 2, MY2027, 2017 DOLLARS <sup>a</sup>

MOVES regulatory class	Technology	Baseline	Proposed Options 1 and 2 (MY2027 increment to baseline)
LHD45 .....	LHD45 Package .....	\$832	\$417
	Engine hardware .....	523	0
	Aftertreatment .....	309	393
	ORVR .....	0	24
MHD67 .....	MHD67 Package .....	832	417
	Engine hardware .....	523	0
	Aftertreatment .....	309	393
	ORVR .....	0	24
HHD8 .....	HHD8 Package .....	832	417
	Engine hardware .....	523	0
	Aftertreatment .....	309	393
	ORVR .....	0	24

<sup>a</sup> Note that the analysis uses the baseline plus the proposal cost—i.e., Baseline+Proposal—when estimating total costs; the incremental costs are shown here for ease of understanding the increased costs associated with the proposed Option 1 or 2. Note also that all LHD2b3 gasoline vehicles are chassis certified so are not expected to incur any costs associated with this proposal.

TABLE V-3—CNG TECHNOLOGY AND PACKAGE DIRECT MANUFACTURING COSTS PER VEHICLE BY REGULATORY CLASS, FOR PROPOSED OPTIONS 1 AND 2, MY2027, 2017 DOLLARS <sup>a</sup>

MOVES regulatory class	Technology	Baseline	Proposed Options 1 and 2 (MY2027 increment to baseline)
HHD8 .....	HHD8 Package .....	\$4,108	\$27
	Engine hardware .....	896	0
	Aftertreatment .....	3,212	27
Urban bus ....	Urban bus Package .....	3,081	19
	Engine hardware .....	672	0
	Aftertreatment .....	2,409	19

<sup>a</sup> Note that the analysis uses the baseline plus the proposal cost—i.e., Baseline+Proposal—when estimating total costs; the incremental costs are shown here for ease of understanding the increased costs associated with the proposed Option 1 or 2. MOVES does not have any MHD67 CNG vehicles. Note also that the urban bus regulatory class consists of MHD engines but is shown here as urban bus for consistency with MOVES vehicle populations and inventories.

The direct costs are then adjusted to account for learning effects going forward from the first year of each phase

of implementation for proposed Option 1, or simply the first year of implementation for proposed Option 2.

We describe in detail in Chapter 7 of the draft RIA the approach used to apply learning effects in this analysis.

Learning effects were applied on a technology package cost basis, and MOVES-projected sales volumes were used to determine first-year sales and cumulative sales. The resultant direct manufacturing costs and how those costs decrease over time are presented in Section V.A.3.

2. Indirect Costs

Indirect costs are all the costs associated with producing the unit of output that are not direct costs—for example, they may be related to production (such as research and development (R&D)), corporate operations (such as salaries, pensions, and health care costs for corporate staff), or selling (such as transportation, dealer support, and marketing). Indirect costs are generally recovered by allocating a share of the indirect costs to each unit of good sold. Although direct costs can be allocated to each unit of good sold, it is more challenging to account for

indirect costs allocated to a unit of goods sold. To ensure that regulatory analyses capture the changes in indirect costs, markup factors (which relate total indirect costs to total direct costs) have been developed and used by EPA and other stakeholders. These factors are often referred to as retail price equivalent (RPE) multipliers. RPE multipliers provide, at an aggregate level, the relative shares of revenues, where:

$$\begin{aligned} \text{Revenue} &= \text{Direct Costs} + \text{Indirect Costs} \\ \text{Revenue}/\text{Direct Costs} &= 1 + \text{Indirect Costs}/\text{Direct Costs} \\ \text{Direct Costs} &= \text{Retail Price Equivalent (RPE)} \\ \text{Resulting in:} \\ \text{Indirect Costs} &= \text{Direct Costs} \times (\text{RPE}-1) \end{aligned}$$

If the relationship between revenues and direct costs (*i.e.*, RPE) can be shown to equal an average value over time, then an estimate of direct costs can be multiplied by that average value to estimate revenues, or total costs. Further, that difference between estimated revenues, or total costs, and

estimated direct costs can be taken as the indirect costs. Cost analysts and regulatory agencies have frequently used these multipliers to predict the resultant impact on costs associated with manufacturers' responses to regulatory requirements and we are using that approach in this analysis.

The proposed cost analysis estimates indirect costs by applying the RPE markup factor used in past rulemakings (such as those setting greenhouse gas standards for heavy-duty trucks).<sup>730</sup> The markup factors are based on financial filings with the Securities and Exchange Commission for several engine and engine/truck manufacturers in the heavy-duty industry.<sup>731</sup> The RPE factors for HD engine manufacturers, HD truck manufacturers and for the HD truck industry as a whole are shown in Table V-4. Also shown in Table V-4 are the RPE factors for light-duty vehicle manufacturers.<sup>732</sup>

TABLE V-4—RETAIL PRICE EQUIVALENT FACTORS IN THE HEAVY-DUTY AND LIGHT-DUTY INDUSTRIES

Cost contributor	HD truck industry	LD vehicle industry
Direct manufacturing cost .....	1.00	1.00
Warranty .....	0.03	0.03
R&D .....	0.05	0.05
Other (admin, retirement, health, etc.) .....	0.29	0.36
Profit (cost of capital) .....	0.05	0.06
RPE .....	1.42	1.50

For this analysis, EPA based indirect cost estimates for diesel and CNG regulatory classes on the HD Truck Industry RPE values shown in Table V-4. Because most of the proposed changes apply to engines, we first considered using the HD Engine Manufacturer values. However, the industry is becoming more vertically integrated and the costs we are analyzing are those that occur at the end purchaser, or retail, level. For that reason, we believe that the truck industry values represent the most appropriate factors for this analysis. For gasoline regulatory classes, we used the LD Vehicle Industry values shown in Table V-4 since they more closely represent the cost structure of manufacturers in that industry—Ford, General Motors, and Chrysler.

Of the cost contributors listed in Table V-4, Warranty and R&D are the elements of indirect costs that the

proposed requirements are expected to impact. As discussed in Section III of the preamble, EPA is proposing to lengthen the warranty period, which we expect to increase the contribution of warranty costs to the RPE. EPA is also proposing to extend the regulatory useful life, which we expect to result in increased R&D expenses as compliant systems are developed. Profit is listed to highlight that profit is being considered and included in the analysis. All other indirect cost elements—those encapsulated by the “Other” category, including General and Administrative Costs, Retirement Costs, Healthcare Costs, and other overhead costs—as well as Profits, are expected to scale according to their historical levels of contribution.

As mentioned, Warranty and R&D are the elements of indirect costs that the proposed requirements are expected to impact. Warranty expenses are the costs

that a business expects to or has already incurred for the repair or replacement of goods that it has sold. The total amount of warranty expense is limited by the warranty period that a business typically allows. After the warranty period for a product has expired, a business no longer incurs a warranty liability; thus, a longer warranty period results in a longer period of liability for a product. At the time of sale, companies are expected to set aside money in a warranty liability account to cover any potential future warranty claims. If and when warranty claims are made by customers, the warranty liability account is debited and a warranty claims account is credited to cover warranty claim expenses.<sup>733</sup>

To address the expected increased indirect cost contributions associated with warranty (increased funding of the warranty liability account) due to the proposed longer warranty requirements,

<sup>730</sup> 76 FR 57106; 81 FR 73478.

<sup>731</sup> Heavy Duty Truck Retail Price Equivalent and Indirect Cost Multipliers, Draft Report, July 2010.

<sup>732</sup> Rogozhin, A., et al., Using indirect cost multipliers to estimate the total cost of adding new

technology in the automobile industry. International Journal of Production Economics (2009), doi:10.1016/j.ijpe.2009.11.031.

<sup>733</sup> Warranty expense is recognized in the same period as the sales for the products that were sold,

if it is probable that an expense will be incurred and the company can estimate the amount of the expense (*AccountingTools.com*, December 24, 2020, accessed January 28, 2021).

we have applied scaling factors commensurate with the changes in proposed Option 1 or Option 2 to the number of miles included in the warranty period (i.e., VMT-based scaling factors). For example, the current required emission warranty period for Class 8 diesel trucks are 5 years or 100,000 miles. Proposed Option 1 would extend the required warranty period for a Class 8 diesel to 7 years or 450,000 miles for MYs 2027 through 2030, and then extend further to 10 years or 600,000 miles for MYs 2031 and beyond. As such, in our analysis of proposed Option 1 for Class 8 diesel trucks we applied a scaling factor of 4.5 (450/100) to the 0.03 warranty

contribution factor for MYs 2027 through 2030, and applied a scaling factor of 6.0 (600/100) for MYs 2031 and later. This same approach is followed for the other regulatory classes, and for our analysis of proposed Option 2.

Similarly, for R&D on that same Class 8 truck, the proposed Option 1 would extend regulatory useful life from 10 years or 435,000 miles to 11 years or 600,000 miles beginning in MY 2027, and then extend further to 12 years or 800,000 miles for MYs 2031 and later, we have applied a scaling factor of 1.38 (600/435) to the 0.05 R&D contribution factor for MYs 2027 through 2029, and then 1.33 (800/600) for MYs 2031 through 2033. Notice the different treatment of the scaling factors for R&D

versus those for warranty. We would expect that once the development efforts into longer useful life are complete, increased expenditures would return to their normal levels of contribution. As such, we have implemented the R&D scalars in three-year increments (2027 through 2029 and then 2031 through 2033). In MY 2034 and later (under the proposal), the R&D scaling factor would no longer be applied.

The VMT-based scaling factors applied to warranty and R&D cost contributors used in our cost analysis of proposed Options 1 and 2 are shown in Table V-5 for diesel and CNG regulatory classes and in Table V-6 for gasoline regulatory classes.

TABLE V-5—SCALING FACTORS APPLIED TO RPE CONTRIBUTION FACTORS TO REFLECT CHANGES IN THEIR CONTRIBUTIONS, DIESEL & CNG REGULATORY CLASSES

Scenario	MOVES regulatory class	Warranty scalars		R&D scalars		
		MY2027-2030	MY2031+	MY2027-2029	MY2031-2033	MY2034+
Baseline	LHD	1.00	1.00	1.00	1.00	1.00
	LHD45	1.00	1.00	1.00	1.00	1.00
	MHD67	1.00	1.00	1.00	1.00	1.00
	HHD8	1.00	1.00	1.00	1.00	1.00
	Urban Bus	1.00	1.00	1.00	1.00	1.00
Option 1	LHD	1.50	2.10	1.73	1.42	1.00
	LHD45	1.50	2.10	1.73	1.42	1.00
	MHD67	2.20	2.80	1.46	1.30	1.00
	HHD8	4.50	6.00	1.38	1.33	1.00
	Urban Bus	4.50	6.00	1.38	1.33	1.00
Option 2	LHD	1.10	1.10	2.27	1.00	1.00
	LHD45	1.10	1.10	2.27	1.00	1.00
	MHD67	1.50	1.50	1.76	1.00	1.00
	HHD8	3.50	3.50	1.49	1.00	1.00
	Urban Bus	3.50	3.50	1.49	1.00	1.00

TABLE V-6—SCALING FACTORS APPLIED TO RPE CONTRIBUTION FACTORS TO REFLECT CHANGES IN THEIR CONTRIBUTIONS, GASOLINE REGULATORY CLASSES

Scenario	MOVES regulatory class	Warranty scalars		R&D scalars		
		MY2027-2030	MY2031+	MY2027-2029	MY2031-2033	MY2034+
Baseline	LHD45	1.00	1.00	1.00	1.00	1.00
	MHD67	1.00	1.00	1.00	1.00	1.00
	HHD8	1.00	1.00	1.00	1.00	1.00
Option 1	LHD45	2.20	3.20	1.41	1.29	1.00
	MHD67	2.20	3.20	1.41	1.29	1.00
	HHD8	2.20	3.20	1.41	1.29	1.00
Option 2	LHD45	2.20	2.20	1.82	1.00	1.00
	MHD67	2.20	2.20	1.82	1.00	1.00
	HHD8	2.20	2.20	1.82	1.00	1.00

Lastly, as mentioned in Section V.A.1, the markups for estimating indirect costs are applied to our estimates of the absolute direct manufacturing costs for emission-control technology shown in Table V-1, Table V-2 and Table V-3, not just the incremental costs associated with the proposal (i.e., the Baseline+Proposal costs, not just the incremental costs of proposed Option 1

or 2). This is an important element of the analysis as shown by the hypothetical example in Table V-7. In the example, which is only for illustration, we assume that the baseline technology cost is \$5,000, the proposed incremental cost is \$1,000, and the indirect cost warranty contribution is 0.03 with a simple scalar of 1.5 associated with a longer warranty

period. In this case, the costs could be calculated according to two approaches, as shown. By including the baseline costs, we are estimating new warranty costs in the proposal as illustrated by the example where including baseline costs results in warranty costs of \$270 while excluding baseline costs results in warranty costs of \$45.

We request comment on the approach used here. Specifically, we request comment on the application of indirect costs to baseline plus incremental costs as just described and as illustrated in Table V-7. We also request comment on

the scaling approach used to estimate indirect cost impacts and the relative scaling of research and development costs along with their return to traditional levels following a three year period, and the absolute scaling of

warranty costs and their continuation at those levels in perpetuity rather than returning to traditional levels at some future point.

TABLE V-7—SIMPLIFIED HYPOTHETICAL EXAMPLE OF INDIRECT WARRANTY COSTS CALCULATED ON AN INCREMENTAL VS. ABSOLUTE TECHNOLOGY PACKAGE COST

[Values Are Not From the Analysis and Are for Presentation Only]

	Excluding baseline costs	Including baseline costs
Direct Manufacturing Cost (DMC) .....	\$1000 .....	\$5000 + \$1000 = \$6000
Indirect Warranty Costs .....	\$1000 × 0.03 × 1.5 = \$45 .....	\$6000 × 0.03 × 1.5 = \$270
DMC + Warranty .....	\$1000 + \$45 = \$1045 .....	\$1000 + \$270 = \$1270

3. Technology Costs per Vehicle

The following tables present the technology costs estimated for the proposed Options 1 and 2 on a per-vehicle basis for MY 2027 and MY 2031. Reflected in these tables are learning effects on direct manufacturing costs and scaling effects—associated with increased costs due to proposed program elements—on indirect costs. The sum is also shown and reflects the cost per vehicle in the specific model year that would be multiplied by sales to estimate the total costs associated with each proposed option.<sup>734</sup>

We show costs per vehicle here, but it is important to note that these are costs and not prices. We are not estimating how manufacturers would price their products. Manufacturers may pass costs along to purchasers via price increases in a manner consistent with what we show here. However, manufacturers may also price certain products higher than what we show while pricing others lower—the higher-priced products thereby subsidizing the lower-priced products. This is true in any market, not just the heavy-duty highway industry. This may be

especially true with respect to the indirect costs we have estimated because, for example, R&D done to improve emission durability can readily transfer across different engines whereas technology added to an engine is uniquely tied to that engine. We request comment on this issue—while we believe that the RPE markup and the indirect cost contributor scaling approach is a reasonable approach to estimating indirect costs, would it be preferable to consider indirect costs in aggregate rather than on a per engine or per vehicle basis?

TABLE V-8—MY2027 & MY2031 TECHNOLOGY COSTS PER VEHICLE FOR LHD2B3 DIESEL, AVERAGE PER VEHICLE, 2017 DOLLARS

Model year	Scenario	DMC	Warranty	R&D	Other	Profit	Tech cost sum
2027 .....	Baseline .....	\$3,788	\$114	\$189	\$1,099	\$189	\$5,379
	Baseline+Proposed Option 1 .....	5,404	243	467	1,567	270	7,952
	Baseline+Proposed Option 2 .....	5,404	178	614	1,567	270	8,034
	Option 1 increase from Baseline .....	1,616	130	277	469	81	2,572
	Option 2 increase from Baseline .....	1,616	65	425	469	81	2,655
2031 .....	Baseline .....	3,504	105	175	1,016	175	4,976
	Baseline+Proposed Option 1 .....	4,863	306	346	1,410	243	7,168
	Baseline+Proposed Option 2 .....	4,863	160	243	1,410	243	6,920
	Option 1 increase from Baseline .....	1,358	201	170	394	68	2,192
	Option 2 increase from Baseline .....	1,358	55	68	394	68	1,944

TABLE V-9—MY2027 & MY2031 TECHNOLOGY COSTS PER VEHICLE FOR LHD45 DIESEL, AVERAGE PER VEHICLE, 2017 DOLLARS

Model year	Scenario	DMC	Warranty	R&D	Other	Profit	Tech cost sum
2027 .....	Baseline .....	\$3,806	\$114	\$190	\$1,104	\$190	\$5,405
	Baseline+Proposed Option 1 .....	5,459	246	471	1,583	273	8,032
	Baseline+Proposed Option 2 .....	5,459	180	620	1,583	273	8,115
	Option 1 increase from Baseline .....	1,653	131	281	479	83	2,627
	Option 2 increase from Baseline .....	1,653	66	430	479	83	2,710
2031 .....	Baseline .....	3,515	105	176	1,019	176	4,991
	Baseline+Proposed Option 1 .....	4,900	309	348	1,421	245	7,223
	Baseline+Proposed Option 2 .....	4,900	162	245	1,421	245	6,973
	Option 1 increase from Baseline .....	1,385	203	172	402	69	2,232

<sup>734</sup>Note that we have not estimated sales impacts associated with the proposal (see Section X), so sales projections are equivalent across scenarios.

TABLE V-9—MY2027 &amp; MY2031 TECHNOLOGY COSTS PER VEHICLE FOR LHD45 DIESEL, AVERAGE PER VEHICLE, 2017 DOLLARS—Continued

Model year	Scenario	DMC	Warranty	R&D	Other	Profit	Tech cost sum
	Option 2 increase from Baseline .....	1,385	56	69	402	69	1,982

TABLE V-10—MY2027 &amp; MY2031 TECHNOLOGY COSTS PER VEHICLE FOR MHD67 DIESEL, AVERAGE PER VEHICLE, 2017 DOLLARS \*

Model year	Scenario	DMC	Warranty	R&D	Other	Profit	Tech cost sum
2027 .....	Baseline .....	\$4,032	\$121	\$202	\$1,169	\$202	\$5,725
	Baseline+Proposed Option 1 .....	5,651	373	412	1,639	283	8,358
	Baseline+Proposed Option 2 .....	5,080	229	254	1,473	254	7,290
	Option 1 increase from Baseline .....	1,619	252	211	470	81	2,632
2031 .....	Option 2 increase from Baseline .....	1,357	117	68	394	68	2,003
	Baseline .....	3,723	112	186	1,080	186	5,287
	Baseline+Proposed Option 1 .....	5,080	427	329	1,473	254	7,563
	Baseline+Proposed Option 2 .....	5,080	229	254	1,473	254	7,290
	Option 1 increase from Baseline .....	1,357	315	143	394	68	2,276
	Option 2 increase from Baseline .....	1,357	117	68	394	68	2,003

TABLE V-11—MY2027 &amp; MY2031 TECHNOLOGY COSTS PER VEHICLE FOR HHD8 DIESEL, AVERAGE PER VEHICLE, 2017 DOLLARS

Model year	Scenario	DMC	Warranty	R&D	Other	Profit	Tech cost sum
2027 .....	Baseline .....	\$6,457	\$194	\$323	\$1,873	\$323	\$9,169
	Baseline+Proposed Option 1 .....	8,668	1,170	598	2,514	433	13,382
	Baseline+Proposed Option 2 .....	8,668	910	648	2,514	433	13,172
	Option 1 increase from Baseline .....	2,210	976	275	641	111	4,213
2031 .....	Option 2 increase from Baseline .....	2,210	716	325	641	111	4,003
	Baseline .....	5,961	179	298	1,729	298	8,465
	Baseline+Proposed Option 1 .....	7,813	1,406	521	2,266	391	12,396
	Baseline+Proposed Option 2 .....	7,813	820	391	2,266	391	11,680
	Option 1 increase from Baseline .....	1,851	1,227	223	537	93	3,931
	Option 2 increase from Baseline .....	1,851	641	93	537	93	3,215

TABLE V-12—MY2027 &amp; MY2031 TECHNOLOGY COSTS PER VEHICLE FOR URBAN BUS DIESEL, AVERAGE PER VEHICLE, 2017 DOLLARS

Model year	Scenario	DMC	Warranty	R&D	Other	Profit	Tech cost sum
2027 .....	Baseline .....	\$4,082	\$122	\$204	\$1,184	\$204	\$5,796
	Baseline+Proposed Option 1 .....	5,734	774	395	1,663	287	8,854
	Baseline+Proposed Option 2 .....	5,734	602	428	1,663	287	8,715
	Option 1 increase from Baseline .....	1,653	652	191	479	83	3,058
2031 .....	Option 2 increase from Baseline .....	1,653	480	224	479	83	2,918
	Baseline .....	3,769	113	188	1,093	188	5,352
	Baseline+Proposed Option 1 .....	5,153	928	344	1,494	258	8,177
	Baseline+Proposed Option 2 .....	5,153	541	258	1,494	258	7,704
	Option 1 increase from Baseline .....	1,385	815	155	402	69	2,825
	Option 2 increase from Baseline .....	1,385	428	69	402	69	2,353

TABLE V-13—MY2027 &amp; MY2031 TECHNOLOGY COSTS PER VEHICLE FOR LHD45, MHD67 &amp; HHD8 GASOLINE, AVERAGE PER VEHICLE, 2017 DOLLARS

Model year	Scenario	DMC	Warranty	R&D	Other	Profit	Tech cost sum
2027 .....	Baseline .....	\$832	\$25	\$42	\$299	\$50	\$1,248
	Baseline+Proposed Option 1 .....	1,249	82	88	450	75	1,944
	Baseline+Proposed Option 2 .....	1,249	82	114	450	75	1,969
	Option 1 increase from Baseline .....	417	57	46	150	25	696
2031 .....	Option 2 increase from Baseline .....	417	57	72	150	25	722
	Baseline .....	768	23	38	277	46	1,152
	Baseline+Proposed Option 1 .....	1,118	107	72	402	67	1,767

TABLE V-13—MY2027 & MY2031 TECHNOLOGY COSTS PER VEHICLE FOR LHD45, MHD67 & HHD8 GASOLINE, AVERAGE PER VEHICLE, 2017 DOLLARS—Continued

Model year	Scenario	DMC	Warranty	R&D	Other	Profit	Tech cost sum
	Baseline+Proposed Option 2 .....	1,118	74	56	402	67	1,717
	Option 1 increase from Baseline .....	350	84	34	126	21	614
	Option 2 increase from Baseline .....	350	51	17	126	21	565

TABLE V-14—MY2027 & MY2031 TECHNOLOGY COSTS PER VEHICLE FOR HHD8 CNG, AVERAGE PER VEHICLE, 2017 DOLLARS

Model year	Scenario	DMC	Warranty	R&D	Other	Profit	Tech cost sum
2027 .....	Baseline .....	\$4,108	\$123	\$205	\$1,191	\$205	\$5,833
	Baseline+Proposed Option 1 .....	4,135	558	285	1,199	207	6,384
	Baseline+Proposed Option 2 .....	4,135	434	309	1,199	207	6,284
	Option 1 increase from Baseline .....	27	435	80	8	1	551
	Option 2 increase from Baseline .....	27	311	104	8	1	450
2031 .....	Baseline .....	3,793	114	190	1,100	190	5,386
	Baseline+Proposed Option 1 .....	3,816	687	254	1,107	191	6,054
	Baseline+Proposed Option 2 .....	3,816	401	191	1,107	191	5,705
	Option 1 increase from Baseline .....	23	573	65	7	1	668
	Option 2 increase from Baseline .....	23	287	1	7	1	318

TABLE V-15—MY2027 & MY2031 TECHNOLOGY COSTS PER VEHICLE FOR URBAN BUS CNG, AVERAGE PER VEHICLE, 2017 DOLLARS

Model year	Scenario	DMC	Warranty	R&D	Other	Profit	Tech cost sum
2027 .....	Baseline .....	\$3,081	\$92	\$154	\$893	\$154	\$4,375
	Baseline+Proposed Option 1 .....	3,100	419	214	899	155	4,787
	Baseline+Proposed Option 2 .....	3,100	326	232	899	155	4,711
	Option 1 increase from Baseline .....	19	326	60	6	1	412
	Option 2 increase from Baseline .....	19	233	78	6	1	336
2031 .....	Baseline .....	2,845	85	142	825	142	4,039
	Baseline+Proposed Option 1 .....	2,861	515	191	830	143	4,539
	Baseline+Proposed Option 2 .....	2,861	300	143	830	143	4,277
	Option 1 increase from Baseline .....	16	430	48	5	1	500
	Option 2 increase from Baseline .....	16	215	1	5	1	237

B. Operating Costs

We have estimated three impacts on operating costs associated with the proposed criteria pollutant standards: Increased diesel exhaust fluid (DEF) consumption by diesel vehicles due to increased DEF dose rates to enable compliance with more stringent NO<sub>x</sub> standards; decreased fuel costs by gasoline vehicles due to new onboard refueling vapor recovery systems that allow burning (in engine) of otherwise evaporated hydrocarbon emissions; and emission repair impacts. For the repair impacts we expect that the longer duration warranty would result in lower owner/operator-incurred repair costs since those costs would be borne by the manufacturer, and that the longer duration useful life periods would result in increased emission control system durability and fewer failing parts needing repair. However, the possibility exists that higher-cost emission control

systems may result in higher repair costs if and when repairs are needed. We have estimated the net effect on repair costs and describe our approach, along with increased DEF consumption and reduced gasoline consumption, below. Additional details on our methodology and estimates of operating costs per mile impacts are included in draft RIA Chapter 7.2.

1. Costs Associated With Increased Diesel Exhaust Fluid (DEF) Consumption in Diesel Engines

Consistent with the approach used to estimate technology costs, we have estimated both baseline case DEF consumption and DEF consumption under the proposed Options 1 and 2. For the baseline case, we estimated DEF consumption using the relationship between DEF dose rate and the reduction in NO<sub>x</sub> over the SCR catalyst. The relationship between DEF dose rate and NO<sub>x</sub> reduction across the SCR

catalyst is based on methodology presented in the Technical Support Document to the 2012 Nonconformance Penalty rule (the NCP Technical Support Document, or NCP TSD).<sup>735</sup> The DEF dose rate to NO<sub>x</sub> reduction relationship based on that methodology considered FTP emissions and, as such, the DEF dose rate increased as FTP tailpipe emissions decreased. The DEF dose rate used is 5.18 percent of fuel consumed.

To estimate DEF consumption impacts under the proposed Options 1 and 2, which involve changes to not only the FTP emission standards but also the RMC and LLC standards along with new idle standards, we developed a new approach to estimating DEF consumption. For this analysis, we scaled DEF consumption with the NO<sub>x</sub>

<sup>735</sup> Nonconformance Penalties for On-highway Heavy-duty Diesel Engines: Technical Support Document; EPA-420-R-12-014, August 2012.

reductions achieved under proposed Options 1 and 2. This was done by considering the molar mass of NO<sub>x</sub>, the molar mass of urea, the mass concentration of urea in DEF along with the density of DEF to estimate the theoretical gallons of DEF consumed per ton of NO<sub>x</sub> reduced. We estimated theoretical DEF consumption per ton of NO<sub>x</sub> reduced at 442 gallons/ton which we then adjusted based on testing to 527 gallons/ton, the value used in this analysis. We describe this in more detail in Section 7.2.1 of the draft RIA.

These two DEF consumption metrics—dose rate per gallon and DEF consumption per ton of NO<sub>x</sub> reduced—were used to estimate total DEF consumption in the baseline, as well as the proposed Options 1 and 2. These DEF consumption rates were then multiplied by DEF price per gallon, adjusted from the DEF prices presented in the NCP TSD, to arrive at the impacts on DEF costs for diesel engines. These are shown in Table V–16.

## 2. Costs Associated With ORVR and the Estimated Reduction in Fuel Costs for Gasoline Engines

We have estimated a decrease in fuel costs, *i.e.*, fuel savings, associated with the proposed ORVR requirements on gasoline engines. Due to the ORVR systems, evaporative emissions that would otherwise be emitted into the atmosphere would be trapped and subsequently burned in the engine. We describe the approach taken to estimate these impacts in Chapter 7.2.2 of the draft RIA. These newly captured evaporative emissions are converted to gallons and then multiplied by AEO 2018 reference case gasoline prices to arrive at the monetized impacts. These impacts are shown in Table V–16.<sup>736</sup>

## 3. Repair Cost Impacts Associated With Longer Warranty and Useful Life Periods

The extended warranty and useful life requirements being proposed would have an impact on emission-related repair costs incurred by truck owners. Researchers have noted the relationships among quality, reliability, and warranty for a variety of goods.<sup>737</sup>

<sup>736</sup> We estimate that the ORVR requirements in both the proposal and Alternative 1 would result in a reduction of approximately 0.3 million (calendar year 2027) to 4.8 million (calendar year 2045) gallons of gasoline, representing roughly 0.1 percent of gasoline consumption from impacted vehicles.

<sup>737</sup> Thomas, M., and S. Rao (1999). “Warranty Economic Decision Models: A Summary and Some Suggested Directions for Future Research.” *Operations Research* 47(6):807–820.

Wu,<sup>738</sup> for instance, examines how analyzing warranty data can provide “early warnings” on product problems that can then be used for design modifications. Guajardo et al. describe one of the motives for warranties to be “incentives for the seller to improve product quality;” specifically for light-duty vehicles, they find that buyers consider warranties to substitute for product quality, and to complement service quality.<sup>739</sup> Murthy and Jack, for new products, and Saidi-Mehrabad et al. for second-hand products, consider the role of warranties in improving a buyer’s confidence in quality of the good.<sup>740 741</sup>

On the one hand, we would expect owner-incurred emission repair costs to decrease due to the proposed program because the longer emission warranty requirements would result in more repair costs covered by the OEMs. Further, we would expect improved serviceability in an effort by OEMs to decrease repair costs they would incur. We would also expect that the longer useful life periods in proposed Options 1 or 2 would result in more durable parts to ensure regulatory compliance over the longer timeframe. On the other hand, we would also expect that the more costly emission control systems required by the proposed Options 1 or 2 would result in higher repair costs which could increase OEM costs during the warranty period and owner costs outside the warranty period. As further explained below, while the longer warranty period could potentially increase repair costs incurred by OEMs, such costs would fall under our estimated warranty cost increases as part of our indirect cost estimates described in Section V.A.2.

As discussed in Section V.A.2, we have estimated increased OEM indirect costs associated with increased warranty liability (*i.e.*, longer warranty periods), and for more durable parts

<sup>738</sup> Wu, S (2012). *Warranty Data Analysis: A Review. Quality and Reliability Engineering International* 28: 795–805.

<sup>739</sup> Guajardo, J., M Cohen, and S. Netessine (2016). “Service Competition and Product Quality in the U.S. Automobile Industry.” *Management Science* 62(7):1860–1877. The other rationales are protection for consumers against failures, provision of product quality information to consumers, and a means to distinguish consumers according to their risk preferences.

<sup>740</sup> Murthy, D., and N. Jack (2009). “Warranty and Maintenance,” Chapter 18 in *Handbook of Maintenance Management and Engineering*, Mohamed Ben-Daya et al., editors. London: Springer.

<sup>741</sup> Saidi-Mehrabad, M., R. Noorossana, and M. Shafiee (2010). “Modeling and analysis of effective ways for improving the reliability of second-hand products sold with warranty.” *International Journal of Advanced Manufacturing Technology* 46: 253–265.

resulting from the longer useful life periods. These costs are accounted for via increased warranty costs scaled by the longer warranty period, and increased research and development (R&D) costs scaled by the longer useful life period. We also included additional aftertreatment costs in the direct manufacturing costs to address the increased useful life requirements (*e.g.*, larger catalyst volume; see Chapters 2 and 4 of the draft RIA for detailed discussions). We estimate that these efforts would help to reduce emission repair costs during the emission warranty and regulatory useful life periods, and possibly beyond.

To estimate impacts on emission repair costs, we began with an emission repair cost curve.<sup>742</sup> We describe in detail how we generated the emission repair cost curve and the data from which it was derived in Chapter 7 of the draft RIA. Figure V–1 shows, conceptually, the nature of the emission repair cost curve (the solid line) and the maintenance and repair cost curve—all maintenance and repair, not just emission repair—from which it was derived (the dotted line). The emission repair cost curve is lower than the curve for all maintenance and repairs since not all repair is emission-related.<sup>743</sup> We have not estimated any impact on maintenance costs associated with the longer warranty and useful life periods in proposed Options 1 and 2, and we have estimated that just over 10 percent of repair costs are emission-related repairs impacted by the proposed action (see Chapter 7 of the draft RIA for this derivation, which is based on the industry whitepaper).<sup>744</sup> From the generic emission repair cost curve in Figure V–1, we generated a unique emission repair cost curve for each type of vehicle (combination long-haul, single unit short-haul, etc.), regulatory class (medium heavy-duty, heavy heavy-duty, etc.) and fuel type (diesel, gasoline, etc.).

As noted, Figure V–1 shows conceptually the relationship between repair costs and the estimated age at

<sup>742</sup> See “Mitigating Rising Maintenance & Repair Costs for Class-8 Truck Fleets, Effective Data & Strategies to Leverage Newer Trucks to Reduce M&R Costs,” *Fleet Advantage Whitepaper Series*, 2018.

<sup>743</sup> Maintenance includes oil changes, tire replacements, brake replacements, etc., *i.e.*, items that are expected to wear out and require replacement. Repair is the fixing of broken parts that are not necessarily expected to break. Repairs might include replacing a cracked particulate filter or a broken mirror or door handle.

<sup>744</sup> See “Mitigating Rising Maintenance & Repair Costs for Class-8 Truck Fleets, Effective Data & Strategies to Leverage Newer Trucks to Reduce M&R Costs,” *Fleet Advantage Whitepaper Series*, 2018.



which the warranty period is reached for any given vehicle, where repair costs are relatively low during the warranty period and repair cost rates begin to increase every year beyond the warranty period. Similarly, at the estimated age at which the useful life period ends, maintenance and repair cost rates increase yet again until, in the figure, costs flatten out. The “estimated ages” mentioned are meant to reflect not the required warranty and/or useful life ages, but rather the age at which the

warranty (or useful life) is reached based on the average miles traveled per year by a given vehicle type relative to the required warranty/useful life ages and mileages. For example, a current long-haul Class-8 truck has a required warranty of 5 years or 100,000 miles, whichever occurs first. Since the mileage accumulation of such a vehicle is over 100,000 miles in the first year, the “estimated age” at which the warranty is reached would be 1 year.<sup>745</sup>

The flattening of costs per mile shown in Figure V–1 is due to a lack of data beyond seven years of operation and, as such, we have chosen to maintain a flat repair cost rate for subsequent years.<sup>746</sup> We considered estimating increases in maintenance and repair cost per mile beyond the useful life, but decided that increases in the cost per mile rate applied to both the baseline case and the proposal would have no net impact.

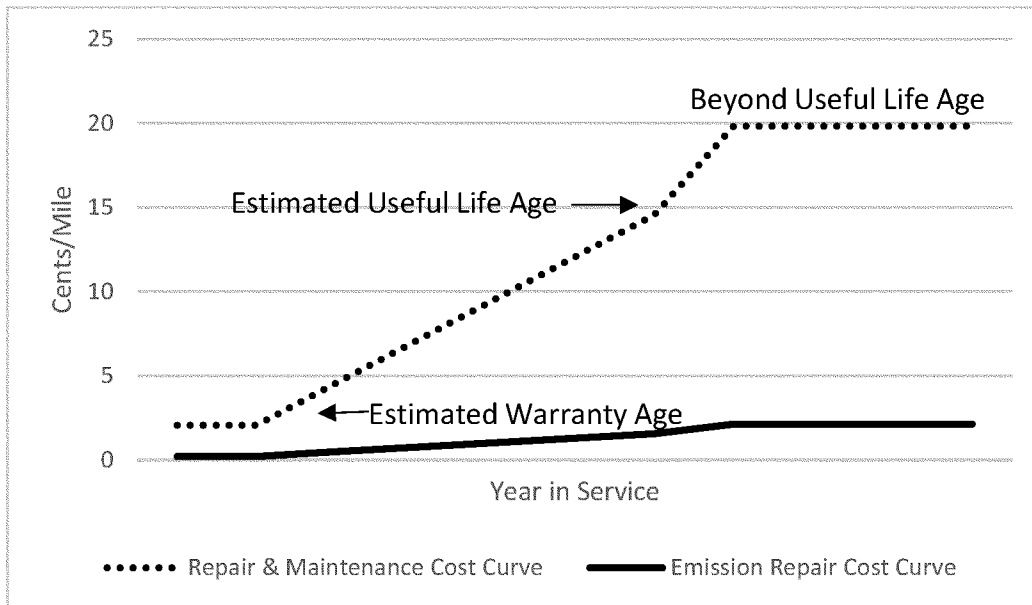

**Figure V-1 Emission Repair Cost/Mile Curve (2018 dollars)**

Figure V–2 illustrates how the generic cost curve was adjusted to estimate the emission repair cost per mile for specific vehicles. To do this, we first estimated the vehicle age (in years) at which the warranty and useful life periods would end based on the typical miles driven per year over the first seven years of operation.<sup>747</sup> The vehicle ages at which the warranty and useful life periods are estimated to end are then applied to the generic emission repair cost curve to generate a unique

emission repair cost curve for each vehicle depending on the unique warranty/useful life provisions and mileage accumulation rates for that vehicle. Figure V–2 shows, conceptually, the baseline emission repair cost curve (the solid line in Figure V–1 but now the dotted line, note the new y-axis scale) and the emission repair cost curve under the proposal (the solid line, not shown in Figure V–1). In this conceptual example, the warranty would expire in year 5 instead

of year 1. Further, the age at which the useful life has been reached would be year 9 instead of year 6. Lastly, the emission repair cost curve would reach a higher cost/mile level during the warranty period, at the end of useful life, and then beyond the useful life. This is due to the more costly emission controls that we estimate would be fitted to engines as a result of the proposed requirements (as discussed in Section V.A).

<sup>745</sup> See “Estimated Warranty and Useful Life Ages Used in Estimating Emission Repair Costs” memorandum from Todd Sherwood to docket EPA–HQ–OAR–2019–0055.

<sup>746</sup> The only data source we are aware of is this industry whitepaper, which includes costs through seven years of operation; “Mitigating Rising

Maintenance & Repair Costs for Class-8 Truck Fleets, Effective Data & Strategies to Leverage Newer Trucks to Reduce M&R Costs,” Fleet Advantage Whitepaper Series, 2018.

<sup>747</sup> We have chosen 7 years for this estimate as a fair snapshot on costs; including fewer years would result in a higher average number of miles/

year given that mileage accumulation rates tend to decrease year-over-year and, therefore, including more years would tend to result in a lower average mileage accumulation rate. We chose seven years as the fair, middle ground.

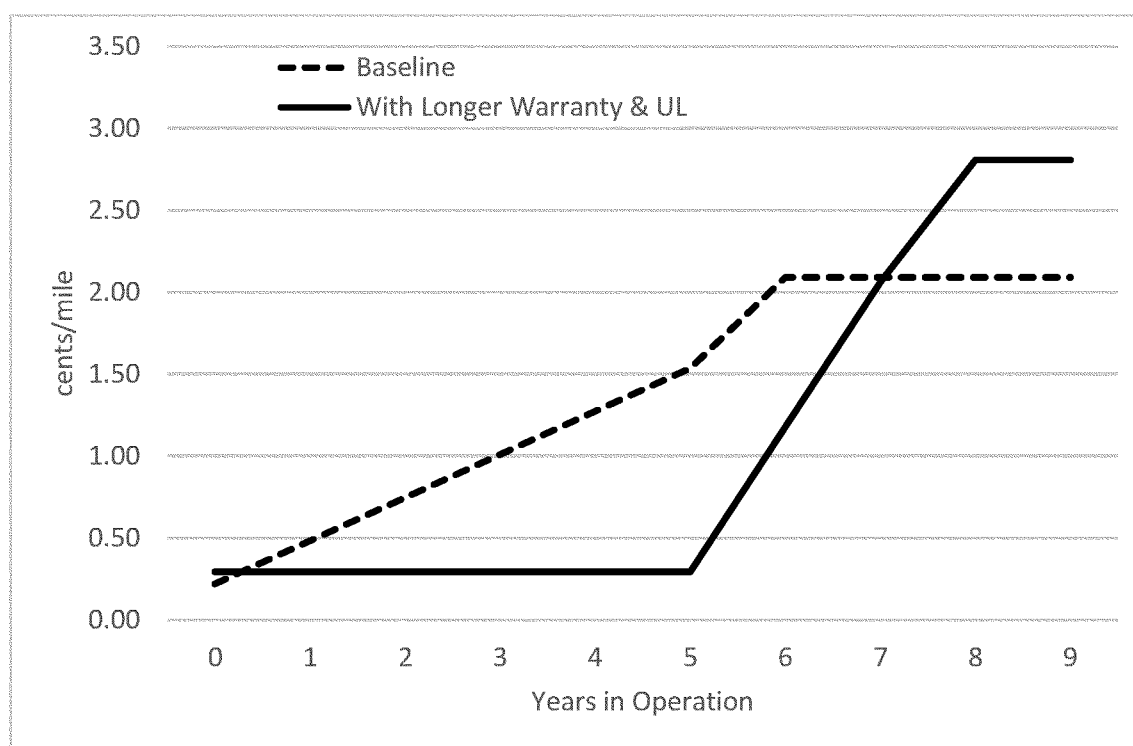

**Figure V-2 Emission Repair Cost Curve in the Baseline Case (dotted line) and a Hypothetical Example with Longer Warranty and Useful Life Provisions (solid line)**

The emission repair cost/mile curves shown in Figure V-2 would result in an incremental cost/mile that is negative for the operating years 2 through 7. During the first year, the incremental cost/mile would be slightly higher due to the marginal technology costs associated with the hypothetical proposed standard. From years 1 through 7, the cost/mile would be lower on increment due to the longer warranty and useful life periods and the efforts we are estimating manufacturers would undertake to improve durability to avoid warranty costs after sale (efforts paid for in upfront indirect costs as described in Section V.A.2). In the years of operation beyond the useful life, emission repair costs/mile would then be expected to be marginally higher, again due to the marginal technology costs associated with the hypothetical proposed standard. Importantly, in those later years of operation, miles driven per year tend to decrease year-over-year, which serves to offset somewhat the effect of the higher estimated cost/mile value on a cost/year basis. In the end, for most vehicle types (*i.e.*, MOVES sourcetypes) our analysis shows that, in general, the net emission repair costs over the first 10 years of operation would decrease (see Section 7.2.3 of the draft RIA).

We believe that it is reasonable to estimate that the emission repair costs would remain flat, as shown in Figure V-2, during the longer warranty periods being proposed under either option because of the increased warranty and research and development costs we are estimating in our technology costs. Note that we are also estimating that the emission repair costs beyond the useful life would increase at a slightly higher rate based on the source data which suggested such a trend. Again, cost/mile rates are estimated to flatten beyond the useful life since the source data included operating costs through only seven years. It is possible that cost/mile rates continue to increase with age and that those would increase at similar rates in both the baseline case and under the proposed options. If true, the net effect would be the same as estimated here and the net effect is of primary concern in our analysis.

As noted, our methodology and estimated impacts are presented in more detail in Chapter 7 of the draft RIA. We request comment on all aspects of our approach. In particular, we request comment on how we have used the data from which our repair cost curve was derived and how we have adjusted that curve to represent costs for all of the vehicle types under consideration. Further, we request data that would

allow us to build upon our approach or change our approach if a better one exists.

#### C. Program Costs

Using the cost elements outlined in Sections V.A and V.B, we have estimated the costs associated with the proposed criteria pollutant standards; costs associated with proposed Options 1 and 2 are shown in Table V-16 and Table V-17, respectively. Costs are presented in more detail in Chapter 7 of the draft RIA. As noted earlier, costs are presented in 2017 dollars in undiscounted annual values along with net present values at both 3 and 7 percent discount rates with values discounted to the 2027 calendar year.

We are not including an analysis of the costs of the Alternative (described in Sections III and IV) because we currently do not have sufficient information to conclude that the Alternative standards would be feasible in the MY 2027 timeframe.

As shown in these tables, and more clearly in Figure V-3, our analysis shows that the proposed Options 1 and 2 would result in similar costs in the early years, but proposed Option 1 would result in lower costs the longer term, despite higher costs in the mid-term years, compared to proposed Option 2.

**Table V-16 Total Technology & Operating Cost Impacts of the proposed Option 1 Relative to the Baseline Case, All Regulatory Classes and All Fuels, Millions of 2017 dollars <sup>a</sup>**

Calendar Year	Direct Tech Cost	Indirect Warranty Cost	Indirect R&D Cost	Other Indirect Cost	Indirect Profit	Total Tech Cost	Emission Repair Cost	Urea Cost	Fuel Cost	Total Operating Cost	Program Cost
2027	\$990	\$300	\$130	\$290	\$50	\$1,800	\$17	\$61	-\$1	\$77	\$1,800
2028	\$960	\$290	\$130	\$280	\$49	\$1,700	-\$55	\$130	-\$2	\$71	\$1,800
2029	\$940	\$290	\$130	\$280	\$48	\$1,700	-\$220	\$200	-\$3	-\$25	\$1,700
2030	\$920	\$290	\$46	\$270	\$46	\$1,600	-\$250	\$270	-\$3	\$13	\$1,600
2031	\$900	\$410	\$110	\$260	\$46	\$1,700	-\$240	\$370	-\$4	\$120	\$1,900
2032	\$890	\$410	\$100	\$260	\$45	\$1,700	-\$240	\$460	-\$5	\$210	\$1,900
2033	\$870	\$400	\$100	\$250	\$44	\$1,700	-\$240	\$530	-\$6	\$280	\$1,900
2034	\$860	\$400	\$43	\$250	\$43	\$1,600	-\$440	\$590	-\$7	\$140	\$1,700
2035	\$850	\$400	\$43	\$250	\$43	\$1,600	-\$480	\$650	-\$8	\$160	\$1,700
2036	\$850	\$400	\$42	\$250	\$43	\$1,600	-\$430	\$720	-\$9	\$280	\$1,900
2037	\$840	\$400	\$42	\$250	\$42	\$1,600	-\$410	\$800	-\$10	\$380	\$1,900
2038	\$830	\$400	\$42	\$240	\$42	\$1,600	-\$430	\$890	-\$11	\$440	\$2,000
2039	\$830	\$400	\$42	\$240	\$42	\$1,600	-\$470	\$940	-\$12	\$450	\$2,000
2040	\$830	\$400	\$42	\$240	\$42	\$1,600	-\$500	\$990	-\$13	\$470	\$2,000
2041	\$840	\$400	\$42	\$250	\$42	\$1,600	-\$490	\$1,000	-\$13	\$520	\$2,100
2042	\$840	\$400	\$42	\$250	\$42	\$1,600	-\$490	\$1,100	-\$14	\$570	\$2,100
2043	\$840	\$400	\$42	\$250	\$42	\$1,600	-\$480	\$1,100	-\$14	\$620	\$2,200
2044	\$840	\$410	\$42	\$250	\$42	\$1,600	-\$470	\$1,200	-\$15	\$670	\$2,200
2045	\$840	\$410	\$42	\$250	\$42	\$1,600	-\$460	\$1,200	-\$16	\$720	\$2,300
PV, 3%	\$13,000	\$5,300	\$1,000	\$3,700	\$630	\$23,000	-\$4,800	\$9,100	-\$120	\$4,200	\$27,000
PV, 7%	\$9,200	\$3,800	\$800	\$2,700	\$460	\$17,000	-\$3,200	\$5,800	-\$73	\$2,600	\$19,000
Annualized, 3%	\$880	\$370	\$71	\$260	\$44	\$1,600	-\$340	\$630	-\$8	\$290	\$1,900
Annualized, 7%	\$890	\$370	\$77	\$260	\$45	\$1,600	-\$310	\$560	-\$7	\$250	\$1,900

<sup>a</sup> Values show 2 significant digits; negative cost values denote savings; calendar year values are undiscounted, present values are discounted to 2027; Program Cost is the sum of Total Tech Cost and Total Operating Cost. Note also that the Information Collection Request costs addressed in Section XI would fall within the "Other" indirect costs shown here.

**Table V-17 Total Technology & Operating Cost Impacts of proposed Option 2 Relative to the Baseline Case,  
All Regulatory Classes and All Fuels, Millions of 2017 dollars <sup>a</sup>**

Calendar Year	Direct Tech Cost	Indirect Warranty Cost	Indirect R&D Cost	Other Indirect Cost	Indirect Profit	Total Tech Cost	Emission Repair Cost	Urca Cost	Fuel Cost	Total Operating Cost	Program Cost
2027	\$990	\$210	\$180	\$290	\$50	\$1,700	\$17	\$56	-\$1	\$72	\$1,800
2028	\$960	\$210	\$170	\$280	\$49	\$1,700	-\$55	\$120	-\$2	\$60	\$1,700
2029	\$940	\$200	\$170	\$280	\$48	\$1,600	-\$150	\$180	-\$3	\$31	\$1,700
2030	\$920	\$200	\$46	\$270	\$46	\$1,500	-\$210	\$250	-\$3	\$31	\$1,500
2031	\$900	\$200	\$45	\$260	\$46	\$1,500	-\$210	\$320	-\$4	\$110	\$1,600
2032	\$890	\$200	\$44	\$260	\$45	\$1,400	-\$99	\$400	-\$5	\$300	\$1,700
2033	\$870	\$200	\$43	\$250	\$44	\$1,400	-\$69	\$460	-\$6	\$380	\$1,800
2034	\$860	\$200	\$43	\$250	\$43	\$1,400	-\$22	\$510	-\$7	\$480	\$1,900
2035	\$850	\$190	\$43	\$250	\$43	\$1,400	\$33	\$560	-\$8	\$580	\$2,000
2036	\$850	\$190	\$42	\$250	\$43	\$1,400	\$110	\$610	-\$9	\$710	\$2,100
2037	\$840	\$190	\$42	\$250	\$42	\$1,400	\$200	\$650	-\$10	\$840	\$2,200
2038	\$830	\$190	\$42	\$240	\$42	\$1,400	\$280	\$690	-\$11	\$960	\$2,300
2039	\$830	\$190	\$42	\$240	\$42	\$1,400	\$360	\$730	-\$11	\$1,100	\$2,400
2040	\$830	\$190	\$42	\$240	\$42	\$1,400	\$410	\$770	-\$12	\$1,200	\$2,500
2041	\$840	\$200	\$42	\$250	\$42	\$1,400	\$450	\$810	-\$13	\$1,200	\$2,600
2042	\$840	\$200	\$42	\$250	\$42	\$1,400	\$500	\$840	-\$13	\$1,300	\$2,700
2043	\$840	\$200	\$42	\$250	\$42	\$1,400	\$530	\$870	-\$14	\$1,400	\$2,800
2044	\$840	\$200	\$42	\$250	\$42	\$1,400	\$560	\$910	-\$15	\$1,400	\$2,800
2045	\$840	\$200	\$42	\$250	\$42	\$1,400	\$580	\$940	-\$15	\$1,500	\$2,900
PV, 3%	\$13,000	\$2,800	\$980	\$3,700	\$630	\$21,000	\$1,800	\$7,400	-\$110	\$9,200	\$30,000
PV, 7%	\$9,200	\$2,100	\$790	\$2,700	\$460	\$15,000	\$840	\$4,800	-\$71	\$5,500	\$21,000
Annualized, 3%	\$880	\$200	\$69	\$260	\$44	\$1,400	\$130	\$520	-\$8	\$640	\$2,100
Annualized, 7%	\$890	\$200	\$76	\$260	\$45	\$1,500	\$81	\$460	-\$7	\$540	\$2,000

<sup>a</sup> Values show 2 significant digits; negative cost values denote savings; calendar year values are undiscounted, present values are discounted to 2027; Program Cost is the sum of Total Tech Cost and Total Operating Cost. Note also that the Information Collection Request costs addressed in Section XI would fall within the "Other" indirect costs shown here.

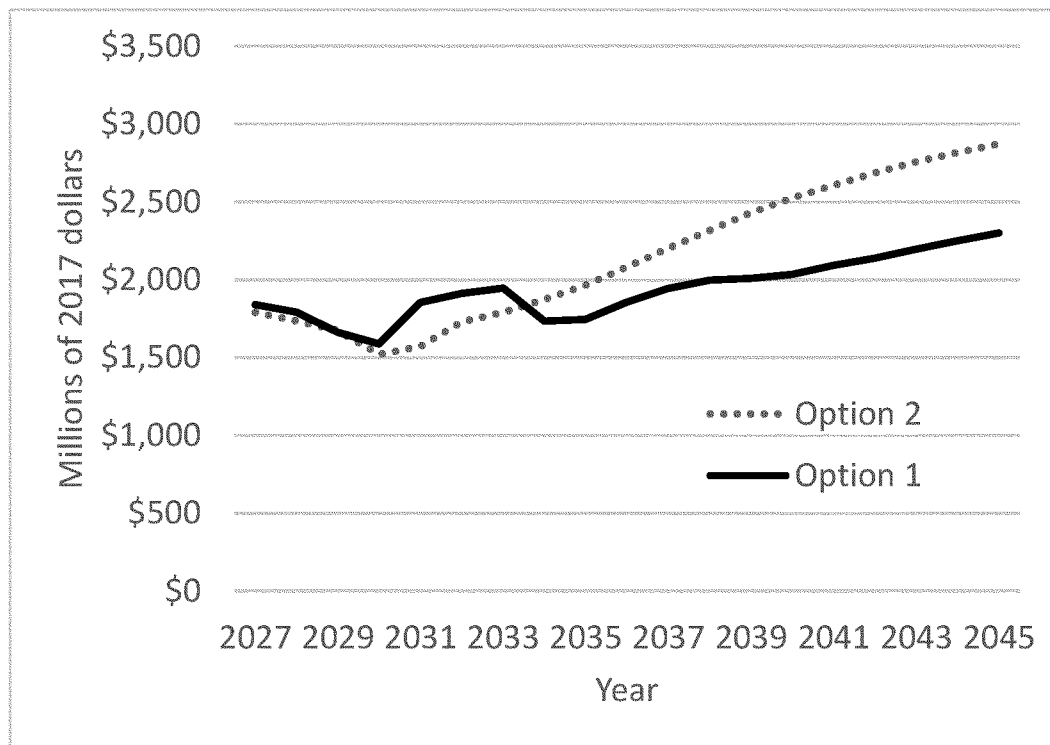

**Figure V-3 Technology and Operating Costs for proposed Options 1 and 2 (Millions of 2017 dollars)**

## VI. Estimated Emission Reductions From the Proposed Program

The proposed criteria pollutant emission control program described in Sections III and IV is expected to reduce emissions from highway heavy-duty engines in several ways.<sup>748</sup> We project reduced tailpipe emissions of NO<sub>x</sub> as a result of the proposed emission standards for heavy-duty diesel engines. The combination of the proposed low-load duty-cycle standard and off-cycle standards for diesel engines would help to ensure that the reduction in tailpipe emissions is achieved in-use, not only under high-speed, on-highway conditions, but under low-load and idle conditions as well. We also project reduced tailpipe emissions of NO<sub>x</sub>, CO, PM, and VOCs from heavy-duty gasoline engines, particularly under cold-start and high-load operating conditions. The proposed longer emission warranty and regulatory useful life requirements for heavy-duty diesel and gasoline engines would help to maintain the expected emission reductions for all pollutants for a longer portion of the operational

life of the engine.<sup>749</sup> The proposed onboard refueling vapor recovery requirements for heavy-duty gasoline engines would reduce VOCs and associated air toxics. See draft RIA Chapter 5, Appendix 5.3 for details on projected emission reductions of each pollutant.

Section VI.A provides an overview of the methods used to estimate emission reductions from our proposed program. All of the projected emission reductions from the proposed Option 1 or 2 are outlined in Section VI.B, with more details provided in the draft RIA Chapter 5. Section VI.C presents projected emission reductions from Option 1 or 2 by engine operations and processes (*e.g.*, medium-to-high load or low-load engine operations). Section VI.D presents results of the Alternative that we analyzed. Section VI.E discusses how heavy-duty electric vehicles could affect the baseline emission inventory in the final rule and requests comment on this topic.

As discussed in Section I and detailed in Sections III and IV, proposed Option 2 is generally less stringent than MY 2031 standards in proposed Option 1 due to the combination of higher numeric levels of the NO<sub>x</sub> emission standards and shorter useful life periods

in proposed Option 2. The Alternative is more stringent than the Option 1 MY 2031 standards due to the combination of shorter lead time, lower numeric levels of the NO<sub>x</sub> and HC emission standards, and longer useful life periods in the Alternative. The proposed Options 1 and 2 standards generally contain values that represent a lower and upper bound of the combined range of options that we are considering for lead time, duty-cycle test standards, off-cycle standards, emission warranty, and useful life requirements. We would need additional information to be able to project that the Alternative is feasible in the MY 2027 timeframe and thereby consider adopting it in the final rule (see Section III for details).

The proposed Options 1 and 2 thus generally bracket the overall range of options that EPA is currently considering and the range of estimated emission inventory impacts that we currently project (see Section I.G for discussion on potentially finalizing a program different from our proposal based on additional data that we collect and stakeholder input on this proposal).

### A. Emission Inventory Methodology

To estimate the emission reductions from the proposed program as a whole, we updated EPA's Motor Vehicle Emission Simulator (MOVES) model to include several changes related

<sup>748</sup> This section describes estimated emission reductions from the proposed criteria pollutant program described in Sections III and IV. Discussion on estimated emission impacts from the proposed revisions to the HD GHG Phase 2 rule are addressed in Section XI.

<sup>749</sup> See Section IV.A for more discussion on the operational life of the engine relative to useful life.

specifically to heavy-duty vehicle emissions and activity (e.g., heavy-duty engine start and running exhaust emission rates, heavy-duty vehicle start and idle activity). These model updates are summarized in Chapter 5.2 of the draft RIA and described in detail in several peer-reviewed technical reports that are available in the docket for this proposed rulemaking.<sup>750</sup>

The draft RIA also provides a detailed description of our methodology to develop model inputs for the proposed and alternative control scenarios (see draft RIA Chapter 5.3.2 and 5.3.3). The model inputs for the proposed and alternative control scenarios capture emission reductions outlined in the introduction to this section.<sup>751</sup>

We invite stakeholders to comment and provide additional information on our approaches to use MOVES for modeling the proposed duty-cycle and off-cycle standards, as well as longer warranty and useful life periods; commenters may also provide input on other data or modeling approaches that EPA should consider when estimating emission inventory impacts in the final rulemaking.

*B. Estimated Emission Reductions From the Proposed Criteria Pollutant Program*

As discussed in Sections I.G and III, EPA is co-proposing two regulatory options with different numeric levels of emission standards, as well as different regulatory useful life and emissions warranty periods.<sup>752</sup> Our estimates of the emission impacts that would result from the proposed Options 1 and 2 in calendar years 2030, 2040, and 2045 are presented below in Table VI–1 Table VI–2, respectively. As shown in Table VI–1, we estimate that the criteria pollutant program in proposed Option 1 would reduce NO<sub>x</sub> emissions from highway heavy-duty vehicles by 61 percent nationwide in 2045. We also estimate a 26 percent reduction in primary exhaust PM<sub>2.5</sub> from highway heavy-duty vehicles. VOC emissions from heavy-duty vehicles would be 21 percent lower. Emissions of CO from heavy-duty vehicles are estimated to decrease by 17 percent. Emission impacts of the proposed Option 1 on other pollutants, including air toxics, range from an estimated reduction of about 27 percent for benzene to no change in 1,3-butadiene.<sup>753</sup> As shown in Table VI–2, proposed Option 2 is

estimated to reduce heavy-duty vehicle NO<sub>x</sub> emissions by 47 percent in 2045; the estimated reductions in other pollutants are similar to reductions from proposed Option 1. Draft RIA Chapter 5.5.3 includes additional details on the emission reductions by vehicle fuel type; Chapter 5.5.5 provides our estimates of criteria pollutant emissions reductions for calendar years 2027 through 2045.

As the proposed standards are implemented, emission reductions are expected to increase over time as the fleet turns over to new, compliant engines.<sup>754</sup> Under either proposed Option 1 or 2, we estimate no change in CO<sub>2</sub> emissions, based on data in our feasibility and cost analyses of the proposed criteria pollutant program (see Section III for more discussion).<sup>755</sup> As shown in Tables VI–1 and Table VI–2, we estimate a less than 1% reduction in CH<sub>4</sub> emissions from heavy-duty vehicles.<sup>756</sup> On the whole, we expect either proposed Option 1 or 2 to have only minor impacts on GHG emissions; however, we request comment on the potential for GHG emission impacts from proposed Option 1 or 2.

TABLE VI–1—ANNUAL EMISSION REDUCTIONS FROM HEAVY-DUTY VEHICLES IN CALENDAR YEARS (CY) 2030, 2040, AND 2045—PROPOSED OPTION 1 EMISSIONS RELATIVE TO THE HEAVY-DUTY VEHICLE EMISSIONS BASELINE

Pollutant	CY2030		CY2040		CY2045	
	US short tons	% Reduction	US short tons	% Reduction	US short tons	% Reduction
NO <sub>x</sub> .....	153,608	16.4	491,318	55.9	558,780	60.5
VOC .....	4,681	5.0	15,199	18.7	17,975	21.0
Primary Exhaust PM <sub>2.5</sub> .....	408	3.4	1,741	23.7	2,005	26.4
CO .....	51,154	3.2	241,974	15.2	289,835	17.2
1,3-Butadiene .....	0	0.0	0	0.0	0	0.0
Acetaldehyde .....	8	0.4	46	2.5	52	2.7
Benzene .....	42	4.1	181	23.1	221	26.8
Formaldehyde .....	12	0.5	63	4.1	75	4.6
Methane (CH <sub>4</sub> ) .....	166	0.2	881	0.7	1,025	0.7
Naphthalene .....	1.3	0.9	6.5	14.3	8	16.7

<sup>750</sup> Sonntag, Darrell. Memorandum to docket EPA–HQ–OAR–2019–0055: “Updates to MOVES for Emissions Analysis of the HD 2027 NPRM”. May 2021

<sup>751</sup> Note that our modeling does not include emission reductions from the proposed useful life and warranty requirements for gasoline and natural gas vehicles. These proposed control requirements are expected to further decrease heavy-duty engine emissions. See draft RIA Chapter 5 for details on anticipated emission impacts and our expectations for modeling emission impacts in the final rule where feasible based on data and modeling capabilities.

<sup>752</sup> As summarized in Section I and detailed in Sections III and IV, the proposed Option 1 would

be implemented in two steps, while the proposed Option 2 would be implemented in a single step starting in MY 2027. The numeric values of the proposed Option 2 standards are less stringent than the proposed Option 1 MY 2031 standards, with useful life and warranty mileages similar to those in proposed Option 1 MY 2027 standards.

<sup>753</sup> No change is observed in 1,3-butadiene emissions in the control scenarios because 1,3-butadiene emissions do not contribute to VOC emissions from MY 2027 and later diesel running and start emissions, heavy-duty gasoline running emissions, and gasoline refueling emissions in the version of MOVES updated for use in this rulemaking, referred to as MOVES CTI NPRM.

<sup>754</sup> We do not currently expect the proposed rule to incentivize additional market shifts to electrification; however, if such shifts were to occur then additional emission reductions beyond those projected in Section VI.B could occur.

<sup>755</sup> This estimate includes the assumption that vehicle sales will not change in response to the proposed rule. See Section X for further discussion on vehicle sales impacts of this proposed rule. See Section XI for discussion on estimated CO<sub>2</sub> emission impacts of the proposed revisions to the Heavy Duty GHG Phase 2 rulemaking.

<sup>756</sup> The CH<sub>4</sub> emissions reductions would be due to lower total hydrocarbon emission rates from the tailpipe of heavy-duty gasoline vehicles (see draft RIA Chapter 5.2.2 for more detail).

TABLE VI-2—ANNUAL EMISSION REDUCTIONS FROM HEAVY-DUTY VEHICLES IN CALENDAR YEARS (CY) 2030, 2040, AND 2045—PROPOSED OPTION 2 EMISSIONS RELATIVE TO THE HEAVY-DUTY VEHICLE EMISSIONS BASELINE

Pollutant	CY 2030		CY 2040		CY 2045	
	US short tons	% Reduction	US short tons	% Reduction	US short tons	% Reduction
NO <sub>x</sub> .....	140,691	15.0	383,350	43.6	437,869	47.4
VOC .....	4,645	5.0	14,623	18.0	17,283	20.2
Primary Exhaust PM <sub>2.5</sub> .....	408	3.4	1,600	21.8	1,856	24.4
CO .....	51,154	3.2	216,413	13.6	262,574	15.6
1,3-Butadiene .....	0	0.0	0	0.0	0	0.0
Acetaldehyde .....	8	0.4	32	1.8	37	1.9
Benzene .....	41	4.0	167	21.3	202	24.5
Formaldehyde .....	12	0.5	51	3.3	61	3.7
Methane (CH <sub>4</sub> ) .....	160	0.1	654	0.5	770	0.6
Naphthalene .....	1.2	0.8	5.7	12.6	7	14.6

C. Estimated Emission Reductions by Engine Operations and Processes

Looking more closely at the NO<sub>x</sub> emission inventory from highway heavy-duty vehicles, our analysis shows that the proposed standards would reduce emissions across several engine operations and processes, with the

greatest reductions attributable to medium-to-high load engine operations, low-load engine operations, and age effects (i.e., deterioration and mal-maintenance of emission controls, as well as tampering). As noted in Section I, without the proposed program, these processes are projected to contribute the most to the heavy-duty NO<sub>x</sub> emission

inventory in 2045. Table VI-3 compares NO<sub>x</sub> emissions in 2045 from different engine operations and processes with and without the proposed Options 1 and 2 standards. Additional details on our analysis of NO<sub>x</sub> emissions by process are included in the draft RIA Chapter 5.5.4.

TABLE VI-3—HEAVY-DUTY NO<sub>x</sub> EMISSION REDUCTIONS BY PROCESS IN CY2045 [US tons]

Engine operation or process	Emission inventory contribution without proposed options (%)	Tons reduced		Percent reduction from baseline (%)		Emission inventory contribution with proposed options (%)	
		Proposed Option 1	Proposed Option 2	Proposed Option 1	Proposed Option 2	Proposed Option 1	Proposed Option 2
Medium- to High-Load	36	286,661	243,887	81	73	17	18
Low-Load .....	28	183,971	149,913	70	57	21	23
Aging .....	24	82,340	23,389	38	11	38	40
Extended Idle & APU ...	2	11,717	10,340	66	58	2	2
Starts .....	4	12,091	10,341	31	26	8	6
Historical Fleet (MY 2010 to 2026) .....	6	0	0	0	0	14	11

D. Estimated Emission Reductions From the Alternative

As discussed in Section III, in addition to the proposed program, EPA analyzed an alternative set of emission

standards, with different regulatory useful life and emissions warranty periods.<sup>757</sup> Our estimates of the emission impacts that would result from the Alternative are presented below in Table VI-4. The Alternative is estimated

to reduce heavy-duty vehicle NO<sub>x</sub> emissions by 61 percent in 2045; estimated reductions in other pollutants are generally higher in the Alternative compared to the proposed Options 1 or 2.

TABLE VI-4—ANNUAL EMISSION REDUCTIONS FROM HEAVY-DUTY VEHICLES IN CALENDAR YEARS 2030, 2040, AND 2045—“THE ALTERNATIVE” EMISSIONS RELATIVE TO THE HEAVY-DUTY VEHICLE EMISSIONS BASELINE

Pollutant	CY 2030		CY 2040		CY 2045	
	US short tons	% Reduction	US short tons	% Reduction	US short tons	% Reduction
NO <sub>x</sub> .....	155,954	16.7	500,367	56.9	566,100	61.3
VOC .....	4,716	5.0	15,312	18.9	18,069	21.1
Primary Exhaust PM <sub>2.5</sub> .....	408	3.4	1,822	24.8	2,090	27.5
CO .....	51,154	3.2	247,475	15.5	295,561	17.5
1,3-Butadiene .....	0	0.0	0	0.0	0	0.0

<sup>757</sup> Under the Alternative, the numeric values of the NO<sub>x</sub> and HC standards are lower than the

proposed Option 1 MY 2031 standards; the useful

life and warranty mileages are also longer than those in proposed Option 1 for MY 2031.

TABLE VI-4—ANNUAL EMISSION REDUCTIONS FROM HEAVY-DUTY VEHICLES IN CALENDAR YEARS 2030, 2040, AND 2045—“THE ALTERNATIVE” EMISSIONS RELATIVE TO THE HEAVY-DUTY VEHICLE EMISSIONS BASELINE—Continued

Pollutant	CY 2030		CY 2040		CY 2045	
	US short tons	% Reduction	US short tons	% Reduction	US short tons	% Reduction
Acetaldehyde .....	9	0.4	49	2.7	56	2.9
Benzene .....	44	4.3	183	23.3	222	26.9
Formaldehyde .....	13	0.6	66	4.3	78	4.7
Methane (CH <sub>4</sub> ) .....	172	0.2	934	0.7	1,076	0.8
Naphthalene .....	1.4	0.9	6.6	14.6	8.0	16.9

### E. Evaluating Emission Impacts of Electric Vehicles in the Proposed Emission Inventory Baseline

As described in Section III, we relied on next-generation emission control technologies for CI and SI engines in our technology feasibility assessment for the proposed standards. Since BEV and FCEV technologies were not included in our feasibility assessment, and because these technologies currently make up less than 1 percent of the current heavy-duty market based on current EPA certification data, we did not include BEV and FCEV technologies in our emission inventory analysis described in Sections VI.B through VI.D, and detailed in draft RIA Chapter 5.<sup>758</sup> However, we have conducted a sensitivity analysis of BEV and FCEV tailpipe emission impacts based on potential market adoption (see draft RIA Chapter 1.4 and Chapter 5.5.5). Results of our analysis show that we would not expect a significant change in the percent emission reductions from the proposed criteria pollutant program if BEVs were to make up a larger percentage of heavy-duty vehicles in the 2045 baseline emission inventory (*i.e.*, 28 percent of medium heavy-duty and 10 percent of heavy heavy-duty vehicle sales in MY 2045).<sup>759 760</sup>

We recognize that it is important to properly define the baseline emission inventory for the final rule (*i.e.*, heavy-duty emissions without emission controls from this proposed EPA rule as finalized), which could include

<sup>758</sup>In MY 2019 manufacturers certified approximately 350 heavy-duty BEVs, based on production volume reports submitted to the agency. This is out of nearly 615,000 heavy-duty diesel vehicles certified in MY 2019, which represents approximately 0.06 percent of the market. See Sections IV and XI, and RIA Chapter 1.4 for more details on current and potential future production volumes of BEVs and FCEVs.

<sup>759</sup>See Preamble Section XI for discussion on our current expectations for how additional electrification of the heavy-duty market could impact the emission reductions expected from the HD GHG Phase 2 program.

<sup>760</sup>We used proposed Option 1 to conduct this sensitivity analysis but expect similar results with proposed Option 2.

projected market penetration rates of BEVs and FCEVs. Specifically, in the final rule we may account for the recent Advanced Clean Truck (ACT) rulemaking in California,<sup>761</sup> and the Memorandum of Understanding (MOU) signed by 15 states.<sup>762</sup>

As discussed in the draft RIA Chapter 1.4.2.3, the CA ACT requires manufacturers to sell a certain percentage of zero emission heavy-duty vehicles (BEVs or FCEVs) for each model year, starting in MY 2024.<sup>763 764 765</sup> The sales requirements vary by vehicle class, but start at 5 to 9 percent of total MY 2024 heavy-duty vehicle sales in California and increase up to 40 to 75 percent of sales for MY 2035 and beyond.<sup>766</sup> The 15-state MOU affirms a commitment to strive towards at least 30 percent of new heavy-duty vehicle sales being zero emission vehicles by 2030 and to reach 100 percent of new sales by 2050. While the MOU does not impose any binding

<sup>761</sup>As noted in Section I.D, EPA is reviewing a waiver request under CAA section 209(b) from California for the ACT rule; we may consider including some analyses that account for BEVs and FCEVs produced to meet the CARB ACT requirements in the final EPA rule.

<sup>762</sup>“Multi-state Medium- and Heavy-Duty Zero Emission Vehicle Memorandum of Understanding” July 13, 2020. Available online at: <https://www.nescaum.org/topics/zero-emission-vehicles>.

<sup>763</sup>California Air Resources Board. “Notice of Decision: Advanced Clean Truck Regulation.” June 2020. Available online at: <https://ww3.arb.ca.gov/regact/2019/act2019/nod.pdf>.

Additional discussion on the CARB ACT is also included in Preamble XI.

<sup>764</sup>Buysse and Sharpe. (July 20, 2020) “California’s Advanced Clean Trucks regulation: Sales requirements for zero-emission heavy-duty trucks”, available online at: <https://theicct.org/publications/california-hdv-ev-update-jul2020> (last accessed August 11, 2021).

<sup>765</sup>California is also developing an Advanced Clean Fleets regulation that would require fleets that are well suited for electrification to transition to BEVs or FCEVs where feasible. For more information, see: California Air Resources Board. “Advanced Clean Fleets Fact Sheet.” August 2021. Available at: <https://ww2.arb.ca.gov/resources/fact-sheets/advanced-clean-fleets-fact-sheet>.

<sup>766</sup>CARB. “Appendix A Proposed Regulation Order” Advanced Clean Truck Regulation.” May 2020. Available online at: <https://ww3.arb.ca.gov/regact/2019/act2019/30dayatta.pdf> (accessed July 24, 2020).

requirements, it may result in higher sales of BEVs and FCEVs in participating states.

EPA solicits comment on whether and how to reflect the expectations for higher sales volumes of BEVs and FCEVs in California and other states in the baseline emission inventory for the final rule (*i.e.*, without this EPA rule as finalized). EPA will consider public comments and other relevant information in deciding to how to reflect future sales volumes of BEVs and FCEVs in the emission inventory analysis of the final rule.

### VII. Air Quality Impacts of the Proposed Program

As discussed in Section VI, we expect the standards in the proposed Options 1 and 2 to result in meaningful reductions in emissions of NO<sub>x</sub>, VOC, CO and PM<sub>2.5</sub>. In this section, we summarize the results of our air quality modeling based on the projected emission reductions from the proposed Option 1 standards.<sup>767</sup> The “base” case represents 2016 air quality. The “reference” scenario represents projected 2045 air quality without the proposed rule and the “control” scenario represents projected 2045 emissions with proposed Option 1. Air quality modeling was done for the future year 2045 when the program would be fully implemented and when most of the regulated fleet would have turned over.

The air quality modeling predicts decreases in ambient concentrations of air pollutants in 2045 due to the proposed Option 1, including significant improvements in ozone concentrations. Ambient PM<sub>2.5</sub>, NO<sub>2</sub> and CO concentrations are also

<sup>767</sup>Due to resource constraints, we only conducted air quality modeling for the proposed Option 1. As noted in Chapter 5.4 of the draft RIA, while we refer to this modeling as for the proposed Option 1, there are differences between the proposed Option 1 standards, emission warranty, and useful life provisions presented in Sections III and IV of this preamble and those included in the control scenario modeled for the air quality analysis.



predicted to improve in 2045 as a result of the proposed Option 1. The proposed Option 1 is expected to result in improvements in nitrogen deposition and visibility but is predicted to have relatively little impact on ambient concentrations of air toxics. Additional information and maps showing expected changes in ambient concentrations of air pollutants in 2045 due to proposed Option 1 are included in Chapter 6 of the draft RIA and in the Air Quality Modeling Technical Support Document.<sup>768</sup>

*A. Ozone*

The proposed rule would reduce 8-hour ozone design values significantly in 2045. The proposed Option 1 would decrease ozone design values by more than 2 ppb in over 150 counties, and over 200 additional modeled counties are projected to have decreases in ozone design values of between 1 and 2 ppb in 2045. Our modeling projections indicate that some counties would have design values above the level of the 2015 NAAQS in 2045, and the proposed Option 1 would help those counties, as well as other counties, in reducing ozone concentrations. Table VII–1

shows the average projected change in 2045 8-hour ozone design values due to the proposed Option 1 standards. Counties within 10 percent of the level of the NAAQS are intended to reflect counties that, although not violating the standard, would also be affected by changes in ambient levels of ozone as they work to ensure long-term attainment or maintenance of the ozone NAAQS. The projected changes in design values, summarized in Table VII–1, indicate in different ways the overall improvement in ozone air quality due to emission reductions from the proposed Option 1 standards, if implemented as modeled.

TABLE VII–1—AVERAGE CHANGE IN PROJECTED 8-HOUR OZONE DESIGN VALUES IN 2045 DUE TO PROPOSED OPTION 1

Projected design value category	Number of counties	2045 Population <sup>a</sup>	Average change in 2045 design value (ppb)	Population-weighted average change in design value (ppb)
All modeled counties .....	457	246,949,949	– 1.87	– 2.23
Counties with 2016 base year design values above the level of the 2015 8-hour ozone standard .....	118	125,319,158	– 2.12	– 2.43
Counties with 2016 base year design values within 10% of the 2015 8-hour ozone standard .....	245	93,417,097	– 1.83	– 2.10
Counties with 2045 reference design values above the level of the 2015 8-hour ozone standard .....	15	37,758,488	– 2.26	– 3.03
Counties with 2045 reference design values within 10% of the 2015 8-hour ozone standard .....	56	39,302,665	– 1.78	– 2.02
Counties with 2045 control design values above the level of the 2015 8-hour ozone standard .....	10	27,930,138	– 2.36	– 3.34
Counties with 2045 control design values within 10% of the 2015 8-hour ozone standard .....	42	31,395,617	– 1.69	– 1.77

<sup>a</sup>Population numbers based on Woods & Poole data. Woods & Poole Economics, Inc. (2015). Complete Demographic Database. Washington, DC. <http://www.woodsandpoole.com/index.php>.

*B. Particulate Matter*

The proposed rule would reduce 24-hour and annual PM<sub>2.5</sub> design values in 2045. The proposed Option 1 standards would decrease projected annual PM<sub>2.5</sub> design values in the majority of modeled counties by between 0.01 and 0.05 ug/m<sup>3</sup> and by greater than 0.05 ug/m<sup>3</sup> in over 75 additional counties. The proposed Option 1 standards would decrease projected 24-hour PM<sub>2.5</sub> design values by between 0.15 and 0.5 ug/m<sup>3</sup> in over 150 counties and by greater than

0.5 ug/m<sup>3</sup> in 5 additional counties. Our air quality modeling projections indicate that some counties would have design values above the level of the 2012 PM<sub>2.5</sub> NAAQS in 2045 and the proposed Option 1 would help those counties, as well as other counties, in reducing PM<sub>2.5</sub> concentrations. Table VII–2 and Table VII–3 present the average projected changes in 2045 annual and 24-hour PM<sub>2.5</sub> design values. Counties within 10 percent of the level of the NAAQS are intended to reflect

counties that, although not violating the standards, would also be affected by changes in ambient levels of PM<sub>2.5</sub> as they work to ensure long-term attainment or maintenance of the annual and/or 24-hour PM<sub>2.5</sub> NAAQS. The projected changes in PM<sub>2.5</sub> design values, summarized in Table VII–2 and Table VII–3, indicate in different ways the overall improvement in PM<sub>2.5</sub> air quality due to the emission reductions resulting from the proposed Option 1 standards, if implemented as modeled.

TABLE VII–2—AVERAGE CHANGE IN PROJECTED ANNUAL PM<sub>2.5</sub> DESIGN VALUES IN 2045 DUE TO PROPOSED OPTION 1

Projected design value category	Number of counties	2045 Population <sup>a</sup>	Average change in 2045 design value (ug/m <sup>3</sup> )	Population-weighted average change in design value (ug/m <sup>3</sup> )
All modeled counties .....	568	273,604,437	– 0.04	– 0.04

<sup>768</sup>USEPA (2021) Technical Support Document: Air Quality Modeling for the HD 2027 Proposal. EPA–HQ–OAR–2019–0055. October 2021.

TABLE VII-2—AVERAGE CHANGE IN PROJECTED ANNUAL PM<sub>2.5</sub> DESIGN VALUES IN 2045 DUE TO PROPOSED OPTION 1—Continued

Projected design value category	Number of counties	2045 Population <sup>a</sup>	Average change in 2045 design value (ug/m <sup>3</sup> )	Population-weighted average change in design value (ug/m <sup>3</sup> )
Counties with 2016 base year design values above the level of the 2012 annual PM <sub>2.5</sub> standard .....	17	26,726,354	-0.09	-0.05
Counties with 2016 base year design values within 10% of the 2012 annual PM <sub>2.5</sub> standard .....	5	4,009,527	-0.06	-0.06
Counties with 2045 reference design values above the level of the 2012 annual PM <sub>2.5</sub> standard .....	12	25,015,974	-0.10	-0.05
Counties with 2045 reference design values within 10% of the 2012 annual PM <sub>2.5</sub> standard .....	6	1,721,445	-0.06	-0.06
Counties with 2045 control design values above the level of the 2012 annual PM <sub>2.5</sub> standard .....	10	23,320,070	-0.10	-0.05
Counties with 2045 control design values within 10% of the 2012 annual PM <sub>2.5</sub> standard .....	8	3,417,349	-0.08	-0.09

<sup>a</sup> Population numbers based on Woods & Poole data. Woods & Poole Economics, Inc. (2015). Complete Demographic Database. Washington, DC. <http://www.woodsandpoole.com/index.php>.

TABLE VII-3—AVERAGE CHANGE IN PROJECTED 24-HOUR PM<sub>2.5</sub> DESIGN VALUES IN 2045 DUE TO PROPOSED OPTION 1

Projected design value category	Number of counties	2045 Population <sup>a</sup>	Average change in 2045 design value (ug/m <sup>3</sup> )	Population-weighted average change in design value (ug/m <sup>3</sup> )
All modeled counties .....	568	272,852,777	-0.12	-0.17
Counties with 2016 base year design values above the level of the 2006 daily PM <sub>2.5</sub> standard .....	33	28,394,253	-0.40	-0.67
Counties with 2016 base year design values within 10% of the 2006 daily PM <sub>2.5</sub> standard .....	15	13,937,416	-0.18	-0.27
Counties with 2045 reference design values above the level of the 2006 daily PM <sub>2.5</sub> standard .....	29	14,447,443	-0.38	-0.55
Counties with 2045 reference design values within 10% of the 2006 daily PM <sub>2.5</sub> standard .....	12	22,900,297	-0.30	-0.59
Counties with 2045 control design values above the level of the 2006 daily PM <sub>2.5</sub> standard .....	29	14,447,443	-0.38	-0.55
Counties with 2045 control design values within 10% of the 2006 daily PM <sub>2.5</sub> standard .....	10	19,766,216	-0.26	-0.60

<sup>a</sup> Population numbers based on Woods & Poole data. Woods & Poole Economics, Inc. (2015). Complete Demographic Database. Washington, DC. <http://www.woodsandpoole.com/index.php>.

### C. Nitrogen Dioxide

Our modeling indicates that in 2045 the proposed Option 1 would decrease annual NO<sub>2</sub> concentrations in most urban areas and along major roadways by more than 0.3 ppb and would decrease annual NO<sub>2</sub> concentrations by between 0.01 and 0.1 ppb across much of the rest of the country. The proposed Option 1 emissions reductions would also likely decrease 1-hour NO<sub>2</sub> concentrations and help any potential nonattainment areas attain and maintenance areas maintain the NO<sub>2</sub> standard.<sup>769</sup> Section 6.3.4 of the draft RIA contains more detail on the impacts of the proposed Option 1 on NO<sub>2</sub> concentrations.

<sup>769</sup> As noted in Section II, there are currently no nonattainment areas for the NO<sub>2</sub> NAAQS.

### D. Carbon Monoxide

Our modeling indicates that in 2045 the proposed Option 1 would decrease annual CO concentrations by more than 0.5 ppb in many urban areas and would decrease annual CO concentrations by between 0.02 and 0.5 ppb across much of the rest of the country. The emissions reductions from proposed Option 1 would also likely decrease 1-hour and 8-hour CO concentrations and help any potential nonattainment areas attain and maintenance areas maintain the CO standard.<sup>770</sup> Section 6.3.5 of the draft RIA contains more detail on the impacts of the proposed Option 1 on CO concentrations.

<sup>770</sup> As noted in Section II, there are currently no nonattainment areas for the CO NAAQS.

### E. Air Toxics

In general, our modeling indicates that the proposed Option 1 would have relatively little impact on national average ambient concentrations of the modeled air toxics in 2045. The proposed Option 1 standards would have smaller impacts on air toxic pollutants dominated by primary emissions (or a decay product of a directly emitted pollutant), and relatively larger impacts on air toxics that primarily result from photochemical transformation, in this case due to the projected large reductions in NO<sub>x</sub> emissions. Specifically, in 2045, our modeling projects that the proposed Option 1 would decrease ambient benzene and naphthalene concentrations by less than 0.001 ug/m<sup>3</sup> across the country.

Acetaldehyde concentrations would increase slightly across most of the country, while formaldehyde would generally have small decreases in most areas and some small increases in urban areas. Section 6.3.6 of the draft RIA contains more detail on the impacts of the proposed Option 1 on air toxics concentrations.

#### F. Visibility

Air quality modeling of Option 1 was used to project visibility conditions in 145 Mandatory Class I Federal areas across the U.S. The results show that the proposed Option 1 standards would improve visibility in these areas.<sup>771</sup> The average visibility at all modeled Mandatory Class I Federal areas on the 20 percent most impaired days is projected to improve by 0.04 deciviews, or 0.37 percent, in 2045 due to the proposed Option 1. Section 6.3.7 of the draft RIA contains more detail on the visibility portion of the air quality modeling.

#### G. Nitrogen Deposition

Our air quality modeling conducted for the proposed rule projects substantial decreases in nitrogen deposition in 2045 as a result of the proposed Option 1. The proposed Option 1 standards would result in annual decreases of greater than 4 percent in some areas and greater than 1 percent over much of the rest of the country. For maps of deposition impacts, and additional information on these impacts, see Section 6.3.8 of the draft RIA.

#### H. Demographic Analysis of Air Quality

When feasible, EPA's Office of Transportation and Air Quality conducts full-scale photochemical air quality modeling to demonstrate how its national mobile source regulatory actions affect ambient concentrations of regional pollutants throughout the United States. As described in draft RIA Chapter 6.2, the air quality modeling we conducted supports our analysis of future projections of PM<sub>2.5</sub> and ozone concentrations in a "baseline" scenario absent the proposed rule and in a "control" scenario that assumes the proposed Option 1 is in place. The incremental reductions in estimated air

<sup>771</sup> The level of visibility impairment in an area is based on the light-extinction coefficient and a unitless visibility index, called a "deciview", which is used in the valuation of visibility. The deciview metric provides a scale for perceived visual changes over the entire range of conditions, from clear to hazy. Under many scenic conditions, the average person can generally perceive a change of one deciview. The higher the deciview value, the worse the visibility. Thus, an improvement in visibility is a decrease in deciview value.

quality concentrations between the two scenarios are therefore attributed to the proposed rule. These baseline and control scenarios are also used as inputs to the health benefits analysis. As demonstrated in draft RIA Chapter 6.3 and Chapter 8.6, the ozone and PM<sub>2.5</sub> improvements that are projected to result from the proposed rule, and the health benefits associated with those pollutant reductions would be substantial.

This air quality modeling data can also be used to conduct a demographic analysis of human exposure to future air quality in scenarios with and without the proposed rule in place. To compare demographic trends, we sorted projected 2045 baseline air quality concentrations from highest to lowest concentration and created two groups: areas within the contiguous U.S. with the worst air quality (highest 5 percent of concentrations) and the rest of the country. This approach can then answer two principal questions to determine disparity among people of color:

1. What is the demographic composition of areas with the worst baseline air quality in 2045?
  2. Are those with the worst air quality benefiting more from the proposed rule?
- We found that in the 2045 baseline, the number of people of color projected to live within the grid cells with the highest baseline concentrations of ozone (26 million) is nearly double that of NH-Whites (14 million). Thirteen percent of people of color are projected to live in areas with the worst baseline ozone, compared to seven percent of NH-Whites. The number of people of color projected to live within the grid cells with the highest baseline concentrations of PM<sub>2.5</sub> (93 million) is nearly double that of NH-Whites (51 million). Forty-six percent of people of color are projected to live in areas with the worst baseline PM<sub>2.5</sub>, compared to 25 percent of NH-Whites.

We also found that the largest predicted improvements in both ozone and PM<sub>2.5</sub> are estimated to occur in areas with the worst baseline air quality, where larger numbers of people of color are projected to reside. Chapter 6.3.9 of the draft RIA describes the data and methods used to conduct the demographic analysis and presents our results in detail. We seek comment on how to improve this analysis for the final rule.

#### VIII. Benefits of the Proposed Program

The highway heavy-duty engines and vehicles subject to the proposed criteria pollutant program are significant sources of mobile source air pollution, including emissions of directly-emitted

PM<sub>2.5</sub> as well as NO<sub>x</sub> and VOCs (both precursors to ozone formation and secondarily-formed PM<sub>2.5</sub>). The proposed program would reduce exhaust emissions of these pollutants from the regulated engines and vehicles, which would reduce ambient concentrations of ozone and PM<sub>2.5</sub> (see Section VII). Exposures to these pollutants are linked to adverse environmental and human health impacts, such as premature deaths and non-fatal illnesses (see Section II).

In this section, we present the quantified and monetized human health benefits from reducing concentrations of ozone and PM<sub>2.5</sub> using the air quality modeling results described in Section VII. For the proposed rulemaking, we have quantified and monetized health impacts in 2045, representing projected benefits in a year when the program would be fully implemented and when most of the regulated fleet would have turned over. Overall, we estimate that the proposed program would lead to a substantial decrease in adverse PM<sub>2.5</sub>- and ozone-related health impacts.

We adopt an updated analysis approach that was recently used to quantify the benefits of changes in PM<sub>2.5</sub> and ozone in the final Revised Cross-State Air Pollution Rule (CSAPR) Update RIA.<sup>772 773</sup> While the steps to performing a criteria pollutant benefits analysis remain unchanged from past mobile source rulemakings (e.g., Tier 3 Motor Vehicle Emission and Fuel Standards Final Rule),<sup>774</sup> the final CSAPR RIA updated the suite of quantified health endpoints included in the benefits analysis, as well as the data used to quantify each health endpoint, to reflect more recent scientific evidence. These updates were based on information drawn from the recent PM<sub>2.5</sub> and ozone Integrated Science Assessments (ISAs), which were reviewed by the Clean Air Science Advisory Committee (CASAC) and the public,<sup>775 776</sup> and are summarized in a

<sup>772</sup> U.S. Environmental Protection Agency (U.S. EPA). 2021. Regulatory Impact Analysis for the Final Revised Cross-State Air Pollution Rule (CSAPR) Update for the 2008 Ozone NAAQS. EPA-452/R-21-002. March.

<sup>773</sup> On March 15, 2021, EPA finalized the Revised Cross-State Air Pollution Rule Update for the 2008 ozone National Ambient Air Quality Standards (NAAQS). Starting in the 2021 ozone season, the rule will require additional emissions reductions of nitrogen oxides (NO<sub>x</sub>) from power plants in 12 states. <https://www.epa.gov/csapr/revised-cross-state-air-pollution-rule-update>.

<sup>774</sup> U.S. Environmental Protection Agency (U.S. EPA). 2014. Control of Air Pollution from Motor Vehicles: Tier 3 Motor Vehicle Emission and Fuel Standards Rule Regulatory Impact Analysis. EPA-420-R-14-005. March.

<sup>775</sup> U.S. Environmental Protection Agency (U.S. EPA). 2019. Integrated Science Assessment (ISA) for

technical support document (TSD) originally published for the final Revised CSAPR Update titled Estimating PM<sub>2.5</sub>- and Ozone-Attributable Health Benefits.<sup>777</sup>

Table VIII–1 and Table VIII–2 present quantified health benefits from reductions in human exposure to ambient PM<sub>2.5</sub> and ozone, respectively, from proposed Option 1 in 2045.<sup>778</sup> Table VIII–3 presents the total monetized benefits attributable to the proposed Option 1 in 2045.

We estimate that in 2045, the proposed Option 1 criteria pollutant program would result in total annual monetized benefits of \$12 and \$33

billion at a 3 percent discount rate and \$10 and \$30 billion at a 7 percent discount rate (2017 dollars).

There are additional human health and environmental benefits associated with reductions in exposure to ambient concentrations of PM<sub>2.5</sub>, ozone, and NO<sub>2</sub> that EPA has not quantified due to data, resource, or methodological limitations. There would also be benefits associated with reductions in air toxic pollutant emissions that result from the proposed program, but EPA is not currently able to monetize those impacts due to methodological limitations. The proposed criteria pollutant standards

would also reduce methane (CH<sub>4</sub>) emissions due to lower total hydrocarbon emission rates from the tailpipe of heavy-duty gasoline vehicles (see draft RIA Chapter 5.2.2 for more detail). The estimated benefits of the proposal would be larger if we were able to monetize all unquantified benefits at this time. We request comment on how to address the climate benefits and other categories of non-monetized benefits of the proposed rule. For more detailed information about the benefits analysis conducted for the proposal, please refer to draft RIA Chapter 8 that accompanies this preamble.

TABLE VIII–1—ESTIMATED AVOIDED PM<sub>2.5</sub> MORTALITY AND ILLNESSES FOR THE PROPOSED OPTION 1 POLICY SCENARIO FOR 2045

[95 percent confidence interval]<sup>a,b</sup>

		Proposed option 1
<b>Avoided premature mortality</b>		
	Turner et al. (2016)—Ages 30+ .....	740 (500 to 980)
	Di et al. (2017)—Ages 65+ .....	800 (780 to 830)
	Woodruff et al. (2008)—Ages < 1 .....	4.1 (– 2.6 to 11)
<b>Non-fatal heart attacks among adults</b>		
Short-term exposure .....	Peters et al. (2001) .....	790 (180 to 1,400)
	Pooled estimate .....	85 (31 to 230)
<b>Morbidity effects</b>		
Long-term exposure .....	Asthma onset .....	1,600 (1,500 to 1,600)
	Allergic rhinitis symptoms .....	10,000 (2,500 to 18,000)
	Stroke .....	41 (11 to 70)
	Lung cancer .....	52 (16 to 86)
	Hospital Admissions—Alzheimer’s disease .....	400 (300 to 500)
	Hospital Admissions—Parkinson’s disease .....	43 (22 to 63)
Short-term exposure .....	Hospital admissions—cardiovascular .....	110 (76 to 130)
	ED visits—cardiovascular .....	210 (– 82 to 500)
	Hospital admissions—respiratory .....	68 (23 to 110)
	ED visits—respiratory .....	400 (78 to 830)
	Asthma symptoms .....	210,000 (– 100,000 to 520,000)

Particulate Matter (Final Report, 2019). U.S. Environmental Protection Agency, Washington, DC, EPA/600/R–19/188, 2019.

<sup>776</sup> U.S. Environmental Protection Agency (U.S. EPA). 2020. Integrated Science Assessment (ISA) for Ozone and Related Photochemical Oxidants (Final Report). U.S. Environmental Protection Agency, Washington, DC, EPA/600/R–20/012, 2020.

<sup>777</sup> U.S. Environmental Protection Agency (U.S. EPA). 2021. Estimating PM<sub>2.5</sub>- and Ozone-Attributable Health Benefits. Technical Support Document (TSD) for the Final Revised Cross-State Air Pollution Rule Update for the 2008 Ozone Season NAAQS. EPA–HQ–OAR–2020–0272. March.

<sup>778</sup> As noted in Section VII, due to resource constraints we only conducted air quality modeling

for the proposed Option 1. Since the air quality modeling results are necessary to quantify estimates of avoided mortality and illness attributable to changes in ambient PM<sub>2.5</sub> or ozone due to the proposed rule, we only have these estimates for proposed Option 1.

TABLE VIII-1—ESTIMATED AVOIDED PM<sub>2.5</sub> MORTALITY AND ILLNESSES FOR THE PROPOSED OPTION 1 POLICY SCENARIO FOR 2045—Continued

[95 percent confidence interval]<sup>a,b</sup>

	Proposed option 1
Minor restricted-activity days .....	460,000 (370,000 to 550,000)
Cardiac arrest .....	10 (- 4.2 to 24)
Lost work days .....	78,000 (66,000 to 90,000)

<sup>a</sup> Values rounded to two significant figures.

<sup>b</sup> PM<sub>2.5</sub> exposure metrics are not presented here because all PM health endpoints are based on studies that used daily 24-hour average concentrations. Annual exposures are estimated using daily 24-hour average concentrations.

TABLE VIII-2—ESTIMATED AVOIDED OZONE MORTALITY AND ILLNESSES FOR THE PROPOSED OPTION 1 POLICY SCENARIO FOR 2045

[95 percent confidence interval]<sup>a</sup>

		Metric and season <sup>b</sup>	Proposed Option 1
<b>Avoided premature mortality</b>			
Long-term exposure .....	Turner et al. (2016) .....	MDA8 .....	2,100 (1,400 to 2,700)
		April–September .....	
Short-term exposure .....	Katsouyanni et al (2009) .....	MDA1 .....	120 (- 69 to 300)
		April–September .....	
<b>Morbidity effects</b>			
Long-term exposure .....	Asthma onset <sup>c</sup> .....	MDA8 .....	16,000 (14,000 to 18,000)
		June–August .....	
Short-term exposure .....	Allergic rhinitis symptoms .....	MDA8 .....	88,000 (47,000 to 130,000)
		May–September .....	
	Hospital admissions—respiratory .....	MDA1 .....	350 (- 91 to 770)
		April–September .....	
	ED visits—respiratory .....	MDA8 .....	5,100 (1,400 to 11,000)
		May–September .....	
	Asthma symptoms—Cough <sup>d</sup> .....	MDA8 .....	920,000 (- 50,000 to 1,800,000)
		May–September .....	
	Asthma symptoms—Chest Tightness <sup>d</sup> .....	MDA8 .....	770,000 (85,000 to 1,400,000)
		May–September .....	
	Asthma symptoms—Shortness of Breath <sup>d</sup> .....	MDA8 .....	390,000 (- 330,000 to 1,100,000)
		May–September .....	
	Asthma symptoms—Wheeze <sup>d</sup> .....	MDA8 .....	730,000 (- 57,000 to 1,500,000)
		May–September .....	
	Minor restricted-activity days <sup>d</sup> .....	MDA1 .....	1,600,000 (650,000 to 2,600,000)
		May–September .....	
	School absence days .....	MDA8 .....	1,100,000 (- 150,000 to 2,200,000)
		May–September .....	

<sup>a</sup> Values rounded to two significant figures.

<sup>b</sup> MDA8—maximum daily 8-hour average; MDA1—maximum daily 1-hour average. Studies of ozone vary with regards to season, limiting analyses to various definitions of summer (e.g., April–September, May–September or June–August). These differences can reflect state-specific ozone seasons, EPA-defined seasons or another seasonal definition chosen by the study author. The paucity of ozone monitoring data in winter months complicates the development of full year projected ozone surfaces and limits our analysis to only warm seasons.

<sup>c</sup> The underlying metric associated with this risk estimate is daily 8-hour average from 10 a.m.–6 p.m. (AVG8); however, we ran the study with a risk estimate converted to MDA8.

<sup>d</sup> Applied risk estimate derived from full year exposures to estimates of ozone across a May–September ozone season. When risk estimates based on full-year, long-term ozone exposures are applied to warm season air quality projections, the resulting benefits assessment may underestimate impacts, due to a shorter timespan for impacts to accrue.

**TABLE VIII-3—TOTAL OZONE AND PM<sub>2.5</sub>-ATTRIBUTABLE BENEFITS FOR THE PROPOSED OPTIONS 1 POLICY SCENARIOS IN 2045**

[95 percent confidence interval; billions of 2017\$]<sup>a,b</sup>

	Total annual benefits in 2045
3% Discount Rate.	\$12 (\$0.72 to \$31) <sup>c</sup> and \$33 (\$3.5 to \$87) <sup>d</sup>
7% Discount Rate.	\$10 (\$0.37 to \$28) <sup>c</sup> and \$30 (\$3.0 to \$78) <sup>d</sup>

<sup>a</sup>The benefits associated with the standards presented here do not include the full complement of health, environmental, and climate-related benefits that, if quantified and monetized, would increase the total monetized benefits.

<sup>b</sup>Values rounded to two significant figures. The two benefits estimates separated by the word “and” signify that they are two separate estimates. The estimates do not represent lower- and upper-bound estimates though they do reflect a grouping of estimates that yield more and less conservative benefit totals. They should not be summed.

<sup>c</sup>Sum of benefits using the Katsouyanni et al. (2009) short-term exposure ozone respiratory mortality risk estimate and the Turner et al. (2016) long-term exposure PM<sub>2.5</sub> all-cause risk estimate.

<sup>d</sup>Sum of benefits using the Turner et al. (2016) long-term exposure ozone respiratory mortality risk estimate and the Di et al. (2017) long-term exposure PM<sub>2.5</sub> all-cause risk estimate.

The full-scale criteria pollutant benefits analysis for Option 1 presented in this section reflects spatially and temporally allocated emissions inventories (see draft RIA Chapter 5), photochemical air quality modeling (see draft RIA Chapter 6), and PM<sub>2.5</sub> and ozone benefits generated using BenMAP-CE (see draft RIA Chapter 8), all for conditions projected to occur in calendar year 2045. As we presented in Sections V and VI, national estimates of emissions and program costs were generated for each analysis year from Option 1’s proposed implementation to a year when Option 1 would be fully phased-in and the vehicle fleet would be approaching full turnover (2027–2045). The computational requirements needed to conduct photochemical air quality modeling to support a full-scale benefits analysis for Option 2 in 2045 and for all Option 1 and Option 2 analysis years from 2027 to 2044 precluded the Agency from conducting benefits analyses comparable to the calendar year 2045 Option 1 benefits analysis. Instead, we have used a reduced-form approach to scale total Option 1 benefits in 2045 back to 2027 using projected reductions in year-over-year NO<sub>x</sub> emissions so that we can estimate the present and annualized values of the stream of estimated benefits for Option 1. We have also used

year-over-year Option 2 NO<sub>x</sub> emissions reductions to scale the total benefits associated with Option 1 to derive a best estimate of criteria pollutant benefits associated with Option 2.<sup>779</sup> For more information on the benefits scaling approach we applied to estimate criteria pollutant benefits over time for the proposed Options 1 and 2, please refer to draft RIA Chapter 8.7 that accompanies this preamble.

Table VIII-4 and Table VIII-5 present the annual, estimated undiscounted total health benefits (PM<sub>2.5</sub> plus ozone) for the stream of years beginning with the first year of rule implementation, 2027, through 2045 for the proposed Options 1 and 2.<sup>780</sup> The tables also present the present and annualized values of benefits over this time series, discounted using both 3 percent and 7 percent discount rates and reported in 2017 dollars. Table VIII-4 presents total benefits as the sum of short-term ozone respiratory mortality benefits for all ages, long-term PM<sub>2.5</sub> all-cause mortality benefits for ages 30 and above, and all monetized avoided illnesses. Table VIII-5 presents total benefits as the sum of long-term ozone respiratory mortality benefits for ages 30 and above, long-term PM<sub>2.5</sub> all-cause mortality benefits for ages 65 and above, and all monetized avoided illnesses.

**TABLE VIII-4—UNDISCOUNTED STREAM AND PRESENT VALUE OF HUMAN HEALTH BENEFITS FROM 2027 THROUGH 2045: MONETIZED BENEFITS QUANTIFIED AS SUM OF SHORT-TERM OZONE RESPIRATORY MORTALITY AGES 0–99, AND LONG-TERM PM<sub>2.5</sub> ALL-CAUSE MORTALITY AGES 30+**

[Discounted at 3 percent and 7 percent; billions of 2017\$]<sup>a,b</sup>

	Proposed Option 1		Proposed Option 2	
	3%	7%	3%	7%
2027 .....	\$0.57	\$0.51	\$0.52	\$0.47
2028 .....	1.2	1.1	1.1	0.98
2029 .....	1.8	1.7	1.7	1.5
2030 .....	2.5	2.3	2.3	2.1
2031 .....	3.4	3.1	3.1	2.7
2032 .....	4.3	3.9	3.8	3.4
2033 .....	5.0	4.5	4.3	3.9
2034 .....	5.6	5.0	4.9	4.4
2035 .....	6.3	5.7	5.4	4.8
2036 .....	6.9	6.2	5.8	5.3
2037 .....	7.8	7.0	6.3	5.7
2038 .....	8.6	7.7	6.7	6.0
2039 .....	9.1	8.2	7.1	6.4
2040 .....	9.6	8.6	7.5	6.7
2041 .....	10	9.0	7.8	7.1
2042 .....	10	9.4	8.2	7.4
2043 .....	11	9.8	8.5	7.6
2044 .....	11	10	8.8	7.9
2045 <sup>c</sup> .....	12	10	9.1	8.2
Present Value .....	87	50	71	41

<sup>779</sup> Because NO<sub>x</sub> is the dominating pollutant controlled by the proposed Options, we make a simplifying assumption that total PM and ozone benefits can be scaled by NO<sub>x</sub> emissions, even

though emissions of other pollutants are controlled in smaller amounts by the proposed program.

<sup>780</sup> We are not including an analysis of benefits of the Alternative (described in Sections III and IV)

because we currently do not have sufficient information to conclude that the Alternative standards would be feasible in the MY 2027 timeframe (see Section III for details).

TABLE VIII-4—UNDISCOUNTED STREAM AND PRESENT VALUE OF HUMAN HEALTH BENEFITS FROM 2027 THROUGH 2045: MONETIZED BENEFITS QUANTIFIED AS SUM OF SHORT-TERM OZONE RESPIRATORY MORTALITY AGES 0–99, AND LONG-TERM PM<sub>2.5</sub> ALL-CAUSE MORTALITY AGES 30+—Continued

[Discounted at 3 percent and 7 percent; billions of 2017\$]<sup>a b</sup>

	Proposed Option 1		Proposed Option 2	
	3%	7%	3%	7%
Annualized Value .....	6.1	4.9	5.0	4.0

<sup>a</sup> The benefits associated with the standards presented here do not include the full complement of health, environmental, and climate-related benefits that, if quantified and monetized, would increase the total monetized benefits.

<sup>b</sup> Benefits calculated as value of avoided: PM<sub>2.5</sub>—attributable deaths (quantified using a concentration-response relationship from the Turner et al. 2016 study); Ozone-attributable deaths (quantified using a concentration-response relationship from the Katsouyanni et al. 2009 study); and PM<sub>2.5</sub> and ozone-related morbidity effects.

<sup>c</sup> Year in which PM<sub>2.5</sub> and ozone air quality associated with Option 1 was simulated (2045).

TABLE VIII-5—UNDISCOUNTED STREAM AND PRESENT VALUE OF HUMAN HEALTH BENEFITS FROM 2027 THROUGH 2045: MONETIZED BENEFITS QUANTIFIED AS SUM OF LONG-TERM OZONE RESPIRATORY MORTALITY AGES 30+, AND LONG-TERM PM<sub>2.5</sub> ALL-CAUSE MORTALITY AGES 65+

[Discounted at 3 percent and 7 percent; billions of 2017\$]<sup>a b</sup>

	Proposed Option 1		Proposed Option 2	
	3%	7%	3%	7%
2027 .....	\$1.6	\$1.4	\$1.4	\$1.3
2028 .....	3.3	2.9	3.0	2.7
2029 .....	5.1	4.6	4.7	4.2
2030 .....	7.0	6.3	6.4	5.8
2031 .....	9.6	8.6	8.5	7.6
2032 .....	12	11	11	9.5
2033 .....	14	13	12	11
2034 .....	16	14	14	12
2035 .....	18	16	15	14
2036 .....	20	18	17	15
2037 .....	22	20	18	16
2038 .....	24	22	19	17
2039 .....	26	23	20	18
2040 .....	28	25	21	19
2041 .....	29	26	23	20
2042 .....	30	27	24	21
2043 .....	31	28	24	22
2044 .....	32	29	25	23
2045 <sup>c</sup> .....	33	30	26	23
Present Value .....	250	140	200	120
Annualized Value .....	17	14	14	11

<sup>a</sup> The benefits associated with the standards presented here do not include the full complement of health, environmental, and climate-related benefits that, if quantified and monetized, would increase the total monetized benefits.

<sup>b</sup> Benefits calculated as value of avoided: PM<sub>2.5</sub>—attributable deaths (quantified using a concentration-response relationship from the Di et al. 2017 study); Ozone-attributable deaths (quantified using a concentration-response relationship from the Turner et al. 2016 study); and PM<sub>2.5</sub> and ozone-related morbidity effects.

<sup>c</sup> Year in which PM<sub>2.5</sub> and ozone air quality for Option 1 was simulated (2045).

This analysis includes many data sources as inputs that are each subject to uncertainty. Input parameters include projected emission inventories, air quality data from models (with their associated parameters and inputs), population data, population estimates, health effect estimates from epidemiology studies, economic data, and assumptions regarding the future state of the world (*i.e.*, regulations, technology, and human behavior). When compounded, even small uncertainties can greatly influence the size of the total quantified benefits. Please refer to draft RIA Chapter 8 for more information on the uncertainty

associated with the benefits presented here.

**IX. Comparison of Benefits and Costs**

This section compares the estimated range of total monetized health benefits to total costs associated with proposed Options 1 and 2 of the criteria pollutant program. This section also presents the range of monetized net benefits (benefits minus costs) associated with the same options. Criteria pollutant program costs are detailed and presented in Section V of this preamble. Those costs include costs for both the new technology and the operating costs associated with that new technology, as well as costs

associated with the proposed warranty and useful life provisions for Options 1 and 2. Criteria pollutant program benefits are presented in Section VIII. Those benefits are the monetized economic value of the reduction in PM<sub>2.5</sub>- and ozone-related premature deaths and illnesses that result from reductions in NO<sub>x</sub> emissions and directly emitted PM<sub>2.5</sub> attributable to implementation of the proposed options.

As noted in Sections IV through VIII, these estimated benefits, costs, and net benefits do not reflect all of the anticipated impacts of the proposed

revisions to the criteria pollutant program.<sup>781</sup>

A. Methods

EPA presents three different benefit-cost comparisons for proposed Options 1 and 2:<sup>782</sup>

1. A future-year snapshot comparison of annual benefits and costs in the year 2045, chosen to approximate the annual health benefits that would occur in a year when the program would be fully implemented and when most of the regulated fleet would have turned over. Benefits, costs and net benefits are presented in year 2017 dollars and are not discounted. However, 3 percent and 7 percent discount rates were applied in the valuation of avoided premature deaths from long-term pollution

exposure to account for a twenty-year segmented cessation lag.

2. The present value (PV) of the stream of benefits, costs and net benefits calculated for the years 2027–2045, discounted back to the first year of implementation of the proposed rule (2027) using both a 3 percent and 7 percent discount rate, and presented in year 2017 dollars. Note that year-over-year costs are presented in Section V and year-over-year benefits can be found in Section VIII.

3. The equivalent annualized value (EAV) of benefits, costs and net benefits representing a flow of constant annual values that, had they occurred in each year from 2027 to 2045, would yield an equivalent present value to those estimated in method 2 (using either a 3

percent or 7 percent discount rate). Each EAV represents a typical benefit, cost or net benefit for each year of the analysis and is presented in year 2017 dollars.

The two estimates of monetized benefits (and net benefits) in each of these benefit-cost comparisons reflect alternative combinations of the economic value of PM<sub>2.5</sub>- and ozone-related premature deaths summed with the economic value of illnesses for each discount rate (see draft RIA Chapter 8 for more detail).

B. Results

Table IX–1 presents the benefits, costs and net benefits of proposed Options 1 and 2 in annual terms for year 2045, in PV terms, and in EAV terms.

TABLE IX–1—ANNUAL VALUE, PRESENT VALUE AND EQUIVALENT ANNUALIZED VALUE OF COSTS, BENEFITS AND NET BENEFITS OF THE PROPOSED OPTION 1 AND OPTION 2

[Billions, 2017\$]<sup>a b</sup>

	Proposed Option 1		Proposed Option 2	
	3% Discount	7% Discount	3% Discount	7% Discount
2045:				
Benefits .....	\$12–\$33	\$10–\$30	\$9.1–\$26	\$8.2–\$23
Costs .....	\$2.3	\$2.3	\$2.9	\$2.9
Net Benefits .....	\$9.2–\$31	\$8.1–\$28	\$6.2–\$23	\$5.3–\$21
Present Value:				
Benefits .....	\$88–\$250	\$52–\$150	\$71–\$200	\$41–\$120
Costs .....	\$27	\$19	\$30	\$21
Net Benefits .....	\$61–\$220	\$33–\$130	\$41–\$170	\$21–\$96
Equivalent Annualized Value:				
Benefits .....	\$6.0–\$17	\$4.7–\$13	\$5.0–\$14	\$4.0–\$11
Costs .....	\$1.9	\$1.9	\$2.1	\$2.0
Net Benefits .....	\$4.1–\$15	\$2.9–\$12	\$2.9–\$12	\$2.0–\$9.3

<sup>a</sup> All benefits estimates are rounded to two significant figures; numbers may not sum due to independent rounding. The range of benefits (and net benefits) in this table are two separate estimates and do not represent lower- and upper-bound estimates, though they do reflect a grouping of estimates that yield more and less conservative benefits totals. The costs and benefits in 2045 are presented in annual terms and are not discounted. However, all benefits in the table reflect a 3 percent and 7 percent discount rate used to account for cessation lag in the valuation of avoided premature deaths associated with long-term exposure.

<sup>b</sup> The benefits associated with the standards presented here do not include the full complement of health, environmental, and climate-related benefits that, if quantified and monetized, would increase the total monetized benefits.

Annual benefits of proposed Option 1 are larger than the annual costs in 2045, with annual net benefits of \$8.1 and \$28 billion using a 7 percent discount rate, and \$9.2 and \$31 billion using a 3 percent discount rate.<sup>783</sup> Benefits also outweigh the costs when expressed in PV terms (net benefits of \$33 and \$130 billion using a 7 percent discount rate, and \$61 and \$220 billion using a 3

percent discount rate) and EAV terms (net benefits of \$2.9 and \$12 billion using a 7 percent discount rate, and \$4.1 and \$15 billion using a 3 percent discount rate).<sup>784</sup>

The benefits also outweigh the costs in annual 2045 terms when looking at proposed Option 2, with annual net benefits of \$5.3 and \$21 billion using a 7 percent discount rate and \$6.2 billion

and \$23 billion using a 3 percent discount rate. The benefits of proposed Option 2 also outweigh the costs in PV and EAV terms.

Comparing proposed Options 1 and 2, our analysis shows that Option 2 has lower net benefits than Option 1 due to both higher costs and lower emission reductions relative to Option 1. As outlined in Section I.G and detailed in

<sup>781</sup> As noted in draft RIA Chapter 5.4, there are differences between the standards, emission warranty, and useful life provisions of proposed Option 1 presented in Sections III and IV and those included in our control case scenario modeled for the air quality analysis (as noted in Section VII, due to resource constraints we only conducted air quality modeling for the proposed Option 1). As detailed in draft RIA Chapter 8, estimates of health benefits are based on our air quality analysis, and thus differences between proposed Option 1 and modeling are not reflected in the benefits analysis.

<sup>782</sup> We are not including an analysis of costs or benefits of the Alternative (described in Sections III and IV) because we currently do not have sufficient information to conclude that the Alternative standards would be feasible in the MY 2027 timeframe (see Section III for details).

<sup>783</sup> The range of benefits and net benefits presented in this section reflect a combination of assumed PM<sub>2.5</sub> and ozone mortality risk estimates and selected discount rate.

<sup>784</sup> As noted in Chapter 5.4 of the draft RIA, there are differences between the proposed Option 1

standards, emission warranty, and useful life provisions presented in Sections III and IV of this preamble and those included in the control scenario modeled for the air quality analysis. In contrast, our cost analysis includes the proposed Option 1 standards, emission warranty, and useful life provisions presented in Sections III and IV. As such, our comparisons of benefits and costs of the proposed options may underestimate the true benefits of each option.



Sections III and IV, we have considered several other factors, including lead time and technological feasibility, in developing these options and considering possible regulatory options.

Given these results, EPA expects that implementation of either proposed option would provide society with a substantial net gain in welfare, notwithstanding the health and other benefits we were unable to quantify (see draft RIA Chapter 8.8 for more information about unquantified benefits). EPA does not expect the omission of unquantified benefits to impact the Agency's evaluation of regulatory options since unquantified benefits generally scale with the emissions impacts of the proposed options.

#### X. Economic Impact Analysis

This section describes our Economic Impact Analysis for the proposed rule. Our analysis focuses on the potential impacts of the proposed standards on heavy-duty (HD) vehicles (sales, mode shift, fleet turnover) and employment in the HD industry. The sub-sections below describe our evaluation.

##### A. Impact on Vehicle Sales, Mode Shift, and Fleet Turnover

This proposed rulemaking, if finalized, would require HD engine manufacturers to develop and implement emission control technologies capable of controlling NO<sub>x</sub> at lower levels over longer emission warranty and regulatory useful life periods. These changes in requirements would increase the cost of producing and selling compliant HD vehicles. These increased costs are likely to lead to increases in prices for HD vehicles, which might lead to reductions in truck sales. In addition, there may be a period of "pre-buying" in anticipation of potentially higher prices, during which there is an increase in new vehicle purchases before the implementation of new requirements, followed by a period of "low-buying" directly after implementation, during which new vehicle purchases decrease. EPA acknowledges that the proposed standards may lead to some pre-buy before the implementation date of the standards, and some low-buy after the standards are implemented. EPA is unable to estimate sales impacts based on existing literature, and as such contracted with ERG to complete a literature review, as well as conduct original research to estimate sales impacts for previous EPA HD vehicle standards on pre- and low-buy for HD vehicles. The resulting analysis examines the effect of four HD truck

regulations, those that became effective in 2004, 2007, 2010 and 2014, on the sales of Class 6, 7 and 8 vehicles over the twelve months before and after each standard. The 2004, 2007 and 2010 rules focused on reducing criteria pollutant emissions. The 2014 regulation focused on reducing GHG emissions. The report finds little evidence of sales impacts for Class 6 and 7 vehicles. For Class 8 vehicles, evidence of pre-buy was found before the 2010 and 2014 standards, and evidence of low-buy was found after the 2002, 2007 and 2010 standards. Based on the results of this study, EPA is outlining an approach that could be used to estimate pre- and low-buy effects in the final RIA. In the draft RIA, we explain the methods used to estimate sales effects, as well as how the results could be applied to a regulatory analysis (see the draft RIA, Chapter 10.1, for further discussion). Our example results for proposed Option 1 suggest pre- and low-buy for Class 8 trucks may range from zero to an approximately two percent increase in sales over a period of up to 8 months before the 2031 standards begin (pre-buy), and a decrease in sales from zero to approximately two percent over a period of up to 12 months after the 2031 standards begin (low-buy). We request comment on the approach that is discussed in the draft RIA, as well as the specific inputs and methods. In addition, we request comment on how additional external factors, including the current global COVID-19 pandemic, might impact any pre- or low-buy that may result from this proposed rulemaking. Commenters are encouraged to provide data on how factors such as the pandemic may affect HD vehicle sales, including on any possible pre- and low-buy resulting from this proposed rule, as well as on the length of the possible sales effects.

In addition to potential sales impacts from changes in purchase price, the proposed requirement for longer useful life and emission warranty periods may also affect vehicle sales. While longer emission warranty periods are likely to increase the purchase price of new HD vehicles, these increases may be offset by reduced operating costs. This is because longer useful life periods are expected to make emission control technology components more durable, and more durable components, combined with manufacturers paying for repairs during the proposed longer warranty periods, would in turn reduce repair costs for vehicle owners. These combined effects may increase (or reduce the decrease in) sales of new HD vehicles if fleets and independent

owner-operators prefer to purchase more durable vehicles with overall lower repair costs.<sup>785</sup> EPA is unable to quantify these effects because existing literature does not provide clear guidance on the relationship between warranty changes, increases in prices due to increased warranty periods, and sales impacts. EPA continues to investigate methods for estimating sales impacts of extended warranty provisions, and requests comment on data and methods to use in such analysis. See the draft RIA, Chapter 10.1.1, for more information.

In addition to potential sales impacts, another potential effect of the proposed standards is transportation mode shift, which is a change from truck to another mode of transportation (typically rail or marine). Whether shippers switch to a different transportation mode for freight depends not only on the cost per mile of the shipment (freight rate), but also the value of the shipment, the time needed for shipment, and the availability of supporting infrastructure. This proposed rule is not expected to have a large impact on truck freight rates given that the price of the truck is only a small part of the cost per mile of a ton of goods. For that reason, we expect little mode shift due to the proposed standards. The draft RIA, Chapter 10.1.3, discusses this issue.

Another potential area of impact of the proposed standards is on fleet turnover and the associated reduction in emissions from new vehicles. After the implementation of the proposed standards, each individual new vehicle sold would produce lower emissions per mile relative to legacy vehicles. However, the proposed standards would reduce total HD highway fleet emissions gradually. This is because, initially, the vehicles meeting the proposed standards would be only a small portion of the total fleet; over time, as more vehicles subject to the standards enter the market and older vehicles leave the market, greater emission reductions would occur. If pre-buy and low-buy behaviors occur, then the initial emission reductions are likely to be smaller than expected. This is because, under pre-buy conditions, the pre-bought vehicles would be certified to less stringent standards and their emission reductions would be smaller than would be realized if those vehicles were subject to the proposed standards. However, the new vehicles are likely less polluting than the older vehicles

<sup>785</sup> The reduced repair costs may counteract some of the sales effect of increased vehicle purchase cost. As a result, they may reduce incentives for pre- and low-buy and mitigate adverse sales impacts.

that they are most likely to displace, and there may be an earlier reduction in emissions than would have occurred without the standards since the vehicles are being purchased ahead of the implementation of new standards, rather than at a natural point in the purchase cycle. Under low-buy, emission reductions would be slower because there is slower adoption of new vehicles than without the standards. See the draft RIA, Chapter 10.1.2, for more information on this, as well as the vehicle miles traveled (VMT) discussion below.

An additional possible effect of the standards is a net reduction in new vehicle sales if there is either a smaller pre-buy than the post-standards low-buy, or some potential buyers decide not to purchase at all. In this case, the VMT of older vehicles may increase to compensate for the “missing” vehicles. To the extent that the older vehicles emit more than the vehicles for which they are substituting, emissions may increase. However, the VMT is more likely to be shifted to the newer HD vehicles among the existing fleet. Because most of those vehicles are expected to be in compliance with the previous tiers of HD vehicle standards, the emission effect of increased VMT for older vehicles is expected to be small.

EPA requests comment on all aspects of the estimated impact on vehicle sales, mode shift, and fleet turnover, including the approach outlined in the draft RIA to quantify sales impacts, and requests stakeholder to recommend any additional methods and data that could be used to inform our understanding of potential impacts on HD VMT, fleet turnover, mode shift and vehicles sales.

### B. Employment Impacts

This section discusses potential employment impacts due to this proposed regulation, as well as our partial estimates of those impacts. We focus our analysis on the motor vehicle manufacturing and the motor vehicle parts manufacturing sectors because these sectors are most directly affected.<sup>786</sup> While the proposed rule primarily affects heavy duty vehicle engines, the employment effects are expected to be felt more broadly in the

<sup>786</sup> The employment analysis in the draft RIA is part of the EPA’s ongoing effort to “conduct continuing evaluations of potential loss or shifts of employment which may result from the administration or enforcement of [the Act]” pursuant to CAA section 321(a). Though the rule primarily affects heavy-duty engines, the employment effects will be felt more broadly in the motor vehicle and parts sectors due to the potential effects of the standards on sales.

motor vehicle and parts sectors due to the effects of the standards on sales.

In general, the employment effects of environmental regulation are difficult to disentangle from other economic changes (especially the state of the macroeconomy) and business decisions that affect employment, both over time and across regions and industries. In light of these difficulties, we look to economic theory to provide a constructive framework for approaching these assessments and for better understanding the inherent complexities in such assessments.

Economic theory of labor demand indicates that employers affected by environmental regulation may change their demand for different types of labor in different ways. They may increase their demand for some types, decrease demand for other types, or maintain demand for still other types. To present a complete picture, an employment impact analysis describes both positive and negative changes in employment. A variety of conditions can affect employment impacts of environmental regulation, including baseline labor market conditions, employer and worker characteristics, industry, and region.

In the draft RIA, we describe three ways employment at the firm level might be affected by changes in a firm’s production costs due to environmental regulation: A demand effect, caused by higher production costs increasing market prices and decreasing demand; a cost effect, caused by additional environmental protection costs leading regulated firms to increase their use of inputs; and a factor-shift effect, in which post-regulation production technologies may have different labor intensities than their pre-regulation counterparts.<sup>787 788</sup>

Due to data limitations, EPA is not quantifying the impacts of the proposed regulation on firm-level employment for affected companies, although we acknowledge these potential impacts. Instead, we discuss demand, cost and factor-shift employment effects for the regulated sector at the industry level in the draft RIA. In general, if the proposed regulation causes HD sales to decrease, fewer people would be needed to

<sup>787</sup> Morgenstern, Richard D., William A. Pizer, and Jhih-Shyang Shih (2002). “Jobs Versus the Environment: An Industry-Level Perspective.” *Journal of Environmental Economics and Management* 43: 412–436.

<sup>788</sup> Berman and Bui have a similar framework in which they consider output and substitution effects that are similar to Morgenstern et al.’s three effect (Berman, E. and L.T.M. Bui (2001). “Environmental Regulation and Labor Demand: Evidence from the South Coast Air Basin.” *Journal of Public Economics* 79(2): 265–295).

assemble trucks and to manufacture their components. If pre-buy occurs, HD vehicle sales may increase temporarily in advance of the standards, leading to temporary increases in employment, but if low-buy occurs following the standards, there could be temporary decreases in employment. Though we have outlined a method to quantify sales impacts, we are not using them to estimate effects on fleet turnover in this proposed rulemaking. As such, we cannot determine which of these effects would dominate and therefore we do not estimate the demand-effect impact on employment due to the proposed standards. In addition, we do not have information on changes in labor intensity of production due to the standards, and therefore we cannot estimate the factor-shift effect on employment.

We do estimate partial employment impacts, namely labor effects associated with increased costs of production. This cost effect includes the impact on employment due to the increase in production costs needed for vehicles to meet the standards. (Note that this analysis is separate from any employment effect due to changes in vehicle sales; in other words, the analysis holds output constant.) In the draft RIA, we capture these effects using the historic share of labor as a part of the cost of production to extrapolate future estimates of the share of labor as a cost of production. This provides a sense of the order of magnitude of expected impacts on employment.

These estimates are averages, covering all the activities in these sectors. The estimates may not be representative of the labor effects when expenditures are required on specific activities, or when manufacturing processes change sufficiently that labor intensity changes. In addition, these estimates do not include changes in industries that supply these sectors, such as steel or electronics producers, or in other potentially indirectly affected sectors (such as shipping). Other sectors that sell, purchase, or service HD vehicles may also face employment impacts due to the proposed standards. The effects on these sectors would depend on the degree to which compliance costs are passed through to prices for HD vehicles and the effects of warranty requirements on demand for vehicle repair and maintenance. EPA does not have data to estimate the full range of possible employment impacts. For more information on how we estimate the employment impacts due to increased costs, see Chapter 10 of the draft RIA.

Table X–1 shows the estimated employment effects due to increases in

vehicle costs based on the ratio of labor to production costs derived from historic data for proposed Option 1 and proposed Option 2. We only quantitatively estimate employment impacts due to cost effects. In this proposed rule, we provide estimates of sales impacts as part of an example approach for commenters to consider,

therefore we do not estimate potential changes in employment due to changes in vehicle sales. Results are shown in job-years, where a job-year is, for example, one year of full-time work for one person, or one year of half-time work for two people. Increased costs of vehicles and parts would, by itself and holding labor intensity constant, be

expected to increase employment by 400 to 2,200 job years, and 300 to 1,800 job years in 2027 and 2032 respectively under proposed Option 1. Employment would be expected to increase by 400 to 2,200 job years, and 300 to 1,500 job years in 2027 and 2032 respectively under proposed Option 2.

TABLE X-1—EMPLOYMENT EFFECTS DUE TO INCREASED COSTS OF VEHICLES AND PARTS (COST EFFECT), IN JOB-YEARS<sup>a</sup>

Year	Proposed Option 1		Proposed Option 2	
	Minimum employment due to cost effect <sup>b</sup>	Maximum employment due to cost effect <sup>c</sup>	Minimum employment due to cost effect <sup>b</sup>	Maximum employment due to cost effect <sup>c</sup>
2027	400	2,200	400	2,200
2028	400	2,100	400	2,000
2029	400	2,000	400	1,900
2030	300	1,800	300	1,700
2031	400	1,900	300	1,600
2032	300	1,800	300	1,500

<sup>a</sup> Due to the data limitations, results do not reflect employment effects that result from changes in heavy-duty vehicle sales.

<sup>b</sup> Minimum employment impacts under both proposed Options are estimated in ASM for NAICS code 336112, Light Truck and Utility Vehicle Manufacturing.

<sup>c</sup> Maximum employment impacts under both proposed Options are estimated in EC for NAICS code 3363, Motor Vehicle Parts Manufacturing.

While we estimate employment impacts, measured in job-years, beginning with program implementation, some of these employment gains may occur earlier as vehicle manufacturers and parts suppliers hire staff in anticipation of compliance with the standards. Additionally, holding all other factors constant, demand-effect employment may increase prior to MY 2027 due to pre-buy, and may decrease, potentially temporarily, afterwards.<sup>789</sup> We present a range of possible results because our analysis consists of data from multiple industrial sectors that we expect would be directly affected by the proposed regulation, as well as data from multiple sources. For more information on the data we use to estimate the cost effect, see Chapter 10.2 of the draft RIA.

**XI. Targeted Updates to the Phase 2 Heavy-Duty Greenhouse Gas Emissions Program**

The transportation sector is the largest U.S. source of GHG emissions, representing 29 percent of total GHG emissions.<sup>790</sup> Within the transportation

sector, heavy-duty vehicles are the second largest contributor, at 23 percent.<sup>791</sup> GHG emissions have significant impacts on public health and welfare as evidenced by the well-documented scientific record and as set forth in EPA’s Endangerment and Cause or Contribute Findings under CAA section 202(a).<sup>792</sup> Therefore, continued emission reductions in the heavy-duty vehicle sector are appropriate.

We are at the early stages of a significant transition in the history of the heavy-duty on-highway sector—a shift to zero-emission vehicle technologies. This change is underway and presents an opportunity for significant reductions in heavy-duty vehicle emissions. Major trucking fleets, manufacturers and U.S. states have announced plans to shift the heavy-duty fleet toward zero-emissions technology, and over just the past few years we have seen the early introduction of zero-emission technology into a number of heavy-duty vehicle market segments. These developments have demonstrated that further CO<sub>2</sub> reductions in the MY 2027 timeframe are appropriate considering cost, lead time, and other factors. This proposed action would adjust the existing HD GHG Phase 2 program to account for the growth in the market.

Proposed adjustments to the existing HD GHG Phase 2 program are responsive to Executive Order 14037 on Strengthening American Leadership in Clean Cars and Trucks, which identifies three potential regulatory actions for the heavy-duty vehicle sector for EPA to consider undertaking: (1) This proposed rule for heavy-duty vehicles for new criteria pollutant standards and strengthening of the MY 2027 GHG standards; (2) a separate rulemaking to establish more stringent criteria and GHG emission standards for medium-duty vehicles for MY 2027 and later (in combination with light-duty vehicles); and (3) a third rulemaking to establish new GHG standards for heavy-duty vehicles for MY 2030 and later.<sup>793</sup> The first step includes considering targeted revisions to the already stringent HD GHG Phase 2 emission standards for heavy-duty vehicles beginning with MY 2027 in consideration of the role that heavy-duty zero-emission vehicles (HD ZEVs) might have in further reducing emissions from certain market segments. As part of this proposal, we are proposing to increase the stringency of the existing CO<sub>2</sub> emission standards for MY 2027 and later vehicles for many of the vocational vehicle and tractor subcategories, specifically those where we project early introductions of zero-emission vehicles. The proposed

<sup>789</sup> Note that the standards are not expected to provide incentives for manufacturers to shift employment between domestic and foreign production. This is because the proposed standards would apply to vehicles sold in the U.S. regardless of where they are produced.

<sup>790</sup> Inventory of U.S. Greenhouse Gas Emissions and Sinks: 1990–2019 (EPA-430-R-21-005, published April 2021). Can be accessed at <https://www.epa.gov/ghgemissions/inventory-us-greenhouse-gas-emissions-and-sinks>.

<sup>791</sup> Ibid.

<sup>792</sup> 74 FR 66496, December 15, 2009; 81 FR 54422, August 15, 2016.

<sup>793</sup> 86 FR 43583, August 5, 2021. Executive Order 14037. Strengthening American Leadership in Clean Cars and Trucks.

increase in stringency is appropriate considering lead time, costs, and other factors, including the market shifts to zero-emission technologies in certain segments of the heavy-duty vehicle sector that are occurring since the HD GHG Phase 2 rule was promulgated in 2016. In addition, we are requesting comment on potential changes to the advanced technology incentive program for electric vehicles beginning in MY 2024. The proposed increased stringency is intended to balance further incentivizing zero and near-zero emission vehicle development with ensuring that the standards achieve an appropriate fleet-wide level of CO<sub>2</sub> emissions reductions. The proposed changes to the CO<sub>2</sub> standards are targeted and apply only to certain MY 2027 standards; the HD GHG Phase 2 program overall remains largely unchanged.

As discussed in the Executive Summary, a number of stakeholders have urged EPA to put in place policies that rapidly advance ZEVs in this current rulemaking in order to prioritize environmental justice in communities that are impacted by freight transportation and already overburdened by pollution.<sup>794</sup> One policy stakeholders have asked EPA to consider is the establishment of a ZEV sales mandate (*i.e.*, a nationwide requirement for manufacturers to produce a portion of their new vehicle fleet as ZEVs), which would culminate in standards requiring 100 percent of all new heavy-duty vehicles be zero-emission no later than 2035. In this current rulemaking EPA is not proposing to establish a heavy-duty ZEV sales mandate; rather, in this rulemaking we are considering how the development and deployment of ZEVs can further the goals of environmental protection and best be reflected in the establishment of EPA's standards and regulatory program for MY 2027 and later heavy-duty vehicles. As discussed earlier in this section EPA will also be considering the important role of ZEV technologies in the upcoming light-duty and medium-duty vehicle proposal for MY 2027 and later and in the heavy-duty vehicle proposal for MY 2030 and later. EPA requests comment under this proposal on how we can best consider the potential for ZEV technology to significantly reduce air pollution from the heavy-duty vehicle sector (including but not limited to whether and how to

consider including specific sales requirements for HD ZEVs).

In Sections XI.A through XI.F, we provide background on the existing EPA heavy-duty GHG standards and the details of our proposed updates to the Model Year 2027 GHG standards. EPA requests comment on all aspects of these proposed updates.

#### A. Background on Heavy-Duty Greenhouse Gas Emission Standards

EPA sets HD GHG emission standards under its authority in CAA section 202(a). Section 202(a)(1) states that “the Administrator shall by regulation prescribe (and from time to time revise) . . . standards applicable to the emission of any air pollutant from any class or classes of new motor vehicles or new motor vehicle engines . . . , which in his judgment cause, or contribute to, air pollution which may reasonably be anticipated to endanger public health or welfare.” Section 202(a)(2) provides that standards under section 202(a) apply to such vehicles and engines “after such period as the Administrator finds necessary to permit the development and application of the requisite technology, giving appropriate consideration to the cost of compliance within such period” and “for their useful life.” EPA also may consider other factors and in previous heavy-duty vehicle GHG standards rulemakings has considered the impacts of potential GHG standards on the industry, fuel savings, oil conservation, energy security and other energy impacts, as well as other relevant considerations such as safety.

EPA finalized the Heavy-Duty Greenhouse Gas Emissions Phase 2 program in 2016.<sup>795</sup> This comprehensive program included GHG emission standards tailored to highway heavy-duty engines and each of four regulatory vehicle categories, including tractors and vocational vehicles. In Phase 2, EPA set CO<sub>2</sub> emission standards, in addition to other GHG emission standards, for HD engines and vehicles that phase in starting in MY 2021 through MY 2027. The HD GHG Phase 2 standards built upon the Phase 1 program promulgated in 2011, which established the first set of GHG emission standards for heavy-duty engines and trucks.<sup>796</sup>

<sup>795</sup> *Id.* The U.S. Department of Transportation through the National Highway Traffic Safety Administration (NHTSA) also established coordinated Phase 2 fuel efficiency standards in this same action as part of a joint EPA—NHTSA final rulemaking.

<sup>796</sup> 76 FR 57106 (September 15, 2011).

#### 1. Background on the CO<sub>2</sub> Emission Standards in the HD GHG Phase 2 Program

In the Phase 1 and Phase 2 Heavy-Duty GHG rules, we finalized GHG emission standards tailored for each of the three regulatory categories—heavy-duty pickups and vans; vocational vehicles, and combination tractors. In addition, we set separate standards for the engines that power combination tractors and vocational vehicles. The heavy-duty vehicle CO<sub>2</sub> emission standards are measured in grams per ton-mile, which represents the grams of CO<sub>2</sub> emitted to move one ton of payload one mile. In this section we provide background information on the two Phase 2 program categories for which we are proposing to make targeted changes: vocational vehicles and tractors.

##### i. Vocational Vehicles

Class 2b–8 vocational vehicles include a wide variety of vehicle types and serve a wide range of functions. We define Class 2b–8 vocational vehicles as all heavy-duty vehicles that are not included in the Heavy-duty Pickup Truck and Van or the Class 7 and 8 Tractor categories. Some examples include service for urban delivery, refuse hauling, utility service, dump, concrete mixing, transit service, shuttle service, school bus, emergency, motor homes, and tow trucks. The HD GHG Phase 2 program also includes a special regulatory category called vocational tractors, which covers vehicles that are technically tractors but generally operate more like vocational vehicles than line-haul tractors. These vocational tractors include those designed to operate off-road and in certain intra-city delivery routes.<sup>797</sup>

The HD GHG Phase 2 vocational vehicle CO<sub>2</sub> standards are based on the performance of a wide array of control technologies. In particular, the Phase 2 vocational vehicle standards recognize detailed characteristics of vehicle powertrains and drivelines. Driveline improvements present a significant opportunity for reducing fuel consumption and CO<sub>2</sub> emissions from vocational vehicles. However, there is no single package of driveline technologies that will be equally suitable for all vocational vehicles, because there is an extremely broad range of driveline configurations available in the market. This is due in part to the variety of final vehicle build configurations, ranging from a purpose-built custom chassis to a commercial

<sup>794</sup> Letter to EPA Administrator Michael Regan from the Moving Forward Network. October 26, 2021.

<sup>797</sup> 40 CFR 1037.630.

chassis that may be intended as a multi-purpose stock vehicle. Furthermore, the wide range of applications and driving patterns of these vehicles leads manufacturers to offer a variety of drivelines, as each performs differently in use.

The final HD GHG Phase 2 rule has a structure for vocational standards that allows the technologies that perform best at highway speeds and those that perform best in urban driving to each be properly recognized over appropriate drive cycles, while avoiding potential unintended results of forcing vocational vehicles that are designed to serve in different applications to be measured against a single drive cycle. The final HD GHG Phase 2 rule includes three drive cycles with the intent of balancing the competing pressures to recognize the varying performance of technologies, serve the wide range of customer needs, and maintain reasonable regulatory simplicity. The HD GHG Phase 2 primary vocational standards therefore have subcategories for Regional, Multi-purpose, and Urban drive cycles in each of the three weight classes (Light Heavy-Duty, Medium Heavy-Duty and Heavy-Heavy Duty), which results in nine unique subcategories. These nine subcategories apply for diesel (CI) vehicles. We separately, but similarly, established six subcategories of gasoline (SI) vehicles. In other words, there are 15 separate numerical performance-based emission standards for each model year. In addition, we established optional custom chassis CO<sub>2</sub> emission standards for Motorhomes, Refuse Haulers, Coach Buses, School Buses, Transit Buses, Concrete Mixers, Mixed Use Vehicles, and Emergency Vehicles. In total, EPA set CO<sub>2</sub> emission standards for 15 subcategories of vocational vehicles and eight subcategories of specialty vehicle types for a total of 23 vocational vehicle subcategories.

The HD GHG Phase 2 standards phase in over a period of seven years, beginning in the 2021 model year. The HD GHG Phase 2 program progresses in three-year stages with an intermediate set of standards in MY 2024 and final standards in MY 2027 and beyond. In the 2016 final rule we identified a potential technology path for complying with each of the three increasingly stringent stages of the HD GHG Phase 2 program standards. These standards were based on the performance of more efficient engines, workday idle reduction technologies, improved transmissions including mild hybrid powertrains, axle technologies, weight reduction, electrified accessories, tire pressure systems, and tire rolling

resistance improvements. The Phase 2 vocational vehicle CO<sub>2</sub> standards were not premised on electric vehicles or fuel cell vehicles. Details regarding the standards can be found in the Phase 2 final rulemaking preamble and in 40 CFR part 1037.<sup>798</sup>

ii. Tractors

EPA promulgated HD GHG Phase 2 CO<sub>2</sub> emission standards for combination tractors that reflect reductions that can be achieved through improvements in the tractor’s powertrain, aerodynamics, tires, idle reduction, and other vehicle systems. EPA did not premise the HD Phase 2 tractor standards on hybrid powertrains, fuel cells, or electric vehicles, though we foresaw some limited use of these technologies in 2021 and beyond.<sup>799</sup> In the HD GHG Phase 2 final rule, EPA analyzed the feasibility of achieving the CO<sub>2</sub> standards and identified means of achieving these standards.<sup>800</sup> The tractor regulatory structure is attribute-based in terms of dividing the tractor category into ten subcategories based on the tractor’s gross vehicle weight rating (GVWR), cab configuration, and roof height. The tractor cab configuration is either day cab or sleeper cab. Day cab tractors are typically used for shorter haul operations, whereas sleeper cabs are often used in long haul operations. EPA set CO<sub>2</sub> emission standards for 10 tractor subcategories. Similar to the vocational program, the HD GHG Phase 2 tractor standards begin implementation in MY 2021 and fully phase-in in MY 2027. More details can be found in the HD GHG Phase 2 final rulemaking preamble and in 40 CFR part 1037.<sup>801</sup>

2. Background on the Advanced Technology Credit Multipliers in the HD GHG Phase 1 and 2 Program

EPA provided advanced technology credits in HD GHG Phase 1 for hybrid powertrains, Rankine cycle waste heat recovery systems on engines, all-electric vehicles, and fuel cell vehicles to promote the implementation of advanced technologies that were not included in our technical basis of the feasibility of the Phase 1 standards (see 40 CFR 86.1819–14(k)(7), 1036.150(h), and 1037.150(p)). The HD GHG Phase 2 CO<sub>2</sub> emission standards that followed Phase 1 were premised on the use of mild hybrid powertrains in vocational vehicles and waste heat recovery systems in a subset of the engines and

tractors, making them equivalent to other fuel-saving technologies in this context. At the time of the HD GHG Phase 2 final rule, we believed the HD GHG Phase 2 standards themselves provided sufficient incentive to develop those specific technologies. However, none of the HD GHG Phase 2 standards were based on projected utilization of the other even more-advanced Phase 1 advanced credit technologies (e.g., plug-in hybrid vehicles, all-electric vehicles, and fuel cell vehicles). Overall, the comments on the HD GHG Phase 2 proposal in 2016 indicated that there was support for such advanced technology credit incentives among operators, suppliers, and states. For HD GHG Phase 2, EPA promulgated the following advanced credit multipliers through MY 2027, as shown in Table XI–1 (see also 40 CFR 1037.150(p)).

TABLE XI–1—ADVANCED TECHNOLOGY MULTIPLIERS IN EXISTING HD GHG PHASE 2

Technology	Multiplier
Plug-in hybrid electric vehicles .....	3.5
All-electric vehicles .....	4.5
Fuel cell vehicles .....	5.5

As stated in the HD GHG Phase 2 rulemaking, our intention with these multipliers was to create a meaningful incentive to those considering adopting these qualifying advanced technologies into their vehicles. The multipliers are consistent with values recommended by California Air Resources Board (CARB) in their supplemental HD GHG Phase 2 comments.<sup>802</sup> CARB’s values were based on a cost analysis that compared the costs of these technologies to costs of other conventional GHG-reducing technologies. Their cost analysis showed that multipliers in the range we ultimately promulgated would make these technologies more competitive with the conventional technologies and could allow manufacturers to more easily generate a viable business case to develop these technologies for heavy-duty vehicles and bring them to market at a competitive price.

In establishing the multipliers in the final HD GHG Phase 2 rule, we also considered the tendency of the heavy-duty sector to lag the light-duty sector in the adoption of a number of advanced technologies. There are many possible reasons for this, such as:

- Heavy-duty vehicles are more expensive than light-duty vehicles,

<sup>798</sup> 81 FR 73682–73729 (October 25, 2016).

<sup>799</sup> 81 FR 73639 (October 25, 2016).

<sup>800</sup> 81 FR 73573–73639 (October 25, 2016).

<sup>801</sup> *Id.*

<sup>802</sup> Letter from Michael Carter, CARB, to Gina McCarthy, Administrator, EPA and Mark Rosekind, Administrator, NHTSA, June 16, 2016. EPA Docket ID EPA–HQ–OAR–2014–0827\_attachment 2.

which makes it a greater monetary risk for purchasers to invest in unproven technologies.

- These vehicles are primarily work vehicles, which makes predictable reliability and versatility important.
- Sales volumes are much lower for heavy-duty vehicles, especially for specialized vehicles.

At the time of the HD GHG Phase 2 rulemaking, we concluded that as a result of factors such as these, and the fact that adoption rates for these advanced technologies in heavy-duty vehicles were essentially non-existent in 2016, it seemed unlikely that market adoption would grow significantly within the next decade without additional incentives.

As we stated in the 2016 HD GHG Phase 2 final rule preamble, we determined that it was appropriate to provide such large multipliers for these advanced technologies at least in the short term, because they have the potential to provide very large reductions in GHG emissions and fuel consumption and advance technology development substantially in the long term. However, because the credit multipliers are so large, we also stated that we should not necessarily allow them to continue indefinitely. Therefore, they were included in the HD GHG Phase 2 final rule as an interim program continuing only through MY 2027.

#### *B. What has changed since we finalized the HD GHG Phase 2 rule?*

When the HD GHG Phase 2 rule was promulgated in 2016, we established CO<sub>2</sub> standards and advanced technology incentives on the premise that electrification of the heavy-duty market was unlikely to occur in the timeframe of the program. Several factors have changed our outlook for heavy-duty electric vehicles since 2016. First, the heavy-duty market has evolved such that in 2021, there are a number of manufacturers producing fully electric heavy-duty vehicles in several applications. Second, the State of California has adopted an Advanced Clean Trucks (ACT) program that includes a manufacturer sales requirement for zero-emission truck sales, specifically that “manufacturers who certify Class 2b–8 chassis or complete vehicles with combustion engines would be required to sell zero-emission trucks as an increasing percentage of their annual California sales from 2024 to 2035.”<sup>803 804</sup> Finally,

other states have signed a Memorandum of Understanding establishing goals to increase the heavy-duty electric vehicle market.<sup>805</sup> These developments have demonstrated that further CO<sub>2</sub> emission reductions in the MY 2027 timeframe are feasible considering cost, lead time, and other factors. We discuss the impacts of these factors on the heavy-duty market in more detail in the following subsections.

#### 1. The HD Battery Electric Vehicle Market

Since 2012, manufacturers have developed a number of prototype and demonstration heavy-duty BEV projects, particularly in the state of California, establishing feasibility and durability of the technology for specific applications used for specific services, as well as building out necessary infrastructure.<sup>806</sup> In 2019, approximately 60 makes and models of BEVs were available for purchase, with additional product lines in prototype or other early development stages.<sup>807 808 809</sup> Current production volumes of BEVs are small, with the North American Council for Freight Efficiency (NACFE) estimating fewer than 100 BEV Class 7/8 trucks in production in the U.S. in 2019.<sup>810</sup> In 2020, approximately 900 heavy-duty

BEVs were sold in the U.S. and Canada combined, consisting primarily of transit buses (54 percent), school buses (33 percent), and straight trucks (13 percent).<sup>811</sup> M.J. Bradley’s analysis of the heavy-duty BEV market in 2021 found 30 manufacturers that have at least one BEV model for sale and an additional nine companies that have made announcements to begin BEV production by 2025.<sup>812</sup> BEV technology is increasingly used in the transit bus market, with electric bus sales growing from 300 to 650 in the U.S. between 2018 to 2019.<sup>813 814</sup> Draft RIA Chapter 1.4.2 provides a snapshot of BEVs in the heavy-duty truck and bus markets as of 2019, according to one source; however, given the dynamic nature of the BEV market, the number and types of vehicles available are changing fairly rapidly.<sup>815</sup>

EPA conducted an analysis for this proposal of manufacturer-supplied end-of-year production reports provided to us as a requirement of the certification process for heavy-duty vehicles to our GHG emission standards.<sup>816</sup> Based on the end-of-year production reports for MY 2019, manufacturers produced approximately 350 certified heavy-duty BEVs. This is out of nearly 615,000 heavy-duty diesel vehicles produced in MY 2019, which represents approximately 0.06 percent of the market. In MY 2020, 380 BEVs were certified. The BEVs were certified in a variety of the Phase 1 vehicle subcategories, including light, medium, and heavy heavy-duty vocational vehicles and vocational tractors. Out of the 380 vehicles certified in MY 2020, a total of 177 unique makes and models were available for purchase by 52 producers in regulatory weight classes 3–8.

<sup>804</sup> EPA is reviewing a waiver request under CAA section 209(b) from California for the ACT rule; we may consider including the ACT in some of our analyses for the final rule.

<sup>805</sup> Multi-State Zero Emission Medium and Heavy-Duty Vehicle Initiative—Memorandum of Understanding (2020), available online at: <https://www.nescaum.org/documents/multistate-truck-zev-governors-mou-20200714.pdf>.

<sup>806</sup> NACFE (2019) “Guidance Report: Viable Class 7/8 Electric, Hybrid and Alternative Fuel Tractors”, available online at: <https://nacfe.org/downloads/viable-class-7-8-alternative-vehicles/>.

<sup>807</sup> Nadel, S. and Junga, E. (2020) “Electrifying Trucks: From Delivery Vans to Buses to 18-Wheelers”. American Council for an Energy-Efficient Economy White Paper, available online at: <https://aceee.org/white-paper/electrifying-trucks-delivery-vans-buses-18>.

<sup>808</sup> The composition of all-electric truck models was: 36 buses, 10 vocational trucks, 9 step vans, 3 tractors, 2 street sweepers, and 1 refuse truck (Nadel and Jung (2020) citing AFDC (Alternative Fuels Data Center). 2018. “Average Annual Vehicle Miles Traveled by Major Vehicle Categories.” [www.afdc.energy.gov/data/widgets/10309](http://www.afdc.energy.gov/data/widgets/10309).

<sup>809</sup> Note that there are varying estimates of BEV and FCEV models in the market; NACFE (2019) “Guidance Report: Viable Class 7/8 Electric, Hybrid and Alternative Fuel Tractors”, available online at: <https://nacfe.org/downloads/viable-class-7-8-alternative-vehicles/> (NACFE 2019) provided slightly lower estimates than those included here from Nadel and Jung 2020. A recent NREL study suggests that there may be more models available, but it is unclear how many are no longer on the market since the inventory includes vehicles introduced and used in commerce starting in 2012 (Smith et al. 2019).

<sup>810</sup> NACFE (2019) “Guidance Report: Viable Class 7/8 Electric, Hybrid and Alternative Fuel Tractors”, available online at: <https://nacfe.org/downloads/viable-class-7-8-alternative-vehicles/>.

<sup>811</sup> International Council on Clean Transportation. “Fact Sheet: Zero-Emission Bus and Truck Market in the United States and Canada: A 2020 Update.” Pages 3–4. May 2021.

<sup>812</sup> M.J. Bradley and Associates (2021) “Medium- and Heavy-Duty Vehicles: Market Structure, Environmental Impact, and EV Readiness.” Page 21. July 2021.

<sup>813</sup> Tigue, K. (2019) “U.S. Electric Bus Demand Outpaces Production as Cities Add to Their Fleets” Inside Climate News, November 14. <https://insideclimatenews.org/news/14112019/electric-bus-cost-savings-health-fuel-charging>.

<sup>814</sup> Note that ICCT (2020) estimates 440 electric buses were sold in the U.S. and Canada in 2019, with 10 of those products being FCEV pilots. The difference in estimates of number of electric buses available in the U.S. may lie in different sources looking at production vs. sales of units.

<sup>815</sup> Union of Concerned Scientists (2019) “Ready for Work: Now Is the Time for Heavy-Duty Electric Vehicles”; [www.ucsusa.org/resources/ready-work](http://www.ucsusa.org/resources/ready-work).

<sup>816</sup> Memo to Docket. HD 2027 Proposed Changes to Heavy-Duty Greenhouse Gas Emissions. November 2021.

<sup>803</sup> CARB (2021) Advanced Clean Truck Regulation, available online at: <https://ww2.arb.ca.gov/rulemaking/2019/advancedcleantrucks>.

Based on current trends, manufacturer announcements, and state-level actions, electrification of the heavy-duty market is expected to substantially increase from current levels. However, the rate of growth varies widely across models. For instance, the 2021 Annual Energy Outlook projects heavy-duty BEVs making up 0.12 percent of new truck sales in 2027.<sup>817</sup> A National Renewable Energy Laboratory (NREL) study evaluated three electrification scenarios to assess the power sector requirements where HD electric vehicle sales in 2050 ranged between less than one percent in the Reference scenario and up to 41 percent in the High scenario.<sup>818</sup> Though these projections should not be viewed as a market driven projection, they do illustrate a wide range of future possibilities. A variety of factors will influence the extent to which BEVs are available for purchase and enter the market. NACFE looked at 22 factors by which to compare BEVs with heavy-duty diesel vehicles; they found that for the Class 7/8 market, a current lack of availability of production-level vehicles resulted in BEVs being ranked lower than diesels in 2019, but being ranked equal to or better than diesel on most factors by 2030.<sup>819</sup> Manufacturers also are announcing their projections for zero emission heavy-duty vehicles, but they vary across the industry. For example, Volvo recently issued a press release that stated, “Volvo Trucks believes the time is right for a rapid upswing in electrification of heavy road transport.”<sup>820</sup> Similarly, Daimler Trucks stated that it “has the ambition to offer only new vehicles that are CO<sub>2</sub>-neutral in driving operation (‘from tank to wheel’) in Europe, North America and Japan by 2039.”<sup>821</sup> Cummins targets

<sup>817</sup> U.S. Energy Information Administration. “Annual Energy Outlook 2021.” Table 49. Can be accessed at [https://www.eia.gov/outlooks/aeo/tables\\_ref.php](https://www.eia.gov/outlooks/aeo/tables_ref.php).

<sup>818</sup> Mai, et al. “Electrification Futures Study: Scenarios of Electric Technology Adoption and Power Consumption for the United States.” National Renewable Energy Laboratory. Pages 25–30. <https://www.nrel.gov/docs/fy18osti/71500.pdf>.

<sup>819</sup> Factors that NACFE considered fell into the following categories: Weight, cost, maintenance effort, vehicle life, range, “fuel” availability, and general; for additional information on the factors and how they compare in 2019 and 2030, see NACFE (2019) “Guidance Report: Viable Class 7/8 Electric, Hybrid and Alternative Fuel Tractors”, available online at: <https://nacfe.org/downloads/viable-class-7-8-alternative-vehicles/>.

<sup>820</sup> AB Volvo. “Volvo Trucks ready to electrify a large part of goods transports ([volvogroup.com](http://volvogroup.com)).” April 20, 2021. Last accessed on September 10, 2021 at <https://www.volvogroup.com/en/news-and-media/news/2021/apr/news-3948719.html>.

<sup>821</sup> Daimler Trucks. “CO<sub>2</sub>-Neutral Commercial Vehicle Fleet by 2039.” October 25, 2019. Last accessed on September 10, 2021 at <https://www.daimler.com/sustainability/co2-neutral-commercial-vehicle-fleet-until-2039.html>.

net-zero carbon emissions by 2050.<sup>822</sup> We request comment on these and other estimates and projections for the heavy-duty EV market.

The lifetime total cost of ownership (TCO), which includes maintenance and fuel costs, is likely a primary factor for heavy-duty fleets considering BEV purchases. In fact, a 2018 survey of fleet owners showed “lower cost of ownership” as the second most important motivator for electrifying their fleet.<sup>823</sup> An International Council for Clean Transportation (ICCT) analysis suggests that TCO for light- and medium heavy-duty battery-electric vehicles could reach cost parity with diesel in the early 2020s, while heavy heavy-duty battery-electric or hydrogen vehicles are likely to reach cost parity with diesel closer to the 2030 timeframe.<sup>824</sup> Recent findings from Phadke et al. suggest that BEV TCO could be 13 percent less than that of a diesel truck if electricity pricing is optimized.<sup>825</sup>

As both the ICCT and Phadke et al. studies suggest, fuel costs are an important part of TCO. While assumptions about vehicle weight and size can make direct comparisons between heavy-duty BEVs and ICEs challenging, data show greater energy efficiency of battery-electric technology relative to an ICE.<sup>826</sup><sup>827</sup> Better energy efficiency leads lower electricity costs for BEVs relative to ICE fuel costs.<sup>828</sup><sup>829</sup>

<sup>822</sup> Cummins, Inc. “Cummins Unveils New Environmental Sustainability Strategy to Address Climate Change, Conserve Natural Resources.” November 14, 2019. Last accessed on September 10, 2021 at <https://www.cummins.com/news/releases/2019/11/14/cummins-unveils-new-environmental-sustainability-strategy-address-climate>.

<sup>823</sup> The primary motivator for fleet managers was “Sustainability and environmental goals”; the survey was conducted by UPS and GreenBiz.  
<sup>824</sup> ICCT (2019) “Estimating the infrastructure needs and costs for the launch of zero-emissions trucks”; available online at: <https://theicct.org/publications/zero-emission-truck-infrastructure>.

<sup>825</sup> Phadke, A., et al. (2021) “Why Regional and Long-Haul Trucks are Primed for Electrification Now”; available online at: [https://eta-publications.lbl.gov/sites/default/files/updated\\_5\\_final\\_ehdv\\_report\\_033121.pdf](https://eta-publications.lbl.gov/sites/default/files/updated_5_final_ehdv_report_033121.pdf).

<sup>826</sup> NACFE (2019) “Guidance Report: Viable Class 7/8 Electric, Hybrid and Alternative Fuel Tractors,” available online at: <https://nacfe.org/downloads/viable-class-7-8-alternative-vehicles/>.

<sup>827</sup> Nadel, S. and Junga, E. (2020) “Electrifying Trucks: From Delivery Vans to Buses to 18-Wheelers.” American Council for an Energy-Efficient Economy White Paper, available online at: <https://aceee.org/white-paper/electrifying-trucks-delivery-vans-buses-18>.

<sup>828</sup> NACFE (2019) “Guidance Report: Viable Class 7/8 Electric, Hybrid and Alternative Fuel Tractors”, available online at: <https://nacfe.org/downloads/viable-class-7-8-alternative-vehicles/>.

<sup>829</sup> Nadel, S. and Junga, E. (2020) “Electrifying Trucks: From Delivery Vans to Buses to 18-Wheelers”. American Council for an Energy-Efficient Economy White Paper, available online at: <https://aceee.org/white-paper/electrifying-trucks-delivery-vans-buses-18>.

Maintenance and service costs are also an important component within TCO; although there is limited data available on actual maintenance costs for heavy-duty BEVs, early experience with BEV medium heavy-duty vehicles and transit buses suggests the potential for lower maintenance costs after an initial period of learning to refine both component durability and maintenance procedures.<sup>830</sup> To facilitate heavy-duty fleets transitioning to BEVs, some manufacturers are currently including maintenance in leasing agreements with fleets; it is unclear the extent to which a full service leasing model will persist or will be transitioned to a more traditional purchase after an initial period of learning.<sup>831</sup><sup>832</sup>

The potential for lower fuel and maintenance costs to outweigh a higher upfront cost for heavy-duty BEVs is reflected in ICCT and others’ projections of BEVs reaching cost parity with diesels within the next several years; however, the current upfront cost can exceed that of a diesel vehicle by 60 percent or more.<sup>833</sup> Upfront purchase price was listed as the primary barrier to heavy-duty fleet electrification in a 2017 survey of fleet managers, which suggests that state or local incentive programs to offset BEV purchase costs will play an important role in the near term, with improvements in battery costs playing a role in reducing costs in the longer-term.<sup>834</sup><sup>835</sup>

The BEV market for transit and school buses continues to grow. Los Angeles Department of Transportation (LADOT) is one of the first transit organizations

<sup>830</sup> U.S. Department of Energy Alternative Fuels Data Center (AFDC), “Developing Infrastructure to Charge Plug-In Electric Vehicles”, [https://afdc.energy.gov/fuels/electricity\\_infrastructure.html](https://afdc.energy.gov/fuels/electricity_infrastructure.html) (accessed 2–27–20).

<sup>831</sup> Fisher, J. (2019) “Volvo’s First Electric VNR Ready for the Road.” *Fleet Owner*, September 17. [www.fleetowner.com/blue-fleets/volvo-s-first-electric-vnr-ready-road](http://www.fleetowner.com/blue-fleets/volvo-s-first-electric-vnr-ready-road).

<sup>832</sup> Gnaticov, C. (2018). “Nikola One Hydrogen Electric Semi Hits the Road in Official Film.” *Carscoops*, Jan. 26. [www.carscoops.com/2018/01/nikola-one-hydrogen-electric-semi-hits-road-official-film/](http://www.carscoops.com/2018/01/nikola-one-hydrogen-electric-semi-hits-road-official-film/).

<sup>833</sup> Nadel, S. and Junga, E. (2020) “Electrifying Trucks: From Delivery Vans to Buses to 18-Wheelers.” American Council for an Energy-Efficient Economy White Paper, available online at: <https://aceee.org/white-paper/electrifying-trucks-delivery-vans-buses-18>.

<sup>834</sup> Other barriers that fleet managers prioritized for fleet electrification included: Inadequate charging infrastructure—our facilities, inadequate product availability, inadequate charging infrastructure—public; for the full list of top barriers see Nadel and Junga (2020), citing UPS and GreenBiz 2018.

<sup>835</sup> Nadel, S. and Junga, E. (2020) “Electrifying Trucks: From Delivery Vans to Buses to 18-Wheelers.” American Council for an Energy-Efficient Economy White Paper, available online at: <https://aceee.org/white-paper/electrifying-trucks-delivery-vans-buses-18>.

in the country to develop a program committed to transition to zero-emission vehicles (ZEV). Started in 2017, this program stipulates that all LADOT transit fleets will transition to entirely electric by 2030 or sooner—a target that is 10 years sooner than CARB’s Innovative Clean Transportation (ICT) regulation for all public transit to be electric by 2040.<sup>836</sup> Since these announcements, LADOT has purchased 27 EV transit and school buses from BYD and Proterra; by 2030, the number of EV buses in the LADOT fleet is expected to grow to 492 buses. Outside of California, major metropolitan areas including Chicago, Seattle, New York City, and Washington DC have zero-emissions transit programs with 100 percent ZEV target dates ranging from 2040–2045.<sup>837</sup>

EV school bus programs, frequently in partnership with local utilities, are also being piloted across the country. These programs include school districts in, but not limited to, California, Virginia, Massachusetts, Michigan, Maryland, Illinois, New York, and Pennsylvania.<sup>838</sup> While these school districts may not have an EV school bus target, the EV school bus program is a part of a broader initiative for regional carbon neutrality.

In a parallel path, large private heavy-duty fleet owners are also committed to

increasing their electric fleet.<sup>839</sup> A report by international agency International Energy Agency (IEA) provides a comprehensive accounting of recent announcements made by UPS, Fedex, DHL, Walmart, Anheuser-Busch, Amazon and PepsiCo for fleet electrification.<sup>840</sup> Amazon and UPS, for example, placed orders in 2020 for 10,000 BEV delivery vans from EV start-up Rivian, and Amazon has plans to scale up to 100,000 BEV vans by 2030. Likewise, by the end of 2021, PepsiCo will add 15 Tesla Semis, out of the 100 planned, to its fleet. These announcements include not only orders for electric delivery vans and semi-trucks, but more specific targets and dates to full electrification or net-zero emissions. Amazon, Fedex, DHL, and Walmart have set a commitment to fleet electrification, net-zero emissions or carbon neutrality by 2040. We recognize that certain delivery trucks and vans will likely fall into the Class 2b and 3 regulatory category, which are not covered in this rule’s proposed updates, but rather intend to address in a future light and medium-duty vehicle rulemaking.

In summary, the heavy-duty BEV market seems to be growing fastest in the areas of school buses, transit buses, delivery trucks, and short haul tractors. As the industry is dynamic and rapidly

changing, the policy and vehicle examples presented here represent only a sampling of the BEV HDV policies and markets; outside of the US, Europe and Asia will also contribute to the greater zero-emissions vehicle market. We request comment on our assessment of the HD ZEV market and any additional data sources we should consider.

2. California’s Advanced Clean Trucks Rule

Heavy-duty vehicle sales and populations are significant in the state of California. Approximately ten percent of U.S. heavy-duty conventional vehicles (those powered by internal combustion engines) in 2016 were registered in California.<sup>841</sup> California adopted an Advanced Clean Trucks (ACT) rule in 2020, which could also influence the market trajectory for battery-electric and fuel cell technologies.<sup>842</sup> The ACT requires manufacturers to sell a certain percentage of zero emission heavy-duty vehicles (BEVs or fuel cell vehicles) for each model year, starting in MY 2024. The sales requirements vary by vehicle class, as shown in Table XI–2, starting at 5 to 9 percent of total MY 2024 heavy-duty vehicle sales in California and increasing to 40 to 75 percent of MY 2035 and later sales.<sup>843</sup>

TABLE XI–2—CARB’S ACT ZEV SALES REQUIREMENTS BY MODEL YEAR

Model year (MY)	Class 2b–3 (percent)	Class 4–8 (percent)	Class 7–8 tractors (percent)
2024	5	9	5
2025	7	11	7
2026	10	13	10
2027	15	20	15
2028	20	30	20
2029	25	40	25
2030	30	50	30
2031	35	55	35
2032	40	60	40
2033	45	65	40
2034	50	70	40

<sup>836</sup> LADOT, (2020). “LADOT Transit Zero-Emission Bus Rollout Plan” [https://ww2.arb.ca.gov/sites/default/files/2020-12/LADOT\\_ROP\\_Reso\\_ADA12172020.pdf](https://ww2.arb.ca.gov/sites/default/files/2020-12/LADOT_ROP_Reso_ADA12172020.pdf).

<sup>837</sup> <https://www.sustainable-bus.com/electric-bus/cta-chicago-electric-buses/>, <https://dcist.com/story/21/06/10/metro-goal-entirely-electric-bus-fleet-2045/>, <https://kingcounty.gov/depts/transportation/metro/programs-projects/innovation-technology/zero-emission-fleet.aspx>, and <https://www.amny.com/transit/mta-says-45-to-60-more-buses-in-recent-procurement-will-be-zero-emissions/>.

<sup>838</sup> <https://www.mass.gov/info-details/ev-programs-incentives>, <https://chargedevs.com/newswire/nycs-new-school-bus-contract-includes-electric-bus-pilot/>, <https://olivineinc.com/wp-content/uploads/2020/10/Pittsburg-USD-Electric-School-Bus-Final-Project-Report-Final.pdf>, <https://cleantechnica.com/2020/01/12/largest-electric-school-bus-program-in-united-states-launching-in-virginia/>, <https://www.greentechmedia.com/articles/read/on-heels-of-253m-raise-highland-electric-lands-biggest-electric-school-bus-contract-in-the-u.s.>, and [https://richmond.com/news/state-and-regional/govt-and-politics/va-house-slows-down-bill-that-would-allow-dominion-to-profit-off-electric-school-bus/article\\_edc69a16-5c2c-51c9-9733-8618d768106b.html](https://richmond.com/news/state-and-regional/govt-and-politics/va-house-slows-down-bill-that-would-allow-dominion-to-profit-off-electric-school-bus/article_edc69a16-5c2c-51c9-9733-8618d768106b.html).

<sup>839</sup> Environmental Defense Fund (2021) Zero-Emission Truck Deployments and Pledges in the U.S., available online at: [https://blogs.edf.org/energyexchange/2021/07/28/edf-analysis-finds-american-fleets-are-embracing-electric-trucks/and-https://docs.google.com/spreadsheets/d/1l0m2Do1mjSemrb\\_DT40YNGou4o2m2Ee-KLSvHC-5vAc/edit#gid=2049738669](https://blogs.edf.org/energyexchange/2021/07/28/edf-analysis-finds-american-fleets-are-embracing-electric-trucks/and-https://docs.google.com/spreadsheets/d/1l0m2Do1mjSemrb_DT40YNGou4o2m2Ee-KLSvHC-5vAc/edit#gid=2049738669).

<sup>840</sup> Global EV Outlook 2021. <https://iea.blob.core.windows.net/assets/ed5f4484-f556-4110-8c5c-4ede8bcb637/GlobalEVOutlook2021.pdf>.

<sup>841</sup> FHWA. U.S. Highway Statistics. Available online at: <https://www.fhwa.dot.gov/policyinformation/statistics.cfm>.

<sup>842</sup> CARB. “Notice of Decision: Advanced Clean Truck Regulation.” June 2020. Available online at: <https://ww3.arb.ca.gov/regact/2019/act2019/nod.pdf>. For more information on this proposed rulemaking in California see: <https://ww2.arb.ca.gov/rulemaking/2019/advancedcleantrucks>.

<sup>843</sup> CARB. “Appendix A Proposed Regulation Order” Advanced Clean Truck Regulation. May 2020. Available online at: <https://ww3.arb.ca.gov/regact/2019/act2019/30dayatta.pdf> (accessed July 24, 2020).



TABLE XI-2—CARB’S ACT ZEV SALES REQUIREMENTS BY MODEL YEAR—Continued

Model year (MY)	Class 2b-3 (percent)	Class 4-8 (percent)	Class 7-8 tractors (percent)
2035+ .....	55	75	40

3. States’ Interest in Shifting to Zero Emissions HD Vehicles

Outside of California, several states have signaled interest in shifting to heavy-duty ZEV technologies and/or establishing specific goals to increase the heavy-duty electric vehicle market. As one example, a 2020 memorandum of understanding (MOU) entitled “Multi-State Medium- and Heavy-Duty Zero Emission Vehicle,” organized by Northeast States for Coordinated Air Use Management (NESCAUM), sets targets “to make all sales of new medium and heavy-duty vehicles [in the jurisdictions of the signatory states] zero emission vehicles by no later than 2050” with an interim goal of 30 percent of all sales of new MD and HD vehicles being zero emission vehicles no later than 2030.<sup>844</sup> The NESCAUM MOU was signed by governors and mayor of 15 states and districts including California, Colorado, Connecticut, Hawaii, Maine, Maryland, Massachusetts, New Jersey, New York, North Carolina, Oregon, Pennsylvania, Rhode Island, Vermont, Washington, and the District of Columbia. The MOU outlines more specific commitments of the states to move toward zero-emissions vehicles through the Multi-State ZEV Task Force and provides an action plan for zero-emissions MHDVs with measurable sales targets and a focus on overburdened and underserved communities. Several states that signed the MOU have since issued proposals to adopt California’s ACT under CAA section 177, and we anticipate more states to follow with similar proposals.<sup>845 846 847 848</sup>

<sup>844</sup> 15 states and one district sign Multi-State MOU. <https://www.nescaum.org/documents/multistate-truck-zev-governors-mou-20200714.pdf>.

<sup>845</sup> EPA has not yet received a waiver request under CAA section 209(b) from California for the ACT rule; if we were to receive and grant a waiver request(s) for the ACT rule, then we may consider including this rule in our analyses for the final rule.

<sup>846</sup> Medium- and Heavy-Duty (MHD) Zero Emission Truck Annual Sales Requirements and Large Entity Reporting. New York State Register. September 8, 2021. Volume XLIII, Issue 36. Available online at: <https://dos.ny.gov/system/files/documents/2021/09/090821.pdf>.

<sup>847</sup> Advanced Clean Trucks Program and Fleet Reporting Requirements. New Jersey State Register. April 19, 2021. Available online at: <https://www.nj.gov/dep/rules/proposals/20210419a.pdf>.

<sup>848</sup> Amending Chapter 173-423 WAC Low Emission Vehicles. State of Washington Department

C. Proposed Changes to HD GHG Phase 2 CO<sub>2</sub> Standards for Targeted Subcategories

EPA is proposing under its authority in CAA section 202(a) to revise CO<sub>2</sub> emissions standards for a subset of MY 2027 heavy-duty vehicles. As discussed in Section XI.B, major trucking fleets, manufacturers and U.S. states have announced plans to shift the heavy-duty fleet toward zero-emissions technology beyond levels we accounted for in setting the existing HD GHG Phase 2 standards in 2016. We developed a proposed approach to make targeted updates that reflect this growing HD electric vehicle market without fundamentally changing the HD GHG Phase 2 program. Specifically, we propose to adjust HD GHG Phase 2 vehicle CO<sub>2</sub> emission standards by sales-weighting the projected EV production levels of school buses, transit buses, delivery trucks, and short-haul tractors and by lowering the applicable CO<sub>2</sub> emission standards for these vehicle types in MY 2027 accordingly. We are proposing to target these four vehicle types because they will likely have the highest EV sales of all heavy-duty vehicle types between now and 2030. These four EV vehicle types do not correspond directly with specific HD GHG Phase 2 standards subcategories (subcategories differentiated by vehicle weight, use, fuel type, etc.), so we have used EPA certification data to determine which subcategories of standards would be affected by EV production in MY 2027. By sales-weighting the projected production levels of the four EV vehicle types in 2027, our proposed approach would adjust 17 of the 33 MY 2027 HD GHG Phase 2 vocational vehicle and tractor standards. EPA is not proposing to change any MY 2021 or MY 2024 vocational vehicle or tractor CO<sub>2</sub> emission standards, any Class 2b/3 CO<sub>2</sub> emission standards, or any heavy-duty engine CO<sub>2</sub> emission standards.

To update the MY 2027 vehicle CO<sub>2</sub> standards from the HD GHG Phase 2 rulemaking to reflect the recent and projected trends in the electrification of the HD market, we considered the

of Ecology. June 22, 2021. Available online at: <https://ecology.wa.gov/DOE/files/29/291ec96d-5aca-4c40-a249-4ef82bca6026.pdf>.

impact these trends would have on the emissions reductions from conventional vehicles we had intended to achieve in setting the existing HD GHG Phase 2 standards. As described in this section’s technology cost discussion, we derived the existing HD GHG Phase 2 standards by evaluating combinations of emission-reducing technologies and adoption rates in “technology packages” developed for each vehicle subcategory, e.g., advanced aerodynamics, more efficient engines, etc. We set the existing HD GHG Phase 2 standards at levels that would require all conventional vehicles to install varying combinations of emission-reducing technologies (the degree and types of technology can differ, with some vehicles that have less being offset by others with more), leading to CO<sub>2</sub> emissions reductions.<sup>849</sup> As discussed in this section and quantified in more detail in a memo to the docket, recent and projected developments in the electrification of the heavy-duty vehicle market over the next several years have demonstrated that further CO<sub>2</sub> emission reductions in the MY 2027 timeframe are feasible considering lead time, cost, and other factors.<sup>850</sup> While we did anticipate some growth in electrification, we did not expect the level of innovation observed that California would adopt a requirement for such a large number of heavy-duty electric vehicles to be sold in the timeframe of the program.<sup>851 852</sup> We are proposing adjustments to the MY 2027 HD GHG Phase 2 standards to reflect this innovation and facilitate the transition to more stringent longer-term standards such that all conventional vehicles would need some level and

<sup>849</sup> Considering technological feasibility, compliance cost, lead time, and other factors.

<sup>850</sup> Memo to Docket. HD 2027 Proposed Changes to Heavy-Duty Greenhouse Gas Emissions. November 2021.

<sup>851</sup> EPA has not yet received a waiver request under CAA section 209(b) from California for the ACT rule.

<sup>852</sup> ACT requires manufacturers to sell a certain percentage of zero emission heavy-duty vehicles (BEVs or fuel cell vehicles) for each model year, starting in MY 2024. The sales requirements vary by vehicle class, starting at 5 to 9 percent of total MY 2024 heavy-duty vehicle sales in California and increasing to 15 to 20 percent of MY 2027 sales. Several states have followed suit and issued proposals to adopt California’s ACT under CAA section 177, and we anticipate more states to follow with similar proposals.

combination of GHG emissions-reducing technology, as intended in the original HD GHG Phase 2 rulemaking. Based on our evaluation of the heavy-duty EV market in the MY 2027 timeframe, we expect school buses, transit buses, delivery trucks, and short haul tractors to have the highest EV sales of all heavy-duty vehicle types between now and 2030. Therefore, we propose to make targeted changes to the MY 2027 standards that are projected to be affected by these four types of electric vehicles. As we describe in the next section, EPA has considered the technological feasibility and cost of the proposed standards and the available lead time for manufacturers to comply with the proposed standards in MY 2027. We request comment on all aspects of these proposed targeted updates to the MY 2027 HD GHG Phase 2 program, including our projections that these four vehicle categories are the appropriate heavy-duty vehicles EPA should focus on for our proposed revisions, and if there are additional vehicle categories we should be considering. We are also considering whether it would be appropriate in the final rule to increase the stringency of the standards more than what we have proposed. Therefore, we request information on heavy-duty electric vehicle sales projections, including projections based on future product plans, to help inform our HD electric vehicle sales projections in the MY 2024 through MY 2029 timeframe. Furthermore, we also request comment on potential impacts on small business vehicle manufacturers if we finalize standards that are more stringent than the proposal. We also request comment on whether to finalize the proposed standards for small business vehicle manufacturers even if we finalize more stringent standards for other manufacturers and whether to allow small business vehicle manufacturers to voluntarily comply with more stringent standards, if finalized, than those required for small manufacturers (either under the existing Phase 2 standards or as updated, if finalized).

We also are considering whether to establish more stringent standards beyond MY 2027, specifically in MY 2028 and MY 2029, using the methodology discussed in Section XI.C.1 but adjusted by MY based on projected penetration rates of ZEV technology for those years both inside and outside of California. We request comment on the appropriate stringency and supporting data for each of those model years, and whether to finalize such an increase in stringency for those

model years' standards in a one-step (single MY) or multi-step (multiple MY) approach. EPA requests comment and supporting data that could support higher penetrations of HD ZEVs in the MY 2027 to 2029 timeframe which could serve as the basis for the increase in the stringency CO<sub>2</sub> standards for specific Phase 2 vehicle subcategories. For example, what information and data are available that would support HD ZEV penetration rates of 5 percent or 10 percent (or higher) in this timeframe, and in what HD vehicle applications and categories. We also request comment on whether EPA should adjust our proposed approach to allow HD ZEV manufacturers to generate NO<sub>x</sub> emission credits if we were to increase the stringency of the CO<sub>2</sub> standards for specific Phase 2 vehicle subcategories based on higher projected penetrations of HD ZEVs in the MY 2027 to 2029 timeframe (see Section IV.I for our proposal to allow HD ZEV manufacturers to generate NO<sub>x</sub> emission credits).

#### 1. Determining the Proposed Standards

In Section XI.A we described how the HD GHG Phase 2 vehicle CO<sub>2</sub> standards are differentiated by vehicle weight, use, fuel type, etc. to recognize the diverse nature of the industry, resulting in 15 subcategories for vocational vehicle standards, with an additional eight subcategories for specialty vehicle types, and 10 subcategories for tractor standards. These HD GHG Phase 2 standard subcategories for vocational vehicles and tractors do not correspond directly with our projections for the four high-sales EV vehicle types—school buses, transit buses, delivery trucks, and short-haul tractors. For example, there is no subcategory with a specific standard for a “delivery truck”; rather, a vocational vehicle used for deliveries may fall into any one of several different subcategories depending on its weight and use pattern. In fact, based on our review of the applications for certification of MY 2020 and MY 2021 vehicles, HD electric vehicle manufacturers of these four vehicle types are certifying them into several of the EPA regulatory vocational vehicle CI subcategories, the school bus and transit bus custom chassis subcategories, and into all three of the Class 8 day cab tractor subcategories.<sup>853</sup>

The changes we are proposing apply only to a subset of the MY 2027 heavy-

duty CO<sub>2</sub> vehicle emission standards. We are not proposing any changes to the heavy-duty engine CO<sub>2</sub> emission standards. The current HD GHG Phase 2 engine standards only apply to engines that are “internal combustion engines.”<sup>854</sup> Electric vehicles are not powered by internal combustion engines. Furthermore, the CO<sub>2</sub> emission credits generated from electric vehicles are not allowed to be brought into the engine averaging sets.<sup>855</sup> Therefore, electric vehicles have no effect on manufacturers' strategies for meeting the HD engine GHG standards, and EPA is not proposing to modify the HD engines GHG standards.

After careful consideration of an approach that would achieve appropriate emission reductions and account for the emerging HD EV market without changing the HD GHG Phase 2 program as a whole, we are proposing to adjust the HD GHG Phase 2 vehicle CO<sub>2</sub> emission standards based on sales-weighting the projected EV production levels of the four types of EVs and using that information to lower the emission standards only for the vocational vehicle and six tractor subcategories that are applicable to these four types of EVs (depending on weight and use pattern) in MY 2027.

Our proposed approach involves three steps. First, we projected the number of sales of electric school buses, transit buses, delivery trucks, and short-haul tractors in MY 2027 based on sales data and projections outlined in the next paragraph. Second, we determined the percentage EVs relative to the total number of vehicles produced in the nine CI vocational vehicle and day cab tractor subcategories, plus the optional school bus and transit bus subcategories.<sup>856</sup> Third, we reduced the numeric level of the standards for the vocational vehicle subcategories and the applicable tractor subcategories by the projected percentage of electric vehicles. Under the resulting revised standards that we are proposing and our projections of EVs, manufacturers would need to either incorporate additional emissions reductions or not generate as many emissions credits,

<sup>854</sup> 40 CFR 1036.5(d).

<sup>855</sup> 40 CFR 1036.740.

<sup>856</sup> We propose that vocational EVs could certify to any of the CI subcategory standards, but would not be allowed to certify to any SI subcategory standard. This is consistent with the approach finalized for heavy-duty vehicles under 14,000 pounds (see 40 CFR 86.1819(a)(2)(ii)). The GHG credit averaging sets for vehicles are based on GVWR and are not differentiated by SI or CI. Therefore, credits generated from EVs would be used within an averaging set that includes both SI and CI vehicles. We are not proposing any changes to the SI vehicle standards.

<sup>853</sup> Note that the Class 7 Tractor CO<sub>2</sub> emission standards in 40 CFR 1037.106 apply to “All Cab Styles”, but nearly all tractors that are subject to these standards are day cabs. Therefore, we refer to these as day cab tractor standards throughout this section.

compared to our estimates at the time of the HD GHG Phase 2 rule. This approach would adjust 17 of the 33 MY 2027 HD GHG Phase 2 standards. We believe that it is not appropriate to propose updates to the sleeper cab tractor standards in this action because the typical usage and daily miles travelled by these vehicles is beyond the range available in current electric tractors under development. We request comment on this approach and the proposed revisions to MY 2027 CO<sub>2</sub> emission standards.

Projecting the production levels of conventional and electric HD vehicles in MY 2027 and beyond is challenging. For this proposal, we used information such as the projected number of zero emission vehicles in the MY 2027 and beyond timeframe from CARB’s ACT

rulemaking documents, the current level of national EV sales data from the International Council on Clean Transportation, the number of conventional vehicles and electric vehicles sold based on EPA’s heavy-duty vehicle GHG certification programs, product announcements, and engineering judgment to inform our projection of EV production in the national market for MY 2027, described in the next paragraph. We request comment on this information, and on identification and description of other available information sources including, more specifically, data and product plans, to help inform these projections. If additional data is submitted by commenters related to the approach described in this section, we would consider it for the final rule, including

the potential for a more stringent adjustment to the MY 2027 standards.

As a starting point for our national projections, CARB’s ACT rulemaking includes (1) projections for the total number of heavy-duty vehicles sold in California in MY 2024 through MY 2030 and (2) a mandate requiring manufacturers to sell a specific percentage of zero-emission vehicles each model year.<sup>857</sup> As shown in Table XI–2, 20 percent of vocational vehicles and 15 percent of tractor vehicles sold in California in MY 2027 are required by the mandate to be zero-emission vehicles. Combining these two sets of information, we estimated the number of electric vehicles that would be sold in California in MY 2027, shown in Table XI–3.

TABLE XI–3—PROJECTED NUMBER OF HD ELECTRIC VEHICLES SOLD IN CALIFORNIA IN MY 2027 BASED ON THE CARB ACT PROGRAM

	Projected number of conventional and electric vehicles in CA	Projected number of electric vehicles in CA
Class 4–8 Vocational Vehicles .....	15,945	3,189
Tractors .....	4,993	749

We analyzed the information provided in a recent report by the International Council on Clean Transportation to extrapolate the number of new heavy-duty electric vehicles that we would expect to be sold

in the entire U.S. in MY 2027.<sup>858</sup> The report includes the number of heavy-duty electric vehicles registered by state and province in the U.S. and Canada as of 2020. Based on these values, we estimate that approximately 42 percent

of the heavy-duty electric vehicle sales in the U.S. are in California. Using this figure, we estimated the total number of electric vehicles in the other 49 states in MY 2027, shown in Table XI–4.

TABLE XI–4—PROJECTED NUMBER OF HD ELECTRIC VEHICLES SOLD NATIONALLY IN MY 2027

	Projected number of electric vehicles sold in California	Projected number of electric vehicles sold in other 49 states	Projected total electric vehicles sold nationally
Class 4–8 Vocational Vehicles .....	3,189	4,404	7,593
Tractors .....	749	1,034	1,783
Total .....	3,938	5,538	9,376

Next, we project the total number of U.S. heavy-duty vocational vehicle and tractor sales in MY 2027. Our projections come from the sales split by vehicle category used in the HD GHG

Phase 2 rulemaking.<sup>859</sup> Furthermore, we assumed the fraction of short-haul tractors relative to the overall tractor sales at 37 percent based on the split used in MOVES3 for heavy-duty

vehicles in 2027.<sup>860</sup> The total number of projected HD vocational vehicle and day cab tractor sales in MY 2027 are shown in Table XI–5.

<sup>857</sup> CARB. Advanced Clean Trucks Regulation. Standardized Regulatory Impact Analysis. Page 25. August 8, 2019.

<sup>858</sup> ICCT. “Zero-emission bus and truck market in the United States and Canada: A 2020 Update.” May 2021. Pages 5–6. Can be accessed online at

<https://theicct.org/publications/canada-race-to-zero-FS-may2021>.

<sup>859</sup> U.S. EPA. “Regulatory Impact Analysis: Greenhouse Gas Emissions and Fuel Efficiency Standards for Medium- and Heavy-Duty Engines

and Vehicles—Phase 2.” Table 7–55. Page 7–49. April 2016.

<sup>860</sup> U.S. EPA. “Population and Activity of Onroad Vehicles in MOVES3.” Table 4–44. Page 30. April 2021. Can be accessed at <https://nepis.epa.gov/Exe/ZyPDF.cgi?Dockey=P1011TF8.pdf>.

TABLE XI-5—PROJECTED NUMBER OF HD VEHICLES SOLD NATIONALLY IN MY 2027

Total Class 4–8 vocational vehicles	Total tractors	Total day cab tractors	Total day cab and vocational vehicles
523,805 .....	155,682	57,602	581,407

We are proposing an approach of aggregating the total number of heavy-duty electric vehicles and total number of day cab tractors and vocational vehicles to calculate the proposed value to account for the fact that many of the EV tractors will likely be certified as “vocational” tractors and certified to a vocational subcategory. We estimate the overall percentage of heavy-duty electric vehicles in MY 2027 based on the values shown in Table XI-4 and Table XI-5 at approximately 1.5 percent. EPA requests comment on this percent projection, including if this value should be lower or higher, and the data and rational for alternative projections which EPA should consider.

At this projected level of EVs in MY 2027, we estimate that approximately five percent of conventional heavy-duty vehicles would be able to meet the current HD GHG Phase 2 standards without installing emission-reducing technologies because the standards apply as a fleet-average.<sup>861</sup> As an example for the Class 8 high roof day cab tractor subcategory, a manufacturer could produce 1.5 percent electric tractors that emit 0 gram/ton-mile; 93.5 percent of conventional vehicles with technology packages that emit on

average at the MY 2027 standard of 75.7 g/ton-mile; and 5 percent vehicles that emit at the baseline level of 98.2 g/ton-mile (*i.e.*, no additional CO<sub>2</sub> emission-reducing technologies beyond Phase 1).<sup>862</sup> On average, this example fleet would meet the current HD GHG Phase 2 MY 2027 standard of 75.7 g/ton-mile.

EPA’s heavy-duty vehicle GHG certification data shows that EV products are being certified in most of the compression-ignition vocational vehicle subcategories, including the school buses and transit buses optional custom chassis subcategories, and the day cab tractor subcategories (about half of the total tractor subcategories). Therefore, we propose to revise the existing CO<sub>2</sub> emission standards in these 17 subcategories. The existing vocational vehicle and tractor standards that would be affected are shown in Table XI-6 and Table XI-8.

With this proposed stringency increase, we intend for the five percent fraction of conventional vehicles that theoretically would not need additional technology to meet current HD GHG Phase 2 standards to need to install some combination of emissions-reducing technologies that on average would meet the current HD GHG Phase 2 standards. Applying the proposed

revisions to the MY 2027 standards to the Class 8 high roof day cab tractor subcategory example, in this hypothetical fleet a manufacturer would produce 1.5 percent electric tractors and all of the remaining conventional vehicles would themselves on average have CO<sub>2</sub> emission-reducing technologies that meet the current HD GHG Phase 2 MY 2027 standard of 75.7 g/ton-mile standard. We propose the revised MY 2027 standards for the vocational vehicle and tractors standards, as shown in Table XI-7 and Table XI-9.<sup>863</sup> In addition, we propose that electric vocational vehicles beginning in MY 2027 be required to certify in one of the nine standards for compression-ignition vehicles or the optional custom chassis standards.<sup>864</sup> This is consistent with the approach finalized for heavy-duty vehicles under 14,000 pounds GVWR (see 40 CFR 86.1819(a)(2)(ii)). The GHG credit averaging sets for vehicles are based on GVWR and are not differentiated by SI or CI. Therefore, credits generated from EVs would be used within an averaging set that includes both SI and CI vehicles. We are not proposing any changes to the SI vehicle standards. We request comment on this approach.

TABLE XI-6—EXISTING MY 2027 VOCATIONAL VEHICLE CO<sub>2</sub> EMISSION STANDARDS [g/ton-mile]

	CI light heavy	CI medium heavy	CI heavy heavy
Urban .....	367	258	269
Multi-Purpose .....	330	235	230
Regional .....	291	218	189
Optional Custom Chassis: School Bus .....	271		
Optional Custom Chassis: Transit Bus .....	286		

TABLE XI-7—PROPOSED MY 2027 VOCATIONAL VEHICLE CO<sub>2</sub> EMISSION STANDARDS [g/ton-mile]

	CI light heavy	CI medium heavy	CI heavy heavy
Urban .....	361	254	265
Multi-Purpose .....	325	231	226
Regional .....	286	215	186
Optional Custom Chassis: School Bus .....	267		
Optional Custom Chassis: Transit Bus .....	282		

<sup>861</sup> Memo to Docket. HD 2027 Proposed Changes to Heavy-Duty Greenhouse Gas Emissions. November 2021.

<sup>862</sup> For the baseline value, see 81 FR 73588.

<sup>863</sup> See proposed 40 CFR 1037.105 and 1037.106.

<sup>864</sup> See proposed 40 CFR 1037.101(c)(3).

**TABLE XI-8—EXISTING MY 2027 TRACTOR CO<sub>2</sub> EMISSION STANDARDS**  
[g/ton-mile]

	Class 7 (all cab styles)	Class 8 (day cab)
Low Roof Day Cab ...	96.2	73.4
Mid Roof Day Cab ....	103.4	78.0
High Roof Day Cab ..	100.0	75.7

**TABLE XI-9—PROPOSED MY 2027 TRACTOR CO<sub>2</sub> EMISSION STANDARDS**  
[g/ton-mile]

	Class 7 (all cab styles)	Class 8 (day cab)
Low Roof .....	94.8	72.3
Mid Roof .....	101.8	76.8
High Roof .....	98.5	74.6

**2. Technology Costs for the Proposed Changes**

In HD GHG Phase 2, EPA projected that the CO<sub>2</sub> emissions reductions can be feasibly, and cost effectively, met through technological improvements in several areas of the heavy-duty engine and vehicle.<sup>865</sup> The combination of improvements in the HD GHG Phase 2

analysis included advanced aerodynamics, more efficient engines, idle reduction technologies, transmission and driveline improvements, and lower rolling resistance tires and automatic inflation systems. In establishing the HD GHG Phase 2 standards and determining the associated technology costs, we evaluated each technology and its effectiveness and estimated the most appropriate adoption rate of the technology in each vehicle subcategory. A technology package that combined the technologies and adoption rate was developed for each vehicle subcategory and used to derive the current HD GHG Phase 2 standards. In proposing revised standards, we apply the same technology packages and cost estimates developed for the existing HD GHG Phase 2 program in 2016 to the conventional vehicles that would not otherwise need to apply technology due to the increase in electric vehicles projected for MY 2027 and beyond, absent the changes we are proposing in this document.

The fleet-average incremental per-vehicle technology package costs for each subcategory are summarized in the 2016 HD GHG Phase 2 preamble with

additional details provided in the HD GHG Phase 2 RIA Chapter 2.12. The technology cost analyses reflected both the direct costs and indirect costs, which included items such as warranty. Table XI-10 and Table XI-11 provide the per-vehicle costs of the technology packages to meet the HD GHG Phase 2 MY 2027 CO<sub>2</sub> emission standards for tractors and vocational vehicles, respectively.<sup>866 867</sup> As discussed in the HD GHG Phase 2 preamble, the per vehicle costs represent approximately a 12 percent increase in typical vehicle price for tractors and 3 percent for vocational vehicles.<sup>868</sup> However, the benefits of the technology greatly exceed the costs and the payback periods are short meaning that the purchaser will see substantial new savings over the vehicle lifetime primarily due to reduced fuel costs.<sup>869</sup> These same per-vehicle technology costs would apply to the subset of conventional vehicles that would require the technology package to meet the proposed revised standards, as was originally intended under the HD GHG Phase 2 program. We believe the technology costs developed during HD GHG Phase 2 are still appropriate, but we welcome comments on revising the technology costs.

**TABLE XI-10—TRACTOR TECHNOLOGY INCREMENTAL AVERAGE COSTS FOR MY 2027**  
[2013\$]

Class 7 low/mid roof day cab	Class 7 high roof day cab	Class 8 low/mid roof day cab	Class 8 high roof day cab
\$10,235 .....	\$10,298	\$10,439	\$10,483

**TABLE XI-11—VOCATIONAL VEHICLE TECHNOLOGY INCREMENTAL AVERAGE COSTS FOR MY 2027**  
[2013\$]

Light HD			Medium HD			Heavy HD		
Urban	Multi-purpose	Regional	Urban	Multi-purpose	Regional	Urban	Multi-purpose	Regional
\$2,533 .....	\$2,571	\$1,486	\$2,727	\$2,771	\$1,500	\$4,151	\$5,025	\$5,670

In HD GHG Phase 2, we calculated the payback period, or time it would take for the increase in technology package and associated costs to be offset by the savings in operating costs, most notably fuel costs. This analysis included the hardware costs of the new technologies and their associated fixed costs, insurance, taxes, and maintenance. In HD GHG Phase 2, we found that the fuel savings significantly exceed the costs

associated with the technologies over the lifetime of the vehicles, with payback occurring in the fourth year of operation for vocational vehicle and in the second year for tractor-trailers.<sup>870</sup> This same payback analysis would apply to the proposed revised standards, again as we are applying the same technology packages with the same costs and fuel saving to conventional vehicles that were originally intended to

have these packages under the existing HD GHG Phase 2 program but would not with the current rise in electrification, absent these changes we are proposing in this action.

**3. Consistency of the Revised Standards With the Agency’s Legal Authority**

The intent of the existing HD GHG Phase 2 program was to set the stringency of the standards at a level

<sup>865</sup> 81 FR 73585 through 73613 (October 25, 2016); 81 FR 73693 through 73719 (October 25, 2016).

<sup>866</sup> 81 FR 73621, Table III-27 (October 25, 2016).

<sup>867</sup> 81 FR 73718, Table V-30 (October 25, 2016).

<sup>868</sup> 81 FR 73482 (October 25, 2016).

<sup>869</sup> 81 FR 73481 (October 25, 2016).

<sup>870</sup> 81 FR 73904 (October 25, 2016).

that all conventional vehicles would need to install some level and combination of emission-reducing technologies or offset another conventional vehicle not installing such technology, since at that time we predicted very little market penetration of EVs. The proposed revised standards are based on the same technology packages used to derive the current HD GHG Phase 2 standards. To calculate the proposed standards, we applied these same technology packages to the subset of the vehicles that would otherwise not require CO<sub>2</sub> emission-reducing technologies due to the higher projection of HD electric vehicles in MY 2027 and beyond. The HD GHG Phase 2 standards were based on adoption rates for technologies in technology packages that EPA regards as appropriate under CAA section 202(a) for the reasons given in the HD GHG Phase 2 rulemaking in Section III.D.1 for tractors and Section V.C.1 for vocational vehicles.<sup>871</sup> We continue to believe these technologies can be adopted at the estimated technology adoption rates for these proposed revised standards within the lead time provided. The fleet-wide average cost per tractor projected to meet the proposed revised MY 2027 standards is approximately \$10,200 to \$10,500. The fleet-wide average cost per vocational vehicle to meet the proposed revised MY 2027 standards ranges between \$1,500 and \$5,700. These increased costs would be recovered in the form of fuel savings during the first two years of ownership for tractors and first four years for vocational vehicles, which we still consider to be reasonable.<sup>872</sup> In addition, manufacturers retain leeway to develop alternative compliance paths, increasing the likelihood of the standards' successful implementation. In this proposal we have considered feasibility, cost, lead time, emissions impact, and other relevant factors, and therefore these revised proposed MY 2027 standards are appropriate under CAA section 202(a).<sup>873</sup>

#### D. HD GHG Phase 2 Advanced Technology Credits for CO<sub>2</sub> Emissions

EPA continues to believe there is a need to incentivize the development of EVs in the heavy-duty sector in the near term as a path towards zero-emissions in the long term. Early state action and industry innovation related to EVs will achieve more GHG reductions in the

near term and help set the stage for longer-term actions. However, the advanced technology credit multipliers for CO<sub>2</sub> emissions in HD GHG Phase 2 may no longer be appropriate based on our current understanding of the heavy-duty market. The existing large advanced technology credit multipliers could result in potential reductions in the effective stringency of the existing MY 2024 through 2027 standards, particularly in combination with the rise in EVs including, but not limited to, those built to satisfy the California ACT requirement. In addition, an increase in production volumes of EVs would likely reduce the cost differential between EVs and conventional vehicles, correspondingly reducing the need for large, advanced technology multipliers. Given these factors, we are requesting comment on three approaches that would reduce the number of incentive credits produced by electric vehicles in the MY 2024 through MY 2027 timeframe (*i.e.*, credit multiplier approach for EVs certified to meet California's ACT Rule, advance technology credit cap approach, and transitional credit cap approach). We are not proposing any one of these approaches and request comment on all aspects of all three approaches.

The HD GHG Phase 2 program currently includes advanced technology credit multipliers for CO<sub>2</sub> emissions for all-electric vehicles, plug-in hybrid electric vehicles, and fuel cell vehicles.<sup>874</sup> The HD GHG Phase 2 credit multipliers begin in MY 2021 and end after MY 2027.

The CO<sub>2</sub> emission credits for heavy-duty vehicles are calculated using Equation XI-1. The CO<sub>2</sub> emission credits for heavy-duty electric vehicles built between MY 2021 and MY 2027 are then multiplied by 4.5 and, for discussion purposes, can be visualized as split into two shares.<sup>875</sup> The first share of credits comes from the reduction in CO<sub>2</sub> emissions realized by the environment from an electric vehicle that is not emitting from the tailpipe, represented by the first 1.0 portion of the multiplier. For all-electric vehicles, the family emission level (FEL) value is deemed to be 0 grams/ton-mile.<sup>876</sup> Therefore, each electric vehicle produced receives emission credits equivalent to the level of the standard, even before taking into account the effect of a multiplier. The second share of credits does not represent CO<sub>2</sub> emission reductions realized in the real world, but was established by EPA to

help incentivize a nascent market: The emission credits for electric vehicles built between MY 2021 and 2027 receive an advanced technology credit multiplier of 4.5, *i.e.*, an additional 3.5 multiple of the standard.

#### Equation XI-1: CO<sub>2</sub> Emission Credit Calculation for Heavy-Duty Vehicles

$$\text{Emission credits (Mg)} = (\text{Std-FEL}) \cdot (\text{PL}) \cdot (\text{Volume}) \cdot (\text{UL}) \cdot (10^{-6})$$

Where:

*Std* = the emission standard associated with the specific regulatory subcategory (g/ton-mile)

*FEL* = the family emission limit for the vehicle subfamily (g/ton-mile)

*PL* = standard payload, in tons

*Volume* = U.S.-directed production volume of the vehicle subfamily

*UL* = useful life of the vehicle, in miles, as described in 40 CFR 1037.105 and 1037.106

The HD GHG Phase 2 advanced technology credit multipliers represent a tradeoff between encouraging a new technology that could have significant benefits well beyond what is required under the standards and providing credits that do not reflect real world reductions in emissions which in effect allow for emissions increases by other engines and vehicles. At the time we finalized the HD GHG Phase 2 program in 2016, we balanced these factors based on our estimate that there would be very little market penetration of EVs in the heavy-duty market in the MY 2021 to MY 2027 timeframe, during which the advanced technology credit multipliers would be in effect. In fact, the primary technology packages used to determine the HD GHG Phase 2 standards did not include any EVs. For MY 2019, EPA's heavy-duty vehicle GHG certification data show that approximately 0.06 percent of heavy-duty vehicles certified were electric vehicles. At low adoption levels, we believe the balance between the benefits of encouraging additional electrification as compared to any negative emissions impacts of multipliers would be appropriate and would justify maintaining the current advanced technology multipliers. This is consistent with our assessment conducted during the development of HD GHG Phase 2 where we found only one all-electric HD vehicle manufacturer had certified through 2016, and we projected "limited adoption of all-electric vehicles into the market."<sup>877</sup> However, as discussed in Section XI.B, we are now in a transitional period where manufacturers are actively increasing their zero-emission HD vehicle offerings, and we expect this

<sup>871</sup> 81 FR 73585 through 73613 (October 25, 2016); 81 FR 73693 through 73719 (October 25, 2016).

<sup>872</sup> 81 FR 73904 (October 25, 2016).

<sup>873</sup> See Phase 2 Safety Impacts at 81 FR 73905 through 73909 (October 25, 2016).

<sup>874</sup> 40 CFR 1037.150(p).

<sup>875</sup> 40 CFR 1037.705.

<sup>876</sup> 40 CFR 1037.150(f).

<sup>877</sup> 81 FR 75300 (October 25, 2016).

growth to continue through the timeframe of the HD GHG Phase 2 program.

While we did anticipate some growth in electrification would occur due to the credit incentives in the HD GHG Phase 2 rule, we did not expect the level of innovation observed or that California would adopt a requirement for such a large number of heavy-duty electric vehicles to be sold at the same time these advanced technology multipliers

were in effect.<sup>878 879</sup> Based on this new information, we believe that the existing advanced technology multiplier credit levels may no longer be appropriate for maintaining the balance between encouraging manufactures to continue to invest in new technologies over the long term and potential emissions increases in the short term. We believe that if left as is, the multiplier credits could allow for backsliding of emission reductions expected from internal

combustion engine vehicles for some manufacturers in the near term, as sales of advanced technology vehicles continue to increase. We show an example of this in Figure XI-1 using the heavy heavy-duty vehicle averaging set. At approximately 8.5 percent EV adoption rate into this averaging set, approximately 100 percent of the projected reductions from HD GHG Phase 2 would be lost.

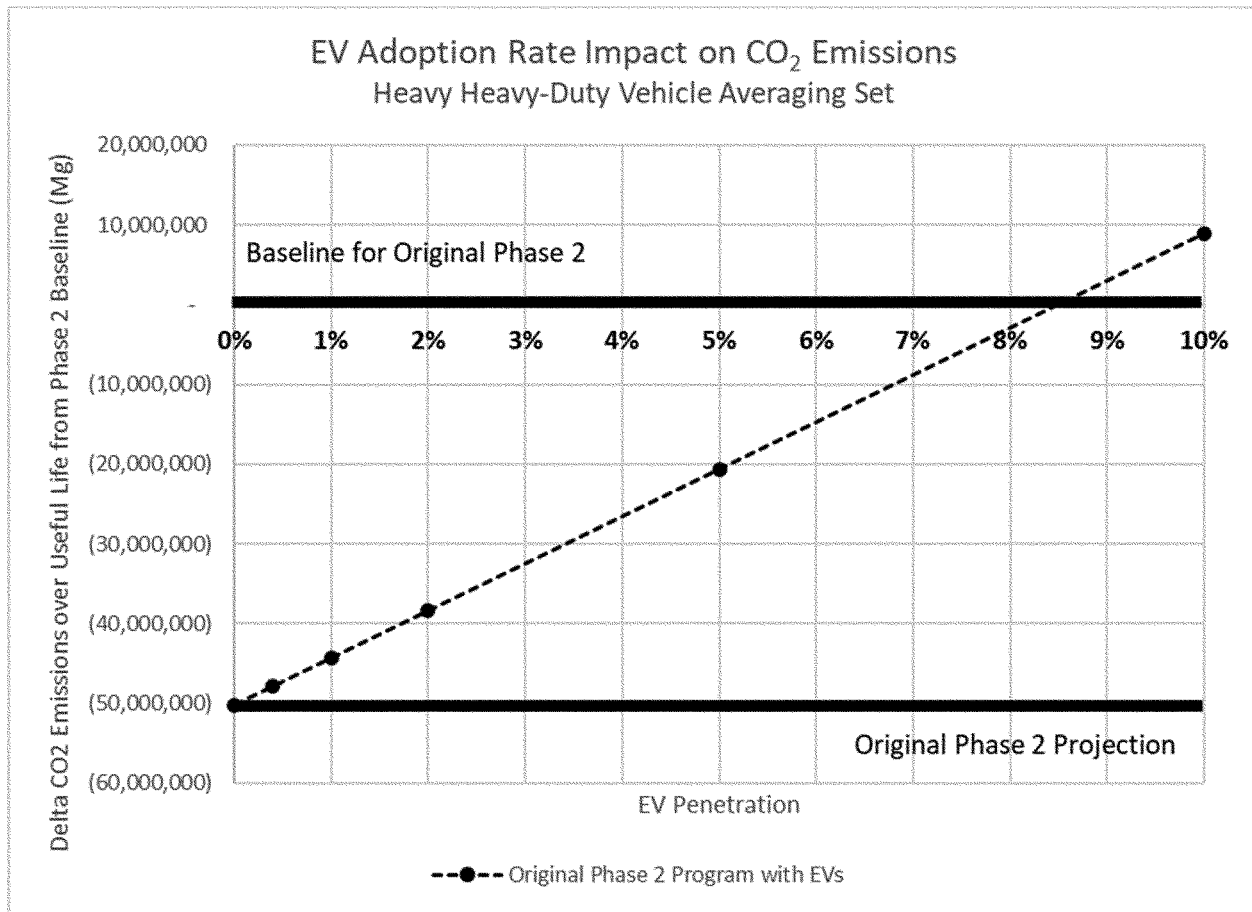

Figure XI-1 Impact of EV Production Levels on Projected CO2 Emissions (includes impact of multiplier)

Therefore, EPA is seeking comment on the potential need to update the HD GHG Phase 2 advanced technology incentive program. In this proposal, we seek comment on three potential approaches that would be in addition to the proposed revised MY 2027 CO<sub>2</sub> emission standards. Each of these approaches is distinct and we would only consider finalizing a single approach.

California’s ACT rule was adopted in 2020 and is expected to cause a shift in heavy-duty electric vehicle production in the U.S. The ACT requires manufacturers to sell a certain percentage of zero emission heavy-duty vehicles (BEVs or fuel cell vehicles) for each model year, starting in MY 2024. The sales requirements vary by vehicle class, starting at 5 to 9 percent of total MY 2024 heavy-duty vehicle sales in

California and increasing to 15 to 20 percent of MY 2027 sales. EPA has received a waiver request under CAA section 209(b) from California for the ACT rule and is reviewing that request. The first approach outlined in this section is predicated on one potential outcome from the review process, which is granting a waiver request for the ACT rule. Given the timing of this proposed rulemaking, we have considered the

<sup>878</sup> EPA has not yet received a waiver request under CAA section 209(b) from California for the ACT rule.

<sup>879</sup> ACT requires manufacturers to sell a certain percentage of zero emission heavy-duty vehicles

(BEVs or fuel cell vehicles) for each model year, starting in MY 2024. The sales requirements vary by vehicle class, starting at 5 to 9 percent of total MY 2024 heavy-duty vehicle sales in California and increasing to 15 to 20 percent of MY 2027 sales.

Several states have followed suit and issued proposals to adopt California’s ACT under CAA section 177, and we anticipate more states to follow with similar proposals.

potential impacts of the California ACT rule on the HD GHG Phase 2 program and we solicit comment on how we could address such potential impacts.

In all three approaches, the changes would begin in MY 2024 to align with California's ACT program. If we finalize changes to the advanced technology credit program in a final rule in 2022, then we would be providing one year of lead time for the manufacturers' product planning and two years to adjust the calculations in the ABT reports for the MY 2024 changes.<sup>880</sup> We request comment on the lead time needed for each of these approaches. We are also seeking comment on whether there are better, alternative methods that EPA should consider and whether we should consider changes to the advanced technology incentive program for fuel cell vehicles and/or plug-in hybrid vehicles.

#### 1. Credit Multiplier Approach for EVs Certified to Meet California's ACT Rule

When EPA finalized the HD GHG Phase 2 program, including the advanced technology credit program, we did not envision a large number of EVs such as required in the California ACT rule. All multipliers reduce the overall stringency of the standards as a trade-off for encouraging early innovation and adoption of new technologies, and a large number of vehicles that qualify for the credits can allow for emissions increases by other engines and vehicles at the national level. However, our view is that EVs built to satisfy California's ACT requirement would not need an additional advanced technology credit incentive from the HD GHG Phase 2 program. The technology feasibility of the proposed revised standards, as we explain in Section XI.C, and the flexibilities that would still be included in meeting those standards with the 1.0 multiplier for the EVs, show that manufacturers would still be able to meet the existing HD GHG Phase 2 standards in the MY 2024 through MY 2026 timeframe and the proposed revised MY 2027 standards without the credits from the multipliers. Therefore, we are requesting comment on an approach that would treat all EVs certified in California in the MY 2024 through MY 2027 timeframe differently than the vehicles certified outside of California. Under this approach, the MY 2024 through MY 2027 EVs certified in California would not receive the advanced technology credit multiplier that currently exists. We note that these EVs would still continue to be deemed to have zero grams CO<sub>2</sub> per ton-mile

emissions and receive significant credits reflective of the difference between the applicable CO<sub>2</sub> emission standard and zero grams. The approach to EVs certified to the EPA program for new vehicles sold outside of California and not subject to California standards in other states under Section 177 would remain unchanged and receive the advanced credit multiplier. We request comment on this approach in general, and we request specific comment on whether maintaining this multiplier for EVs sold outside of California could impact manufacturer production plans.

#### 2. Advanced Technology Credit Cap Approach

In Phase 1, EPA included a provision that capped the amount of advanced technology credits that could be brought into any averaging set in any model year at 60,000 Mg of CO<sub>2</sub> emissions to prevent market distortions.<sup>881</sup> The second approach we are requesting comment on is similar to the Phase 1 advanced technology credit cap approach. We did not finalize such a cap in HD GHG Phase 2 because, as described at the beginning of this section, we believe we appropriately balanced encouraging new technologies and potential emissions increases under the assumption that there would be very limited adoption of EVs during the HD GHG Phase 2 timeframe. However, the option for unlimited advanced technology credit multipliers for CO<sub>2</sub> emissions in HD GHG Phase 2 may no longer be appropriate considering the observed and projected rise in electrification.

Under this credit cap approach, advanced technology credits generated due to the production of EVs on an annual basis that are under the cap would remain unchanged. Above the cap, the multiplier would effectively be a value of 1.0; in other words, after a manufacturer reaches their cap in any model year, the multiplier would no longer be available and would have no additional effect on credit calculations. Each electric vehicle produced would still receive emission credits equivalent to the level of the standard (the real-world emission reduction), but this effect would not be multiplied to generate additional credits for that manufacturer.

The first step in developing this approach would be to determine the appropriate level of EV adoption rate above which to apply the cap. The cap could be set at a lower level to be more protective of the environment or at a

higher level to continue to provide strong incentives to the development of heavy-duty EVs. In setting the value EPA would consider how the selected cap level limits losses of the HD GHG Phase 2 program's emission reduction efficacy.

We seek comment on an approach that would set a cap at a level that would restrict the credit multipliers for EVs produced above a threshold of one percent of the total projected vehicle production volumes. We first projected the number of total vehicles certified in each averaging set.<sup>882</sup> In MY 2019, the most recent year for which we have data, approximately 167,000 HD vehicles were certified into light heavy-duty; approximately 177,000 into medium heavy-duty; and approximately 267,000 into heavy heavy-duty averaging sets. Next, we determined the number of EV manufacturers. In MY 2019, there were a total of 26 manufacturers that had either certified electric vehicles or notified EPA that they were a small manufacturer that produced vehicles that were excluded from the regulations due to the small business provision in 40 CFR 1037.150(c)(3). The potential cap values represent approximately 65 vehicles per manufacturer per year in each of the light and medium heavy-duty averaging sets and approximately 100 vehicles per manufacturer per year for the heavy heavy-duty averaging sets. This advanced technology credit cap approach would limit the credits generated by a manufacturer's use of the advanced technology credit multipliers for battery electric vehicles to the following levels of CO<sub>2</sub> per manufacturer per model year beginning in MY 2024 and extending through MY 2027:

- Light Heavy-Duty Vehicle Averaging Set: 42,000 Mg CO<sub>2</sub>
- Medium Heavy-Duty Vehicle Averaging Set: 75,000 Mg CO<sub>2</sub>
- Heavy Heavy-Duty Vehicle Averaging Set: 325,000 Mg CO<sub>2</sub>

We request comment on applying this general approach to a different EV threshold based on a sales percentage or absolute emissions cap, the structure of the credit cap, the assumptions that would be used in developing the numerical value of the caps, and whether these credit caps also should apply to plug-in hybrids and fuel cell vehicles.

<sup>882</sup> Memo to Docket. HD 2027 Approaches to Change the Heavy-Duty GHG Phase 2 Advanced Technology Credit Incentive Program. September 2021.

<sup>880</sup> 40 CFR 1037.730.

<sup>881</sup> 76 FR 57246 (September 15, 2011). Regulations can be found in 40 CFR 1036.740(c)(1).



3. Transitional Credit Multipliers Approach

A third option to limit the credit multiplier impact would be to reduce and phase-out the magnitude of the credit multipliers over a period of model years. EPA has always intended the credit multipliers to serve as a temporary incentive for manufacturers to develop and use zero-emission technologies. The HD GHG Phase 2 advanced technology credit multipliers currently end after MY 2027. The credit multipliers were not considered in determining the feasibility of the HD GHG Phase 2 CO<sub>2</sub> emission standards. The feasibility was determined through the evaluation of conventional technologies, as described in Section XI.C.

As noted in Section XI.A.2, the HD GHG Phase 2 advanced technology credit multipliers were derived based on CARB’s cost analysis that compared the costs of BEVs in the 2015/2016 timeframe to costs of other conventional CO<sub>2</sub>-reducing technologies. CARB’s cost analysis showed that multipliers in the range we finalized for HD GHG Phase 2 would make these technologies closer to cost-competitive with the conventional technologies. Since 2016, the electric vehicle market has grown and is now projected to continue growing in ways we did not anticipate in HD GHG Phase 2: Namely that we did anticipate small growth in electrification due to the credit incentives, but we did not predict the large numbers of heavy-duty EVs associated with California’s ACT requirement, as described in Section

XI.B.2. Therefore, the projected costs of electric vehicles in the future continue to decrease to reflect the increase in learning and production levels. For this proposal, EPA recreated the BEV technology cost analysis to determine new values under consideration for the advanced technology credits. The analysis was updated using new information on the cost of EVs in the form of CARB’s incremental BEV costs developed in 2019.<sup>883</sup> We maintained the conventional vehicle technology costs and associated final HD GHG Phase 2 CO<sub>2</sub> emission standards in this analysis as we believe the cost of the conventional technology packages developed under HD GHG Phase 2 is still appropriate. The analysis for MY 2024 is shown in Table XI–12 and for MY 2027 in Table XI–13.

**Table XI-12 Advanced Technology Ratio Calculations for MY 2024**

Vehicle Category	Vehicle Sub-category	BEV Technology Incremental Cost in 2024 (2019\$) <sup>a</sup>	MY 2024 Phase 2 Technology Package Cost (2019\$) <sup>b</sup>	MY 2024 Phase 2 Standard (g/ton-mile) <sup>c</sup>	Phase 2 Baseline (g/ton-mile) <sup>d</sup>	Phase 2 Emission Benefit (g/ton-mile)	Phase 2 Conventional \$/g/ton-mile	BEV \$/g/ton-mile	Advanced Technology Cost Ratio
Tractor	Class 7	\$71,351	\$8,867	99.8	119.1	19.3	\$416	\$715	1.6
	Class 8	\$71,351	\$9,048	76.2	91.3	15.1	\$543	\$936	1.6
Vocational	Light HD	\$25,127	\$2,161	385	482	97	\$20	\$65	2.9
	Medium HD	\$31,174	\$2,297	271	332	61	\$34	\$115	3.1
	Heavy HD	\$34,799	\$3,235	283	338	55	\$53	\$123	2.1

<sup>a</sup> California Air Resources Board. Advanced Clean Trucks Regulation. Standardized Regulatory Impact Analysis. Table G8, Page 31. August 8, 2019.

<sup>b</sup> 81 FR 73620 and 73716 (October 25, 2016). Adjusted from 2013\$ to 2019\$.

<sup>c</sup> 40 CFR 1037.105 and 1037.106.

<sup>d</sup> 81 FR 73588 and 73706 (October 25, 2016).

<sup>883</sup> California Air Resources Board. Advanced Clean Trucks Regulation. Standardized Regulatory Impact Analysis. Table G8, Page 31. August 8, 2019.

**Table XI-13 Advanced Technology Ratio Calculations for MY 2027**

Vehicle Category	Vehicle Sub-category	BEV Technology Incremental Cost in 2027 (2019\$) <sup>a</sup>	MY 2027 Phase 2 Technology Package Cost (2019\$) <sup>b</sup>	MY 2027 Phase 2 Standard (g/ton-mile) <sup>c</sup>	Phase 2 Baseline (g/ton-mile) <sup>d</sup>	Phase 2 Emission Benefit (g/ton-mile)	Phase 2 Conventional \$/g/ton-mile	BEV \$/g/ton-mile	Advanced Technology Cost Ratio
Tractor	Class 7	\$53,371	\$11,292	96.2	119.1	22.9	\$447	\$555	1.1
	Class 8	\$53,371	\$11,517	73.4	91.3	17.9	\$583	\$727	1.1
Vocational	Light HD	\$18,852	\$2,795	367	482	115	\$22	\$51	2.1
	Medium HD	\$22,253	\$3,009	258	332	74	\$37	\$86	2.1
	Heavy HD	\$24,057	\$4,580	269	338	69	\$60	\$89	1.3

<sup>a</sup> California Air Resources Board. Advanced Clean Trucks Regulation. Standardized Regulatory Impact Analysis. Table G8, Page 31. August 8, 2019.

<sup>b</sup> 81 FR 73620 and 73716 (October 25, 2016). Adjusted from 2013\$ to 2019\$.

<sup>c</sup> 40 CFR 1037.105 and 1037.106.

<sup>d</sup> 81 FR 73588 and 73706 (October 25, 2016).

Under this approach, based on the values calculated in Table XI-12 and Table XI-13, EPA is taking comment on revising the advanced technology multipliers for BEVs to transition by

model year as shown in Table XI-14. We request comment on this approach, the values used in the credit multiplier calculations, and the impact of decrementing the credit multipliers on

the timeframe shown in Table XI-14. We request comment on all aspects of this approach.

**TABLE XI-14—ADVANCED TECHNOLOGY CREDIT MULTIPLIERS**

	2023	2024	2025	2026	2027	2028
Existing Advanced Credit Multipliers for Electric Vehicles .....	4.5	4.5	4.5	4.5	4.5	1.0
Advanced Credit Multipliers for Electric Vehicles under Consideration .....	4.5	3.5	3.0	2.0	1.5	1.0

*E. Emissions and Cost Impacts of Proposed Revised MY 2027 CO<sub>2</sub> Emission Standards*

As discussed throughout this section, we established the HD GHG Phase 2 program in 2016 based in part on projections that electrification of the heavy-duty market was unlikely to occur in the timeframe of the program. The recent rise in EV product offerings, which are projected to grow through MY 2027 and beyond, could affect the amount of technology required to be installed on conventional vehicles to meet the standards. As noted in Section XI.C, we derived the HD GHG Phase 2 standards based on a “technology package” that combined emission-reducing technologies with adoption rates developed for each vehicle subcategory. We set the current HD GHG Phase 2 standards at levels that would require conventional vehicles to install some combination of these technologies,

leading to CO<sub>2</sub> emissions reductions.<sup>884</sup> We estimate that the increase in electric vehicles in the timeframe of the HD GHG Phase 2 program would now allow approximately five percent of conventional vehicles to meet the standards without installing emission-reducing technologies.<sup>885</sup> The increase in the stringency we propose adjusts the standard levels such that this five percent fraction of conventional vehicles would on average need to install some combination of emissions-reducing technology. As shown in Section XI.C, we estimate the overall percentage of electric vehicles in the vocational and day cab tractor subcategories in MY 2027 to be 1.5 percent, deriving the increase in

stringency from this value. The existing HD GHG Phase 2 program was estimated to reduce CO<sub>2</sub> emissions by approximately 1 billion metric tons over the life of vehicles and engines sold during the program and provide over \$200 billion in net societal benefits at an aggregate technology cost to HD vehicle buyers and operators of roughly \$25 billion (using a 3 percent discount rate).<sup>886</sup> The small adjustment to the select standards we are proposing would generally maintain the anticipated costs and benefits of the HD GHG Phase 2 program, with a less than one percent decrease in CO<sub>2</sub> emissions and less than two percent increase in technology costs projected for the 2027 MY vehicles in the HD GHG Phase 2 rulemaking.

The proposed revised MY 2027 CO<sub>2</sub> emission standards would result in

<sup>884</sup> Considering technological feasibility, compliance cost, lead time and other factors noted in Section I.C.

<sup>885</sup> Memo to Docket. HD 2027 Proposed Changes to Heavy-Duty Greenhouse Gas Emissions. November 2021.

<sup>886</sup> 81 FR 73482, and 73894–73905 (October 25, 2016).

modest additional changes in CO<sub>2</sub> emission reductions. With the existing HD GHG Phase 2 emission standards and our projected increase in electric vehicles in the MY 2027, the MY 2027 vocational vehicles and tractors are projected to emit 29 million metric tons of CO<sub>2</sub> emissions in calendar year 2027, as shown in the Reference Case column of Table XI-15.<sup>887</sup> Also as shown in Table XI-15, the proposed increase in stringency of the MY 2027 vocational vehicle and day cab tractor standards would lead to a 1.5 percent reduction in the CO<sub>2</sub> emissions only from the subcategories of vehicles with the proposed revised standards. Overall, the

proposed standards would lead to a reduction of approximately 222,000 metric tons in 2027 beyond the current HD GHG Phase 2 program. This represents a 0.7 percent reduction in CO<sub>2</sub> emissions from the overall heavy-duty vocational vehicle and tractor sector (that includes sleeper cab tractors that remain unchanged) in 2027 compared to the emissions from these sectors with the existing HD GHG Phase 2 standards if they were to remain unchanged. Similar levels of annual reductions in CO<sub>2</sub> emissions would be expected in the years beyond 2027 for these MY 2027 vehicles, though those

future-year impacts have not been quantified.

There would be climate-related benefits associated with the CO<sub>2</sub> emission reductions achieved by the targeted revisions, but we are not monetizing them in this proposal.<sup>888</sup> We request comment on how to address the climate benefits and other categories of non-monetized benefits of the proposed rule. We intend to conduct additional analysis for the final rule after reviewing public comments related to the proposed revised standards and considering any changes to the proposed advanced technology credit program.

TABLE XI-15—CO<sub>2</sub> EMISSIONS IMPACT OF PROPOSED STANDARDS FOR 2027 CALENDAR YEAR

	Reference case CO <sub>2</sub> emissions from MY 2027 vehicles (metric tons)	CO <sub>2</sub> emission reductions (metric tons)
Light Heavy Vocational .....	2,419,884	36,298
Medium Heavy Vocational .....	3,433,171	51,498
Heavy Heavy Vocational .....	955,382	14,331
Medium Heavy Day Cab Tractors .....	4,068,458	61,027
Heavy Heavy Day Cab Tractors .....	3,921,448	58,822
Heavy Heavy Sleeper Cab Tractors .....	14,290,255	.....
<b>Total .....</b>	<b>29,088,598</b>	<b>221,975</b>

The aggregate technology costs resulting from the proposed changes in the MY 2027 standards are shown in Table XI-16. The average costs per vehicle represent the technology package costs developed for conventional vehicles to meet the HD

GHG Phase 2 standards. The projected sales in MY 2027 were generated from MOVES3. The percentage of conventional vehicles needed to improve to meet the proposed revised standards are approximately five percent, as discussed in Section XI.C.

The aggregated technology cost in MY 2027 of the proposed revised standards is approximately \$98 million. This compares to the MY 2027 technology costs of the HD GHG Phase 2 rule of \$5.2 billion (2013\$).<sup>889</sup> We request comment on this cost analysis.

TABLE XI-16—TECHNOLOGY COST DUE TO PROPOSED INCREASE IN EMISSION STANDARD STRINGENCY

	Projected sales in MY 2027	Percentage of conventional vehicles affected (%)	Number of conventional vehicles affected	Phase 2 technology cost per vehicle (2013\$) <sup>a</sup>	Total cost (2013\$ millions)
Light Heavy Vocational .....	141,716	5	7,086	\$2,533	\$17.9
Medium Heavy Vocational .....	180,432	5	9,021	2,727	24.6
Heavy Heavy Vocational .....	138,453	5	6,923	4,151	28.7
Medium Heavy Day Cab Tractors .....	10,558	5	528	10,235	5.4
Heavy Heavy Day Cab Tractors .....	41,334	5	2,067	10,439	21.6
<b>Total .....</b>	.....	.....	.....	.....	<b>98</b>

<sup>a</sup>81 FR 73620 and 73716 (October 25, 2016) noting the Urban subcategory costs.

<sup>887</sup> Memo to Docket. HD 2027 Proposed Changes to Heavy-Duty Greenhouse Gas Emissions. November 2021.

<sup>888</sup> The U.S. District Court for the Western District of Louisiana has issued an injunction concerning

the monetization of the benefits of greenhouse gas emission reductions by EPA and other defendants. See *Louisiana v. Biden*, No. 21-cv-01074-JDC-KK (W.D. La. Feb. 11, 2022).

<sup>889</sup> U.S. EPA and NHTSA. "Regulatory Impact Analysis: Greenhouse Gas Emission and Fuel Efficiency Standards for Medium- and Heavy-Duty Vehicles—Phase 2." EPA-420-R-16-900. August 2016. Page 7-21.

### F. Summary of Proposed Changes to HD GHG Phase 2

In summary, we are proposing some updates to the existing HD GHG Phase 2 and seeking comment on other potential changes. First, we propose to reduce the MY 2027 CO<sub>2</sub> emission standards for the compression-ignition vocational vehicles subcategories, the optional school bus and other bus subcategories, and the day cab tractor subcategories. We are also considering whether it would be appropriate in the final rule to increase the stringency of the standards even more than what we propose, specifically for MYs 2027, 2028, and/or 2029. Second, we seek comment on three different approaches to potentially revise the credits generated by a manufacturer's use of the advanced technology credit multipliers for battery electric vehicles in MY 2024 through MY 2027. We request comments about all aspects of these proposed updates to the CO<sub>2</sub> emission standards and revisions under consideration for the advanced technology incentive program.

### XII. Other Amendments

This section describes several amendments to correct, clarify, and streamline a wide range of regulatory provisions for many different types of engines, vehicles, and equipment.<sup>890</sup> Section XII.A includes technical amendments to compliance provisions that apply broadly across EPA's emission control programs to multiple industry sectors, including light-duty vehicles, light-duty trucks, marine diesel engines, locomotives, and various types of nonroad engines, vehicles, and equipment. Some of those amendments are for broadly applicable testing and compliance provisions in 40 CFR parts 1065, 1066, and 1068. Other cross-sector issues involve making the same or similar changes in multiple standard-setting parts for individual industry sectors.

We are proposing amendments in two areas of note for the general compliance provisions in 40 CFR part 1068. First, we are proposing to take a comprehensive approach for making confidentiality determinations related to compliance information that companies submit to EPA. We are proposing to apply these provisions for all highway, nonroad, and stationary engine, vehicle, and equipment programs, as well as

<sup>890</sup> A docket memo includes redline text to highlight all the changes to the regulations in the proposed rule. See "Redline Document Showing Proposed Changes to Regulatory Text in the Heavy-Duty 2027 Rule", EPA memorandum from Alan Stout to Docket EPA-HQ-OAR-2019-0055.

aircraft and portable fuel containers. Second, we are proposing provisions that include clarifying text to establish what qualifies as an adjustable parameter and to identify the practically adjustable range for those adjustable parameters. The adjustable parameters proposal also includes specific provisions related to electronic controls that aim to deter tampering.

The rest of Section XII describes proposed amendments that apply uniquely for individual industry sectors. These proposed amendments would apply to heavy-duty highway engines and vehicles, light-duty motor vehicles, large nonroad SI engines, small nonroad SI engines, recreational vehicles and nonroad equipment, marine diesel engines, locomotives, and stationary emergency CI engines.

#### A. General Compliance Provisions (40 CFR Part 1068) and Other Cross-Sector Issues

The regulations in 40 CFR part 1068 include compliance provisions that apply broadly across EPA's emission control programs for engines, vehicles, and equipment. This section describes several proposed amendments to these regulations. This section also includes amendments that make the same or similar changes in multiple standard-setting parts for individual industry sectors. The following sections describe these cross-sector issues.

##### 1. Proposed Confidentiality Determinations

EPA adopts emission standards and corresponding certification requirements and compliance provisions that apply to on-highway CI and SI engines (such as those proposed in this action for on-highway heavy-duty engines) and vehicles, and to stationary and nonroad CI and SI engines, vehicles, and equipment. Nonroad applications include marine engines, locomotives, and a wide range of other land-based vehicles and equipment. Standards and certification requirements also apply for portable fuel containers and for fuel tanks and fuel lines used with some types of nonroad equipment. Standards and certification requirements also apply for stationary engines and equipment, such as generators and pumps. EPA also has emission standards for aircraft and aircraft engines. Hereinafter, these are all "sources." Under this proposal, certain information the manufacturers must submit under the standard-setting parts<sup>891</sup> for certification, compliance

<sup>891</sup> 40 CFR parts 2, 59, 60, 85, 86, 87, 1068, 1030, 1033, 1036, 1037, 1039, 1042, 1043, 1045, 1048,

oversight, and in response to certain enforcement activities<sup>892</sup> would be subject to disclosure to the public without further notice.

The CAA states that "[a]ny records, reports or information obtained under [section 114 and parts B and C of Subchapter II] shall be available to the public. . . ." <sup>893</sup> Thus, the CAA begins with a presumption that the information submitted to EPA will be available to be disclosed to the public.<sup>894</sup> It then provides a narrow exception to that presumption for information that "would divulge methods or processes entitled to protection as trade secrets. . . ." <sup>895</sup> The CAA then narrows this exception further by excluding "emission data" from the category of information eligible for confidential treatment. While the CAA does not define "emission data," EPA has done so by regulation at 40 CFR 2.301(a)(2)(i). EPA releases, on occasion, some of the information submitted under CAA sections 114 and 208 to parties outside of the Agency of its own volition, through responses to requests submitted under the Freedom of Information Act ("FOIA"),<sup>896</sup> or through civil litigation. Typically, manufacturers may claim some of the information is entitled to confidential treatment as confidential business information ("CBI"), which is exempt from disclosure under Exemption 4 of the FOIA.<sup>897</sup> Generally, when we have information that we intend to disclose publicly that is covered by a claim of confidentiality under FOIA Exemption 4, EPA has a process to make case-by-case or class determinations under 40 CFR part 2 to evaluate whether such information qualifies for confidential treatment under the exemption.<sup>898</sup>

This rulemaking proposes provisions regarding the confidentiality of information that is submitted for a wide range of engines, vehicles, and equipment that are subject to emission

1051, 1054, and 1060. These parts are hereinafter collectively referred to as "the standard-setting parts."

<sup>892</sup> We also receive numerous FOIAs for information once enforcement actions have concluded. In responding to those requests, to the extent the information corresponds to a category of certification or compliance information that we are proposing a determination for in this rulemaking, if finalized we would similarly consider such information emissions data or otherwise not entitled to confidential treatment, or CBI.

<sup>893</sup> CAA section 114(c) and 208(c); 42 U.S.C. 7414(c) and 7542(c).

<sup>894</sup> CAA section 114(c) and 208(c); 42 U.S.C. 7414(c) and 7542(c).

<sup>895</sup> CAA section 114(c) and 208(c); 42 U.S.C. 7414(c) and 7542(c).

<sup>896</sup> 5 U.S.C. 552.

<sup>897</sup> 5 U.S.C. 552(b)(4).

<sup>898</sup> 40 CFR 2.205.

standards and other requirements under the CAA. This includes motor vehicles and motor vehicle engines, nonroad engines and nonroad equipment, aircraft and aircraft engines, and stationary engines. It also includes portable fuel containers regulated under 40 CFR part 59, subpart F, and fuel tanks, fuel lines, and related fuel system components regulated under 40 CFR part 1060. The proposed regulatory provisions regarding confidentiality determinations for these products would be codified broadly in 40 CFR part 1068, with additional detailed provisions for specific sectors in the regulatory parts referenced in 40 CFR 1068.1. With this rulemaking, EPA is proposing to make categorical emission data and CBI determinations in advance through this notice and comment rulemaking for some information collected by EPA for engine, vehicle, and equipment certification and compliance, including information collected during certain enforcement actions.<sup>899</sup> At this time, we are not proposing to determine that any information is CBI or entitled to confidential treatment. We are proposing to maintain the 40 CFR part 2 process for the information we are not determining to be emission data or otherwise not entitled to confidential treatment in this rulemaking. As explained further below, the emission data and CBI determinations proposed in this action are intended to increase the efficiency with which the Agency responds to FOIA requests and to provide consistency in the treatment of the same or similar information collected under the standard-setting parts. We believe doing these determinations through this rulemaking will provide predictability for both information requesters and submitters. We also believe that the proposed emission data and CBI determinations will lead to greater transparency in the certification programs.

In 2013 EPA published CBI class determinations for information related to certification of engines and vehicles under the standard-setting parts.<sup>900</sup> These determinations established whether those particular classes of information were releasable or entitled

to treatment as CBI and could be instructive when making case-by-case determinations for other similar information within the framework of the CAA and the regulations. However, the determinations did not resolve all confidentiality questions regarding information submitted to the Agency for the standard-setting parts, and EPA receives numerous requests each year to disclose information that is not within the scope of these 2013 CBI class determinations.

Prior to this rulemaking, the Agency has followed the existing process in 40 CFR part 2 when making case-by-case or class confidentiality determinations. The part 2 CBI determination process is time consuming for information requesters, information submitters, and EPA. The determinations proposed in this rulemaking would allow EPA to process requests for information more quickly, as the Agency would not need to go through the part 2 process to make case-by-case determinations. Additionally, the proposed determinations would also provide predictability and consistency to information submitters on how EPA will treat their information. Finally, the part 2 CBI determination process is very resource-intensive for EPA, as it requires personnel in the program office to draft letters to the manufacturers (of which there may be many) requesting that they substantiate their claims of confidentiality, review each manufacturer's substantiation response, and provide a recommendation, and for the Office of General Counsel to review all of the materials and make a final determination on the entitlement of the information to confidential treatment. For these reasons, we are proposing to amend our regulations in 40 CFR parts 2 and 1068 to establish a broadly applicable set of CBI determinations by categories of information, through rulemaking. With this action, we propose to supersede the class determinations made in 2013, though we intend this rulemaking to be consistent with the 2013 class determinations for Tables 1 and 2. Specifically, the CBI class determinations reflected in Table 1 and Table 2 of the 2013 determination are consistent with the proposed determinations described in Section XII.A.1.i and Section XII.A.1.iii, respectively. However, for the reasons described in Section XII.A.1.iv, we propose that the information in Table 3 of the 2013 determination will be subject to the existing part 2 process, such that EPA would continue to make

case-by-case CBI determinations as described below in Section XII.A.1.iv.

In this action, EPA is proposing regulations to establish categories for the information submitted under the standard-setting parts and to determine whether such categories of information are entitled to confidential treatment, including proposed revisions to 40 CFR parts 2, 59, 60, 85, 86, 87, 1030, 1033, 1036, 1037, 1043, 1045, 1048, 1051, 1054, 1060, and 1068. The proposed confidentiality determinations for these categories, and the basis for such proposed determinations, are described below. Additionally, a detailed description of the specific information submitted under the standard-setting parts that currently falls within these categories is also available in the docket for this rulemaking.<sup>901</sup> The proposed determinations made in this rulemaking, if finalized, will serve as notification of the Agency's decisions on (1) the categories of information the Agency will not treat as confidential, and (2) the categories of information that may be claimed as confidential but will remain subject to the existing part 2 process. We are not proposing in this rulemaking to make a determination in favor of confidential treatment for any information collected for certification and compliance of engines, vehicles, equipment, and products subject to evaporative emission standards. In responding to requests for information not determined in this proposal to be emission data or otherwise not entitled to confidential treatment, we propose to apply the existing part 2 case-by-case process.

For future use, we are proposing provisions in the Agency's Clean Air Act-specific FOIA regulations at 40 CFR 2.301(j)(2) and 2.301(j)(4) concerning information determined to be entitled to confidential treatment through rulemaking in 40 CFR part 1068. These provisions are very similar to the regulations established by the Greenhouse Gas Reporting Program from 40 CFR part 98 that is addressed at 40 CFR 2.301(d). The proposed regulation at 40 CFR 2.301(j)(4)(ii) is intended for the Agency to reconsider a determination that information is entitled to confidential treatment under 40 CFR 2.204(d)(2) if there is a change in circumstance in the future. This provision is intended to maintain flexibility the Agency currently has

<sup>899</sup> Throughout this preamble, we refer to certification and compliance information. Hereinafter, the enforcement information covered by this proposed confidentiality determination is included when we refer to certification and compliance information.

<sup>900</sup> EPA, Class Determination 1–13, Confidentiality of Business Information Submitted in Certification Applications for 2013 and subsequent model year Vehicles, Engines and Equipment, March 28, 2013, available at [https://www.epa.gov/sites/default/files/2020-02/documents/1-2013\\_class\\_determination.pdf](https://www.epa.gov/sites/default/files/2020-02/documents/1-2013_class_determination.pdf).

<sup>901</sup> See Zaremski, Sara. Memorandum to docket EPA–HQ–OAR–2019–0055. “Supplemental Information for CBI Categories for All Industries and All Programs”. October 1, 2021, and attachment “CBI Categories for All Industries All Programs” (hereinafter “CBI Chart”), available in the docket for this action.

under its part 2 regulations. These proposed regulations at 40 CFR 2.301(j)(2) and (4) do not have any effect at this time since the Agency is not proposing to find any information to be entitled to confidential treatment in this rulemaking, but are being proposed for future use.

The information categories we are proposing in this action are:

- (1) Certification and compliance information,
- (2) fleet value information,
- (3) source family information,
- (4) test information and results,
- (5) averaging, banking, and trading (“ABT”) credit information,
- (6) production volume information,
- (7) defect and recall information, and
- (8) selective enforcement audit (“SEA”) compliance information.

The information submitted to EPA under the standard-setting parts can be grouped in these categories based on their shared characteristics. That said, much of the information submitted under the standard-setting parts could be logically grouped into more than one category. For the sake of organization, we have chosen to label information as being in just one category where we think it fits best. We believe this approach will promote greater accessibility to the CBI determinations proposed here, reduce redundancy within the categories that could lead to confusion, and ensure consistency in the treatment of similar information in the future. We are requesting comment on the following: (1) Our proposed categories of information; (2) the proposed confidentiality determination on each category; and (3) our placement of each data point under the category proposed.

**i. Information That Is Emission Data and Therefore Not Entitled to Confidential Treatment.**

In this proposal, we are applying the regulatory definition of “emission data” in 40 CFR 2.301(a)(2)(i) to propose that certain categories of source certification and compliance information are not entitled to confidential treatment. As relevant here, a source is generally the engine, vehicle, or equipment covered by a certificate of conformity. Alternatively, a source is each individual engine, vehicle, or equipment produced under a certificate of conformity. The CAA provides in sections 114 and 208 that certain information may be entitled to confidential treatment; however, it expressly excludes emission data from that category of information. The CAA does not define “emission data,” but

EPA has done so by regulation in 40 CFR 2.301(a)(2)(i).

Agency regulations broadly define emission data as information that falls into one or more of three types of information. Specifically, emission data is defined in 40 CFR 2.301(a)(2)(i), for any source of emission of any substance into the air as:

- Information necessary to determine the identity, amount, frequency, concentration, or other characteristics (to the extent related to air quality) of any emission which has been emitted by the source (or of any pollutant resulting from any emission by the source), or any combination of the foregoing;
- Information necessary to determine the identity, amount, frequency, concentration, or other characteristics (to the extent related to air quality) of the emissions which, under an applicable standard or limitation, the source was authorized to emit (including, to the extent necessary for such purposes, a description of the manner or rate of operation of the source); and
- A general description of the location and/or nature of the source to the extent necessary to identify the source and to distinguish it from other sources (including, to the extent necessary for such purposes, a description of the device, installation, or operation constituting the source).

However, 40 CFR 2.301(a)(2)(ii) additionally provides a limitation on the timing of any release to the public of emission data concerning “any product, method, device, or installation (or any component thereof) designed and intended to be marketed or used commercially but not yet so marketed or used.” Consistent with this limitation, and as described in Sections XII.A.1.i and iii, we are proposing to maintain confidential treatment prior to the introduction-into-commerce date for the information included in an application for certification. Though we are proposing that the information in these categories is emission data, we are proposing that the information would not become subject to release until the product for which the information was submitted has been introduced into commerce, consistent with 40 CFR 2.301(a)(2)(ii). The introduction to commerce date is specified in an application for certification, unless a certificate of conformity is issued after the introduction-into-commerce date, at which point we propose to use the date of certificate issuance as the introduction-into-commerce date, as stated in the proposed 40 CFR 1068.10(d)(1).

We are proposing to establish in 40 CFR 1068.11(a) that certain categories of information the Agency collects in connection with the Title II programs are information that meets the regulatory definition of emission data under 40 CFR 2.301(a)(2)(i). The following sections describe the categories of information we are proposing to determine to be emission data, based on application of the definition at 40 CFR 2.301(a)(2)(i) to the shared characteristics of the information in each category and our rationale for each proposed determination. The CBI Chart in the docket provides a comprehensive list of the current regulatory citations under which we collect the information that we propose to group into each proposed category and can be found in the docket for this proposal. For ease of reference, we have also indicated in the CBI Chart the reason(s) explained in Sections XII.A.1 and 3 of this proposal for why the information submitted to EPA would not be considered confidential. The CBI Chart provides the information EPA currently collects that is covered by this proposed determination, the regulatory citation the information is collected under, the information category we propose for the information, the confidentiality determination for the information, and the rationale used to determine whether the information is not entitled to confidential treatment (*i.e.*, the information qualifies as emission data under one or more subparagraph of the regulatory definition of emission data, is both emission data and publicly available after the introduction-into-commerce-date, etc.). We explain in this proposal that much of the information covered by these proposed determinations are emission data under more than one basis under the regulatory definition of emission data, as described at the end of each of the sections that follow, where each basis alone would support EPA finalizing a given proposed determination. Therefore, we request that commenters provide responses to every rationale presented in the CBI Chart, available in the docket, for information we are proposing to determine is emission data.

a. Information Necessary To Determine the Identity, Amount, Frequency, Concentration, or Other Characteristics (to the Extent Related to Air Quality) of Any Emission Which Has Been Emitted by the Source (or of Any Pollutant Resulting From Any Emission by the Source), or Any Combination of the Foregoing

We are proposing the categories of information identified and proposing to determine that the information in them meets the regulatory definition of emission data under 40 CFR 2.301(a)(2)(i)(A), which defines emission data to include “[i]nformation necessary to determine the identity, amount, frequency, concentration, or other characteristics (to the extent related to air quality) of any emission which has been emitted by the source (or of any pollutant resulting from any emission by the source), or any combination of the foregoing[.]”<sup>902</sup> For shorthand convenience, we refer to information that qualifies as emission data under subparagraph (A) in the definition of emission data as merely “paragraph A information.”

EPA collects emission information during certification, compliance reporting, SEAs, defect and recall reporting, in ABT programs, and in various testing programs like production line testing (“PLT”) and in-use testing. We are proposing that the following categories of information are emission data under 40 CFR 2.301(a)(2)(i)(A):

- (1) Fleet value information,
- (2) test information and results (including certification testing, PLT, in-use testing, fuel economy testing, and SEA testing),
- (3) ABT credit information,
- (4) production volume,
- (5) defect and recall information, and
- (6) SEA compliance information.

All these categories include information that fits under the other emission data regulatory definition subparagraphs, therefore, the lists in this section are not exhaustive of the information in each category. We are proposing that the paragraph A information we identify in this section under each of the categories is also emission data under subparagraph (B) of the definition of emission data and may also be emission data under subparagraph (C) of the definition of emission data. In the CBI Chart in the docket, we have identified for every piece of information in every category all the applicable emission data definition subparagraphs. Nevertheless, under this proposal, we have chosen to

explain each piece of information in detail only under the most readily understandable subparagraph of emission data, while highlighting that the information could also qualify as emission data under another subparagraph of the regulatory definition of emission data. Consistent with 40 CFR 2.301(a)(2)(ii), under this proposed determination, we would not release information included in an application for certification prior to the introduction-into-commerce-date, except under the limited circumstances already provided for in that regulatory provision. The introduction-into-commerce-date is specified in an application for certification or in the certificate itself, if the certificate is issued after the introduction-into-commerce-date.

*Fleet Value Information:* We are proposing that the fleet value information category includes the following information that underlies the ABT compliance demonstrations and fleet average compliance information for on-highway and nonroad: Offsets, displacement, useful life, power payload tons, load factor, integrated cycle work, cycle conversion factor, and test cycle. The information in this proposed category underlies the fleet average calculations, which are necessary to understand the type and amount of emissions released in-use from sources regulated under the standard-setting parts that require a fleet average compliance value. These values represent compounds emitted, though the raw emissions from an individual source may be different from these values due to other variables in the fleet value calculation. For these reasons, we propose to determine the fleet value information category is emission data because it is necessary to identify and determine the amount of emissions emitted by sources.<sup>903</sup> Note, we are also proposing that a portion of the fleet value information category meets another basis in the emission data definition, as discussed in more detail in Section XII.A.1.i.b, as it additionally provides “[i]nformation necessary to determine the identity, amount, frequency, concentration, or other characteristics (to the extent related to air quality) of the emissions which, under an applicable standard or limitation, the source was authorized to emit (including, to the extent necessary for such purposes, a description of the manner or rate of operation of the source)[.]”<sup>904</sup>

*Test Information and Results:* The proposed test information and results category includes information collected during the certification process, PLT testing, in-use testing programs, testing to determine fuel economy, and testing performed during an SEA. This category encompasses the actual test results themselves and information necessary to understand how the test was conducted, and other information to fully understand the results. We are proposing to include in the test information and results category the certification test results information, including emission test results which are required under the standard-setting parts. Before introducing a source into commerce, manufacturers must certify that the source meets the applicable emission standards and emissions related requirements. To do this, manufacturers conduct specified testing during the useful life of a source and submit information related to those tests. Emission test results are a straightforward example of emission data, as they identify and measure the compounds emitted from the source during the test. Furthermore, the tests were designed and are performed for the explicit purpose of determining the identity, amount, frequency, concentration, or other air quality characteristics of emissions from a source. For these reasons, we propose to determine that test information and results category is emission data because it is necessary to determine the emissions emitted by a source.<sup>905</sup> We are also proposing that all the information in the test information and results category, except fuel label information, meets another basis in the emission data definition, as it is also “[i]nformation necessary to determine the identity, amount, frequency, concentration, or other characteristics (to the extent related to air quality) of the emissions which, under an applicable standard or limitation, the source was authorized to emit (including, to the extent necessary for such purposes, a description of the manner or rate of operation of the source)[.]”<sup>906</sup> See Section XII.A.1.i.b for a more detailed discussion for issues related to test information and results. See Section XII.A.1.iv for additional discussion of fuel label information.

The following test information and results are collected from the PLT program: (1) For CI engines and vehicles: CO results, particulate matter (PM) results, NO<sub>x</sub> results, NO<sub>x</sub> + HC results, and HC results, and (2) for SI

<sup>902</sup> 40 CFR 2.301(a)(2)(i)(A).

<sup>903</sup> Id.

<sup>904</sup> 40 CFR 2.301(a)(2)(i)(B).

<sup>905</sup> 40 CFR 2.301(a)(2)(i)(A).

<sup>906</sup> 40 CFR 2.301(a)(2)(i)(B).

engines and vehicles and for products subject to the evaporative emission standards: Fuel type used, number of test periods, actual production per test period, adjustments, modifications, maintenance, test number, test duration, test date, end test period date, service hours accumulated, test cycle, number of failed engines, initial test results, final test results, and cumulative summation. Production line testing is conducted under the standard-setting parts to ensure that the sources produced conform to the certificate issued. PLT results are emission test results and, for that reason, are among the most straightforward examples of emission data, as they identify and measure the compounds emitted from the source during the test. For example, the measured amounts of specified compounds (like HC results, CO results, and PM results) are measured emissions, the literal results of testing. Similarly, the number of failed engines is emission data as it reflects the results of emissions testing. Additionally, adjustments, modifications, maintenance, and service hours accumulated are information necessary for understanding the test results. We propose that the information listed in this paragraph is necessary to understand the context and conditions in which the test was performed, like test number, test duration, test date, number of test periods, actual production per test period, end test period, and is, therefore, emission data because it is information necessary for understanding the characteristics of the test as performed, the test results, and the information that goes into the emissions calculations. Furthermore, PLT is performed for the explicit purpose of determining the identity, amount, frequency, concentration, or other air quality characteristics of emissions from a source. For these reasons, we propose to determine that test information and results category is emission data because it is necessary to determine the emissions emitted by a source.<sup>907</sup> Note, we are also proposing that the PLT information in the test information and results category meets another basis in the emission data definition, as discussed in more detail in Section XII.A.1.i.b, as it additionally provides “[i]nformation necessary to determine the identity, amount, frequency, concentration, or other characteristics (to the extent related to air quality) of the emissions which, under an applicable standard or limitation, the source was authorized to emit (including, to the extent necessary

for such purposes, a description of the manner or rate of operation of the source)[.]”<sup>908</sup>

The proposed test information and results category also includes the following information from the in-use testing program: A description of how the manufacturer recruited vehicles, the criteria use to recruit vehicles, the rejected vehicles and the reason they were rejected, test number, test date and time, test duration and shift-days of testing, weather conditions during testing (ambient temperature and humidity, atmospheric pressure, and dewpoint), differential back pressure, results from all emissions testing, total hydrocarbons (HC), NMHC, carbon monoxide, carbon dioxide, oxygen, NO<sub>x</sub>, PM, and methane, applicable test phase (Phase 1 or Phase 2), adjustments, modifications, repairs, maintenance history, vehicle mileage at start of test, fuel test results, total lifetime operating hours, total non-idle operation hours, a description of vehicle operation during testing, number of valid Not to Exceed (NTE) events, exhaust flow measurements, recorded one-hertz test data, number of engines passed, vehicle pass ratio, number of engines failed, outcome of Phase 1 testing, testing to determine why a source failed, the number of incomplete or invalid tests, usage hours and use history, vehicle on board diagnostic (“OBD”) system history, engine diagnostic system, number of disqualified engines, and number of invalid tests. The in-use testing information includes actual test results and the information that goes into the emissions calculations. For example, the measured amounts of specified compounds (like total HC) are measured emissions, and adjustments, modifications, and repairs are information necessary for understanding the test results. It is necessary to know if and how a source has changed from its certified condition during its use, as these changes may impact the source’s emissions. Total lifetime operating hours and usage hours information is also used to calculate emissions during in-use testing. The diagnostic system information is necessary for understanding emissions, as well, because it provides context to and explains the test results; if an issue or question arises from the in-use testing, the diagnostic system information allows for greater understanding of the emissions performance. Additionally, the number of disqualified engines is necessary to determine the sources tested, if an end user has modified the source such that it cannot be used for

in-use testing, this directly relates to the sources eligible for in-use testing and the emission measurements resulting from those tests. For these reasons, we propose to determine that the in-use testing information is emission data because it is necessary to determine the emissions emitted by sources.<sup>909</sup> Note, we are also proposing that the in-use testing information meets another basis in the emission data definition, as discussed in more detail in Section XII.A.1.i.b, as it additionally provides “[i]nformation necessary to determine the identity, amount, frequency, concentration, or other characteristics (to the extent related to air quality) of the emissions which, under an applicable standard or limitation, the source was authorized to emit (including, to the extent necessary for such purposes, a description of the manner or rate of operation of the source)[.]”<sup>910</sup>

We are also proposing that the test information and results category include the underlying information necessary to determine the adjusted and rounded fuel economy label values and the resulting label values. The underlying information includes test result values that are plugged into a calculation included in the standard-setting parts that establish the fuel economy rating. These results represent emissions, the rate at which they are released, and are necessary to understanding the fuel economy rating. For these reasons, we propose that the fuel economy label information is appropriately included in the test information and results category. Accordingly, we propose to determine that fuel economy label information is emission data because it is necessary to determine the emissions emitted by sources.<sup>911</sup> Note, we are also proposing that a portion of the fuel economy label information is not entitled to confidential treatment because it is required to be publicly available and is discussed in more detail in Section XII.A.1.iii. We are proposing in this rulemaking to supersede the 2013 class determination Table 3 for all fuel economy label information, but our proposed CBI determination here applies only to a portion of the fuel economy label information, as explained in Section XII.A.1.iv.

We are proposing that the test information and results category include the following information from SEA testing: The test procedure, initial test results, rounded test results, final test results, final deteriorated test results,

<sup>909</sup> 40 CFR 2.301(a)(2)(i)(A).

<sup>910</sup> 40 CFR 2.301(a)(2)(i)(B).

<sup>911</sup> 40 CFR 2.301(a)(2)(i)(A).

<sup>907</sup> 40 CFR 2.301(a)(2)(i)(A).

<sup>908</sup> 40 CFR 2.301(a)(2)(i)(B).



the number of valid tests conducted, the number of invalid tests conducted, adjustments, modifications, repairs, test article preparation, test article maintenance, and the number of failed engines and vehicles. SEAs can be required of manufacturers that obtain certificates of conformity for their engines, vehicles, and equipment. SEA test information includes emission test results from tests performed on production engines and equipment covered by a certificate of conformity. These tests measure the emissions emitted from the test articles; therefore, we propose that they are emission data and not entitled to confidentiality. The information supporting the test results, such as the number of valid tests conducted, the adjustments, modifications, repairs, and maintenance regarding the test article, is necessary to understand the test results and is, therefore, also emission data. For these reasons, we also propose to determine that SEA test information is appropriately grouped in test information and results category and is emission data because it is necessary to identify and determine the amount of emissions from a source.<sup>912</sup> The SEA test information, like all the information in the test information and results category, is also emission data under another basis in the emission data definition, as discussed in more detail in Section XII.A.1.i.b, as it provides “[i]nformation necessary to determine the identity, amount, frequency, concentration, or other characteristics (to the extent related to air quality) of the emissions which, under an applicable standard or limitation, the source was authorized to emit (including, to the extent necessary for such purposes, a description of the manner or rate of operation of the source)[.]”<sup>913</sup>

*Production Volume:* We are proposing to determine that the production volume category is emission data and is not entitled to confidential treatment because the information is necessary to determine the total emissions emitted by the source, where the source is the type of engine, vehicle, or equipment covered by a certificate of conformity. The certificate of conformity for a source does not, on its face, provide aggregate emissions information for all of the sources covered by that certificate. Rather, it provides information relative to each single unit of the source covered by a certificate. The production volume is necessary to understand the amount, frequency, and

concentration of emissions emitted from the aggregate of units covered by a single certificate that comprise the source. In other words, unless there will only ever be one single engine, vehicle, or equipment covered by the certificate of conformity, the emissions from that source will not be expressed by the certificate and compliance information alone. The total number of engines, vehicles, or equipment produced, in combination with the certificate information, is necessary to know the real-world impact on emissions from that source. Additionally, the production volume is also collected for the purpose of emission modeling. For example, engine population (the number of engines in use) is used in the non-road emissions model to establish emission standards. Production volume, when used in combination with the other emission data we collect (certification test results, in-use test results, defects and recalls, etc.), also allows EPA and independent third parties to calculate total mobile source air emissions. For these reasons, production volume is “necessary to determine the identity, amount, frequency, concentration, or other characteristics (to the extent related to air quality) of any emission which has been emitted by the source (or of any pollutant resulting from any emission by the source), or any combination of the foregoing[.]”<sup>914</sup> Note, we are also proposing to determine that the production volume category meets another basis in the emission data definition, as discussed in more detail in Section XII.A.1.i.c, as it additionally provides “[a] general description of the location and/or nature of the source to the extent necessary to identify the source and to distinguish it from other sources (including, to the extent necessary for such purposes, a description of the device, installation, or operation constituting the source).”<sup>915</sup>

*Defect and Recall Information:* We propose to determine that the defect and recall information category is emission data and not entitled to confidential treatment because it is information necessary to determine the emissions from a source that has been issued a certificate of conformity.<sup>916</sup> The only defects and recalls that manufacturers or certificate holders are required to report to EPA are ones that impact emissions or could impact emissions. Therefore, if a defect or recall is reported to us, it is because it causes or may cause increased emissions and information

relating to that defect or recall is necessarily emission data, as it directly relates to the source’s emissions. The proposed defect and recall information category includes any reported emission data available. This information is the available test results that a manufacturer has after conducting emission testing, and an estimate of the defect’s impact on emissions, with an explanation of how the manufacturer calculated this estimate and a summary of any available emission data demonstrating the impact of the defect. Note, we are only proposing to determine that a portion of the defect and recall information category is paragraph A information. As discussed in Section XII.A.1.iv, we are not proposing to make a confidentiality determination on the defect investigation report at this time. We are also proposing to determine that the information in this category, excluding the defect investigation report, meets another basis in the emission data definition, as discussed in more detail in Section XII.A.1.i.b, as it additionally provides “[i]nformation necessary to determine the identity, amount, frequency, concentration, or other characteristics (to the extent related to air quality) of the emissions which, under an applicable standard or limitation, the source was authorized to emit (including, to the extent necessary for such purposes, a description of the manner or rate of operation of the source)[.]”<sup>917</sup>

As noted throughout this section, the information included in the proposed categories identified as paragraph A information could also meet another prong of the definition of emission data.<sup>918</sup> See Section XII.A.1.i.b for our discussion of why we are proposing that this information could also be emission data as defined at 40 CFR 2.301(a)(2)(i)(B). See Section XII.A.1.i.c for our discussion of why we are proposing that this information could also be emission data as defined at 40 CFR 2.301(a)(2)(i)(C).

**b. Information Necessary To Determine the Identity, Amount, Frequency, Concentration, or Other Characteristics (to the Extent Related to Air Quality) of the Emissions Which, Under an Applicable Standard or Limitation, the Source Was Authorized To Emit (Including, to the Extent Necessary for Such Purposes, a Description of the Manner or Rate of Operation of the Source)**

We are proposing that information within the proposed categories

<sup>912</sup> Id.

<sup>913</sup> 40 CFR 2.301(a)(2)(i)(B).

<sup>914</sup> 40 CFR 2.301(a)(2)(i)(A).

<sup>915</sup> 40 CFR 2.301(a)(2)(i)(C).

<sup>916</sup> 40 CFR 2.301(a)(2)(i)(A).

<sup>917</sup> 40 CFR 2.301(a)(2)(i)(B) and (C).

<sup>918</sup> 40 CFR 2.301(a)(2)(i)(B).

explained in this subsection meets the regulatory definition of emission data under 40 CFR 2.301(a)(2)(i)(B) because it is “[i]nformation necessary to determine the identity, amount, frequency, concentration, or other characteristics (to the extent related to air quality) of the emissions which, under an applicable standard or limitation, the source was authorized to emit (including, to the extent necessary for such purposes, a description of the manner or rate of operation of the source)[.]” We will refer to subparagraph (B) in the definition of emission data as “paragraph B information” throughout this section.

The vast majority of the information we collect for certification and compliance fits within this subparagraph of the definition of emission data. We are proposing that the following categories are paragraph B information and not entitled to confidential treatment: (1) Certification and compliance information, (2) ABT credit information, (3) fleet value information, (4) production volumes, (5) test information and results, (6) defect and recall information, and (7) SEA compliance information. These categories are summarized here and described in more detail below. Certification and compliance information category includes information that is submitted in manufacturers’ certificate of conformity applications and information reported after the certificate is issued to ensure compliance with both the certificate and the applicable standards, which is required under EPA’s regulation. ABT credit information shows whether a manufacturer participating in an ABT program has complied with the applicable regulatory standards. Additionally, fleet value information is collected in order to calculate average and total emissions for a fleet of sources, thereby demonstrating compliance with the applicable regulatory standards when a manufacturer participates in an ABT program or for fleet averaging programs. A portion of the test and test result category of information is distinguishable under the paragraph A information basis. This portion of the test information and results category includes information that explains how the tests and test results demonstrate compliance with the applicable standards and is identified and discussed in this section. The test information and results described in Section XII.A.1.i.a is also necessary to understand whether a source is in compliance with the applicable standard-setting parts; however, we are

only describing information once in this preamble, though it may qualify under more than one subparagraph of the emission data definition. The SEA compliance information category includes information related to understanding how the results of the SEA reflect whether a source was in compliance with the applicable standard-setting parts. Consistent with 40 CFR 2.301(a)(2)(ii), under this proposed determination, we would not release information included in an application for certification prior to the introduction-into-commerce-date, except under the limited circumstances already provided for in that regulatory provision. The introduction-into-commerce-date is specified in an application for certification, or in the certificate itself if the certificate is issued after the introduction-into-commerce-date.

These categories apply to information submitted for certification and compliance reporting across the standard-setting parts. These categories make up the largest amount of information addressed by the proposed confidentiality determinations.

*Certification and Compliance Information:* Once a source is certified as conforming to applicable emission standards (*i.e.*, the source has a certificate of conformity), all sources the manufacturer produces under that certificate must conform to the requirements of the certificate for the useful life of the source. In short, a source’s compliance is demonstrated against the applicable certificate of conformity through inspection and testing conducted by EPA and the manufacturers. Therefore, certification and compliance information falls under subparagraph B of emission data because it is “necessary to determine the identity, amount, frequency, concentration, or other characteristic (to the extent related to air quality) of the emissions which, under an applicable standard or limitation, the source was authorized to emit (including, to the extent necessary for such purposes, a description of the manner or rate of operation of the source)[.]”<sup>919</sup> The certification and compliance information category includes models and parts information, family determinants, general emission control system information, and certificate request information (date, requester, etc.), contact names, importers, agents of service, and ports of entry used. The models and parts information is necessary to determine that the sources actually manufactured conform to the

specifications of the certificate. Lastly, certificate request information is general information necessary to identify the applicable certificate of conformity for a source, as well as understanding the timing and processing of the request. For these reasons, we propose to determine certificate information is necessary to determine whether a source has achieved compliance with the applicable standards.<sup>920</sup> Note, we are also proposing that a portion of the category of certification and compliance information meets another basis in the emission data definition, as discussed in more detail in Section XII.A.1.i.c, as it additionally provides “[a] general description of the location and/or nature of the source to the extent necessary to identify the source and to distinguish it from other sources (including, to the extent necessary for such purposes, a description of the device, installation, or operation constituting the source).”<sup>921</sup>

*ABT Credit Information:* ABT programs are an option for compliance with certain emissions standards. In ABT programs, manufacturers may generate credits when they certify that their vehicles, engines, and equipment achieve greater emission reductions than the applicable standards require. “Averaging” within ABT programs means exchanging emission credits between vehicle or engine families within a given manufacturer’s regulatory subcategories and averaging sets. This can allow a manufacturer to certify one or more vehicle or engine families within the same averaging set at levels worse than the applicable emission standard under certain regulatory conditions. The increased emissions over the standard would need to be offset by one or more vehicle or engine families within that manufacturer’s averaging set that are certified better than the same emission standard, such that the average emissions from all the manufacturer’s vehicle or engine families, weighted by engine power, regulatory useful life, and production volume, are at or below the level required by the applicable standards. “Banking” means the retention of emission credits by the manufacturer for use in future model year averaging or trading. “Trading” means the exchange of emission credits between manufacturers, which can then be used for averaging purposes, banked for future use, or traded again to another manufacturer. The proposed ABT credit information category includes a manufacturer’s banked credits,

<sup>920</sup> Id.

<sup>921</sup> 40 CFR 2.301(a)(2)(i)(C).

<sup>919</sup> Id.

transferred credits, traded credits, total credits, credit balance, and annual credit balance. Because manufacturers participating in ABT programs use credits to demonstrate compliance with the applicable standards, ABT information is “necessary to determine the identity, amount, frequency, concentration, or other characteristic (to the extent related to air quality) of the emissions which, under an applicable standard or limitation, the source was authorized to emit (including, to the extent necessary for such purposes, a description of the manner or rate of operation of the source)[.]”<sup>922</sup> For these reasons, we propose to determine ABT credit information is emission data because it is necessary to determine whether a source has achieved compliance with the applicable standards.<sup>923</sup>

*Fleet Value Information:* ABT credit information must be reviewed in conjunction with the fleet value information, which underlies a manufacturer’s credit balance. The two categories are distinct from each other, though the information under the two categories is closely related. In addition to reasons described in Section XII.A.1.i.a, fleet value information is also used for compliance reporting under ABT programs, though some fleet value information is collected during certification for the on-highway sectors. The proposed fleet value information category includes: Source classification, averaging set, engine type or category, conversion factor, engine power, payload tons, intended application, advanced technology (“AT”) indicator, AT CO<sub>2</sub> emission, AT improvement factor, AT CO<sub>2</sub> benefit, innovative technology (“IT”) indicator, IT approval code, and IT CO<sub>2</sub> improvement factor. Additionally, the proposed fleet value information category includes the following for light-duty vehicles and engines, non-road SI engines, and products subject to evaporative emission standards: Total area of the internal surface of a fuel tank, adjustment factor, and deterioration factor. Fleet value information is used in ABT programs to explain and support a manufacturer’s ABT credit balance. For the standard-setting parts that require a fleet average compliance value, the fleet value information is used to demonstrate compliance with the applicable standard setting parts. For these reasons, we propose to determine that the fleet value information category is emission data because it is information necessary to understand the

ABT compliance demonstration and compliance with the fleet average value, as applicable.<sup>924</sup> Additionally, a portion of the fleet value information is emission data, as described in Section XII.A.1.i.a, because it is “necessary to determine the identity, amount, frequency, concentration, or other characteristics (to the extent related to air quality) of any emission which has been emitted by the source (or of any pollutant resulting from any emission by the source), or any combination of the foregoing[.]”<sup>925</sup>

*Production Volumes:* The production volume category is emission data because it is necessary to determine compliance with the standards when a manufacturer meets requirements in an ABT credit, PLT, or in-use testing program, and also for GHG fleet compliance assessment. When a manufacturer is subject to these programs, the production volume is necessary to determine whether that manufacturer has complied with the applicable standards and limitations. In ABT programs, the averages used to calculate credit balances are generated based on the production volumes of the various families certified. For GHG standards compliance, manufacturers comply based on their overall fleet average, therefore, the production volume is necessary to calculate the fleet average and whether the manufacturers’ fleet complies with the applicable standards. For these reasons, we propose that production volume information is necessary to understanding the calculations behind a manufacturer’s credit generation and use, as well as a manufacturer’s fleet average, which are then used to demonstrate compliance with the applicable standards.<sup>926</sup> Additionally, for PLT and in-use testing, production volumes are used to determine whether and how many sources are required to be tested or, in some cases, whether the testing program needs to be undertaken at all. In this way, production volume is tied to compliance with the PLT and in-use testing requirements and is paragraph B information necessary for demonstrating compliance with an applicable standard. Note, we are proposing to determine that the production volume category is emission data for multiple reasons, as discussed in Sections X.A.1.i.a and X.A.1.i.c.

*Test Information and Results:* The proposed test information and results category includes the testing conducted by manufacturers and is necessary to

demonstrate that the test parameters meet the requirements of the regulations. This ensures that the test results are reliable and consistent. If a test does not meet the requirements in the applicable regulations, then the results cannot be used for certification or compliance purposes. The parameters and underlying information of an emissions test is information necessary to understanding the test results themselves. Adjustable parameter information is necessary to understand the tests used to certify a source and, therefore, also necessary to understand the test results and whether the source achieved compliance with the applicable standard. For these reasons, we propose that the test information and results category is “necessary to determine the identity, amount, frequency, concentration, or other characteristic (to the extent related to air quality) of the emissions which, under an applicable standard or limitation, the source was authorized to emit (including, to the extent necessary for such purposes, a description of the manner or rate of operation of the source[.]”<sup>927</sup> Test information and results collected under the standard-setting parts includes the following: Test temperature, adjustable test parameters, exhaust emission standards and family emission limits (FELs), emission deterioration factors, fuel type used, intended application, CO standard, particulate matter (“PM”) standard, NO<sub>x</sub> + HC standard, NO<sub>x</sub> standard, HC standard, CO<sub>2</sub> alternate standard, alternate standard approval code, CO<sub>2</sub> family emission limit (“FEL”), CO<sub>2</sub> family certification level (“FCL”), NO<sub>x</sub> and NMHC + NO<sub>x</sub> standard, NO<sub>x</sub> and NMHC + NO<sub>x</sub> alternate standard, N<sub>2</sub>O standard, N<sub>2</sub>O FEL, CH<sub>4</sub> standard, CH<sub>4</sub> FEL, NO<sub>x</sub> or NMHC + NO<sub>x</sub> FEL, PM FEL, test number, test time, engine configuration, green engine factor, the test article’s service hours, the deterioration factor type, test location, test facility, the manufacturer’s test contact, fuel test results, vehicle mileage at the start of the test, exhaust aftertreatment temperatures, engine speed, engine brake torque, engine coolant temperature, intake manifold temperature and pressure, throttle position, parameter sensed, emission-control system controlled, fuel-injection timing, NTE threshold, limited testing region, meets vehicle pass criteria (*i.e.*, whether the test passes the applicable emission standard), number of engines tested, number of engines still needing to be tested, number of engines passed,

<sup>924</sup> Id.

<sup>925</sup> 40 CFR 2.301(a)(2)(i)(A).

<sup>926</sup> 40 CFR 2.301(a)(2)(i)(B).

<sup>927</sup> Id.

<sup>922</sup> 40 CFR 2.301(a)(2)(i)(B).

<sup>923</sup> Id.

purpose of diagnostics, instances for OBD illuminated or set trouble codes, instance of misfuelling, incomplete or invalid test information, the minimum tests required, diagnostic system, and the number of disqualified engines. For the reasons given, we propose to determine that test information and results is emission data because it is both necessary to understand how the source meets the applicable standards, including, but not limited to, ABT compliance demonstrations, and to ensure a source is complying with its certificate of conformity.<sup>928</sup>

Additionally, we are proposing that a portion of the information included in the test information and results category meets another basis in the emission data definition, as discussed in more detail in Section XII.A.1.i.a, as it is also “[i]nformation necessary to determine the identity, amount, frequency, concentration, or other characteristics (to the extent related to air quality) of any emission which has been emitted by the source (or of any pollutant resulting from any emission by the source), or any combination of the foregoing[.]”<sup>929</sup>

*Defect and Recall Information:* We propose to determine that the defect and recall information category is emission data and not entitled to confidential treatment because it is information necessary to determine compliance with an applicable standard or limitation.<sup>930</sup> The only defects and recalls that manufacturers are required to report to EPA are ones that impact emissions or could impact emissions. Therefore, if a defect is reported to us, it is because it causes or may cause increased emissions and information relating to that defect is necessarily emission data, as it directly relates to the source’s compliance with an applicable standard. The proposed defect and recall information category, including information collected under the standard-setting parts, includes: System compliance reporting type, EPA compliance report name, manufacturer compliance report, manufacturer compliance report identifier, contact identifier, process code, submission status, EPA submission status and last modified date, submission creator, submission creation date, last modified date, last modified by, EPA compliance report identifier, compliance report type, defect category, defect description, defect emissions impact estimate, defect remediation plan explanation, drivability problems description, emission data available indicator, OBD

MIL illumination indicator, defect identification source/method, plant address where defects were manufactured, certified sales area, carline manufacturer code, production start date, defect production end date, total production volume of affected engines or vehicles, estimated or potential number of engines or vehicles affected, actual number identified, estimated affected percentage, make, model, additional model identifier, specific displacement(s) impacted description, specific transmission(s) impacted description, related defect report identifier, related EPA defect report identifier, related defect description, remediation description, proposed remedy supporting information, description of the impact on fuel economy of defect remediation, description of the impact on drivability from remediation, description of the impact on safety from remediation, recalled source description, part availability method description, repair performance/maintenance description, repair instructions, nonconformity correction procedure description, nonconformity estimated correction date, defect remedy time, defect remedy facility, owner demonstration of repair eligibility description, owner determination method description, owner notification method description, owner notification start date, owner notification final date, number of units involved in recall, calendar quarter, calendar year, quarterly report number, related EPA recall report/remedial plan identifier, number of sources inspected, number of sources needing repair, number of sources receiving repair, number of sources ineligible due to improper maintenance, number of sources ineligible for repair due to exportation, number of sources ineligible for repair due to theft, number of sources ineligible for repair due to scrapping, number of sources ineligible for repair due to other reasons, additional owner notification indicator, and the number of owner notifications sent. We are not proposing to include defect investigation reports in this proposed category, and instead we propose to continue with the part 2 process as described in Section XII.A.1.iv for defect investigation reports. Additionally, we are proposing that a portion of the information included in this category meets another basis in the emission data definition, as discussed in more detail in Section XII.A.1.i.a, as it is also “[i]nformation necessary to determine the identity, amount, frequency, concentration, or other characteristics (to the extent

related to air quality) of any emission which has been emitted by the source (or of any pollutant resulting from any emission by the source), or any combination of the foregoing[.]”<sup>931</sup>

*SEA Compliance Information:* We are proposing that the SEA compliance information category is emission data because it is necessary to determine whether a source is in compliance with its certificate and the standards. This proposed category includes the facility name and location where the SEA was conducted, number of tests conducted, model year, build date, hours of operation, location of accumulated hours, the date the engines shipped, how the engines were stored, and, for imported engines, the port facility and date of arrival. This information collected through SEAs is necessary for determining whether a source that was investigated through an SEA is in compliance with the applicable standards. For that reason, EPA is proposing to make a determination that this category is emission data as defined at 40 CFR 2.301(a)(2)(i)(B). Additionally, certain information collected during an SEA is included in the test information and results category. We propose that SEA compliance information is emission data because it is both paragraph B information and “[i]nformation necessary to determine the identity, amount, frequency, concentration, or other characteristics (to the extent related to air quality) of any emission which has been emitted by the source (or of any pollutant resulting from any emission by the source), or any combination of the foregoing[.]”<sup>932</sup>

c. Information That Is Emission Data Because It Provides a General Description of the Location and/or Nature of the Source to the Extent Necessary To Identify the Source and To Distinguish It From Other Sources (Including, to the Extent Necessary for Such Purposes, a Description of the Device, Installation, or Operation Constituting the Source)

We are proposing that certain categories of information meet the regulatory definition of emission data under 40 CFR 2.301(a)(2)(i)(C) because they convey a “[g]eneral description of the location and/or nature of the source to the extent necessary to identify the source and to distinguish it from other sources (including, to the extent necessary for such purposes, a description of the device, installation, or

<sup>928</sup> Id.

<sup>929</sup> 40 CFR 2.301(a)(2)(i)(A).

<sup>930</sup> 40 CFR 2.301(a)(2)(i)(B).

<sup>931</sup> 40 CFR 2.301(a)(2)(i)(A).

<sup>932</sup> Id.

operation constituting the source).”<sup>933</sup> We will refer to subparagraph (C) in the definition of emission data as “paragraph C information” throughout this section. We are proposing that two categories of information fall primarily under this regulatory definition of emissions data: (1) Source family information, and (2) production volume information. We propose these categories are paragraph C information and are, therefore, emission data and would not be entitled to confidential treatment. However, under this proposed determination, consistent with 40 CFR 2.301(a)(2)(ii), we would not release information included in an application for certification prior to the introduction-into-commerce-date, except under the limited circumstances already provided for in that regulatory provision. The introduction-into-commerce-date is specified in an application for certification or in the certificate itself, if the certificate is issued after the introduction-into-commerce-date.

*Source Family Information:* The information included in the source family information category includes engine family information, vehicle family information, evaporative family information, equipment family information, subfamily name, engine family designation, emission family name, and test group information. The engine, vehicle, and evaporative family information includes information necessary to identify the emission source for which the certificate was issued; this determines the emission standards that apply to the source and distinguishes the source’s emissions from other sources. Manufacturers request certification using the family name of the engines, vehicles, or equipment they intend to produce for sale in the United States. Test group information identifies the sources tested and covered by a certificate. The source family is the basic unit used to identify a group of sources for certification and compliance purposes. The source family is a code with 12 digits that identifies all parts of that particular source. More specifically, information conveyed in the source family code include the model year, manufacturer, industry sector, engine displacement, and the manufacturer’s self-designated code for the source family. We are proposing that the source family information category of information is emission data because it is information that provides a “[g]eneral description of the location and/or nature of the source to the extent necessary to identify the source and to

distinguish it from other sources (including, to the extent necessary for such purposes, a description of the device, installation, or operation constituting the source).”<sup>934</sup>

*Production Volume:* Additionally, we are proposing that production volume is emission data necessary to identify the source. Where the source is each individual engine, vehicle, or equipment produced, the production volume provides information necessary for EPA or the public to identify that source (the certificate only identifies one source, where the production volume identifies all the sources) and distinguish that source’s emissions from the emissions of other sources. In other words, actual production volume provides necessary information to identify the number of sources operating under a certificate of conformity and distinguish their total emissions from other sources. In this way, the total number of sources operating under a certificate of conformity provides a “[g]eneral description . . . of nature of the source” or, alternatively, provides information necessary such that the source can be identified in total, since it is generally unlikely that only a single unit of any engine, vehicle, or equipment would be produced under a certificate. For this additional reason, we are proposing to determine that the production volume category is emission data, not only for the reasons provided in Sections X.A.1.i.a and b, but also because it also provides a “[g]eneral description of the location and/or nature of the source to the extent necessary to identify the source and to distinguish it from other sources (including, to the extent necessary for such purposes, a description of the device, installation, or operation constituting the source).”<sup>935</sup>

ii. EPA Will Treat Preliminary and Superseded Information With the Same Confidentiality Treatment It Provides to the Final Reported Information

In the course of certifying and demonstrating compliance, manufacturers may submit information before the applicable deadline, and that information may be updated or corrected before the deadline for certification or compliance reporting. Similarly, manufacturers routinely update their applications for certification to include more or different information. EPA views this information as Agency records as soon as it is received through the Engine and Vehicle Certification Information System (EVCIS). We are proposing to

apply the same confidentiality determinations to this “early” information by category as is applied to information included in the final certification request or compliance report in the categories generally. However, EPA does not intend to proactively publish or release such preliminary or superseded information, because we believe that the inclusion of preliminary information in Agency publications could lead to an inaccurate or misleading understanding of emissions or of a manufacturer’s compliance status. Note, since such early information are Agency records upon receipt, we may be obligated to release information from those preliminary or superseded documents that does not qualify as CBI if a FOIA requester specifically identifies such pre-final information in the FOIA request. EPA also does not intend to disclose information in submitted reports until we have reviewed them to verify the reports’ accuracy, though the Agency may be required to release such information if it is specifically requested under the FOIA. We request comment on how the Agency can treat this kind of preliminary or superseded information to protect the public from incomplete or inaccurate information.

iii. Information That Is Never Entitled to Confidential Treatment Because It Is Publicly Available or Discernible Information or Becomes Public After a Certain Date.

We are also proposing to determine that information that is or becomes publicly available under the applicable standard-setting parts is not entitled to confidential treatment by EPA. Information submitted under the standard-setting parts generally becomes publicly available in one of two ways: (1) Information is required to be publicly disclosed under the standard-setting parts, or (2) information becomes readily measurable or observable after the introduction to commerce date. Information that is required to be publicly available under the standard-setting parts includes: Information contained in the fuel economy label, the vehicle emission control information (“VECI”) label, the engine emission control information label, owner’s manuals, and information submitted by the manufacturer expressly for public release. The information in the labels is designed to make the public aware of certain emissions related information and thus is in no way confidential. Similarly, manufacturers submit documents specifically prepared for public disclosure to EPA with the

<sup>933</sup> 40 CFR 2.301(a)(2)(i)(C).

<sup>934</sup> 40 CFR 2.301(a)(2)(i)(C).

<sup>935</sup> Id.

understanding that they are intended for public disclosure. We propose that these public facing documents are not entitled to confidential treatment, as they are prepared expressly for public availability. Additionally, we propose to determine that the information provided in the list below that is measurable or observable by the public after the source is introduced into commerce is not entitled to confidential treatment by EPA after the introduction to commerce date. This information may be emission data and included in the one of the categories proposed in this action, accordingly, we propose that it is emission data as described in Section XII.A.1.i. The fact that this information is or becomes publicly available is an additional reason for it to be not entitled to confidential treatment after the introduction into commerce date. This information includes: Model and parts information, source footprint information, manufacturer, model year, category, service class, whether the engine is remanufactured, engine type/category, engine displacement, useful life, power, payload tons, intended application, model year, fuel type, tier, and vehicle make and model. Footprint information is readily observable by the public after the introduction to commerce date, as one can measure and calculate that value once the source is introduced into commerce. Additionally, models and parts information is also readily available to the public after the source is introduced into commerce. Because this information is publicly available, it is not entitled to confidential treatment. Though EPA is also proposing that these proposed categories containing this information are not entitled to confidential treatment because they are emission data, as described in Section XI.A.1.i, the fact that the information becomes public after introduction to commerce is an additional basis for determining that the information is not entitled to confidential treatment. Therefore, we would not provide any additional notice or process prior to releasing this information in the future.

iv. Information Not Included in This Rule's Proposed Determinations Would Be Treated as Confidential, if the Submitter Claimed it as Such, Until a Confidentiality Substantiation Is Submitted and a Determination Made Under the 40 CFR Part 2 Process.

We are not proposing to make a confidentiality determination under 40 CFR 1068.11 for certain information submitted to us for certification and compliance. This information, if claimed as confidential by the

submitters, would be treated by EPA as confidential until such time as it is requested under the FOIA or EPA otherwise goes through a case-by-case or class determination process. At that time, we would pursue a confidentiality determination in accordance with 40 CFR part 2, and as proposed in this rulemaking under 40 CFR 2.301(j)(4). We are proposing to supersede the Table 3 CBI class determination made in 2013, such that the same categories of information in Table 3 would not have an applicable class determination and would be subject to the part 2 process. The information we are not proposing to include in this determination, and that would remain subject to the part 2 process, includes:

- (1) Projected production and sales,
- (2) production start and end dates outside of the defect and recall context,
- (3) specific and detailed descriptions of the emissions control operation and function,
- (4) design specifications related to aftertreatment devices,
- (5) specific and detailed descriptions of auxiliary emission control devices (AECDs),
- (6) plans for meeting regulatory requirements (e.g., ABT pre-production plans),
- (7) procedures to determine deterioration factors and other emission adjustment factors and any information used to justify those procedures,
- (8) financial information related to ABT credit transactions (including dollar amount, parties to the transaction and contract information involved) and manufacturer bond provisions (including aggregate U.S. asset holdings, financial details regarding specific assets, whether the manufacturer or importer obtains a bond, and copies of bond policies),
- (9) serial numbers or other information to identify specific engines or equipment selected for testing,
- (10) procedures that apply based on the manufacturers request to test engines or equipment differently than we specify in the applicable standard-setting parts,
- (11) information related to testing vanadium catalysts in 40 CFR part 1065, subpart L (proposed in this rule),
- (12) GPS data identifying the location and route for in-use emission testing, and
- (13) defect investigation reports. The information contained in defect investigation reports may encompass both emission data and information that may be CBI, so we are not proposing a determination for this report as whole. Instead, procedurally we will treat these reports in accordance with the existing part 2 process.

Additionally, we are proposing a category of information to include information received through "comments submitted in the comment field," where EPA's compliance reporting software has comment fields to allow manufacturers to submit clarifying information. We are not

proposing to make a determination on this broad category of potential information at this time, as the comments may or may not contain emission data. Therefore, EPA is proposing to undertake a case-by-case determination pursuant to part 2 for any information provided in a comment field. After further consideration, EPA is also not proposing to make a determination at this time regarding whether the information in Table 3 of the 2013 determination may meet the definition of emission data or otherwise may not be entitled to confidential treatment in certain circumstances under individual standard-setting parts, and instead thinks that a case-by-case determination process is better suited to these categories of information.

## 2. Adjustable Parameters

One of the goals of the certification process is to ensure that the emission standards needed to meet emission standards cannot be bypassed or rendered inoperative. Consistent with this goal, the standard-setting parts generally require that engines, vehicles, and equipment with adjustable parameters meet all the requirements of part 1068 for any adjustment in the physically adjustable range. This applies for testing pre-production engines, production engines, and in-use engines.

The underlying principles of the current regulations and policy can be traced to the early emission standards for mechanically controlled engines. The regulations at 40 CFR 86.094–22(e) illustrate how the relevant provisions currently apply for heavy-duty highway engines. The earliest generation of engines with emission control technology subject to emission standards included components such as simple screws to adjust a variety of engine operating parameters, including fuel-air ratio and idle speed. Owners were then able to adjust the engines based on their priority for power, efficiency, or durability. At the same time, manufacturers sought to reduce emissions by limiting the physical range of adjustment of these parameters, so EPA developed regulations to ensure that the engines' limitations were sufficiently robust to minimize operation outside the specified range (48 FR 1418, January 12, 1983).

Since then, heavy-duty highway engine manufacturers have developed new technologies that did not exist when we adopted the existing regulations related to adjustable parameters. The regulations at 40 CFR 86.094–22(e) therefore provide a limited framework under which to administer

the current certification for heavy-duty highway engines. Current certification practice consists of applying these broad principles to mechanically controlled operating parameters in a way that is similar for both highway and nonroad applications. EPA developed guidance with detailed provisions for addressing adjustable parameters at certification for land-based nonroad spark-ignition engines below 19 kW.<sup>936</sup> Electronically controlled operating parameters have generally not been treated as adjustable parameters, except that manufacturers need to identify all available operating modes (such as eco-performance or rabbit/turtle operation).

Manufacturers are required by existing regulations to describe in their application for certification how they address potentially adjustable operating parameters. As with all elements of certification, the regulations require manufacturers to use good engineering judgment for decisions related to adjustable parameters. The regulations also describe a process for manufacturers to ask for preliminary approval for decisions related to new technologies, substantially changed engine designs, or new methods for limiting adjustability. See, for example, 40 CFR 1039.115 and 1039.210.

We are proposing a new 40 CFR 1068.50 to update the current regulatory provisions to better describe how the established principles and requirements related to adjustable parameters also apply for current technologies. Thus, the new provisions would describe how our established principles regarding adjustable parameters apply for the full range of emission control technologies.

The proposed provisions are largely based on the regulations that already apply for highway engines and vehicles under 40 CFR 86.094–22(e) and 86.1833–01. Most of what we are proposing in 40 CFR 1068.50 is an attempt to codify in one place a set of provisions that are consistent with current practice. Some proposed provisions may represent new or more detailed approaches, as described further below, especially in the context of electronic controls. The proposed provisions in 40 CFR 1068.50 are intended to apply broadly across EPA's engine, vehicle, and equipment programs. The proposed language attempts to capture the full range of engine technologies represented by spark-ignition and compression-ignition engines used in highway, nonroad, and

stationary applications. We are accordingly proposing to apply the new provisions for all the types of engines, vehicles and equipment that are broadly subject to 40 CFR part 1068, as described in 40 CFR 1068.1. For example, the proposed provisions would apply for nonroad sectors and for heavy-duty highway engines, but not for highway motorcycles or motor vehicles subject to standards under 40 CFR part 86, subpart S. As with other provisions in 40 CFR part 1068, if the standard-setting part specifies some provisions that are different than 40 CFR 1068.50, the provisions in the standard-setting part would apply instead of the provisions in 40 CFR 1068.50. For example, we propose to continue to rely on the provisions related to adjusting air-fuel ratios in 40 CFR part 1051 for recreational vehicles in addition to the new provisions from 40 CFR 1068.50. We are also proposing some minor adjustments to the regulatory provisions in the standard-setting parts to align with the proposed language in 40 CFR 1068.50.

#### i. Operating Parameters, Adjustable Parameters, and Statement of Adjustable Range

The proposed regulations would codify the different meanings of the terms “operating parameter” and “adjustable parameter”. As proposed, “operating parameter” would generally mean any feature that can, by the nature of its design, be adjusted to affect emission performance—whether that feature is a single component, a system of components, or an electronic signal. This may include engine components that are designed to be replaced. It may also include elements of design involving consumption and replenishment, such as diesel exhaust fluid (DEF) or hybrid batteries (see Section XII.A.2.i.c for a discussion of these parameters). See proposed 40 CFR 1068.50(c).

Under the proposed regulations, an “adjustable parameter” would generally be any operating parameter that is practically adjustable and that can be adjusted using available tools in a way that affects emissions without significantly degrading engine performance. For example, while spark plug gap and valve lash are practically adjustable operating parameters, we do not treat them as adjustable parameters because adjusting them does not affect emissions without significantly degrading engine performance. The following sections describe how we propose to consider whether parameters are practically adjustable.

#### a. Mechanically Controlled Parameters

We propose in 40 CFR 1068.50(d)(1) that a mechanically controlled parameter is considered “not practically adjustable” if adjustments with ordinary tools take more than 15 minutes or involve service parts that cost more than \$30 for engines at or below 30 kW, or take more than 60 minutes or involve service parts that cost more than \$60 for engines between 30 kW and 560 kW.<sup>937</sup> This reference to “ordinary tools” would include hand tools, solvents, or other supplies that are available to the operator. Hand tools include screwdrivers, pliers, hammers, wrenches, electric screwdrivers, electric drills, and any tools supplied by the manufacturer with the product. Any such items that are sold at hardware stores, automotive parts supply stores, or on the Internet are considered available. The proposed thresholds are intended to be generally consistent with the provisions that apply under current regulations but tailored to represent an appropriate level of deterrence relative to typical maintenance experiences for the different sizes of engines.

For engines at or above 560 kW, we propose to consider a mechanically controlled parameter “practically adjustable” if the parameter can be adjusted using any available tools. We would expect this arrangement to cause manufacturers to take greater care for limiting adjustability with engines at or above 560 kW. This is appropriate because we expect owners of these low-volume, high-cost engines are more likely to have ready access to experienced mechanics to continuously manage the maintenance and performance of their engines. For example, owners of marine vessels often have engineers traveling with vessels to always be ready to perform extensive repairs or maintenance as needed. Owners of engines at or above 560 kW also commonly do their own work to substantially overhaul engines.

Mechanically controlled adjustable parameters usually have physical limits or physical stops to limit the range of adjustability. We are proposing to identify specific characteristics in 40 CFR 1068.50(e) to illustrate how physical limits or stops should function

<sup>937</sup> These costs are in 2020 dollars. Manufacturers would adjust these values for certification by comparing to the most recently available Consumer Price Index for All Urban Consumers value published by the Bureau of Labor Statistics at <https://www.usinflationcalculator.com/>. The cost thresholds do not include the cost of labor or the cost of any necessary tools or nonconsumable supplies; the time thresholds refer to the time required to access and adjust the parameter, excluding any time necessary to purchase parts, tools, or supplies or to perform testing.

<sup>936</sup> “Clean Air Act Requirements for Small Nonroad Spark-Ignition Engines: Reporting Adjustable Parameters and Enforcement Guidance,” EPA Guidance CD–12–11, August 24, 2012.

to control the adjustable range. For example, a physical stop defines the limit of the range of adjustability for a mechanically controlled adjustable parameter if operators cannot exceed the travel or rotation limits using ordinary tools without causing damage exceeding specified thresholds.

#### b. Electronically Controlled Parameters

We propose in 40 CFR 1068.50(d)(2) that electronically controlled parameters would be considered “practically adjustable” if they can be adjusted using any available tools (including devices that are used to alter computer code). This would apply for engines with any degree of electronic control. The proposed 40 CFR 1068.50(d) and (f) would also include special provisions for determining whether electronic control modules that can be adjusted by changing software or operating parameters (“reflashed”) are practically adjustable and to determine the practically adjustable range. First, where any of the following characteristics apply for a given electronic parameter, it would be considered practically adjustable:

- If an engine family includes multiple algorithms that can be selected or are easily accessible, the operating parameter would be practically adjustable and each of the available settings would be within the practically adjustable range.
- If the manufacturer sells software (or other products) that could be used to reflash the electronic control module, the operating parameter would be practically adjustable and all those settings would be within the practically adjustable range.
- If the engines/equipment have other electronic settings that can be adjusted using any available service tools (such as fuel injection maps), the operating parameter would be practically adjustable and all those settings would be within the practically adjustable range.

Injection fuel maps and other similar electronic parameters would not be considered practically adjustable if the manufacturer adequately prevents access to the electronic control modules with encryption or password protection consistent with good engineering judgment, such as having adequate protections in place to prevent distribution and use of passwords or encryption keys. Manufacturers would be able to exclude electronic operating parameters from being considered adjustable parameters (or identify them as adjustable parameters but narrow the adjustable range) where they appropriately determine that the

operating parameters will not be subject to in-use adjustment; EPA would retain the right to review such statements. The proposed regulations would also allow us to specify conditions to ensure that the certified configuration includes electronic parameter settings representing adjustable ranges that reflect the expected range of in-use adjustment or modification.

To address the safety, financial liability, operational, and privacy concerns which can result from tampering, manufacturers, industry organizations, and regulators have been working to develop standards and design principles to improve the security of ECMs.<sup>938</sup> Since security principles are constantly evolving as new threats are identified, requiring them to be applied with specificity in an annual emissions certification process could be problematic. In addition, manufacturers may choose to utilize different mixes of technical standards or principles of those recommended by these organizations, and a one-size-fits-all approach with detailed requirements for ECM security would be neither practical nor prudent. Manufacturers need the flexibility to quickly implement measures to address new or emerging threats and vulnerabilities. Accordingly, we are proposing that manufacturers inform EPA of their ECM security measures at the time they submit an application for certification. Manufacturers would be required to identify and describe the measures they are using, whether proprietary, industry technical standards, or a combination of both, to prevent unauthorized access to the ECM. At a minimum, for determination whether the parameter is an operating parameter or an adjustable parameter this documentation would need to describe in sufficient detail the measures that a manufacturer has used to: prevent unauthorized access; ensure that calibration values, software, or diagnostic features cannot be modified or disabled; and respond to repeated, unauthorized attempts at reprogramming or tampering.

Aftermarket fuel conversions for heavy-duty highway engines and vehicles are a special case. We expect aftermarket converters to continue their current practice of modifying engines to run on alternative fuels under the clean alternative fuel conversion program in 40 CFR part 85, subpart F. The anti-tampering provisions proposed in 40 CFR 1068.50 are not intended to

<sup>938</sup> See SAE J3061, “Cybersecurity Guidebook for Cyber-Physical Vehicle Systems,” January 14, 2016. Efforts are also underway to draft a cybersecurity agreement under the auspices of the UNECE process for WP.29 (ISO/SAE J21434).

interfere with actions aftermarket converters may need to take to modify or replace ECMs as part of the conversion process consistent with 40 CFR part 85, subpart F. The proposed provisions direct manufacturers to prevent unauthorized access to reprogram ECMs. Aftermarket converters would presumably need to either use a replacement ECM with a full calibration allowing the engine to run on the alternative fuel or perhaps create a piggyback ECM that modifies the engine’s calibration only as needed to accommodate the unique properties of the alternative fuel. Aftermarket converters could alternatively work with engine manufacturers to access and change the engine’s existing ECM programming for operation on the alternative fuel. We request comment on any adjustment to the proposed regulatory provisions that would be needed to address fuel conversions.

#### c. Consumption, Replenishment, and the Certified Configuration

Certain elements of design involving consumption and replenishment may be considered adjustable parameters. Two significant examples are DEF tank fill level and hybrid battery state of charge. The proposed provisions in 40 CFR 1068.50(h) address these issues.

For these adjustable parameters, the range of adjustability is determined based on the likelihood of in-use operation at a given point in the physically adjustable range. We may determine that operation in certain subranges within the physically adjustable range is sufficiently unlikely that the subranges may be excluded from the allowable adjustable range for testing. In such cases, the engines/equipment are not required to meet the emission standards for operation in an excluded subrange.

The proposal in 40 CFR 1068.50(h) describes how we would not require new engines to be within the range of adjustability for a certified configuration for adjustments related to consumption and replenishment. Specifically, manufacturers would not violate the prohibition in 40 CFR 1068.101(a)(1) to introduce into commerce a vehicle with an empty DEF tank or an uncharged hybrid battery.

Except for these special cases related to consumption and replenishment, engines are not in the certified configuration if manufacturers produce them with adjustable parameters set outside the range specified in the application for certification. Similarly, engines are not in the certified configuration if manufacturers produce them with other operating parameters



that do not conform to the certified configuration. Such engines would therefore not be covered by a certificate of conformity and would therefore be subject to the violation provisions of 40 CFR 1068.101(a)(1).

#### ii. Certification Process

The existing regulations in each standard-setting part describe how manufacturers need to identify their adjustable parameters, along with the corresponding physical stops and adjustable ranges. The existing certification process includes a review of the manufacturer's specified adjustable parameters, including consideration of the limits of adjustability. This has generally focused on mechanically controlled parameters. We consider the totality of the circumstances as we determine whether a manufacturer's effort to prevent inappropriate adjustment is adequate. See text further clarifying this principle in proposed 40 CFR 1068.50(g). Under the existing certification process we may also evaluate the appropriateness of a manufacturer's statement regarding an adjustable parameter if we learn from observation of in-use engines with such parameters or other information that a parameter was in fact practically adjustable or that the specified adjustable range was in fact not correct.

We are proposing to require manufacturers in the certification application to state, with supporting justification, that they designed mechanically controlled adjustable parameters to prevent in-use operation outside the intended physically adjustable range, and that they have restricted access to the electronic controls as specified in the proposed 40 CFR 1068.50 to prevent in-use operation outside the practically adjustable range.

We are proposing in this rule to clarify that manufacturers must consider electronically controlled parameters to be operating parameters that may also be adjustable. For example, engine calibrations may include user-selectable settings for different operating modes. Different operating modes may alternatively be available for certain users with assistance from dealers or other authorized service centers. All operating modes available for selection by the operator must be described in the certification application and are considered to fall within the engine's practically adjustable range. The manufacturer would also describe in the certification application how they have restricted access to the electronic controls to prevent unauthorized modification of in-use engines. We would expect manufacturers to follow

accepted industry best practices to include password restrictions, encryption, two-step authentication, and other methods as appropriate. These practices will change over time and we would expect manufacturers to implement those newer methods, especially where there are observed cases of unauthorized changes to in-use engines.

Manufacturers would name all available operating modes in the application for certification and describe their approach for restricting access to electronic controls. This description would include naming any applicable encryption protocols, along with any additional relevant information to characterize how the system is designed to prevent unauthorized access. Manufacturers separately identify information regarding their auxiliary emission control devices. Manufacturers would not need to report additional detailed programming information describing electronically adjustable operating parameters that are unavailable to owners.

While EPA would still retain the right to review the manufacturer's specified adjustable parameters in the certification process, the manufacturer would be responsible for ensuring all aspects of the manufacturer's statements regarding adjustable parameters are appropriate for each certification application. EPA may review this information each year to evaluate whether the designs are appropriate. As industry practices evolve to improve tamper-resistance with respect to electronic controls, we may require manufacturers to upgrade tamper-resistance features to include more effective protocols in order to support their statement that the electronic controls are both restricted from unauthorized access and limited to the identified practically adjustable range.

We are proposing to apply the new provisions in 40 CFR 1068.50 starting with model year 2024. This proposed implementation date would allow time for updating EPA's certification software and procedures. Manufacturers would continue to be required to meet existing regulations related to adjustable parameters before model year 2024 under this proposal. The proposed provisions are intended to include only modest changes for mechanically controlled parameters. As described in Section XII.2.i.b, engine manufacturers have described their significant efforts to limit unauthorized access to electronically controlled parameters. We therefore expect that manufacturers would not need additional time beyond

model year 2024 to comply with the new provisions. We request comment on whether this proposal provides sufficient time to comply with all the proposed provisions in 40 CFR 1068.50.

The proposed provisions in 40 CFR 1068.50 are not intended to limit the tampering prohibition of 40 CFR 1068.101(b)(1) or the defeat device prohibition of 40 CFR 1068.101(b)(2). For example, it would be prohibited tampering to bypass a manufacturer's stops. Similarly, software that reduces the effectiveness of controls specified by the manufacturer in the application for certification would be a prohibited defeat device. See proposed 40 CFR 1068.50(k).

If EPA discovers that someone manufactures or installs a modified ECM or reflashes an engine's ECM in a way that is not a certified configuration represented in the application for certification, those persons could be held liable for violating the tampering prohibition of 40 CFR 1068.101(b)(1) or the defeat-device prohibition in 40 CFR 1068.101(b)(2). As we gather information about cases where third parties have successfully penetrated ECM access restrictions, under our proposed regulations the manufacturer would be responsible in each certification application for ensuring all aspects of the manufacturer's statements regarding such adjustable parameters are still appropriate and we may also engage with the manufacturer to see if there is need or opportunity to upgrade future designs for better protection.

#### iii. Engine Inspections

EPA may want to inspect engines to determine if they meet the proposed specifications. These inspections could be part of the certification process, or we could inspect in-use engines after certification. For example, we may request a production line engine be sent to an EPA designated lab for inspection to test the limits of the adjustable parameters as described in proposed 40 CFR 1068.50(d)(1).

#### iv. Right To Repair

Several states are pursuing legislative initiatives to require engine manufacturers and other companies to make it easier for owners to repair or modify products. As described in Section IV.B.3, this proposed rule includes several provisions intended to improve or increase access to service information for owners and mechanics. Given the complexity of modern engines, access to service information is important to sustain the expectation that engines and their emission controls will

continue to work properly over their operating life.

That objective does not extend to engines to the extent they rely on electronic controls to manage engine operation to achieve the required level of emission control. In fact, the proposed approach to treat electronic controls without adequately restricted access as adjustable parameters is intended specifically to prevent owners and mechanics from being able to modify those electronic controls to allow in-use operation outside of the practically adjustable range. Any state regulation requiring manufacturers to provide access to these controls would be directly in conflict with the Clean Air Act prohibition against tampering with certified engines and the prohibition against using defeat devices to circumvent emission standards.

### 3. Exemptions for Engines, Vehicles, and Equipment Under 40 CFR Part 1068, Subparts C and D

40 CFR part 1068, subparts C and D, describe various exemption provisions for engines, vehicles and equipment that are subject to emission standards and certification requirements. We are proposing to amend several of these exemption provisions. The following paragraphs use the term engines to refer generically to regulated engines, vehicles and equipment.

The test exemption in 40 CFR 1068.210 applies for certificate holders performing test programs “over a two-year period”. We are proposing to remove this time limitation. We may impose reasonable time limits on the duration of the exemption for individual engines under another existing provision (40 CFR 1068.210(e)). Such limitations may take the form of a defined time period for manufacturers to produce exempt engines, or a defined time period for individual engines to remain in exempt status. This exemption applies for a wide range of products and experience has shown that circumstances may call for the exemption to apply for longer than (or less than) two years. We may therefore continue to apply a two-year limit for producing or using exempt engines based on a case-specific assessment of the need for the exemption. We could alternatively identify a shorter or longer exemption period based on the circumstances for each requested exemption. The exemption approval could also allow test engines to operate indefinitely, perhaps with additional conditions on modifying the engine to include software or hardware changes that result from the test program or other design improvements. This

approach may be appropriate for manufacturing one or more engines as part of a pilot project to prove out designs and calibrations for meeting new emission standards. Separate provisions apply for importing engines under the testing exemption in 40 CFR 1068.325, which we discuss further later in this section.

The display exemption in 40 CFR 1068.220 applies for using noncompliant engines/equipment for display purposes that are “in the interest of a business or the general public.” The regulation disallows the display exemption for private use, private collections, and any other purposes we determine to be inappropriate. We have been aware of several cases involving displays we may have considered to be in the interest of the general public but they did not qualify for the display exemption because they were mostly for private use. Experience has shown that it may be difficult to distinguish private and public displays. For example, private collections are sometimes shared with the general public. We are accordingly proposing to preserve the fundamental limitation of the display exemption to cases involving the interest of a business or the general public. We propose to revise 40 CFR 1068.220 to no longer categorically disallow the display exemption for engines and vehicles displayed for private use or for engines in private collections. We propose to retain the discretion to disallow the display exemption for inappropriate purposes. This would apply, for example, if engines or vehicles from a private collection will not be displayed for the general public or for any business interest. Consistent with longstanding policy, such private displays do not warrant an exemption from emission standards.

The regulation defines provisions that apply for “delegated assembly” of aftertreatment and other components in 40 CFR 1068.261. Under the current regulation, manufacturers must follow a set of detailed requirements for shipping partially complete engines to equipment manufacturers to ensure that the equipment manufacturer will fully assemble the engine into a certified configuration. A much simpler requirement applies for engine manufacturers that produce engines for installation in equipment that they also produce. Manufacturers have raised questions about how these requirements apply in the case of joint ventures, subsidiary companies, and similar business arrangements. We are proposing to revise 40 CFR 1068.261(b) through (d) to clarify that the simpler

requirements for intra-company shipments apply for engines shipped to affiliated companies. Conversely, engine manufacturers shipping partially complete engines to any unaffiliated company would need to meet the additional requirements that apply for inter-company shipments. We define “affiliated companies” in 40 CFR 1068.30.

The identical configuration exemption in 40 CFR 1068.315(h) allows for importation of uncertified engines that are identical to engines that have been certified. This might apply, for example, for engines that meet both European and U.S. emission standards but were originally sold in Europe. We are proposing to modify the regulatory language from “identical” to “identical in all material respects.” This change allows for minor variation in engines/equipment, such as the location of mounting brackets, while continuing to require that engines/equipment remain identical to a certified configuration as described in the manufacturer’s application for certification.

The ancient engine/equipment exemption in 40 CFR 1068.315(i) includes an exemption for nonconforming engines/equipment that are at least 21 years old that are substantially in their original configuration. We originally adopted these for nonroad spark-ignition engines in 2002 to align with a similar exemption that was in place for light-duty motor vehicles (67 FR 68242, November 8, 2002). Now that part 1068 applies for a much wider range of applications, many with very long operating lives, it has become clear that this exemption is no longer appropriate for importing nonconforming engines. Keeping the exemption would risk compromising the integrity of current standards to the extent importers misuse this provision to import high-emitting engines. This was not the original intent of the exemption. We are therefore proposing to remove the ancient engine/equipment exemption. The identical configuration exemption will continue to be available to allow importation of nonconforming engines/equipment that continue to be in a configuration corresponding to properly certified engines.

The regulations at 40 CFR 1068.325 describe provisions that apply for temporarily exempting engines/equipment from certification requirements. As noted in the introduction to 40 CFR 1068.325, we may ask U.S. Customs and Border Protection (CBP) to require a specific bond amount to make sure importers comply with applicable requirements.

We use the imports declaration form (3520–21) to request CBP to require a bond equal to the value of these imported engines/equipment for companies that are not certificate holders. Several of the individual paragraphs describing provisions that apply for specific exemptions include a separate statement requiring the importer to post bond for these products. We are proposing to remove the reference to the bond requirement in the individual paragraphs because the introduction addresses the bonding requirement broadly for all of 40 CFR 1068.325.

We are proposing to revise the diplomatic or military exemption at 40 CFR 1068.325(e) to clarify that someone qualifying for an exemption would show written confirmation of being qualified for the exemption to U.S. Customs and Border Protection, not EPA. This may involve authorization from the U.S. State Department or a copy of written orders for military duty in the United States. Consistent with current practice, EPA would not be involved in the transaction of importing these exempted products, except to the extent that U.S. Customs and Border Protection seeks input or clarification of the requirements that apply.

The regulations at 40 CFR 1068.260(c) currently include an exemption allowing manufacturers to ship partially complete engines between two of their facilities. This may be necessary for assembling engines in stages across short distances. It might also involve shipping engines across the country to a different business unit under the same corporate umbrella. The regulation at 40 CFR 1068.325(g) includes additional provisions for cases involving importation. Multi-national corporations might also import partially complete engines from outside the United States to an assembly plant inside the United States. We are proposing to revise 40 CFR 1068.325(g) to require that imported engines in this scenario have a label that identifies the name of the company and the regulatory cite authorizing the exemption. This would provide EPA and U.S. Customs and Border Protection with essential information to protect against parties exploiting this provision to import noncompliant engines without authorization.

Most of the exemptions that allow manufacturers to import uncertified engines include labeling requirements to identify the engine manufacturer and the basis of the exemption. We are proposing to add a general requirement in 40 CFR 1068.301 to clarify that labels are required on all exempted engines. In

cases where there are no labeling specifications for a given exemption, we are proposing to create a default labeling requirement to add a label for exempted engines to identify the engine manufacturer and the basis of the exemption.

#### 4. Other Amendments to 40 CFR Part 1068

We are proposing the following additional amendments to 40 CFR Part 1068:

- *Section 1068.1*: Clarifying how part 1068 applies for older engines. This is necessary for nonroad engines certified to standards under 40 CFR parts 89, 90, 91, 92, and 94 because those emission standards and regulatory provisions have been removed from the CFR. These amendments were inadvertently omitted from the rule to remove those obsolete parts.

- *Section 1068.1*: Clarifying how part 1068 applies for motor vehicles and motor vehicle engines. Vehicles and engines certified under part 86 are subject to certain provisions in part 1068 as specified in part 86. Vehicles and engines certified under parts 1036 and 1037 are subject to all the provisions of part 1068. This correction aligns with regulatory text adopted in previous rulemakings.

- *Section 1068.101(a)*: The regulations at 40 CFR 1068.101(a) set forth the prohibitions that apply for engines and equipment that are subject to EPA emission standards and certification requirements. The regulation includes at 40 CFR 1068.101(a)(2) a prohibition related to reporting and recordkeeping requirements. Section 1068.101(a)(3) similarly includes a prohibition to ensure that EPA inspectors have access to test facilities. These prohibitions derive from CAA section 208(a), which applies the information and access requirements to manufacturers “and other persons subject to the requirements of this part or part C.” The very first provision of 40 CFR part 1068 at 40 CFR 1068.1(a) clearly makes the provisions of part 1068 applicable “to everyone with respect to the engine and equipment categories as described in this paragraph (a)[. . .] including owners, operators, parts manufacturers, and persons performing maintenance”. However, the regulation in 40 CFR 1068.101(a) as written inadvertently limits the prohibitions to manufacturers. We are accordingly proposing to revise the scope of the prohibitions in 40 CFR 1068.101(a) to apply to both manufacturers and “other persons as provided in 40 CFR 1068.1(a)” in accord with those in CAA section 203(a).

- *Section 1068.101(b)(5)*: Removing extraneous words.

- *Section 1068.240(a)*: Removing reference to paragraph (d) as an alternative method of qualifying for the replacement engine exemption. Paragraph (d) only describes some administrative provisions related to labeling partially complete engines so it is not correct to describe that as an additional “approach for exempting” replacement engines.

- *Section 1068.240(b) and (c)*: Adding text to clarify that owners may retain possession of old engines after installing an exempt replacement engine. This is intended to address a concern raised by engine owners that they generally expect to be able to continue to use a replaced engine.<sup>939</sup> Engine owners stated that they expect to use the replaced engine for either replacement parts or continued use in a different piece of equipment and were surprised to learn that engine manufacturers were insisting that the owner turn ownership of the old engine to the engine manufacturer. The existing regulation disallows simply installing those replaced engines in a different piece of equipment, but destroying the engine block and using the engine core as a source of replacement parts is acceptable under the existing regulation.

- *Sections 1068.601 and 1068.630*: Adding provisions to establish procedures for hearings related to an EPA decision to approve maintenance procedures associated with new technology for heavy-duty highway engines. As described in Section IV.B.5.v, we are proposing to update regulatory provisions related to engine maintenance for heavy-duty highway engines. Section XII.A.9 describes how we may eventually extend those same provisions for nonroad engines. The provisions proposed in this rule include a commitment for EPA to describe approved maintenance for new technology in a **Federal Register** notice, along with an allowance for any manufacturer to request a hearing to object to EPA’s decision. The general provisions related to hearing procedures in 40 CFR part 1068, subpart G, cover the maintenance-related hearing procedures. We are proposing to amend the regulation to provide examples of the reasons a manufacturer may request a hearing, including if a manufacturer believes certain EPA decisions may cause harm to its competitive position, and to add detailed specifications for requesting

<sup>939</sup> Email exchange regarding replacement engines, August 2020, Docket EPA–HQ–OAR–2019–0055.

and administering such a hearing for maintenance-related decisions for heavy-duty highway engines.

5. Engine and Vehicle Testing Procedures (40 CFR Parts 1036, 1037, 1065 and 1066)

The regulations in 40 CFR part 1036, subpart F, 40 CFR part 1037, subpart F, and 40 CFR parts 1065 and 1066 describe emission measurement procedures that apply broadly across EPA's emission control programs for engines, vehicles, and equipment. This rule includes several proposed amendments to these regulations.

We are proposing to delete the hybrid engine test procedure in 40 CFR 1036.525 as it was applicable only for model year 2014 to 2020 engines and has been replaced with the hybrid powertrain test procedure for model 2021 and later engines in 40 CFR 1037.550.

We are proposing updates to the engine mapping test procedure in 40 CFR 1065.510. To generate duty cycles for each engine configuration, engine manufacturers identify the maximum brake torque versus engine speed using the engine mapping procedures of 40 CFR 1065.510. The measured torque values are intended to represent the maximum torque the engine can achieve under fully warmed-up operation when using the fuel grade recommended by the manufacturer across the range of engine speeds expected in real-world conditions. Historically, the mapping procedure required the engine to stabilize at discrete engine speed points ranging from idle to the electronically limited highest RPM before recording the peak engine torque values at any given speed. We adopted a provision in 40 CFR 1065.510(b)(5)(ii) that allows manufacturers to perform a transient sweep from idle to maximum rated speed, which requires less time than stabilizing at each measurement point.

The proposed updates to the engine mapping test procedure in 40 CFR 1065.510 are intended to ensure the resulting engine map achieves its intended purpose. The current test procedure is intended to generate a "torque curve" that represents the peak torque at any specific engine speed point. The transient sweep from idle to maximum rated speed can create engine conditions that trigger electronic control features on modern heavy-duty spark-ignition engines that result in lower-than-peak torque levels. Engine control features that can cause variability in the maximum torque levels include spark advance, fuel-air ratio, and variable valve timing that temporarily alter torque levels to meet supplemental

goals (such as torque management for transmissions shifts).<sup>940</sup> If the engine map does not capture the true maximum torque, the duty cycles generated using the map may not accurately recreate the highest-load conditions that could lead to higher emissions in the real-world.

We are proposing to update 40 CFR 1065.510(b)(5)(ii) to require that the torque curve established during the mapping procedure represent the highest torque level possible when using the manufacturer's recommended fuel grade. Specifically, we are proposing to require manufacturers to disable electronic controls or other auxiliary emission control devices if they are of a transient nature and impact peak torque during the engine mapping procedure.<sup>941</sup> Manufacturers would continue to implement their engine control during the duty cycle tests, enabling their engines to react to the test conditions as they would in real world operation. The proposed changes to the mapping procedure would ensure the test duty cycle appropriately represents torque output and emissions during high-load and transient conditions.

There may be other ways to update the mapping procedure to ensure maximum torque, such as a change to the order or duration of the torque measurement points. We seek comment, including relevant data, on the proposed procedure update as well as other approaches we should consider.

This rule includes the following additional proposed amendments to 40 CFR parts 1065 and 1066:

- *Sections 1065.301 and 1065.1001:* Revising NIST-traceability requirements to allow the use of international standards recognized by the CIPM Mutual Recognition Arrangement without prior EPA approval. The current regulation allows us to approve international standards that are not NIST-traceable, but this was intended only to accommodate laboratories in other countries that meet CIPM requirements instead of following NIST-traceable protocols. With this approach there would no longer be any need for a separate approval process for using international standards that are not NIST-traceable. NIST-traceable standards are traceable to the International System of Units (SI) as specified in NIST Technical Note 1297, which is referenced in the definition of

<sup>940</sup> These AECDS are typically electronic controls that are timer-based and initiated for a set duration. In a transient test, measurements are taken continuously, and the controls remain engaged; the same controls would "time out" if each measurement was taken at stabilized conditions.

<sup>941</sup> These electronic controls would be reported as an AECDS using 40 CFR 1036.205(b).

NIST-traceable in 40 CFR part 1065. This same traceability to the International System of Units is required of standards recognized by the CIPM Mutual Recognition Arrangement, thus putting them on par with NIST-traceable standards.

- *Section 1065.298:* Proposing a new 40 CFR 1065.298 to codify the in-use particulate matter (PM) measurement method that augments real-time PM measurement with gravimetric PM filter measurement for field-testing analysis. This method has been approved for use for over 10 years as an alternative method under 40 CFR 1065.10 and 1065.12.

- *Section 1065.410:* Clarifying that manufacturers may inspect engines using electronic tools to monitor engine performance. For example, this may apply for OBD signals, onboard health monitors, and other prognostic tools manufacturers incorporate into their engine designs. As described in the current regulation, inspection tools are limited to those that are available in the marketplace. This prevents engine manufacturers from handling a test engine more carefully than what would be expected with in-use engines. Extending that principle to inspection with electronic tools, we propose to limit the use of those inspections to include only information that can be accessed without needing specialized equipment.

- *Section 1065.650(c)(6):* Adding an allowance to determine nonmethane nonethane hydrocarbon (NMNEHC) for engines fueled with natural gas as 1.0 times the corrected mass of NMHC if the test fuel has 0.010 mol/mol of ethane or more. This may result in a higher reported NMNEHC emission value. The engine manufacturer may use this method if reducing test burden is more important than the potential for a slightly higher reported emission value.

- *Section 1065.720:* Removing the test fuel specification related to volatility residue for liquefied petroleum gas. The identified reference procedure, ASTM D1837, has been withdrawn, at least in part, due to limited availability of mercury thermometers. There is no apparent replacement for ASTM D1837. Rather than proposing an alternative specification for volatility residue, we would instead rely on the existing residual matter specification based on the measurement procedure in ASTM D2158. This alternative specification should adequately address concerns about nonvolatile impurities in the test fuel.

- *Section 1065.910(b):* Adding a requirement to locate the PEMS during field testing in an area that minimizes

the effects of ambient temperature changes, electromagnetic radiation, shock, and vibration. This may involve putting the PEMS in an environmental enclosure to reduce the effect of these parameters. We are also proposing to remove (1) the recommendation to install the PEMS in the passenger compartment because that does not necessarily lead to better mitigation of temperature effects as the cab temperature can vary during vehicle soaks, (2) ambient pressure as a parameter to minimize as there are no known pressure effects on PEMS, and (3) ambient hydrocarbon as a parameter because it is more of a PEMS design issue that is handled with an activated carbon filter on the burner air inlet, which is already covered in 40 CFR 1065.915(c).

- *Section 1065.920*: Broadening the PEMS calibration and verification requirements to make them applicable to the new emission measurement bin structure being proposed in 40 CFR part 1036. The verification is now generic to verifications for both NTE and binned windows where you acquire a shift-day's worth of data over 6 to 9 hours and then process the data as you would for an in-use test (either NTE or binned windows) and compare the performance of the PEMS to the lab-based measurement system.

- *Section 1065.935(d)*: Updating the zero and span verification requirements to include new provisions for the emission measurement bin structure being proposed in 40 CFR part 1036 and retaining the current requirements for NTE testing only. The procedure now includes the requirement to perform zero-verifications at least hourly using purified air. Span verifications must be performed at the end of the shift-day or more frequently based on the PEMS manufacturer's recommendation or good engineering judgment.

- *Section 1065.935(g)(6)*: Adding a new paragraph to include new drift limits instead of those in 40 CFR 1065.550 for the emission measurement bin structure being proposed in 40 CFR part 1036. The analyzer zero drift limit between the hourly or more frequent zero verifications is 2.5 ppm, while the limit over the entire shift-day (or more frequently if you perform zero-adjustments) is 10 ppm. The analyzer span drift limit between the beginning and end of the shift-day or more frequent span verification(s) or adjustment(s) must be within  $\pm 4$  percent of the measured span value.

- *Sections 1065.1123, 1065.1125, and 1065.1127*: Adding new regulatory sections to migrate the smoke test procedure in 40 CFR part 86, subpart I,

into 40 CFR part 1065. This would provide a common location for the test procedure and analyzer requirements for all parts that still require smoke measurement with the exception of locomotive testing. The locomotive test procedure would continue to reside in 40 CFR part 1033, subpart F, as it is specific to locomotive testing and operation at specific notches. No updates were made to the procedure that would affect analyzer requirements and setup or how a laboratory would report test results. For all engines required to carry out smoke testing, other than locomotive engines, we are proposing to update operation at curb idle speed to warm idle speed and rated speed to maximum test speed. We believe this proposed change will not adversely affect the acceleration and lugging operation modes of the test and this update will now make smoke testing consistent with all other engine-based testing that now use warm idle speed and maximum test speed.

- *Part 1066, subpart D*: Referencing an updated version of SAE J2263 for coastdown measurements. The updated standard incorporates EPA guidance for vehicles certified under 40 CFR part 86, subpart S.<sup>942</sup> The updated version of the test method also reduces the wind speed allowed for performing measurements, allows for adding ballast to vehicles if needed, and adds clarifying procedures for testing on oval tracks. These changes align with current practice for light-duty vehicles, and the changes would have no substantial effect for measurements with heavy-duty vehicles. We are therefore proposing to apply the updated version of SAE J2263 for all light-duty and heavy-duty vehicles.

- *Section 1066.420*: Adding the existing 40 CFR 86.140–94 requirement to zero and span calibrate the hydrocarbon analyzer by overflowing the zero and span gas at the hydrocarbon sampling system probe inlet during analyzer calibration when testing vehicles that are 14,000 GVWR or less. This requirement was inadvertently missed during the migration of the light-duty test procedures to 40 CFR part 1066.

- *Section 1066.831*: Removing the reference to 40 CFR part 1065 regarding how to measure THC emissions, as the method for measuring THC emission is already covered in 40 CFR part 1066, subparts B and E.

This rule includes additional proposed amendments that are regarded as clarifications in the following

<sup>942</sup> "Determination and Use of Vehicle Road-Load Force and Dynamometer Settings", EPA Guidance Document CD–15–04, February 23, 2015.

sections of 40 CFR parts 1036, 1037, 1065, and 1066:

40 CFR 1036.501, 1036.503, 1036.505, 1036.510, 1036.527, 1036.530, 1036.535, 1036.540, and 1036.543; 40 CFR 1037.320, 1037.510, 1037.515, 1037.520, 1037.534, 1037.540, 1037.550, 1037.551, 1037.555, 1037.601, 1037.615, and 1037.725; 40 CFR 1065.1, 1065.5, 1065.10, 1065.12, 1065.140, 1065.190, 1065.210, 1065.284, 1065.301, 1065.305, 1065.307, 1065.308, 1065.309, 1065.315, 1065.320, 1065.325, 1065.330, 1065.345, 1065.350, 1065.410, 1065.501, 1065.510, 1065.512, 1065.514, 1065.545, 1065.610, 1065.650, 1065.655, 1065.660, 1065.667, 1065.680, 1065.695, 1065.715, 1065.720, 1065.790, 1065.901, 1065.915, 1065.920, 1065.1001, and 1065.1005; and 40 CFR 1066.110, 1066.220, 1066.415, 1066.710, 1066.815, 1066.835, 1066.845, 1066.1001, and 1066.1005.

## 6. Vanadium-Based SCR Catalysts

In certain diesel engine applications vanadium-based SCR catalysts may provide a performance and cost advantage over other types of catalysts. However, vanadium material can sublime from the catalyst in the presence of high exhaust gas temperatures.<sup>943</sup> Sublimation of vanadium catalyst material leads to reduced NO<sub>x</sub> conversion efficiency of the catalyst and possible exposure of the public to vanadium emissions. In 2016 EPA provided certification guidance to manufacturers of diesel engines equipped with vanadium-based SCR catalysts ("2016 guidance").<sup>944</sup> The certification guidance clarified EPA's expectations for manufacturers using vanadium-based SCR catalysts and provided our views and recommendations on reasonable steps manufacturers could take to protect against excessive loss of vanadium from these SCR systems. We are now proposing to codify these provisions as regulatory requirements for using vanadium-based SCR catalysts. We propose to adopt these requirements for all types of diesel engines. The proposed regulatory provisions are consistent with the 2016 guidance and would begin to apply when the final rule becomes effective. To make this effective immediately for all current and future MY diesel engines, we are proposing to update 40 CFR 86.007–11 (to cover HD engines through MY 2026) to reference the new 40 CFR 1036.115(g)(2) which contains this

<sup>943</sup> The temperature at which vanadium sublimation occurs varies by engine and catalyst and is generally 550° C or higher.

<sup>944</sup> "Certification of Diesel Engines Equipped with Vanadium-based SCR Catalyst", EPA guidance document CD–16–09, June 13, 2016.

requirement. We request comment on any additional time needed by manufacturers to comply with the proposed requirements.

Specifically, we are proposing that manufacturers of heavy-duty diesel engines equipped with vanadium-based SCR catalysts determine vanadium sublimation temperatures and thermal management strategies and include documentation in their certification applications. EPA would use the information submitted by manufacturers in its evaluation of a manufacturer's engine and aftertreatment design as part of its application for certification.

In their certification applications, engine manufacturers would be required to provide information identifying the vanadium sublimation temperature threshold for the specific catalyst product being used. To identify the vanadium sublimation temperature, manufacturers would be required to use the vanadium sublimation sampling and analytical test method identified in the 2016 guidance.<sup>945</sup> Manufacturers also would be required to identify their thermal management strategy for preventing the vanadium sublimation temperature from being exceeded. In addition, manufacturers would be required to identify how their thermal management strategy will protect the catalyst in the event of high temperature exotherms resulting from upstream engine component failures, as well as exotherms resulting from hydrocarbon buildup during normal engine operation. EPA would expect to approve applications that include thermal management strategies that prevent exhaust gas temperatures from exceeding the sublimation temperature threshold (*i.e.*, the temperature below which vanadium emissions are less than the method detection limit in the test method proposed to be included in 40 CFR part 1065, subpart L).

#### 7. ULSD-Related Exemption for Guam

EPA's in-use fuel requirements at 40 CFR part 1090 include an exemption from the 15-ppm sulfur standard for Guam, American Samoa, and the Commonwealth of the Northern Mariana Islands (40 CFR 1090.620). Diesel fuel meeting the 15-ppm standard is known as ultra-low sulfur diesel or ULSD. EPA's emission standards for highway and nonroad diesel engines generally involves SCR as a control technology. The durability of SCR systems depends on the use of fuel meeting the 15-ppm

ULSD standard, so we adopted a corresponding exemption from the most stringent emission standards for engines used in these three territories (see 40 CFR 86.007–11(f) for heavy-duty highway engines and 40 CFR 1039.655 for land-based nonroad diesel engines).

Guam has in the meantime adopted rules requiring the 15-ppm sulfur standard for in-use diesel fuel for both highway and nonroad engines and vehicles. As a result, there is no longer a reason to keep the exemption from emission standards for engines used in Guam. We are therefore proposing to remove the exemption for these engines in Guam. Since there is no question of feasibility or other issues related to availability of certified engines for Guam, we are proposing to remove the exemption upon the effective date of the final rule, which we anticipate as late in 2022 or early in 2023. We request comment on the need for lead time or any other transitional provisions related to removing the exemption.

We are not proposing to remove the exemption from American Samoa and the Northern Mariana Islands at this time as we are not aware of the adoption of ULSD requirements in those territories. We seek comment on the status of the use of ULSD in American Samoa and the Northern Mariana Islands.

We are also proposing to clarify that the exemption for land-based nonroad diesel engines at 40 CFR 1039.655 applies only for engines at or above 56 kW. Smaller engines are not subject to NO<sub>x</sub> standards that would lead manufacturers to use SCR or other sulfur-sensitive technologies, so we would not expect anyone to be using this exemption for engines below 56 kW in any area where the exemption applies. We intend to revisit the exemption from the 15-ppm ULSD standard for diesel fuel in Guam under 40 CFR part 1090 in a future action. Removal of exemption for diesel fuel in Guam would likely involve new or revised regulatory provisions for parties that make, distribute, and sell diesel fuel in Guam such as additional reporting, recordkeeping, and other compliance-related provisions.

#### 8. Deterioration Factors for Certifying Nonroad Engines

Section IV describes a proposed approach for manufacturers of heavy-duty highway engines to establish deterioration factors (DFs) based on bench-aged aftertreatment in combination with a plan for testing in-use engines to verify that the original deterioration factor properly predicts an engine's emission levels at the end of

the useful life. As described in Section IV.F, we are proposing the new approach for establishing deterioration factors to take advantage of available techniques for bench-aging aftertreatment devices to streamline the certification and product-development timeline. The leaner up-front testing is complemented by measurements from in-use engines to verify that the original deterioration factors are still appropriate for certifying engines in later model years.

This same dynamic applies for nonroad applications. We are therefore proposing to allow manufacturers of all types of nonroad diesel engines and manufacturers of land-based nonroad spark-ignition engines above 19 kW to use these same procedures to establish and verify DFs. These proposed provisions would apply for 40 CFR parts 1033, 1039, 1042, and 1048. We are not proposing any changes to the existing certification and durability procedures for certifying these engines for those who choose not to rely on the proposed provisions with bench-aged aftertreatment.

Most of the DF verification procedures proposed for heavy-duty highway engines apply equally for nonroad engines, but unique aspects of each certification program call for making the following adjustments:

- Marine and land-based nonroad diesel engines are subject to not-to-exceed standards and corresponding test procedures that would continue to apply instead of the in-use measurement protocols proposed in this rule for heavy-duty highway engines.
- Land-based nonroad spark-ignition engines above 19 kW (Large SI engines) are subject to field-testing standards and corresponding test procedures that would continue to apply instead of the in-use measurement protocols proposed in this rule for heavy-duty highway engines.
- Locomotives are not subject to off-cycle emission standards or emission measurement procedures that apply during normal in-use operation. However, manufacturers can perform in situ testing on in-use locomotives that meets all the specifications for certification testing in a laboratory. This allows for testing in-use engines to verify that deterioration factors based on bench-aged aftertreatment devices are appropriate for predicting full-life emissions.

Each type of nonroad diesel engine already has sector-specific methods for calculating infrequent regeneration adjustment factors.

We are not proposing to allow this approach for certifying recreational

<sup>945</sup> EPA is proposing to codify the test method in CD-16-09 in 40 CFR part 1065, subpart L; 40 CFR 1065.12 describes the process for approving alternative test procedures.

vehicles, land-based nonroad spark-ignition engines at or below 19 kW, or marine spark-ignition engines. These engines are generally subject to certification of a useful life that is much shorter than the values that apply for the types of engines for which we are proposing to allow the new DF verification procedures. Many nonroad spark-ignition engines are also certified without aftertreatment. As a result, it is not clear that there would be any potential for manufacturers of these other types of engines to find a benefit of using the proposed DF verification procedures.

We request comment on this proposed alternative for establishing and verifying deterioration factors for the identified nonroad engines. We also request comment on the adjustments proposed for the identified engine types, and on extending the DF verification protocol to the other nonroad spark-ignition applications.

#### 9. Serviceability, Allowable Maintenance, and Hearing Procedures

Section IV describes how we are proposing to update maintenance-related specifications for heavy-duty highway engines. This includes changes to require manufacturers to comply with emission standards based on less frequent critical emission-related maintenance and to provide greater access to servicing information on the engine's emission control information label and in the owners manual. The proposal also includes substantial changes to modernize the description and organization of the maintenance specifications as part of the overall migration of regulatory provisions from 40 CFR part 86 to 40 CFR part 1036. Many of these structural changes are intended to align with analogous provisions already adopted for the various nonroad sectors, but the proposal includes several things that depart from those other regulations.

We are not proposing to make changes to maintenance-related specifications for nonroad engines or equipment. However, we will likely propose amendments in a future rulemaking to align nonroad regulations with many of the maintenance-related provisions we adopt in this rule. As a result, we encourage commenters to review this proposed rule with consideration of the potential for these maintenance-related provisions to apply in the future for each of the nonroad sectors as appropriate.

#### *B. Heavy-Duty Highway Engine and Vehicle Emission Standards (40 CFR Parts 1036 and 1037)*

##### 1. Timing of Annual Reports

We are proposing to simplify annual reporting requirements to account for the extensive information submissions related to the greenhouse gas emission standards. Vehicle manufacturers are required to report on GEM results and production volumes for thousands of distinct vehicle configurations at the end of the model year to show that emission credits related to calculated average CO<sub>2</sub> emission rates are sufficient to comply with standards. The regulation currently requires an interim end-of-year report by March 31 and a final report by September 30 (see 40 CFR 1037.730). This same schedule is typical for documentation related to emission credits for various types of nonroad engines and vehicles. In contrast to those nonroad programs, compliance with the heavy-duty highway CO<sub>2</sub> emission standards relies on a detailed assessment of GEM results and corresponding production volumes to determine all the necessary credit calculations for the model year. We propose to modify the regulation at 40 CFR 1037.730 to no longer require the interim end-of-year report, because we have observed that manufacturers need more time to complete their effort to fully document their compliance for the model year and we believe the interim end-of-year report is unnecessary for heavy-duty vehicles. The regulation allows us to waive this interim report, and we have routinely approved such requests. We are not proposing any change to the final report due in September and would continue to rely on that final report to evaluate compliance with standards.

Engine manufacturers generate and use emission credits based on production volumes that correspond to the vehicle production. As a result, it is beneficial for both EPA and engine manufacturers to align the emission credit reporting requirements for engines and vehicles. We are therefore proposing to revise 40 CFR 1036.730 to also omit the interim end-of-year report and instead rely only on the final report submitted by September 30 following each model year. In addition, the regulations at 40 CFR 1036.250 and 1037.250 currently specify that engine and vehicle manufacturers must report their production volumes within 90 days after the end of the model year. For the same reasons given for modifying the schedule for credit reports, we propose to align this production reporting with the final ABT report,

requiring manufacturers to report their production volumes also by September 30 following the end of the model year. These proposed changes address a comment by the Truck and Engine Manufacturers Association in a recent rulemaking.<sup>946</sup>

##### 2. Warranty Period for Medium HDV With Spark-Ignition Engines

In the HD GHG Phase 2 final rule, we set a vehicle-based warranty period for the Medium HDV service class to five years or 100,000 miles for 2021 and later model years (81 FR 73478, October 25, 2016), which represents an increase in the warranty period for Class 6 through Class 8 heavy-duty vehicles with spark-ignition engines.<sup>947</sup> These warranty provisions apply for both evaporative and refueling emission standards in 40 CFR 1037.103 and for greenhouse gas standards in 40 CFR 1037.105.

The Medium HDV warranty period differs from the warranty periods associated with some engines that may be certified for use in those vehicles. Compression-ignition engines from the "Light HDE" primary intended service class and all spark-ignition engines certified to GHG standards under 40 CFR 1036.108 are subject to warranty requirements for five years or 50,000 miles (40 CFR 1036.120). We request comment on whether to revise the warranty provisions in 40 CFR 1037.120 to include a warranty period of five years or 50,000 miles for Medium HDV with compression-ignition engines from the "Light HDE" primary intended service class or with spark-ignition engines to be consistent with the GHG warranty periods for those engines.

In Section IV.B, we propose to increase the warranty periods for engines certified to model year 2027 and later criteria pollutant standards. Under proposed 40 CFR 1036.150(w), those longer warranty periods would not apply for engine technologies that are limited to controlling greenhouse gas emissions, but we are not aware of any current or projected technologies that would qualify as being dedicated to meeting GHG standards. We request comment on whether to instead align all warranty periods that apply for engine technologies, irrespective of the emissions they are designed to control, with the warranty periods that we finalize for criteria pollutant emission control.

For model years 2027 and later, we recognize that our proposed engine

<sup>946</sup> "Comments of the Truck and Engine Manufacturers Association" for Docket EPA-HQ-OAR-2019-0307, June 26, 2020.

<sup>947</sup> This vehicle service class is defined in 40 CFR 1037.140(g)(3).

warranty periods would differ from the vehicle warranty periods described in this section. All the proposed engine warranties are longer than the warranty periods under consideration for heavy-duty vehicles. We request comment on whether these misaligned warranties may pose a problem for certification or implementation.

### 3. Scope and Timing for Amending Applications for Certification

Engines must be produced in a certified configuration to be covered by the certificate of conformity. Manufacturers routinely need to amend their applications for certification during the model year to reflect ongoing product development. These amendments may involve new configurations or improvements to existing configurations. The current regulations describe how manufacturers can make these amendments in a way that allow them to comply with the general requirement to produce engines that are in a certified configuration (see 40 CFR 1036.225 and 1037.225). We generally refer to these amendments as running changes. Manufacturers apply these running changes to new engines they continue to build during the model year. Applying these running changes to engines that have already been produced is referred to as a “field fix”. We have provided “field-fix” guidance since the earliest days of EPA emission standards.<sup>948</sup>

We recently adopted regulatory provisions in 40 CFR parts 1036 and 1037 to describe how manufacturers may modify engines as reflected in the modified application for certification, which included essential elements of the 1975 field-fix guidance (80 FR 73478, October 25, 2016).

There is also a related field-fix question of how to allow for design changes to produced engines (before or after initial shipment) that the manufacturer identifies after the end of the model year. The preamble for that recent final rule explained that the regulatory provisions also included how manufacturers may amend an application for certification after the end of the model year to support intended modifications to in-use engines.

After further consideration, we are proposing to revise 40 CFR 1036.225 and 1037.225 to limit manufacturers to having the ability to amend an application for certification only during the production period represented by the model year. These proposed

revisions would become effective upon the effective date of the final rule, if adopted. Manufacturers would continue to be able to apply field fixes to engines they have already produced if those engine modifications are consistent with the amended application for certification.

The process for amending applications for certification under proposed 40 CFR 1036.225 and 1037.225 would not apply to field fixes that manufacturers identify after the end of the model year. Like our approach in other standard-setting parts for nonroad applications, we would refer manufacturers to the 1975 field-fix guidance for recommendations on how to approach design changes after the end of the model year. EPA’s certification software is already set up to accommodate manufacturers that submit documentation for field fixes related to engine families from earlier model years. We believe this approach is effective, and it involves less burden for EPA implementation than allowing manufacturers to amend their application for certification after the end of the model year.

We request comment on the proposed regulations for amending applications for certification and field-fixes within the model year for a given engine family.

We expect to propose to adopt further regulatory provisions in a future rulemaking to update and clarify implementation of the field-fix policy for design changes that occur after the end of the model year. We expect that rulemaking to include consideration of such provisions for all types of highway and nonroad engines and vehicles.

### 4. Alternate Standards for Specialty Vehicles

The final rule adopting HD GHG Phase 2 standards for heavy-duty highway engines and vehicles included provisions allowing limited numbers of specialty motor vehicles to have engines meeting alternate standards derived from EPA’s nonroad engine programs (80 FR 73478, October 25, 2016). The provisions applied for amphibious vehicles, vehicles with maximum operating speed of 45 mph or less, and all-terrain vehicles with portal axles. The provisions also apply for hybrid vehicles with engines that provide energy for a Rechargeable Energy Storage System, but only through model year 2027.

We continue to recognize the need for and benefit of alternate standards that address limitations associated with specialty vehicles. We are therefore proposing to migrate these alternate

standards from 40 CFR 86.007–11 and 86.008–10 into 40 CFR 1036.605 without modification. At the same time, we are mindful of two important regulatory and technological factors that will cause us to potentially revise the alternate standards. First, certifying based on powertrain testing addresses the testing limitations associated with nonstandard power configurations. Second, emission control technologies may support more stringent alternate emission standards than the current nonroad engine standards. Furthermore, CARB has not adopted that same approach to apply alternate standards for specialty vehicles and we are unaware of manufacturers certifying any of these types of specialty vehicles to the full engine and vehicle standards. We may therefore consider revising the alternate standards, or discontinuing the alternate standards entirely. We are also considering whether to sunset the provisions for hybrid vehicles at the end of model year 2026 to align with the new standards that will start in model year 2027. We have prepared a memorandum that further explores these technological and regulatory issues, with a discussion of a range of possible options that we are considering.<sup>949</sup> We request comment on all these potential changes to the provisions related to alternate standards for specialty vehicles. We might make those changes in this rule or in a future rule.

### 5. Additional Amendments

We are proposing to revise the regulatory text in 40 CFR parts 1036 and 1037 to describe units for tire rolling resistance as newtons per kilonewton (N/kN) instead of kg/tonne. SAE J2452 treats these as interchangeable units, but ISO 28580, which we incorporated by reference at 40 CFR 1037.810, establishes N/kN as the appropriate units for measuring rolling resistance. Since the units in the numerator and denominator cancel each other out either way, this change in units has no effect on the numerical values identified in the regulation or on data submitted by manufacturers.

The regulation at 40 CFR 1037.115(e) describes how manufacturers demonstrate that they meet requirements related to air conditioning leakage. Paragraph (e) allows for alternative demonstration methods where the specified method is impossible or impractical, but limits

<sup>948</sup> “Field Fixes Related to Emission Control-Related Components,” EPA Advisory Circular, March 17, 1975.

<sup>949</sup> Stout, Alan. Memorandum to Docket EPA–HQ–OAR–2019–0055. “Draft Amendments Related to Alternate Engine Standards for Specialty Vehicles”. January 31, 2022.



that alternative to systems with capacity above 3000 grams of refrigerant. We recognize alternative demonstrations may also be necessary for systems with smaller capacity and are therefore proposing to remove this qualifying criterion. The proposed change is also consistent with changes that CARB has made as part of the Omnibus rule.<sup>950</sup>

The SET duty cycle table in 40 CFR 86.1362 contains the engine speed and load as well as vehicle speed and road grade to carry out either engine or powertrain testing. The table contains two errors in the vehicle speed column for modes 1a and 14. The vehicle speed is set to “warm idle speed” in the table, which is an engine test set point. Since this is an idle mode and the vehicle is not moving, the vehicle speeds should be set to 0 mi/hr. This correction will have no effect on how powertrain testing over this duty cycle is carried out.

We are proposing to correct a typo in 40 CFR 1036.235(c)(5)(iv)(C) regarding EPA’s confirmatory testing of a manufacturer’s fuel map for demonstrating compliance with greenhouse gas emission standards. We propose to update the “greater than or equal to” to “at or below” to be consistent with the related interim provision in 40 CFR 1036.150(q). The intent of the EPA testing is to confirm that the manufacturer-declared value is at or below EPA’s measured values.

We are proposing to clarify that “mixed-use vehicles” qualify for alternate standards under 40 CFR 1037.105(h) if they meet any one of the criteria specified in 40 CFR 1037.631(a)(1) or (2). In contrast, vehicles meeting the criterion in 40 CFR 1037.631(a)(1) and at least one of the criteria in 40 CFR 1037.631(a)(2) automatically qualify as being exempt from GHG standards under 40 CFR part 1037.

#### *C. Fuel Dispensing Rates for Heavy-Duty Vehicles (40 CFR Parts 80 and 1090)*

EPA adopted a regulation limiting the fuel dispensing rate to a maximum of 10 gallons per minute for gasoline dispensed into motor vehicles (58 FR 16002, March 24, 1993). The dispensing limit corresponded with the test procedure for vehicle manufacturers to demonstrate compliance with a refueling spitback standard adopted in the same final rule. Spitback involves a spray of liquid fuel during a refueling

event if the vehicle cannot accommodate the flow of fuel into the fuel tank. The spitback standard applied only for vehicles at or below 14,000 pounds GVWR, so we provided an exemption from the dispensing limit for dispensing pumps dedicated exclusively to heavy-duty vehicles (see 40 CFR 80.22(j) and 1090.1550(b)). Just like for spitback testing with vehicles at or below 14,000 pounds GVWR, vehicles designed with onboard refueling vapor recovery systems depend on a reliable maximum dispensing rate to manage vapor flow into the carbon canister.

Now that we are proposing a requirement for all gasoline-fueled heavy-duty highway vehicle manufacturers to comply with refueling standards, it is no longer appropriate to preserve the exemption from the dispensing rate limit for dispensing pumps dedicated exclusively to heavy-duty vehicles. Retail stations and fleets rarely have dispensing pumps that are dedicated to heavy-duty vehicles. Since there are no concerns of feasibility or other issues related to meeting the 10 gallon per minute dispensing limit, we are proposing to remove the exemption upon the effective date of the final rule. We request comment on allowing additional lead time for any legacy installations that continue to have higher dispensing rates for gasoline-fueled heavy-duty vehicles. We expect few such cases. This may occur, for example, with a remaining fleet of gasoline-fueled school buses or with farms that have refueling capabilities for delivery trucks along with nonroad implements.

We note that the proposed dispensing rate limits relate only to gasoline-fueled motor vehicles. There is no rate restriction on dispensing diesel fuel into motor vehicles, or on dispensing any kind of fuel into aircraft, marine vessels, other nonroad equipment, or portable or permanently installed storage tanks. We are also not proposing new dispensing rate limits for these fuels in this action.

#### *D. Refueling Interface for Motor Vehicles (40 CFR Parts 80 and 1090)*

EPA first adopted a requirement for new gasoline-fueled cars and trucks to have filler necks fitted with a limiting orifice to prevent fueling with leaded fuel (38 FR 26450, Sept. 21, 1973). This purpose became obsolete when leaded gasoline was disallowed as a fuel for motor vehicles starting January 1, 1996. The requirement has nevertheless endured, perhaps to accommodate Stage II refueling controls at retail stations or to ensure compatibility with onboard refueling vapor recovery systems.

In 2020, as part of a broader effort to streamline fuel regulations, EPA proposed to migrate in-use fuel regulations from 40 CFR part 80 to 40 CFR part 1090 (85 FR 29034, May 14, 2020). Since the requirements related to vehicle-refueling interface were in 40 CFR 80.24, we proposed to move those vehicle requirements to 40 CFR part 86 for light-duty vehicles and to 40 CFR part 1037 for heavy-duty vehicles. In response to the proposed rule, we received comments suggesting that we should modify the requirements for narrow-diameter fuel necks to align with published voluntary consensus standards.<sup>951</sup> In finalizing that rule, we deferred action on the proposed migration of these provisions to further consider potential modifications (85 FR 78412, December 4, 2020).

In the meantime, we have focused on further understanding the handful of heavy-duty vehicle models that have side-mounted fuel tanks. These vehicles are generally derived from diesel-fueled truck models and therefore are designed with large fuel tanks with no filler neck. In evaluating the feasibility of applying refueling standards for these vehicles, we again reviewed the narrow-diameter filler-neck requirement. The filler-neck restriction is no longer needed to prevent misfueling with leaded fuel. There is also no need for new vehicles to be designed to accommodate Stage II refueling controls now that they are subject to vehicle-based refueling standards. As a result, the only remaining need for restricting the filler-neck diameter is for those vehicles that depend on such a design to meet spitback and refueling standards.

Since there is no longer an external emission-related design constraint for filler necks, vehicle manufacturers will no longer be constrained to design their vehicles to meet spitback and refueling standards with a limiting orifice. If vehicle manufacturers need to have a narrow-diameter filler neck to achieve a mechanical seal for onboard refueling vapor recovery or to prevent spitback, then they will need to include those design specifications. If they can use a different orifice or no orifice at all and still meet spitback and refueling standards, that would also represent a compliant configuration. We therefore propose to remove the filler-neck restrictions from 40 CFR 80.24 without migrating those requirements to the CFR parts for light-duty or heavy-duty vehicles.

<sup>950</sup> California Air Resources Board, “Appendix B–3 Proposed 30-Day Modifications to the Greenhouse Gas Test Procedures”, May 5, 2021. Available online: <https://ww2.arb.ca.gov/sites/default/files/barcu/regact/2020/hdomnibuslownox/30dayappb3.pdf>, page 20.

<sup>951</sup> See SAE J285 “Dispenser Nozzle Spouts for Liquid Fuels Intended for Use with Spark Ignition and Compression Ignition Engines”, April 2019 and ISO 9158:1988 “Road vehicles—Nozzle spouts for unleaded gasoline”, March 1998.

We acknowledge that there are commercial reasons to have standardized specifications for filler necks. This is reflected by the referenced voluntary consensus standards adopted to accomplish that purpose. EPA's existing specifications are compatible with those published standards but allow for a much wider range of dimensions. The comment from the earlier rulemaking requested that we update our specifications to match those in the voluntary consensus standards. We request comment on the appropriateness of either keeping the existing specifications or adopting the specifications from voluntary consensus standards into the EPA regulations. We specifically request comment on the benefit of adopting such standards and on the authority for adopting such standards under the Clean Air Act considering that we intend to remove the now obsolete requirements in 40 CFR 80.24.

*E. Light-Duty Motor Vehicles (40 CFR Parts 85, 86, and 600)*

EPA's emission standards, certification requirements, and fuel economy provisions for light-duty motor vehicles are in 40 CFR part 85, 40 CFR part 86, subpart S, and 40 CFR part 600.

1. Testing With Updated Versions of SAE J1634

i. Existing BEV Test Procedures

EPA's existing regulations for testing Battery Electric Vehicles (BEVs) can be found in 40 CFR part 600—Fuel Economy and Greenhouse Gas Emissions of Motor Vehicles. The existing EPA regulations (40 CFR 600.116–12(a) and 600.311–12(j) and (k)) reference the 2012 version of the SAE Standard J1634—Battery Electric Vehicle Energy Consumption and Range Test Procedure.

Current regulations (40 CFR 600.116–12(a)) allow manufacturers to perform either single cycle tests (SCT) or the multi-cycle test (MCT) as described in the EPA regulations and the 2012 version of SAE J1634. The SCT and MCT are used to determine the unrounded and unadjusted city and highway range values and the city and highway mile per gallon equivalent (MPGe) fuel economy values.

The 2012 version of SAE J1634 specifies 55 miles per hour (mph) as the speed to be used during the mid-test and end-of-test constant speed cycles of the MCT. The 2017 version of SAE J1634 specifies 65 mph as the speed to be used during the constant speed cycles of the MCT. Manufacturers have reached out to the Agency and

requested to use the 2017 version of SAE J1634 to reduce the time required to perform the MCT and the Agency has generally approved these requests. EPA's fuel economy regulations allow manufacturers to use procedures other than those specified in the regulations. The special test procedure option is described in 40 CFR 600.111–08(h). This option is used when vehicles cannot be tested according to the procedures in the EPA regulations or when an alternative procedure is determined to be equivalent to the EPA regulation.

EPA regulations found in 40 CFR 600.210–12(d)(3) specify three options for manufacturers to adjust the unrounded and unadjusted 2-cycle (city and highway) results for fuel economy labeling purposes. The three methods include: Generating 5-cycle data; multiplying the 2-cycle values by 0.7; and asking the Administrator to approve adjustment factors based on operating data from in-use vehicles. To date the Agency has not approved any requests to use operating data from in-use vehicles to generate an adjustment factor.

Many manufacturers use the option to multiply their 2-cycle fuel consumption and range result by the 0.7 adjustment factor. The benefit of this option for the manufacturer is that the manufacturer does not need to perform any of the additional 5-cycle tests to determine the label result. This method is equivalent to the derived 5-cycle method which allows manufacturers to adjust their 2-cycle fuel economy test results for gasoline vehicles based on the EPA determined slope and intercept values generated from 5-cycle testing performed on emission data vehicles (EDVs).

A few manufacturers have been using the option to generate 5-cycle data which is then used for determining a 5-cycle adjustment factor. The specific 5-cycle adjustment factor is then multiplied by the unrounded, unadjusted 2-cycle results to determine fuel economy label values.

EPA's current regulations do not specify a method for performing 5-cycle testing for BEVs. EPA acknowledged this in the 2011 rulemaking that created the fuel economy label requirement for BEVs:

The 5-cycle testing methodology for electric vehicles is still under development at the time of this final rule. This final rule will address 2-cycle and the derived adjustments to the 2-cycle testing, for electric vehicles. As 5-cycle testing methodology develops, EPA may address alternate test procedures. EPA regulations allow test methods alternate to the 2-cycle and derived 5-cycle to be used

with Administrator approval. (76 FR 39501, July 6, 2011)

The first manufacturer to approach EPA and request to perform 5-cycle testing for BEVs was Tesla, and EPA approved Tesla's request. The method Tesla proposed is known as the BEV 5-cycle adjustment factor method, and it was added to Appendices B and C of the SAE J1634 Standard in the 2017 update.

Since publication of the 2017 version of SAE J1634, BEV manufacturers in addition to Tesla have been approaching the Agency and seeking to use the 5-cycle adjustment factor methodology outlined in Appendices B and C. EPA has generally approved manufacturer requests to use this method.

The 5-cycle method outlined in the 2017 version of SAE J1634 is essentially the same method that EPA uses to determine 5-cycle fuel economy for vehicles with internal combustion engines. There are, however, two differences between the EPA approved BEV 5-cycle adjustment factor method compared to the 5-cycle calculation methodology outlined in 40 CFR 600.114–12, Vehicle-specific 5-cycle fuel economy and carbon-related exhaust emission calculations. The first difference is that the numerator of the City and Highway fuel economy equations is 0.92 rather than 0.905. This was done to remove the ethanol correction from the 5-cycle fuel economy equation for BEVs. The second change was to allow BEV manufacturers to use the results of a full charge depleting Cold Temperature Test Procedure (CTTP or 20°F FTP) in the City fuel economy calculation when calculating the running fuel consumption. Vehicles with internal combustion engines (ICE) use only the bag 2 and bag 3 fuel economy results from the CTTP. The CTTP is performed at an ambient temperature of 20°F after the vehicle has cold-soaked in the 20°F test chamber for a minimum of 12 hours and a maximum of 36 hours. In addition, to reduce the testing burden the current BEV 5-cycle procedure allows manufacturers to skip the 10-minute key-off soak between UDSS cycles after the second UDSS cycle. This test procedure allowance was made to reduce the time burden for performing full charge depletion testing in the cold test chamber.

ii. Summary of Proposed Changes

EPA is proposing to update the SAE J1634 standard referenced in 40 CFR part 600 from the 2012 version to the 2017 version. This update will require manufacturers to use 65 mph for the constant speed cycles of the MCT. In addition, this update will allow

manufacturers to use the BEV 5-cycle adjustment factor methodology outlined in Appendices B and C of the 2017 version of SAE J1634 with the revisions described below.

For model year 2023, manufacturers may continue to perform full charge depletion testing on BEVs when running the CTTTP to determine the 5-cycle adjustment factor. However, EPA is proposing that in model year 2023 manufacturers would be required to perform a 10-minute key-off soak between each UDDS cycle performed as part of the charge depleting CTTTP. We are not proposing to change the existing requirement to submit a written request for EPA approval to perform 5-cycle testing prior to beginning 5-cycle adjustment procedure testing. EPA is proposing that manufacturers will be required to attest that the vehicle was not preconditioned or connected to an external power source during the 20°F cold soak period.

Beginning with model year 2024, EPA is proposing that manufacturers would be allowed to perform only two UDDS cycles when running the CTTTP, with a 10-minute key-off soak between the UDDS cycles to generate their BEV 5-cycle adjustment factor. The running fuel consumption for the City fuel economy equation would be modified from the equation provided in Appendix C of the 2017 version of SAE J1634. The charge depletion value would be replaced with the results from Bag 2 of the first and second UDDS and Bag 1 from the second UDDS. The Agency would allow manufacturers to use their existing CTTTP test results to make these calculations, or they could perform new tests with the option to have the vehicle's state-of-charge set to a value specified by the manufacturer such that the vehicle can capture regeneration energy during the first UDDS cycle.

The Agency is also proposing additional changes to the procedures outlined in the 2017 version of SAE J1634 including: Specifying a maximum constant speed phase time of 1 hour with a minimum 5-minute soak following each one-hour constant speed phase; specifying the use of the methods in Appendix A of the 2017 version of SAE J1634 to determine the constant speed cycle's total time for the mid-test constant speed cycle; and, specifying

that energy depleted from the propulsion battery during key-off engine soak periods is not included in the useable battery energy (UBE) measurement.

### iii. Discussion of Proposed Changes

The Agency is proposing to adopt portions of Appendix B and C of the 2017 version of SAE J1634 as the process for determining the 5-cycle adjustment factor with modifications. As proposed, manufacturers will be required to request Administrator approval to use the process outlined in the Appendices with modifications including: Requiring soak periods of a minimum of 10 minutes between each UDDS cycle when performing the charge depleting CTTTP (the Appendices allow skipping the key-off soak period between UDDS cycles, after the second UDDS cycle, to reduce the charge depleting test burden); adding the specification that preconditioning of any vehicle components, including the propulsion battery and vehicle cabin, is prohibited; and, beginning in the 2024 Model Year allowing only two UDDS cycles to be performed on the CTTTP instead of allowing manufacturers to choose how many UDDS cycles to perform up to and including full charge depletion testing on the CTTTP.

The current approved 5-cycle test procedure includes allowing a complete charge depleting CTTTP to generate data for the city fuel economy calculation. As the Agency has gathered data from manufacturers performing this test, it has become apparent that the charge depletion testing on the CTTTP generates fuel consumption data that are not representative of the extreme cold start test conditions this test was designed to capture. A long-range BEV can complete as many as 50 UDDS cycles at  $-7^{\circ}\text{C}$  ( $20^{\circ}\text{F}$ ) before depleting the battery. With the allowance to skip the 10-minute key off soak period after the second UDDS a long-range BEV will reach a stabilized warmed-up energy consumption condition after 6 to 10 UDDS cycles. At this point the vehicle is warmed-up and will have approximately the same energy consumption for each of the remaining 30 to 40 UDDS cycles. The averaged energy consumption value from this full charge depletion test—as many as 50 UDDS cycles—is entered into the 5-cycle equation for the running

fuel consumption for the city fuel economy calculation. In contrast, for vehicles using fuels other than electricity the running fuel consumption is calculated using the values from Bag 2 of the first UDDS cycle and Bag 1 of the second UDDS cycle.

It has become apparent to the Agency that modifications are needed to this method to ensure all vehicles are tested under similar conditions and use equivalent data for generating fuel economy label values. Allowing BEVs to perform a full charge depletion CTTTP creates test procedure differences between BEVs and non-BEVs. Non-BEVs are not allowed to run more than one UDDS cycle followed by one Bag 1 phase from the second UDDS cycle.

The intent of the CTTTP is to capture the performance of vehicles under extreme cold start conditions during short trip city driving. The CTTTP procedure used by vehicles other than BEVs consists of one UDDS cycle (consisting of Bag 1 and Bag 2) followed by a 10-minute key-off soak followed by the first 505 seconds (Bag 3) of the second UDDS cycle. The data from these three bags are utilized by all vehicles, other than BEVs, when calculating the vehicle's city fuel economy (40 CFR 600.114–12). Allowing BEVs to use a fuel consumption value based on fully depleting the battery, while not performing any key-off soaks between any UDDS cycle after the second UDDS cycle is not representative of short trip urban driving or equivalent to the procedure performed by vehicles using fuels other than electricity.

Based on these observations, the Agency has concluded that allowing BEVs to perform full charge depletion testing on the CTTTP, with only one 10-minute key-off soak occurring between the first and second UDDS cycle, does not generate data representative of the vehicles' performance during extreme cold start short trip city driving conditions. Therefore, starting in model year 2024, the Agency proposes to allow BEVs to perform only two UDDS cycles with a 10-minute key-off soak between them. The Agency proposes the following change to the running fuel consumption equation used for calculating the city fuel economy outlined in Appendix C of the 2017 Version of SAE J1634:

$$\begin{aligned}
 \text{RunningFC} = & 0.82 \times \left[ \frac{0.48}{\text{Bag2 FTP}} + \frac{0.41}{\text{Bag3 FTP}} + \frac{0.11}{\text{US06 City}} \right] \\
 & + 0.18 \times \left[ \frac{1}{(20^\circ\text{F UDDS1 Bag2} + 20^\circ\text{F UDDS2 Bag2})} + \frac{0.5}{20^\circ\text{F UDDS2 Bag1}} \right] \\
 & + 0.133 \times 1.083 \times \left[ \frac{1}{\text{SC03}} - \left( \frac{0.61}{\text{Bag3 FTP}} + \frac{0.39}{\text{Bag2 FTP}} \right) \right]
 \end{aligned}$$

The Agency understands that the proposed test procedure and fuel economy equation is different from that for non-BEVs. The Agency also understands that BEV testing has primarily not consisted of measured sample bags and, instead has focused on performing complete UDDS cycles. Unlike vehicles using combustion engines, BEVs do not generate significant quantities of waste heat from their operation, and typically require using stored energy, when not being preconditioned at cold ambient temperatures, to produce heat for both the cabin and the battery. The Agency expects BEVs will require more than two UDDS cycles with a 10-minute key-off soak between them for the vehicle to reach a fully warmed up and stabilized operating point. As such, the Agency believes it is reasonable to include an additional data point (*i.e.*, UDDS2 Bag2) for use in the running fuel consumption equation for BEVs. The Agency seeks comment on whether this is a reasonable procedure and calculation method for generating BEV fuel economy results that are comparable to the procedures and calculations used for non-BEVs, or, if the test procedure and fuel economy equation should be the same for BEVs and non-BEVs which would entail the BEV CTTTP concluding following the completion of the first Bag of the second UDDS cycle.

For model year 2024, the Agency proposes to allow manufacturers to recalculate the city fuel economy for models they are carrying-over using the first two UDDS cycles from their prior charge depletion CTTTP test procedures to generate new model year 2024 label values. Manufacturers may not want to use these data, as the test may not be representative, since the vehicle's regeneration capability may be limited by the fully charged battery during the first and possibly second UDDS cycles on the CTTTP. The Agency proposes to perform the two UDDS CTTTP with the vehicle initially charged to a level defined by the manufacturer and disclosed to the Agency. One possible approach consists of charging the vehicle to a level that produces a battery state-of-charge (SoC) equivalent to 50 percent following the first UDDS cycle.

The 2017 version of SAE J1634 refers to this SoC level as the mid-point test charge (MC).

As BEVs have become more efficient and as battery capacities have increased over the past decade, the time required to perform CTTTP charge depletion testing has dramatically increased. This proposal will result in significant time savings for manufacturers as the proposed BEV CTTTP will consist of two UDDS cycles, and no longer allows charge depletion testing which, in many instances, would require multiple shifts to complete. The Agency also believes the results obtained from the proposal will be more representative of the energy consumption observed during short urban trips under extreme cold temperature conditions. The Agency seeks comment on these proposals for reducing test burden and reducing the test procedure variability between BEVs and vehicles other than BEVs.

#### iv. Proposed Changes to Procedures for Testing Electric Vehicles

EPA is proposing to update from the 2012 to the 2017 version of SAE J1634 and proposing to include regulatory provisions that amend or clarify the BEV test procedures outlined in the 2017 version. These amendments are being proposed to minimize test procedure variations allowed in the 2017 version, which the Agency has concluded can impact test results. For example, the SAE standard allows for the constant speed cycles to be performed as a single phase or broken into multiple phases with key-off soak periods. Depending on how the constant-speed portion is subdivided, the UBE measurement can vary. These proposed changes are intended to reduce the variations between tests and to improve test-to-test and laboratory-to-laboratory repeatability.

The proposed changes include:

- Allowing for Administrator approval for vehicles that cannot complete the Multi-Cycle Range and Energy Consumption Test (MCT) because of the distance required to complete the test or maximum speed for the UDDS or HFEDS cycle.

- In alignment with SAE J1634, Section 8.3.4, a 15 second key-on pause

time and a 10 minute key-off soak period would be required between specific drive cycles where key-off soak periods have to be conducted with the key or power switch in the "off" position, the hood closed, and test cell fan(s) off, and the brake pedal not depressed.

- Manufacturers predetermine estimates of the mid-test constant speed cycle distance (dM) using the methods in SAE J1634, Appendix A.

- Mid-test constant speed cycles that do not exceed one hour do not need a key-off soak period. If the mid-test constant speed cycle exceeds one hour, the cycle needs to be separated into phases of less than one-hour, and a minimum 5-minute key-off soak is needed at the end of each phase.

- Using good engineering judgement, end-of-test constant speed cycles do not exceed 20 percent of total distance driven during the MCT, as described in SAE J1634, Section 8.3.3.

- End-of-test constant speed cycles that do not exceed one hour do not need key-off soak period. If the end-of-test constant speed cycle exceeds one hour, the cycle needs to be separated into phases of less than one-hour, and a minimum 5-minute key-off soak is needed at the end of each phase.

- Discharge energy that occurs during the key-off soak periods is not included in the useable battery energy.

- Recharging the vehicle's battery must start within three hours after testing.

- The Administrator may approve a manufacturer's request to use an earlier version of SAE J1634 for carryover vehicles.

- All label values related to fuel economy, energy consumption, and range must be based on 5-cycle testing, or values must be adjusted to be equivalent to 5-cycle results.

Manufacturers may request Administrator approval to use SAE J1634, Appendix B and Appendix C for determining 5-cycle adjustment factors.

## 2. Additional Light-Duty Changes Related to Certification Requirements and Measurement Procedures

We are proposing the following additional amendments related to

criteria standards and general certification requirements:

- 40 CFR part 85, subpart V: Correcting the warranty periods identified in the regulation to align with the Clean Air Act, as amended, and clarifying that the warranty provisions apply to both types of warranty specified in Clean Air Act section 207(a) and (b)—an emission defect warranty and an emission performance warranty. EPA adopted warranty regulations in 1980 to apply starting with model year 1981 vehicles (45 FR 34802, May 22, 1980). The Clean Air Act as amended in 1990 changed the warranty period for model year 1995 and later light-duty vehicles and light-duty trucks to 2 years or 24,000 miles of use (whichever occurs first), except that a warranty period of 8 years or 80,000 miles applied for specified major emission control components.

- Section 86.117–96: Revising paragraph (d)(1), which describes how to calculate evaporative emissions from methanol-fueled vehicles. The equation in the regulation inadvertently mimics the equation used for calculating evaporative emissions from gasoline-fueled vehicles. We are proposing to revise the equation to properly represent the fuel-specific calculations in a way that includes temperature correction for the sample volume based on the sample and SHED temperatures.

- Section 86.1810: Clarifying the certification responsibilities for cases involving small-volume manufacturers that modify a vehicle already certified by a different company and recertify the modified vehicle to the standards that apply for a new vehicle under 40 CFR part 86, subpart S. Since the original certifying manufacturer accounts for these vehicles in their fleet-average calculations, these secondary vehicle manufacturers should not be required to repeat those fleet-average calculations for the affected vehicles. This applies to fleet average standards for criteria exhaust emissions, evaporative emissions, and greenhouse gas emissions. The secondary vehicle manufacturer would need to meet all the same bin standards and family emission limits as specified by the original certifying manufacturer. We recently proposed a similar amendment (85 FR 28140, May 12, 2020), but chose to re-propose this to include greenhouse gas emissions in response to a comment, rather than finalizing a revised provision in that rulemaking.

- Section 86.1819–14: Clarifying that the definition of “engine code” for implementing heavy-duty greenhouse gas standards (Class 2b and 3) is the same “engine code” definition that

applies to light-duty vehicles in the part 600 regulations.

- Section 86.1823–08: Revising to specify a simulated test weight based on Loaded Vehicle Weight for light light-duty trucks (LDT1 and LDT2). The regulation inadvertently applies adjusted loaded vehicle weight, which is substantially greater and inappropriate for light light-duty trucks because they are most often used like lightly loaded passenger vehicles rather than cargo-carrying commercial trucks. In practice, we have been allowing manufacturers to implement test requirements for these vehicles based on Loaded Vehicle Weight. This proposed revision is responsive to manufacturers’ request to clarify test weights for the affected vehicles.

- Section 86.1843–01(f)(2): Delaying the end-of-year reporting deadline to May 1 following the end of the model year. Manufacturers requested that we routinely allow for later submissions instead of setting the challenging deadline of January 1 and allowing extensions.

We are proposing the following additional amendments related to greenhouse gas emissions and fuel economy testing:

- Section 86.1823: We are proposing to revise paragraph (m)(1) to reflect current business practices with respect to CO<sub>2</sub> durability requirements. For example, while conventional vehicles currently have a multiplicative CO<sub>2</sub> deterioration factor of one or an additive deterioration factor of zero to determine full useful life emissions for FTP and highway fuel economy tests, many plug-in hybrid electric vehicles have non-zero additive CO<sub>2</sub> deterioration factors (or manufacturers perform fuel economy tests using aged components). Proposed changes have no impact on conventional vehicles but strengthen the CO<sub>2</sub> durability requirements for plug-in hybrid electric vehicles.

- Section 600.002: Revising the definition of “engine code” to refer to a “test group” instead of an “engine-system combination”. This change reflects updated terminology corresponding to current certification procedures.

- Part 600, subpart B: Updating test procedures with references to 40 CFR part 1066 to reflect the migration of procedures from 40 CFR part 86, subpart B. The migrated test procedures allow us to delete the following obsolete regulatory sections: 600.106, 600.108, 600.109, 600.110, and 600.112, along with references to those sections.

- Sections 600.115 and 600.210: EPA issued guidance in 2015 for the fuel economy program to reflect technology

trends.<sup>952</sup> We are proposing to codify these changes in the regulation. First, as outlined in the EPA guidance letter and provisions of 40 CFR 600.210–12(a)(2)(iv), “[t]he Administrator will periodically update the slopes and intercepts through guidance and will determine the model year that the new coefficients must take effect.” Thus, we are proposing to update the coefficients used for calculating derived 5-cycle city and highway mpg values in Section 600.210 to be consistent with the coefficients provided in the 2015 EPA guidance letter and to be more representative of the fuel economy characteristics of the current fleet. Second, for reasons discussed on page 2 of the EPA guidance letter, we are proposing to codify a change to 40 CFR 600.115 to allow manufacturers to calculate derived 5-cycle fuel economy and CO<sub>2</sub> emission values using a factor of 0.7 only for battery electric vehicles, fuel cell vehicles, and plug-in hybrid electric vehicles (during charge depleting operation only).

- Section 600.210: The regulation already allows manufacturers to voluntarily decrease fuel economy values and raise CO<sub>2</sub> emission values if they determine that the values on the fuel economy label do not properly represent in-use performance. The expectation is that manufacturers would prefer not to include label values that create an unrealistic expectation for consumers. We are proposing to add a condition that the manufacturer may adjust these values only if the manufacturer changes both values and revises any other affected label value accordingly for a model type (including but not limited to the fuel economy 1–10 rating, greenhouse gas 1–10 rating, annual fuel cost, and 5-year fuel cost information). We are also proposing to extend these same provisions for electric vehicles and plug-in hybrid electric vehicles based on both increasing energy consumption values and lowering the electric driving range values.

- Section 600.311: Adding clarifying language to reference the adjusted driving ranges to reflect in-use driving conditions. These adjusted values are used for fuel economy labeling. For plug-in hybrid electric vehicles, we are also correcting terminology from “battery driving range” to “adjusted charge-depleting driving range (R<sub>cda</sub>)” for clarity and to be consistent with the terms used in SAE Recommended Practice J1711.

<sup>952</sup> “Derived 5-cycle Coefficients for 2017 and Later Model Years”, EPA Guidance Document CD-15–15, June 22, 2015.

- Section 600.510–12: Providing a more detailed cross reference to make sure manufacturers use the correct equation for calculating average combined fuel economy.

- Section 600.512–12: Delaying the deadline for the model year report from the end of March to May 1. The proposal aligns the deadline provisions with the proposed amendment for end-of-year reporting as described in 40 CFR 86.1843–01(f)(2).

#### F. Large Nonroad Spark-Ignition Engines (40 CFR Part 1048)

EPA's emission standards and certification requirements for land-based nonroad spark-ignition engines above 19 kW are set out in 40 CFR part 1048. We are proposing the following amendments to part 1048:

- Section 1048.501: Correct a mistaken reference to duty cycles in appendix II.
- Section 1048.620: Remove obsolete references to 40 CFR part 89.

#### G. Small Nonroad Spark-Ignition Engines (40 CFR Part 1054)

EPA's emission standards and certification requirements for land-based nonroad spark-ignition engines at or below 19 kW ("Small SI engines") are set out in 40 CFR part 1054. We recently proposed several amendments to part 1054 (85 FR 28140, May 12, 2020). Comments submitted in response to that proposed rule suggested additional amendments related to testing and certifying these Small SI engines. The following discussion addresses some of these suggested additional amendments that the EPA is proposing in this rule.

##### 1. Engine Test Speed

The duty cycle established for nonhandheld Small SI engines consists of six operating modes with varying load, and with engine speed corresponding to typical governed speed for the intended application. This generally corresponds to an "A cycle" with testing at 3060 rpm to represent a typical operating speed for a lawnmower, and a "B cycle" with testing at 3600 rpm to represent a typical operating speed for a generator. While lawnmowers and generators are the most common equipment types, there are many other applications with widely varying speed setpoints.

In 2020, we issued guidance to clarify manufacturers' testing responsibilities for the range of equipment using engines from a given emission family.<sup>953</sup> We are proposing to adopt the

provisions described in that guidance document. This includes two main items. First, we are proposing to identify all equipment in which the installed engine's governed speed at full load is at or above 3400 rpm as "rated-speed equipment", and all equipment in which the installed engine's governed speed at full load is below 3330 rpm as "intermediate-speed equipment". For equipment in which the installed engine's governed speed at full load is between 3330 and 3400 rpm, the engine manufacturer may consider that to be either "rated-speed equipment" or "intermediate-speed equipment". This allows manufacturers to reasonably divide their engine models into separate families for testing only on the A cycle or the B cycle, as appropriate. For emission families including both rated-speed equipment and intermediate-speed equipment, manufacturers would measure emissions over both the A cycle and the B cycle and certify based on the worst-case HC+NO<sub>x</sub> emission results.

Second, we are proposing to limit the applicability of the A cycle to engines with governed speed at full load that is at or above 2700 rpm, and limit the applicability of the B cycle to engines with governed speed at full load that is at or below 4000 rpm. These values represent an approximate 10 percent variation from the nominal test speed. For engines with governed speed at full load outside of these ranges, we propose to require that manufacturers use the provisions for special procedures in 40 CFR 1065.10(c)(2) to identify suitable test speeds for those engines. Manufacturers may take reasonable measures to name alternate test speeds to represent multiple engine configurations and equipment installations.

##### 2. Steady-State Duty Cycles

As noted in Section XII.G.1, the duty cycle for nonhandheld engines consists of a six-mode duty cycle including idle and five loaded test points. This cycle is not appropriate for engines designed to be incapable of operating with no load at a reduced idle speed. For many years, we have approved a modified five-mode duty cycle for these engines by removing the idle mode and reweighting the remaining five modes. We are proposing to adopt that same alternative duty cycle into the regulation and require its use for all engines that are not designed to idle. For emission families that include both types of engines, manufacturers would measure emissions over both the six-mode and five-mode duty cycles and

certify based on the worst-case HC+NO<sub>x</sub> emission results.

The discussion in Section XII.G.1 applies equally for nonhandheld engines whether or not they are designed to idle. As a result, if an emission family includes engines designed for idle with governed speeds corresponding to rated-speed equipment and intermediate-speed equipment, and engines in the same emission family that are not designed to idle have governed speeds corresponding to rated-speed equipment and intermediate-speed equipment, the manufacturer would need to perform A cycle and B cycle testing for both the six-mode duty cycle and the five-mode duty cycle. Manufacturers would then perform those four sets of emission measurements and certify based on the worst-case HC+NO<sub>x</sub> emission results.

The nonhandheld six-mode duty cycle in appendix II to 40 CFR part 1054 includes an option to do discrete-mode or ramped-modal testing. The ramped-modal test method involves collecting emissions during the established modes and defined transition steps between modes to allow manufacturers to treat the full cycle as a single measurement. With the new five-mode duty cycle, we would need to decide whether to again specify a corresponding ramped-modal duty cycle. We are proposing rather to remove the ramped-modal test option for the six-mode duty cycle. No manufacturer has ever used ramped-modal testing. This appears to be based largely on the greater familiarity with discrete-mode testing and on the sensitivity of small engines to small variations in speed and load. Rather than increasing the complexity of the regulation by multiplying the number of duty cycles, we are favoring the leaner approach of limiting tests to those tests that manufacturers have selected consistently over the years.

##### 3. Engine Family Criteria

Manufacturers requested that we allow open-loop and closed-loop engines to be included together in a certified emission family, with the testing demonstration for certification based on the worst-case configuration.

The key regulatory provision for this question is in 40 CFR 1054.230(b)(8), which says that engine configurations can be in the same emission family if they are the same in the "method of control for engine operation, other than governing (mechanical or electronic)".

Engine families are intended to group different engine models and configurations together if they will have similar emission characteristics throughout the useful life. The general

<sup>953</sup> "Small Spark-Ignition Nonhandheld Engine Test Cycle Selection," EPA guidance document CD-2020-06, May 11, 2020.

description of an engine's "method of control for engine operation" requires that EPA apply judgment to establish which fuel-system technologies should be eligible for treating together in a single engine family. We have implemented this provision by allowing open-loop and closed-loop engine configurations to be in the same emission family if they have the same design values for spark timing and targeted air-fuel ratio. This approach allows us to consider open-loop vs. closed-loop configurations as different "methods of control" when the engines have fundamentally different approaches for managing combustion. We do not intend to change this current practice and we are therefore not proposing to amend 40 CFR 1054.230 to address the concern about open-loop and closed-loop engine configurations.

The existing text of 40 CFR 1054.230(b)(8) identifies "mechanical or electronic" control to be fundamental for differentiating emission families. However, as is expected for open-loop and closed-loop configurations, we would expect engines with electronic throttle-body injection and mechanical carburetion to have very similar emission characteristics if they have the same design values for spark timing and targeted air-fuel ratio. A more appropriate example to establish a fundamental difference in method of control would be the contrast between port fuel injection and carburetion (or throttle-body injection). We are therefore proposing to revise the regulation with this more targeted example. This revision would allow manufacturers to group engine configurations with carburetion and throttle-body injection into a shared emission family as long as they have the same design values for spark timing and targeted air-fuel ratio.

#### 4. Miscellaneous Amendments for Small Nonroad Spark-Ignition Engines

We are proposing the following additional amendments to 40 CFR part 1054:

- Section 1054.115: Revising the description of prohibited controls to align with similar provisions from the regulations that apply for other sectors.
- Appendix I: Clarifying that requirements related to deterioration factors, production-line testing, and in-use testing did not apply for Phase 1 engines certified under 40 CFR part 90.

#### H. Recreational Vehicles and Nonroad Evaporative Emissions (40 CFR parts 1051 and 1060)

EPA's emission standards and certification requirements for

recreational vehicles are set out in 40 CFR part 1051, with additional specifications for evaporative emission standards in 40 CFR part 1060. We are proposing the following amendments to parts 1051 and 1060:

- Section 1051.115(d): Aligning the time and cost specification related to air-fuel adjustments with those that apply for mechanically adjustable parameters we are proposing in 40 CFR 1068.50(d)(1). This would create a uniform set of specifications for time and cost thresholds for all adjustable parameters including air-fuel ratio adjustment.
- Sections 1051.501(c) and 1060.515(c) and (d): Creating an exception to the ambient temperature specification for fuel-line testing to allow for removing the test article from an environmental chamber for daily weight measurements. This proposed change aligns with our recent change to allow for this same exception in the measurement procedure for fuel tank permeation (86 FR 34308, June 29, 2021).
- Section 1051.501(c): Specifying that fuel-line testing involves daily weight measurements for 14 days. This is consistent with the specifications in 40 CFR 1060.515. This proposed amendment codifies EPA's guidance to address these test parameters that are missing from the referenced SAE J30 test procedure.<sup>954</sup>
- Section 1051.501(d): Updating referenced procedures. The referenced procedure in 40 CFR 1060.810 is the 2006 version of ASTM D471. We inadvertently left the references in 40 CFR 1051.501 to the 1998 version of ASTM D471. Citing the standard without naming the version allows us to avoid a similar error in the future.
- Section 1051.515: Revising the soak period specification to allow an alternative of preconditioning fuel tanks at 43±5 °C for 10 weeks. The existing regulation allows for a soak period that is shorter and higher temperature than the specified soak of 28±5 °C for 20 weeks. This approach to an alternative soak period is the same as what is specified in 40 CFR 1060.520(b)(1).
- Section 1060.520: Adding "±" where that was inadvertently omitted in describing the temperature range that applies for soaking fuel tanks for 10 weeks.

We are proposing an additional amendment related to snowmobile emission standards. The original

<sup>954</sup> "Evaporative Permeation Requirements for 2008 and Later Model Year New Recreational Vehicles and Highway Motorcycles", EPA guidance document CD-07-02, March 26, 2007.

exhaust emission standards for snowmobiles in 40 CFR 1051.103 included standards for NO<sub>x</sub> emissions. However, EPA removed those NO<sub>x</sub> emission standards in response to an adverse court decision.<sup>955</sup> We are therefore proposing to remove the reference to NO<sub>x</sub> emissions in the description of emission credits for snowmobiles in 40 CFR 1051.740(b).

#### I. Marine Diesel Engines (40 CFR parts 1042 and 1043)

EPA's emission standards and certification requirements for marine diesel engines under the CAA are in 40 CFR part 1042. Emission standards and related fuel requirements that apply internationally are in 40 CFR part 1043.

##### 1. Production-Line Testing

Engine manufacturers have been testing production engines as described in 40 CFR part 1042. This generally involves testing up to 1 percent of production engines for engine families with production volumes greater than 100 engines. We adopted these testing provisions in 1999 with the expectation that most families would have production volumes greater than 100 engines per year (64 FR 73300, December 29, 1999). That was the initial rulemaking to set emission standards for marine diesel engines. As a result, there was no existing certification history to draw on for making good estimates of the number of engine families or the production volumes in those engine families. Now that we have almost 20 years of experience in managing certification for these engines, we can observe that manufacturers have certified a few engine families with production volumes substantially greater than 100 engines per year, but many engine families are not subject to production-line testing because production volumes are below 100 engines per year. As a result, manufacturers test several engines in large engine families, but many engine families have no production-line testing at all.

We are proposing to revise the production-line testing regimen for marine diesel engines to reflect a more tailored approach. The biggest benefit of production-line testing for this sector is

<sup>955</sup> "Bluewater Network vs. EPA, No. 03-1003, September Term, 2003" Available here: <https://www.govinfo.gov/content/pkg/USCOURTS-caDC-03-01249/pdf/USCOURTS-caDC-03-01249-0.pdf>. The Court found that the EPA had authority to regulate CO under CAA 213(a)(3) and HC under CAA 213(a)(4), but did not have authority to regulate NO<sub>x</sub> under CAA 213(a)(4) as it was explicitly referred to in CAA 213(a)(2) and CAA 213(a)(4) only grants authority to regulate emissions "not referred to in paragraph (2)."

to confirm that engine manufacturers can go beyond the prototype engine build for certification and move to building compliant engines in a production environment. From this perspective, the first test is of most value, with additional tests adding assurance of proper quality control procedures for ongoing production. Additional testing might also add value to confirm that design changes and updated production practices over time do not introduce problems.

We are proposing to set up a default engine sampling rate of one test per family. An engine test from a prior year would count as a sufficient demonstration as long as the manufacturer certifies the engine family using carryover emission data. At the same time, we are proposing to remove the testing exemption for small-volume engine manufacturers and low-volume engine families. In summary, this approach would:

- Remove the testing exemption for low-volume families and small-volume manufacturers, and remove the 1 percent sampling rate. Revise the engine sampling instruction to require one test for each family. A test from a prior year can meet the test requirement for carryover families. This includes tests performed before these changes to the regulation become effective. This may also involve shared testing for recreational and commercial engine families if they rely on the same emission-data engine.
- Require a single test engine randomly selected early in the production run. EPA may direct the manufacturer to select a specific configuration and build date. The manufacturer continues to be subject to the requirement to test two more engines for each failing engine, and notify EPA if an engine family fails.
- Require a full test report within 45 days after testing is complete for the family. There would be no additional quarterly report or annual reports.
- Allow manufacturers to transition to the new test requirements by spreading out tests over multiple years if several engine families are affected. Small-volume engine manufacturers would need to test no more than two engine families in a single model year, and other engine manufacturers would need to test no more than four engine families in a single model year.
- Allow EPA to withhold approval of a request for certification for a family for a given year if PLT work from the previous model year is not done.
- Preserve EPA's ability to require an additional test in the same model year or a later model year for cause even after

there was a passing result based on any reasonable suspicion that engines may not meet emission standards.

In our recent rule proposing several regulatory amendments to Marine CI provisions in 40 CFR part 1042 (and several other sectors), we requested comment on changes to production-line testing that were very similar to what we are proposing in this document (85 FR 28140, May 12, 2020). That proposed rule referenced a memorandum with draft regulatory amendments.<sup>956</sup> The provisions in this proposal include the following adjustments to reflect the input shared by commenters:

- The start of testing must occur within 60 days after production starts for a given Category 1 engine family, with an accommodation for low-volume families that specifies that the engine manufacturer must test the next engine produced if the 60-day time frame is not sufficient for selecting a test engine.
- The same provisions apply for selecting a Category 2 engine for testing, except that the 60-day period for engine selection starts after the manufacturer produces the fifth engine from an engine family. This approach is reflective of the production volumes that are typical for Category 2 engines.
- For the additional testing that is required after failing results, we specify a 90-day time frame in case the engine family's production volumes are too low to resume testing after producing 15 engines.
- We are keeping the requirement to randomly select production engines for testing, but we are clarifying that (1) the fundamental feature of random selection is to ensure that test engines have been assembled using the same instructions, procedures, and quality-control oversight that applies for other production engines and (2) random selection can include preferentially selecting engines earlier than we specify. For example, a manufacturer may randomly select a test engine for a high-volume Category 1 engine family in the first 20 days of production instead of randomly selecting a test engine from the first 60 days of production.
- There are no test requirements until after the manufacturer starts production for a given engine family.

The proposal giving us the discretion to require additional testing for cause would include a more detailed description to illustrate the types of concerns that would lead us to identify

the need for additional testing. Reporting defects for an engine family would raise such a concern. In addition, amending applications for certification might also raise concerns.<sup>957</sup> Decreasing an engine family's Family Emission Limit without submitting new emission data would be a concern because the manufacturer would appear to be creating credits from what was formerly considered a necessary compliance margin. Changing suppliers or specifications for critical emission-related components would raise concerns about whether the emission controls system is continuing to meet performance expectations. Adding a new or modified engine configuration always involves a judgment about whether the original test data continue to represent the worst-case configuration for the expanded family. In any of these cases, we may direct the manufacturer to perform an additional test with a production engine to confirm that the family meets emission standards. In addition to these specific concerns, we expect manufacturers to have a greater vigilance in making compliant products if they know that they may need to perform additional testing. Conversely, removing the possibility of further testing for the entirety of a production run spanning several years could substantially weaken our oversight presence to ensure compliance.

The net effect of the proposed production-line test changes would be a substantial decrease in overall testing. We estimate industry-wide testing will decrease by about 30 engines per year. Spreading test requirements more widely across the range of engine families should allow for a more effective program in spite of the reduced testing rate. We acknowledge that some individual companies will test more engines under the proposal; however, by limiting default test rates to one per engine family, including future years, this would represent a small test burden even for the companies with new or additional testing requirements.

We request comment on the timing for starting the transition to the new approach, including any appropriate adjustments to the maximum annual test rate for small-volume and other engine manufacturers. We request comment on adjusting the criteria by which we would treat different engine families to be the same for purposes of production-line testing. We request

<sup>956</sup> "Alternative Production-Line Testing Requirements for Marine Diesel Engines," EPA memorandum from Alan Stout to Docket EPA-HQ-OAR-2019-0307, January 23, 2020.

<sup>957</sup> In this context, making the described changes in an application for certification applies equally for running changes within a model year and for changes that are introduced at the start of a new model year.



comment on the test schedule, especially for balancing the different dynamics that apply for high-volume, low-volume, and seasonal engines. We request comment on our attempt to clarify that engines must be randomly selected even for the most challenging cases of low-volume production and carefully constructed timelines. We request comment on the schedule for reporting test results to properly balance the interests of timely submissions with the practical realities of assembling the information. We request comment on the proposed criteria to inform our decision-making for requiring additional testing beyond the mandatory first test engine; this may include clarification or adjustment of the proposed criteria, and it may include consideration of additional criteria that would support a concern for ongoing compliance. More generally, we request comment on all aspects of the proposed approach for sampling and testing production engines to achieve the benefits of EPA's effective compliance oversight at a reasonable level of testing for manufacturers.

We are proposing two additional clarifications related to production-line testing. First, we are clarifying that test results from the as-built engine are the final results to represent that engine. Manufacturers may modify the test engine to develop alternative strategies or to better understand the engine's performance; however, testing from those modified engines do not represent the engine family unless the manufacturer changes their production processes for all engines to match those engine modifications. Testing modified engines to meet production-line testing obligations would count as a separate engine rather than replacing the original test results.

Second, we are clarifying that Category 3 auxiliary engines exempted from EPA certification under part 1042 continue to be subject to production-line testing under 40 CFR 1042.305. This question came up because we recently amended 40 CFR 1042.650(d) to allow Category 3 auxiliary engines installed in certain ships to meet Annex VI certification requirements instead of EPA certification requirements under part 1042 (86 FR 34308, June 29, 2021). As with Category 1 and Category 2 engines covered by production-line testing requirements in 40 CFR 1042.301, these test requirements apply for all engines subject to part 1042, even if they are not certified under part 1042.

## 2. Applying Reporting Requirements to EGR-Equipped Engines

EPA has received comments suggesting that we apply the SCR-related monitoring and reporting requirements in 40 CFR 1042.660(b) to engines that instead use exhaust gas recirculation (EGR) to meet Tier 4 standards. We understand SCR and EGR to be fundamentally different in ways that lead us not to propose this suggested change.

### i. Maintenance

There are two principal modes of EGR failure: (1) Failure of the valve itself (physically stuck or not able to move or adjust within normal range) and (2) EGR cooler fouling. EGR cooler maintenance is typically listed in the maintenance instructions provided by engine manufacturers to owners. If done according to the prescribed schedule, this should prevent fouling of the EGR cooler. Similarly, EGR valves typically come with prescribed intervals for inspection and replacement. For both components, the intervals are long and occur at the time that other maintenance is routinely performed. Under 40 CFR 1042.125(a)(2), the minimum interval for EGR-related filters and coolers is 1500 hours, and the minimum interval for other EGR-related components is either 3000 hours or 4500 hours depending on the engine's max power.

In contrast, SCR systems depend on the active, ongoing involvement of the operator to maintain an adequate supply of Diesel Exhaust Fluid (DEF) as a reductant to keep the catalyst functioning properly. EPA does not prescribe the size of DEF storage tanks for vessels, but the engine manufacturers provide installation instructions with recommendations for tank sizing to ensure that enough DEF is available onboard for the duration of a workday or voyages between ports. At the frequencies that this fluid needs replenishing, it would not be expected that other routine maintenance must also be performed, aside from refueling.

DEF consumption from marine diesel engines is estimated to be 3–8 percent of diesel fuel consumption. Recommended DEF tank sizes are generally about 10 percent of the onboard fuel storage, with the expectation that operators would refill DEF tanks during a refueling event.

Another point of contrast is that SCR systems have many failure modes in addition to the failure to maintain an adequate supply of reductant. For example, dosing could stop due to faulty sensors, malfunctions of

components in the reductant delivery system, or freezing of the reductant.

Over the years of implementing regulations for which SCR is the adopted technology, EPA has produced several guidance documents to assist manufacturers in developing approvable SCR engine designs.<sup>958 959 960</sup> Many of the features implemented to assure that SCR systems are properly maintained by vehicle and equipment operators are not present with systems on marine vessels. Thus, we rely on the reporting provision of 40 CFR 1042.660(b) to enhance our assurance that maintenance will occur as prescribed.

### ii. Tampering

Engine manufacturers and others have asked questions about generation of condensate from an EGR-equipped engine. This condensate is an acidic liquid waste that must be discharged in accordance with water quality standards (and IMO, USCG, local port rules). The Tier 4 EGR-equipped engines that EPA has certified are believed to generate a very small amount of EGR condensate. Larger quantities of condensate may be generated from an aftercooler, but that is non-acidic, non-oily water that would generally not need to be held onboard or treated. In the absence of compelling information to the contrary, we believe that the burden of storing, treating, and discharging the EGR condensate is not great enough to motivate an operator to tamper with the engine.

Most EGR-equipped engines have internal valves and components that are not readily accessible to operators. In these cases, the controls to activate or deactivate EGR are engaged automatically by the engine's electronic control module and are not vulnerable to operator tampering. Where an engine design has external EGR, even though emission-related components may be somewhat accessible to operators, the controls are still engaged automatically by the engine's electronic control module and continued compliance is ensured if prescribed maintenance is performed on schedule and there is no tampering.

### iii. Nature of the Risk

There are five manufacturers actively producing hundreds of certified Category 1 marine diesel engines each year using EGR to achieve Tier 3

<sup>958</sup> "Revised Guidance for Certification of Heavy-Duty Diesel Engines Using Selective Catalyst Reduction (SCR) Technologies", EPA guidance document C1SD-09-04, December 30, 2009.

<sup>959</sup> "Nonroad SCR Certification", EPA Webinar Presentation, July 26, 2011.

<sup>960</sup> "Certification of Nonroad Diesel Engines Equipped with SCR Emission Controls", EPA guidance document CD-14-10, May 12, 2014.

emission standards. Nobody has suggested that these EGR controls are susceptible to tampering or malmaintenance.

There is one manufacturer who has certified two Category 3 marine diesel engine families using EGR to achieve the Tier 3 emission standards for these large engines. If there is any risk with these, it's that the ocean-going vessel may not visit an ECA often enough to exercise the EGR valve and prevent it from getting corroded or stuck. These engines are already subject to other onboard diagnostics and reporting requirements, so we expect no need to expand 40 CFR 1042.660(b) for these engines.

There is one manufacturer producing Category 2 marine diesel engines using EGR to achieve the Tier 4 emission standards. We again do not see the need to include them in the reporting scheme in 40 CFR 1042.660(b).

### 3. Miscellaneous Amendments for Marine Diesel Engines

We are proposing the following additional amendments for our marine diesel engine program:

- Sections 1042.110 and 1042.205: Revising text to refer to “warning lamp” instead of “malfunction indicator light” to prevent confusion with conventional onboard diagnostic controls. This aligns with changes adopted for land-based nonroad diesel engines in 40 CFR part 1039. We are also clarifying that the manufacturers description of the diagnostic system in the application for certification should identify which communication protocol the engine uses.

- Section 1042.110: Revising text to refer more broadly to detecting a proper supply of Diesel Exhaust Fluid to recognize, for example, that a closed valve may interrupt the supply (not just an empty tank).

- Section 1042.115: Revising provisions related to adjustable parameters, as described in Section XII.H.1.

- Section 1042.115: Adding provisions to address concerns related to vanadium sublimation, as described in Section XII.B.

- Section 1042.615: Clarifying that engines used to repower a steamship may be considered to qualify for the replacement engine exemption. This exemption applies relative to EPA standards in 40 CFR part 1042. We are also proposing to amend 40 CFR 1043.95 relative to the application of MARPOL Annex VI requirements for repowering Great Lakes steamships.

- Section 1042.660(b): Revising the instruction for reporting related to

vessel operation without reductant for SCR-equipped engines to describe the essential items to be reported, which includes the cause, the remedy, and an estimate of the extent of operation without reductant. We are also proposing to revise the contact information for reporting, and to clarify that the reporting requirement applies equally for engines that meet standards under MARPOL Annex VI instead of or in addition to meeting EPA standards under part 1042. We are also aware that vessel owners may choose to voluntarily add SCR systems to engines certified without aftertreatment; we propose to clarify that the reporting requirement of 40 CFR 1042.660(b) does not apply for these uncertified systems. These changes are intended to clarify the reporting instructions for manufacturers under this provision rather than creating a new reporting obligation. We request comment on adjusting these information requirements to meet the goal of providing essential information with a minimal reporting burden.

- Section 1042.901: Clarifying that the displacement value differentiating Category 1 and Category 2 engines subject to Tier 1 and Tier 2 standards was 5.0 liters per cylinder, rather than the value of 7.0 liters per cylinder that applies for engines subject to Tier 3 and Tier 4 standards.

- Part 1042, appendix I: Correcting the decimal places to properly identify the historical Tier 1 and Tier 2 PM standards for 19–37 kW engines.

- Section 1043.20: Revising the definition of “public vessel” to clarify how national security exemptions relate to applicability of requirements under MARPOL Annex VI. Specifically, vessels with an engine-based national security exemption are exempt from NO<sub>x</sub> standards under MARPOL Annex VI, and vessels with a fuel-based national security exemption are exempt from the fuel standards under MARPOL Annex VI. Conversely, an engine-based national security exemption does not automatically exempt a vessel from the fuel standards under MARPOL Annex VI, and a fuel-based national security exemption does not automatically exempt a vessel from the NO<sub>x</sub> standards under MARPOL Annex VI. These distinctions are most likely to come into play for merchant marine vessels that are intermittently deployed for national (noncommercial) service.

- Section 1043.55: Revising text to clarify that U.S. Coast Guard is the approving authority for technologies that are equivalent to meeting sulfur standards under Regulation 4 of MARPOL Annex VI.

- Section 1043.95: Expanding the Great Lakes steamship provisions to allow for engine repowers to qualify for the replacement engine exemption in Annex VI, Regulation 13.2.2. This allows EPA to approve a ship owner's request to install engines meeting the IMO Tier II NO<sub>x</sub> standard. Since meeting the IMO Tier III NO<sub>x</sub> standard for such a repower project would be cost-prohibitive, this proposed provision is intended to create an incentive for shipowners to upgrade the vessel by replacing the steam boilers with IMO Tier II engines, with very substantial expected reductions in NO<sub>x</sub>, PM, and CO<sub>2</sub> emissions compared to emission rates from continued operation as steamships. We are also proposing to simplify the fuel-use exemption for Great Lakes steamships to allow for continued use of high-sulfur fuel for already authorized steamships, while recognizing that the fuel-use exemption is no longer available for additional steamships.

#### *J. Locomotives (40 CFR Part 1033)*

EPA's emission standards and certification requirements for locomotives and locomotive engines are in 40 CFR part 1033. This proposed rule includes several amendments that affect locomotives, as discussed in Sections XI.A and XI.L.

We are proposing to amend 40 CFR 1033.815 to clarify how penalty provisions apply relative to maintenance and remanufacturing requirements. We have become aware that the discussion of violations and penalties in 40 CFR 1033.815(f) addresses failure to perform required maintenance but omits reference to the recordkeeping requirements described in that same regulatory section. We originally adopted the maintenance and recordkeeping requirements with a statement describing that failing to meet these requirements would be considered a violation of the tampering prohibition in 40 CFR 1068.101(b)(1). The requirement for owners to keep records for the specified maintenance are similarly tied to the tampering prohibition, but failing to keep required records cannot be characterized as a tampering violation per se. As a result, we are proposing to clarify that a failure to keep records violates 40 CFR 1068.101(a)(2).

We are also proposing to amend 40 CFR 1033.815(f) to specifically name the tampering prohibition as the relevant provision related to maintenance requirements for locomotives, rather than making a more general reference to prohibitions in 40 CFR 1068.101.

We are also proposing to amend 40 CFR 1033.525 to remove the smokemeter requirements and replace them with a reference to 40 CFR 1065.1125, which we are proposing as the central location for all instrument and setup requirements for measuring smoke. We are also proposing to add data analysis requirements for locomotives to 40 CFR 1033.525 that were never migrated over from 40 CFR 92.131; manufacturers still use these procedures to analyze and submit smoke data for certifying locomotives. It is our understanding is that all current smoke testing includes computer-based analysis of measured results; we are therefore proposing to remove the references to manual or graphical analysis of smoke test data.

Finally, we are proposing to amend 40 CFR 1033.1 to clarify that 40 CFR part 1033 applies to engines that were certified under part 92 before 2008. We are also proposing to remove 40 CFR 1033.102 and revise 40 CFR 1033.101 and appendix A of part 1033 to more carefully describe how locomotives were subject to different standards in the transition to the standards currently specified in 40 CFR 1033.101.

#### *K. Stationary Compression-Ignition Engines (40 CFR Part 60, Subpart III)*

EPA's emission standards and certification requirements for stationary compression-ignition engines are in 40 CFR part 60, subpart III. Section 60.4202 establishes emission standards for stationary emergency compression-ignition engines. We are proposing to correct a reference in 40 CFR 60.4202 to the Tier 3 standards for marine engines contained in 40 CFR part 1042. EPA emission standards for certain engine power ratings go directly from Tier 2 to Tier 4. Such engines are never subject to Tier 3 standards, so the reference in 40 CFR 60.4202 is incorrect. Section 60.4202 currently describes the engines as those that otherwise "would be subject to the Tier 4 standards". We propose to amend the regulation to more broadly refer to the "previous tier of standards" instead of naming Tier 3. In most cases, this would continue to apply the Tier 3 standards for these engines, but the Tier 2 standards would apply if there was no applicable Tier 3 standard.

#### **XIII. Statutory and Executive Order Reviews**

Additional information about these statutes and Executive Orders can be found at <http://www.epa.gov/laws-regulations/laws-and-executive-orders>.

#### *A. Executive Order 12866: Regulatory Planning and Review and Executive Order 13563: Improving Regulation and Regulatory Review*

This action is an economically significant regulatory action that was submitted to the Office of Management and Budget (OMB) for review. Any changes made in response to OMB recommendations have been documented in the docket. EPA prepared an analysis of the potential costs and benefits associated with this action. This analysis, the draft "Regulatory Impact Analysis—Control of Air Pollution from New Motor Vehicles: Heavy-Duty Engine and Vehicle Standards NPRM," is available in the docket. The analyses contained in this document are also summarized in Sections V, VI, VII, VIII, IX, X, and XI of this preamble.

#### *B. Paperwork Reduction Act (PRA)*

The information collection activities in this proposed rule have been submitted for approval to the Office of Management and Budget (OMB) under the PRA. The Information Collection Request (ICR) document that EPA prepared has been assigned EPA ICR Number 2621.01. You can find a copy of the ICR in the docket for this rule, and it is briefly summarized here.

The proposed rule builds on existing certification and compliance requirements required under title II of the Clean Air Act (42 U.S.C. 7521 *et seq.*). Existing requirements are covered under two ICRs: (1) EPA ICR Number 1684.20, OMB Control Number 2060–0287, Emissions Certification and Compliance Requirements for Nonroad Compression-ignition Engines and On-highway Heavy Duty Engines; and (2) EPA ICR Number 1695.14, OMB Control Number 2060–0338, Certification and Compliance Requirements for Nonroad Spark-ignition Engines. Therefore, this ICR only covers the incremental burden associated with the updated regulatory requirements as described in the proposed rule. The resulting burden and costs estimates may be updated in response to additional input the Agency receives in comments on the proposed regulatory changes and to reflect any updates or revisions in the final rule.

- Respondents/affected entities: The entities potentially affected by this action are manufacturers of engines and vehicles in the heavy-duty on-highway industries, including alternative fuel converters, secondary vehicle manufacturers, and electric vehicle manufacturers. Manufacturers of light-duty vehicles, light-duty trucks, marine diesel engines, locomotives, and various

types of nonroad engines, vehicles, and equipment may be affected to a lesser degree.

- Respondent's obligation to respond: Regulated entities must respond to this collection if they wish to sell their products in the United States, as prescribed by CAA section 203(a). Participation in some programs is voluntary; but once a manufacturer has elected to participate, it must submit the required information.

- Estimated number of respondents: Approximately 279 (total).

- Frequency of response: Annually or On Occasion, depending on the type of response.

- Total estimated burden: 24,214 hours per year. Burden is defined at 5 CFR 1320.03(b).

- Total estimated cost: \$5,694,258 (per year), includes an estimated \$3,729,550 annualized capital or maintenance and operational costs.

An agency may not conduct or sponsor, and a person is not required to respond to, a collection of information unless it displays a currently valid OMB control number. The OMB control numbers for EPA's regulations in 40 CFR are listed in 40 CFR part 9.

Submit your comments on the Agency's need for this information, the accuracy of the provided burden estimates and any suggested methods for minimizing respondent burden to EPA using the docket identified at the beginning of this rule. You may also send your ICR-related comments to OMB's Office of Information and Regulatory Affairs via email to [OIRA\\_submission@omb.eop.gov](mailto:OIRA_submission@omb.eop.gov). Attention: Desk Officer for EPA. Since OMB is required to make a decision concerning the ICR between 30 and 60 days after receipt, OMB must receive comments no later than April 27, 2022. EPA will respond to any ICR-related comments in the final rule.

#### *C. Regulatory Flexibility Act (RFA)*

I certify that this action will not have a significant economic impact on a substantial number of small entities under the RFA. The small entities subject to the requirements of this proposed action are heavy-duty alternative fuel engine converters, heavy-duty electric vehicle manufacturers, a heavy-duty conventional vehicle manufacturer, and heavy-duty secondary vehicle manufacturers. While the proposed rule also includes regulatory amendments for sectors other than highway heavy-duty engines and vehicles, these amendments for other sectors correct, clarify, and streamline the regulatory provisions, and there is no burden from

the proposed rule on small entities in these other sectors.

We identified 265 small entities in the heavy-duty sector that would be subject to the proposed rule: Two heavy-duty alternative fuel engine converters, 13 electric vehicle manufacturers, one conventional vehicle manufacturer, and 249 heavy-duty secondary vehicle manufacturers. The Agency has determined that 217 of the 265 small entities subject to the rule would experience an impact of less than 1 percent of annual revenue; 48 small entities would experience an impact of 1 to less than 3 percent of annual revenue; and no small entity would experience an impact of 3 percent or greater of annual revenue. Specifically, the two alternative fuel engine converters, the 13 electric vehicle manufacturers, the conventional vehicle manufacturer, and 201 secondary vehicle manufacturers would experience an impact of less than 1 percent of annual revenue, and 48 secondary vehicle manufacturers would experience an impact of 1 to less than 3 percent of annual revenue. Details of this analysis are presented in Chapter 11 of the draft RIA.

#### *D. Unfunded Mandates Reform Act (UMRA)*

This proposed rule contains no federal mandates under UMRA, 2 U.S.C. 1531–1538, for State, local, or Tribal governments. The proposed rule would impose no enforceable duty on any State, local or Tribal government. This proposed rule would contain a federal mandate under UMRA that may result in expenditures of \$100 million or more for the private sector in any one year. Accordingly, the costs and benefits associated with the proposed rule are discussed in Section IX and in the draft RIA, which are in the docket for this rule.

This action is not subject to the requirements of section 203 of UMRA because it contains no regulatory requirements that might significantly or uniquely affect small governments.

#### *E. Executive Order 13132: Federalism*

This proposed rule does not have federalism implications. It will not have substantial direct effects on states, on the relationship between the national government and states, or on the distribution of power and responsibilities among the various levels of government.

#### *F. Executive Order 13175: Consultation and Coordination With Indian Tribal Governments*

This action does not have Tribal implications as specified in Executive Order 13175. Thus, Executive Order 13175 does not apply to this action. This action does not have substantial direct effects on one or more Indian tribes, on the relationship between the Federal Government and Indian tribes, or on the distribution of power and responsibilities between the Federal Government and Indian tribes. However, EPA plans to continue engaging with Tribal stakeholders in the development of this rulemaking by offering a Tribal workshop and offering government-to-government consultation upon request.

#### *G. Executive Order 13045: Protection of Children From Environmental Health and Safety Risks*

This action is subject to Executive Order 13045 because it is an economically significant regulatory action as defined by Executive Order 12866, and EPA believes that the environmental health risks or safety risks addressed by this action may have a disproportionate effect on children. Accordingly, we have evaluated the environmental health or safety effects of air pollutants affected by the proposed program on children. The results of this evaluation are described in Section II regarding the Need for Additional Emissions Control and associated references in Section II.

Children are more susceptible than adults to many air pollutants because of differences in physiology, higher per body weight breathing rates and consumption, rapid development of the brain and bodily systems, and behaviors that increase chances for exposure. Even before birth, the developing fetus may be exposed to air pollutants through the mother that affect development and permanently harm the individual.

Infants and children breathe at much higher rates per body weight than adults, with infants under one year of age having a breathing rate up to five times that of adults.<sup>961</sup> In addition, children breathe through their mouths more than adults and their nasal passages are less effective at removing

<sup>961</sup> U.S. Environmental Protection Agency. (2009). Metabolically-derived ventilation rates: A revised approach based upon oxygen consumption rates. Washington, DC: Office of Research and Development. EPA/600/R-06/129F. <http://cfpub.epa.gov/ncea/cfm/recordisplay.cfm?deid=202543>.

pollutants, which leads to a higher deposition fraction in their lungs.<sup>962</sup>

Certain motor vehicle emissions present greater risks to children as well. Early lifestages (e.g., children) are thought to be more susceptible to tumor development than adults when exposed to carcinogenic chemicals that act through a mutagenic mode of action.<sup>963</sup> Exposure at a young age to these carcinogens could lead to a higher risk of developing cancer later in life. Section II.B.7 describes a systematic review and meta-analysis conducted by the U.S. Centers for Disease Control and Prevention that reported a positive association between proximity to traffic and the risk of leukemia in children.

The adverse effects of individual air pollutants may be more severe for children, particularly the youngest age groups, than adults. As described in Section II.B, the Integrated Science Assessments for a number of pollutants affected by this rule, including those for NO<sub>2</sub>, PM, ozone and CO, describe children as a group with greater susceptibility. Section II.B.7 discusses a number of childhood health outcomes associated with proximity to roadways, including evidence for exacerbation of asthma symptoms and suggestive evidence for new onset asthma.

There is substantial evidence that people who live or attend school near major roadways are more likely to be of a minority race, Hispanic ethnicity, and/or low SES. Within these highly exposed groups, children's exposure and susceptibility to health effects is greater than adults due to school-related and seasonal activities, behavior, and physiological factors.

Section VI.B of this preamble presents the estimated emissions reductions from the proposed rule, including substantial reductions in NO<sub>x</sub> and other criteria and toxic pollutants. Section VII of this preamble presents the air quality impacts of the proposed rule. The air quality modeling predicts decreases in ambient concentrations of air pollutants in 2045 due to the proposed standards, including significant improvements in ozone concentrations. Ambient PM<sub>2.5</sub>, NO<sub>2</sub> and CO concentrations are also predicted to improve in 2045 because of the proposed program.

<sup>962</sup> Foos, B.; Marty, M.; Schwartz, J.; Bennet, W.; Moya, J.; Jarabek, A.M.; Salmon, A.G. (2008) Focusing on children's inhalation dosimetry and health effects for risk assessment: An introduction. *J Toxicol Environ Health* 71A: 149–165.

<sup>963</sup> U.S. Environmental Protection Agency. (2005). Supplemental guidance for assessing susceptibility from early-life exposure to carcinogens. Washington, DC: Risk Assessment Forum. EPA/630/R-03/003F. [http://www.epa.gov/raf/publications/pdfs/childrens\\_supplement\\_final.pdf](http://www.epa.gov/raf/publications/pdfs/childrens_supplement_final.pdf).

Children are not expected to experience greater ambient concentrations of air pollutants than the general population. However, because of their greater susceptibility to air pollution and their increased time spent outdoors, it is likely that the proposed standards would have particular benefits for children’s health.

*H. Executive Order 13211: Actions Concerning Regulations That Significantly Affect Energy Supply, Distribution, or Use*

This action is not a “significant energy action” because it is not likely to have a significant adverse effect on the supply, distribution, or use of energy. In fact, this proposal has an incremental positive impact on energy supply and use. Section III.E and Section V describe

our projected fuel savings due to the proposed refueling emissions standards for certain Spark-ignition HDE. These refueling emission standards would require manufacturers to implement emission control systems to recover evaporative emissions that would otherwise be emitted to the ambient air during a refueling event for use in those engines. Considering the estimated incremental fuel savings from the proposed refueling emissions standards, we have concluded that this proposal is not likely to have any adverse energy effects.

*I. National Technology Transfer and Advancement Act (NTTAA) and 1 CFR Part 51*

This action involves technical standards. Except for the standards

discussed below, the standards included in the regulatory text as incorporated by reference were all previously approved for IBR and no change is included in this action.

In accordance with the requirements of 1 CFR 51.5, we are proposing to incorporate by reference the use of test methods and standards from ASTM International (ASTM). The referenced standards and test methods may be obtained through the ASTM website ([www.astm.org](http://www.astm.org)) or by calling (610) 832–9585. If ASTM adopts an updated version of the referenced standards, we would expect to reference the most recent version. We are proposing to incorporate by reference the following ASTM standards:

Standard or test method	Regulation	Summary
ASTM D975–21, Standard Specification for Diesel Fuel”.	40 CFR 1036.415(c) and 1036.810(a) .....	Fuel specification needed for manufacturer-run field-testing program. This is a newly referenced standard.
ASTM D4814–21c, Standard Specification for Automotive Spark-Ignition Engine Fuel.	40 CFR 1036.415(c) and 1036.810(a) .....	Fuel specification needed for manufacturer-run field-testing program. This is a newly referenced standard.
ASTM D7467–20a, Standard Specification for Diesel Fuel Oil, Biodiesel Blend (B6 to B20).	40 CFR 1036.415(c) and 1036.810(a) .....	Fuel specification needed for manufacturer-run field-testing program. This is a newly referenced standard.

In accordance with the requirements of 1 CFR 51.5, we are proposing to incorporate by reference the use of test methods and standards from SAE

International. The referenced standards and test methods may be obtained through the SAE International website ([www.sae.org](http://www.sae.org)) or by calling (800) 854–

7179. We are proposing to incorporate by reference the following SAE International standards and test methods:

Standard or test method	Regulation	Summary
SAE J1634, July 2017, Battery Electric Vehicle Energy Consumption and Range Test Procedure.	40 CFR 600.011(c), 600.116–12(a), 600.210–12(d), and 600.311–12(j) and (k). 40 CFR 1066.501(a) and 1066.1010(b).	The procedure describes how to measure energy consumption and range from electric vehicles. This is an updated version of the document currently specified in the regulation.
SAE J1711, June 2010, Recommended Practice for Measuring the Exhaust Emissions and Fuel Economy of Hybrid-Electric Vehicles, Including Plug-In Hybrid Vehicles.	40 CFR 1066.501(a), 1066.1001, and 1066.1010(b).	The recommended practice describes how to measure fuel economy and emissions from light-duty vehicles, including hybrid-electric vehicles. This proposal cites the reference document in an additional place in the regulation.
SAE J1979–2, April 22, 2021, E/E Diagnostic Test Modes: OBDOnUDS.	40 CFR 1036.150(v) and 1036.810(e) .....	The standard includes information describing interface protocols for onboard diagnostic systems. This is a newly referenced standard.
SAE J2263, May 2020, Road Load Measurement Using Onboard Anemometry and Coastdown Techniques.	40 CFR 1037.528 introductory text, (a), (b), (d), and (f), 1037.665(a), and 1037.810(e). 40 CFR 1066.301(b), 1066.305, 1066.310(b), 1066.1010(b).	The procedure describes how to perform coastdown measurements with light-duty and heavy-duty vehicles. This is an updated version of the document currently specified in the regulation.
SAE J2711, May 2020, Recommended Practice for Measuring Fuel Economy and Emissions of Hybrid-Electric and Conventional Heavy-Duty Vehicles.	40 CFR 1066.501(a) and 1066.1010(b) .....	The recommended practice describes how to measure fuel economy and emissions from heavy-duty vehicles, including hybrid-electric vehicles. This is an updated version of the document currently specified in the regulation.
SAE J2841, March 2009, Utility Factor Definitions for Plug-In Hybrid Electric Vehicles Using 2001 U.S. DOT National Household Travel Survey Data.	40 CFR 1037.550(a) and 1037.810(e) .....	The standard practice establishes terminology and procedures for calculating emission rates and fuel consumption for plug-in hybrid electric vehicles.

In accordance with the requirements of 1 CFR 51.5, we are proposing to incorporate by reference the use of test methods and standards from the International Organization for Standardization (ISO). This reference standard is intended to support

proposed changes to labeling for heavy-duty engines. We request comment on the need or benefit of amending the regulation to cite this same document where we currently use an older version of the same reference standard for fuel economy labels (see 40 CFR part 600,

subpart D). The referenced standards and test methods may be obtained through the ISO website ([www.iso.org](http://www.iso.org)) or by calling (41) 22749 0111. We propose to incorporate by reference the following ISO standard:

Standard or test method	Regulation	Summary
ISO/IEC 18004:2015(E), February 2015, Information technology—Automatic identification and data capture techniques—QR Code bar code symbology specification, Third Edition.	40 CFR 1036.135(c) and 1036.810(c) .....	The standard specifies a standardized code protocol for including on engines' emission control information labels. This is a newly referenced standard.

In accordance with the requirements of 1 CFR 51.5, we are proposing to incorporate by reference the use of test methods and standards from the Idaho

National Laboratory. The referenced standards and test methods may be obtained through the Idaho National Laboratory website ([www.inl.gov](http://www.inl.gov)) or by

calling (866) 495-7440. We propose to incorporate by reference the following test methods:

Standard or test method	Regulation	Summary
U.S. Advanced Battery Consortium, Electric Vehicle Battery Test Procedures Manual, Revision 2, January 1996.	40 CFR 1037.552(a) and 1037.810(f) .....	The referenced procedure describes a procedure for preconditioning batteries as part of a performance demonstration. This is a newly referenced standard.

In accordance with the requirements of 1 CFR 51.5, we are proposing to incorporate by reference the use of test methods and standards from the

California Air Resources Board (CARB). The referenced standards and test methods may be obtained through the CARB website ([www.arb.ca.gov](http://www.arb.ca.gov)) or by

calling (916) 322-2884. We propose to incorporate by reference the following CARB documents:

Standard or test method	Regulation	Summary
CARB's 2019 OBD regulation—13 CCR 1968.2, 1968.5, and 1971.5.	40 CFR 1036.110(b) and 1036.810(d) .....	The CARB standards establish requirements for onboard diagnostic systems for heavy-duty vehicles. These are newly referenced standards.
CARB's 2019 OBD regulation—13 CCR 1971.1	40 CFR 1036.110(b) and (c), 1036.111(a) and (c), and 1036.810(d).	The CARB standards establish requirements for onboard diagnostic systems for heavy-duty vehicles. This is a newly referenced standard.

*J. Executive Order 12898: Federal Actions To Address Environmental Justice in Minority Populations and Low-Income Populations*

EPA believes that this proposed rule does not have disproportionately high and adverse human health or environmental effects on minority populations, low-income populations and/or indigenous peoples, as specified in Executive Order 12898 (59 FR 7629, February 16, 1994). Section II.B.8 of this preamble provides a qualitative summary of evidence that communities with environmental justice concerns are disproportionately impacted by mobile source emissions and would therefore benefit from the emissions reductions that would result from this proposal. Section II.B.8 also presents the results of new work that shows that, relative to the rest of the population, people living near truck routes are more likely to be

people of color and have lower incomes than the general population.

With respect to emissions reductions and associated improvements in air quality, EPA has determined that this rule would benefit all U.S. populations, including minority populations, low-income populations and indigenous peoples. Section VI of this preamble presents the estimated emissions reductions from the proposed rule, including substantial reductions in NO<sub>x</sub> and other criteria and toxic pollutants. Section VII of this preamble presents the air quality impacts of the proposed Option 1. The air quality modeling predicts decreases in ambient concentrations of air pollutants in 2045 due to the proposed standards, including significant improvements in ozone concentrations. Ambient PM<sub>2.5</sub>, NO<sub>2</sub> and CO concentrations are also predicted to improve in 2045 because of the proposed Option 1 program.

In terms of benefits to human health, reduced ambient concentrations of ozone and PM<sub>2.5</sub> would lead to the avoidance of many adverse environmental and human health impacts in 2045, including reductions in premature deaths and many non-fatal illnesses. These health benefits, presented in Section VIII of the preamble, would accrue to all U.S. populations, including minority populations, low-income populations and indigenous peoples.

EPA also conducted a demographic analysis of air quality modeling data in 2045 to examine trends in human exposure to future air quality in scenarios both with and without the proposed Option 1 in place. That analysis, summarized in Section VII.H of the preamble and presented in more detail in draft RIA Chapter 6.3.9, found that in the 2045 baseline, nearly double the number of people of color live

within areas with the worst ozone and PM<sub>2.5</sub> air quality compared to non-Hispanic whites. We also found that the largest predicted improvements in both ozone and PM<sub>2.5</sub> are estimated to occur in areas with the worst baseline air quality. While there would be improvements in air quality for people of color, disparities in PM<sub>2.5</sub> and ozone exposure are projected to remain.

#### **XIV. Statutory Provisions and Legal Authority**

Statutory authority for the requirements proposed in this rulemaking can be found in CAA sections 202, 203, 206, 207, 208, 213, 216, and 301 (42 U.S.C. 7521, 7522, 7525, 7541, 7542, 7547, 7550, and 7601).

#### **List of Subjects**

##### *40 CFR Part 2*

Administrative practice and procedure, Confidential business information, Courts, Environmental protection, Freedom of information, Government employees

##### *40 CFR Part 59*

Air pollution control, Confidential business information, Labeling, Ozone, Reporting and recordkeeping requirements, Volatile organic compounds.

##### *40 CFR Part 60*

Administrative practice and procedure, Air pollution control, Aluminum, Beverages, Carbon monoxide, Chemicals, Coal, Electric power plants, Fluoride, Gasoline, Glass and glass products, Grains, Greenhouse gases, Household appliances, Industrial facilities, Insulation, Intergovernmental relations, Iron, Labeling, Lead, Lime, Metals, Motor vehicles, Natural gas, Nitrogen dioxide, Petroleum, Phosphate, Plastics materials and synthetics, Polymers, Reporting and recordkeeping requirements, Rubber and rubber products, Sewage disposal, Steel, Sulfur oxides, Vinyl, Volatile organic compounds, Waste treatment and disposal, Zinc.

##### *40 CFR Part 80*

Environmental protection, Administrative practice and procedure, Air pollution control, Diesel fuel, Fuel additives, Gasoline, Imports, Oil imports, Petroleum, Renewable fuel.

##### *40 CFR Part 85*

Confidential business information, Greenhouse gases, Imports, Labeling, Motor vehicle pollution, Reporting and recordkeeping requirements, Research, Warranties.

##### *40 CFR Part 86*

Environmental protection, Administrative practice and procedure, Confidential business information, Labeling, Motor vehicle pollution, Reporting and recordkeeping requirements.

##### *40 CFR Part 87*

Environmental protection. Air pollution control, Aircraft.

##### *40 CFR Part 600*

Environmental protection, Administrative practice and procedure, Electric power, Fuel economy, Incorporation by reference, Labeling, Reporting and recordkeeping requirements.

##### *40 CFR Part 1027*

Environmental protection, Administrative practice and procedure, Air pollution control, Confidential business information, Imports, Reporting and recordkeeping requirements.

##### *40 CFR Part 1030*

Environmental protection, Air pollution control, Aircraft, Greenhouse gases.

##### *40 CFR Part 1033*

Environmental protection, Administrative practice and procedure, Confidential business information, Environmental protection, Labeling, Penalties, Railroads, Reporting and recordkeeping requirements.

##### *40 CFR Part 1036*

Environmental protection, Administrative practice and procedure, Air pollution control Confidential business information, Greenhouse gases, Incorporation by reference, Labeling, Motor vehicle pollution, Reporting and recordkeeping requirements, Warranties.

##### *40 CFR Part 1037*

Environmental protection, Administrative practice and procedure, Air pollution control, Confidential business information, Incorporation by reference, Labeling, Motor vehicle pollution, Reporting and recordkeeping requirements, Warranties.

##### *40 CFR Part 1039*

Environmental protection, Administrative practice and procedure, Air pollution control, Confidential business information, Imports, Labeling, Penalties, Reporting and recordkeeping requirements, Warranties.

##### *40 CFR Part 1042*

Environmental protection, Administrative practice and procedure, Air pollution control, Confidential business information, Environmental protection, Imports, Labeling, Penalties, Reporting and recordkeeping requirements, Vessels, Warranties.

##### *40 CFR Part 1043*

Environmental protection, Administrative practice and procedure, Air pollution control, Imports, Reporting and recordkeeping requirements, Vessels.

##### *40 CFR Parts 1045, 1051, and 1054*

Environmental protection, Administrative practice and procedure, Air pollution control, Confidential business information, Imports, Labeling, Penalties, Reporting and recordkeeping requirements, Warranties.

##### *40 CFR Part 1048*

Environmental protection, Administrative practice and procedure, Air pollution control, Confidential business information, Imports, Labeling, Penalties, Reporting and recordkeeping requirements, Research, Warranties.

##### *40 CFR Part 1060*

Environmental protection, Administrative practice and procedure, Air pollution control, Confidential business information, Imports, Labeling, Penalties, Reporting and recordkeeping requirements, Warranties.

##### *40 CFR Part 1065*

Environmental protection, Administrative practice and procedure, Air pollution control, Reporting and recordkeeping requirements, Research.

##### *40 CFR Part 1066*

Environmental protection, Air pollution control, Incorporation by reference, Reporting and recordkeeping requirements.

##### *40 CFR Part 1068*

Environmental protection, Administrative practice and procedure, Air pollution control, Confidential business information, Imports, Motor vehicle pollution, Penalties, Reporting and recordkeeping requirements, Warranties.

##### *40 CFR Part 1090*

Environmental protection, Administrative practice and procedure, Air pollution control, Diesel fuel, Fuel

additives, Gasoline, Imports, Oil imports, Petroleum, Renewable fuel.

**Michael S. Regan,**  
Administrator.

For the reasons set out in the preamble, we are amending title 40, chapter I of the Code of Federal Regulations as set forth below.

## PART 2—PUBLIC INFORMATION

- 1. The authority citation for part 2 continues to read as follows:

**Authority:** 5 U.S.C. 552, 552a, 553; 28 U.S.C. 509, 510, 534; 31 U.S.C. 3717.

- 2. Amend § 2.301 by adding and reserving paragraph (i) and adding paragraph (j) to read as follows:

### § 2.301 Special rules governing certain information obtained under the Clean Air Act.

\* \* \* \* \*

(i) [Reserved]

(j) *Requests for or release of information subject to a confidentiality determination through rulemaking as specified in 40 CFR part 1068.* This paragraph (j) describes provisions that apply for a wide range of engines, vehicles, and equipment that are subject to emission standards and other requirements under the Clean Air Act. This includes motor vehicles and motor vehicle engines, nonroad engines and nonroad equipment, aircraft and aircraft engines, and stationary engines. It also includes portable fuel containers regulated under 40 CFR part 59, subpart F, and fuel tanks, fuel lines, and related fuel-system components regulated under 40 CFR part 1060. Regulatory provisions related to confidentiality determinations for these products are codified broadly in 40 CFR part 1068, with additional detailed provisions for specific sectors in the regulatory parts referenced in 40 CFR 1068.1. References in this paragraph (j) to 40 CFR part 1068 also include these related regulatory parts.

(1) Unless noted otherwise, 40 CFR 2.201 through 2.215 do not apply for information covered by the confidentiality determinations in 40 CFR part 1068 if EPA has determined through rulemaking that information to be any of the following pursuant to 42 U.S.C. 7414 or 7542(c) in a rulemaking subject to 42 U.S.C. 7607(d):

(i) Emission data as defined in paragraph (a)(2)(i) of this section.  
(ii) Data not entitled to confidential treatment.

(2) Unless noted otherwise, 40 CFR 2.201 through 2.208 do not apply for information covered by the confidentiality determinations in 40

CFR part 1068 if EPA has determined through rulemaking that information to be entitled to confidential treatment pursuant to 42 U.S.C. 7414 or 7542(c) in a rulemaking subject to 42 U.S.C. 7607(d). EPA will treat such information as confidential in accordance with the provisions of § 2.209 through 2.215, subject to paragraph (j)(4) of this section.

(3) EPA will deny a request for information under 5 U.S.C. 552(b)(4) if EPA has determined through rulemaking that the information is entitled to confidential treatment under 40 CFR part 1068. The denial notification will include a regulatory cite to the appropriate determination.

(4) A determination made pursuant to 42 U.S.C. 7414 or 7542 in a rulemaking subject to 42 U.S.C. 7607(d) that information specified in 40 CFR part 1068 is entitled to confidential treatment shall continue in effect unless EPA takes one of the following actions to modify the determination:

(i) EPA determines, pursuant to 5 U.S.C. 552(b)(4) and the Clean Air Act (42 U.S.C. 7414; 7542(c)) in a rulemaking subject to 42 U.S.C. 7607(d), that the information is entitled to confidential treatment, or that the information is emission data or data that is otherwise not entitled to confidential treatment by statute or regulation.

(ii) EPA determines, pursuant to 5 U.S.C. 552(b)(4) and the Clean Air Act (42 U.S.C. 7414; 7542(c)) that the information is emission data or data that is otherwise clearly not entitled to confidential treatment by statute or regulation under 40 CFR 2.204(d)(2).

(iii) The Office of General Counsel revisits an earlier determination, pursuant to 5 U.S.C. 552(b)(4) and the Clean Air Act (42 U.S.C. 7414; 7542(c)), that the information is entitled to confidential treatment because of a change in the applicable law or newly discovered or changed facts. Prior to a revised final determination, EPA shall afford the business an opportunity to submit a substantiation on the pertinent issues to be considered, including any described in §§ 2.204(e)(4) or 2.205(b), within 15 days of the receipt of the notice to substantiate. If, after consideration of any timely comments made by the business in its substantiation, the Office of General Counsel makes a revised final determination that the information is not entitled to confidential treatment under 42 U.S.C. 7414 or 7542, EPA will notify the business in accordance with § 2.205(f)(2).

(5) The provisions of 40 CFR 2.201 through 2.208 continue to apply for the categories of information identified in

40 CFR 1068.11(c) for which there is no confidentiality determination in 40 CFR part 1068.

## PART 59—NATIONAL VOLATILE ORGANIC COMPOUND EMISSION STANDARDS FOR CONSUMER AND COMMERCIAL PRODUCTS

- 3. The authority citation for part 59 continues to read as follows:

**Authority:** 42 U.S.C. 7414 and 7511b(e).

- 4. Revise § 59.695 to read as follows:

### § 59.695 What provisions apply to confidential information?

The provisions of 40 CFR 1068.10 and 1068.11 apply for submitted information you claim as confidential information you submit under this part.

## PART 60—STANDARDS OF PERFORMANCE FOR NEW STATIONARY SOURCES

- 5. The authority citation for part 60 continues to read as follows:

**Authority:** 42 U.S.C. 7401 *et seq.*

- 6. Amend § 60.4202 by revising paragraph (g) introductory text to read as follows:

### § 60.4202 What emission standards must I meet for emergency engines if I am a stationary CI internal combustion engine manufacturer?

\* \* \* \* \*

(g) Notwithstanding the requirements in paragraphs (a) through (d) of this section, stationary emergency CI ICE identified in paragraphs (a) and (c) of this section may be certified to the provisions of 40 CFR part 1042 for commercial engines that are applicable for the engine's model year, displacement, power density, and maximum engine power if the engines will be used solely in either or both of the locations identified in paragraphs (g)(1) and (2) of this section. Engines that would be subject to the Tier 4 standards in 40 CFR part 1042 that are used solely in either or both of the locations identified in paragraphs (g)(1) and (2) of this section may instead continue to be certified to the previous tier of standards in 40 CFR part 1042. The previous tier is Tier 3 in most cases; however, the previous tier is Tier 2 if there are no Tier 3 standards specified for engines of a certain size or power rating.

\* \* \* \* \*

- 7. Revise § 60.4218 to read as follows:



**§ 60.4218 What General Provisions and confidential information provisions apply to me?**

(a) Table 8 to this subpart shows which parts of the General Provisions in §§ 60.1 through 60.19 apply to you.

(b) The provisions of 40 CFR 1068.10 and 1068.11 apply for engine manufacturers. For others, the general confidential business information (CBI) provisions apply as described in 40 CFR part 2.

■ 8. Revise § 60.4246 to read as follows:

**§ 60.4246 What General Provisions and confidential information provisions apply to me?**

(a) Table 3 to this subpart shows which parts of the General Provisions in §§ 60.1 through 60.19 apply to you.

(b) The provisions of 40 CFR 1068.10 and 1068.11 apply for engine manufacturers. For others, the general confidential business information (CBI) provisions apply as described in 40 CFR part 2.

**PART 80—REGULATION OF FUELS AND FUEL ADDITIVES**

■ 9. The authority citation for part 80 continues to read as follows:

**Authority:** 42 U.S.C. 7414, 7521, 7542, 7545, and 7601(a).

**Subpart B—[Removed and reserved]**

■ 10. Remove and reserve subpart B.

**PART 85—CONTROL OF AIR POLLUTION FROM MOBILE SOURCES**

■ 11. The authority citation for part 85 continues to read as follows:

**Authority:** 42 U.S.C. 7401–7671q.

■ 12. Amend § 85.1501 by revising paragraph (a) to read as follows:

**§ 85.1501 Applicability.**

(a) Except where otherwise indicated, this subpart is applicable to motor vehicles offered for importation or imported into the United States for which the Administrator has promulgated regulations under 40 CFR part 86, subpart D or S, prescribing emission standards, but which are not covered by certificates of conformity issued under section 206(a) of the Clean Air Act (*i.e.*, which are nonconforming vehicles as defined in § 85.1502), as amended, and part 86 at the time of conditional importation. Compliance with regulations under this subpart shall not relieve any person or entity from compliance with other applicable provisions of the Clean Air Act. This subpart no longer applies for heavy-duty engines certified under 40 CFR part 86, subpart A, or 40 CFR part 1036;

references in this subpart to “engines” therefore apply only for replacement engines intended for installation in motor vehicles that are subject to this subpart.

\* \* \* \* \*

**§ 85.1513 —[Amended]**

■ 13. Amend § 85.1513 by removing and reserving paragraph (e)(5).

■ 14. Revise § 85.1514 to read as follows:

**§ 85.1514 Treatment of confidential information.**

The provisions of 40 CFR 1068.10 and 1068.11 apply for information you submit under this subpart.

■ 15. Amend § 85.1515 by revising paragraph (a)(2)(ii)(A) to read as follows:

**§ 85.1515 Emission standards and test procedures applicable to imported nonconforming motor vehicles and motor vehicle engines.**

(a) \* \* \*

(2) \* \* \*

(ii) \* \* \*

(A) *Exhaust and fuel economy tests.*

You must measure emissions over the FTP driving cycle and the highway fuel economy driving cycle as specified in 40 CFR 1066.801 to meet the fuel economy requirements in 40 CFR part 600 and demonstrate compliance with the exhaust emission standards in 40 CFR part 86 (other than PM). Measure exhaust emissions and fuel economy with the same test procedures used by the original manufacturer to test the vehicle for certification. However, you must use an electric dynamometer meeting the requirements of 40 CFR part 1066, subpart B, unless we approve a different dynamometer based on excessive compliance costs. If you certify based on testing with a different dynamometer, you must state in the application for certification that all vehicles in the emission family will comply with emission standards if tested on an electric dynamometer.

\* \* \* \* \*

■ 16. Amend § 85.1701 by revising paragraphs (a)(1), (b), and (c) to read as follows:

**§ 85.1701 General applicability.**

(a) \* \* \*

(1) Beginning January 1, 2014, the exemption provisions of 40 CFR part 1068, subpart C, apply instead of the provisions of this subpart for heavy-duty motor vehicle engines and heavy-duty motor vehicles regulated under 40 CFR part 86, subpart A, or 40 CFR part 1036 or part 1037, except that the nonroad competition exemption of 40 CFR 1068.235 and the nonroad hardship

exemption provisions of 40 CFR 1068.245, 1068.250, and 1068.255 do not apply for motor vehicle engines. Note that the provisions for emergency vehicle field modifications in § 85.1716 continue to apply for heavy-duty engines.

\* \* \* \* \*

(b) The provisions of 40 CFR 1068.10 and 1068.11 apply for information you submit under this subpart.

(c) References to engine families and emission control systems in this subpart or in 40 CFR part 1068 apply to durability groups and test groups as applicable for manufacturers certifying vehicles under the provisions of 40 CFR part 86, subpart S.

\* \* \* \* \*

**§ 85.1712 —[Removed and Reserved]**

■ 17. Remove and reserve § 85.1712.

■ 18. Revise § 85.1808 to read as follows:

**§ 85.1808 Treatment of confidential information.**

The provisions of 40 CFR 1068.10 and 1068.11 apply for information you submit under this subpart.

■ 19. Amend § 85.1901 by revising paragraph (a) to read as follows:

**§ 85.1901 Applicability.**

(a) The requirements of this subpart shall be applicable to all 1972 and later model year motor vehicles and motor vehicle engines, except that the provisions of 40 CFR 1068.501 apply instead for heavy-duty motor vehicle engines and heavy-duty motor vehicles certified under 40 CFR part 86, subpart A, or 40 CFR part 1036 or 1037 starting January 1, 2018.

\* \* \* \* \*

■ 20. Revise § 85.1909 to read as follows:

**§ 85.1909 Treatment of confidential information.**

The provisions of 40 CFR 1068.10 and 1068.11 apply for information you submit under this subpart.

**Subpart V—WARRANTY REGULATIONS AND VOLUNTARY AFTERMARKET CERTIFICATION PROGRAM**

■ 21. The heading of subpart V is revised to read as set forth above.

■ 22. Amend § 85.2102 by revising paragraphs (a)(1), (2), (4) through (6), (10), and (13) to read as follows:

**§ 85.2102 Definitions.**

(a) \* \* \*

(1) *Act* means Part A of Title II of the Clean Air Act, 42 U.S.C. 7421 *et seq.*

(2) *Office Director* means the Director for the Office of Transportation and Air

Quality in the Office of Air and Radiation of the Environmental Protection Agency or other authorized representative of the Office Director.

\* \* \* \* \*

(4) *Emission performance warranty* means that warranty given pursuant to this subpart and 42 U.S.C. 7541(b).

(5) *Emission warranty* means a warranty given pursuant to this subpart and 42 U.S.C. 7541(a) or (b).

(6) *Model year* means the manufacturer's annual production period as described in subpart X of this part.

\* \* \* \* \*

(10) *Useful life* means that period established pursuant to 42 U.S.C. 7521(d) and regulations promulgated thereunder.

\* \* \* \* \*

(13) *Written instructions for proper maintenance and use* means those maintenance and operation instructions specified in the owner's manual as being necessary to assure compliance of a vehicle with applicable emission standards for the useful life of the vehicle that are:

(i) In accordance with the instructions specified for performance on the manufacturer's prototype vehicle used in certification (including those specified for vehicles used under special circumstances); and

(ii) In compliance with the requirements of 40 CFR 86.1808; and

(iii) In compliance with any other EPA regulations governing maintenance and use instructions.

\* \* \* \* \*

■ 23. Amend § 85.2103 by revising paragraph (a)(3) to read as follows:

**§ 85.2103 Emission performance warranty.**

(a) \* \* \*

(3) Such nonconformity results or will result in the vehicle owner having to bear any penalty or other sanction (including the denial of the right to use the vehicle) under local, State or Federal law, then the manufacturer shall remedy the nonconformity at no cost to the owner; except that, if the vehicle has been in operation for more than 24 months or 24,000 miles, the manufacturer shall be required to remedy only those nonconformities resulting from the failure of any of the specified major emission control components listed in 42 U.S.C. 7541(i)(2) or components which have been designated by the Administrator to be specified major emission control components until the vehicle has been in operation for 8 years or 80,000 miles.

\* \* \* \* \*

■ 24. Amend § 85.2104 by revising paragraphs (a) and (h) introductory text to read as follows:

**§ 85.2104 Owners' compliance with instructions for proper maintenance and use.**

(a) An emission warranty claim may be denied on the basis of noncompliance by a vehicle owner with the written instructions for proper maintenance and use.

\* \* \* \* \*

(h) In no case may a manufacturer deny an emission warranty claim on the basis of—

\* \* \* \* \*

■ 25. Amend § 85.2106 by revising paragraphs (b) introductory text, (c), (d) introductory text, (d)(2), and (g) to read as follows:

**§ 85.2106 Warranty claim procedures.**

\* \* \* \* \*

(b) A claim under any emission warranty required by 42 U.S.C. 7541(a) or (b) may be submitted by bringing a vehicle to:

\* \* \* \* \*

(c) To the extent required by any Federal or State law, whether statutory or common law, a vehicle manufacturer shall be required to provide a means for non-franchised repair facilities to perform emission warranty repairs.

(d) The manufacturer of each vehicle to which the warranty is applicable shall establish procedures as to the manner in which a claim under the emission warranty is to be processed. The procedures shall—

\* \* \* \* \*

(2) Require that if the facility at which the vehicle is initially presented for repair is unable for any reason to honor the particular claim, then, unless this requirement is waived in writing by the vehicle owner, the repair facility shall forward the claim to an individual or office authorized to make emission warranty determinations for the manufacturer.

\* \* \* \* \*

(g) The vehicle manufacturer shall incur all costs associated with a determination that an emission warranty claim is valid.

■ 26. Amend § 85.2107 by revising paragraphs (a) and (b) to read as follows:

**§ 85.2107 Warranty remedy.**

(a) The manufacturer's obligation under the emission warranties provided under 42 U.S.C. 7541(a) and (b) shall be to make all adjustments, repairs or replacements necessary to assure that the vehicle complies with applicable emission standards of the U.S.

Environmental Protection Agency, that it will continue to comply for the remainder of its useful life (if proper maintenance and operation are continued), and that it will operate in a safe manner. The manufacturer shall bear all costs incurred as a result of the above obligation, *except that* after the first 24 months or 24,000 miles (whichever first occurs) the manufacturer shall be responsible only for:

(1) The adjustment, repair or replacement of any of the specified major emission control components listed in 42 U.S.C. 7541(i)(2) or components which have been designated by the administrator to be specified major emission control components until the vehicle has been in operation for 8 years or 80,000 miles; and

(2) All other components which must be adjusted, repaired or replaced to enable a component adjusted, repaired, or replaced under paragraph (a)(1) of this section to perform properly.

(b) Manufacturers shall be liable for the total cost of the remedy for any vehicle validly presented for repair under an emission warranty to any authorized service facility authorized by the vehicle manufacturer. State or local limitations as to the extent of the penalty or sanction imposed upon an owner of a failed vehicle shall have no bearing on this liability.

\* \* \* \* \*

■ 27. Amend § 85.2109 by revising paragraphs (a) introductory text and (a)(6) to read as follows:

**§ 85.2109 Inclusion of warranty provisions in owners' manuals and warranty booklets.**

(a) A manufacturer shall furnish with each new motor vehicle, a full explanation of the emission warranties required by 42 U.S.C. 7541(a) and (b), including at a minimum the following information:

\* \* \* \* \*

(6) An explanation that an owner may obtain further information concerning the emission warranties or that an owner may report violations of the terms of the Emission warranties provided under 42 U.S.C. 7541(a) and (b) by contacting the Director, Compliance Division, Environmental Protection Agency, 2000 Traverwood Dr, Ann Arbor, MI 48105 (Attention: Warranty) or email to: [complianceinfo@epa.gov](mailto:complianceinfo@epa.gov).

\* \* \* \* \*

■ 28. Amend § 85.2111 by revising the introductory text and paragraphs (b) introductory text, (c), and (d) to read as follows:

§ 85.2111 Warranty enforcement.

The following acts are prohibited and may subject a manufacturer to a civil penalty as described in paragraph (d) of this section:

\* \* \* \* \*

(b) Failing or refusing to comply with the terms and conditions of the emission warranties provided under 42 U.S.C. 7541(a) and (b) with respect to any vehicle to which this subpart applies. Acts constituting such a failure or refusal shall include, but are not limited to, the following:

\* \* \* \* \*

(c) To provide directly or indirectly in any communication to the ultimate purchaser or any subsequent purchaser that emission warranty coverage is conditioned upon the use of any name brand component, or system or upon service (other than a component or service provided without charge under the terms of the purchase agreement), unless the communication is made pursuant to a written waiver by the Office Director.

(d) The maximum penalty value is \$37,500 for each offense that occurs after November 2, 2015. Maximum penalty limits may be adjusted based on the Consumer Price Index as described at 40 CFR part 19.

\* \* \* \* \*

■ 29. Revise § 85.2123 to read as follows:

§ 85.2123 Treatment of confidential information.

The provisions of 40 CFR 1068.10 and 1068.11 apply for information you submit under this subpart.

PART 86—CONTROL OF EMISSIONS FROM NEW AND IN-USE HIGHWAY VEHICLES AND ENGINES

■ 30. The authority citation for part 86 continues to read as follows:

Authority: 42 U.S.C. 7401–7671q.

■ 31. Amend § 86.007–11 by revising paragraphs (f) and (g) introductory text to read as follows:

§ 86.007–11 Emission standards and supplemental requirements for 2007 and later model year diesel heavy-duty engines and vehicles.

\* \* \* \* \*

(f) Model year 2007 and later diesel-fueled heavy-duty engines and vehicles for sale in Guam, American Samoa, or the Commonwealth of the Northern Mariana Islands may be subject to alternative standards under 40 CFR 1036.655.

(g) Model years 2018 through 2026 engines at or above 56 kW that will be installed in specialty vehicles as

allowed by 40 CFR 1037.605 may meet alternate emission standards as follows:

\* \* \* \* \*

■ 32. Amend § 86.008–10 by revising paragraph (g) introductory text to read as follows:

§ 86.008–10 Emission standards for 2008 and later model year Otto-cycle heavy-duty engines and vehicles.

\* \* \* \* \*

(g) Model years 2018 through 2026 engines that will be installed in specialty vehicles as allowed by 40 CFR 1037.605 may meet alternate emission standards as follows:

\* \* \* \* \*

■ 33. Amend § 86.010–18 by:

■ a. Revising paragraph (a) introductory text.

■ b. Removing and reserving paragraph (o)

The revision reads as follows:

§ 86.010–18 On-board Diagnostics for engines used in applications greater than 14,000 pounds GVWR.

(a) General. Heavy-duty engines intended for use in a heavy-duty vehicle weighing more than 14,000 pounds GVWR must be equipped with an on-board diagnostic (OBD) system capable of monitoring all emission-related engine systems or components during the life of the engine. The OBD requirements of 40 CFR 1036.110 apply starting in model year 2027. In earlier model years, manufacturers may meet the requirements of this section or the requirements of 40 CFR 1036.110. Note that 40 CFR 1036.150(u) allows for an alternative communication protocol before model year 2027. The OBD system is required to detect all malfunctions specified in paragraphs (g), (h), and (i) of this section even though the OBD system is not required to use a unique monitor to detect each of those malfunctions.

\* \* \* \* \*

■ 34. Amend § 86.016–1 by:

■ a. Revising paragraphs (a) introductory text, (d) introductory text, and (d)(4).

■ b. Adding and reserving paragraph (i).

■ c. Adding paragraph (j).

The revisions and additions read as follows:

§ 86.016–1 General applicability.

(a) Applicability. The provisions of this subpart apply for certain types of new heavy-duty engines and vehicles as described in this section. As described in paragraph (j) of this section, most of this subpart no longer applies starting with model year 2027. Note that this subpart does not apply for light-duty vehicles, light-duty trucks, medium-

duty passenger vehicles, or vehicles at or below 14,000 pounds GVWR that have no propulsion engine, such as electric vehicles; see subpart S of this part for requirements that apply for those vehicles. In some cases, manufacturers of heavy-duty engines and vehicles can choose to meet the requirements of this subpart or the requirements of subpart S of this part; those provisions are therefore considered optional, but only to the extent that manufacturers comply with the other set of requirements. In cases where a provision applies only for a certain vehicle group based on its model year, vehicle class, motor fuel, engine type, or other distinguishing characteristics, the limited applicability is cited in the appropriate section. The provisions of this subpart apply for certain heavy-duty engines and vehicles as follows:

\* \* \* \* \*

(d) Non-petroleum fueled vehicles. Standards and requirements apply to model year 2016 and later non-petroleum fueled motor vehicles as follows:

\* \* \* \* \*

(4) The standards and requirements of 40 CFR part 1037 apply for vehicles above 14,000 pounds GVWR that have no propulsion engine, such as electric vehicles. Electric heavy-duty vehicles may not generate PM emission credits. Electric heavy-duty vehicles may not generate NOx emission credits except as allowed under 40 CFR part 1037.

\* \* \* \* \*

(i) [Reserved]

(j) Transition to 40 CFR parts 1036 and 1037. Except for § 86.010–38(j), this subpart no longer applies starting with model year 2027. Individual provisions in 40 CFR parts 1036 and 1037 apply instead of the provisions of this subpart before model year 2027 as specified in this subpart and 40 CFR parts 1036 and 1037.

■ 35. Amend § 86.090–5 by adding paragraph (b)(4) to read as follows.

§ 86.090–5 General standards; increase in emissions; unsafe conditions.

\* \* \* \* \*

(b) \* \* \*

(4) Manufacturers of engines equipped with vanadium-based SCR catalysts must design the engine and its emission controls to prevent vanadium sublimation and protect the catalyst from high temperatures as described in 40 CFR 1036.115(g)(2).

■ 36. Amend § 86.117–96 by revising paragraph (d)(1) introductory text and adding paragraphs (d)(1)(iii) and (iv) to read as follows.

**§ 86.117–96 Evaporative emission enclosure calibrations.**

\* \* \* \* \*

(d) \* \* \*

(1) The calculation of net methanol and hydrocarbon mass change is used to

determine enclosure background and leak rate. It is also used to check the enclosure volume measurements. The methanol mass change is calculated from the initial and final methanol samples, the net withdrawn methanol

(in the case of diurnal emission testing with fixed-volume enclosures), and initial and final temperature and pressure according to the following equation:

$$M_{\text{CH}_3\text{OH}} = V_n \times \left[ \frac{(\text{TE}_f \times (\text{C}_{\text{MS1f}} \times \text{AV}_{1f}) + (\text{C}_{\text{MS2f}} \times \text{AV}_{2f}))}{V_{\text{E}f} \times \text{T}_{\text{SHED}f}} \right] - \left[ \frac{(\text{TE}_i \times (\text{C}_{\text{MS1i}} \times \text{AV}_{1i}) + (\text{C}_{\text{MS2i}} \times \text{AV}_{2i}))}{V_{\text{E}i} \times \text{T}_{\text{SHED}i}} \right] + (M_{\text{CH}_3\text{OH},\text{out}} - M_{\text{CH}_3\text{OH},\text{in}})$$

\* \* \* \* \*

(iii) TE = temperature of sample withdrawn, R.

(iv) TSHEd = temperature of SHED, R.

\* \* \* \* \*

■ 37. Add § 86.450 to subpart E to read as follows:

**§ 86.450 Treatment of confidential information.**

The provisions of 40 CFR 1068.10 and 1068.11 apply for information you submit under this subpart.

**Subpart I—[Removed and Reserved]**

■ 38. Subpart I, consisting of §§ 86.1101–87 through 86.1116–87, is removed and reserved.

■ 39. Add § 86.1117 to subpart L to read as follows:

**§ 86.1117 Labeling.**

(a) Light-duty trucks and heavy-duty vehicles and engines for which nonconformance penalties are to be paid in accordance with § 86.1113–87(b) must have information printed on the emission control information label or a supplemental label as follows.

(1) The manufacturer must begin labeling production engines or vehicles within 10 days after the completion of the PCA.

(2) This statement shall read: “The manufacturer of this [engine or vehicle, as applicable] will pay a

nonconformance penalty to be allowed to introduce it into U.S. commerce at an emission level higher than the applicable emission standard. The [compliance level or alternative emission standard] for this engine/vehicle is [insert the applicable pollutant and compliance level calculated in accordance with § 86.1112–87(a)].”

(3) If a manufacturer introduces an engine or vehicle into U.S. commerce prior to the compliance level determination of § 86.1112–87(a), it must provide the engine or vehicle owner with a label as described in paragraph (a)(2) of this section to be affixed in a location in proximity to the emission control information label within 30 days of the completion of the PCA.

(b) The Administrator may approve in advance other label content and formats, provided the alternative label contains information consistent with this section.

■ 40. Revise § 86.1301 to read as follows:

**§ 86.1301 Scope; applicability.**

(a) This subpart specifies gaseous emission test procedures for Otto-cycle and diesel heavy-duty engines, and particulate emission test procedures for diesel heavy-duty engines.

(b) You may optionally demonstrate compliance with the emission standards

of this part by testing hybrid engines and hybrid powertrains using the test procedures in 40 CFR part 1036, rather than testing the engine alone. If you choose this option, you may meet the supplemental emission test (SET) requirements by using the SET duty cycle specified in either § 86.1362 or 40 CFR 1036.505. Except as specified, provisions of this subpart and subpart A of this part that reference engines apply equally to hybrid engines and hybrid powertrains.

(c) The abbreviations and acronyms from subpart A of this part apply to this subpart.

**§§ 86.1302–84, 86.1303–84, and 86.1304—[Removed]**

■ 41. Remove §§ 86.1302–84, 86.1303–84, and 86.1304.

■ 42. Amend § 86.1362 by revising paragraph (b) to read as follows:

**§ 86.1362 Steady-state testing with a ramped-modal cycle.**

\* \* \* \* \*

(b) Measure emissions by testing the engine on a dynamometer with the following ramped-modal duty cycle to determine whether it meets the applicable steady-state emission standards in this part and 40 CFR part 1036:



14 Steady-state. 168 Warm Idle ... 0 ..... 0 ..... 0 ..... 0 ..... 0 ..... 0 ..... 0 ..... 0 ..... 0 ..... 6

<sup>1</sup> Engine speed terms are defined in 40 CFR part 1065.  
<sup>2</sup> Advance from one mode to the next within a 20 second transition phase. During the transition phase, command a linear progression from the settings of the current mode to the settings of the next mode.  
<sup>3</sup> The percent torque is relative to maximum torque at the commanded engine speed.  
<sup>4</sup> See 40 CFR 1036.505(c) for a description of powertrain testing with the ramped-modal cycle, including the equation that uses the road-grade coefficients.  
<sup>5</sup> Use the specified weighting factors to calculate composite emission results for CO<sub>2</sub> as specified in 40 CFR 1036.501.

■ 43. Amend § 86.1372 by revising paragraph (a) introductory text to read as follows:

§ 86.1372 Measuring smoke emissions within the NTE zone.

\* \* \* \* \*

(a) For steady-state or transient smoke testing using full-flow opacimeters, equipment meeting the requirements of 40 CFR part 1065, subpart L, or ISO/DIS-11614 "Reciprocating internal combustion compression-ignition engines—Apparatus for measurement of the opacity and for determination of the light absorption coefficient of exhaust gas" is required. ISO/DIS-11614 is incorporated by reference (see § 86.1).

\* \* \* \* \*

■ 44. Amend § 86.1801-12 by revising paragraphs (a)(2) introductory text, (a)(2)(iii), (a)(3) introductory text, and (g) to read as follows:

§ 86.1801-12 Applicability.

(a) \* \* \*

(2) The provisions of this subpart apply for medium-duty passenger vehicles and all vehicles at or below 14,000 pounds GVWR that have no propulsion engine, such as electric vehicles. The provisions of this subpart also apply for other complete heavy-duty vehicles at or below 14,000 pounds GVWR, except as follows:

\* \* \* \* \*

(iii) The provisions of this subpart are optional for diesel-fueled Class 3 heavy-duty vehicles in a given model year if those vehicles are equipped with engines certified to the appropriate standards in § 86.007-11 or 40 CFR 1036.104 for which less than half of the engine family's sales for the model year in the United States are for complete Class 3 heavy-duty vehicles. This includes engines sold to all vehicle manufacturers. If you are the original manufacturer of the engine and the vehicle, base this showing on your sales information. If you manufacture the vehicle but are not the original manufacturer of the engine, you must use your best estimate of the original manufacturer's sales information.

(3) The provisions of this subpart generally do not apply to incomplete heavy-duty vehicles or to complete vehicles above 14,000 pounds GVWR (see § 86.016-1 and 40 CFR parts 1036 and 1037). However, this subpart applies to such vehicles in the following cases:

\* \* \* \* \*

(g) Complete and incomplete vehicles. Several provisions in this subpart, including the applicability provisions described in this section, are different for complete and incomplete vehicles.

We differentiate these vehicle types as described in 40 CFR 1037.801.

\* \* \* \* \*

■ 45. Amend § 86.1810-17 by adding paragraph (j) to read as follows:

§ 86.1810-17 General requirements.

\* \* \* \* \*

(j) Small-volume manufacturers that modify a vehicle already certified by a different company may recertify that vehicle under this subpart S based on the vehicle supplier's compliance with fleet average standards for criteria exhaust emissions, evaporative emissions, and greenhouse gas emissions as follows:

(1) The recertifying manufacturer must certify the vehicle at bin levels and family emission limits that are the same as or more stringent than the corresponding bin levels and family emission limits for the vehicle supplier.

(2) The recertifying manufacturer must meet all the standards and requirements described in this subpart S, except for the fleet average standards for criteria exhaust emissions, evaporative emissions, and greenhouse gas emissions.

(3) The vehicle supplier must send the small-volume manufacturer a written statement accepting responsibility to include the subject vehicles in the vehicle supplier's exhaust and evaporative fleet average calculations in §§ 86.1860-17, 86.1864-10, and 86.1865-12.

(4) The small-volume manufacturer must describe in the application for certification how the two companies are working together to demonstrate compliance for the subject vehicles. The application must include the statement from the vehicle supplier described in paragraph (j)(3) of this section.

(5) The vehicle supplier must include a statement that the vehicle supplier is including the small volume manufacturer's sales volume and emissions levels in the vehicle supplier's fleet average reports under §§ 86.1860-17, 86.1864-10, and 86.1865-12.

§ 86.1819 [Removed]

■ 46. Remove § 86.1819.

■ 47. Amend § 86.1819-14 by revising paragraph (d)(12)(i) to read as follows:

§ 86.1819-14 Greenhouse gas emission standards for heavy-duty vehicles.

\* \* \* \* \*

(d) \* \* \*

(12) \* \* \*

(i) Configuration means a subclassification within a test group based on engine code, transmission type and gear ratios, final drive ratio, and

other parameters we designate. Engine code means the combination of both "engine code" and "basic engine" as defined for light-duty vehicles in 40 CFR 600.002.

\* \* \* \* \*

■ 48. Amend § 86.1823-08 by:

■ a. Revising paragraph (c)(1)(iv)(A).

■ b. Adding paragraph (m) introductory text.

■ c. Revising paragraph (m)(1).

The addition and revisions read as follows:

§ 86.1823-08 Durability demonstration procedures for exhaust emissions.

\* \* \* \* \*

(c) \* \* \*

(1) \* \* \*

(iv) \* \* \*

(A) The simulated test weight will be the equivalent test weight specified in § 86.129 using a weight basis of the loaded vehicle weight for light-duty vehicles and light light-duty trucks, and ALVW for all other vehicles.

\* \* \* \* \*

(m) Durability demonstration procedures for vehicles subject to the greenhouse gas exhaust emission standards specified in § 86.1818. Determine a deterioration factor for each exhaust constituent as described in this paragraph (m) and in 40 CFR 600.113-12(h) through (m) to calculate the composite CREE DF value.

(1) CO2. (i) Unless otherwise specified under paragraph (m)(1)(ii) or (iii) of this section, manufacturers may use a multiplicative CO2 deterioration factor of one or an additive deterioration factor of zero to determine full useful life emissions for the FTP and HFET tests.

(ii) Based on an analysis of industry-wide data, EPA may periodically establish and/or update the deterioration factor for CO2 emissions, including air conditioning and other credit-related emissions. Deterioration factors established and/or updated under this paragraph (m)(1)(ii) will provide adequate lead time for manufacturers to plan for the change.

(iii) For plug-in hybrid electric vehicles and any other vehicle model the manufacturer determines will experience increased CO2 emissions over the vehicle's useful life, consistent with good engineering judgment, manufacturers must either install aged components on test vehicles as provided in paragraph (f)(2) of this section, determine a deterioration factor based on testing, or provide an engineering analysis that the vehicle is designed such that CO2 emissions will not increase over the vehicle's useful life. Manufacturers may test using the whole-vehicle mileage accumulation

procedures in § 86.1823–08 (c) or (d)(1), or manufacturers may request prior EPA approval for an alternative durability procedure based on good engineering judgment. For the testing option, each FTP test performed on the durability data vehicle selected under § 86.1822 must also be accompanied by an HFET test, and combined FTP/HFET CO<sub>2</sub> results determined by averaging the city (FTP) and highway (HFET) CO<sub>2</sub> values, weighted 0.55 and 0.45 respectively. The deterioration factor will be determined for this combined CO<sub>2</sub> value. Calculated multiplicative deterioration factors that are less than one shall be set to equal one, and calculated additive deterioration factors that are less than zero shall be set to zero.

\* \* \* \* \*

■ 49. Amend § 86.1843–01 by revising paragraph (f)(2) and adding paragraph (i) to read as follows:

**§ 86.1843–01 General information requirements.**

\* \* \* \* \*

(f) \* \* \*

(2) The manufacturer must submit a final update to Part 1 and Part 2 of the Application by May 1 following the end of the model year to incorporate any applicable running changes or corrections which occurred between January 1 of the applicable model year and the end of the model year. A manufacturer may request an extension for submitting the final update. The request must clearly indicate the circumstances necessitating the extension.

\* \* \* \* \*

(i) *Confidential information.* The provisions of 40 CFR 1068.10 and 1068.11 apply for information you submit under this subpart.

■ 50. Amend § 86.1869–12 by revising paragraph (d)(2)(i) to read as follows:

**§ 86.1869–12 CO<sub>2</sub> credits for off-cycle CO<sub>2</sub> reducing technologies.**

\* \* \* \* \*

(d) \* \* \*

(2) *Notice and opportunity for public comment.* (i) The Administrator will publish a notice of availability in the **Federal Register** notifying the public of a manufacturer's proposed alternative off-cycle credit calculation methodology. The notice will include details regarding the proposed methodology but will not include any Confidential Business Information (see 40 CFR 1068.10 and 1068.11). The notice will include instructions on how to comment on the methodology. The Administrator will take public comments into consideration in the

final determination and will notify the public of the final determination. Credits may not be accrued using an approved methodology until the first model year for which the Administrator has issued a final approval.

\* \* \* \* \*

**PART 87—CONTROL OF AIR POLLUTION FROM AIRCRAFT AND AIRCRAFT ENGINES**

■ 51. The authority citation for part 87 continues to read as follows:

*Authority:* 42 U.S.C. 7401 *et seq.*

■ 52. Revise § 87.4 to read as follows:

**§ 87.4 Treatment of confidential information.**

The provisions of 40 CFR 1068.10 and 1068.11 apply for information you submit under this part.

**§ 87.42 [Amended]**

■ 53. Amend § 87.42 by removing and reserving paragraph (d).

**PART 600—FUEL ECONOMY AND GREENHOUSE GAS EXHAUST EMISSIONS OF MOTOR VEHICLES**

■ 54. The authority citation for part 600 continues to read as follows:

*Authority:* 49 U.S.C. 32901–23919q, Pub. L. 109–58.

■ 55. Amend § 600.001 by removing the paragraph heading from paragraph (e) and adding paragraph (f) to read as follows:

**§ 600.001 General applicability.**

\* \* \* \* \*

(f) Unless we specify otherwise, send all reports and requests for approval to the Designated Compliance Officer (see § 600.002).

■ 56. Amend § 600.002 by adding a definition for “Designated Compliance Officer” in alphabetical order and revising the definitions for “Engine code”, “SC03”, and “US06” to read as follows:

**§ 600.002 Definitions.**

\* \* \* \* \*

*Designated Compliance Officer* means the Director, Light-Duty Vehicle Center, U.S. Environmental Protection Agency, 2000 Traverwood Drive, Ann Arbor, MI 48105; [complianceinfo@epa.gov](mailto:complianceinfo@epa.gov); [www.epa.gov/ve-certification](http://www.epa.gov/ve-certification).

\* \* \* \* \*

*Engine code* means one of the following:

(1) For LDV, LDT, and MDPV, *engine code* means a unique combination, within a test group (as defined in § 86.1803 of this chapter), of displacement, fuel injection (or

carburetion or other fuel delivery system), calibration, distributor calibration, choke calibration, auxiliary emission control devices, and other engine and emission control system components specified by the Administrator. For electric vehicles, engine code means a unique combination of manufacturer, electric traction motor, motor configuration, motor controller, and energy storage device.

(2) For HDV, *engine code* has the meaning given in § 86.1819–14(d)(12) of this chapter.

\* \* \* \* \*

*SC03* means the test procedure specified in 40 CFR 1066.801(c)(2).

\* \* \* \* \*

*US06* means the test procedure as described in 40 CFR 1066.801(c)(2).

\* \* \* \* \*

■ 57. Amend § 600.011 by revising paragraphs (a) and (c)(2) to read as follows:

**§ 600.011 Incorporation by reference.**

(a) Certain material is incorporated by reference into this part with the approval of the Director of the Federal Register in accordance with 5 U.S.C. 552(a) and 1 CFR part 51. To enforce any edition other than that specified in this section, the Environmental Protection Agency (EPA) must publish a document in the **Federal Register** and the material must be available to the public. All approved material is available for inspection at the EPA and at the National Archives and Records Administration (NARA). Contact EPA at: U.S. EPA, Air and Radiation Docket and Information Center, 1301 Constitution Ave. NW, Room B102, EPA West Building, Washington, DC 20460, [www.epa.gov/dockets](http://www.epa.gov/dockets), (202) 202–1744. For information on the availability of this material at NARA, email: [fr.inspection@nara.gov](mailto:fr.inspection@nara.gov), or go to: [www.archives.gov/federal-register/cfr/ibr-locations.html](http://www.archives.gov/federal-register/cfr/ibr-locations.html). The material may be obtained from the sources in the following paragraphs of this section.

\* \* \* \* \*

(c) \* \* \*

(2) SAE J1634, Battery Electric Vehicle Energy Consumption and Range Test Procedure, revised July 2017; IBR approved for §§ 600.116–12(a); 600.210–12(d); 600.311–12(j) and (k).

\* \* \* \* \*

**§§ 600.106–08, 600.108–08, 600.109–08, and 600.110–08 [Removed]**

■ 58. Amend subpart B by removing the following sections: §§ 600.106–08, 600.108–08, 600.109–08, and 600.110–08.



■ 59. Amend § 600.111–08 by revising the introductory text to read as follows:

**§ 600.111–08 Test procedures.**

This section describes test procedures for the FTP, highway fuel economy test (HFET), US06, SC03, and the cold temperature FTP tests. See 40 CFR 1066.801(c) for an overview of these procedures. Perform testing according to test procedures and other requirements contained in this part 600 and in 40 CFR part 1066. This testing includes specifications and procedures for equipment, calibrations, and exhaust sampling. Manufacturers may use data collected according to previously published test procedures for model years through 2021. In addition, we may approve the use of previously published test procedures for later model years as an alternative procedure under 40 CFR 1066.10(c). Manufacturers must comply with regulatory requirements during the transition as described in 40 CFR 86.101 and 86.201.

\* \* \* \* \*

**§ 600.112–08 [Removed]**

■ 60. Remove § 600.112–08.

■ 61. Amend § 600.113–12 by revising paragraphs (a)(1), (b) through (d), and (e)(1) to read as follows:

**§ 600.113–12 Fuel economy, CO<sub>2</sub> emissions, and carbon-related exhaust emission calculations for FTP, HFET, US06, SC03 and cold temperature FTP tests.**

\* \* \* \* \*

(a) \* \* \*

(1) Calculate the weighted grams/mile values for the FTP test for CO<sub>2</sub>, HC, and CO, and where applicable, CH<sub>3</sub>OH, C<sub>2</sub>H<sub>5</sub>OH, C<sub>2</sub>H<sub>4</sub>O, HCHO, NMHC, N<sub>2</sub>O, and CH<sub>4</sub> as specified in 40 CFR 1066.605. Measure and record the test fuel's properties as specified in paragraph (f) of this section.

\* \* \* \* \*

(b) Calculate the HFET fuel economy as follows:

(1) Calculate the mass values for the highway fuel economy test for HC, CO, and CO<sub>2</sub>, and where applicable, CH<sub>3</sub>OH, C<sub>2</sub>H<sub>5</sub>OH, C<sub>2</sub>H<sub>4</sub>O, HCHO, NMHC, N<sub>2</sub>O, and CH<sub>4</sub> as specified in 40 CFR 1066.605. Measure and record the test fuel's properties as specified in paragraph (f) of this section.

(2) Calculate the grams/mile values for the highway fuel economy test for HC, CO, and CO<sub>2</sub>, and where applicable, CH<sub>3</sub>OH, C<sub>2</sub>H<sub>5</sub>OH, C<sub>2</sub>H<sub>4</sub>O, HCHO, NMHC, N<sub>2</sub>O, and CH<sub>4</sub> by dividing the mass values obtained in paragraph (b)(1) of this section, by the actual driving distance, measured in miles, as specified in 40 CFR 1066.840.

(c) Calculate the cold temperature FTP fuel economy as follows:

(1) Calculate the weighted grams/mile values for the cold temperature FTP test for HC, CO, and CO<sub>2</sub>, and where applicable, CH<sub>3</sub>OH, C<sub>2</sub>H<sub>5</sub>OH, C<sub>2</sub>H<sub>4</sub>O, HCHO, NMHC, N<sub>2</sub>O, and CH<sub>4</sub> as specified in 40 CFR 1066.605.

(2) Calculate separately the grams/mile values for the cold transient phase, stabilized phase and hot transient phase of the cold temperature FTP test as specified in 40 CFR 1066.605.

(3) Measure and record the test fuel's properties as specified in paragraph (f) of this section.

(d) Calculate the US06 fuel economy as follows:

(1) Calculate the total grams/mile values for the US06 test for HC, CO, and CO<sub>2</sub>, and where applicable, CH<sub>3</sub>OH, C<sub>2</sub>H<sub>5</sub>OH, C<sub>2</sub>H<sub>4</sub>O, HCHO, NMHC, N<sub>2</sub>O, and CH<sub>4</sub> as specified in 40 CFR 1066.605.

(2) Calculate separately the grams/mile values for HC, CO, and CO<sub>2</sub>, and where applicable, CH<sub>3</sub>OH, C<sub>2</sub>H<sub>5</sub>OH, C<sub>2</sub>H<sub>4</sub>O, HCHO, NMHC, N<sub>2</sub>O, and CH<sub>4</sub>, for both the US06 City phase and the US06 Highway phase of the US06 test as specified in 40 CFR 1066.605 and 1066.831. In lieu of directly measuring the emissions of the separate city and highway phases of the US06 test according to the provisions of 40 CFR 1066.831, the manufacturer may optionally, with the advance approval of the Administrator and using good engineering judgment, analytically determine the grams/mile values for the city and highway phases of the US06 test. To analytically determine US06 City and US06 Highway phase emission results, the manufacturer shall multiply the US06 total grams/mile values determined in paragraph (d)(1) of this section by the estimated proportion of fuel use for the city and highway phases relative to the total US06 fuel use. The manufacturer may estimate the proportion of fuel use for the US06 City and US06 Highway phases by using modal CO<sub>2</sub>, HC, and CO emissions data, or by using appropriate OBD data (*e.g.*, fuel flow rate in grams of fuel per second), or another method approved by the Administrator.

(3) Measure and record the test fuel's properties as specified in paragraph (f) of this section.

(e) \* \* \*

(1) Calculate the grams/mile values for the SC03 test for HC, CO, and CO<sub>2</sub>, and where applicable, CH<sub>3</sub>OH, C<sub>2</sub>H<sub>5</sub>OH, C<sub>2</sub>H<sub>4</sub>O, HCHO, NMHC, N<sub>2</sub>O, and CH<sub>4</sub> as specified in 40 CFR 1066.605.

\* \* \* \* \*

■ 62. Amend § 600.115–11 by revising the introductory text to read as follows:

**§ 600.115–11 Criteria for determining the fuel economy label calculation method.**

This section provides the criteria to determine if the derived 5-cycle method for determining fuel economy label values, as specified in § 600.210–08(a)(2) or (b)(2) or § 600.210–12(a)(2) or (b)(2), as applicable, may be used to determine label values. Separate criteria apply to city and highway fuel economy for each test group. The provisions of this section are optional. If this option is not chosen, or if the criteria provided in this section are not met, fuel economy label values must be determined according to the vehicle-specific 5-cycle method specified in § 600.210–08(a)(1) or (b)(1) or § 600.210–12(a)(1) or (b)(1), as applicable. However, dedicated alternative-fuel vehicles (other than battery electric vehicles), dual fuel vehicles when operating on the alternative fuel, MDPVs, and vehicles imported by Independent Commercial Importers may use the derived 5-cycle method for determining fuel economy label values whether or not the criteria provided in this section are met. Manufacturers may alternatively account for this effect for battery electric vehicles, fuel cell vehicles, and plug-in hybrid electric vehicles (when operating in the charge-depleting mode) by multiplying 2-cycle fuel economy values by 0.7 and dividing 2-cycle CO<sub>2</sub> emission values by 0.7.

\* \* \* \* \*

■ 63. Amend § 600.116–12 by revising paragraph (a) to read as follows:

**§ 600.116–12 Special procedures related to electric vehicles and hybrid electric vehicles.**

(a) Determine fuel economy values for electric vehicles as specified in §§ 600.210 and 600.311 using the procedures of SAE J1634 (incorporated by reference in § 600.011). Use the procedures of SAE J1634, Section 8, with the following clarifications and modifications for using this and other sections of SAE J1634:

(1) Vehicles that cannot complete the Multi-Cycle Range and Energy Consumption Test (MCT) because they are unable travel the distance required to complete the test with a fully charged battery, or they are unable to achieve the maximum speed on either the UDSS or HFEDS (Highway Fuel Economy Drive Cycle also known as the HFET) cycle should seek Administrator approval to use the procedures outlined in SAE J1634 Section 7 Single Cycle Range and Energy Consumption Test (SCT).

(2) The MCT includes the following key-on soak times and key-off soak periods:

(i) As noted in SAE J1634 Section 8.3.4, a 15 second key-on pause is required between UDDS<sub>1</sub> and HFEDS<sub>1</sub>, and UDDS<sub>3</sub> and HFEDS<sub>2</sub>. The key-on pause is considered a part of the HFEDS<sub>1</sub> and HFEDS<sub>2</sub> drive cycle.

(ii) As noted in SAE J1634 Section 8.3.4, a 10 minute key-off soak period is required between HFEDS<sub>1</sub> and UDDS<sub>2</sub>, and HFEDS<sub>2</sub> and UDDS<sub>4</sub>.

(iii) A 5-minute minimum key-off soak period is required between UDDS<sub>2</sub> and the first phase of the mid-test constant speed cycle, and UDDS<sub>4</sub> and the first phase of the end-of-test constant speed cycle.

(iv) If multiple phases are required during either the mid-test constant speed cycle or the end-of-test constant speed cycle there must be a minimum 5-minute key-off soak period between each constant speed phase. The key-off soak periods between the constant speed phases may last for up to a maximum of 30 minutes.

(3) As noted in SAE J1634 Section 8.3.4, during all 'key-off' soak periods, the key or power switch must be in the "off" position, the hood must be closed, the test cell fan(s) must be off, and the brake pedal not depressed. For vehicles which do not have a key or power switch the vehicle must be placed in the 'mode' the manufacturer recommends when the vehicle is to be parked and the occupants exit the vehicle.

(4) Either Method 1 or Method 2 described in Appendix A of SAE J1634 may be used to estimate the mid-test constant speed cycle distance ( $d_M$ ). The mid-test constant speed cycle distance calculation needs to be performed prior to beginning the test and should not use data from the test being performed. If Method 2 is used, multiply the result determined by the Method 2 equation by 0.8 to determine the mid-test constant speed cycle distance ( $d_M$ ).

(5) Divide the mid-test constant speed cycle distance ( $d_M$ ) by 65 mph to determine the total time required for the mid-test constant speed cycle. If the time required is one-hour or less the mid-test constant speed cycle can be performed with no key-off soak periods. If the time required is greater than one-hour the mid-test constant speed cycle must be separated into phases such that no phase exceeds more than one-hour. At the conclusion of each mid-test constant speed phase a minimum 5-minute key-off soak will be performed.

(6) Using good engineering judgment determine the end-of-test constant speed cycle distance so that it does not exceed 20% of the total distance driven during

the MCT as described in SAE J1634 Section 8.3.3.

(7) Divide the end-of-test constant speed cycle distance ( $d_E$ ) by 65 mph to determine the total time required for the end-of-test constant speed cycle. If the time required is one-hour or less the end-of-test constant speed cycle can be performed with no key-off soak periods. If the time required is greater than one-hour the end-of-test constant speed cycle must be separated into phases such that no phase exceeds more than one-hour. At the conclusion of each end-of-test constant speed phase a minimum 5-minute key-off soak will be performed.

(8) SAE J634 Section 3.13 defines useable battery energy (UBE) as the total DC discharge energy ( $Ed_{total}$ ), measured in DC watt-hours for a full discharge test. The total DC discharge energy is the sum of all measured phases of a test inclusive of all drive cycle types. As key-off soak periods are not considered part of the test phase, the discharge energy that occurs during the key-off soak periods is not included in the useable battery energy.

(9) Recharging the vehicle's battery must start within three hours after the end of testing.

(10) At the request of a manufacturer, the Administrator may approve the use of an earlier version of SAE J1634 when a manufacturer is carrying over data for vehicles tested using a prior version of SAE J1634.

(11) All label values related to fuel economy, energy consumption, and range must be based on 5-cycle testing or on values adjusted to be equivalent to 5-cycle results. Prior to performing testing to generate a 5-cycle adjustment factor, manufacturers must request Administrator approval to use SAE J1634 Appendices B and C for determining a 5-cycle adjustment factor with the following modifications, clarifications, and attestations:

(i) The 20 °F charge-depleting UDDS must be performed with a minimum 10-minute key-off soak period between each UDDS cycle. Key-off soak periods of up to 30 minutes are allowed. During all 'key-off' soak periods, the key or power switch must be in the "off" position, the hood must be closed, the test cell fan(s) must be off, and the brake pedal not depressed. For vehicles which do not have a key or power switch the vehicle must be placed in the 'mode' the manufacturer recommends when the vehicle is to be parked and the occupants exit the vehicle.

(ii) Prior to performing the 20 °F charge-depleting UDDS the vehicle must

soak for a minimum of 12 hours and a maximum of 36 hours at a temperature of 20 °F. Prior to beginning the 12 to 36 hour cold soak at 20 °F the vehicle must be fully charged, the charging can take place at test laboratory ambient temperatures (68 to 86 °F) or at 20 °F. During the 12 to 36 hour cold soak period the vehicle may not be connected to a charger nor is the vehicle cabin or battery to be preconditioned during the 20 °F soak period.

(iii) Beginning with the 2024 model year the 20 °F UDDS charge-depleting UDDS test will be replaced with a 20 °F UDDS test consisting of 2 UDDS cycles performed with a 10-minute key-off soak between the two UDDS cycles. The data from the two UDDS cycles will be used to calculate the five-cycle adjustment factor, instead of using the results from the entire charge-depleting data set. Manufacturers that have submitted and used the average data from 20 °F charge-depleting UDDS data sets will be required to revise their 5-cycle adjustment factor calculation and re-label vehicles using the data from the first two UDDS cycles only.

Manufacturers, at their discretion, would also be allowed to re-run the 20 °F UDDS test with the battery charged to a state-of-charge (SoC) determined by the manufacturer. The battery does not need to be at 100% SoC before the 20 °F cold soak.

(iv) Manufacturers must submit a written attestation to the Administrator at the completion of testing with the following information:

(A) A statement noting the SoC level of the rechargeable energy storage system (RESS) prior to beginning the 20°F cold soak for testing performed beginning with model year 2024.

(B) A statement confirming the vehicle was not charged or preconditioned during the 12 to 36 hour 20 °F soak period before starting the 20 °F UDDS cycle.

(C) A summary of all the 5-cycle test results and the calculations used to generate the 5-cycle adjustment factor, including all of the 20 °F UDDS cycles, the distance travelled during each UDDS and the measured DC discharge energy during each UDDS phase. Beginning in model year 2024, the 20 °F UDDS test results will consist of only two UDDS cycles.

(D) Beginning in model year 2024 the *RunningFC* equation used to calculate the City Fuel Economy found on Page 30 in Appendix C of J1634 should be replaced with the following equation when calculating City Fuel Economy:

$$\begin{aligned}
 \text{RunningFC} = & 0.82 \times \left[ \frac{0.48}{\text{Bag2 FTP}} + \frac{0.41}{\text{Bag3 FTP}} + \frac{0.11}{\text{US06 City}} \right] \\
 & + 0.18 \times \left[ \frac{1}{(20\text{degF UDDS1 Bag2} + 20\text{degF UDDS2 Bag2})} \right. \\
 & \left. + \frac{0.5}{20\text{degF UDDS2 Bag1}} \right] \\
 & + 0.133 \times 1.083 \times \left[ \frac{1}{\text{SC03}} - \left( \frac{0.61}{\text{Bag3 FTP}} + \frac{0.39}{\text{Bag2 FTP}} \right) \right]
 \end{aligned}$$

(E) A description of each test group and configuration which will use the 5-cycle adjustment factor, including the battery capacity of the vehicle used to generate the 5-cycle adjustment factor and the battery capacity of all the configurations to which it will be applied.

(v) At the conclusion of the manufacturers testing and after receiving the attestations from the manufacturer regarding the performance of the 20 °F UDDS test processes, the 5-cycle test results, and the summary of vehicles to which the manufacturer proposes applying the 5-cycle adjustment factor, the Administrator will review the submittals and inform the manufacturer in writing if the Administrator concurs with the manufacturer's proposal. If not, the Administrator will describe the rationale to the manufacturer for not approving their request.

\* \* \* \* \*

■ 64. Amend § 600.210–12 by revising paragraphs (a) introductory text, (a)(2)(iii), and (d) to read as follows:

**§ 600.210–12 Calculation of fuel economy and CO<sub>2</sub> emission values for labeling.**

(a) *General labels.* Except as specified in paragraphs (d) and (e) of this section, fuel economy and CO<sub>2</sub> emissions for general labels may be determined by one of two methods. The first is based on vehicle-specific model-type 5-cycle data as determined in § 600.209–12(b). This method is available for all vehicles and is required for vehicles that do not qualify for the second method as described in § 600.115 (other than electric vehicles). The second method, the derived 5-cycle method, determines fuel economy and CO<sub>2</sub> emissions values from the FTP and HFET tests using equations that are derived from vehicle-specific 5-cycle model type data, as determined in paragraph (a)(2) of this section. Manufacturers may voluntarily lower fuel economy (MPG) values and raise CO<sub>2</sub> values if they determine that the label values from any method are not representative of the in-use fuel economy and CO<sub>2</sub> emissions for that

model type, but only if the manufacturer changes both the MPG values and the CO<sub>2</sub> value and revises any other affected label value accordingly for a model type (including but not limited to the fuel economy 1–10 rating, greenhouse gas 1–10 rating, annual fuel cost, 5-year fuel cost information). Similarly, for any electric vehicles and plug-in hybrid electric vehicles, manufacturers may voluntarily lower the fuel economy (MPGe) and raise the energy consumption (kW-hr/100 mile) values if they determine that the label values are not representative of the in-use fuel economy, energy consumption, and CO<sub>2</sub> emissions for that model type, but only if the manufacturer changes both the MPGe and the energy consumption value and revises any other affected label value accordingly for a model type. Manufacturers may voluntarily lower the value for electric driving range if they determine that the label values are not representative of the in-use electric driving range.

\* \* \* \* \*

(2) \* \* \*  
 (iii) Unless and until superseded by written guidance from the Administrator, the following intercepts and slopes shall be used in the equations in paragraphs (a)(2)(i) and (ii) of this section:

- City Intercept = 0.004091.
- City Slope = 1.1601.
- Highway Intercept = 0.003191.
- Highway Slope = 1.2945.

\* \* \* \* \*

(d) *Calculating combined fuel economy, CO<sub>2</sub> emissions, and driving range.* (1) If the criteria in § 600.115–11(a) are met for a model type, both the city and highway fuel economy and CO<sub>2</sub> emissions values must be determined using the vehicle-specific 5-cycle method. If the criteria in § 600.115–11(b) are met for a model type, the city fuel economy and CO<sub>2</sub> emissions values may be determined using either method, but the highway fuel economy and CO<sub>2</sub> emissions values must be determined using the vehicle-specific 5-cycle method (or modified 5-cycle method as allowed under § 600.114–12(b)(2)).

(2) If the criteria in § 600.115 are not met for a model type, the city and highway fuel economy and CO<sub>2</sub> emission label values must be determined by using the same method, either the derived 5-cycle or vehicle-specific 5-cycle.

(3) Manufacturers may use one of the following methods to determine 5-cycle values for fuel economy, CO<sub>2</sub> emissions, and driving range for electric vehicles:

- (i) Generate 5-cycle data as described in paragraph (a)(1) of this section using the procedures of SAE J1634 (incorporated by reference in § 600.011) with amendments and revisions as described in § 600.116–12(a).
- (ii) Multiply 2-cycle fuel economy values and driving range by 0.7 and divide 2-cycle CO<sub>2</sub> emission values by 0.7.

(iii) Manufacturers may ask the Administrator to approve adjustment factors for deriving 5-cycle fuel economy results from 2-cycle test data based on operating data from their in-use vehicles. Such data should be collected from multiple vehicles with different drivers over a range of representative driving routes and conditions. The Administrator may approve such an adjustment factor for any of the manufacturer's vehicle models that are properly represented by the collected data.

\* \* \* \* \*

■ 65. Amend § 600.311–12 by revising paragraphs (j)(2), (j)(4) introductory text, and (j)(4)(i) to read as follows:

**§ 600.311–12 Determination of values for fuel economy labels.**

\* \* \* \* \*

(j) \* \* \*  
 (2) For electric vehicles, determine the vehicle's overall driving range as described in Section 8 of SAE J1634 (incorporated by reference in § 600.011), with amendments and revisions as described in § 600.116. Determine separate range values for FTP-based city and HFET-based highway driving. Adjust these values to reflect actual in-use driving conditions, then calculate a combined value by arithmetically

averaging the two values, weighted 0.55 and 0.45 respectively, and rounding to the nearest whole number.

\* \* \* \* \*

(4) For plug-in hybrid electric vehicles, determine the adjusted charge-depleting (R<sub>cd</sub>) driving range, the adjusted all electric driving range (if applicable), and overall adjusted driving range as described in SAE J1711 (incorporated by reference in § 600.011), as described in § 600.116, as follows:

(i) Determine the vehicle's Actual Charge-Depleting Range, R<sub>cd</sub>, and adjust these values to reflect actual in-use driving conditions. Determine separate range values for FTP-based city and HFET-based highway driving, then calculate a combined value by arithmetically averaging the two values, weighted 0.55 and 0.45 respectively, and rounding to the nearest whole number. Precondition the vehicle as needed to minimize engine operation for consuming stored fuel vapors in evaporative canisters; for example, you may purge the evaporative canister or time a refueling event to avoid engine starting related to purging the canister. For vehicles that use combined power from the battery and the engine before the battery is fully discharged, also use this procedure to establish an all electric range by determining the distance the vehicle drives before the engine starts, rounded to the nearest mile. You may represent this as a range of values. We may approve adjustments to these procedures if they are necessary to properly characterize a vehicle's all electric range.

\* \* \* \* \*

■ 66. Amend § 600.510–12 by revising the entry defining the term “AFE” in paragraph (e) to read as follows:

**§ 600.510–12 Calculation of average fuel economy and average carbon-related exhaust emissions.**

\* \* \* \* \*

(e) \* \* \*

AFE = Average combined fuel economy as calculated in paragraph (c)(2) of this section, rounded to the nearest 0.0001 mpg;

\* \* \* \* \*

■ 67. Amend § 600.512–12 by adding paragraph (a)(3) and revising paragraph (b) to read as follows:

**§ 600.512–12 Model year report.**

(a) \* \* \*

(3) Separate reports shall be submitted for passenger automobiles and light trucks (as identified in § 600.510–12).

(b) The model year report shall be in writing, signed by the authorized representative of the manufacturer and shall be submitted no later than May 1

following the end of the model year. A manufacturer may request an extension for submitting the model year report if that is needed to provide all additional required data as determined in § 600.507–12. The request must clearly indicate the circumstances necessitating the extension.

\* \* \* \* \*

**PART 1027—FEES FOR VEHICLE AND ENGINE COMPLIANCE PROGRAMS**

■ 68. The authority citation for part 1027 continues to read as follows:

**Authority:** 42 U.S.C. 7401–7671q.

■ 69. Amend § 1027.101 by revising paragraph (a)(1) to read as follows:

**§ 1027.101 To whom do these requirements apply?**

(a) \* \* \*

(1) Motor vehicles and motor vehicle engines we regulate under 40 CFR part 86 or 1036. This includes light-duty vehicles, light-duty trucks, medium-duty passenger vehicles, highway motorcycles, and heavy-duty highway engines and vehicles.

\* \* \* \* \*

**PART 1030—CONTROL OF GREENHOUSE GAS EMISSIONS FROM ENGINES INSTALLED ON AIRPLANES**

■ 70. The authority citation for part 1030 continues to read as follows:

**Authority:** 42 U.S.C. 7401–7671q.

■ 71. Revise § 1030.98 to read as follows:

**§ 1030.98 Confidential information.**

The provisions of 40 CFR 1068.10 and 1068.11 apply for information you submit under this part.

**PART 1033—CONTROL OF EMISSIONS FROM LOCOMOTIVES**

■ 72. The authority citation for part 1033 continues to read as follows:

**Authority:** 42 U.S.C. 7401–7671q.

■ 73. Amend § 1033.1 by revising paragraph (e) to read as follows:

**§ 1033.1 Applicability.**

\* \* \* \* \*

(e) This part applies for locomotives that were certified as freshly manufactured or remanufactured locomotives under 40 CFR part 92.

**§ 1033.5 [Amended]**

■ 74. Amend § 1033.5 by removing and reserving paragraph (c).

■ 75. Amend § 1033.101 by revising the introductory text to read as follows:

**§ 1033.101 Exhaust emission standards.**

See appendix A of this part to determine how emission standards apply before 2023.

\* \* \* \* \*

**§ 1033.102 Removed]**

■ 76. Remove § 1033.102.

■ 77. Amend § 1033.115 by revising paragraphs (b) introductory text and (c) to read as follows:

**§ 1033.115 Other requirements.**

\* \* \* \* \*

(b) *Adjustable parameters.*

Locomotives that have adjustable parameters must meet all the requirements of this part for any adjustment in the approved adjustable range. General provisions for adjustable parameters apply as specified in 40 CFR 1068.50. You must specify in your application for certification the adjustable range of each adjustable parameter on a new locomotive or new locomotive engine to—

\* \* \* \* \*

(c) *Prohibited controls.* (1) *General provisions.* You may not design or produce your locomotives with emission control devices, systems, or elements of design that cause or contribute to an unreasonable risk to public health, welfare, or safety while operating. For example, a locomotive may not emit a noxious or toxic substance it would otherwise not emit that contributes to such an unreasonable risk.

(2) *Vanadium sublimation in SCR catalysts.* For engines equipped with vanadium-based SCR catalysts, you must design the engine and its emission controls to prevent vanadium sublimation and protect the catalyst from high temperatures. We will evaluate your engine design based on the following information that you must include in your application for certification:

(i) Identify the threshold temperature for vanadium sublimation for your specified SCR catalyst formulation as described in 40 CFR 1065.1113 through 1065.1121.

(ii) Describe how you designed your engine to prevent catalyst inlet temperatures from exceeding the temperature you identify in paragraph (c)(2)(i) of this section, including consideration of engine wear through the useful life. Also describe your design for catalyst protection in case catalyst temperatures exceed the specified temperature. In your description, include how you considered elevated catalyst temperature resulting from sustained high-load engine operation, catalyst

exotherms, particulate filter regeneration, and component failure resulting in unburned fuel in the exhaust stream.

\* \* \* \* \*

■ 78. Amend § 1033.120 by revising paragraph (c) to read as follows:

**§ 1033.120 Emission-related warranty requirements.**

\* \* \* \* \*

(c) *Components covered.* The emission-related warranty covers all components whose failure would increase a locomotive's emissions of any regulated pollutant. This includes components listed in 40 CFR part 1068, appendix A, and components from any other system you develop to control emissions. The emission-related warranty covers the components you sell even if another company produces the component. Your emission-related warranty does not need to cover components whose failure would not increase a locomotive's emissions of any regulated pollutant. For remanufactured locomotives, your emission-related warranty is required to cover only those parts that you supply or those parts for which you specify allowable part manufacturers. It does not need to cover used parts that are not replaced during the remanufacture.

\* \* \* \* \*

■ 79. Amend § 1033.205 by revising paragraph (d)(6) to read as follows:

**§ 1033.205 Applying for a certificate of conformity.**

\* \* \* \* \*

(d) \* \* \*  
(6) A description of injection timing, fuel rate, and all other adjustable operating parameters, including production tolerances. For any operating parameters that do not qualify as adjustable parameters, include a description supporting your conclusion (see 40 CFR 1068.50(c)). Include the following in your description of each adjustable parameter:

(i) For mechanically controlled parameters, include the nominal or recommended setting, the intended physically adjustable range, the limits or stops used to limit adjustable ranges,

and production tolerances of the limits or stops used to establish each physically adjustable range. Also include information showing why the physical limits, stops or other means of limiting adjustment, are effective in preventing adjustment of parameters on in-use engines to settings outside your intended physically adjustable ranges.

(ii) For electronically controlled parameters, describe how your engines are designed to prevent unauthorized adjustments.

\* \* \* \* \*

■ 80. Amend § 1033.245 by adding paragraph (f) to read as follows:

**§ 1033.245 Deterioration factors.**

\* \* \* \* \*

(f) You may alternatively determine and verify deterioration factors based on bench-aged aftertreatment as described in 40 CFR 1036.245 and 1036.246, with the following exceptions:

(1) Apply the percentage of useful life from Table 1 of 40 CFR 1036.246 based on hours of operation rather than vehicle mileage.

(2) Perform verification testing as described in subpart F of this part rather than 40 CFR 1036.520. The provisions of 40 CFR 1036.246(d)(2) and (3) do not apply. Perform testing consistent with the original certification to determine whether tested locomotives meet the duty-cycle emission standards in § 1033.101.

(3) Apply infrequent regeneration adjustment factors as specified in § 1033.535 rather than 40 CFR 1036.522.

■ 81. Revise § 1033.525 to read as follows:

**§ 1033.525 Smoke opacity testing.**

Analyze exhaust opacity test data as follows:

(a) Measure exhaust opacity using the procedures specified in 40 CFR 1065.1125. Perform the opacity test with a continuous digital recording of smokemeter response identified by notch setting over the entire locomotive test cycle specified in § 1033.515(c)(4) or § 1033.520(e)(4). Measure smokemeter response in percent opacity to within one percent resolution.

(b) Calibrate the smokemeter as follows:

(1) Calibrate using neutral density filters with approximately 10, 20, and 40 percent opacity. Confirm that the opacity values for each of these reference filters are NIST-traceable within 185 days of testing, or within 370 days of testing if you consistently protect the reference filters from light exposure between tests.

(2) Before each test, remove the smokemeter from the exhaust stream, if applicable, and calibrate as follows:

(i) *Zero.* Adjust the smokemeter to give a zero response when there is no detectable smoke.

(ii) *Linearity.* Insert each of the qualified reference filters in the light path perpendicular to the axis of the light beam and adjust the smokemeter to give a result within 1 percentage point of the named value for each reference filter.

(c) Use computer analysis to evaluate percent opacity for each notch setting. Treat the start of the first idle mode as the start of the test. Each mode ends when operator demand changes for the next mode (or for the end of the test). Analyze the opacity trace using the following procedure:

(1) *3 second peak.* Identify the highest opacity value over the test and integrate the highest 3 second average including that highest value.

(2) *30 second peak.* Divide the test into a series of 30 second segments, advancing each segment in 1 second increments. Determine the opacity value for each segment and identify the highest opacity value from all the 30 second segments.

(3) *Steady-state.* Calculate the average of second-by-second values between 120 and 180 seconds after the start of each mode. For RMC modes that are less than 180 seconds, calculate the average over the last 60 seconds of the mode. Identify the highest of those steady-state values from the different modes.

(d) Determine values of standardized percent opacity, *kstd*, by correcting to a reference optical path length of 1 meter for comparing to the standards using the following equation:

$$\kappa_{\text{std}} = 100 \cdot \left( 1 - \left( 1 - \frac{\kappa_{\text{meas}}}{100} \right)^{\frac{1}{l_{\text{meas}}}} \right)$$

Eq. 1033.525-1

Where:

$\kappa_{\text{meas}}$  = the value of percent opacity from paragraphs (c)(1) through (3) of this section.

$l_{\text{meas}}$  = the smokemeter’s optical path length in the exhaust plume, expressed to the nearest 0.01 meters.

*Example:*

$\kappa_m = 14.1 \%$

$l_{\text{meas}} = 1.11 \text{ m}$

$$\kappa_{\text{std}} = 100 \cdot \left( 1 - \left( 1 - \frac{14.1}{100} \right)^{\frac{1}{1.11}} \right) = 12.8 \%$$

■ 82. Amend § 1033.630 by revising paragraph (b)(1) to read as follows:

**§ 1033.630 Staged-assembly and delegated assembly exemptions.**

\* \* \* \* \*

(b) \* \* \*

(1) In cases where an engine has been assembled in its certified configuration, properly labeled, and will not require an aftertreatment device to be attached when installed in the locomotive, no exemption is needed to ship the engine. You do not need an exemption to ship engines without specific components if they are not emission-related components identified in appendix A of 40 CFR part 1068.

■ 83. Amend § 1033.815 by revising paragraph (f) to read as follows:

**§ 1033.815 Maintenance, operation, and repair.**

\* \* \* \* \*

(f) Failure to perform required maintenance is a violation of the

tampering prohibition in 40 CFR 1068.101(b)(1). Failure of any person to comply with the recordkeeping requirements of this section is a violation of 40 CFR 1068.101(a)(2).

■ 84. Amend § 1033.901 by revising the definition of “Designated Compliance Officer” to read as follows:

**§ 1033.901 Definitions.**

\* \* \* \* \*

*Designated Compliance Officer* means the Director, Diesel Engine Compliance Center, U.S. Environmental Protection Agency, 2000 Traverwood Drive, Ann Arbor, MI 48105; *complianceinfo@epa.gov*; *www.epa.gov/ve-certification*.

\* \* \* \* \*

■ 85. Redesignate appendix I to part 1033 as appendix A to part 1033 and revise newly redesignated appendix A to read as follows:

**Appendix A to Part 1033—Original Standards for Tier 0, Tier 1 and Tier 2 Locomotives**

(a) Locomotives were originally subject to Tier 0, Tier 1, and Tier 2 emission standards described in paragraph (b) of this appendix as follows:

(1) The Tier 0 and Tier 1 standards in paragraph (b) of this appendix applied instead of the Tier 0 and Tier 1 standards of § 1033.101 for locomotives manufactured and remanufactured before January 1, 2010. For example, a locomotive that was originally manufactured in 2004 and remanufactured on April 10, 2011 was subject to the original Tier 1 standards specified in paragraph (b) of this appendix and became subject to the Tier 1 standards of § 1033.101 when it was remanufactured on April 10, 2011.

(2) The Tier 2 standards in paragraph (b) of this appendix applied instead of the Tier 2 standards of § 1033.101 for locomotives manufactured and remanufactured before January 1, 2013.

(b) The following NO<sub>x</sub> and PM standards applied before the dates specified in paragraph (a) of this appendix:

TABLE 1 TO APPENDIX A—ORIGINAL LOCOMOTIVE EMISSION STANDARDS

Type of standard	Year of original manufacture	Tier	Standards (g/bhp-hr)		
			NO <sub>x</sub>	PM-primary	PM-alternate <sup>1</sup>
Line-haul .....	1973–1992	Tier 0 .....	9.5	0.60	0.30
	1993–2004	Tier 1 .....	7.4	0.45	0.22
	2005–2011	Tier 2 .....	5.5	0.20	0.10
Switch .....	1973–1992	Tier 0 .....	14.0	0.72	0.36
	1993–2004	Tier 1 .....	11.0	0.54	0.27
	2005–2011	Tier 2 .....	8.1	0.24	0.12

<sup>1</sup>Locomotives certified to the alternate PM standards are also subject to alternate CO standards of 10.0 for the line-haul cycle and 12.0 for the switch cycle.

(c) The original Tier 0, Tier 1, and Tier 2 standards for HC and CO emissions and smoke are the same standards identified in § 1033.101.

## PART 1036—CONTROL OF EMISSIONS FROM NEW AND IN-USE HEAVY-DUTY HIGHWAY ENGINES

■ 86. Revise part 1036 to read as follows:

### PART 1036—CONTROL OF EMISSIONS FROM NEW AND IN-USE HEAVY-DUTY HIGHWAY ENGINES

Sec.

#### Subpart A—Overview and Applicability

- 1036.1 Applicability.
- 1036.2 Compliance responsibility.
- 1036.5 Excluded engines.
- 1036.10 Organization of this part.
- 1036.15 Other applicable regulations.
- 1036.30 Submission of information.

#### Subpart B—Emission Standards and Related Requirements

- 1036.101 Overview of exhaust emission standards.
- 1036.104 Criteria pollutant emission standards—NO<sub>x</sub>, HC, PM, and CO.
- 1036.108 Greenhouse gas emission standards—CO<sub>2</sub>, CH<sub>4</sub>, and N<sub>2</sub>O.
- 1036.110 Diagnostic controls.
- 1036.111 Inducements related to SCR.
- 1036.115 Other requirements.
- 1036.120 Emission-related warranty requirements.
- 1036.125 Maintenance instructions and allowable maintenance.
- 1036.130 Installation instructions for vehicle manufacturers.
- 1036.135 Labeling.
- 1036.140 Primary intended service class and engine cycle.
- 1036.150 Interim provisions.

#### Subpart C—Certifying Engine Families

- 1036.201 General requirements for obtaining a certificate of conformity.
- 1036.205 Requirements for an application for certification.
- 1036.210 Preliminary approval before certification.
- 1036.225 Amending applications for certification.
- 1036.230 Selecting engine families.
- 1036.235 Testing requirements for certification.
- 1036.240 Demonstrating compliance with criteria pollutant emission standards.
- 1036.241 Demonstrating compliance with greenhouse gas emission standards.
- 1036.245 Deterioration factors for exhaust emission standards.
- 1036.246 Verifying deterioration factors.
- 1036.250 Reporting and recordkeeping for certification.
- 1036.255 EPA oversight on certificates of conformity.

#### Subpart D—Testing Production Engines and Hybrid Powertrains

- 1036.301 Measurements related to GEM inputs in a selective enforcement audit.

#### Subpart E—In-use Testing

- 1036.401 Testing requirements for in-use engines.
- 1036.405 Overview of the manufacturer-run field-testing program.
- 1036.410 Selecting and screening vehicles and engines for testing.
- 1036.415 Preparing and testing engines.
- 1036.420 Pass criteria for individual engines.
- 1036.425 Pass criteria for engine families.
- 1036.430 Reporting requirements.
- 1036.435 Recordkeeping requirements.
- 1036.440 Warranty obligations related to in-use testing.

#### Subpart F—Test Procedures

- 1036.501 General testing provisions.
- 1036.503 Engine data and information to support vehicle certification.
- 1036.505 Supplemental Emission Test.
- 1036.510 Federal Test Procedure.
- 1036.512 Low Load Cycle.
- 1036.514 Clean Idle test.
- 1036.515 Test procedures for off-cycle testing.
- 1036.520 Test procedures to verify deterioration factors.
- 1036.522 Infrequently regenerating aftertreatment devices.
- 1036.527 Powertrain system rated power determination.
- 1036.530 Calculating greenhouse gas emission rates.
- 1036.535 Determining steady-state engine fuel maps and fuel consumption at idle.
- 1036.540 Determining cycle-average engine fuel maps.
- 1036.543 Carbon balance error verification.

#### Subpart G—Special Compliance Provisions

- 1036.601 Overview of compliance provisions.
- 1036.605 Alternate emission standards for engines used in specialty vehicles.
- 1036.610 Off-cycle technology credits and adjustments for reducing greenhouse gas emissions.
- 1036.615 Engines with Rankine cycle waste heat recovery and hybrid powertrains.
- 1036.620 Alternate CO<sub>2</sub> standards based on model year 2011 compression-ignition engines.
- 1036.625 In-use compliance with CO<sub>2</sub> family emission limits (FELs).
- 1036.630 Certification of engine greenhouse gas emissions for powertrain testing.
- 1036.635 —[Reserved]
- 1036.655 Special provisions for diesel-fueled engines sold in American Samoa or the Commonwealth of the Northern Mariana Islands.

#### Subpart H—Averaging, Banking, and Trading for Certification

- 1036.701 General provisions.
- 1036.705 Generating and calculating emission credits.
- 1036.710 Averaging.
- 1036.715 Banking.
- 1036.720 Trading.
- 1036.725 Required information for certification.
- 1036.730 ABT reports.
- 1036.735 Recordkeeping.
- 1036.740 Restrictions for using emission credits.

- 1036.741 Using emission credits from electric vehicles and hydrogen fuel-cell vehicles.
- 1036.745 End-of-year CO<sub>2</sub> credit deficits.
- 1036.750 Consequences for noncompliance.
- 1036.755 Information provided to the Department of Transportation.

#### Subpart I—Definitions and Other Reference Information

- 1036.801 Definitions.
- 1036.805 Symbols, abbreviations, and acronyms.
- 1036.810 Incorporation by reference.
- 1036.815 Confidential information.
- 1036.820 Requesting a hearing.
- 1036.825 Reporting and recordkeeping requirements.

#### Appendix A of Part 1036—Summary of Previous Emission Standards

#### Appendix B of Part 1036—Transient Duty Cycles

#### Appendix C of Part 1036—Default Engine Fuel Maps for § 1036.540

Authority: 42 U.S.C. 7401–7671q.

#### Subpart A—Overview and Applicability

##### § 1036.1 Applicability.

(a) Except as specified in § 1036.5, the provisions of this part apply for engines that will be installed in heavy-duty vehicles (including glider vehicles).

(b) Heavy-duty engines produced before model year 2027 are subject to greenhouse gas emission standards and related provisions under this part as specified in § 1036.108; these engines are subject to exhaust emission standards for HC, CO, NO<sub>x</sub>, and PM and related provisions under 40 CFR part 86, subpart A, instead of this part, except as follows:

(1) The provisions of §§ 1036.115, 1036.501(f), and 1036.601 apply.

(2) 40 CFR parts 85 and 86 may specify that certain provisions apply.

(3) This part describes how several individual provisions are optional or mandatory before model year 2027. For example, § 1036.150(a) describes how you may generate emission credits by meeting the standards of this part before model year 2027.

(c) The provisions of this part also apply for fuel conversions of all engines described in paragraph (a) of this section as described in 40 CFR 85.502.

(d) Gas turbine heavy-duty engines and other heavy-duty engines not meeting the definition *compression-ignition* or *spark-ignition* are deemed to be compression-ignition engines for purposes of this part.

(e) For the purpose of applying the provisions of this part, engines include all emission-related components and any components or systems that should be identified in your application for

certification, such as hybrid components for engines that are certified as hybrid engines or hybrid powertrains.

#### **§ 1036.2 Compliance responsibility.**

The regulations in this part contain provisions that affect both engine manufacturers and others. However, the requirements of this part are generally addressed to the engine manufacturer(s). The term “you” generally means the engine manufacturer(s), especially for issues related to certification. Additional requirements and prohibitions apply to other persons as specified in subpart G of this part and 40 CFR part 1068.

#### **§ 1036.5 Excluded engines.**

(a) The provisions of this part do not apply to engines used in medium-duty passenger vehicles or other heavy-duty vehicles that are subject to regulation under 40 CFR part 86, subpart S, except as specified in 40 CFR part 86, subpart S, and § 1036.150(j). For example, this exclusion applies for engines used in vehicles certified to the standards of 40 CFR 86.1818 and 86.1819.

(b) An engine installed in a heavy-duty vehicle that is not used to propel the vehicle is not a heavy-duty engine. The provisions of this part therefore do not apply to these engines. Note that engines used to indirectly propel the vehicle (such as electrical generator engines that provide power to batteries for propulsion) are subject to this part. See 40 CFR part 1039, 1048, or 1054 for other requirements that apply for these auxiliary engines. See 40 CFR part 1037 for requirements that may apply for vehicles using these engines, such as the evaporative emission requirements of 40 CFR 1037.103.

(c) The provisions of this part do not apply to aircraft or aircraft engines. Standards apply separately to certain aircraft engines, as described in 40 CFR part 87.

(d) The provisions of this part do not apply to engines that are not internal combustion engines, except as specified in § 1036.741. For example, the provisions of this part generally do not apply to fuel cells. Note that gas turbine engines are internal combustion engines.

(e) The provisions of this part do not apply for model year 2013 and earlier heavy-duty engines unless they were:

- (1) Voluntarily certified to this part.
- (2) Installed in a glider vehicle subject to 40 CFR part 1037.

#### **§ 1036.10 Organization of this part.**

This part is divided into the following subparts:

(a) Subpart A of this part defines the applicability of this part and gives an overview of regulatory requirements.

(b) Subpart B of this part describes the emission standards and other requirements that must be met to certify engines under this part. Note that § 1036.150 describes certain interim requirements and compliance provisions that apply only for a limited time.

(c) Subpart C of this part describes how to apply for a certificate of conformity.

(d) Subpart D of this part addresses testing of production engines.

(e) Subpart E of this part describes provisions for testing in-use engines.

(f) Subpart F of this part describes how to test your engines (including references to other parts of the Code of Federal Regulations).

(g) Subpart G of this part describes requirements, prohibitions, and other provisions that apply to engine manufacturers, vehicle manufacturers, owners, operators, rebuilders, and all others.

(h) Subpart H of this part describes how you may generate and use emission credits to certify your engines.

(i) Subpart I of this part contains definitions and other reference information.

#### **§ 1036.15 Other applicable regulations.**

(a) Parts 85 and 86 of this chapter describe additional provisions that apply to engines that are subject to this part. See § 1036.601.

(b) Part 1037 of this chapter describes requirements for controlling evaporative emissions and greenhouse gas emissions from heavy-duty vehicles, whether or not they use engines certified under this part.

(c) Part 1065 of this chapter describes procedures and equipment specifications for testing engines to measure exhaust emissions. Subpart F of this part describes how to apply the provisions of part 1065 of this chapter to determine whether engines meet the exhaust emission standards in this part.

(d) The requirements and prohibitions of part 1068 of this chapter apply as specified in § 1036.601 to everyone, including anyone who manufactures, imports, installs, owns, operates, or rebuilds any of the engines subject to this part, or vehicles containing these engines. See § 1036.601 to determine how to apply the part 1068 regulations for heavy-duty engines. The issues

addressed by these provisions include these seven areas:

(1) Prohibited acts and penalties for engine manufacturers, vehicle manufacturers, and others.

(2) Rebuilding and other aftermarket changes.

(3) Exclusions and exemptions for certain engines.

(4) Importing engines.

(5) Selective enforcement audits of your production.

(6) Recall.

(7) Procedures for hearings.

(e) Other parts of this chapter apply if referenced in this part.

#### **§ 1036.30 Submission of information.**

Unless we specify otherwise, send all reports and requests for approval to the Designated Compliance Officer (see § 1036.801). See § 1036.825 for additional reporting and recordkeeping provisions.

#### **Subpart B—Emission Standards and Related Requirements**

##### **§ 1036.101 Overview of exhaust emission standards.**

(a) You must show that engines meet the following exhaust emission standards:

(1) Criteria pollutant standards for NO<sub>x</sub>, HC, PM, and CO apply as described in § 1036.104.

(2) Greenhouse gas (GHG) standards for CO<sub>2</sub>, CH<sub>4</sub>, and N<sub>2</sub>O apply as described in § 1036.108.

(b) You may optionally demonstrate compliance with the emission standards of this part by testing hybrid engines and hybrid powertrains, rather than testing the engine alone. Except as specified, provisions of this part that reference engines apply equally to hybrid engines and hybrid powertrains.

##### **§ 1036.104 Criteria pollutant emission standards—NO<sub>x</sub>, HC, PM, and CO.**

This section describes the applicable NO<sub>x</sub>, HC, CO, and PM standards for model years 2027 and later. These standards apply equally for all primary intended service classes unless otherwise noted.

(a) *Emission standards.* Exhaust emissions may not exceed the standards in this section for the specified duty cycle, as follows:

(1) Measure emissions over the specified duty cycles using the test procedures described in subpart F of this part.

(2) The following emission standards apply over the FTP and SET duty cycles:



TABLE 1 TO PARAGRAPH (a)(2) OF § 1036.104—FTP AND SET EMISSION STANDARDS

Model year	NO <sub>x</sub> (mg/hp-hr)	HC (mg/hp-hr)	PM (mg/hp-hr)	CO (g/hp-hr)
2027–2030 .....	35	60	5	6.0
2031 and later .....	<sup>a</sup> 20	40	5	6.0

<sup>a</sup> The NO<sub>x</sub> standard identified for Heavy HDE applies for an intermediate useful life of 435,000 miles, 10 years, or 22,000 hours, whichever comes first. A standard of 40 mg/hp-hr applies for the rest of the useful life.

(3) The following emission standards apply for compression-ignition engines over the Low Load Cycle:

TABLE 2 TO PARAGRAPH (a)(3) OF § 1036.104—LOW LOAD CYCLE EMISSION STANDARDS

Model Year	NO <sub>x</sub> (mg/hp-hr)	HC (mg/hp-hr)	PM (mg/hp-hr)	CO (g/hp-hr)
2027–2030 .....	90	140	5	6.0
2031 and later .....	<sup>a</sup> 50	60	5	6.0

<sup>a</sup> The NO<sub>x</sub> standard identified for Heavy HDE applies for an intermediate useful life of 435,000 miles, 10 years, or 22,000 hours, whichever comes first. A standard of 100 mg/hp-hr applies for the rest of the useful life.

(4) Off-cycle emission standards apply for compression-ignition engines using the procedures specified in § 1036.515. For the idle bin, the NO<sub>x</sub> off-cycle emission standard is 10.0 g/hr starting in model years 2027 through 2030 and 7.5 g/hr starting in model year 2031. Additional off-cycle emission standards apply as described in the following table:

TABLE 3 TO PARAGRAPH (a)(4) OF § 1036.104—OFF-CYCLE EMISSION STANDARDS FOR COMPRESSION-IGNITION ENGINES

Model year	Bin	NO <sub>x</sub> (mg/hp-hr)	HC (mg/hp-hr)	PM (mg/hp-hr)	CO (g/hp-hr)
2027–2030 .....	Low load .....	180	280	10	12.0
	Medium/high load .....	70	120	10	12.0
2031 and later .....	Low load .....	<sup>a</sup> 75	90	8	9.0
	Medium/high load .....	<sup>a</sup> 30	60	8	9.0

<sup>a</sup> The low load and medium/high load NO<sub>x</sub> standards identified for Heavy HDE apply for an intermediate useful life of 435,000 miles, 10 years, or 22,000 hours, whichever comes first. A low load bin standard of 150 mg/hp-hr and a medium/high load bin standard of 60 mg/hp-hr apply for the rest of the useful life.

(b) *Clean Idle.* You may optionally certify compression-ignition engines to the Clean Idle NO<sub>x</sub> emission standard using the Clean Idle test specified in § 1036.514. The optional Clean Idle NO<sub>x</sub> emission standard is 30.0 g/h before model year 2024, 10.0 g/h for model years 2024 through 2026, and 5.0 g/hr for model year 2027 and later. The mass emission rate of HC, CO, and PM in g/hr during the Clean Idle test may not exceed the emission results from the idle modes of the SET duty cycle as described in § 1036.505(h) or the idle segments of the FTP duty cycle as described in § 1036.510(g). The standard applies separately to each mode of the Clean Idle test. If you certify an engine family to the Clean Idle standards, it is subject to all these voluntary standards as if they were mandatory.

(c) *Averaging, banking, and trading.* You may generate or use emission credits under the averaging, banking, and trading (ABT) program described in subpart H of this part for demonstrating compliance with NO<sub>x</sub> emission standards in paragraph (a) of this section. You must meet the PM, HC, and CO emission standards in § 1036.104(a) without generating or using emission credits.

(1) To generate or use emission credits, you must specify a family emission limit for each engine family. Declare the family emission limit corresponding to full useful life for engine operation over the FTP duty cycle, FEL<sub>FTP</sub>, expressed to the same number of decimal places as the emission standard. Use FEL<sub>FTP</sub> to

calculate emission credits in subpart H of this part.

(2) The following NO<sub>x</sub> FEL caps are the maximum values you may specify for FEL<sub>FTP</sub>:

(i) 150 mg/hp-hr for model year 2027 through 2030 Spark-ignition HDE, Light HDE, Medium HDE, and Heavy HDE.

(ii) 50 mg/hp-hr for model year 2031 and later Spark-ignition HDE, Light HDE, and Medium HDE.

(iii) 70 mg/hp-hr for model year 2031 and later Heavy HDE.

(3) Calculate the NO<sub>x</sub> family emission limit, FEL<sub>[cycle]NO<sub>x</sub></sub>, that applies for each duty-cycle or off-cycle standard using the following equation, noting that you must also use this approach to determine the FEL for each cycle that applies for Heavy HDE at intermediate useful life:

$$FEL_{[cycle]NO_x} = Std_{[cycle]NO_x} \cdot \frac{FEL_{FTPNO_x}}{Std_{FTPNO_x}}$$

Eq. 1036.104-1

Where:

$Std_{[cycle]NO_x}$  = the NO<sub>x</sub> emission standard that applies for the applicable cycle under paragraph (a) of this section for engines not participating in the ABT program.

$FEL_{FTPNO_x}$  = the engine family’s declared FEL for NO<sub>x</sub> over the FTP duty cycle from paragraph (c)(1) of this section.

$Std_{FTPNO_x}$  = the NO<sub>x</sub> emission standard that applies for the FTP duty cycle under paragraph (a) of this section for engines not participating in the ABT program.

*Example for model year 2029 Medium HDE for the SET:*

$$Std_{SETNO_x} = 35 \text{ mg/hp} \cdot \text{hr}$$

$$FEL_{FTP} = 121 \text{ mg/hp} \cdot \text{hr}$$

$$Std_{FTPNO_x} = 35 \text{ mg/hp} \cdot \text{hr}$$

$$FEL_{SETNO_x} = 35 \cdot \frac{121}{35} = 121 \text{ mg/hp} \cdot \text{hr}$$

(4) The family emission limits in this paragraph (c) serve as the emission standards for compliance testing instead of the standards specified in this section.

(d) *Fuel types.* The exhaust emission standards in this section apply for engines using the fuel type on which the engines in the engine family are

designed to operate. You must meet the numerical emission standards for HC in this section based on the following types of hydrocarbon emissions for engines powered by the following fuels:

- (1) Alcohol-fueled engines: NMHCE emissions.
- (2) Gaseous-fueled engines: NMNEHC emissions.

(3) Other engines: NMHC emissions.

(e) *Useful life.* The exhaust emission standards of this section apply for the useful life, expressed in vehicle miles, or hours of engine operation, or years in service, whichever comes first, as follows:

TABLE 4 TO PARAGRAPH (e) OF § 1036.104—USEFUL LIFE BY PRIMARY INTENDED SERVICE CLASS

Primary intended service class	Model year 2027 through 2030		Model year 2031 and later	
	Miles	Years	Miles	Years
Spark-ignition HDE .....	155,000	12	200,000	15
Light HDE .....	190,000	12	270,000	15
Medium HDE .....	270,000	11	350,000	12
Heavy HDE <sup>a</sup> .....	600,000	11	800,000 <sup>b</sup>	12

<sup>a</sup> Useful life for Heavy HDE is also expressed as 32,000 operating hours for model year 2027 through 2030, and 40,000 operating hours for model year 2031 and later. For an individual engine, the useful life is no shorter than 10 years or 100,000 miles, whichever occurs first, regardless of operating hours.

<sup>b</sup> Additional standards apply for Heavy HDE during an intermediate useful life of 435,000 miles, 10 years, or 22,000 hours, whichever comes first.

(f) *Applicability for testing.* The emission standards in this subpart apply to all testing, including certification, selective enforcement audits, and in-use testing. For selective enforcement audits, we may require you to perform the appropriate duty-cycle testing as specified in §§ 1036.505, 1036.510, and 1036.512. The off-cycle standards in this section apply for duty-cycle testing you perform for a selective enforcement audit. We may direct you to do additional testing to show that your engines meet the off-cycle standards.

**§ 1036.108 Greenhouse gas emission standards—CO<sub>2</sub>, CH<sub>4</sub>, and N<sub>2</sub>O.**

This section contains standards and other regulations applicable to the emission of the air pollutant defined as the aggregate group of six greenhouse gases: Carbon dioxide, nitrous oxide, methane, hydrofluorocarbons, perfluorocarbons, and sulfur hexafluoride. This section describes the applicable CO<sub>2</sub>, N<sub>2</sub>O, and CH<sub>4</sub> standards for engines.

(a) *Emission standards.* Emission standards apply for engines and

optionally powertrains measured using the test procedures specified in subpart F of this part as follows:

(1) CO<sub>2</sub> emission standards in this paragraph (a)(1) apply based on testing as specified in subpart F of this part. The applicable test cycle for measuring CO<sub>2</sub> emissions differs depending on the engine family’s primary intended service class and the extent to which the engines will be (or were designed to be) used in tractors. For Medium HDE and Heavy HDE certified as tractor engines, measure CO<sub>2</sub> emissions using the SET

steady-state duty cycle specified in § 1036.505. This testing with the SET duty cycle is intended for engines designed to be used primarily in tractors and other line-haul applications. Note that the use of some SET-certified tractor engines in vocational applications does not affect your certification obligation under this paragraph (a)(1); see other provisions of this part and 40 CFR part 1037 for limits on using engines certified to only one

cycle. For Medium HDE and Heavy HDE certified as both tractor and vocational engines, measure CO<sub>2</sub> emissions using the SET duty cycle specified in § 1036.505 and the FTP transient duty cycle specified in § 1036.510. Testing with both SET and FTP duty cycles is intended for engines that are designed for use in both tractor and vocational applications. For all other engines (including Spark-ignition HDE), measure CO<sub>2</sub> emissions using the FTP

transient duty cycle specified in § 1036.510.

(i) The CO<sub>2</sub> standard is 627 g/hp-hr for all spark-ignition engines for model years 2016 through 2020. This standard continues to apply in later model years for all spark-ignition engines that are not Heavy HDE.

(ii) The following CO<sub>2</sub> standards apply for compression-ignition engines (in g/hp-hr):

TABLE 1 TO PARAGRAPH (a)(1)(ii) OF § 1036.108—COMPRESSION-IGNITION ENGINE STANDARDS FOR MODEL YEARS 2014–2020

Model years	Light heavy-duty	Medium heavy-duty-vocational	Heavy heavy-duty-vocational	Medium heavy-duty-tractor	Heavy heavy-duty-tractor
2014–2016 .....	600	600	567	502	475
2017–2020 .....	576	576	555	487	460

(iii) The following CO<sub>2</sub> standards apply for compression-ignition engines and all Heavy HDE (in g/hp-hr):

TABLE 2 TO PARAGRAPH (a)(1)(iii) OF § 1036.108—COMPRESSION-IGNITION ENGINE STANDARDS FOR MODEL YEARS 2021 AND LATER

Model years	Light heavy-duty	Medium heavy-duty-vocational	Heavy heavy-duty-vocational	Medium heavy-duty-tractor	Heavy heavy-duty-tractor
2021–2023 .....	563	545	513	473	447
2024–2026 .....	555	538	506	461	436
2027 and later .....	552	535	503	457	432

(iv) You may certify spark-ignition engines to the compression-ignition standards for the appropriate model year under this paragraph (a). If you do this, those engines are treated as compression-ignition engines for all the provisions of this part.

(2) The CH<sub>4</sub> emission standard is 0.10 g/hp-hr when measured over the applicable transient duty cycle specified in § 1036.510. This standard begins in model year 2014 for compression-ignition engines and in model year 2016 for spark-ignition engines. Note that this standard applies for all fuel types just like the other standards of this section.

(3) The N<sub>2</sub>O emission standard is 0.10 g/hp-hr when measured over the transient duty cycle specified in

§ 1036.510. This standard begins in model year 2014 for compression-ignition engines and in model year 2016 for spark-ignition engines.

(b) *Family Certification Levels.* You must specify a CO<sub>2</sub> Family Certification Level (FCL) for each engine family. The FCL may not be less than the certified emission level for the engine family. The CO<sub>2</sub> Family Emission Limit (FEL) for the engine family is equal to the FCL multiplied by 1.03.

(c) *Averaging, banking, and trading.* You may generate or use emission credits under the averaging, banking, and trading (ABT) program described in subpart H of this part for demonstrating compliance with CO<sub>2</sub> emission standards. Credits (positive and

negative) are calculated from the difference between the FCL and the applicable emission standard. As described in § 1036.705, you may use CO<sub>2</sub> credits to certify your engine families to FELs for N<sub>2</sub>O and/or CH<sub>4</sub>, instead of the N<sub>2</sub>O/CH<sub>4</sub> standards of this section that otherwise apply. Except as specified in §§ 1036.150 and 1036.705, you may not generate or use credits for N<sub>2</sub>O or CH<sub>4</sub> emissions.

(d) *Useful life.* The exhaust emission standards of this section apply for the useful life, expressed as vehicle miles, or hours of engine operation, or years in service, whichever comes first, as follows:

TABLE 3 TO PARAGRAPH (d) OF § 1036.108—USEFUL LIFE BY PRIMARY INTENDED SERVICE CLASS FOR MODEL YEAR 2021 AND LATER

Primary intended service class	Miles	Years
Spark-ignition HDE .....	150,000	15
Light HDE .....	150,000	15
Medium HDE .....	185,000	10

TABLE 3 TO PARAGRAPH (d) OF § 1036.108—USEFUL LIFE BY PRIMARY INTENDED SERVICE CLASS FOR MODEL YEAR 2021 AND LATER—Continued

Primary intended service class	Miles	Years
Heavy HDE <sup>a</sup>	435,000	10

<sup>a</sup> Useful life for Heavy HDE is also expressed as 22,000 operating hours. For an individual engine, the useful life is no shorter than 10 years or 100,000 miles, whichever occurs first, regardless of operating hours.

(e) *Applicability for testing.* The emission standards in this subpart apply as specified in this paragraph (e) to all duty-cycle testing (according to the applicable test cycles) of testable configurations, including certification, selective enforcement audits, and in-use testing. The CO<sub>2</sub> FCLs serve as the CO<sub>2</sub> emission standards for the engine family with respect to certification and confirmatory testing instead of the standards specified in paragraph (a)(1) of this section. The FELs serve as the emission standards for the engine family with respect to all other duty-cycle testing. See §§ 1036.235 and 1036.241 to determine which engine configurations within the engine family are subject to testing. Note that engine fuel maps and powertrain test results also serve as standards as described in §§ 1036.535, 1036.540, and 1036.630 and 40 CFR 1037.550.

#### § 1036.110 Diagnostic controls.

Onboard diagnostic (OBD) systems must generally detect malfunctions in the emission control system, store trouble codes corresponding to detected malfunctions, and alert operators appropriately. Starting in model year 2027, new engines must have OBD systems as described in this section. You may optionally comply with any or all of the requirements of this section instead of 40 CFR 86.010–18 in earlier model years.

(a) Chassis-based OBD requirements apply instead of the requirements of this section for certain engines as follows:

(1) Heavy-duty engines intended to be installed in heavy duty vehicles at or below 14,000 pounds GVWR must meet the requirements in 40 CFR 86.1806.

(2) Heavy-duty spark-ignition engines intended to be installed in heavy-duty vehicles above 14,000 pounds GVWR may meet the requirements in 40 CFR 86.1806 if the engines share essential design characteristics with engines that the engine manufacturer also installs in vehicles certified under 40 CFR part 86, subpart S.

(b) Engines must comply with the 2019 heavy-duty OBD requirements adopted for California as described in this paragraph (b). California's 2019 heavy-duty OBD requirements are part of 13 CCR 1968.2, 1968.5, 1971.1, and

1971.5 (incorporated by reference in § 1036.810). We may approve your request to certify an OBD system meeting alternative specifications if you demonstrate that it meets the intent of this section. For example, we may approve your request for a system that meets a later version of California's OBD requirements if you demonstrate that it meets the intent of this section. To demonstrate that your engine meets the intent of this section, the OBD system meeting alternative specifications must address all the provisions described in this paragraph (b) and in paragraph (c) of this section. The following clarifications and exceptions apply for engines certified under this part:

(1) We may approve a small manufacturer's request to delay complying with the requirements of this section for up to three model years if that manufacturer has not certified those engines or other comparable engines in California for those model years.

(2) For engines not certified in California, references to vehicles meeting certain California Air Resources Board emission standards are understood to refer to the corresponding EPA emission standards for a given family, where applicable. Use good engineering judgment to correlate the specified standards with the EPA standards that apply under this part. You must describe in your application for certification how you will perform testing to demonstrate compliance with OBD requirements to represent all your engine families over five or fewer model years.

(3) Engines must comply with OBD requirements throughout the useful life as specified in § 1036.104.

(4) The purpose and applicability statements in 13 CCR 1971.1(a) and (b) do not apply.

(5) Compression-ignition engines are subject to a NO<sub>x</sub> threshold of 0.40 g/hp-hr and a PM threshold of 0.03 g/hp-hr for operation on the FTP and SET duty cycles. Spark-ignition engines are subject to the following thresholds:

(i) 0.015 g/hp-hr for PM emissions.

(ii) 0.30 g/hp-hr for monitors detecting a malfunction before NO<sub>x</sub> emissions exceed 1.5 times the applicable standard.

(iii) 0.35 g/hp-hr for monitors detecting a malfunction before NO<sub>x</sub> emissions exceed 1.75 times the applicable standard.

(iv) 0.60 g/hp-hr for monitors detecting a malfunction before NO<sub>x</sub> emissions exceed 3.0 times the applicable standard.

(6) The testing and reporting requirements in 13 CCR 1971.1(i)(2.3) and (2.4) do not apply.

(7) The deficiency provisions described in paragraph (d) of this section apply instead of 13 CCR 1971.1(k).

(8) Capture the following elements as freeze frame data:

(i) Data parameters specified in 13 CCR 1971.1(h)(4.2) and (4.3).

(ii) System health monitor parameters specified in paragraph (c)(3) of this section.

(9) Design compression-ignition engines to make the following parameters available for reading with a generic scan tool, if so equipped:

(i) *Engine and vehicle parameters.* Status of parking brake, neutral switch, brake switch, and clutch switch, wastegate control solenoid output, wastegate position (commanded and actual), speed and output shaft torque consistent with § 1036.115(d).

(ii) *Diesel oxidation catalyst parameters.* Include inlet and outlet pressure and temperature for the diesel oxidation catalyst.

(iii) *Particulate filter parameters.* Include filter soot load and ash load for all installed particulate filters.

(iv) *EGR parameters.* Include differential pressure for exhaust gas recirculation.

(v) *SCR parameters.* Include DEF quality-related signals, output of aftertreatment doser system (pump and injectors), DEF coolant control valve position (commanded and actual), DEF tank temperature, DEF system pressure, DEF pump commanded percentage, DEF doser control status, DEF line heater control outputs.

(vi) *Additional parameters.* Include any additional parameters if they are related to engine derating or other inducements under § 1036.111 or § 1036.125.

(10) Design spark-ignition engines to make the following additional

parameters available for reading with a generic scan tool, if applicable:

(i) *Air/fuel enrichment parameters.* Percent of time in enrichment, both for each trip (key-on to key-off) and as a cumulative lifetime value. Track values separately for enrichment based on throttle, engine protection, and catalyst protection.

(ii) *Component temperature parameters.* Include component temperatures (measured and modeled, if applicable) used for catalyst protection.

(11) If you have an approved Executive order from the California Air Resources Board for a given engine family, we may rely on that Executive order to evaluate whether you meet federal OBD requirements for that same engine family or an equivalent engine family. Engine families are equivalent if they are identical in all aspects material to emission characteristics. EPA would count two equivalent engines families as one for the purposes of determining OBD demonstration testing requirements. Send us the following information:

(i) You must submit additional information as needed to demonstrate that you meet the requirements of this section that are not covered by the California Executive order.

(ii) Send us results from any testing you performed for certifying engine families (including equivalent engine families) with the California Air Resources Board, including the results of any testing performed under 13 CCR 1971.1(i)(2.3) and (2.4), 13 CCR 1971.1(l), and 13 CCR 1971.5(b).

(iii) We may require that you send us additional information if we need it to evaluate whether you meet the requirements of this section. This may involve sending us copies of documents you send to the California Air Resources Board.

(c) The following additional provisions apply:

(1) Design the diagnostic system to display the following information in the cab:

(i) The health monitoring information specified in paragraph (c)(3) of this section.

(ii) The information related to inducements as specified in § 1036.111(f).

(2) Diagnostic testing to measure the effectiveness of DEF dosing must be made available for use with either a generic scan tool or an equivalent alternative method (such as an option commanded through a vehicle system menu).

(3) The following provisions related to system health monitors apply:

(i) Provide the following information related to particulate filters:

(A) An indicator of general system wear, such as the total number of regeneration events that have taken place since installing the current particulate filter.

(B) Indicator of historical and current active and passive regeneration frequency.

(C) The estimated mileage until the particulate filter needs cleaning to remove accumulated ash.

(D) Information describing any disabled regeneration if this is accompanied by engine derating. Also include the reason for disabling.

(ii) Provide the following information related to SCR:

(A) An indicator of historical and current DEF consumption.

(B) Information describing any disabled DEF dosing if this is accompanied by engine derating. Also include the reason for disabling.

(C) Information describing any detected flow obstruction in DEF lines or dosing valve in anticipation of triggering an inducement under § 1036.111(b)(2).

(iii) Provide an indication of EGR valve health, such as by comparing commanded and actual EGR position.

(iv) Provide an indicator of EGR cooler performance, such as by displaying parameters described in 13 CCR 1971.1(e)(3.2.5).

(v) Provide current data under paragraphs (c)(3)(i) and (ii) of this section based on a default method of updating or resetting collected data. For example, the current data may include information from the Active 100-Hour Array or Stored 100-Hour Array. The system must allow the operator to perform a manual reset to start collecting new data on demand.

(d) You may ask us to accept as compliant an engine that does not fully meet specific requirements under this section. The following provisions apply regarding OBD system deficiencies:

(1) We will not approve a deficiency for gasoline-fueled or diesel-fueled engines if it involves the complete lack of a major diagnostic monitor, such as monitors related to exhaust aftertreatment devices, oxygen sensors, air-fuel ratio sensors, NO<sub>x</sub> sensors, engine misfire, evaporative leaks, and diesel EGR (if applicable). We may approve such deficiencies for engines using other fuels if you demonstrate that the alternative fuel causes these monitors to be unreliable.

(2) We will approve a deficiency only if you show us that full compliance is infeasible or unreasonable considering any relevant factors, such as the

technical feasibility of a given monitor, or the lead time and production cycles of vehicle designs and programmed computing upgrades.

(3) Our approval for a given deficiency applies only for a single model year, though you may continue to ask us to extend a deficiency approval in renewable one-year increments. We may approve an extension if you demonstrate an acceptable level of progress toward compliance and you show that the necessary hardware or software modifications would pose an unreasonable burden. We will approve a deficiency for more than two years only if you further demonstrate that you need the additional lead time to make substantial changes to engine hardware.

(4) We will not approve deficiencies retroactively.

#### § 1036.111 Inducements related to SCR.

Engines using SCR to control emissions depend on a constant supply of diesel exhaust fluid (DEF). This section describes how manufacturers must design their engines to derate power output to induce operators to take appropriate actions to ensure the SCR system is working properly. The requirements of this section apply starting in model year 2027, though you may comply with the requirements of this section in earlier model years.

(a) *General provisions.* The following terms and general provisions apply under this section:

(1) As described in § 1036.110, this section relies on terms and requirements specified for OBD systems by California ARB in 13 CCR 1971.1 (incorporated by reference in § 1036.810).

(2) The provisions of this section apply differently for low-speed vehicles. A low-speed vehicle is one whose OBD system has recorded an average speed below 20 miles per hour for the preceding 30 hours of non-idle engine operation. Non-idle engine operation includes all operating conditions except those that qualify as idle based on OBD system controls as specified in 13 CCR 1971.1(h)(5.4.10).

(3) An inducement drive cycle consists of four hours of continuous engine operation, without regard to engine starting.

(b) *Fault conditions.* Create derate strategies that monitor for and trigger an inducement based on the following conditions:

(1) DEF supply falling to a level corresponding to three hours of engine operation, based on available information on DEF consumption rates.

(2) Blocked DEF lines or dosing valves.

(3) DEF quality failing to meet your concentration specifications.

(4) Open circuit faults related to the following: DEF tank level sensor, DEF pump, DEF quality sensor, SCR wiring harness, NO<sub>x</sub> sensors, DEF dosing valve, DEF tank heater and aftertreatment control module.

(5) Monitor for a missing catalyst.

(c) *NO<sub>x</sub> override*. Reset the Active 100 Hour Array in the OBD system when the engine detects a fault condition

identified in paragraph (b) of this section (but do not reset the Active 100 Hour Array if an additional fault occurs before the fault condition is resolved). Use NO<sub>x</sub> sensor data to override engine derates as described in this paragraph (c) after the engine detects the fault condition. Override the onset of derating associated with a fault condition if the NO<sub>x</sub> conversion efficiency in the Active 100 Hour Array

is within 10 percent of the NO<sub>x</sub> conversion efficiency stored in the lifetime array for OBD REAL Bin 13 and 14. The Active 100 Hour Array and the Lifetime Array are referenced in 13 CCA 1971.1(h)(5.3.2)(A) and (C), respectively. Calculate the NO<sub>x</sub> conversion efficiency relative to the lifetime value using the following equation and override inducements if the calculated override factor is at or below 0.10:

$$\text{Override factor} = \frac{\eta_{\text{Life}} - \eta_{100}}{\eta_{\text{Life}}}$$

Where:

$\eta$  = NO<sub>x</sub> conversion efficiency =  $\frac{m_{\text{in}} - m_{\text{out}}}{m_{\text{in}}}$ . Use appropriate values from OBD REAL Bin 13

and 14 from the Lifetime Array for  $\eta_{\text{Life}}$  and from the Active 100 Hour Array for  $\eta_{100}$ .

$m_{\text{in}}$  = NO<sub>x</sub> mass entering the catalyst. Use “NO<sub>x</sub> mass – engine out” from 13 CCA 1971.1(h)(5.3.1)(A).

$m_{\text{out}}$  = NO<sub>x</sub> mass exiting catalyst. Use “NO<sub>x</sub> mass – tailpipe” from 13 CCA 1971.1(h)(5.3.1)(B).

(d) *Derate schedule*. Engines must follow the derate schedule described in this paragraph (d) if the engine detects a fault condition identified in paragraphs (b) and (c) of this section. The derate takes the form of a maximum drive speed for the vehicle. This maximum drive speed decreases over time based on hours of engine operation without regard to engine starting or mode of operation. Apply speed-limiting derates according to the following schedule:

TABLE 1 TO PARAGRAPH (d) OF § 1036.111—DERATE SCHEDULE FOR DETECTED FAULTS

Non-idle hours of engine operation <sup>a</sup>	Default maximum speed (mi/hr)	Maximum speed for low-speed vehicles (mi/hr)
0 .....	65	50
6 .....	60	45
12 .....	55	40
60 .....	50	35

<sup>a</sup>Hours start counting when the engine detects a fault condition specified in paragraph (b) of this section and the override factor for NO<sub>x</sub> conversion efficiency is above 0.10. For DEF supply, you may program the engine to reset the timer to three hours when the engine detects an empty DEF tank.

(e) *Multiple and continuing faults*. The following provisions apply if the engine detects fault conditions after starting with the derate schedule specified in paragraph (d) of this section:

(1) The determination to qualify a low-speed vehicle in paragraph (a)(2) of this section applies at the point that the engine first detects a fault condition and continues to apply until the fault condition is fully resolved, as specified in paragraph (g) of this section.

(2) Apply the provisions of this section independently for each fault, except as specified in this section.

(f) *In-cab display*. The in-cab display required in § 1036.110(c)(1) must indicate the condition that triggered the pending or active derate. The display must indicate “inducement pending” as long as the system is evaluating NO<sub>x</sub> conversion efficiency without finding that the override factor is above 0.10. Once calculated NO<sub>x</sub> conversion efficiency confirms the fault condition, the display must identify the current stage of derating and show a countdown timer to estimate the time or distance remaining before the next stage.

(g) *Deactivating derates*. Once the override factor for NO<sub>x</sub> conversion efficiency confirms a detected fault condition, do not use it alone to deactivate derates. Rather, program the engine to deactivate derates as follows:

(1) Evaluate whether the detected fault condition continues to apply and reset the Active 100 Hour Array in the OBD system when the fault condition no longer exists. Deactivate derates if the engine confirms that the fault condition is resolved and the override factor for NO<sub>x</sub> conversion efficiency is at or below 0.10 for a full inducement drive schedule.

(2) Allow a generic scan tool to tentatively deactivate inducement-related fault codes while the vehicle is not in motion. Reactivate the derate at the same point in the derate schedule if the engine detects the same fault condition during a full inducement drive schedule.

(3) Treat any fault condition that recurs within 80 hours of engine operation as the same triggering condition, which would restart the derate at the same point that the system last deactivated the derate.

**§ 1036.115 Other requirements.**

Engines that are required to meet the emission standards of this part must meet the following requirements, except as noted elsewhere in this part:

(a) *Crankcase emissions*. Crankcase emissions may not be discharged directly into the ambient atmosphere from any engine throughout its useful life. For purposes of this paragraph (a), crankcase emissions that are routed to the exhaust upstream of exhaust aftertreatment during all operation are not considered to be discharged directly into the ambient atmosphere.

(b) *Fuel mapping*. You must perform fuel mapping for your engine as described in § 1036.510(b).

(c) *Evaporative emissions*. You must design and produce your engines to comply with evaporative emission standards as follows:

(1) For complete heavy-duty vehicles you produce, you must certify the vehicles to emission standards as specified in 40 CFR 1037.103.

(2) For incomplete heavy-duty vehicles, and for engines used in vehicles you do not produce, you do not need to certify your engines to evaporative emission standards or otherwise meet those standards. However, vehicle manufacturers certifying their vehicles with your engines may depend on you to produce your engines according to their specifications. Also, your engines must meet applicable exhaust emission standards in the installed configuration.

(d) *Torque broadcasting.*

Electronically controlled engines must broadcast their speed and output shaft torque (in newton-meters). Engines may alternatively broadcast a surrogate value for determining torque. Engines must broadcast engine parameters such that they can be read with a remote device or broadcast them directly to their controller area networks. This information is necessary for testing engines in the field (see § 1036.515).

(e) *EPA access to broadcast information.* If we request it, you must provide us any hardware, tools, and information we would need to readily read, interpret, and record all information broadcast by an engine's on-board computers and electronic control modules. If you broadcast a surrogate parameter for torque values, you must provide us what we need to convert these into torque units. We will not ask for hardware or tools if they are readily available commercially.

(f) *Adjustable parameters.* Engines that have adjustable parameters must meet all the requirements of this part for any adjustment in the physically adjustable range.

(1) We may require that you set adjustable parameters to any specification within the adjustable range during any testing, including certification testing, selective enforcement auditing, or in-use testing.

(2) General provisions apply for adjustable parameters as specified in 40 CFR 1068.50.

(3) DEF supply and DEF quality are adjustable parameters. The physically adjustable range includes any amount or quality of DEF that the engine's diagnostic system does not trigger inducement provisions under § 1036.111.

(g) *Prohibited controls.* (1) General provisions. You may not design your engines with emission control devices, systems, or elements of design that cause or contribute to an unreasonable risk to public health, welfare, or safety while operating. For example, this would apply if the engine emits a noxious or toxic substance it would

otherwise not emit that contributes to such an unreasonable risk.

(2) *Vanadium sublimation in SCR catalysts.* For engines equipped with vanadium-based SCR catalysts, you must design the engine and its emission controls to prevent vanadium sublimation and protect the catalyst from high temperatures. We will evaluate your engine design based on the following information that you must include in your application for certification:

(i) Identify the threshold temperature for vanadium sublimation for your specified SCR catalyst formulation as described in 40 CFR 1065.1113 through 1065.1121.

(ii) Describe how you designed your engine to prevent catalyst inlet temperatures from exceeding the temperature you identify in paragraph (g)(2)(i) of this section, including consideration of engine wear through the useful life. Also describe your design for catalyst protection in case catalyst temperatures exceed the specified temperature. In your description, include how you considered elevated catalyst temperature resulting from sustained high-load engine operation, catalyst exotherms, particulate filter regeneration, and component failure resulting in unburned fuel in the exhaust stream.

(h) *Defeat devices.* You may not equip your engines with a defeat device. A defeat device is an auxiliary emission control device (AEC) that reduces the effectiveness of emission controls under conditions that may reasonably be expected in normal operation and use. This does not apply to auxiliary emission control devices you identify in your application for certification if any of the following is true:

(1) The conditions of concern were substantially included in the applicable procedure for duty-cycle testing as described in subpart F of this part.

(2) You show your design is necessary to prevent engine (or vehicle) damage or accidents.

(3) The reduced effectiveness applies only to starting the engine.

(4) The AEC) applies only for engines that will be installed in emergency vehicles, and the need is justified in terms of preventing the engine from losing speed, torque, or power due abnormal conditions of the emission control system, or in terms of preventing such abnormal conditions from occurring, during operation related to emergency response. Examples of such abnormal conditions may include excessive exhaust backpressure from an overloaded particulate trap, and running

out of diesel exhaust fluid for engines that rely on urea-based selective catalytic reduction.

(i) *DEF tanks.* Diesel exhaust fluid tanks must be sized to require refilling no more frequently than the vehicle operator will need to refill the fuel tank, even for worst-case assumptions related to fuel efficiency and refueling volumes.

(j) *Special provisions for spark-ignition engines.* The following provisions apply for spark-ignition engines starting with model year 2027:

(1) Catalyst bed temperature may not fall below 350 °C during extended idle. Describe how you designed your engine to meet this requirement in your application for certification. You may ask us to approve alternative strategies to prevent emissions from increasing during idle.

(2) You may use modeled exhaust component temperatures to protect the catalyst instead of designing the engine to continuously monitor exhaust component temperatures as described in this paragraph (j)(2). Measure and record component temperatures during engine mapping and during emission measurements with each required duty cycle. You may use modeled exhaust temperatures under this paragraph (j)(2) only if all modeled and actual temperatures differ by 5 °C or less. Submit a second-by-second comparison of the modeled and actual component temperatures as part of your application for certification.

**§ 1036.120 Emission-related warranty requirements.**

(a) General requirements. You must warrant to the ultimate purchaser and each subsequent purchaser that the new engine, including all parts of its emission control system, meets two conditions:

(1) It is designed, built, and equipped so it conforms at the time of sale to the ultimate purchaser with the requirements of this part.

(2) It is free from defects in materials and workmanship that may keep it from meeting these requirements.

(b) *Warranty period.* Your emission-related warranty must be valid for at least as long as the minimum warranty periods listed in this paragraph (b) in vehicle miles, or hours of engine operation, or years in service, whichever comes first. You may offer an emission-related warranty more generous than we require. The emission-related warranty for the engine may not be shorter than any published warranty you offer with or without charge for the engine. Similarly, the emission-related warranty for any component may not be shorter than any published warranty you offer

without charge for that component. If an extended warranty requires owners to pay for a portion of repairs, those terms

apply in the same manner to the emission-related warranty. The warranty period begins when the

vehicle is placed into service. The following minimum warranty periods apply:

TABLE 1 TO PARAGRAPH (b) OF § 1036.120—WARRANTY BY PRIMARY INTENDED SERVICE CLASS <sup>a</sup>

Primary intended service class	Model year 2026 and earlier	Model year 2027 through 2030		Model year 2031 and later	
	Mileage	Mileage	Hours	Mileage	Hours
Spark-Ignition HDE .....	50,000	110,000	6,000	160,000	8,000
Light HDE .....	50,000	150,000	7,000	210,000	10,000
Medium HDE .....	100,000	220,000	11,000	280,000	14,000
Heavy HDE .....	100,000	450,000	22,000	600,000	30,000

<sup>a</sup> Warranty period is also expressed as 5 years for model years 2026 and earlier, 7 years for model years 2027 through 2030, and 10 years for model years 2031 and later.

(c) *Components covered.* The emission-related warranty covers all components whose failure would increase an engine’s emissions of any regulated pollutant, including components listed in 40 CFR part 1068, appendix A, and components from any other system you develop to control emissions. The emission-related warranty covers these components even if another company produces the component.

(d) *Limited applicability.* You may deny warranty claims under this section if the operator caused the problem through improper maintenance or use, subject to the provisions in § 1036.125 and 40 CFR 1068.115.

(e) *Owners manual.* Describe in the owners manual the emission-related warranty provisions from this section that apply to the engine.

**§ 1036.125 Maintenance instructions and allowable maintenance.**

Maintenance includes any inspection, adjustment, cleaning, repair, or replacement of components and is classified as either emission-related or nonemission-related and each of these can be classified as either scheduled or unscheduled. Further, some emission-related maintenance is also classified as critical emission-related maintenance. Give the ultimate purchaser of each new engine written instructions for maintaining and using the engine. As described in paragraph (h) of this section, these instructions must identify how owners properly maintain and use engines for applying regulatory requirements such as emission-related warranty and defect reporting.

(a) *Critical emission-related maintenance.* Critical emission-related maintenance includes any adjustment, cleaning, repair, or replacement of components listed in paragraph (a)(2) of this section. This may also include other maintenance that you determine is critical, including maintenance on other critical emission-related components as defined in 40 CFR part 1068, if we approve it in advance. You may perform scheduled critical emission-related maintenance during service accumulation on your emission-data engines at the intervals you specify.

(1) *Maintenance demonstration.* You must demonstrate that the maintenance is reasonably likely to be done at the recommended intervals on in-use engines. We will accept DEF replenishment and other SCR-related maintenance as reasonably likely to occur if your engine meets the specifications in § 1036.111. We will accept other scheduled maintenance as reasonably likely to occur if you satisfy any of the following conditions:

(i) You present data showing that, if a lack of maintenance increases emissions, it also unacceptably degrades the engine’s performance.

(ii) You design and produce your engines with a system we approve that displays a visible signal to alert drivers that maintenance is due, either as a result of component failure or the appropriate degree of engine or vehicle operation. The signal must clearly display “maintenance needed”, “check engine”, or a similar message that we approve. The signal must be continuous while the engine is operating and not be easily eliminated without performing

the specified maintenance. Your maintenance instructions must specify resetting the signal after completing the specified maintenance. We must approve the method for resetting the signal. You may not design the system to be less effective at the end of the useful life or after any other degree of operation. If others install your engine in their vehicle, you may rely on installation instructions to ensure proper mounting and operation of the display. Disabling or improperly resetting the system for displaying these maintenance-related signals without performing the indicated maintenance violates the tampering prohibition in 42 U.S.C. 7522(a)(3).

(iii) You present survey data showing that at least 80 percent of engines in the field get the maintenance you specify at the recommended intervals.

(iv) You provide the maintenance free of charge and clearly say so in your maintenance instructions.

(v) You otherwise show us that the maintenance is reasonably likely to be done at the recommended intervals.

(2) *Minimum scheduled maintenance intervals.* You may not schedule replacement of catalyst beds or particulate filters during an engine’s useful life. You may not schedule other critical emission-related maintenance more frequently than the minimum intervals specified in Table 1 and Table 2 of this section or otherwise allowed in this paragraph (a). The minimum intervals specified for each component applies to actuators, sensors, tubing, valves, and wiring associated with that component, except as specified.



TABLE 1 TO PARAGRAPH (a)(2) OF § 1036.125—MINIMUM SCHEDULED MAINTENANCE INTERVALS FOR REPLACEMENT

Component	Accumulated miles (hours) for components			
	Spark-Ignition HDE	Light HDE	Medium HDE	Heavy HDE
Spark plugs .....	25,000 (750)	NA	NA	NA
DEF filters .....	NA	100,000 (3,000)	120,000 (3,600)	175,000 (5,250)
Crankcase ventilation valves and filters .....	60,000 (1,800)	60,000 (1,800)	60,000 (1,800)	60,000 (1,800)
Ignition wires .....	100,000 (3,000)	NA	NA	NA
Oxygen sensors .....	80,000 (2,400)	NA	NA	NA
Air injection system components .....	110,000 (3,300)	NA	NA	NA
Particulate filtration system (other than filters) .....	100,000 (3,000)	100,000 (3,000)	250,000 (7,500)	250,000 (7,500)
Catalyst systems (other than catalyst beds) .....				
Fuel injectors .....				
Electronic control modules .....				
Evaporative emission canisters .....				
Turbochargers .....				
EGR system components (including filters and coolers) .....	110,000 (3,300)	110,000 (3,300)	185,000 (5,550)	435,000 (13,050)

TABLE 2 TO PARAGRAPH (a)(2) OF § 1036.125—MINIMUM SCHEDULED MAINTENANCE INTERVALS FOR ADJUSTMENT OR CLEANING

Component	Accumulated miles (hours) for components			
	Spark-Ignition HDE	Light HDE	Medium HDE	Heavy HDE
Spark plugs .....	25,000 (750)	NA	NA	NA
EGR-related filters and coolers .....				
Fuel injectors .....				
Crankcase ventilation valves and filters .....	50,000 (1,500)	50,000 (1,500)	50,000 (1,500)	50,000 (1,500)
DEF filters .....	NA	50,000 (1,500)	50,000 (1,500)	50,000 (1,500)
Ignition wires .....				
Idle mixture .....	50,000 (1,500)	NA	NA	NA
Oxygen sensors .....	80,000 (2,400)	NA	NA	NA
Air injection system components .....	100,000 (3,000)	NA	NA	NA
Catalyst system components .....				
EGR system components (other than filters or coolers) .....				
Particulate filtration system components .....				
Turbochargers .....	100,000 (3,000)	100,000 (3,000)	150,000 (4,500)	150,000 (4,500)

(3) *New technology.* You may ask us to approve scheduled critical emission-related maintenance of components not identified in paragraph (a)(2) of this section that is a direct result of the implementation of new technology not used in model year 2020 or earlier engines, subject to the following provisions:

(i) Your request must include your recommended maintenance interval, including data to support the need for the maintenance, and a demonstration that the maintenance is likely to occur at the recommended interval using one of the conditions specified in paragraph (a)(1) of this section.

(ii) For any such new technology, we will publish a **Federal Register** notice based on information you submit and any other available information to announce that we have established new allowable minimum maintenance intervals. Any manufacturer objecting to our decision may ask for a hearing (see § 1036.820).

(b) *Recommended additional maintenance.* You may recommend any amount of maintenance that is additional to what we approve for critical emission-related components in paragraph (a) of this section for those components, as long as you state clearly that the recommended additional maintenance steps are not necessary to keep the emission-related warranty valid. If operators do the maintenance specified in paragraph (a) of this section, but not the recommended additional maintenance, this does not allow you to disqualify those engines from in-use testing or deny a warranty claim. Do not take these maintenance steps during service accumulation on your emission-data engines.

(c) *Special maintenance.* You may specify more frequent maintenance to address problems related to special situations, such as atypical engine operation. You must clearly state that this special maintenance is associated with the special situation you are addressing. We may disapprove your

maintenance instructions if we determine that you have specified special maintenance steps to address engine operation that is not atypical, or that the maintenance is unlikely to occur in use. If we determine that certain maintenance items do not qualify as special maintenance under this paragraph (c), you may identify them as recommended additional maintenance under paragraph (b) of this section.

(d) *Noncritical emission-related maintenance.* You may specify any amount of emission-related inspection or other maintenance that is not approved critical emission-related maintenance under paragraph (a) of this section, subject to the provisions of this paragraph (d). Noncritical emission-related maintenance generally includes maintenance on the components we specify in 40 CFR part 1068, appendix A, that is not covered in paragraph (a) of this section. You must state in the owners manual that these steps are not necessary to keep the emission-related

warranty valid. If operators fail to do this maintenance, this does not allow you to disqualify those engines from in-use testing or deny a warranty claim. Do not take these inspection or other maintenance steps during service accumulation on your emission-data engines.

(e) *Nonemission-related maintenance.* You may schedule any amount of maintenance unrelated to emission controls that is needed for proper functioning of the engine. This might include adding engine oil; changing air, fuel, or oil filters; servicing engine-cooling systems; adjusting idle speed, governor, engine bolt torque, valve lash, injector lash, timing, or tension of air pump drive belts; and lubricating the heat control valve in the exhaust manifold. You may perform nonemission-related maintenance during service accumulation on your emission-data engines at the least frequent intervals that you recommend to the ultimate purchaser (but not the intervals recommended for special situations).

(f) *Source of parts and repairs.* State clearly on the first page of your written maintenance instructions that a repair shop or person of the owner's choosing may maintain, replace, or repair emission control devices and systems. Your instructions may not require components or service identified by brand, trade, or corporate name. Also, do not directly or indirectly condition your warranty on a requirement that the engine be serviced by your franchised dealers or any other service establishments with which you have a commercial relationship. You may disregard the requirements in this paragraph (f) if you do one of two things:

(1) Provide a component or service without charge under the purchase agreement.

(2) Get us to waive this prohibition in the public's interest by convincing us the engine will work properly only with the identified component or service.

(g) *Payment for scheduled maintenance.* Owners are responsible for properly maintaining their engines, which generally includes paying for scheduled maintenance. However, you may commit to paying for scheduled maintenance as described in paragraph (a)(1)(iv) of this section to demonstrate that the maintenance will occur. You may also schedule maintenance not otherwise allowed by paragraph (a)(2) of this section if you pay for it. You must pay for scheduled maintenance on any component during the useful life if it meets all the following conditions:

(1) Each affected component was not in general use on similar engines before 1980.

(2) The primary function of each affected component is to reduce emissions.

(3) The cost of the scheduled maintenance is more than 2 percent of the price of the engine.

(4) Failure to perform the maintenance would not cause clear problems that would significantly degrade the engine's performance.

(h) *Owners manual.* Include the following information in the owners manual to clarify maintenance instructions and the owner's responsibilities:

(1) Clearly describe the scheduled maintenance steps, consistent with the provisions of this section, using nontechnical language as much as possible. Include a list of components for which you will cover scheduled replacement costs.

(2) Identify steps owners must take to qualify their engines as properly maintained, consistent with the requirements of this section. Also identify types of engine operation that would not qualify their engines as being properly used. Describe what documentation you consider appropriate for making these demonstrations. Note that you may identify failure to repair critical emission-related components as improper maintenance if the repairs are related to an observed defect.

(3) Describe how the owner can access the OBD system to troubleshoot problems and find emission-related diagnostic information and codes stored in onboard monitoring systems as described in § 1036.110(b) and (c). For example, the instructions should identify the communication protocol and any other information the owner would need to read and understand stored codes.

(4) Include a general description of how the emission control systems operate.

(5) Include one or more diagrams of the engine and its emission-related components with the following information:

(i) The flow path for intake air and exhaust gas.

(ii) The flow path of evaporative and refueling emissions for spark-ignition engines, and DEF for compression-ignition engines, as applicable.

(iii) The flow path of engine coolant if it is part of the emission control system described in the application for certification.

(iv) The identity, location, and arrangement of relevant sensors, wiring,

and other emission-related components in the diagram. Terminology to identify components must be consistent with codes you use for the OBD system.

(v) Expected pressures at the particulate filter and exhaust temperatures throughout the aftertreatment system.

(6) Include exploded-view drawings to allow the owner to identify the part numbers and basic assembly requirements for turbochargers, aftercoolers, and all components required for proper functioning of EGR and aftertreatment devices. Include enough detail to allow a mechanic to replace any of those components.

(7) Include basic wiring diagrams for aftertreatment-related components. Include enough detail to allow a mechanic to detect improper functioning of those components.

(8) Include the following statement: "Technical service bulletins and other information for your engine may be available at [www.nhtsa.gov/recalls](http://www.nhtsa.gov/recalls)."

(9) Include a troubleshooting guide to address warning signals related to DEF dosing and particulate filter regeneration that would be displayed in the cab or in a generic scan tool. The troubleshooting guide must describe the fault condition, the potential causes, the remedy, and the consequence of continuing to operate without remedy, this would include a list of all codes that cause derate or inducement (e.g., list SPN/FMI combinations) and associated operating restrictions (e.g., percent torque derate).

(10) Note that § 1036.135(c)(10) requires the owners manual for an engine to be accessible electronically from a QR Code on the emission control information label.

(11) Include the following information for engines with particulate filters:

(i) Instructions on removing the particulate filter for cleaning.

(ii) Criteria for establishing that a particulate filter has been cleaned, including maximum clean filter weight and pressure drop across the filter. We recommend that you also specify a pre-installation filter weight to represent a like-new configuration.

(iii) A statement that particulate filter inlet and outlet pressures are available with a generic scan tool.

(iv) Suggested maintenance practices to prevent damage to particulate filters.

#### **§ 1036.130 Installation instructions for vehicle manufacturers.**

(a) If you sell an engine for someone else to install in a vehicle, give the engine installer instructions for installing it consistent with the requirements of this part. Include all

information necessary to ensure that an engine will be installed in its certified configuration.

(b) Make sure these instructions have the following information:

(1) Include the heading: "Emission-related installation instructions".

(2) State: "Failing to follow these instructions when installing a certified engine in a heavy-duty motor vehicle violates federal law, subject to fines or other penalties as described in the Clean Air Act."

(3) Provide all instructions needed to properly install the exhaust system and any other components.

(4) Describe any necessary steps for installing any diagnostic system required under § 1036.110.

(5) Describe how your certification is limited for any type of application. For example, if you certify Heavy HDE to the CO<sub>2</sub> standards using only transient FTP testing, you must make clear that the engine may not be installed in tractors.

(6) Describe any other instructions to make sure the installed engine will operate according to design specifications in your application for certification. This may include, for example, instructions for installing aftertreatment devices when installing the engines.

(7) Give the following instructions if you do not ship diesel exhaust fluid tanks with your engines:

(i) Specify that vehicle manufacturers must install diesel exhaust fluid tanks meeting the specifications of § 1036.115(i).

(ii) Describe how vehicle manufacturers must install diesel exhaust fluid tanks with sensors as needed to meet the requirements of §§ 1036.110 and 1036.111.

(8) State: "If you install the engine in a way that makes the engine's emission control information label hard to read during normal engine maintenance, you must place a duplicate label on the vehicle, as described in 40 CFR 1068.105."

(c) Give the vehicle manufacturer fuel map results as described in § 1036.503(b).

(d) You do not need installation instructions for engines that you install in your own vehicles.

(e) Provide instructions in writing or in an equivalent format. For example, you may post instructions on a publicly available website for downloading or printing. If you do not provide the instructions in writing, explain in your application for certification how you will ensure that each installer is informed of the installation requirements.

#### § 1036.135 Labeling.

(a) Assign each engine a unique identification number and permanently affix, engrave, or stamp it on the engine in a legible way.

(b) At the time of manufacture, affix a permanent and legible label identifying each engine. The label must meet the requirements of 40 CFR 1068.45.

(c) The label must—

(1) Include the heading "EMISSION CONTROL INFORMATION".

(2) Include your full corporate name and trademark. You may identify another company and use its trademark instead of yours if you comply with the branding provisions of 40 CFR 1068.45.

(3) Include EPA's standardized designation for the engine family.

(4) Identify the primary intended service class.

(5) State the engine's displacement (in liters); however, you may omit this from the label if all the engines in the engine family have the same per-cylinder displacement and total displacement.

(6) State the date of manufacture [DAY (optional), MONTH, and YEAR]; however, you may omit this from the label if you stamp, engrave, or otherwise permanently identify it elsewhere on the engine, in which case you must also describe in your application for certification where you will identify the date on the engine.

(7) State the FEL(s) to which the engines are certified if certification depends on the ABT provision of subpart H of this part.

(8) State: "THIS ENGINE COMPLIES WITH U.S. EPA REGULATIONS FOR [MODEL YEAR] HEAVY-DUTY HIGHWAY ENGINES."

(9) Identify any limitations on your certification. For example, if you certify Heavy HDE to the CO<sub>2</sub> standards using only steady-state testing, include the statement "TRACTORS ONLY". Similarly, for engines with one or more approved AECDs for emergency vehicle applications under § 1036.115(h)(4), the statement: "THIS ENGINE IS FOR INSTALLATION IN EMERGENCY VEHICLES ONLY".

(10) Include a field on the label to allow for accessing interactive information with mobile electronic devices. To do this, include an image of a QR code that will direct mobile electronic devices to a public Web site that you maintain. Generate the QR code as specified in ISO/IEC 18004 (incorporated by reference in § 1036.810). To the left of the QR code, include the vertically oriented caption "Smartphone QR Code™". The website associated with the QR code for a given engine must include a link to a

public copy of the owners manual and the following information for that engine:

(i) Include EPA's standardized designation for the engine family. This may include multiple engine families in a given model year and it may include multiple model years for those families as long as the appropriate information is available for each engine.

(ii) Identify the emission control system. Use terms and abbreviations as described in 40 CFR 1068.45.

(iii) Identify any requirements for fuel and lubricants that do not involve fuel-sulfur levels.

(d) You may add information to the emission control information label as follows:

(1) You may identify other emission standards that the engine meets or does not meet. You may add the information about the other emission standards to the statement we specify, or you may include it in a separate statement.

(2) You may add other information to ensure that the engine will be properly maintained and used.

(3) You may add appropriate features to prevent counterfeit labels. For example, you may include the engine's unique identification number on the label.

(e) You may ask us to approve modified labeling requirements in this part if you show that it is necessary or appropriate. We will approve your request if your alternate label is consistent with the requirements of this part. We may also specify modified labeling requirements to be consistent with the intent of 40 CFR part 1037.

(f) If you obscure the engine label while installing the engine in the vehicle such that the label cannot be read during normal maintenance, you must place a duplicate label on the vehicle. If others install your engine in their vehicles in a way that obscures the engine label, we require them to add a duplicate label on the vehicle (see 40 CFR 1068.105); in that case, give them the number of duplicate labels they request and keep the following records for at least five years:

(1) Written documentation of the request from the vehicle manufacturer.

(2) The number of duplicate labels you send for each engine family and the date you sent them.

#### § 1036.140 Primary intended service class and engine cycle.

You must identify a single primary intended service class for each engine family that best describes vehicles for which you design and market the engine, as follows:

(a) Divide compression-ignition engines into primary intended service

classes based on the following engine and vehicle characteristics:

(1) Light HDE includes engines that are not designed for rebuild and do not have cylinder liners. Vehicle body types in this group might include any heavy-duty vehicle built from a light-duty truck chassis, van trucks, multi-stop vans, and some straight trucks with a single rear axle. Typical applications would include personal transportation, light-load commercial delivery, passenger service, agriculture, and construction. The GVWR of these vehicles is normally at or below 19,500 pounds.

(2) Medium HDE includes engines that may be designed for rebuild and may have cylinder liners. Vehicle body types in this group would typically include school buses, straight trucks with single rear axles, city tractors, and a variety of special purpose vehicles such as small dump trucks, and refuse trucks. Typical applications would include commercial short haul and intra-city delivery and pickup. Engines in this group are normally used in vehicles whose GVWR ranges from 19,501 to 33,000 pounds.

(3) Heavy HDE includes engines that are designed for multiple rebuilds and have cylinder liners. Vehicles in this group are normally tractors, trucks,

straight trucks with dual rear axles, and buses used in inter-city, long-haul applications. These vehicles normally exceed 33,000 pounds GVWR.

(b) Divide spark-ignition engines into primary intended service classes as follows:

(1) Spark-ignition engines that are best characterized by paragraph (a)(1) or (2) of this section are in a separate Spark-ignition HDE primary intended service class.

(2) Spark-ignition engines that are best characterized by paragraph (a)(3) of this section are included in the Heavy HDE primary intended service class along with compression-ignition engines. Gasoline-fueled engines are presumed not to be characterized by paragraph (a)(3) of this section; for example, vehicle manufacturers may install some number of gasoline-fueled engines in Class 8 trucks without causing the engine manufacturer to consider those to be Heavy HDE.

(c) References to “spark-ignition standards” in this part relate only to the spark-ignition engines identified in paragraph (b)(1) of this section. References to “compression-ignition standards” in this part relate to compression-ignition engines, to spark-ignition engines optionally certified to standards that apply to compression-

ignition engines, and to all engines identified under paragraph (b)(2) of this section as Heavy HDE.

#### § 1036.150 Interim provisions.

The provisions in this section apply instead of other provisions in this part. This section describes when these interim provisions expire, if applicable.

(a) *Transitional and early credits for NO<sub>x</sub> emissions.* You may generate and use transitional and early credits for NO<sub>x</sub> emissions according to § 1036.104(c) and subpart H of this part subject to the following provisions:

(1) *Transitional credits.* Model year 2024 through 2026 engines may generate transitional credits that can be used to certify model year 2027 and later engines as follows:

(i) Calculate transitional credits as described in § 1036.705(b) relative to the NO<sub>x</sub> emission standard for FTP testing in 40 CFR 86.007–11 or 86.008–10 using the useful life mileages of 40 CFR 86.004–2.

(ii) Engines must also comply with NO<sub>x</sub> family emission limits for each duty-cycle standard other than the FTP duty cycle in § 1036.104(a) using the test procedures in subpart F of this part. Calculate these NO<sub>x</sub> family emission limits, FEL<sub>[cycle]NO<sub>x</sub></sub>, using the following equation:

$$FEL_{[cycle]NO_x} = Std_{[cycle]NO_x2027} \cdot \frac{FEL_{FTPNO_x}}{Std_{FTPNO_x2027}}$$

Eq. 1036.150-1

Where:

$Std_{[cycle]NO_x2027}$  = the NO<sub>x</sub> emission standard that applies for the applicable duty cycle under § 1036.104 for model year 2027 engines not participating in the ABT program.

$FEL_{FTPNO_x}$  = the engine family’s declared FEL for NO<sub>x</sub> over the FTP duty cycle from § 1036.104(c)(1).

$Std_{FTPNO_x2027}$  = the NO<sub>x</sub> emission standard that applies for the FTP duty cycle under § 1036.104 for model year 2027 engines not participating in the ABT program.

*Example for LLC:*

$Std_{LLCNO_x2027} = 90 \text{ mg/hp} \cdot \text{hr}$

$FEL_{FTPNO_x} = 100 \text{ mg/hp} \cdot \text{hr}$

$Std_{FTPNO_x2027} = 35 \text{ mg/hp} \cdot \text{hr}$

$FEL_{LLCNO_x} = 90 \cdot \frac{100}{35} = 257 \text{ mg/hp} \cdot \text{hr}$

(iii) The family emission limits in this paragraph (a)(1) serve as the emission standards to determine compliance for all testing instead of the standards

specified in 40 CFR 86.007–11 or 86.008–10.

(iv) Record PM, HC, and CO emission levels during all testing. Demonstrate that you comply with applicable PM,

HC, and CO emission standards in 40 CFR 86.007–11 or 86.008–10.

(2) *Early credits.* Model year 2024 and later engines may generate early credits under this paragraph (a)(2) only if they

comply with all the requirements that apply under this part for the model year to which you are certifying. Calculate early credits as described in

§ 1036.705(b) with the following adjustments and clarifications:  
(i) Calculate early credits for all model year 2030 and earlier engines relative to the NO<sub>x</sub> standard for FTP testing in 40

CFR 86.007–11 or 86.008–10 or § 1036.104 that applies for an engine family's model year.  
(ii) Replace the FL term in Eq. 1036.705–1 with:

$$FL_{\text{earlycredit}} = FEL_{\text{FTP}} \cdot \frac{UL_{\text{MY}}}{UL}$$

Eq. 1036.150-2

Where:

$FEL_{\text{FTP}}$  = the engine family's declared FEL for NO<sub>x</sub> over the FTP duty cycle from § 1036.104(c)(1).

$UL_{\text{MY}}$  = the required useful life, in miles, that applies for that model year.

$UL$  = the useful life, in miles, for the future model year standard that applies for the applicable primary intended service class.

*Example for model year 2026 Heavy HDE generating early credits for a model year 2028 Heavy HDE:*

$FEL_{\text{FTP}} = 35 \text{ mg/hp} \cdot \text{hr}$

$UL_{\text{MY}} = 435,000 \text{ miles}$

$UL = 600,000 \text{ miles}$

$$FL_{\text{earlycredit}} = 131 \cdot \frac{435,000}{600,000} = 95 \text{ mg/hp} \cdot \text{hr}$$

(3) *Limitations on using banked emission credits in model years 2027 and later.* You must use one of the methods described in paragraphs (a)(1) and (2) of this section for using NO<sub>x</sub> emission credits generated by model year 2026 and earlier engines when certifying model year 2027 and later engines. Similarly, you must use the method described in paragraph (a)(2) of this section for using NO<sub>x</sub> emission credits generated by model year 2027 through 2030 engines when certifying model year 2031 and later engines.

(b) *Model year 2014 N<sub>2</sub>O standards.* In model year 2014 and earlier, manufacturers may show compliance with the N<sub>2</sub>O standards using an engineering analysis. This allowance also applies for later families certified using carryover CO<sub>2</sub> data from model 2014 consistent with § 1036.235(d).

(c) *Engine cycle classification.* Through model year 2020, engines meeting the definition of spark-ignition, but regulated as compression-ignition engines under § 1036.140, must be certified to the requirements applicable to compression-ignition engines under this part. Such engines are deemed to be compression-ignition engines for purposes of this part. Similarly, through

model year 2020, engines meeting the definition of compression-ignition, but regulated as Otto-cycle under 40 CFR part 86 must be certified to the requirements applicable to spark-ignition engines under this part. Such engines are deemed to be spark-ignition engines for purposes of this part. See § 1036.140 for provisions that apply for model year 2021 and later.

(d) *Small manufacturers.* The greenhouse gas standards of this part apply on a delayed schedule for manufacturers meeting the small business criteria specified in 13 CFR 121.201. Apply the small business criteria for NAICS code 336310 for engine manufacturers with respect to gasoline-fueled engines and 333618 for engine manufacturers with respect to other engines; the employee limits apply to the total number employees together for affiliated companies. Qualifying small manufacturers are not subject to the greenhouse gas emission standards in § 1036.108 for engines with a date of manufacture on or after November 14, 2011 but before January 1, 2022. In addition, qualifying small manufacturers producing engines that run on any fuel other than gasoline, E85, or diesel fuel may delay complying with

every later standard under this part by one model year. Small manufacturers may certify their engines and generate emission credits under this part before standards start to apply, but only if they certify their entire U.S.-directed production volume within that averaging set for that model year. Note that engines not yet subject to standards must nevertheless supply fuel maps to vehicle manufacturers as described in paragraph (n) of this section. Note also that engines produced by small manufacturers are subject to criteria pollutant standards.

(e) *Alternate phase-in standards for greenhouse gas emissions.* Where a manufacturer certifies all of its model year 2013 compression-ignition engines within a given primary intended service class to the applicable alternate standards of this paragraph (e), its compression-ignition engines within that primary intended service class are subject to the standards of this paragraph (e) for model years 2013 through 2016. This means that once a manufacturer chooses to certify a primary intended service class to the standards of this paragraph (e), it is not allowed to opt out of these standards.

TABLE 1 TO PARAGRAPH (e) OF § 1036.150—ALTERNATE PHASE-IN STANDARDS

Vehicle type	Model years	LHD engines	MHD engines	HHD engines
Tractors .....	2013–2015 .....	NA .....	512 g/hp-hr .....	485 g/hp-hr.
2016 and later a .....	NA .....	487 g/hp-hr .....	460 g/hp-hr.	
Vocational .....	2013–2015 .....	618 g/hp-hr .....	618 g/hp-hr .....	577 g/hp-hr.
	2016 through 2020 <sup>a</sup> .....	576 g/hp-hr .....	576 g/hp-hr .....	555 g/hp-hr.

<sup>a</sup>**Note:** These alternate standards for 2016 and later are the same as the otherwise applicable standards for 2017 through 2020.

(f) [Reserved]

(g) *Default deterioration factors for greenhouse gas standards.* You may use default deterioration factors (DFs) without performing your own durability emission tests or engineering analysis as follows:

(1) You may use a default additive DF of 0.0 g/hp-hr for CO<sub>2</sub> emissions from engines that do not use advanced or off-cycle technologies. If we determine it to be consistent with good engineering judgment, we may allow you to use a

default additive DF of 0.0 g/hp-hr for CO<sub>2</sub> emissions from your engines with advanced or off-cycle technologies.

(2) You may use a default additive DF of 0.010 g/hp-hr for N<sub>2</sub>O emissions from any engine through model year 2021, and 0.020 g/hp-hr for later model years.

(3) You may use a default additive DF of 0.020 g/hp-hr for CH<sub>4</sub> emissions from any engine.

(h) *Advanced-technology credits.* If you generate CO<sub>2</sub> credits from model year 2020 and earlier engines certified

for advanced technology, you may multiply these credits by 1.5.

(i) *CO<sub>2</sub> credits for low N<sub>2</sub>O emissions.*

If you certify your model year 2014, 2015, or 2016 engines to an N<sub>2</sub>O FEL less than 0.04 g/hp-hr (provided you measure N<sub>2</sub>O emissions from your emission-data engines), you may generate additional CO<sub>2</sub> credits under this paragraph (i). Calculate the additional CO<sub>2</sub> credits from the following equation instead of the equation in § 1036.705:

$$\text{CO}_2 \text{ credits (Mg)} = (0.04 - \text{FEL}_{\text{N}_2\text{O}}) \cdot \text{CF} \cdot \text{Volume} \cdot \text{UL} \cdot 10^{-6} \cdot 298$$

Eq. 1036.150-3

(j) *Alternate standards under 40 CFR part 86.* This paragraph (j) describes alternate emission standards for loose engines certified under 40 CFR 86.1819–14(k)(8). The standards of § 1036.108 do not apply for these engines. The standards in this paragraph (j) apply for emissions measured with the engine installed in a complete vehicle consistent with the provisions of 40 CFR 86.1819–14(k)(8)(vi). The only requirements of this part that apply to these engines are those in this paragraph (j), §§ 1036.115 through 1036.135, 1036.535, and 1036.540.

(k) [Reserved]

(l) *Credit adjustment for spark-ignition engines and light heavy-duty compression-ignition engines.* For greenhouse gas emission credits generated from model year 2020 and earlier spark-ignition and light heavy-duty engines, multiply any banked CO<sub>2</sub> credits that you carry forward to demonstrate compliance with model year 2021 and later standards by 1.36.

(m) *Infrequent regeneration.* For model year 2020 and earlier, you may invalidate any test interval with respect to CO<sub>2</sub> measurements if an infrequent regeneration event occurs during the test interval. Note that § 1036.522 specifies how to apply infrequent regeneration adjustment factors for later model years.

(n) *Supplying fuel maps.* Engine manufacturers not yet subject to standards under § 1036.108 in model year 2021 must supply vehicle manufacturers with fuel maps (or powertrain test results) as described in § 1036.130 for those engines.

(o) *Engines used in glider vehicles.* For purposes of recertifying a used engine for installation in a glider vehicle, we may allow you to include in an existing certified engine family those engines you modify (or otherwise demonstrate) to be identical to engines already covered by the certificate. We would base such an approval on our review of any appropriate

documentation. These engines must have emission control information labels that accurately describe their status.

(p) *Transition to Phase 2 CO<sub>2</sub> standards.* If you certify all your model year 2020 engines within an averaging set to the model year 2021 FTP and SET standards and requirements, you may apply the provisions of this paragraph (p) for enhanced generation and use of emission credits. These provisions apply separately for Medium HDE and Heavy HDE.

(1) Greenhouse gas emission credits you generate with model year 2018 through 2024 engines may be used through model year 2030, instead of being limited to a five-year credit life as specified in § 1036.740(d).

(2) You may certify your model year 2024 through 2026 engines to the following alternative standards:

TABLE 2 TO PARAGRAPH (P)(2) OF § 1036.150—ALTERNATIVE STANDARDS FOR MODEL YEARS 2024 THROUGH 2026

Model years	Medium heavy-duty-vocational	Heavy heavy-duty-vocational	Medium heavy-duty-tractor	Heavy heavy-duty-tractor
2024–2026 .....	542	510	467	442

(q) *Confirmatory testing of fuel maps defined in § 1036.503(b).* For model years 2021 and later, where the results

from Eq. 1036.235–1 for a confirmatory test are at or below 2.0%, we will not replace the manufacturer’s fuel maps.

(r) [Reserved]

(s) *Greenhouse gas compliance testing.* Select duty cycles and measure

emissions to demonstrate compliance with greenhouse gas emission standards before model year 2027 as follows:

(1) For model years 2016 through 2020, measure emissions using the FTP duty cycle specified in § 1036.510 and SET duty cycle specified in 40 CFR 86.1362, as applicable.

(2) The following provisions apply for model years 2021 through 2026:

(i) Determine criteria pollutant emissions during any testing used to demonstrate compliance with greenhouse gas emission standards; however, the duty-cycle standards of § 1036.104 apply for measured criteria pollutant emissions only as described in subpart F of this part.

(ii) You may demonstrate compliance with SET-based greenhouse gas emission standards in § 1036.108(a)(1) using the SET duty cycle specified in 40 CFR 86.1362 if you collect emissions with continuous sampling. Integrate the test results by mode to establish separate emission rates for each mode (including the transition following each mode, as applicable). Apply the CO<sub>2</sub> weighting factors specified in 40 CFR 86.1362 to calculate a composite emission result.

(t) [Reserved]

(u) *Crankcase emissions.* Through model year 2026, compression-ignition engines may discharge crankcase emissions to the ambient atmosphere if the emissions are added to the exhaust emissions (either physically or mathematically) during all emission testing. If you take advantage of this exception, you must do the following things:

(1) Manufacture the engines so that all crankcase emissions can be routed into the applicable sampling systems specified in 40 CFR part 1065.

(2) Account for deterioration in crankcase emissions when determining exhaust deterioration factors.

(v) *OBD communication protocol.* For model year 2026 and earlier engines, we may approve the alternative communication protocol specified in SAE J1979-2 (incorporated by reference in § 1036.810) if the protocol is approved by the California Air Resources Board. The alternative protocol would apply instead of SAE J1939 and SAE J1979 as specified in 40 CFR 86.010-18(k)(1).

(w) *Greenhouse gas warranty.* For model year 2027 and later engines, you may ask us to approve the model year 2026 warranty periods specified in § 1036.120 for components or systems needed to comply with greenhouse gas emission standards if those components or systems do not play a role in

complying with criteria pollutant standards.

(x) *Schedule for migrating provisions from 40 CFR part 86.* This part included provisions that applied uniquely for complying with greenhouse gas standards before [the effective date of the final rule]. The following provisions apply through model year 2026:

(1) Subpart F of this part applies except as specified in this section; otherwise, you may continue to comply with the earlier version of the provisions of this part if those provisions are modified to apply for complying with both criteria pollutant standards and greenhouse gas standards.

(2) Engines exempted from the applicable standards of 40 CFR part 86 under the provisions of 40 CFR part 1068 are exempt from the standards of this part without request.

(y) *Powertrain testing for criteria pollutants.* You may apply the powertrain testing provisions of § 1036.101(b) for demonstrating compliance with criteria pollutant emission standards in 40 CFR part 86 before model year 2027.

### Subpart C—Certifying Engine Families

#### § 1036.201 General requirements for obtaining a certificate of conformity.

(a) You must send us a separate application for a certificate of conformity for each engine family. A certificate of conformity is valid from the indicated effective date until December 31 of the model year for which it is issued.

(b) The application must contain all the information required by this part and must not include false or incomplete statements or information (see § 1036.255).

(c) We may ask you to include less information than we specify in this subpart, as long as you maintain all the information required by § 1036.250.

(d) You must use good engineering judgment for all decisions related to your application (see 40 CFR 1068.5).

(e) An authorized representative of your company must approve and sign the application.

(f) See § 1036.255 for provisions describing how we will process your application.

(g) We may require you to deliver your test engines to a facility we designate for our testing (see § 1036.235(c)). Alternatively, you may choose to deliver another engine that is identical in all material respects to the test engine, or another engine that we determine can appropriately serve as an emission-data engine for the engine family.

(h) For engines that become new after being placed into service, such as rebuilt engines installed in new vehicles, we may specify alternate certification provisions consistent with the intent of this part. See 40 CFR 1068.120(h) and the definition of “new motor vehicle engine” in § 1036.801.

#### § 1036.205 Requirements for an application for certification.

This section specifies the information that must be in your application, unless we ask you to include less information under § 1036.201(c). We may require you to provide additional information to evaluate your application.

(a) Identify the engine family’s primary intended service class and describe the engine family’s specifications and other basic parameters of the engine’s design and emission controls with respect to compliance with the requirements of this part. List the fuel type on which your engines are designed to operate (for example, gasoline, diesel fuel, or natural gas). For engines that can operate on multiple fuels, identify whether they are dual-fuel or flexible-fuel engines; also identify the range of mixtures for operation on blended fuels, if applicable. List each distinguishable engine configuration in the engine family. List the rated power for each engine configuration.

(b) Explain how the emission control system operates. Describe in detail all system components for controlling greenhouse gas and criteria pollutant emissions, including all auxiliary emission control devices (AECs) and all fuel-system components you will install on any production or test engine. Identify the part number of each component you describe. For this paragraph (b), treat as separate AECs any devices that modulate or activate differently from each other. Include all the following:

(1) Give a general overview of the engine, the emission control strategies, and all AECs.

(2) Describe each AEC’s general purpose and function.

(3) Identify the parameters that each AEC senses (including measuring, estimating, calculating, or empirically deriving the values). Include engine-based parameters and state whether you simulate them during testing with the applicable procedures.

(4) Describe the purpose for sensing each parameter.

(5) Identify the location of each sensor the AEC uses.

(6) Identify the threshold values for the sensed parameters that activate the AEC.

(7) Describe the parameters that the AECD modulates (controls) in response to any sensed parameters, including the range of modulation for each parameter, the relationship between the sensed parameters and the controlled parameters and how the modulation achieves the AECD's stated purpose. Use graphs and tables, as necessary.

(8) Describe each AECD's specific calibration details. This may be in the form of data tables, graphical representations, or some other description.

(9) Describe the hierarchy among the AECDS when multiple AECDS sense or modulate the same parameter. Describe whether the strategies interact in a comparative or additive manner and identify which AECD takes precedence in responding, if applicable.

(10) Explain the extent to which the AECD is included in the applicable test procedures specified in subpart F of this part.

(11) Do the following additional things for AECDS designed to protect engines or vehicles:

(i) Identify any engine and vehicle design limits that make protection necessary and describe any damage that would occur without the AECD.

(ii) Describe how each sensed parameter relates to the protected components' design limits or those operating conditions that cause the need for protection.

(iii) Describe the relationship between the design limits/parameters being protected and the parameters sensed or calculated as surrogates for those design limits/parameters, if applicable.

(iv) Describe how the modulation by the AECD prevents engines and vehicles from exceeding design limits.

(v) Explain why it is necessary to estimate any parameters instead of measuring them directly and describe how the AECD calculates the estimated value, if applicable.

(vi) Describe how you calibrate the AECD modulation to activate only during conditions related to the stated need to protect components and only as needed to sufficiently protect those components in a way that minimizes the emission impact.

(c) Explain in detail how the engine diagnostic system works, describing especially the engine conditions (with the corresponding diagnostic trouble codes) that cause the malfunction indicator to go on. Propose the conditions under which the diagnostic system should disregard trouble codes as described in § 1036.110.

(d) Describe the engines you selected for testing and the reasons for selecting them.

(e) Describe any test equipment and procedures that you used, including any special or alternate test procedures you used (see § 1036.501).

(f) Describe how you operated the emission-data engine before testing, including the duty cycle and the number of engine operating hours used to stabilize emission levels. Explain why you selected the method of service accumulation. Describe any scheduled maintenance you did.

(g) List the specifications of the test fuel to show that it falls within the required ranges we specify in 40 CFR part 1065.

(h) Identify the engine family's useful life.

(i) Include the maintenance instructions and warranty statement you will give to the ultimate purchaser of each new engine (see §§ 1036.120 and 1036.125).

(j) Include the emission-related installation instructions you will provide if someone else installs your engines in their vehicles (see § 1036.130).

(k) Describe your emission control information label (see § 1036.135). We may require you to include a copy of the label.

(l) Identify the duty-cycle emission standards from §§ 1036.104(a) and (b) and 1036.108(a) that apply for the engine family. Also identify FELs and FCLs as follows:

(1) Identify the NO<sub>x</sub> FEL over the FTP for the engine family.

(2) Identify the CO<sub>2</sub> FCLs for the engine family; also identify any FELs that apply for CH<sub>4</sub> and N<sub>2</sub>O. The actual U.S.-directed production volume of configurations that have CO<sub>2</sub> emission rates at or below the FCL and CH<sub>4</sub> and N<sub>2</sub>O emission rates at or below the applicable standards or FELs must be at least one percent of your actual (not projected) U.S.-directed production volume for the engine family. Identify configurations within the family that have emission rates at or below the FCL and meet the one percent requirement. For example, if your U.S.-directed production volume for the engine family is 10,583 and the U.S.-directed production volume for the tested rating is 75 engines, then you can comply with this provision by setting your FCL so that one more rating with a U.S.-directed production volume of at least 31 engines meets the FCL. Where applicable, also identify other testable configurations required under § 1036.230(f)(2)(ii).

(m) Identify the engine family's deterioration factors and describe how you developed them (see §§ 1036.240

and 1036.241). Present any test data you used for this.

(n) State that you operated your emission-data engines as described in the application (including the test procedures, test parameters, and test fuels) to show you meet the requirements of this part.

(o) Present emission data from all valid tests on an emission-data engine to show that you meet emission standards. Note that § 1036.235 allows you to submit an application in certain cases without new emission data. Present emission data as follows:

(1) For hydrocarbons (such as NMHC or NMHCE), NO<sub>x</sub>, PM, and CO, as applicable, show your engines meet the applicable exhaust emission standards we specify in § 1036.104. Show emission figures for duty-cycle exhaust emission standards before and after applying adjustment factors for regeneration and deterioration factors for each engine.

(2) For CO<sub>2</sub>, CH<sub>4</sub>, and NO<sub>2</sub>, show that your engines meet the applicable emission standards we specify in § 1036.108. Show emission figures before and after applying deterioration factors for each engine. In addition to the composite results, show individual measurements for cold-start testing and hot-start testing over the transient test cycle. For each of these tests, also include the corresponding exhaust emission data for criteria emissions.

(3) If we specify more than one grade of any fuel type (for example, a summer grade and winter grade of gasoline), you need to submit test data only for one grade, unless the regulations of this part specify otherwise for your engine.

(p) State that all the engines in the engine family comply with the off-cycle emission standards we specify in § 1036.104 for all normal operation and use when tested as specified in § 1036.515. Describe any relevant testing, engineering analysis, or other information in sufficient detail to support your statement.

(q) We may ask you to send information to confirm that the emission data you submitted were from valid tests meeting the requirements of this part and 40 CFR part 1065. You must indicate whether there are test results from invalid tests or from any other tests of the emission-data engine, whether or not they were conducted according to the test procedures of subpart F of this part. We may require you to report these additional test results.

(r) Describe all adjustable operating parameters (see § 1036.115(f)), including production tolerances. For any operating parameters that do not qualify as adjustable parameters, include a



description supporting your conclusion (see 40 CFR 1068.50(c)). Include the following in your description of each adjustable parameter:

(1) For mechanically controlled parameters, include the nominal or recommended setting, the intended physically adjustable range, and the limits or stops used to establish adjustable ranges. Also include information showing why the limits, stops, or other means of inhibiting adjustment are effective in preventing adjustment of parameters on in-use engines to settings outside your intended physically adjustable ranges.

(2) For electronically controlled parameters, describe how your engines are designed to prevent unauthorized adjustments.

(s) Provide the information to read, record, and interpret all the information broadcast by an engine's onboard computers and ECMs as described in § 1036.115(d). State that, upon request, you will give us any hardware, software, or tools we would need to do this.

(t) Confirm that your emission-related installation instructions specify how to ensure that sampling of exhaust emissions will be possible after engines are installed in equipment and placed in service. If this cannot be done by simply adding a 20-centimeter extension to the exhaust pipe, show how to sample exhaust emissions in a way that prevents diluting the exhaust sample with ambient air.

(u) State whether your certification is limited for certain engines. For example, you might certify engines only for use in tractors, in emergency vehicles, or in vehicles with hybrid powertrains. If this is the case, describe how you will prevent use of these engines in vehicles for which they are not certified.

(v) Unconditionally certify that all the engines in the engine family comply with the requirements of this part, other referenced parts of the CFR, and the Clean Air Act. Note that § 1036.235 specifies which engines to test to show that engines in the entire family comply with the requirements of this part.

(w) Include good-faith estimates of U.S.-directed production volumes. Include a justification for the estimated production volumes if they are substantially different than actual production volumes in earlier years for similar models.

(x) Include the information required by other subparts of this part. For example, include the information required by § 1036.725 if you participate in the ABT program.

(y) Include other applicable information, such as information

specified in this part or 40 CFR part 1068 related to requests for exemptions.

(z) Name an agent for service located in the United States. Service on this agent constitutes service on you or any of your officers or employees for any action by EPA or otherwise by the United States related to the requirements of this part.

(aa) For imported engines, identify the following:

(1) Describe your normal practice for importing engines. For example, this may include identifying the names and addresses of any agents you have authorized to import your engines. Engines imported by nonauthorized agents are not covered by your certificate.

(2) The location of a test facility in the United States where you can test your engines if we select them for testing under a selective enforcement audit, as specified in 40 CFR part 1068, subpart E.

(bb) Include information needed to certify vehicles to greenhouse gas standards under 40 CFR part 1037 as described in § 1036.503.

#### **§ 1036.210 Preliminary approval before certification.**

If you send us information before you finish the application, we may review it and make any appropriate determinations, especially for questions related to engine family definitions, auxiliary emission control devices, adjustable parameters, deterioration factors, testing for service accumulation, and maintenance. Decisions made under this section are considered to be preliminary approval, subject to final review and approval. We will generally not reverse a decision where we have given you preliminary approval, unless we find new information supporting a different decision. If you request preliminary approval related to the upcoming model year or the model year after that, we will make best-efforts to make the appropriate determinations as soon as practicable. We will generally not provide preliminary approval related to a future model year more than two years ahead of time.

#### **§ 1036.225 Amending applications for certification.**

Before we issue you a certificate of conformity, you may amend your application to include new or modified engine configurations, subject to the provisions of this section. After we have issued your certificate of conformity, you may send us an amended application any time before the end of the model year requesting that we include new or modified engine

configurations within the scope of the certificate, subject to the provisions of this section. You must also amend your application if any changes occur with respect to any information that is included or should be included in your application.

(a) You must amend your application before you take any of the following actions:

(1) Add an engine configuration to an engine family. In this case, the engine configuration added must be consistent with other engine configurations in the engine family with respect to the design aspects listed in § 1036.230.

(2) Change an engine configuration already included in an engine family in a way that may affect emissions, or change any of the components you described in your application for certification. This includes production and design changes that may affect emissions any time during the engine's lifetime.

(3) Modify an FEL or FCL for an engine family as described in paragraph (f) of this section.

(b) To amend your application for certification, send the relevant information to the Designated Compliance Officer.

(1) Describe in detail the addition or change in the engine model or configuration you intend to make.

(2) Include engineering evaluations or data showing that the amended engine family complies with all applicable requirements. You may do this by showing that the original emission-data engine is still appropriate for showing that the amended family complies with all applicable requirements.

(3) If the original emission-data engine for the engine family is not appropriate to show compliance for the new or modified engine configuration, include new test data showing that the new or modified engine configuration meets the requirements of this part.

(4) Include any other information needed to make your application correct and complete.

(c) We may ask for more test data or engineering evaluations. You must give us these within 30 days after we request them.

(d) For engine families already covered by a certificate of conformity, we will determine whether the existing certificate of conformity covers your newly added or modified engine. You may ask for a hearing if we deny your request (see § 1036.820).

(e) The amended application applies starting with the date you submit the amended application, as follows:

(1) For engine families already covered by a certificate of conformity,

you may start producing a new or modified engine configuration any time after you send us your amended application and before we make a decision under paragraph (d) of this section. However, if we determine that the affected engines do not meet applicable requirements in this part, we will notify you to cease production of the engines and may require you to recall the engines at no expense to the owner. Choosing to produce engines under this paragraph (e) is deemed to be consent to recall all engines that we determine do not meet applicable emission standards or other requirements in this part and to remedy the nonconformity at no expense to the owner. If you do not provide information required under paragraph (c) of this section within 30 days after we request it, you must stop producing the new or modified engines.

(2) [Reserved]

(f) You may ask us to approve a change to your FEL in certain cases after the start of production, but before the end of the model year. If you change an FEL for CO<sub>2</sub>, your FCL for CO<sub>2</sub> is automatically set to your new FEL divided by 1.03. The changed FEL may not apply to engines you have already introduced into U.S. commerce, except as described in this paragraph (f). You may ask us to approve a change to your FEL in the following cases:

(1) You may ask to raise your FEL for your engine family at any time. In your request, you must show that you will still be able to meet the emission standards as specified in subparts B and H of this part. Use the appropriate FELs/FCLs with corresponding production volumes to calculate emission credits for the model year, as described in subpart H of this part.

(2) You may ask to lower the FEL for your engine family only if you have test data from production engines showing that emissions are below the proposed lower FEL (or below the proposed FCL for CO<sub>2</sub>). The lower FEL/FCL applies only to engines you produce after we approve the new FEL/FCL. Use the appropriate FEL/FCL with corresponding production volumes to calculate emission credits for the model year, as described in subpart H of this part.

(g) You may produce engines or modify in-use engines as described in your amended application for certification and consider those engines to be in a certified configuration. Modifying a new or in-use engine to be in a certified configuration does not violate the tampering prohibition of 40 CFR 1068.101(b)(1), as long as this does not involve changing to a certified

configuration with a higher family emission limit.

#### § 1036.230 Selecting engine families.

(a) For purposes of certification to the standards of this part, divide your product line into families of engines that are expected to have similar characteristics for criteria emissions throughout the useful life as described in this section. Your engine family is limited to a single model year.

(b) Group engines in the same engine family if they are the same in all the following design aspects:

(1) The combustion cycle and fuel. See paragraph (g) of this section for special provisions that apply for dual-fuel and flexible-fuel engines.

(2) The cooling system (water-cooled vs. air-cooled).

(3) Method of air aspiration, including the location of intake and exhaust valves or ports and the method of intake-air cooling, if applicable.

(4) The number, location, volume, and composition of catalytic converters or other aftertreatment devices.

(5) Cylinder arrangement (such as in-line vs. vee configurations), number of cylinders, and bore center-to-center dimensions.

(6) Method of control for engine operation other than governing (*i.e.*, mechanical or electronic).

(7) The numerical level of the applicable criteria emission standards. For example, an engine family may not include engines certified to different family emission limits for criteria emission standards, though you may change family emission limits without recertifying as specified in § 1036.225(f).

(c) You may subdivide a group of engines that is identical under paragraph (b) of this section into different engine families if you show the expected criteria emission characteristics are different during the useful life.

(d) In unusual circumstances, you may group engines that are not identical with respect to the design aspects listed in paragraph (b) of this section in the same engine family if you show that their criteria emission characteristics during the useful life will be similar.

(e) Engine configurations certified as hybrid engines or hybrid powertrains may not be included in an engine family with engines that have nonhybrid powertrains. Note that this does not prevent you from including engines in a nonhybrid family if they are used in hybrid vehicles, as long as you certify them based on engine testing.

(f) You must certify your engines to the greenhouse gas standards of § 1036.108 using the same engine

families you use for criteria pollutants. The following additional provisions apply with respect to demonstrating compliance with the standards in § 1036.108:

(1) You may subdivide an engine family into subfamilies that have a different FCL for CO<sub>2</sub> emissions. These subfamilies do not apply for demonstrating compliance with criteria standards in § 1036.104.

(2) If you certify engines in the family for use as both vocational and tractor engines, you must split your family into two separate subfamilies.

(i) Calculate emission credits relative to the vocational engine standard for the number of engines sold into vocational applications and relative to the tractor engine standard for the number of engines sold into non-vocational tractor applications. You may assign the numbers and configurations of engines within the respective subfamilies at any time before submitting the end-of-year report required by § 1036.730. If the family participates in averaging, banking, or trading, you must identify the type of vehicle in which each engine is installed; we may alternatively allow you to use statistical methods to determine this for a fraction of your engines. Keep records to document this determination.

(ii) If you restrict use of the test configuration for your split family only to tractors, or only to vocational vehicles, you must identify a second testable configuration for the other type of vehicle (or an unrestricted configuration). Identify this configuration in your application for certification. The FCL for the engine family applies for this configuration as well as the primary test configuration.

(3) If you certify both engine fuel maps and powertrain fuel maps for an engine family, you may split the engine family into two separate subfamilies. Indicate this in your application for certification, and identify whether one or both of these sets of fuel maps applies for each group of engines. If you do not split your family, all engines within the family must conform to the engine fuel maps, including any engines for which the powertrain maps also apply.

(4) If you certify in separate engine families engines that could have been certified in vocational and tractor engine subfamilies in the same engine family, count the two families as one family for purposes of determining your obligations with respect to the OBD requirements and in-use testing requirements. Indicate in the applications for certification that the two engine families are covered by this paragraph (f)(4).

(5) Except as described in this paragraph (f), engine configurations within an engine family must use equivalent greenhouse gas emission controls. Unless we approve it, you may not produce nontested configurations without the same emission control hardware included on the tested configuration. We will only approve it if you demonstrate that the exclusion of the hardware does not increase greenhouse gas emissions.

(g) You may certify dual-fuel or flexible-fuel engines in a single engine family. You may include dedicated-fuel versions of this same engine model in the same engine family, as long as they are identical to the engine configuration with respect to that fuel type for the dual-fuel or flexible-fuel version of the engine. For example, if you produce an engine that can alternately run on gasoline and natural gas, you can include the gasoline-only and natural gas-only versions of the engine in the same engine family as the dual-fuel engine if engine operation on each fuel type is identical with or without installation of components for operating on the other fuel.

#### **§ 1036.235 Testing requirements for certification.**

This section describes the emission testing you must perform to show compliance with the emission standards in §§ 1036.104 and 1036.108.

(a) Select and configure a single emission-data engine from each engine family.

(1) For criteria pollutant emission testing, select the engine configuration most likely to exceed (or have emissions nearer to) an applicable emission standard or FEL identified in § 1036.205(l)(1). To the extent we allow it for establishing deterioration factors, select for testing those engine components or subsystems whose deterioration represents the deterioration of in-use engines.

(2) For greenhouse gas emission testing, the standards of this part apply only with respect to emissions measured from this tested configuration and other configurations identified in § 1036.205(l)(2). Note that configurations identified in § 1036.205(l)(2) are considered to be “tested configurations” whether or not you test them for certification. However, you must apply the same (or equivalent) emission controls to all other engine configurations in the engine family. In other contexts, the tested configuration is sometimes referred to as the “parent configuration”, although the terms are not synonymous.

(b) Test your emission-data engines using the procedures and equipment specified in subpart F of this part. In the case of dual-fuel and flexible-fuel engines, measure emissions when operating with each type of fuel for which you intend to certify the engine.

(1) For criteria pollutant emission testing, measure NO<sub>x</sub>, PM, CO, and NMHC emissions using each duty cycle specified in § 1036.104.

(2) For greenhouse gas emission testing, measure CO<sub>2</sub>, CH<sub>4</sub>, and N<sub>2</sub>O emissions; the following provisions apply regarding test cycles for demonstrating compliance with tractor and vocational standards:

(i) If you are certifying the engine for use in tractors, you must measure CO<sub>2</sub> emissions using the applicable SET specified in § 1036.505, taking into account the interim provisions in § 1036.150(s), and measure CH<sub>4</sub> and N<sub>2</sub>O emissions using the specified transient cycle.

(ii) If you are certifying the engine for use in vocational applications, you must measure CO<sub>2</sub>, CH<sub>4</sub>, and N<sub>2</sub>O emissions using the specified transient duty cycle, including cold-start and hot-start testing as specified in § 1036.510.

(iii) You may certify your engine family for both tractor and vocational use by submitting CO<sub>2</sub> emission data from both SET and transient cycle testing and specifying FCLs for both duty cycles.

(iv) Some of your engines certified for use in tractors may also be used in vocational vehicles, and some of your engines certified for use in vocational may be used in tractors. However, you may not knowingly circumvent the intent of this part (to reduce in-use emissions of CO<sub>2</sub>) by certifying engines designed for tractors or vocational vehicles (and rarely used in the other application) to the wrong cycle. For example, we would generally not allow you to certify all your engines to the SET without certifying any to the transient cycle.

(c) We may perform confirmatory testing by measuring emissions from any of your emission-data engines. If your certification includes powertrain testing as specified in § 1036.630, this paragraph (c) also applies for the powertrain test results.

(1) We may decide to do the testing at your plant or any other facility. If we do this, you must deliver the engine to a test facility we designate. The engine you provide must include appropriate manifolds, aftertreatment devices, ECMs, and other emission-related components not normally attached directly to the engine block. If we do the testing at your plant, you must schedule

it as soon as possible and make available the instruments, personnel, and equipment we need.

(2) If we measure emissions on your engine, the results of that testing become the official emission results for the engine as specified in this paragraph (c). Unless we later invalidate these data, we may decide not to consider your data in determining if your engine family meets applicable requirements in this part.

(3) Before we test one of your engines, we may set its adjustable parameters to any point within the physically adjustable ranges (see § 1036.115(f)).

(4) Before we test one of your engines, we may calibrate it within normal production tolerances for anything we do not consider an adjustable parameter. For example, we may calibrate it within normal production tolerances for an engine parameter that is subject to production variability because it is adjustable during production, but is not considered an adjustable parameter (as defined in § 1036.801) because it is permanently sealed. For parameters that relate to a level of performance that is itself subject to a specified range (such as maximum power output), we will generally perform any calibration under this paragraph (c)(4) in a way that keeps performance within the specified range.

(5) For greenhouse gas emission testing, we may use our emission test results for steady-state, idle, cycle-average and powertrain fuel maps defined in § 1036.503(b) as the official emission results. We will not replace individual points from your fuel map.

(i) We will determine fuel masses,  $m_{\text{fuel}[\text{cycle}]}$ , and mean idle fuel mass flow rates,  $\bar{m}_{\text{fuel}[\text{idle}]}$ , if applicable, using both direct and indirect measurement. We will determine the result for each test point based on carbon balance error verification as described in § 1036.535(g)(3)(i) and (ii).

(ii) We will perform this comparison using the weighted results from GEM, using vehicles that are appropriate for the engine under test. For example, we may select vehicles that the engine went into for the previous model year.

(iii) If you supply cycle-average engine fuel maps for the highway cruise cycles instead of generating a steady-state fuel map for these cycles, we may perform a confirmatory test of your engine fuel maps for the highway cruise cycles by either of the following methods:

(A) Directly measuring the highway cruise cycle-average fuel maps.

(B) Measuring a steady-state fuel map as described in this paragraph (c)(5) and using it in GEM to create our own cycle-

average engine fuel maps for the highway cruise cycles.

(iv) We will replace fuel maps as a result of confirmatory testing as follows:

(A) Weight individual duty cycle results using the vehicle categories

determined in paragraph (c)(5)(i) of this section and respective weighting factors in 40 CFR 1037.510(c) to determine a composite CO<sub>2</sub> emission value for each vehicle configuration; then repeat the process for all the unique vehicle

configurations used to generate the manufacturer's fuel maps.

(B) The average percent difference between fuel maps is calculated using the following equation:

$$\text{difference} = \left( \frac{\sum_{i=1}^N \frac{e_{\text{CO2compEPA}i} - e_{\text{CO2compManu}i}}{e_{\text{CO2compManu}i}}}{N} \right) \cdot 100 \%$$

Eq. 1036.235-1

Where:

$i$  = an indexing variable that represents one individual weighted duty cycle result for a vehicle configuration.

$N$  = total number of vehicle configurations.

$e_{\text{CO2compEPA}i}$  = unrounded composite mass of CO<sub>2</sub> emissions in g/ton-mile for vehicle configuration  $i$  for the EPA test.

$e_{\text{CO2compManu}i}$  = unrounded composite mass of CO<sub>2</sub> emissions in g/ton-mile for vehicle configuration  $i$  for the manufacturer-declared map.

(C) Where the unrounded average percent difference between our composite weighted fuel map and the manufacturer's is at or below 0%, we will not replace the manufacturer's maps, and we will consider an individual engine to have passed the fuel map.

(6) We may perform confirmatory testing with an engine dynamometer to simulate normal engine operation to determine whether your emission-data engine meets off-cycle emission standards. The accuracy margins described in § 1036.420(a) do not apply for such laboratory testing.

(d) You may ask to use carryover emission data from a previous model year instead of doing new tests, but only if all the following are true:

(1) The engine family from the previous model year differs from the current engine family only with respect to model year, items identified in § 1036.225(a), or other characteristics unrelated to emissions. We may waive this criterion for differences we determine not to be relevant.

(2) The emission-data engine from the previous model year remains the appropriate emission-data engine under paragraph (a) of this section.

(3) The data show that the emission-data engine would meet all the requirements that apply to the engine family covered by the application for certification. If the useful life for a new engine certification is longer than the useful life for the model year corresponding to the original testing, you must demonstrate that you meet the

requirements of §§ 1036.245 and 1036.246 in a way that accounts for the longer useful life for the new model year. For example, you may use carryover bench-aged deterioration factors in model year 2030 only if you originally performed bench-aging based on the useful life values for model year 2030 or if you supplement your original bench-aging procedures with additional bench-aging and emission measurements corresponding to the longer useful life that applies for model year 2030.

(e) We may require you to test a second engine of the same configuration in addition to the engines tested under paragraph (a) of this section.

(f) If you use an alternate test procedure under 40 CFR 1065.10 and later testing shows that such testing does not produce results that are equivalent to the procedures specified in subpart F of this part, we may reject data you generated using the alternate procedure.

(g) We may evaluate or test your engines to determine whether they have a defeat device before or after we issue a certificate of conformity. We may test or require testing on any vehicle or engine at a designated location, using driving cycles and conditions that may reasonably be expected in normal operation and use to investigate a potential defeat device. If we designate an engine's AECD as a possible defeat device, you must demonstrate to us that that the AECD does not reduce emission control effectiveness when the engine operates under conditions that may reasonably be expected in normal operation and use, unless one of the specific exceptions described in § 1036.115(h) applies.

**§ 1036.240 Demonstrating compliance with criteria pollutant emission standards.**

(a) For purposes of certification, your engine family is considered in compliance with the emission standards in § 1036.104 if all emission-data engines representing that family have

test results showing official emission results and deteriorated emission levels at or below these standards (including all corrections and adjustments). This also applies for all test points for emission-data engines within the family used to establish deterioration factors. Note that your FELs are considered to be the applicable emission standards with which you must comply if you participate in the ABT program in subpart H of this part.

(b) Your engine family is deemed not to comply if any emission-data engine representing that family has test results showing an official emission result or a deteriorated emission level for any pollutant that is above an applicable emission standard (including all corrections and adjustments). Similarly, your engine family is deemed not to comply if any emission-data engine representing that family has test results showing any emission level above the applicable off-cycle emission standard for any pollutant. This also applies for all test points for emission-data engines within the family used to establish deterioration factors.

(c) To compare emission levels from the emission-data engine with the applicable duty-cycle emission standards, apply deterioration factors to the measured emission levels for each pollutant. Section 1036.245 specifies how to test your engine to develop deterioration factors that represent the deterioration expected in emissions over your engines' useful life (or intermediate useful life, as applicable). Your deterioration factors must take into account any available data from in-use testing with similar engines. Small manufacturers may use assigned deterioration factors that we establish. Apply deterioration factors as follows:

(1) *Additive deterioration factor for exhaust emissions.* Except as specified in paragraph (c)(2) of this section, use an additive deterioration factor for exhaust emissions. An additive deterioration factor is the difference

between exhaust emissions at the end of the useful life and exhaust emissions at the low-hour test point. In these cases, adjust the official emission results for each tested engine at the selected test point by adding the factor to the measured emissions. If the factor is less than zero, use zero. Additive deterioration factors must be specified to one more decimal place than the applicable standard.

(2) *Multiplicative deterioration factor for exhaust emissions.* Use a multiplicative deterioration factor if good engineering judgment calls for the deterioration factor for a pollutant to be the ratio of exhaust emissions at the end of the useful life to exhaust emissions at the low-hour test point. For example, if you use aftertreatment technology that controls emissions of a pollutant proportionally to engine-out emissions, it is often appropriate to use a multiplicative deterioration factor. Adjust the official emission results for each tested engine at the selected test point by multiplying the measured emissions by the deterioration factor. If the factor is less than one, use one. A multiplicative deterioration factor may not be appropriate in cases where testing variability is significantly greater than engine-to-engine variability. Multiplicative deterioration factors must be specified to one more significant figure than the applicable standard.

(3) *Sawtooth and other nonlinear deterioration patterns.* The deterioration factors described in paragraphs (c)(1) and (2) of this section assume that the highest useful life emissions occur either at the end of useful life or at the low-hour test point. The provisions of this paragraph (c)(3) apply where good engineering judgment indicates that the highest useful life emissions will occur between these two points. For example, emissions may increase with service accumulation until a certain maintenance step is performed, then return to the low-hour emission levels and begin increasing again. Such a pattern may occur with battery-based electric hybrid engines. Base deterioration factors for engines with such emission patterns on the difference between (or ratio of) the point at which the highest emissions occur and the low-hour test point. Note that this applies for maintenance-related deterioration only where we allow such critical emission-related maintenance.

(4) *Dual-fuel and flexible-fuel engines.* In the case of dual-fuel and flexible-fuel engines, apply deterioration factors separately for each fuel type. You may accumulate service hours on a single emission-data engine using the type of fuel or the fuel mixture expected to have

the highest combustion and exhaust temperatures; you may ask us to approve a different fuel mixture if you demonstrate that a different criterion is more appropriate.

(d) Determine the official emission result for each pollutant to at least one more decimal place than the applicable standard. Apply the deterioration factor to the official emission result, as described in paragraph (c) of this section, then round the adjusted figure to the same number of decimal places as the emission standard. Compare the rounded emission levels to the emission standard for each emission-data engine.

**§ 1036.241 Demonstrating compliance with greenhouse gas emission standards.**

(a) For purposes of certification, your engine family is considered in compliance with the emission standards in § 1036.108 if all emission-data engines representing the tested configuration of that engine family have test results showing official emission results and deteriorated emission levels at or below the standards. Note that your FCLs are considered to be the applicable emission standards with which you must comply for certification.

(b) Your engine family is deemed not to comply if any emission-data engine representing the tested configuration of that engine family has test results showing an official emission result or a deteriorated emission level for any pollutant that is above an applicable emission standard (generally the FCL). Note that you may increase your FCL if any certification test results exceed your initial FCL.

(c) Apply deterioration factors to the measured emission levels for each pollutant to show compliance with the applicable emission standards. Your deterioration factors must take into account any available data from in-use testing with similar engines. Apply deterioration factors as follows:

(1) *Additive deterioration factor for greenhouse gas emissions.* Except as specified in paragraphs (c)(2) and (3) of this section, use an additive deterioration factor for exhaust emissions. An additive deterioration factor is the difference between the highest exhaust emissions (typically at the end of the useful life) and exhaust emissions at the low-hour test point. In these cases, adjust the official emission results for each tested engine at the selected test point by adding the factor to the measured emissions. If the factor is less than zero, use zero. Additive deterioration factors must be specified to one more decimal place than the applicable standard.

(2) *Multiplicative deterioration factor for greenhouse gas emissions.* Use a multiplicative deterioration factor for a pollutant if good engineering judgment calls for the deterioration factor for that pollutant to be the ratio of the highest exhaust emissions (typically at the end of the useful life) to exhaust emissions at the low-hour test point. Adjust the official emission results for each tested engine at the selected test point by multiplying the measured emissions by the deterioration factor. If the factor is less than one, use one. A multiplicative deterioration factor may not be appropriate in cases where testing variability is significantly greater than engine-to-engine variability. Multiplicative deterioration factors must be specified to one more significant figure than the applicable standard.

(3) *Sawtooth and other nonlinear deterioration patterns.* The deterioration factors described in paragraphs (c)(1) and (2) of this section assume that the highest useful life emissions occur either at the end of useful life or at the low-hour test point. The provisions of this paragraph (c)(3) apply where good engineering judgment indicates that the highest useful life emissions will occur between these two points. For example, emissions may increase with service accumulation until a certain maintenance step is performed, then return to the low-hour emission levels and begin increasing again. Such a pattern may occur with battery-based electric hybrid engines. Base deterioration factors for engines with such emission patterns on the difference between (or ratio of) the point at which the highest emissions occur and the low-hour test point. Note that this applies for maintenance-related deterioration only where we allow such critical emission-related maintenance.

(4) [Reserved]

(5) *Dual-fuel and flexible-fuel engines.* In the case of dual-fuel and flexible-fuel engines, apply deterioration factors separately for each fuel type by measuring emissions with each fuel type at each test point. You may accumulate service hours on a single emission-data engine using the type of fuel or the fuel mixture expected to have the highest combustion and exhaust temperatures; you may ask us to approve a different fuel mixture if you demonstrate that a different criterion is more appropriate.

(d) Calculate emission data using measurements to at least one more decimal place than the applicable standard. Apply the deterioration factor to the official emission result, as described in paragraph (c) of this section, then round the adjusted figure

to the same number of decimal places as the emission standard. Compare the rounded emission levels to the emission standard for each emission-data engine.

(e) If you identify more than one configuration in § 1036.205(l)(2), we may test (or require you to test) any of the identified configurations. We may also require you to provide an engineering analysis that demonstrates that untested configurations listed in § 1036.205(l)(2) comply with their FCL.

**§ 1036.245 Deterioration factors for exhaust emission standards.**

This section describes how to determine deterioration factors, either with an engineering analysis, with pre-existing test data, or with new emission measurements. Apply these deterioration factors to determine whether your engines will meet the duty-cycle emission standards as described in § 1036.240. These standards generally apply throughout the useful life; a separate deterioration factor applies starting in model year 2031 for intermediate useful life for Heavy HDE. The provisions of this section and § 1036.246 apply for all engine families starting in model year 2027; you may optionally use these provisions to determine and verify deterioration factors for earlier model years.

(a) You may ask us to approve deterioration factors for an engine family based on an engineering analysis of emission measurements from similar highway or nonroad engines if you have already given us these data for certifying the other engines in the same or earlier model years. Use good engineering judgment to decide whether the two engines are similar. We will approve your request if you show us that the emission measurements from other engines reasonably represent in-use deterioration for the engine family for which you have not yet determined deterioration factors.

(b) If you are unable to determine deterioration factors for an engine family under paragraph (a) of this section, select engines, subsystems, or components for testing. Determine deterioration factors based on service accumulation and related testing to represent the deterioration expected from in-use engines over the useful life. You may perform maintenance on emission-data engines as described in § 1036.125 and 40 CFR part 1065, subpart E. Use good engineering judgment for all aspects of the effort to establish deterioration factors under this paragraph (b). Send us your test plan for our preliminary approval under § 1036.210. You may apply deterioration

factors based on testing under this paragraph (b) to multiple engine families, consistent with the provisions in paragraph (a) of this section.

Determine deterioration factors using one of the following procedures:

(1) Operate the emission-data engine in the certified configuration on an engine dynamometer to represent the useful life.

(i) You may accelerate the service accumulation using higher-load operation based on equivalent total fuel flow. However, the engine operation for service accumulation must also include light-load operation (or alternating light-load and high-load operation) representing in-use behavior that may contribute to aging of aftertreatment devices or systems.

(ii) Calculate deterioration factors by comparing exhaust emissions at the end of the useful life and exhaust emissions at the low-hour test point. For Heavy HDE starting in model year 2031, also calculate deterioration factors by comparing exhaust emissions at the end of intermediate useful life and exhaust emissions at the low-hour test point.

Create a linear curve fit if testing includes intermediate test points. Calculate deterioration factors based on measured values, without extrapolation.

(2) Determine deterioration factors based on bench-aged aftertreatment. If you use this option, you must verify deterioration factors based on emission measurements with in-use engines as described in § 1036.246.

(i) Perform bench aging of aftertreatment devices in a way that accounts for thermal and chemical degradation to represent normal engine operation over the useful life. For Heavy HDE starting in model year 2031, also account for thermal and chemical degradation to represent normal engine operation over the intermediate useful life. Use an EPA-approved bench-aging procedure or propose an equivalent procedure. For example, this might involve testing consistent with the analogous procedures that apply for light-duty vehicles under 40 CFR part 86, subpart S.

(ii) After bench-aging aftertreatment devices, install or reinstall those aftertreatment devices and systems on an emission-data engine that has been stabilized without aftertreatment (or an equivalent engine). Ensure that the engine is in an appropriate certified configuration to represent the engine family.

(iii) Measure all criteria pollutants after operating the engine with the bench-aged aftertreatment devices to stabilize emission controls for at least 100 hours on an engine dynamometer.

(iv) Calculate deterioration factors by comparing exhaust emissions with the bench-aged aftertreatment at the useful life and exhaust emissions at the low-hour test point. For Heavy HDE starting in model year 2031, also calculate deterioration factors by comparing exhaust emissions with the bench-aged aftertreatment at the intermediate useful life and exhaust emissions at the low-hour test point. Create a linear curve fit if testing includes intermediate test points. Calculate deterioration factors based on measured values, without extrapolation.

(c) If you determine deterioration factors as described in paragraph (b)(2) of this section, you may apply those deterioration factors in later years for engine families that qualify for carryover certification as described in § 1036.235(d), subject to the conditions described in § 1036.246. You may also apply those deterioration factors for additional engine families as described in paragraph (a) of this section.

(d) Include the following information in your application for certification:

(1) If you use test data from a different engine family, explain why this is appropriate and include all the emission measurements on which you base the deterioration factors. If the deterioration factors for the new engine family are not identical to the deterioration factors for the different engine family, describe your engineering analysis to justify the revised values and state that all your data, analyses, evaluations, and other information are available for our review upon request.

(2) If you determined deterioration factors based on testing under paragraph (b)(1) of this section, describe your procedure for service accumulation, including a supporting rationale for any accelerated aging.

(3) If you determined deterioration factors under paragraph (b)(2) of this section, include the following information in the first year that you use those deterioration factors:

(i) Describe your bench aging or other procedures to represent full-life service accumulation for the engine's emission controls. Also describe how you prepared the test engine before and after installing aftertreatment systems to determine deterioration factors. Identify the power rating of the emission-data engine used to determine deterioration factors.

(ii) Describe your plan for verification testing under § 1036.246. Include at least the following information:

(A) Identify whether you intend to test using procedures specified in § 1036.246(d)(1), (2), or (3).

(B) Describe how you intend to identify candidate vehicles for testing, including consideration of how you will identify or prioritize specific vehicle types and vehicle applications to represent the engine family.

(C) Describe your intended schedule for recruiting and testing vehicles.

(D) Describe any steps you will take to ensure that selected vehicles have been properly maintained and used.

(4) If you determined deterioration factors under paragraph (b)(2) of this section, include the following information in any later year that you use those deterioration factors:

(i) Identify any changes or updates to your verification test plan that you have made in your most recent testing, or that you plan to make for later years.

(ii) Submit a report to describe any verification testing you have performed under § 1036.246 as described in § 1036.246(e). Include previously submitted results in addition to information related to new testing you performed for the current submission.

**§ 1036.246 Verifying deterioration factors.**

This section describes how to perform in-use testing to verify that your deterioration factors are appropriate. This applies for deterioration factors you determine based on testing with bench-aged aftertreatment devices or other procedures as described in § 1036.245(b)(2). You may continue to use those deterioration factors for later model years with carryover engines if in-use engines meet the verification requirements of this section.

(a) Paragraph (d) of this section describes three different verification procedures you may use for measuring emissions. We may also approve your request to use an alternative verification procedure if you demonstrate that it is at least as effective as one of the specified verification procedures.

(b) Verify deterioration factors based on bench-aged aftertreatment as follows:

(1) You may use the original deterioration factors for the original model year and one additional model year, prior to the start of the year three production verification, without restriction.

(2) You must verify the original deterioration factors with testing that starts in the third year of production and continues in later production years up to and including the eighth year of production.

(3) As long as your verification test has a passing result, you may continue to use the original deterioration factors for the upcoming model year without restriction.

(4) The provisions of paragraph (h) of this section apply if your verification testing has a fail result.

(c) Select and prepare in-use engines for verification testing under this section as follows:

(1) You may recruit candidate engines any time before testing. This may involve creating a pool of candidate engines and vehicles in coordination with vehicle manufacturers and vehicle purchasers to ensure availability and to confirm a history of proper maintenance. You may meet the testing requirements of this section by repeating tests on a given engine as it ages, or you may test different engines over the course of verification testing; however, you may not choose whether to repeat tests on a given engine at a later stage based on its measured emission levels. This generally requires that you describe your plan for selecting engines in advance and justify any departures from that plan.

(2) Selected vehicles must come from independent sources, unless we approve your request to select vehicles that you own or manage. In your request, you must describe how you will ensure that the vehicle operator will drive in a way that represents normal in-use operation for the engine family.

(3) Select vehicles with installed engines from the same engine family and with the same power rating as the emission-data engine used to determine the deterioration factors. You may ask for our approval to modify engines in selected vehicles by reflashing the ECM or replacing parts to change the engines to be in a different certified configuration for proper testing. We may approve your request to modify the engines or we may waive test specifications to allow you to test in the as-received condition.

(4) You may exclude selected engines from testing if you determine that they have not been properly maintained or used. Selected engines may not have maintenance exceeding your instructions for the maintenance items specified in § 1036.125(a). Selected engines must have their original aftertreatment components and be in a certified configuration. Do not perform verification testing with an engine if its critical emission-related components had a major repair other than what we allow under § 1036.125(a). You may ask us to approve replacing a critical emission-related component with an equivalent part that has undergone a comparable degree of aging.

(5) Select vehicles meeting the mileage specifications specified in Table 1 of this paragraph (c)(5) for each stage of the verification testing program. If

you are unable to find enough test vehicles that meet the mileage specifications, perform testing as described in this section using vehicles with the highest available mileage and describe how you will attempt to test properly qualified vehicles for later years. If this occurs in the eighth year, continue testing in future years until all tested vehicles have mileage that is at least 85 percent of the engine's useful life.

**TABLE 1 TO PARAGRAPH (C)(5) OF § 1036.246—MINIMUM AGE REQUIRED FOR OBTAINING IN-USE ENGINES**

Year of production following the initial model year that relied on the deterioration factors	Minimum mileage for selected vehicles as a percentage of the engine's useful life
1	—
2	—
3	35%
4	45
5	55
6	65
7	75
8	85

(6) You may accelerate the testing schedule specified in paragraph (c)(5) of this section if all your test vehicles in a given year meet the mileage specifications for a later year of testing.

(d) Perform verification testing each year with one of the following procedures:

(1) *Engine dynamometer testing.* Measure emissions from engines equipped with in-use aftertreatment systems on an engine dynamometer as follows:

(i) Test at least two engines using the procedures specified in subpart F of this part and 40 CFR part 1065. Install the aftertreatment system from the selected in-use vehicle, including all associated wiring, sensors, and related hardware and software, on one of the following partially complete engines:

(A) The in-use engine from the same vehicle.

(B) The emission-data engine used to determine the deterioration factors.

(C) A different emission-data engine from the same engine family that has been stabilized as described in 40 CFR 1065.405(c).

(ii) Perform testing on all duty cycles with brake-specific emission standards (g/hp·hr) to determine whether the engine meets all the duty-cycle emission standards for criteria pollutants. Apply

infrequent regeneration adjustment factors as specified in § 1036.522.

(iii) Evaluate verification testing for each pollutant independently. You pass the verification test if at least 70 percent of tested engines meet standards for each pollutant over all duty cycles. You fail the verification test if 70 percent or fewer engines meet standards for a given pollutant over all duty cycles.

(2) *PEMS testing.* Measure emissions using PEMS with in-use engines that remain installed in selected vehicles as follows:

(i) Test at least five engines using the procedures specified in § 1036.520 and 40 CFR part 1065, subpart J.

(ii) Measure emissions of NO<sub>x</sub>, HC, and CO as the test vehicle's normal operator drives over a regular shift-day to determine whether the engine meets all the off-cycle emission standards that applied for the engine's original certification. Apply infrequent regeneration adjustment factors as specified in § 1036.522. For Spark-ignition HDE, calculate off-cycle emission standards for purposes of this subpart by multiplying the FTP duty-cycle standards in § 1036.104(a) by 2.0 in model years 2027 through 2030 and by 1.5 in model years 2031 and later, and rounding to the same number of decimal places.

(iii) Evaluate verification testing for each pollutant independently. You pass the verification test if at least 70 percent of tested engines meet standards for each pollutant. You fail the verification test if 70 percent or fewer engines do not meet standards for a given pollutant.

(iv) You may reverse a fail determination under paragraph (d)(2)(iii) of this section by restarting and successfully completing the verification test for that year using the procedures specified in paragraph (d)(1) of this section. If you do this, you must use the verification testing procedures specified in paragraph (d)(1) of this section for all remaining years of the verification testing program.

(3) *Onboard NO<sub>x</sub> measurement.* Collect on-board NO<sub>x</sub> data from in-use engines that remain installed in selected vehicles as follows:

(i) Test at least 50 percent of engines produced using the procedures specified in § 1036.520 and 40 CFR part 1065, subpart J. Perform the overall verification of your onboard NO<sub>x</sub> measurement system as described in 40 CFR 1065.920(b) using an engine that emits NO<sub>x</sub> at levels at or below the off-cycle NO<sub>x</sub> emission standard that applied for the engine's original certification. The onboard NO<sub>x</sub> measurement system must be functional within 100 seconds of engine starting

and must remain functional over the entire shift-day.

(ii) Collect NO<sub>x</sub> data as the test vehicle's normal operator drives over a regular shift-day to determine whether the engine meets the off-cycle NO<sub>x</sub> emission standards that applied for the engine's original certification. Apply infrequent regeneration adjustment factors as specified in § 1036.522. For Spark-ignition HDE, calculate off-cycle emission standards as described in paragraph (d)(2)(ii) of this section.

(iii) You pass the verification test if at least 70 percent of tested engines meet the off-cycle NO<sub>x</sub> emission standard. You fail the verification test if 70 percent or fewer engines do not meet standards for a given pollutant.

(iv) You may reverse a fail determination under paragraph (d)(3)(iii) of this section by restarting and successfully completing the verification test for that year using the procedures specified in paragraph (d)(1) of this section. If you do this, you must use the verification testing procedures specified in paragraph (d)(1) of this section for all remaining years of the verification testing program.

(e) You may stop testing before you meet all the requirements of this section in the following circumstances:

(1) In a given year, you may discontinue the verification test program and concede a fail result before you meet all the testing requirements of this section. However, we may require you to do more testing before we approve revised deterioration factors under paragraph (h)(2) of this section.

(2) You may stop testing before the eight-year period specified in paragraph (c)(5) of this section if you meet all the requirements with vehicles that had mileage accumulation representing at least 85 percent of the engine family's useful life.

(f) Prepare a report to describe your verification testing each year. Include at least the following information:

(1) Identify whether you tested using the procedures specified in § 1036.246(d)(1), (2), or (3).

(2) Describe how the test results support a pass or fail decision for the verification test. For in-field measurements, include continuous 1 Hz data collected over the shift-day and binned emission values determined under § 1036.515.

(3) If your testing included invalid test results, describe the reasons for invalidating the data. Give us the invalid test results if we ask for them.

(4) Describe the types of vehicles selected for testing. If you determined that any selected vehicles with enough mileage accumulation were not suitable

for testing, describe why you chose not to test them.

(5) For each tested engine, identify the vehicle's VIN, the engine's serial number, the engine's power rating, and the odometer reading and the engine's lifetime operating hours at the start of testing (or engine removal).

(6) State that the tested engines have been properly maintained and used and describe any noteworthy aspects of each vehicle's maintenance history. Describe the steps you took to prepare the engines for testing.

(7) For testing with engines that remain installed in vehicles, identify the date and location of testing. Also describe the ambient conditions and the driving route over the course of the shift-day.

(g) Send electronic reports to the Designated Compliance Officer using an approved information format. If you want to use a different format, send us a written request with justification.

(1) You may send us reports as you complete testing for an engine instead of waiting until you complete testing for all engines.

(2) We may ask you to send us less information in your reports than we specify in this section.

(3) We may require you to send us more information to evaluate whether your engine family meets the requirements of this part.

(4) Once you send us information under this section, you need not send that information again in later reports.

(5) We will review your test report to evaluate the results of the verification testing at each stage. We will notify you if we disagree with your conclusions, if we need additional information, or if you need to revise your testing plan for future testing.

(h) The following provisions apply if your verification test has a fail result for any deterioration factor:

(1) You may certify affected engine families for one additional model year based on the original deterioration factors. We may require you to certify with family emission limits that are at the maximum values we allow in § 1036.104(c)(2), or at some lower value corresponding to your measured emission results. You may not generate emission credits from affected engine families for any pollutant. We may require you to apply the revised family emission limits to recalculate emission credits and credit balances from previous model years based on your test results.

(2) You may ask us to approve revised deterioration factors for future model years based on your measured emission results. You may use such revised



deterioration factors and continue verification testing under this section if the engine family still meets emission standards (or family emission limits) after applying the revised deterioration factors to the low-hour test results from an emission-data engine.

(3) Unless we approve revised deterioration factors under paragraph (h)(2) of this section, you must do new testing to establish deterioration factors after the one additional model year described in paragraph (h)(1) of this section.

(4) The provisions of this paragraph (h) apply for all engine families relying on the deterioration factors that failed to pass verification testing.

**§ 1036.250 Reporting and recordkeeping for certification.**

(a) By September 30 following the end of the model year, send the Designated Compliance Officer a report including the total U.S.-directed production volume of engines you produced in each engine family during the model year (based on information available at the time of the report). Report the production by serial number and engine configuration. You may combine this report with reports required under subpart H of this part. We may waive the reporting requirements of this paragraph (a) for small manufacturers.

(b) Organize and maintain the following records:

(1) A copy of all applications and any summary information you send us.

(2) Any of the information we specify in § 1036.205 that you were not required to include in your application.

(3) A detailed history of each emission-data engine. For each engine, describe all of the following:

(i) The emission-data engine's construction, including its origin and buildup, steps you took to ensure that it represents production engines, any components you built specially for it, and all the components you include in your application for certification.

(ii) How you accumulated engine operating hours (service accumulation), including the dates and the number of hours accumulated.

(iii) All maintenance, including modifications, parts changes, and other service, and the dates and reasons for the maintenance.

(iv) All your emission tests, including documentation on routine and standard tests, as specified in part 40 CFR part 1065, and the date and purpose of each test.

(v) All tests to diagnose engine or emission control performance, giving the date and time of each and the reasons for the test.

(vi) Any other significant events.

(4) Production figures for each engine family divided by assembly plant.

(5) Engine identification numbers for all the engines you produce under each certificate of conformity.

(c) Keep routine data from emission tests required by this part (such as test cell temperatures and relative humidity readings) for one year after we issue the associated certificate of conformity. Keep all other information specified in this section for eight years after we issue your certificate.

(d) Store these records in any format and on any media, as long as you can promptly send us organized, written records in English if we ask for them. You must keep these records readily available. We may review them at any time.

**§ 1036.255 EPA oversight on certificates of conformity.**

(a) If we determine an application is complete and shows that the engine family meets all the requirements of this part and the Act, we will issue a certificate of conformity for the engine family for that model year. We may make the approval subject to additional conditions.

(b) We may deny an application for certification if we determine that an engine family fails to comply with emission standards or other requirements of this part or the Clean Air Act. We will base our decision on all available information. If we deny an application, we will explain why in writing.

(c) In addition, we may deny your application or suspend or revoke a certificate of conformity if you do any of the following:

(1) Refuse to comply with any testing or reporting requirements in this part.

(2) Submit false or incomplete information. This includes doing anything after submitting an application that causes submitted information to be false or incomplete.

(3) Cause any test data to become inaccurate.

(4) Deny us from completing authorized activities (see 40 CFR 1068.20). This includes a failure to provide reasonable assistance.

(5) Produce engines for importation into the United States at a location where local law prohibits us from carrying out authorized activities.

(6) Fail to supply requested information or amend an application to include all engines being produced.

(7) Take any action that otherwise circumvents the intent of the Act or this part.

(d) We may void a certificate of conformity if you fail to keep records,

send reports, or give us information as required under this part or the Act. Note that these are also violations of 40 CFR 1068.101(a)(2).

(e) We may void a certificate of conformity if we find that you intentionally submitted false or incomplete information. This includes doing anything after submitting an application that causes submitted information to be false or incomplete after submission.

(f) If we deny an application or suspend, revoke, or void a certificate, you may ask for a hearing (see § 1036.820).

**Subpart D—Testing Production Engines and Hybrid Powertrains**

**§ 1036.301 Measurements related to GEM inputs in a selective enforcement audit.**

(a) Selective enforcement audits apply for engines as specified in 40 CFR part 1068, subpart E. This section describes how this applies uniquely in certain circumstances.

(b) Selective enforcement audit provisions apply with respect to your fuel maps as follows:

(1) A selective enforcement audit for an engine with respect to fuel maps would consist of performing measurements with production engines to determine fuel-consumption rates as declared for GEM simulations, and running GEM for the vehicle configurations specified in paragraph (b)(2) of this section based on those measured values. The engine is considered passing for a given configuration if the new modeled emission result for each applicable duty cycle is at or below the modeled emission result corresponding to the declared GEM inputs. The engine is considered failing if it is determined that its fuel map test result is above the modeled emission result corresponding to the result using the manufacturer-declared fuel maps, as specified in § 1036.235(c)(5).

(2) If the audit includes fuel-map testing in conjunction with engine testing relative to exhaust emission standards, the fuel-map simulations for the whole set of vehicles and duty cycles counts as a single test result for purposes of evaluating whether the engine family meets the pass-fail criteria under 40 CFR 1068.420.

(c) If your certification includes powertrain testing as specified in 40 CFR 1036.630, these selective enforcement audit provisions apply with respect to powertrain test results as specified in 40 CFR part 1037, subpart D, and 40 CFR 1037.550. We may allow manufacturers to instead perform the

engine-based testing to simulate the powertrain test as specified in 40 CFR 1037.551.

(d) We may suspend or revoke certificates for any appropriate configurations within one or more engine families based on the outcome of a selective enforcement audit.

### Subpart E—In-Use Testing

#### § 1036.401 Testing requirements for in-use engines.

(a) We may perform in-use testing of any engine family subject to the standards of this part, consistent with the Clean Air Act and the provisions of § 1036.235.

(b) This subpart describes a manufacturer-run field-testing program that applies for model year 2027 and later compression-ignition engines. Note that the testing requirements of 40 CFR part 86, subpart T, continue to apply for model year 2026 and earlier engines.

(c) In-use test procedures for spark-ignition engines apply as described in § 1036.515. We won't require routine manufacturer-run field testing for spark-ignition engines, but the procedures of this subpart describe how to use field-testing procedures to measure emissions from engines installed in vehicles. Use good engineering judgment to apply the measurement procedures for fuels other than gasoline.

(d) We may void your certificate of conformity for an engine family if you do not meet your obligations under this subpart. We may also void individual tests and require you to retest those vehicles or take other appropriate measures in instances where you have not performed the testing in accordance with the requirements described in this subpart.

#### § 1036.405 Overview of the manufacturer-run field-testing program.

(a) You must test in-use engines from the families we select. We may select the following number of engine families for testing, except as specified in paragraph (b) of this section:

(1) We may select up to 25 percent of your engine families in any calendar year, calculated by dividing the number of engine families you certified in the model year corresponding to the calendar year by four and rounding to the nearest whole number. We will consider only engine families with annual U.S.-directed production volumes above 1,500 units in calculating the number of engine families subject to testing each calendar year under the annual 25 percent engine family limit. If you have only three or fewer families that each exceed an

annual U.S.-directed production volume of 1,500 units, we may select one engine family per calendar year for testing.

(2) Over any four-year period, we will not select more than the average number of engine families that you have certified over that four-year period (the model year when the selection is made and the preceding three model years), based on rounding the average value to the nearest whole number.

(3) We will not select engine families for testing under this subpart from a given model year if your total U.S.-directed production volume was less than 100 engines.

(b) If there is clear evidence of a nonconformity with regard to an engine family, we may select that engine family without counting it as a selected engine family under paragraph (a) of this section. For example, there may be clear evidence of a nonconformity if you certify an engine family using carryover data after reaching a fail decision under this subpart in an earlier model year without modifying the engine to remedy the problem.

(c) We may select any individual engine family for testing, regardless of its production volume, as long as we do not select more than the number of engine families described in paragraph (a) of this section. We may select an engine family from model year 2027 or any later model year.

(d) You must complete all the required testing and reporting under this subpart (for all ten test engines, if applicable), within 18 months after we approve your proposed plan for recruiting, screening, and selecting vehicles. We will typically select engine families for testing and notify you in writing by June 30 of the applicable calendar year. If you request it, we may allow additional time to send us this information.

(e) If you make a good-faith effort to access enough test vehicles to complete the testing requirements under this subpart for an engine family, but are unable to do so, you must ask us either to modify the testing requirements for the selected engine family or to select a different engine family.

(f) We may select an engine family for repeat testing in a later calendar year. Such a selection for repeat testing would count as an additional engine family for that year under paragraph (a) of this section.

(g) You may ask for approval to meet requirements under this subpart for an engine family based on information from onboard NO<sub>x</sub> sensors that have been shown to comply with the onboard NO<sub>x</sub> measurement system verification described in 40 CFR

1065.920(b) using an engine that emits NO<sub>x</sub> at levels at or below the applicable standard. Any on-board NO<sub>x</sub> measurement system must be functional within 100 seconds of engine starting and must remain functional during the entire shift-day. An alternative test program would need to rely on telematic methods to collect NO<sub>x</sub> emission values broadly from engines in the fleet to evaluate whether emission controls are working properly across a wide range of engine operation. The alternative test program must include PEMS field-testing of at least two engines as described in this subpart, including measurement of all regulated pollutants. In your request, you must show us that the alternative program gives comparable assurance that your engines meet the NO<sub>x</sub> standards of this part. We may waive some or all of this subpart's requirements for the engine family if we approve your alternative test program.

#### § 1036.410 Selecting and screening vehicles and engines for testing.

(a) Send us your proposed plan for recruiting, screening, and selecting vehicles. Identify the types of vehicles, location, and any other relevant criteria. We will approve your plan if it supports the objective of measuring emissions to represent a broad range of operating characteristics.

(b) Select vehicles and engines for testing that meet the following criteria:

(1) The vehicles come from at least two independent sources.

(2) Powertrain, drivetrain, emission controls, and other key vehicle and engine systems have been properly maintained and used. See § 1036.125.

(3) The engines have not been tampered with, rebuilt, or undergone major repair that could be expected to affect emissions.

(4) The engines have not been misfueled. Do not consider engines misfueled if they have used fuel meeting the specifications of § 1036.415(c).

(5) The vehicles are likely to operate for at least three hours of non-idle operation over a complete shift-day, as described in § 1036.415(f).

(6) The vehicles have not exceeded the applicable useful life, in miles, hours, or years; you may otherwise not exclude engines from testing based on their age or mileage.

(7) The vehicle has appropriate space for safe and proper mounting of the portable emission measurement system (PEMS) equipment.

(c) You must notify us before disqualifying any vehicle based on the owner declining to participate, illuminated MIL or stored OBD trouble

codes as described in § 1036.415(b)(2), or for any other reasons not specified in paragraph (b) of this section. For example, notify us if you disqualify any vehicle because the engine does not represent the engine family or the vehicle's usage is atypical for the particular application.

**§ 1036.415 Preparing and testing engines.**

(a) You must limit maintenance to what is in the owners manual for engines with that amount of service and age. For anything we consider an adjustable parameter (see § 1036.115(f)), you may adjust that parameter only if it is outside its adjustable range. You must then set the adjustable parameter to your recommended setting or the mid-point of its adjustable range, unless we approve your request to do otherwise. You must get our approval before adjusting anything not considered an adjustable parameter. You must keep records of all maintenance and adjustments, as required by § 1036.435. You must send us these records, as described in § 1036.430(a)(2)(ix), unless we instruct you not to send them.

(b) You may treat a vehicle with an illuminated MIL or stored trouble code as follows:

(1) If a candidate vehicle has an illuminated MIL or stored trouble code, either test the vehicle as received or repair the vehicle before testing. You may disqualify the vehicle only if MIL illumination or trouble code storage exceeds 12 hours. Once testing is initiated on the vehicle, you accept that the vehicle has been properly maintained and used.

(2) If a MIL illuminates or a trouble code appears on a test vehicle during a field test, stop the test and repair the vehicle. Determine test results as specified in § 1036.515 using one of the following options:

(i) Restart the testing and use only the portion of the full test results without the MIL illuminated or trouble code set.

(ii) Initiate a new test and use only the post-repair test results.

(3) If you determine that repairs are needed but they cannot be completed in a timely manner, you may disqualify the vehicle and replace it with another vehicle.

(c) Use appropriate fuels for testing, as follows:

(1) You may use any diesel fuel that meets the specifications for S15 in ASTM D975 (incorporated by reference in § 1036.810). You may use any commercially available biodiesel fuel blend that meets the specifications for ASTM D975 or ASTM D7467 (incorporated by reference in § 1036.810). You may use any gasoline

fuel that meets the specifications in ASTM D4814 (incorporated by reference in § 1036.810). For other fuel types, you may use any commercially available fuel.

(2) You may drain test vehicles' fuel tanks and refill them with diesel fuel conforming to the specifications in paragraph (c)(1) of this section.

(3) Any fuel that is added to a test vehicle's fuel tanks must be purchased at a local retail establishment near the site of vehicle recruitment or screening, or along the test route. Alternatively, the fuel may be drawn from a central fueling source, as long as the fuel represents commercially available fuel in the area of testing.

(4) No post-refinery fuel additives are allowed, except that specific fuel additives may be used during field testing if you can document that the test vehicle has a history of normally using the fuel treatments and they are not prohibited in the owners manual or in your published fuel-additive recommendations.

(5) You may take fuel samples from test vehicles to ensure that appropriate fuels were used during field testing. If a vehicle fails the vehicle-pass criteria and you can show that an inappropriate fuel was used during the failed test, that particular test may be voided. You may drain vehicles' fuel tanks and refill them with diesel fuel conforming to the specifications described in paragraph (c)(1) of this section. You must report any fuel tests that are the basis of voiding a test in your report under § 1036.430.

(d) You must test the selected engines using the test procedure described in § 1036.515 while they remain installed in the vehicle. Testing consists of characterizing emission rates for moving average 300 second windows while driving, with those windows divided into bins representing different types of engine operation over a shift-day. Use one of the following methods to measure emissions:

(1) Perform all testing with PEMS and field-testing procedures referenced in 40 CFR part 1065, subpart J. Measure emissions of HC, CO, NO<sub>x</sub>, PM, and CO<sub>2</sub>. You may determine HC emissions by any method specified in 40 CFR 1065.660(b).

(2) [Reserved]

(e) Operate the test vehicle under conditions reasonably expected during normal operation. For the purposes of this subpart, normal operation generally includes the vehicle's normal routes and loads (including auxiliary loads such as air conditioning in the cab), normal ambient conditions, and the normal driver.

(f) Once an engine is set up for testing, test the engine for at least one shift-day. To complete a shift-day's worth of testing, start sampling at the beginning of a shift and continue sampling for the whole shift, subject to the calibration requirements of the PEMS. A shift-day is the period of a normal workday for an individual employee. Evaluate the emission data as described in § 1036.420 and include the data in the reporting and record keeping requirements specified in §§ 1036.430 and 1036.435.

(g) You may ask us to waive testing relative to one or more emission standards if you can show that field testing for such emissions is not necessary.

**§ 1036.420 Pass criteria for individual engines.**

Perform the following steps to determine whether an engine meets the binned emission standards in § 1036.104(a)(4):

(a) Determine the binned or shift-day emission standard, as applicable, for each regulated pollutant by adding the following accuracy margins for PEMS to the off-cycle standards in § 1036.104(a)(4):

(1) HC: 10 mg/hp-hr.

(2) CO: 0.025 g/hp-hr.

(3) PM: 6 mg/hp-hr.

(4) NO<sub>x</sub>: 10% of the standard.

(b) Calculate the mass emission rate for each pollutant as specified in 40 CFR part 1065, subpart G, for use in the calculations in § 1036.515.

(c) For compression-ignition engines, determine the number of windows in each bin. A bin is valid under this section only if it has more than 2,400 windows. If the 2,400 valid windows in any bin is not achieved, continue testing additional shift-days as necessary to achieve the minimum window requirements for each bin. You may idle the engine anytime during the shift day to increase the number of windows in the idle bin.

(d) An engine passes if the result for each valid bin is at or below the standard determined in paragraph (a) of this section. An engine fails if the result for any valid bin for any pollutant is above the standard determined in paragraph (a) of this section. Having no valid bins for a bin category over a shift-day does not disqualify an engine from pass-fail determinations under this paragraph (d).

**§ 1036.425 Pass criteria for engine families.**

For testing with PEMS under § 1036.415(d)(1), determine the number of engines you must test from each selected engine family and the family pass criteria as follows:

(a) Start by measuring emissions from five engines using the procedures described in this subpart E and § 1036.515. If all five engines comply fully with the off-cycle bin standards, the engine family passes, and you may stop testing.

(b) If only one of the engines tested under paragraph (a) of this section does not comply fully with the off-cycle bin standards, test one more engine. If this additional engine complies fully with the off-cycle bin standards, the engine family passes, and you may stop testing.

(c) If two or more engines tested under paragraphs (a) and (b) of this section do not comply fully with the off-cycle bin standards, test additional engines until you have tested a total of ten engines. Calculate the arithmetic mean of the sum-over-sum emissions from the ten engine tests as specified in § 1036.515(g) for each pollutant. If the results are at or below the off-cycle bin standards, the engine family passes. If the result for any pollutant is above an off-cycle bin standard, the engine family fails.

#### § 1036.430 Reporting requirements.

(a) *Report content.* Prepare test reports as follows:

(1) Include the following for each engine family:

(i) Describe how you recruited vehicles. Describe how you used any criteria or thresholds to narrow your search or to screen individual vehicles.

(ii) Include a summary of the vehicles you have disqualified and the reasons you disqualified them, whether you base the disqualification on the criteria in § 1036.410(b) or anything else. If you disqualified a vehicle due to misfueling, include the results of any fuel sample tests. If you reject a vehicle due to tampering, describe how you determined that tampering occurred.

(iii) Identify how many engines you have tested from the applicable engine family and how many engines still need to be tested. Identify how many tested engines have passed or failed under § 1036.420.

(iv) After the final test, report the results and state the outcome of testing for the engine family based on the criteria in § 1036.425.

(v) Describe any incomplete or invalid tests that were conducted under this subpart.

(2) Include the following information for the test vehicle:

(i) The EPA engine-family designation, and the engine's model number, total displacement, and power rating.

(ii) The date EPA selected the engine family for testing.

(iii) The vehicle's make and model and the year it was built.

(iv) The vehicle identification number and engine serial number.

(v) The vehicle's type or application (such as delivery, line haul, or dump truck). Also, identify the type of trailer, if applicable.

(vi) The vehicle's maintenance and use history.

(vii) The known status history of the vehicle's OBD system and any actions taken to address OBD trouble codes or MIL illumination over the vehicle's lifetime.

(viii) Any OBD codes or MIL illumination that occur after you accept the vehicle for field testing under this subpart.

(ix) Any steps you take to maintain, adjust, modify, or repair the vehicle or its engine to prepare for or continue testing, including actions to address OBD trouble codes or MIL illumination. Include any steps you took to drain and refill the vehicle's fuel tank(s) to correct misfueling, and the results of any fuel test conducted to identify misfueling.

(3) Include the following data and measurements for each test vehicle:

(i) The date and time of testing, and the test number.

(ii) Number of shift-days of testing (see § 1036.415(f)).

(iii) Route and location of testing. You may base this description on the output from a global-positioning system (GPS).

(iv) The steps you took to ensure that vehicle operation during testing was consistent with normal operation and use, as described in § 1036.415(e).

(v) Fuel test results, if fuel was tested under § 1036.410 or § 1036.415.

(vi) The vehicle's mileage at the start of testing. Include the engine's total lifetime hours of operation, if available.

(vii) The number of windows in each bin (see § 1036.420(c)).

(viii) The bin emission value per vehicle for each pollutant. Describe the method you used to determine HC as specified in 40 CFR 1065.660(b).

(ix) Recorded 1 Hz test data for at least the following parameters, noting that gaps in the 1 Hz data file over the shift-day are only allowed during analyzer zero and span verifications:

(A) Ambient temperature.

(B) Ambient pressure.

(C) Ambient humidity.

(D) Altitude.

(E) Emissions of HC, CO, CO<sub>2</sub>, and NO<sub>x</sub>. Report results for PM if it was measured in a manner that provides 1 Hz test data.

(F) Differential backpressure of any PEMS attachments to vehicle exhaust.

(G) Exhaust flow.

(H) Exhaust aftertreatment temperatures.

(I) Engine speed.

(J) Engine brake torque.

(K) Engine coolant temperature

(L) Intake manifold temperature.

(M) Intake manifold pressure.

(N) Throttle position.

(O) Any parameter sensed or controlled to modulate the emission control system or fuel-injection timing.

(4) Include the following summary information after you complete testing with each engine:

(i) State whether the engine meets the off-cycle standards for each bin for each pollutant as described in § 1036.420(d).

(ii) Describe if any testing or evaluations were conducted to determine why a vehicle failed the off-cycle emission standards described in § 1036.420.

(iii) Describe the purpose of any diagnostic procedures you conduct.

(iv) Describe any instances in which the OBD system illuminated the MIL or set trouble codes. Also describe any actions taken to address the trouble codes or MIL.

(v) Describe any instances of misfueling, the approved actions taken to address the problem, and the results of any associated fuel sample testing.

(b) *Submission.* Send electronic reports to the Designated Compliance Officer using an approved information format. If you want to use a different format, send us a written request with justification.

(1) You may send us reports as you complete testing for an engine instead of waiting until you complete testing for all engines.

(2) We may ask you to send us less information in your reports than we specify in this section.

(3) We may require you to send us more information to evaluate whether your engine family meets the requirements of this part.

(4) Once you send us information under this section, you need not send that information again in later reports.

(c) *Additional notifications.* Notify the Designated Compliance Officer describing progress toward completing the required testing and reporting under this subpart, as follows:

(1) Notify us once you complete testing for an engine.

(2) Notify us if your review of the test data for an engine family indicates that two of the first five tested engines have failed to comply with the vehicle-pass criteria in § 1036.420(d).

(3) Notify us if your review of the test data for an engine family indicates that the engine family does not comply with the family-pass criteria in § 1036.425(c).

(4) Describe any voluntary vehicle/engine emission evaluation testing you

intend to conduct with PEMS on the same engine families that are being tested under this subpart, from the time that engine family was selected for field testing under § 1036.405 until the final results of all testing for that engine family are reported to us under this section.

#### **§ 1036.435 Recordkeeping requirements.**

Keep the following paper or electronic records of your field testing for five years after you complete all the testing required for an engine family:

(a) Keep a copy of the reports described in § 1036.430.

(b) Keep any additional records, including forms you create, related to any of the following:

(1) The recruitment, screening, and selection process described in § 1036.410, including the vehicle owner's name, address, phone number, and email address.

(2) Pre-test maintenance and adjustments to the engine performed under § 1036.415.

(3) Test results for all void, incomplete, and voluntary testing described in § 1036.430.

(4) Evaluations to determine why a vehicle failed any of the bin standards described in § 1036.420.

(c) Keep a copy of the relevant calibration results required by 40 CFR part 1065.

#### **§ 1036.440 Warranty obligations related to in-use testing.**

Testing under this subpart that finds an engine exceeding emission standards under this subpart is not by itself sufficient to show a breach of warranty under 42 U.S.C. 7541(a)(1). A breach of warranty would also require one of the following:

(a) That the engine or vehicle, as designed, built, and equipped at the time of sale, does not conform in all material respects reasonably related to emission controls to the engine as described in the application for certification and covered by the certificate.

(b) A defect in a component's materials or workmanship causes the vehicle or engine to fail to conform to the applicable regulations for its useful life.

### **Subpart F—Test Procedures**

#### **§ 1036.501 General testing provisions.**

(a) Use the equipment and procedures specified in this subpart and 40 CFR part 1065 to determine whether engines meet the emission standards in §§ 1036.104 and 1036.108.

(b) You may use special or alternate procedures to the extent we allow them under 40 CFR 1065.10.

(c) This subpart is addressed to you as a manufacturer, but it applies equally to anyone who does testing for you, and to us when we perform testing to determine if your engines meet emission standards.

(d) For engines that use aftertreatment technology with infrequent regeneration events, apply infrequent regeneration adjustment factors as described in § 1036.522.

(e) Determine engine fuel maps as described in § 1036.503(b).

(f) If your engine is intended for installation in a vehicle equipped with stop-start technology, you may turn the engine off during idle portions of the duty cycle to represent in-use operation. We recommend installing a production engine starter motor and allowing the engine's ECM to manipulate the starter motor to control the engine stop and start events.

#### **§ 1036.503 Engine data and information to support vehicle certification.**

You must give vehicle manufacturers information as follows so they can certify their vehicles to greenhouse gas emission standards under 40 CFR part 1037:

(a) Identify engine make, model, fuel type, combustion type, engine family name, calibration identification, and engine displacement. Also identify whether the engines meet CO<sub>2</sub> standards for tractors, vocational vehicles, or both.

(b) This paragraph (b) describes four different methods to generate engine fuel maps. For engines without hybrid components and for mild hybrid engines where you do not include hybrid components in the test, generate fuel maps using either paragraph (b)(1) or (2) of this section. For other hybrid engines, generate fuel maps using paragraph (b)(3) of this section. For powertrains and for vehicles where the transmission is not automatic, automated manual, manual, or dual-clutch, generate fuel maps using paragraph (b)(4) of this section.

(1) Determine steady-state engine fuel maps as described in § 1036.535(b). Determine fuel consumption at idle as described in § 1036.535(c). Determine cycle-average engine fuel maps as described in § 1036.540, excluding cycle-average fuel maps for highway cruise cycles.

(2) Determine steady-state fuel maps as described in either § 1036.535(b) or (d). Determine fuel consumption at idle as described in § 1036.535(c). Determine cycle-average engine fuel maps as described in § 1036.540, including

cycle-average engine fuel maps for highway cruise cycles. We may do confirmatory testing by creating cycle-average fuel maps from steady-state fuel maps created in paragraph (b)(1) of this section for highway cruise cycles. In § 1036.540 we define the vehicle configurations for testing; we may add more vehicle configurations to better represent your engine's operation for the range of vehicles in which your engines will be installed (see 40 CFR 1065.10(c)(1)).

(3) Determine fuel consumption at idle as described in § 1036.535(c) and (d), and determine cycle-average engine fuel maps as described in 40 CFR 1037.550, including cycle-average engine fuel maps for highway cruise cycles.

(4) Generate powertrain fuel maps as described in 40 CFR 1037.550 instead of fuel mapping under § 1036.535 or § 1036.540. Note that the option in 40 CFR 1037.550(b)(2) is allowed only for hybrid engine testing.

(c) Provide the following information if you generate engine fuel maps using either paragraph (b)(1), (2), or (3) of this section:

(1) Full-load torque curve for installed engines and the full-load torque curve of the engine (parent engine) with the highest fueling rate that shares the same engine hardware, including the turbocharger, as described in 40 CFR 1065.510. You may use 40 CFR 1065.510(b)(5)(i) for Spark-ignition HDE. Measure the torque curve for hybrid engines that have an RESS as described in 40 CFR 1065.510(g)(2) with the hybrid system active. Test hybrid engines with no RESS as described in 40 CFR 1065.510(b)(5)(ii).

(2) Motoring torque curve as described in 40 CFR 1065.510(c)(2) and (5) for conventional and hybrid engines, respectively. For engines with a low-speed governor, remove data points where the low-speed governor is active. If you don't know when the low-speed governor is active, we recommend removing all points below 40 r/min above the warm low-idle speed.

(3) Declared engine idle speed. For vehicles with manual transmissions, this is the engine speed with the transmission in neutral. For all other vehicles, this is the engine's idle speed when the transmission is in drive.

(4) The engine idle speed during the transient cycle-average fuel map.

(5) The engine idle torque during the transient cycle-average fuel map.

(d) If you generate powertrain fuel maps using paragraph (b)(4) of this section, determine the system continuous rated power according to § 1036.527.

**§ 1036.505 Supplemental Emission Test.**

(a) Measure emissions using the steady-state SET duty cycle as described in this section. Note that the SET duty cycle is operated as a ramped-modal cycle rather than discrete steady-state test points.

(b) Perform SET testing with one of the following procedures:

(1) For testing nonhybrid engines, the SET duty cycle is based on normalized speed and torque values relative to certain maximum values. Denormalize speed as described in 40 CFR 1065.512. Denormalize torque as described in 40 CFR 1065.610(d).

(2) Test hybrid engines and hybrid powertrains as described in 40 CFR

1037.550, except as specified in this paragraph (b)(2). Do not compensate the duty cycle for the distance driven as described in 40 CFR 1037.550(g)(4). For hybrid engines, select the transmission from Table 1 of § 1036.540, substituting “engine” for “vehicle” and “highway cruise cycle” for “SET”. Disregard duty cycles in 40 CFR 1037.550(j). For cycles that begin with idle, leave the transmission in neutral or park for the full initial idle segment. Place the transmission into drive no earlier than 5 seconds before the first nonzero vehicle speed setpoint. For SET testing only, place the transmission into park or neutral when the cycle reaches the final

idle segment. Use the following vehicle parameters instead of those in 40 CFR 1037.550 to define the vehicle model in 40 CFR 1037.550(a)(3):

(i) Determine the vehicle test mass,  $M$ , as follows:

$$M = 15.1 \cdot P_{\text{contrated}}^{1.31}$$

Eq. 1036.505-1

Where:

$P_{\text{contrated}}$  = the continuous rated power of the hybrid system determined in § 1036.527.

*Example:*

$P_{\text{contrated}} = 350.1 \text{ kW}$

$M = 15.1 \cdot 350.1^{1.31} = 32499 \text{ kg}$

(ii) Determine the vehicle frontal area,  $A_{\text{front}}$ , as follows:

(A) For  $M \leq 18050$  kg:

$$A_{\text{front}} = -1.69 \cdot 10^{-8} \cdot M^2 + 6.33 \cdot 10^{-4} \cdot M + 1.67$$

Eq. 1036.505-2

*Example:*

$$M = 16499 \text{ kg}$$

$$A_{\text{front}} = -1.69 \cdot 10^{-8} \cdot 16499^2 + 6.33 \cdot 10^{-4} \cdot 16499 + 1.67 = 7.51 \text{ m}^2$$

(B) For  $M > 18050$  kg,  $A_{\text{front}} = 7.59 \text{ m}^2$

(iii) Determine the vehicle drag area,  $C_d A$ , as follows:

$$C_d A = \frac{(0.00299 \cdot A_{\text{front}} - 0.000832) \cdot 2 \cdot g \cdot 3.6^2}{\rho}$$

Eq. 1036.505-3

Where:

$g$  = gravitational constant = 9.80665 m/s<sup>2</sup>.

$\rho$  = air density at reference conditions. Use  $\rho = 1.1845 \text{ kg/m}^3$ .

*Example:*

$$C_d A = \frac{(0.00299 \cdot 7.59 - 0.000832) \cdot 2 \cdot 9.80665 \cdot 3.6^2}{1.1845} = 3.08 \text{ m}^2$$

(iv) Determine the coefficient of rolling resistance,  $C_{\text{rr}}$ , as follows:

$$C_{\text{rr}} = 5.13 + \frac{17600}{M}$$

Eq. 1036.505-4

*Example:*

$$C_{\text{rr}} = 5.13 + \frac{17600}{32499} = 5.7 \text{ N/kN} = 0.0057 \text{ N/N}$$

(v) Determine the vehicle curb mass,  $M_{\text{curb}}$ , as follows:

$$M_{\text{curb}} = -0.000007376537 \cdot M^2 + 0.6038432 \cdot M$$

Eq. 1036.505-5

*Example:*

$$M_{\text{curb}} = -0.000007376537 \cdot 32499^2 + 0.6038432 \cdot 32499 = 11833 \text{ kg}$$

(vi) Determine the linear equivalent mass of rotational moment of inertias,  $M_{\text{rotating}}$ , as follows:

$$M_{\text{rotating}} = 0.07 \cdot M_{\text{curb}}$$

Eq. 1036.505-6

*Example:*

$$M_{\text{rotating}} = 0.07 \cdot 11833 = 828.3 \text{ kg}$$

(vii) Select a drive axle ratio,  $k_a$ , that represents the worst-case combination of final gear ratio, drive axle ratio, and tire size for CO<sub>2</sub> expected for vehicles in which the hybrid powertrain or hybrid engine will be installed. This is typically the highest axle ratio.

(viii) Select a tire radius,  $r$ , that represents the worst-case pair of tire size and drive axle ratio for CO<sub>2</sub> expected for vehicles in which the hybrid powertrain or hybrid engine will be installed. This is typically the smallest tire radius.

(ix) If you are certifying a hybrid engine, use a default transmission efficiency of 0.95 and create the vehicle

model along with its default transmission shift strategy as described in 40 CFR 1037.550(a)(3)(ii). Use the transmission parameters defined in Table 1 of § 1036.540 to determine transmission type and gear ratio. For Light HDV and Medium HDV, use the Light HDV and Medium HDV parameters for FTP, LLC, and SET duty cycles. For Tractors and Heavy HDVs, use the Tractor and Heavy HDV transient cycle parameters for the FTP and LLC duty cycles and the Tractor and Heavy HDV highway cruise cycle parameters for the SET duty cycle.

(c) Measure emissions using the SET duty cycle shown in Table 1 of this section to determine whether engines meet the steady-state compression-

ignition standards specified in subpart B of this part. Table 1 of this section specifies test settings, as follows:

(1) The duty cycle for testing engines (including hybrid engines) involves a schedule of normalized engine speed and torque values.

(2) The duty cycle for testing hybrid powertrains involves a schedule of vehicle speeds and road grade as follows:

(i) Determine road grade at each point based on the continuous rated power of the hybrid powertrain system,  $P_{\text{contrated}}$ , in kW determined in § 1036.527, the vehicle speed (A, B, or C) in mi/hr for a given SET mode,  $v_{\text{ref[ speed]}}$ , and the specified road-grade coefficients using the following equation:

$$\begin{aligned} \text{Roadgrade} = & a \cdot P_{\text{contrated}}^3 + b \cdot P_{\text{contrated}}^2 \cdot v_{\text{ref[ speed]}} + c \cdot P_{\text{contrated}}^2 + d \cdot v_{\text{ref[ speed]}}^2 \\ & + e \cdot P_{\text{contrated}} \cdot v_{\text{ref[ speed]}} + f \cdot P_{\text{contrated}} + g \cdot v_{\text{ref[ speed]}} + h \end{aligned}$$

Eq. 1036.505-7

*Example for SET mode 3a in Table 1 of this section:*

$$P_{\text{contrated}} = 345.2 \text{ kW}$$

$$v_{\text{refB}} = 59.3 \text{ mi/hr}$$

$$\begin{aligned} \text{Road grade} = & 8.296 \cdot 10^{-9} \cdot 345.2^3 + \\ & (-4.752 \cdot 10^{-7}) \cdot 345.2^2 \cdot 59.3 + \\ & 1.291 \cdot 10^{-5} + 2.88 \cdot 10^{-4} \cdot 59.3^2 \\ & + 4.524 \cdot 10^{-4} \cdot 345.2 \cdot 59.3 + \\ & (-1.802 \cdot 10^{-2}) \cdot 345.2 + (-1.83 \cdot \\ & 10^{-1}) \cdot 59.3 + 8.81 = 0.53\% \end{aligned}$$

(ii) Use the vehicle C speed determined in § 1036.527. Determine vehicle A and B speeds as follows:

(A) Determine vehicle A speed using the following equation:

$$v_{\text{refA}} = v_{\text{refC}} \cdot \frac{55.0}{75.0}$$

Eq. 1036.505-8

*Example:*

$$v_{\text{refC}} = 68.42 \text{ mi/hr}$$

$$v_{\text{refA}} = 68.4 \cdot \frac{55.0}{75.0} = 50.2 \text{ mi/hr}$$

(B) Determine vehicle B speed using the following equation:

$$v_{\text{refB}} = v_{\text{refC}} \cdot \frac{65.0}{75.0}$$

Eq. 1036.505-9

*Example:*

$$v_{\text{refB}} = 68.4 \cdot \frac{65.0}{75.0} = 59.3 \text{ mi/hr}$$

(3) Table 1 follows:



TABLE 1 TO PARAGRAPH (c)(3) OF § 1036.505—SUPPLEMENTAL EMISSION TEST

SET mode	Engine testing			Hybrid powertrain testing									
	Time in mode (seconds)	Engine speed <sup>a,b</sup>	Torque (percent) <sup>b,c</sup>	Vehicle speed (mi/hr)	a	b	c	d	e	f	g	h	
1a Steady-state	124	Warm Idle	0	0	-1.898E-08	-5.895E-07	3.780E-05	4.706E-03	6.550E-04	0	-2.679E-02	0	
1b Transition	20	Linear Transition	Linear Transition	Linear Transition	Linear Transition	Linear Transition	Linear Transition	Linear Transition	Linear Transition	Linear Transition	Linear Transition	Linear Transition	
2a Steady-state	196	A	100	$v_{relA}$	-1.227E-08	-5.504E-07	3.946E-05	1.212E-03	5.289E-04	0	-3.116E-02	0	
2b Transition	20	Linear Transition	Linear Transition	Linear Transition	Linear Transition	Linear Transition	Linear Transition	Linear Transition	Linear Transition	Linear Transition	Linear Transition	Linear Transition	
3a Steady-state	220	B	50	$v_{relB}$	8.296E-09	-4.752E-07	1.291E-05	2.880E-04	4.524E-04	0	-1.802E-02	0	
3b Transition	20	B	Linear Transition	Linear Transition	Linear Transition	Linear Transition	Linear Transition	Linear Transition	Linear Transition	Linear Transition	Linear Transition	Linear Transition	
4a Steady-state	220	B	75	$v_{relB}$	1.818E-10	-5.229E-07	2.579E-05	5.575E-04	5.006E-04	0	-2.561E-02	0	
4b Transition	20	Linear Transition	Linear Transition	Linear Transition	Linear Transition	Linear Transition	Linear Transition	Linear Transition	Linear Transition	Linear Transition	Linear Transition	Linear Transition	
5a Steady-state	268	A	50	$v_{relA}$	3.973E-09	-4.362E-07	1.365E-05	4.846E-04	4.158E-04	0	-1.606E-02	0	
5b Transition	20	A	Linear Transition	Linear Transition	Linear Transition	Linear Transition	Linear Transition	Linear Transition	Linear Transition	Linear Transition	Linear Transition	Linear Transition	
6a Steady-state	268	A	75	$v_{relA}$	-4.216E-09	-4.891E-07	2.641E-05	8.796E-04	4.692E-04	0	-2.348E-02	0	
6b Transition	20	A	Linear Transition	Linear Transition	Linear Transition	Linear Transition	Linear Transition	Linear Transition	Linear Transition	Linear Transition	Linear Transition	Linear Transition	
7a Steady-state	268	A	25	$v_{relA}$	1.211E-08	-3.772E-07	6.209E-07	1.202E-04	3.578E-04	0	-8.420E-03	0	
7b Transition	20	Linear Transition	Linear Transition	Linear Transition	Linear Transition	Linear Transition	Linear Transition	Linear Transition	Linear Transition	Linear Transition	Linear Transition	Linear Transition	
8a Steady-state	196	B	100	$v_{relB}$	-8.232E-09	-5.707E-07	3.900E-05	8.150E-04	5.477E-04	0	-3.325E-02	0	
8b Transition	20	B	Linear Transition	Linear Transition	Linear Transition	Linear Transition	Linear Transition	Linear Transition	Linear Transition	Linear Transition	Linear Transition	Linear Transition	
9a Steady-state	196	B	25	$v_{relB}$	1.662E-08	-4.261E-07	-2.705E-07	2.098E-05	4.046E-04	0	-1.037E-02	0	
9b Transition	20	Linear Transition	Linear Transition	Linear Transition	Linear Transition	Linear Transition	Linear Transition	Linear Transition	Linear Transition	Linear Transition	Linear Transition	Linear Transition	
10a Steady-state	28	C	100	$v_{relC}$	-1.073E-09	-5.904E-07	3.477E-05	5.069E-04	5.647E-04	0	-3.354E-02	0	
10b Transition	20	C	Linear Transition	Linear Transition	Linear Transition	Linear Transition	Linear Transition	Linear Transition	Linear Transition	Linear Transition	Linear Transition	Linear Transition	
11a Steady-state	4	C	25	$v_{relC}$	1.916E-08	-5.023E-07	3.715E-06	3.634E-05	4.706E-04	0	-1.539E-02	0	
11b Transition	20	C	Linear Transition	Linear Transition	Linear Transition	Linear Transition	Linear Transition	Linear Transition	Linear Transition	Linear Transition	Linear Transition	Linear Transition	
12a Steady-state	4	C	75	$v_{relC}$	6.167E-09	-5.577E-07	2.354E-05	3.524E-04	5.319E-04	0	-2.708E-02	0	
12b Transition	20	C	Linear Transition	Linear Transition	Linear Transition	Linear Transition	Linear Transition	Linear Transition	Linear Transition	Linear Transition	Linear Transition	Linear Transition	
13a Steady-state	4	C	50	$v_{relC}$	6.209E-09	-5.292E-07	2.126E-05	3.475E-04	5.132E-04	0	-2.552E-02	0	
13b Transition	20	Linear Transition	Linear Transition	Linear Transition	Linear Transition	Linear Transition	Linear Transition	Linear Transition	Linear Transition	Linear Transition	Linear Transition	Linear Transition	
14 Steady-state	144	Warm Idle	0	0	0	0	0	0	0	0	0	0	

<sup>a</sup> Engine speed terms are defined in 40 CFR part 1065.  
<sup>b</sup> Advance from one mode to the next within a 20 second transition phase. During the transition phase, command a linear progression from the settings of the current mode to the settings of the next mode.  
<sup>c</sup> The percent torque is relative to maximum torque at the commanded engine speed.

(d) Determine criteria pollutant emissions for plug-in hybrid engines and powertrains as follows:

- (1) Precondition the engine or powertrain in charge-sustaining mode. Perform testing as described in this section for hybrid engines and hybrid powertrains in charge-sustaining mode.
- (2) Carry out a charge-depleting test as described in paragraph (d)(1) of this section, except as follows:

- (i) Fully charge the RESS after preconditioning.
- (ii) Operate the hybrid engine or powertrain continuously over repeated SET duty cycles until you reach the end-of-test criterion defined in 40 CFR 1066.501(a)(3).
- (iii) Calculate emission results for each SET duty cycle. Figure 1 of this section provides an example of a charge-depleting test sequence where there are

two test intervals that contain engine operation.

- (3) Report the highest emission result for each criteria pollutant from all tests in paragraphs (d)(1) and (2) of this section, even if those individual results come from different test intervals.
- (4) Figure 1 follows:

Figure 1 to paragraph (d)(4) of § 1036.505—SET charge-depleting criteria pollutant test sequence.

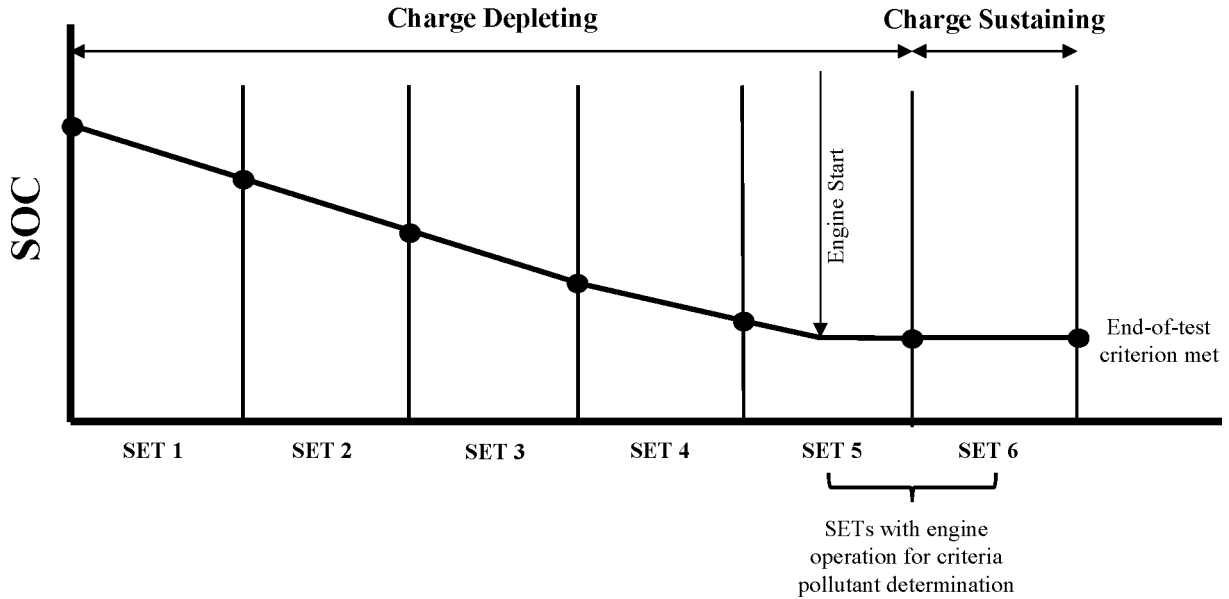

(e) Determine greenhouse gas pollutant emissions for plug-in hybrid engines and powertrains using the emissions results for all the SET test

intervals for both charge-depleting and charge-sustaining operation from paragraph (d)(2) of this section. Calculate the utility factor-weighted

composite mass of emissions from the charge-depleting and charge-sustaining test results,  $e_{UF[emission]comp}$ , using the following equation:

$$e_{UF[emission]comp} = \frac{\sum_{i=1}^N [e_{[emission][int]CDi} \cdot (UF_{DCDi} - UF_{DCDi-1})] + \sum_{j=1}^M [e_{[emission][int]CSj}]}{(1 - UF_{RCD}) \cdot M}$$

Eq. 1036.505-10

Where:

$i$  = an indexing variable that represents one test interval.

$N$  = total number of charge-depleting test intervals.

$e_{[emission][int]CDi}$  = total mass of emissions in the charge-depleting portion of the test for each test interval,  $i$ , starting from  $i = 1$ , including the test interval(s) from the transition phase.

$UF_{DCDi}$  = utility factor fraction at distance  $DCDi$  from Eq. 1036.505-11, as determined by interpolating the approved utility factor curve for each test

interval,  $i$ , starting from  $i = 1$ . Let  $UF_{DCD0} = 0$ .

$j$  = an indexing variable that represents one test interval.

$M$  = total number of charge-sustaining test intervals.

$e_{[emission][int]CSj}$  = total mass of emissions in the charge-sustaining portion of the test for each test interval,  $j$ , starting from  $j = 1$ .

$UF_{RCD}$  = utility factor fraction at the full charge-depleting distance, RCD, as determined by interpolating the approved utility factor curve. RCD is the cumulative distance driven over  $N$  charge-depleting test intervals.

$$D_{CDi} = \sum_{k=1}^Q (v_k \cdot \Delta t)$$

Eq. 1036.505-11

Where:

$k$  = an indexing variable that represents one recorded velocity value.

$Q$  = total number of measurements over the test interval.

$v$  = vehicle velocity at each time step,  $k$ , starting from  $k = 1$ . For tests completed under this section,  $v$  is the vehicle

velocity from the vehicle model in 40 CFR 1037.550. Note that this should include charge-depleting test intervals that start when the engine is not yet operating.

$$\Delta t = 1/f_{\text{record}}$$

$f_{\text{record}}$  = the record rate.

*Example using the charge-depletion test in Figure 1 of § 1036.505 for the SET for CO<sub>2</sub> emission determination:*

$$Q = 24000$$

$$v_1 = 0 \text{ mi/hr}$$

$$v_2 = 0.8 \text{ mi/hr}$$

$$v_3 = 1.1 \text{ mi/hr}$$

$$f_{\text{record}} = 10 \text{ Hz}$$

$$\Delta t = 1/10 \text{ Hz} = 0.1 \text{ s}$$

$$D_{\text{CD}1} = \sum_{k=1}^{24000} (0 \cdot 0.1 + 0.8 \cdot 0.1 + 1.1 \cdot 0.1 + v_{24000} \cdot \Delta t) = 30.1 \text{ mi}$$

$$D_{\text{CD}2} = 30.0 \text{ mi}$$

$$D_{\text{CD}3} = 30.1 \text{ mi}$$

$$D_{\text{CD}4} = 30.2 \text{ mi}$$

$$D_{\text{CD}5} = 30.1 \text{ mi}$$

$$N = 5$$

$$UF_{\text{DCD}1} = 0.11$$

$$UF_{\text{DCD}2} = 0.23$$

$$UF_{\text{DCD}3} = 0.34$$

$$UF_{\text{DCD}4} = 0.45$$

$$UF_{\text{DCD}5} = 0.53$$

$$e_{\text{CO}2\text{SETCD}1} = 0 \text{ g/hp}\cdot\text{hr}$$

$$e_{\text{CO}2\text{SETCD}2} = 0 \text{ g/hp}\cdot\text{hr}$$

$$e_{\text{CO}2\text{SETCD}3} = 0 \text{ g/hp}\cdot\text{hr}$$

$$e_{\text{CO}2\text{SETCD}4} = 0 \text{ g/hp}\cdot\text{hr}$$

$$e_{\text{CO}2\text{SETCD}5} = 174.4 \text{ g/hp}\cdot\text{hr}$$

$$M = 1$$

$$e_{\text{CO}2\text{SETCS}} = 428.1 \text{ g/hp}\cdot\text{hr}$$

$$UF_{\text{RCD}} = 0.53$$

$$e_{\text{UFCO}2\text{comp}} = [0 \cdot (0.11 - 0) + 0 \cdot (0.23 - 0.11) + 0 \cdot (0.34 - 0.23) + 0 \cdot (0.45 - 0.34) + 174.4 \cdot (0.53 - 0.45)] + 428.1 \cdot \frac{(1 - 0.53)}{1} = 215.2 \text{ g/hp}\cdot\text{hr}$$

(f) Calculate and evaluate cycle statistics as specified in 40 CFR 1065.514 for nonhybrid engines and 40 CFR 1037.550 for hybrid engines and hybrid powertrains.

(g) Calculate cycle work for powertrain testing using system power,  $P_{\text{sys}}$ . Determine  $P_{\text{sys}}$ , using § 1036.527(e).

(h) If you certify to the clean idle standard in § 1036.104(b), determine the mean mass emission rate,  $\overline{m}_{\text{[emission]}}$ , in g/hr over the combined warm idle modes 1a and 14 of the SET duty cycle for HC, CO, and PM by calculating the total emission mass  $m_{\text{[emission]}}$  and dividing by the total time. Note that this requires creating composite emission values from separate samples for CO and PM. These values for  $\overline{m}_{\text{[emission]}}$  serve as emission standards for testing over the Clean Idle test in § 1036.514. (Note: For plug-in hybrid engines and powertrains, use the SET results from the charge-sustaining or charge-depleting tests that have the highest emission values.)

#### § 1036.510 Federal Test Procedure.

(a) Measure emissions using the transient Federal Test Procedure (FTP) as described in this section to determine whether engines meet the emission standards in subpart B of this part.

Operate the engine or hybrid powertrain over one of the following transient duty cycles:

(1) For engines subject to spark-ignition standards, use the transient duty cycle described in paragraph (b) of appendix B of this part.

(2) For engines subject to compression-ignition standards, use the transient duty cycle described in paragraph (c) of appendix B of this part.

(b) The following procedures apply differently for testing engines and hybrid powertrains:

(1) The transient duty cycles for nonhybrid engine testing are based on normalized speed and torque values. Denormalize speed as described in 40 CFR 1065.512. Denormalize torque as described in 40 CFR 1065.610(d).

(2) Test hybrid engines and hybrid powertrains as described in § 1036.505(b)(2), with the following exceptions:

(i) Replace  $P_{\text{contrated}}$  with  $P_{\text{rated}}$ , which is the peak rated power determined in § 1036.527.

(ii) Keep the transmission in drive for all idle segments after the initial idle segment.

(iii) For hybrid engines, select the transmission from Table 1 of § 1036.540, substituting “engine” for “vehicle”.

(iv) For hybrid engines, you may request to change the engine-commanded torque at idle to better represent curb idle transmission torque (CITT).

(v) For plug-in hybrid engines and powertrains, test over the FTP in both charge-sustaining and charge-depleting operation for both criteria and greenhouse gas pollutant determination.

(c) The FTP duty cycle consists of an initial run through the transient duty cycle from a cold start as described in 40 CFR part 1065, subpart F, followed by a (20 ± 1) minute hot soak with no engine operation, and then a final hot start run through the same transient duty cycle. Engine starting is part of both the cold-start and hot-start test intervals. Calculate the total emission mass of each constituent,  $m$ , and the total work,  $W$ , over each test interval as described in 40 CFR 1065.650. Calculate total work over each test interval for powertrain testing using system power,  $P_{\text{sys}}$ . Determine  $P_{\text{sys}}$  using § 1036.527(e). For powertrains with automatic transmissions, account for and include the work produced by the engine from the CITT load. Calculate the official transient emission result from the cold-start and hot-start test intervals using the following equation:

$$\text{Official transient emission result} = \frac{\text{cold start emissions (g)} + 6 \cdot \text{hot start emissions (g)}}{\text{cold start work (hp}\cdot\text{hr)} + 6 \cdot \text{hot start work (hp}\cdot\text{hr)}}$$

Eq. 1036.510-1

(d) Determine criteria pollutant emissions for plug-in hybrid engines and powertrains as follows:

(1) Precondition the engine or powertrain in charge-sustaining mode. Perform testing as described in this section for hybrid engines and hybrid powertrains in charge-sustaining mode.

(2) Carry out a charge-depleting test as described in paragraph (d)(1) of this section, except as follows:

(i) Fully charge the battery after preconditioning.

(ii) Operate the hybrid engine or powertrain over one FTP duty cycle followed by alternating repeats of a 20-minute soak and a hot start test interval until you reach the end-of-test criteria defined in 40 CFR 1066.501.

(iii) Calculate emission results for each successive pair of test intervals. Calculate the emission result by treating the first of the two test intervals as a

cold-start test. Figure 1 of this section provides an example of a charge-depleting test sequence where there are three test intervals with engine operation for two overlapping FTP duty cycles.

(3) Report the highest emission result for each criteria pollutant from all tests in paragraphs (d)(1) and (2) of this section, even if those individual results come from different test intervals.

(4) Figure 1 follows:

Figure 1 to paragraph (d)(4) of § 1036.510—FTP charge-depleting criteria pollutant test sequence.

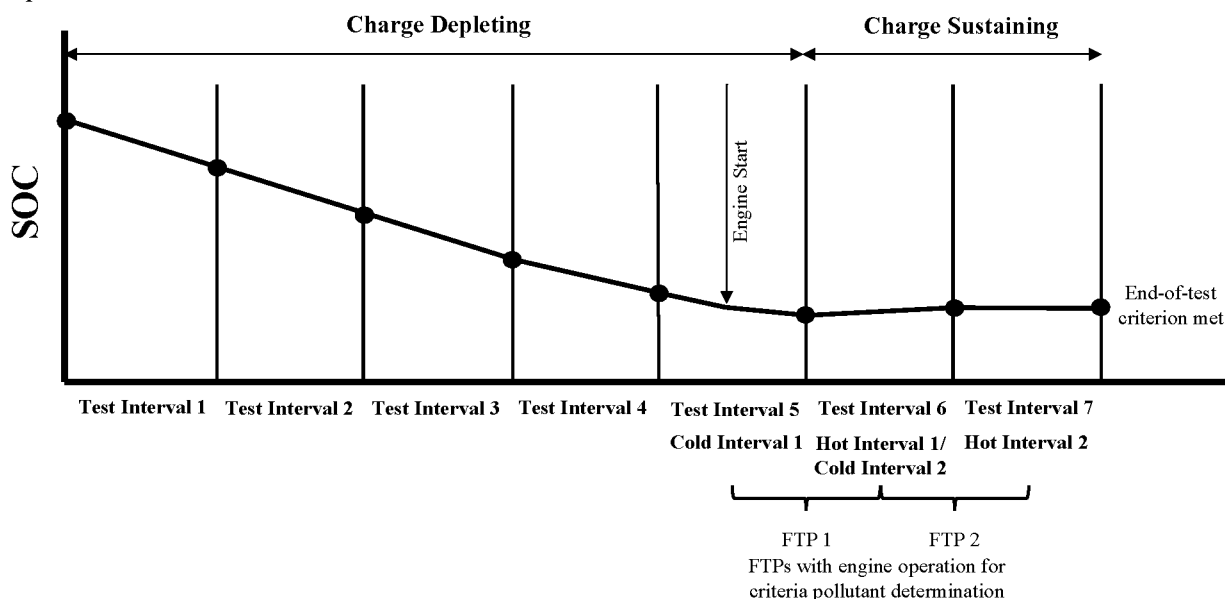

(e) Determine greenhouse gas pollutant emissions for plug-in hybrid engines and powertrains using the emissions results for all the transient duty cycle test intervals described in either paragraph (b) or (c) of appendix B of this part for both charge-depleting and charge-sustaining operation from paragraph (d)(2) of this section. Calculate the utility factor weighted composite mass of emissions from the charge-depleting and charge-sustaining test results,  $e_{UF[emission]comp}$ , as described in § 1036.505(e), replacing occurrences of “SET” with “transient test interval”. Note this results in composite FTP GHG emission results for plug-in hybrid engines and powertrains without the use of the cold-start and hot-start test interval weighting factors in Eq. 1036.510–1.

(f) Calculate and evaluate cycle statistics as specified in 40 CFR 1065.514 for nonhybrid engines and 40 CFR 1037.550 for hybrid engines and hybrid powertrains.

(g) If you certify to the clean idle standard in § 1036.104(b), determine the

mean mass emission rate,  $\bar{m}_{[emission]}$ , in g/hr over the idle segments of the FTP duty cycle for HC, CO, and PM by calculating the total emission mass  $m_{[emission]}$  and dividing by the total time. Note that this requires creating composite emission values from separate samples for CO and PM. These values for  $\bar{m}_{[emission]}$  serve as emission standards for testing over the Clean Idle test in § 1036.514. (Note: For plug-in hybrid engines and powertrains, use the FTP results from the charge-sustaining or charge-depleting tests that have the highest emission values.)

#### § 1036.512 Low Load Cycle.

(a) Measure emissions using the transient Low Load Cycle (LLC) as described in this section to determine whether engines meet the LLC emission standards in § 1036.104.

(b) The operating profile for the LLC is in paragraph (d) of appendix B of this part. The following procedures apply differently for testing engines and hybrid powertrains:

(1) For engine testing, the duty cycle is based on normalized speed and torque values.

(i) Denormalize speed as described in 40 CFR 1065.512. Denormalize torque as described in 40 CFR 1065.610(d).

(ii) For idle segments more than 200 seconds, set reference torques to zero instead of CITT. This is to represent shifting the transmission to park or neutral at the start of the idle segment. Change the reference torque to CITT no earlier than 5 seconds before the end of the idle segment. This is to represent shifting the transmission to drive.

(2) Test hybrid powertrains as described in § 1036.505(b)(2), with the following exceptions:

(i) Replace  $P_{contrated}$  with  $P_{rated}$ , which is the peak rated power determined in § 1036.527.

(ii) Keep the transmission in drive for all idle segments 200 seconds or less. For idle segments more than 200 seconds, place the transmission in park or neutral at the start of the idle segment and place the transmission into drive

again no earlier than 5 seconds before the first nonzero vehicle speed setpoint.

(3) For gaseous-fueled engine testing with a single-point fuel injection system, you may apply all the statistical criteria in § 1036.540(d)(3) to validate the LLC.

(c) Set dynamometer torque demand such that vehicle power represents an accessory load for all idle operation as described in Table 1 of paragraph (c)(4) of this section for each primary intended service class. Additional provisions related to accessory load apply for the following special cases:

(1) For engines with stop-start technology, account for accessory load during engine-off conditions by determining the total engine-off power demand over the test interval and distributing that load over the engine-on portions of the test interval based on calculated average power. You may determine the engine-off time by running practice cycles or through engineering analysis.

(2) Apply accessory loads for hybrid powertrain testing that includes the transmission either as a mechanical or electrical load.

(3) You may apply the following deviations from specified torque settings for smoother idle (other than idle that includes motoring), or you may develop different procedures for adjusting accessory load at idle consistent with good engineering judgment:

(i) Set the reference torque to correspond to the applicable accessory load for all points with normalized speed at or below zero percent and reference torque from zero up to the torque corresponding to the accessory load.

(ii) Change the reference torques to correspond to the applicable accessory load for consecutive points with reference torques from zero up to the torque corresponding to the accessory load that immediately precedes or follows idle points.

(4) Table 1 follows:

TABLE 1 TO PARAGRAPH (C)(4) OF § 1036.512—ACCESSORY LOAD AT IDLE

Primary intended service class	Power representing accessory load (kW)
Light HDE .....	1.5
Medium HDE .....	2.5
Heavy HDE .....	3.5

(d) The transient test sequence consists of preconditioning the engine by running one or two FTPs with each FTP followed by (20 ±1) minutes with

no engine operation and running the LLC. You may start any preconditioning FTP with a hot engine. Perform testing as described in 40 CFR 1065.530 for a test interval that includes engine starting. Calculate the total emission mass of each constituent, *m*, and the total work, *W*, as described in 40 CFR 1065.650.

(e) Determine criteria pollutant and greenhouse gas emissions for plug-in hybrid engines and powertrains as described in § 1036.505(d) and (e), replacing “SET” with “LLC”.

(f) Calculate and evaluate cycle statistics as specified in 40 CFR 1065.514 for nonhybrid engines and 40 CFR 1037.550 for hybrid engines and hybrid powertrains.

**§ 1036.514 Clean Idle test.**

Measure emissions using the procedures described in this section to determine whether engines and hybrid powertrains meet the clean idle emission standards in § 1036.104(b). For plug-in hybrid engines and powertrains, perform the test with the hybrid function disabled.

(a) The clean idle test consists of two separate test intervals as follows:

(1) Mode 1 consists of engine operation with a speed setpoint at your recommended warm idle speed. Set the dynamometer torque demand corresponding to vehicle power requirements at your recommended warm idle speed that represent in-use operation.

(2) Mode 2 consists of engine operation with a speed setpoint at 1100 r/min. Set the dynamometer torque demand to account for the sum of the following power loads:

(i) Determine power requirements for idling at 1100 r/min.

(ii) Apply a power demand of 2 kW to account for appliances and accessories the vehicle operator may use during rest periods.

(3) Determine torque demand for testing under this paragraph (a) based on an accessory load that includes the engine cooling fan, alternator, coolant pump, air compressor, engine oil and fuel pumps, and any other engine accessory that operates at the specific test condition. Also include the accessory load from the air conditioning compressor operating at full capacity for Mode 2. Do not include any other load for air conditioning or other cab or vehicle accessories except as specified.

(b) Perform the Clean Idle test as follows:

(1) Warm up the engine by operating it over the FTP or SET duty cycle, or by operating it at any speed above peak-torque speed and at (65 to 85) % of

maximum mapped power. The warm-up is complete when the engine thermostat controls engine temperature or when the engine coolant’s temperature is within 2% of its mean value for at least 2 minutes.

(2) Start operating the engine in Mode 1 as soon as practical after the engine warm-up is complete.

(3) Start sampling emissions 10 minutes after reaching the speed and torque setpoints and continue emission sampling and engine operation at those setpoints. Stop emission sampling after 1200 seconds to complete the test interval.

(4) Linearly ramp the speed and torque setpoints over 5 seconds to start operating the engine in Mode 2. Sample emissions during Mode 2 as described in paragraph (b)(3) of this section.

(c) Verify that the test speed stays within ±50 r/min of the speed setpoint throughout the test. The torque tolerance is ±2 percent of the maximum mapped torque at the test speed. Verify that measured torque meets the torque tolerance relative to the torque setpoint throughout the test.

(d) Calculate the mean mass emission rate of NO<sub>x</sub>, HC, CO, and PM,  $\overline{m}_{[emission]}$  over each test interval by calculating the total emission mass  $m_{[emission]}$  and dividing by the total time.

**§ 1036.515 Test procedures for off-cycle testing.**

(a) *General.* This section describes the measurement and calculation procedures to perform field testing under subpart E of this part. Use good engineering judgment if you use these procedures to simulate vehicle operation in the laboratory.

(b) *Emission measurement.* Set up the vehicle for testing with a portable emissions measurement system (PEMS) as specified in 40 CFR part 1065, subpart J. Measure emissions over one or more shift-days as specified in subpart E of this part. Collect data using moving average windows as follows:

(1) Start the engine at the beginning of the shift-day only after confirming that engine coolant temperature is at or below 30 °C and that all measurement systems are activated as described in 40 CFR 1065.935(c)(3). Start emission sampling just before starting the engine.

(2) Determine the test interval as follows:

(i) For Light HDE, Medium HDE, and Heavy HDE, establish a test interval for every 300 second moving average window until key-off. Create each new window starting 1 second after the start of the previous window. Note that most 1 Hz data points will be included in 300 windows.

(ii) For Spark-ignition HDE, your test interval is the entire shift-day except for data excluded under paragraph (c) of this section.

(3) For Light HDE, Medium HDE, and Heavy HDE, create windows as follows if you exclude data under paragraph (c) of this section:

(i) For excluded blocks of data that are less than 300 seconds long, create 300 second moving average windows that include operation before and after the excluded portion. The resulting windows might include multiple interruptions less than 300 seconds long that may total more than 300 seconds.

(ii) For excluded blocks of data that are 300 seconds or longer, discontinue windows at the start of the excluded portion. Create new 300 second moving average windows following the excluded portion, like at the start of the shift-day.

(c) *Exclusions.* Exclude the following shift-day data:

(1) Data collected during the PEMS zero and span drift checks or zero and span calibrations. Emissions analyzers are not available to measure emissions during that time and these checks/

calibrations are needed to ensure the robustness of the data.

(2) Data collected where the engine is off, including engine off due to automated start/stop.

(3) Data collected during infrequent regeneration events. The data collected for the test order may not collect enough operation during the infrequent regeneration to properly weight the emissions rates during an infrequent regeneration event with emissions that occur without an infrequent regeneration event.

(4) Data collected where the instantaneous ambient air temperature is below  $-7\text{ }^\circ\text{C}$  or above the value in degrees Celsius calculated using Eq. 1036.515-1. Colder temperatures can significantly inhibit the engine's ability to maintain aftertreatment temperature above the minimum operating temperature of the SCR catalyst while high temperature conditions at altitude can adversely affect (limit) the mass airflow through the engine, which can affect the engine's ability to reduce engine out  $\text{NO}_x$  through the use of EGR. In addition to affecting EGR, the air-fuel ratio of the engine can decrease under high load, which can increase exhaust

temperatures above the condition where the SCR catalyst is most efficient at reducing  $\text{NO}_x$ .

$$T_{\text{invalid}} = -0.0014 \cdot h + 37.778$$

Eq. 1036.515-1

Where:

$h$  = instantaneous altitude in feet above sea level ( $h$  is negative for altitudes below sea-level).

(5) Data collected where the altitude more than 5,500 feet above sea level for the same reasons given for the high temperature at altitude exclusion in paragraph (c)(4) of this section.

(6) If your engine family includes engines with one or more approved AECs for emergency vehicle applications under § 1036.115(h)(4), any data where these AECs are active because the engines are allowed to exceed the emission standards when these AECs are active. Do not exclude data for any other AECs.

(d) *Mean mass percent of  $\text{CO}_2$  from normalized  $\text{CO}_2$  rate.* For Light HDE, Medium HDE, and Heavy HDE, determine the mean mass percent of  $\text{CO}_2$  of a window,  $\bar{w}_{\text{CO}_2\text{win}}$ , using the following equation:

$$\bar{w}_{\text{CO}_2\text{win}} = \frac{\bar{m}_{\text{CO}_2\text{win}}}{\dot{m}_{\text{CO}_2\text{max}}}$$

Eq. 1036.515-2

Where:

$\bar{m}_{\text{CO}_2\text{win}}$  = mean mass rate of  $\text{CO}_2$  over the valid window.

$$\dot{m}_{\text{CO}_2\text{max}} = e_{\text{CO}_2\text{FTPFL}} \cdot P_{\text{max}}$$

$e_{\text{CO}_2\text{FTPFL}}$  = the engine's FTP FCL  $\text{CO}_2$  emission value.

$P_{\text{max}}$  = the engine family's maximum power determined according to the torque mapping test procedure defined in 40 CFR 1065.510.

*Example:*

$$\bar{m}_{\text{CO}_2\text{win}} = 13.16 \text{ g/s} = 47368 \text{ g/hr}$$

$$e_{\text{CO}_2\text{FTPFL}} = 428.2 \text{ g/hp}\cdot\text{hr}$$

$$P_{\text{max}} = 406.5 \text{ hp}$$

$$\dot{m}_{\text{CO}_2\text{max}} = 428.2 \cdot 406.5 = 174063 \text{ g/hr}$$

$$\dot{m}_{\text{CO}_2\text{max}} = 428.2 \cdot 406.5 = 174063 \text{ g/hr}$$

$$\bar{w}_{\text{CO}_2\text{win}} = \frac{47368}{174063} = 0.272 = 27.2 \%$$

(e) *Binning.* For Light HDE, Medium HDE, and Heavy HDE, segregate test results from each 300 second window over the shift-day based on its mean mass percent of  $\text{CO}_2$  into one of the following bins:

TABLE 1 TO PARAGRAPH (e) OF § 1036.515—CRITERIA FOR OFF-CYCLE BIN TYPES

Bin	Mean mass percent of $\text{CO}_2$
Idle .....	$\bar{w}_{\text{CO}_2\text{win}} \leq 6\%$ .
Low load .....	$6\% < \bar{w}_{\text{CO}_2\text{win}} \leq 20\%$ .
Medium/high load .....	$\bar{w}_{\text{CO}_2\text{win}} > 20\%$ .

(f) *Window emission values.* For Light HDE, Medium HDE, and Heavy HDE, determine the emission mass for a given window,  $m_{[\text{emission}]\text{win}}$ , for  $\text{CO}_2$  and other measured emissions using the following equation:

$$m_{[\text{emission}]_{\text{win}}} = \sum_{i=1}^N \dot{m}_{[\text{emission}]_i} \cdot \Delta t$$

Eq. 1036.515-3

Where:

$i$  = an indexing variable that represents one recorded emission value.

$N$  = total number of measurements in the window.

$\dot{m}_{[\text{emission}]}$  = mass emission rate at a point in time within a given window.

$\Delta t = 1/f_{\text{record}}$

$f_{\text{record}}$  = the record rate.

*Example:*

$N = 300$

$\dot{m}_{\text{NOx1}} = 0.0179 \text{ g/s}$

$\dot{m}_{\text{NOx2}} = 0.0181 \text{ g/s}$

$f_{\text{record}} = 1 \text{ Hz}$

$\Delta t = 1/1 \text{ Hz} = 1 \text{ s}$

$m_{\text{NOxwin}} = (0.0179 + 0.0181 + \dots + \dot{m}_{\text{NOx300}}) \cdot 1 = 5.46 \text{ g}$

(g) *Bin emission values.* For Light HDE, Medium HDE, and Heavy HDE, determine the emission value for each bin, which may include measurement windows from multiple vehicles.

(1) Determine the sum of the  $\text{NO}_x$  emissions from each window for the idle bin,  $e_{\text{NOxidle}}$ , using the following equation:

$$e_{\text{NOxidle}} = \frac{\sum_{i=1}^N m_{\text{NOxidlewin}i}}{\sum_{i=1}^N t_i}$$

Eq. 1036.515-4

Where:

$i$  = an indexing variable that represents one window.

$N$  = total number of windows in the bin.

$m_{\text{NOxidlewin}}$  = total mass of  $\text{NO}_x$  emissions for a given window as determined in paragraph (f) of this section.

$t_i$  = duration for a given window = 300 seconds.

*Example:*

$N = 10114$

$m_{\text{NOxidlewin1}} = 0.021 \text{ g}$

$m_{\text{NOxidlewin2}} = 0.025 \text{ g}$

$t_1 = 300 \text{ s}$

$t_2 = 300 \text{ s}$

$$e_{\text{NOxidle}} = \frac{(0.021 + 0.025 + \dots + m_{\text{NOxmediumhighloadwin10114}})}{(300 + 300 \dots + t_{10114})} = 0.000285 \text{ g/s} = 1.026 \text{ g/hr}$$

(2) Determine the sum of mass emissions from each window over the sum of  $\text{CO}_2$  emissions from each

window for the low load and medium high load bins,  $e_{\text{sos}[\text{emission}][\text{bin}]}$ , for each

measured pollutant using the following equation:

$$e_{\text{sos}[\text{emission}][\text{bin}]} = \frac{\sum_{i=1}^N m_{[\text{emission}][\text{bin}]_{\text{win}i}}}{\sum_{i=1}^N m_{\text{CO2}[\text{bin}]_{\text{win}i}}} \cdot e_{\text{CO2FTPFL}}$$

Eq. 1036.515-5

Where:

$i$  = an indexing variable that represents mass emissions from one window.

$N$  = total number of windows in the bin.

$m_{[\text{emission}][\text{bin}]_{\text{win}}}$  = sum of mass for each emission for a given window and bin as determined in paragraph (f) of this section.

$m_{\text{CO2}[\text{bin}]_{\text{win}}}$  = sum of mass for  $\text{CO}_2$  for a given window and bin as determined in paragraph (f) of this section.

$e_{\text{CO2FTPFL}}$  = the FCL value for  $\text{CO}_2$  emissions over the FTP duty cycle identified in the engine family's application for certification.

*Example:*

$N = 15439$

$m_{\text{NOxmediumhighloadwin1}} = 0.546 \text{ g}$

$m_{\text{NOxmediumhighloadwin2}} = 0.549 \text{ g}$

$m_{\text{CO2mediumhighloadwin1}} = 10950.2 \text{ g}$

$m_{\text{CO2mediumhighloadwin2}} = 10961.3 \text{ g}$

$e_{\text{CO2 FTPFL}} = 428.1 \text{ g/hp-hr}$

$$e_{\text{sosNOxmediumhighload}} = \frac{(0.546 + 0.549 + \dots + m_{\text{NOxmediumhighloadwin15439}})}{(10950.2 + 10961.3 \dots + m_{\text{CO2mediumhighloadwin15439}})} \cdot 428.1$$

$$= 0.026 \text{ g/hp} \cdot \text{hr}$$

(h) *Shift-day emission values for spark-ignition engines.* For spark-

ignition engines, determine the shift-day emission values as follows:

(1) Determine the emission mass for a shift-day,  $m_{[\text{emission}]_{\text{shift}}}$ , for each

measured pollutant and  $\text{CO}_2$  using the following equation:

$$m_{[\text{emission}]_{\text{shift}}} = \sum_{i=1}^N \dot{m}_{[\text{emission}]_i} \cdot \Delta t$$

Eq. 1036.515-6

Where:

$i$  = an indexing variable that represents one recorded emission value.

$N$  = total number of measurements in the shift-day.

$\dot{m}_{[emission]}$  = mass emission rate at a point in time within a given shift-day.

$\Delta t = 1/f_{record}$

$f_{record}$  = the record rate.

*Example:*

$N = 24543$

$\dot{m}_{NOx1} = 0.0187$  g/s

$\dot{m}_{NOx2} = 0.0191$  g/s

$f_{record} = 1$  Hz

$\Delta t = 1/1$  Hz = 1 s

$m_{NOxshift} = (0.0187 + 0.0191 + \dots + \dot{m}_{NOx24543}) \cdot 1 = 1.337$  g

(2) Determine the sum of mass emissions from the shift day over the sum of CO<sub>2</sub> emissions from the shift day,  $e_{sos[emission]shift}$ , for each measured pollutant using the following equation:

$$e_{sos[emission]shift} = \frac{m_{[emission]shift}}{m_{CO2shift}} \cdot e_{CO2FTPFL}$$

Eq. 1036.515-7

Where:

$m_{[emission]shift}$  = sum of mass for each emission for the shift day as determined in paragraph (h)(1) of this section.

$m_{CO2shift}$  = sum of mass for CO<sub>2</sub> for the shift day as determined in paragraph (h)(1) of this section.

$e_{CO2FTPFL}$  = the FCL value for CO<sub>2</sub> emissions over the FTP duty cycle identified in the engine family's application for certification.

*Example:*

$m_{NOxshift} = 1.337$  g

$m_{CO2shift} = 18778$  g

$e_{CO2FTPFL} = 505.1$  g/hp·hr

$$e_{sosNOxmediumhighload} = \frac{1.337}{18778} \cdot 505.1 = 0.035 \text{ g/hp} \cdot \text{hr}$$

#### § 1036.520 Test procedures to verify deterioration factors.

Sections 1036.240 through 1036.246 describe certification procedures to determine, verify, and apply deterioration factors. This section describes the measurement procedures for verifying deterioration factors using PEMS or onboard NO<sub>x</sub> sensors with in-use vehicles.

(a) Use PEMS or onboard NO<sub>x</sub> sensors to collect 1 Hz data throughout a shift-day of driving. Collect all the data elements needed to determine brake-specific emissions. Calculate emission results using moving average windows as described in § 1036.515.

(b) Collect data as needed to perform the calculations specified in paragraph (a) of this section and to submit the test report specified in § 1036.246(f).

#### § 1036.522 Infrequently regenerating aftertreatment devices.

For engines using aftertreatment technology with infrequent regeneration events that may occur during testing, take one of the following approaches to account for the emission impact of regeneration on criteria pollutant and greenhouse gas emissions:

(a) You may use the calculation methodology described in 40 CFR 1065.680 to adjust measured emission results. Do this by developing an upward adjustment factor and a downward adjustment factor for each pollutant based on measured emission data and observed regeneration frequency as follows:

(1) Adjustment factors should generally apply to an entire engine

family, but you may develop separate adjustment factors for different configurations within an engine family. Use the adjustment factors from this section for all testing for the engine family.

(2) You may use carryover data to establish adjustment factors for an engine family as described in § 1036.235(d), consistent with good engineering judgment.

(3) Identify the value of  $F_{[cycle]}$  in each application for the certification for which it applies.

(4) Calculate separate adjustment factors for each required duty cycle.

(b) You may ask us to approve an alternate methodology to account for regeneration events. We will generally limit approval to cases where your engines use aftertreatment technology with extremely infrequent regeneration and you are unable to apply the provisions of this section.

(c) You may choose to make no adjustments to measured emission results if you determine that regeneration does not significantly affect emission levels for an engine family (or configuration) or if it is not practical to identify when regeneration occurs. You may omit adjustment factors under this paragraph (c) for N<sub>2</sub>O, CH<sub>4</sub>, or other individual pollutants under this paragraph (c) as appropriate. If you choose not to make adjustments under paragraph (a) or (b) of this section, your engines must meet emission standards for all testing, without regard to regeneration.

#### § 1036.527 Powertrain system rated power determination.

This section describes how to determine the peak and continuous rated power of conventional and hybrid powertrain systems and the vehicle speed for carrying out testing according to §§ 1036.505 and 1036.510 and 40 CFR 1037.550.

(a) Set up the powertrain according to 40 CFR 1037.550, but use the vehicle parameters in § 1036.505(b)(2), except replace  $P_{contrated}$  with the manufacturer declared system peak power and use applicable automatic transmission for the engine. Note that if you repeat the system rated power determination as described in paragraph (f)(4) of this section, use the measured system peak power in place of  $P_{contrated}$ .

(b) Prior to the start of each test interval verify the following:

(1) The state-of-charge of the rechargeable energy storage system (RESS) is  $\geq 90\%$  of the operating range between the minimum and maximum RESS energy levels specified by the manufacturer.

(2) The conditions of all hybrid system components are within their normal operating range as declared by the manufacturer.

(3) RESS restrictions (e.g., power limiting, thermal limits, etc.) are not active.

(c) Carry out the test as follows:

(1) Warm up the powertrain by operating it. We recommend operating the powertrain at any vehicle speed and road grade that achieves approximately 75% of its expected maximum power.



Continue the warm-up until the engine coolant, block, or head absolute temperature is within  $\pm 2\%$  of its mean value for at least 2 min or until the engine thermostat controls engine temperature.

(2) Once warmup is complete, bring the vehicle speed to 0 mi/hr and start the test by operating the powertrain at 0 mi/hr for 50 seconds.

(3) Set maximum driver demand for a full load acceleration at 6% road grade

with an initial vehicle speed of 0 mi/hr. After 268 seconds, linearly ramp the grade from 6% down to 0% over 300 seconds. Stop the test after the vehicle speed has reached a maximum value.

(d) Record the powertrain system angular speed and torque values measured at the dynamometer at 100 Hz and use these in conjunction with the vehicle model to calculate  $P_{\text{sys,vehicle}}$ .

(e) Calculate the system power,  $P_{\text{sys}}$ , for each data point as follows:

(1) For testing with the speed and torque measurements at the transmission input shaft,  $P_{\text{sys}i}$  is equal to the calculated vehicle system power,  $P_{\text{sys}i,\text{vehicle}}$ , determined in paragraphs (c) and (d) of this section.

(2) For testing with the speed and torque measurements at the axle input shaft or the wheel hubs, determine  $P_{\text{sys}}$  for each data point using the following equation:

$$P_{\text{sys}i} = \frac{P_{\text{sys}i,\text{vehicle}}}{\epsilon_{\text{trans}} \cdot \epsilon_{\text{axle}}}$$

Eq. 1036.527-1

Where:

$P_{\text{sys}i,\text{vehicle}}$  = the calculated vehicle system power for each data point.

$\epsilon_{\text{trans}}$  = the default transmission efficiency = 0.95.

$\epsilon_{\text{axle}}$  = the default axle efficiency. Set this value = 1 for speed and torque measurement at the axle input shaft or = 0.955 at the wheel hubs.

*Example:*

$$P_{\text{sys,vehicle}} = 317.6 \text{ kW}$$

$$P_{\text{sys}} = \frac{317.6}{0.95 \cdot 0.955} = 350.1 \text{ kW}$$

(f) The system peak rated power,  $P_{\text{rated}}$ , is the highest calculated  $P_{\text{sys}}$  where the coefficient of variation (COV)

<2%. The COV is determined as follows:

(1) Calculate the standard deviation,  $\sigma(t)$ .

$$\sigma(t) = \sqrt{\frac{1}{N} \cdot \sum_{i=1}^N (P_{\text{sys}i} - \bar{P}_{\text{sys}}(t))^2}$$

Eq. 1036.527-2

Where:

$N$  = the number of measurement intervals = 20.

$P_{\text{sys}i}$  = the  $N$  samples of  $P_{\text{sys}}$  in the 100 Hz signal previously used to calculate the respective  $\bar{P}_{\text{sys}}(t)$  values at the time step  $t$ .

$\bar{P}_{\text{sys}}(t)$  = the power vector from the results of each test run that is determined by a moving averaging of 20 consecutive samples of  $P_{\text{sys}}$  in the 100 Hz that converts  $P_{\text{sys}}(t)$  to a 5 Hz signal.

(2) The resulting 5 Hz power and covariance signals are used to determine system rated power.

(3) The coefficient of variation  $\text{COV}(t)$  shall be calculated as the ratio of the standard deviation,  $\sigma(t)$ , to the mean value of power,  $\bar{P}_{\text{sys}}(t)$ , for each time step  $t$ .

$$\text{COV}(t) = \frac{\sigma(t)}{\bar{P}_{\text{sys}}(t)}$$

Eq. 1036.527-3

(4) If the determined system peak rated power is not within  $\pm 3\%$  of the system peak rated power as declared by the manufacturer, you must repeat the procedure in paragraphs (a) through

(f)(3) of this section using the measured system peak rated power determined in this paragraph (f) instead of the manufacturer declared value. The result

from this repeat is the final determined system peak rated power.

(5) If the determined system peak rated power is within  $\pm 3\%$  of the system peak rated power as declared by the

manufacturer, the declared system peak rated power shall be used.

(g) Determine continuous rated power as follows:

(1) For conventional powertrains,  $P_{\text{contrated}}$  equals  $P_{\text{rated}}$ .

(2) For hybrid powertrains, continuous rated power,  $P_{\text{contrated}}$ , is the maximum measured power from the data collected in paragraph (c)(3) of this section that meets the requirements in paragraph (f) of this section.

(h) Vehicle C speed,  $v_{\text{refC}}$ , is determined as follows:

(1) For powertrains where  $P_{\text{sys}}$  is greater than  $0.98 \cdot P_{\text{contrated}}$  in top gear at more than one vehicle speed,  $v_{\text{refC}}$  is the average of the minimum and maximum vehicle speeds from the data collected in paragraph (c)(3) of this section that meets the requirements in paragraph (f) of this section.

(2) For powertrains where  $P_{\text{sys}}$  is less than  $0.98 \cdot P_{\text{contrated}}$  in top gear at more than one vehicle speed,  $v_{\text{refC}}$  is the maximum vehicle speed from the data collected in paragraph (c)(3) of this section that meets the requirements in paragraph (f) of this section where  $P_{\text{sys}}$  is greater than  $0.98 \cdot P_{\text{contrated}}$ .

**§ 1036.530 Calculating greenhouse gas emission rates.**

This section describes how to calculate official emission results for CO<sub>2</sub>, CH<sub>4</sub>, and N<sub>2</sub>O.

(a) Calculate brake-specific emission rates for each applicable duty cycle as specified in 40 CFR 1065.650. Apply infrequent regeneration adjustment factors as described in § 1036.522.

(b) Adjust CO<sub>2</sub> emission rates calculated under paragraph (a) of this section for measured test fuel properties as specified in this paragraph (b). This adjustment is intended to make official emission results independent of differences in test fuels within a fuel type. Use good engineering judgment to develop and apply testing protocols to minimize the impact of variations in test fuels.

(1) Determine your test fuel’s mass-specific net energy content,  $E_{\text{mfuelmeas}}$ , also known as lower heating value, in MJ/kg, expressed to at least three decimal places. Determine  $E_{\text{mfuelmeas}}$  as follows:

(i) For liquid fuels, determine  $E_{\text{mfuelmeas}}$  according to ASTM D4809 (incorporated by reference in § 1036.810). Have the sample analyzed by at least three different labs and determine the final value of your test fuel’s  $E_{\text{mfuelmeas}}$  as the median all of the lab results you obtained. If you have results from three different labs, we recommend you screen them to determine if additional observations are needed. To perform this screening, determine the absolute value of the difference between each lab result and the average of the other two lab results. If the largest of these three resulting absolute value differences is greater than 0.297 MJ/kg, we recommend you obtain additional results prior to determining the final value of  $E_{\text{mfuelmeas}}$ .

(ii) For gaseous fuels, determine  $E_{\text{mfuelmeas}}$  according to ASTM D3588 (incorporated by reference in § 1036.810).

(2) Determine your test fuel’s carbon mass fraction,  $w_C$ , as described in 40 CFR 1065.655(d), expressed to at least three decimal places; however, you must measure fuel properties rather than using the default values specified in Table 1 of 40 CFR 1065.655.

(i) For liquid fuels, have the sample analyzed by at least three different labs and determine the final value of your test fuel’s  $w_C$  as the median of all of the lab results you obtained. If you have results from three different labs, we recommend you screen them to determine if additional observations are needed. To perform this screening, determine the absolute value of the difference between each lab result and the average of the other two lab results. If the largest of these three resulting absolute value differences is greater than 1.56 percent carbon, we

recommend you obtain additional results prior to determining the final value of  $w_C$ .

(ii) For gaseous fuels, have the sample analyzed by a single lab and use that result as your test fuel’s  $w_C$ .

(3) If, over a period of time, you receive multiple fuel deliveries from a single stock batch of test fuel, you may use constant values for mass-specific energy content and carbon mass fraction, consistent with good engineering judgment. To use these constant values, you must demonstrate that every subsequent delivery comes from the same stock batch and that the fuel has not been contaminated.

(4) Correct measured CO<sub>2</sub> emission rates as follows:

$$e_{\text{CO2cor}} = e_{\text{CO2}} \cdot \frac{E_{\text{mfuelmeas}}}{E_{\text{mfuelCref}} \cdot w_{\text{Cmeas}}}$$

Eq. 1036.530-1

Where:

- $e_{\text{CO2}}$  = the calculated CO<sub>2</sub> emission result.
- $E_{\text{mfuelmeas}}$  = the mass-specific net energy content of the test fuel as determined in paragraph (b)(1) of this section. Note that dividing this value by  $w_{\text{Cmeas}}$  (as is done in this equation) equates to a carbon-specific net energy content having the same units as  $E_{\text{mfuelCref}}$ .
- $E_{\text{mfuelCref}}$  = the reference value of carbon-mass-specific net energy content for the appropriate fuel type, as determined in Table 1 in this section.
- $w_{\text{Cmeas}}$  = carbon mass fraction of the test fuel (or mixture of test fuels) as determined in paragraph (b)(2) of this section.

*Example:*

$$e_{\text{CO2}} = 630.0 \text{ g/hp}\cdot\text{hr}$$

$$E_{\text{mfuelmeas}} = 42.528 \text{ MJ/kg}$$

$$E_{\text{mfuelCref}} = 49.3112 \text{ MJ/kgC}$$

$$w_{\text{Cmeas}} = 0.870$$

$$e_{\text{CO2cor}} = 630.0 \cdot \frac{42.528}{49.3112 \cdot 0.870}$$

$$e_{\text{CO2cor}} = 624.5 \text{ g/hp}\cdot\text{hr}$$

$$e_{\text{CO2cor}} = 624.5 \text{ g/hp}\cdot\text{hr}$$

TABLE 1 TO PARAGRAPH (b)(4) OF § 1036.530—REFERENCE FUEL PROPERTIES

Fuel type <sup>a</sup>	Reference fuel carbon-mass-specific net energy content, $E_{\text{mfuelCref}}$ , (MJ/kgC) <sup>b</sup>	Reference fuel carbon mass fraction, $w_{\text{Cref}}$ <sup>b</sup>
Diesel fuel .....	49.3112	0.874
Gasoline .....	50.4742	0.846
Natural Gas .....	66.2910	0.750
LPG .....	56.5218	0.820
Dimethyl Ether .....	55.3886	0.521
High-level ethanol-gasoline blends .....	50.3211	0.576

<sup>a</sup> For fuels that are not listed, you must ask us to approve reference fuel properties.

<sup>b</sup> For multi-fuel streams, such as natural gas with diesel fuel pilot injection, use good engineering judgment to determine blended values for  $E_{\text{mfuelCref}}$  and  $w_{\text{Cref}}$  using the values in this table.

(c) Your official emission result for each pollutant equals your calculated brake-specific emission rate multiplied by all applicable adjustment factors, other than the deterioration factor.

**§ 1036.535 Determining steady-state engine fuel maps and fuel consumption at idle.**

The procedures in this section describe how to determine an engine's steady-state fuel map and fuel consumption at idle for model year 2021 and later vehicles; these procedures apply as described in § 1036.503. Vehicle manufacturers may need these values to demonstrate compliance with emission standards under 40 CFR part 1037.

(a) *General test provisions.* Perform fuel mapping using the procedure described in paragraph (b) of this section to establish measured fuel-consumption rates at a range of engine speed and load settings. Measure fuel consumption at idle using the procedure described in paragraph (c) of this section. Paragraph (d) of this section describes how to apply the steady-state mapping from paragraph (b) of this section for the special case of cycle-average mapping for highway cruise cycles as described in § 1036.540. Use these measured fuel-consumption values to declare fuel-consumption rates for certification as described in paragraph (g) of this section.

(1) Map the engine's torque curve and declare engine idle speed as described in § 1036.503(c)(1) and (3). Perform emission measurements as described in 40 CFR 1065.501 and 1065.530 for discrete-mode steady-state testing. This section uses engine parameters and variables that are consistent with 40 CFR part 1065.

(2) Measure NO<sub>x</sub> emissions as described in paragraph (f) of this section. Include these measured NO<sub>x</sub> values any time you report to us your fuel consumption values from testing under this section.

(3) You may use shared data across engine configurations to the extent that

the fuel-consumption rates remain valid.

(4) The provisions related to carbon balance error verification in § 1036.543 apply for all testing in this section. These procedures are optional, but we will perform carbon balance error verification for all testing under this section.

(5) Correct fuel mass flow rate to a mass-specific net energy content of a reference fuel as described in paragraph (e) of this section.

(b) *Steady-state fuel mapping.* Determine steady-state fuel-consumption rates for each engine configuration over a series of paired engine speed and torque setpoints as described in this paragraph (b). For example, if you test a high-output (parent) configuration and create a different (child) configuration that uses the same fueling strategy but limits the engine operation to be a subset of that from the high-output configuration, you may use the fuel-consumption rates for the reduced number of mapped points for the low-output configuration, as long as the narrower map includes at least 70 points. Perform fuel mapping as follows:

(1) Generate the fuel-mapping sequence of engine speed and torque setpoints as follows:

(i) Select the following required speed setpoints: Warm idle speed,  $f_{\text{idle}}$  the highest speed above maximum power at which 70% of maximum power occurs,  $n_{\text{hi}}$ , and eight (or more) equally spaced points between  $f_{\text{idle}}$  and  $n_{\text{hi}}$ . (See 40 CFR 1065.610(c)). For engines with adjustable warm idle speed, replace  $f_{\text{idle}}$  with minimum warm idle speed  $f_{\text{idlemin}}$ .

(ii) Determine the following default torque setpoints at each of the selected speed setpoints: Zero ( $T = 0$ ), maximum mapped torque,  $T_{\text{max mapped}}$ , and eight (or more) equally spaced points between  $T = 0$  and  $T_{\text{max mapped}}$ . Select the maximum torque setpoint at each speed to conform to the torque map as follows:

(A) Calculate 5 percent of  $T_{\text{max mapped}}$ . Subtract this result from the mapped torque at each speed setpoint,  $T_{\text{max}}$ .

(B) Select  $T_{\text{max}}$  at each speed setpoint as a single torque value to represent all the default torque setpoints above the value determined in paragraph (b)(1)(ii)(A) of this section. All the default torque setpoints less than  $T_{\text{max}}$  at a given speed setpoint are required torque setpoints.

(iii) You may select any additional speed and torque setpoints consistent with good engineering judgment. For example you may need to select additional points if the engine's fuel consumption is nonlinear across the torque map. Avoid creating a problem with interpolation between narrowly spaced speed and torque setpoints near  $T_{\text{max}}$ . For each additional speed setpoint, we recommend including a torque setpoint of  $T_{\text{max}}$ ; however, you may select torque setpoints that properly represent in-use operation. Increments for torque setpoints between these minimum and maximum values at an additional speed setpoint must be no more than one-ninth of  $T_{\text{max,mapped}}$ . Note that if the test points were added for the child rating, they should still be reported in the parent fuel map. We will test with at least as many points as you. If you add test points to meet testing requirements for child ratings, include those same test points as reported values for the parent fuel map. For our testing, we will use the same normalized speed and torque test points you use, and we may select additional test points.

(iv) Start fuel-map testing at the highest speed setpoint and highest torque setpoint, followed by decreasing torque setpoints at the highest speed setpoint. Continue testing at the next lowest speed setpoint and the highest torque setpoint at that speed setpoint, followed by decreasing torque setpoints at that speed setpoint. Follow this pattern through all the speed and torque points, ending with the lowest speed ( $f_{\text{idle}}$  or  $f_{\text{idlemin}}$ ) and torque setpoint ( $T = 0$ ). The following figure illustrates an array of test points and the corresponding run order.

Figure 1 paragraph (b)(1)(iv) of § 1036.535—Illustration of Steady-State Fuel-Mapping Test Points and Run Order

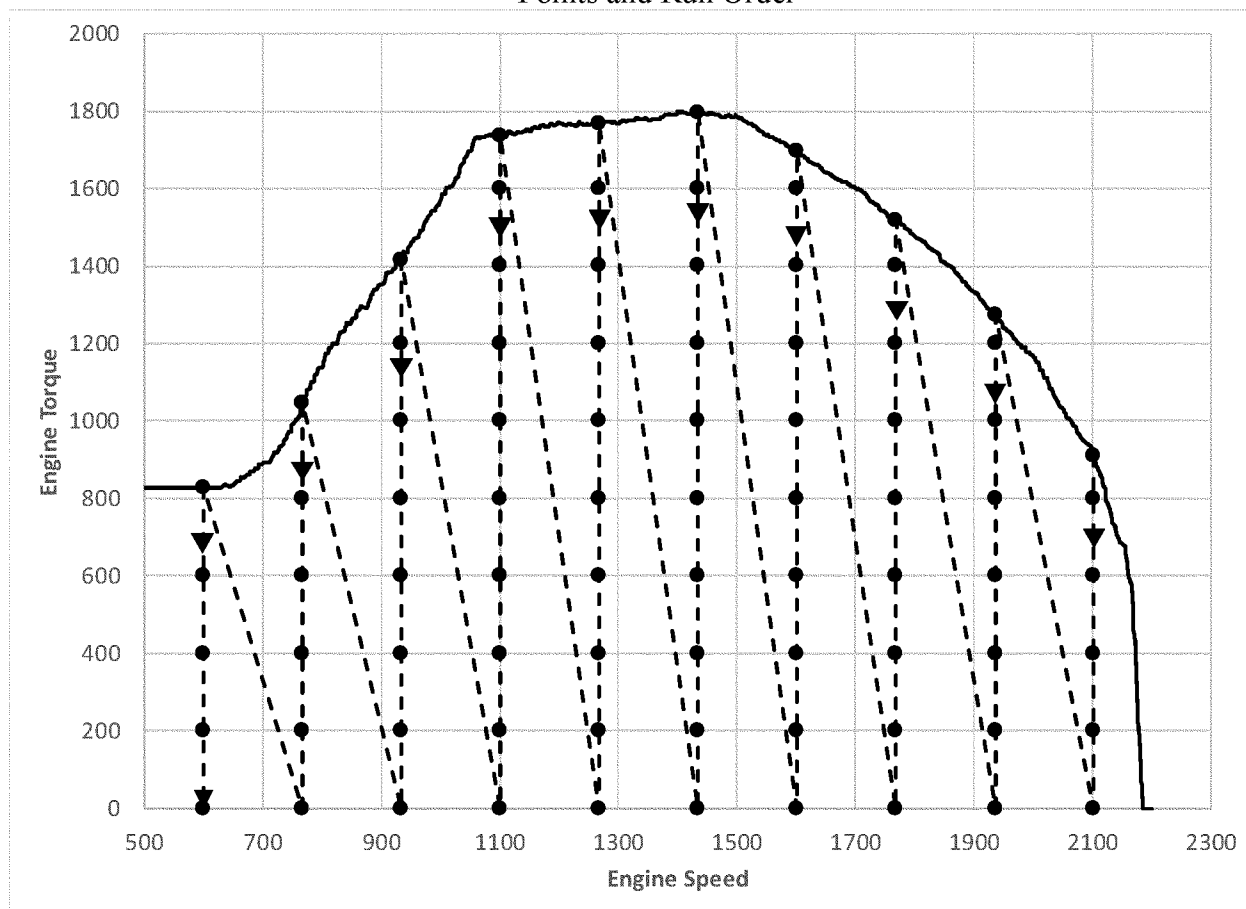

(v) The highest torque setpoint for each speed setpoint is an optional reentry point to restart fuel mapping after an incomplete test run.

(vi) The lowest torque setpoint at each speed setpoint is an optional exit point to interrupt testing. Paragraph (b)(7) of this section describes how to interrupt testing at other times.

(2) If the engine's warm idle speed is adjustable, set it to its minimum value,  $f_{\text{idlemin}}$ .

(3) The measurement at each unique combination of speed and torque setpoints constitutes a test interval. Unless we specify otherwise, you may program the dynamometer to control either speed or torque for a given test interval, with operator demand controlling the other parameter. Control speed and torque so that all recorded speed points are within  $\pm 1\%$  of  $n_{\text{hi}}$  from the target speed and all recorded engine torque points are within  $\pm 5\%$  of  $T_{\text{max}}$  mapped from the target torque during each test interval, except as follows:

(i) For steady-state engine operating points that cannot be achieved, and the operator demand stabilizes at minimum; program the dynamometer to control

torque and let the engine govern speed (see 40 CFR 1065.512(b)(1)). Control torque so that all recorded engine torque points are within  $\pm 25$  N·m from the target torque. The specified speed tolerance does not apply for the test interval.

(ii) For steady-state engine operating points that cannot be achieved and the operator demand stabilizes at maximum and the speed setpoint is below 90% of  $n_{\text{hi}}$  even with maximum operator demand, program the dynamometer to control speed and let the engine govern torque (see 40 CFR 1065.512(b)(2)). The specified torque tolerance does not apply for the test interval.

(iii) For steady-state engine operating points that cannot be achieved and the operator demand stabilizes at maximum and the speed setpoint is at or above 90% of  $n_{\text{hi}}$  even with maximum operator demand, program the dynamometer to control torque and let the engine govern speed (see 40 CFR 1065.512(b)(1)). The specified speed tolerance does not apply for the test interval.

(iv) For the steady-state engine operating points at the minimum speed setpoint and maximum torque setpoint,

you may program the dynamometer to control speed and let the engine govern torque. The specified torque tolerance does not apply for this test interval if operator demand stabilizes at its maximum or minimum limit.

(4) Record measurements using direct and/or indirect measurement of fuel flow as follows:

(i) *Direct fuel-flow measurement.* Record speed and torque and measure fuel consumption with a fuel flow meter for  $(30 \pm 1)$  seconds. Determine the corresponding mean values for the test interval. Use of redundant direct fuel-flow measurements require prior EPA approval.

(ii) *Indirect fuel-flow measurement.* Record speed and torque and measure emissions and other inputs needed to run the chemical balance in 40 CFR 1065.655(c) for  $(30 \pm 1)$  seconds. Determine the corresponding mean values for the test interval. Use of redundant indirect fuel-flow measurements require prior EPA approval. Measure background concentration as described in 40 CFR 1065.140, except that you may use one of the following methods to apply a

single background reading to multiple test intervals:

(A) For batch sampling, you may sample periodically into the bag over the course of multiple test intervals and read them as allowed in paragraph (b)(7)(i) of this section. You must determine a single background reading for all affected test intervals if you use the method described in this paragraph (b)(4)(ii)(A).

(B) You may measure background concentration by sampling from the dilution air during the interruptions allowed in paragraph (b)(7)(i) of this section or at other times before or after test intervals. Measure background concentration within 30 minutes before the first test interval and within 30 minutes before each reentry point. Measure the corresponding background concentration within 30 minutes after each exit point and within 30 minutes after the final test interval. You may measure background concentration more frequently. Correct measured emissions for test intervals between a pair of background readings based on the average of those two values. Once the system stabilizes, collect a background sample over an averaging period of at least 30 seconds.

(5) Warm up the engine as described in 40 CFR 1065.510(b)(2). Within 60 seconds after concluding the warm-up, linearly ramp the speed and torque setpoints over 5 seconds to the starting test point from paragraph (b)(1) of this section.

(6) Stabilize the engine by operating at the specified speed and torque setpoints for  $(70 \pm 1)$  seconds and then start the test interval. Record measurements during the test interval. Measure and report  $\text{NO}_x$  emissions over each test interval as described in paragraph (f) of this section.

(7) After completing a test interval, linearly ramp the speed and torque setpoints over 5 seconds to the next test point.

(i) You may interrupt the fuel-mapping sequence before a reentry point as noted in paragraphs (b)(1)(v) and (vi) of this section. If you zero and span analyzers, read and evacuate background bag samples, or sample dilution air for a background reading during the interruption, the maximum time to stabilize in paragraph (b)(6) of this section does not apply. If you shut off the engine, restart with engine warm-up as described in paragraph (b)(5) of this section.

(ii) You may interrupt the fuel-mapping sequence at a given speed

setpoint before completing measurements at that speed. If this happens, you may measure background concentration and take other action as needed to validate test intervals you completed before the most recent reentry point. Void all test intervals after the last reentry point. Restart testing at the appropriate reentry point in the same way that you would start a new test. Operate the engine long enough to stabilize aftertreatment thermal conditions, even if it takes more than 70 seconds. In the case of an infrequent regeneration event, interrupt the fuel-mapping sequence and allow the regeneration event to finish with the engine operating at a speed and load that allows effective regeneration.

(iii) If you void any one test interval, all the testing at that speed setpoint is also void. Restart testing by repeating the fuel-mapping sequence as described in this paragraph (b);

include all voided speed setpoints and omit testing at speed setpoints that already have a full set of valid results.

(8) If you determine fuel-consumption rates using emission measurements from the raw or diluted exhaust, calculate the mean fuel mass flow rate,  $\bar{m}_{\text{fuel}}$ , for each point in the fuel map using the following equation:

$$\bar{m}_{\text{fuel}} = \frac{M_C}{w_{C\text{meas}}} \cdot \left( \bar{n}_{\text{exh}} \cdot \frac{\bar{x}_{C\text{combdry}}}{1 + \bar{x}_{\text{H}_2\text{Oexhdry}}} - \frac{\bar{m}_{\text{CO}_2\text{DEF}}}{M_{\text{CO}_2}} \right)$$

Eq. 1036.535-1

Where:

$\bar{m}_{\text{fuel}}$  = mean fuel mass flow rate for a given fuel map setpoint, expressed to at least the nearest 0.001 g/s.

$M_C$  = molar mass of carbon.

$w_{C\text{meas}}$  = carbon mass fraction of fuel (or mixture of test fuels) as determined in 40 CFR 1065.655(d), except that you may not use the default properties in Table 2 of 40 CFR 1065.655 to determine  $\alpha$ ,  $\beta$ , and  $w_C$ . You may not account for the contribution to  $\alpha$ ,  $\beta$ ,  $\gamma$ , and  $\delta$  of diesel exhaust fluid or other non-fuel fluids injected into the exhaust.

$\bar{n}_{\text{exh}}$  = the mean raw exhaust molar flow rate from which you measured emissions according to 40 CFR 1065.655.

$\bar{x}_{C\text{combdry}}$  = the mean concentration of carbon from fuel and any injected fluids in the exhaust per mole of dry exhaust as determined in 40 CFR 1065.655(c).

$\bar{x}_{\text{H}_2\text{Oexhdry}}$  = the mean concentration of  $\text{H}_2\text{O}$  in exhaust per mole of dry exhaust as determined in 40 CFR 1065.655(c).

$\bar{m}_{\text{CO}_2\text{DEF}}$  = the mean  $\text{CO}_2$  mass emission rate resulting from diesel exhaust fluid decomposition as determined in paragraph (b)(9) of this section. If your

engine does not use diesel exhaust fluid, or if you choose not to perform this correction, set  $\bar{m}_{\text{CO}_2\text{DEF}}$  equal to 0.

$M_{\text{CO}_2}$  = molar mass of carbon dioxide.

*Example:*

$M_C = 12.0107$  g/mol

$w_{C\text{meas}} = 0.869$

$\bar{n}_{\text{exh}} = 25.534$  mol/s

$\bar{x}_{C\text{combdry}} = 0.002805$  mol/mol

$\bar{x}_{\text{H}_2\text{Oexhdry}} = 0.0353$  mol/mol

$\bar{m}_{\text{CO}_2\text{DEF}} = 0.0726$  g/s

$M_{\text{CO}_2} = 44.0095$  g/mol

$$\bar{m}_{\text{fuel}} = \frac{12.0107}{0.869} \cdot \left( 25.534 \cdot \frac{0.002805}{1 + 0.0353} - \frac{0.0726}{44.0095} \right) = 0.933 \text{ g/s}$$

(9) If you determine fuel-consumption rates using emission measurements with engines that utilize diesel exhaust fluid for  $\text{NO}_x$  control and you correct for the mean  $\text{CO}_2$  mass emission rate resulting from diesel exhaust fluid decomposition as described in paragraph (b)(8) of this

section, perform this correction at each fuel map setpoint using the following equation:

$$\bar{m}_{\text{CO}_2\text{DEF}} = \bar{m}_{\text{DEF}} \cdot \frac{M_{\text{CO}_2} \cdot w_{\text{CH}_4\text{N}_2\text{O}}}{M_{\text{CH}_4\text{N}_2\text{O}}}$$

Eq. 1036.535-2

Where:

$\bar{m}_{\text{DEF}}$  = the mean mass flow rate of injected urea solution diesel exhaust fluid for a

given sampling period, determined directly from the ECM, or measured separately, consistent with good engineering judgment.

$M_{CO_2}$  = molar mass of carbon dioxide.

$w_{CH_4N_2O}$  = mass fraction of urea in diesel exhaust fluid aqueous solution. Note that the subscript "CH<sub>4</sub>N<sub>2</sub>O" refers to urea as

a pure compound and the subscript "DEF" refers to the aqueous urea diesel exhaust fluid as a solution of urea in water. You may use a default value of 32.5% or use good engineering judgment to determine this value based on measurement.

$M_{CH_4N_2O}$  = molar mass of urea.

*Example:*

$$\bar{m}_{DEF} = 0.304 \text{ g/s}$$

$$M_{CO_2} = 44.0095 \text{ g/mol}$$

$$w_{CH_4N_2O} = 32.5\% = 0.325$$

$$M_{CH_4N_2O} = 60.05526 \text{ g/mol}$$

$$\bar{m}_{CO_2DEF} = 0.304 \cdot \frac{44.0095 \cdot 0.325}{60.05526} = 0.0726 \text{ g/s}$$

(c) *Fuel consumption at idle.*

Determine fuel-consumption rates at idle for each engine configuration that is certified for installation in vocational vehicles. Determine fuel-consumption rates at idle by testing engines over a series of paired engine speed and torque setpoints as described in this paragraph (c). Perform measurements as follows:

(1) The idle test sequence consists of measuring fuel consumption at four test points representing each combination of the following speed and torque setpoints in any order.

(i) Speed setpoints for engines with adjustable warm idle speed are minimum warm idle speed,  $f_{idlemin}$ , and maximum warm idle speed,  $f_{idlemax}$ . Speed setpoints for engines with no adjustable warm idle speed (with zero torque on the primary output shaft) are  $f_{idle}$  and 1.15 times  $f_{idle}$ .

(ii) Torque setpoints are 0 and 100 N · m.

(2) Control speed and torque as follows:

(i) *Adjustable warm idle speed.* Set the engine's warm idle speed to the next speed setpoint any time before the engine reaches the next test point. Control both speed and torque when the engine is warming up and when it is transitioning to the next test point. Start to control both speed and torque. At any time prior to reaching the next engine-idle operating point, set the engine's adjustable warm idle speed setpoint to the speed setpoint of the next engine-idle operating point in the sequence. This may be done before or during the warm-up or during the transition. Near the end of the transition period control speed and torque as described in paragraph (b)(3)(i) of this section shortly before reaching each test point. Once the engine is operating at the desired speed and torque setpoints, set the operator demand to minimum; control torque so that all recorded engine torque points are within  $\pm 25$  N·m from the target torque.

(ii) *Nonadjustable warm idle speed.* For the lowest speed setpoint, control speed and torque as described in paragraph (c)(2)(i) of this section, except

for adjusting the warm idle speed. For the second-lowest speed setpoint, control speed and torque so that all recorded speed points are within  $\pm 1\%$  of  $n_{hi}$  from the target speed and engine torque within  $\pm 5\%$  of  $T_{max}$  mapped from the target torque.

(3) Record measurements using direct and/or indirect measurement of fuel flow as follows:

(i) *Direct fuel flow measurement.* Record speed and torque and measure fuel consumption with a fuel flow meter for  $(600 \pm 1)$  seconds. Determine the corresponding mean values for the test interval. Use of redundant direct fuel-flow measurements require prior EPA approval.

(ii) *Indirect fuel flow measurement.* Record speed and torque and measure emissions and other inputs needed to run the chemical balance in 40 CFR 1065.655(c) for  $(600 \pm 1)$  seconds. Determine the corresponding mean values for the test interval. Use of redundant indirect fuel-flow measurements require prior EPA approval. Measure background concentration as described in paragraph (b)(4)(ii) of this section. We recommend setting the CVS flow rate as low as possible to minimize background, but without introducing errors related to insufficient mixing or other operational considerations. Note that for this testing 40 CFR 1065.140(e) does not apply, including the minimum dilution ratio of 2:1 in the primary dilution stage.

(4) Warm up the engine as described in 40 CFR 1065.510(b)(2). Within 60 seconds after concluding the warm-up, linearly ramp the speed and torque over 20 seconds to the first speed and torque setpoint.

(5) The measurement at each unique combination of speed and torque setpoints constitutes a test interval. Operate the engine at the selected speed and torque set points for  $(180 \pm 1)$  seconds, and then start the test interval. Record measurements during the test interval. Measure and report NO<sub>x</sub> emissions over each test interval as described in paragraph (f) of this section.

(6) After completing each test interval, repeat the steps in paragraphs (c)(4) and (5) of this section for all the remaining engine-idle test points.

(7) Each test point represents a stand-alone measurement. You may therefore take any appropriate steps between test intervals to process collected data and to prepare engines and equipment for further testing. Note that the allowances for combining background in paragraph (b)(4)(ii)(B) of this section do not apply. If an infrequent regeneration event occurs, allow the regeneration event to finish; void the test interval if the regeneration starts during a measurement.

(8) Correct the measured or calculated mean fuel mass flow rate, at each of the engine-idle operating points to account for mass-specific net energy content as described in paragraph (e) of this section.

(d) *Steady-state fuel maps used for cycle-average fuel mapping of the highway cruise cycles.* Determine steady-state fuel-consumption rates for each engine configuration over a series of paired engine speed and torque setpoints near idle as described in this paragraph (d). Perform fuel mapping as described in paragraph (b) of this section with the following exceptions:

(1) Select speed setpoints to cover a range of values to represent in-use operation at idle. Speed setpoints for engines with adjustable warm idle speed must include at least minimum warm idle speed,  $f_{idlemin}$ , and a speed at or above maximum warm idle speed,  $f_{idlemax}$ . Speed setpoints for engines with no adjustable idle speed must include at least warm idle speed (with zero torque on the primary output shaft),  $f_{idle}$ , and a speed at or above  $1.15 \cdot f_{idle}$ .

(2) Select the following torque setpoints at each speed setpoint to cover a range of values to represent in-use operation at idle:

(i) The minimum torque setpoint is zero.

(ii) Choose a maximum torque setpoint that is at least as large as the

value determined by the following equation:

$$T_{\text{idlemaxest}} = \left( \frac{T_{\text{finstall}} \cdot f_{\text{nidle}}^2}{f_{\text{finstall}}^2} + \frac{P_{\text{acc}}}{f_{\text{nidle}}} \right) \cdot 1.1$$

Eq. 1036.535-3

Where:

$T_{\text{finstall}}$  = the maximum engine torque at  $f_{\text{finstall}}$ .  
 $f_{\text{nidle}}$  = for engines with an adjustable warm idle speed, use the maximum warm idle speed,  $f_{\text{nidlemax}}$ . For engines without an adjustable warm idle speed, use warm idle speed,  $f_{\text{nidle}}$ .

$f_{\text{finstall}}$  = the stall speed of the torque converter; use  $f_{\text{ntest}}$  or 2250 r/min, whichever is lower.

$P_{\text{acc}}$  = accessory power for the vehicle class; use 1500 W for Vocational Light HDV, 2500 W for Vocational Medium HDV, and 3500 W for Tractors and Vocational Heavy HDV. If your engine is going to be installed in multiple vehicle classes, perform the test with the accessory

power for the largest vehicle class the engine will be installed in.

*Example:*

$T_{\text{finstall}} = 1870 \text{ N} \cdot \text{m}$   
 $f_{\text{ntest}} = 1740.8 \text{ r/min} = 182.30 \text{ rad/s}$   
 $f_{\text{finstall}} = 1740.8 \text{ r/min} = 182.30 \text{ rad/s}$   
 $f_{\text{nidle}} = 700 \text{ r/min} = 73.30 \text{ rad/s}$   
 $P_{\text{acc}} = 1500 \text{ W}$

$$T_{\text{idlemaxest}} = \left( \frac{1870 \cdot 73.30^2}{182.30^2} + \frac{1500}{73.30} \right) \cdot 1.1 = 355.07 \text{ N} \cdot \text{m}$$

(iii) Select one or more equally spaced intermediate torque setpoints, as needed, such that the increment between torque setpoints is no greater than one-ninth of  $T_{\text{max,mapped}}$ . Remove the points from the default map that are below 115% of the maximum speed and 115% of the maximum torque of the boundaries of the points measured in paragraph (d)(1) of this section.

(e) *Correction for net energy content.* Correct the measured or calculated mean fuel mass flow rate,  $\bar{m}_{\text{fuel}}$ , for each test interval to a mass-specific net energy content of a reference fuel using the following equation:

$$\bar{m}_{\text{fuelcor}} = \bar{m}_{\text{fuel}} \cdot \frac{E_{\text{mfuelmeas}}}{E_{\text{mfuelCref}} \cdot w_{\text{Cref}}}$$

Eq. 1036.535-4

Where:

$E_{\text{mfuelmeas}}$  = the mass-specific net energy content of the test fuel as determined in § 1036.530(b)(1).

$E_{\text{mfuelCref}}$  = the reference value of carbon-mass-specific net energy content for the appropriate fuel. Use the values shown in Table 1 in § 1036.530 for the designated fuel types, or values we approve for other fuel types.

$w_{\text{Cref}}$  = the reference value of carbon mass fraction for the test fuel as shown in

Table 1 of § 1036.530 for the designated fuels. For any fuel not identified in the table, use the reference carbon mass fraction of diesel fuel for engines subject to compression-ignition standards, and use the reference carbon mass fraction of gasoline for engines subject to spark-ignition standards.

*Example:*

$\bar{m}_{\text{fuel}} = 0.933 \text{ g/s}$   
 $E_{\text{mfuelmeas}} = 42.7984 \text{ MJ/kgC}$   
 $E_{\text{mfuelCref}} = 49.3112 \text{ MJ/kgC}$   
 $w_{\text{Cref}} = 0.874$

$$\bar{m}_{\text{fuel}} = 0.933 \cdot \frac{42.7984}{49.3112 \cdot 0.874} = 0.927 \text{ g/s}$$

(f) *Measuring NO<sub>x</sub> emissions.* Measure NO<sub>x</sub> emissions for each sampling period in g/s. You may perform these measurements using a NO<sub>x</sub> emission-measurement system that meets the requirements of 40 CFR part 1065, subpart J. If a system malfunction prevents you from measuring NO<sub>x</sub> emissions during a test under this section but the test otherwise gives valid results, you may consider this a valid test and omit the NO<sub>x</sub> emission measurements; however, we may require you to repeat the test if we determine that you inappropriately voided the test with respect to NO<sub>x</sub> emission measurement.

(g) *Measured vs. declared fuel-consumption.* Determine declared fuel consumption as follows:

(1) Select fuel-consumption rates in g/s to characterize the engine's fuel maps. You must select a declared value for each test point that is at or above the corresponding value determined in paragraphs (b) through (e) of this section, including those from redundant measurements.

(2) Declared fuel-consumption serves as emission standards under § 1036.108. These are the values that vehicle manufacturers will use for certification under 40 CFR part 1037. Note that production engines are subject to GEM cycle-weighted limits as described in § 1036.301.

(3) If you perform the carbon balance error verification, select declared values that are at or above the following emission measurements:

(i) If you pass the  $\epsilon_{\text{c}}$  verification, you may use the average of the values from direct and indirect fuel measurements.

(ii) If you fail  $\epsilon_{\text{c}}$  verification, but pass either the  $\epsilon_{\text{aC}}$  or  $\epsilon_{\text{aCrate}}$  verification, use the value from indirect fuel measurement.

(iii) If you fail all three verifications, you must either void the test interval or use the highest value from direct and indirect fuel measurements. Note that we will consider our test results to be invalid if we fail all three verifications.

#### § 1036.540 Determining cycle-average engine fuel maps.

(a) *Overview.* This section describes how to determine an engine's cycle-average fuel maps for model year 2021 and later vehicles. Vehicle manufacturers may need cycle-average

fuel maps for transient duty cycles, highway cruise cycles, or both to demonstrate compliance with emission standards under 40 CFR part 1037. Generate cycle-average engine fuel maps as follows:

- (1) Determine the engine’s torque maps as described in § 1036.503(c).
- (2) Determine the engine’s steady-state fuel map and fuel consumption at idle as described in § 1036.535. If you are applying cycle-average fuel mapping for highway cruise cycles, you may instead use GEM’s default fuel map instead of generating the steady-state fuel map in § 1036.535(b).
- (3) Simulate several different vehicle configurations using GEM (see 40 CFR 1037.520) to create new engine duty cycles as described in paragraph (c) of this section. The transient vehicle duty cycles for this simulation are in 40 CFR part 1037, appendix A; the highway cruise cycles with grade are in 40 CFR part 1037, appendix D. Note that GEM simulation relies on vehicle service classes as described in 40 CFR 1037.140.
- (4) Test the engines using the new duty cycles to determine fuel consumption, cycle work, and average vehicle speed as described in paragraph (d) of this section and establish GEM inputs for those parameters for further vehicle simulations as described in paragraph (e) of this section.

(b) *General test provisions.* The following provisions apply for testing under this section:

- (1) To perform fuel mapping under this section for hybrid engines, make sure the engine and its hybrid features are appropriately configured to represent the hybrid features in your testing.
- (2) Measure NO<sub>x</sub> emissions for each specified sampling period in grams. You may perform these measurements using a NO<sub>x</sub> emission-measurement system that meets the requirements of 40 CFR part 1065, subpart J. Include these measured NO<sub>x</sub> values any time you report to us your fuel consumption values from testing under this section. If a system malfunction prevents you from measuring NO<sub>x</sub> emissions during a test under this section but the test otherwise gives valid results, you may consider this a valid test and omit the NO<sub>x</sub> emission measurements; however, we may require you to repeat the test if we determine that you inappropriately voided the test with respect to NO<sub>x</sub> emission measurement.
- (3) The provisions related to carbon balance error verification in § 1036.543 apply for all testing in this section. These procedures are optional, but we will perform carbon balance error verification for all testing under this section.
- (4) Correct fuel mass flow rate to a mass-specific net energy content of a

reference fuel as described in paragraph (d)(13) of this section.

- (5) This section uses engine parameters and variables that are consistent with 40 CFR part 1065.
- (c) *Create engine duty cycles.* Use GEM to simulate your engine operation with several different vehicle configurations to create transient and highway cruise engine duty cycles corresponding to each vehicle configuration as follows:
  - (1) Set up GEM to simulate your engine’s operation based on your engine’s torque maps, steady-state fuel maps, warm-idle speed as defined in 40 CFR 1037.520(h)(1), and fuel consumption at idle as described in paragraphs (a)(1) and (2) of this section.
  - (2) Set up GEM with transmission parameters for different vehicle service classes and vehicle duty cycles. Specify the transmission’s torque limit for each gear as the engine’s maximum torque as determined in 40 CFR 1065.510. Specify the transmission type as Automatic Transmission for all engines and for all engine and vehicle duty cycles, except that the transmission type is Automated Manual Transmission for Heavy HDE operating over the highway cruise cycles or the SET duty cycle. For automatic transmissions set neutral idle to “Y” in the vehicle file. Select gear ratios for each gear as shown in the following table:

TABLE 1 TO PARAGRAPH (C)(2) OF § 1036.540—GEM INPUT FOR GEAR RATIO

Gear No.	Spark-ignition HDE, light HDE, and medium HDE—all engine and vehicle duty cycles	Heavy HDE—transient and FTP duty cycles	Heavy HDE—cruise and SET duty cycles
1	3.10	3.51	12.8
2	1.81	1.91	9.25
3	1.41	1.43	6.76
4	1.00	1.00	4.90
5	0.71	0.74	3.58
6	0.61	0.64	2.61
7			1.89
8			1.38
9			1.00
10			0.73
Lockup Gear	3	3	

(3) Run GEM for each simulated vehicle configuration and use the GEM outputs of instantaneous engine speed and engine flywheel torque for each vehicle configuration to generate a 10

Hz transient duty cycle corresponding to each vehicle configuration operating over each vehicle duty cycle. Run GEM for the specified number of vehicle configurations. You may run additional

vehicle configurations to represent a wider range of in-use vehicles. Run GEM as follows:



(i) *Determining axle ratio and tire size.* Set the axle ratio,  $k_a$ , and tire size,  $\frac{f_{ntire}}{v_{vehicle}}$ , for each vehicle configuration based on the corresponding designated engine speed ( $f_{nrefA}$ ,  $f_{nrefB}$ ,  $f_{nrefC}$ ,  $f_{nrefD}$ , or  $f_{ntest}$  as defined in 40 CFR 1065.610(c)(2)) at 65 mi/hr for the transient duty cycle and for the 65 mi/hr highway cruise cycle. Similarly, set these parameters based on the corresponding designated engine speed at 55 mi/hr for the 55 mi/hr highway cruise cycle. Use one of the following equations to determine  $\frac{f_{ntire}}{v_{vehicle}}$  and  $k_a$  at each of the defined engine speeds:

(A) Select a value for  $\left[\frac{f_{ntire}}{v_{vehicle}}\right]_{[speed]}$  and solve for  $k_{a[speed]}$  using the following

equation:

$$k_{a[speed]} = \frac{f_{n[speed]}}{\left[\frac{f_{ntire}}{v_{vehicle}}\right]_{[speed]} \cdot k_{topgear} \cdot v_{ref}}$$

Eq. 1036.540-1

Where:

$f_{n[speed]}$  = engine's angular speed as determined in paragraph (c)(3)(ii) or (iii) of this section.

$k_{topgear}$  = transmission gear ratio in the highest available gear from Table 1 of this section.

$v_{ref}$  = reference speed. Use 65 mi/hr for the transient cycle and the 65 mi/hr highway cruise cycle and use 55 mi/hr for the 55 mi/hr highway cruise cycle.

(B) Select a value for  $k_{a[speed]}$  and solve for  $\left[\frac{f_{ntire}}{v_{vehicle}}\right]_{[speed]}$  using the following equation:

$$\left[\frac{f_{ntire}}{v_{vehicle}}\right]_{[speed]} = \frac{f_{n[speed]}}{k_{a[speed]} \cdot k_{topgear} \cdot v_{ref}}$$

Eq. 1036.540-2

*Example for a vocational Light HDV or vocational Medium HDV with a 6-speed automatic transmission at B speed (Test 3 or 4 in Table 3 of this section):*

$$f_{nrefB} = 1870 \text{ r/min} = 31.17 \text{ r/s}$$

$$k_{aB} = 4.0$$

$$k_{topgear} = 0.61$$

$$v_{ref} = 65 \text{ mi/hr} = 29.06 \text{ m/s}$$

$$\left[\frac{f_{ntire}}{v_{vehicle}}\right]_B = \frac{31.17}{4.0 \cdot 0.61 \cdot 29.06} = 0.4396 \text{ r/m}$$

(ii) *Vehicle configurations for Spark-ignition HDE, Light HDE, and Medium HDE.* Test at least eight different vehicle

configurations for engines that will be installed in vocational Light HDV or

vocational Medium HDV using vehicles in the following table:

Table 2 to paragraph (c)(3)(ii) of § 1036.540—Vehicle Configurations for Testing Spark-ignition HDE, Light HDE, and Medium HDE

Parameter	Configuration							
	1	2	3	4	5	6	7	8
$C_{tr}$ (N/kN)	6.2	7.7	6.2	7.7	6.2	7.7	6.2	7.7
CI engine speed for $\frac{f_{ntire}}{v_{vehicle}}$ and $k_a$	$f_{nrefA}$	$f_{nrefA}$	$f_{nrefB}$	$f_{nrefB}$	$f_{nrefC}$	$f_{nrefC}$	$f_{ntest}$	$f_{ntest}$
SI engine speed for $\frac{f_{ntire}}{v_{vehicle}}$ and $k_a$	$f_{nrefD}$	$f_{nrefD}$	$f_{nrefA}$	$f_{nrefA}$	$f_{nrefB}$	$f_{nrefB}$	$f_{nrefC}$	$f_{nrefC}$
Drive Axle Configuration	4x2	4x2	4x2	4x2	4x2	4x2	4x2	4x2
GEM Regulatory Subcategory	LHD	MHD	LHD	MHD	LHD	MHD	LHD	MHD

(iii) *Vehicle configurations for Heavy HDE.* Test at least nine different vehicle configurations for engines that will be installed in vocational Heavy HDV and for tractors that are not heavy-haul tractors. Test six different vehicle configurations for engines that will be installed in heavy-haul tractors. Use the

settings specific to each vehicle configuration as shown in Table 3 or Table 4 in this section, as appropriate. Engines subject to testing under both Table 3 and Table 4 in this section need not repeat overlapping vehicle configurations, so complete fuel mapping requires testing 12 (not 15)

vehicle configurations for those engines. However, the preceding sentence does not apply if you choose to create two separate maps from the vehicle configurations defined in Table 3 and Table 4 in this section. Tables 3 and 4 follow:

Table 3 to paragraph (c)(3)(iii) of § 1036.540—Vehicle Configurations for Testing Heavy HDE Installed in General Purpose Tractors and Vocational Heavy HDV

Parameter	Configuration								
	1	2	3	4	5	6	7	8	9
$C_{tr}$ (N/kN)	6.9	6.9	6.9	6.9	6.9	6.9	6.9	6.9	6.9
$C_{dA}$	5.4	4.7	4.0	5.4	4.7	4.0	5.4	4.7	4.0
Engine speed for $\frac{f_{ntire}}{v_{vehicle}}$ and $k_a$	$f_{nrefD}$	$f_{nrefD}$	$f_{nrefD}$	$f_{nrefB}$	$f_{nrefB}$	$f_{nrefB}$	$f_{ntest}$	$f_{ntest}$	$f_{ntest}$
Drive Axle Configuration	6x4	6x4	4x2	6x4	6x4	4x2	6x4	6x4	4x2
GEM Regulatory Subcategory	C8_SC HR	C8_DC MR	C7_DC MR	C8_SC HR	C8_DC MR	C7_DC MR	C8_SC HR	C8_DC MR	C7_DC MR
Vehicle Weight Reduction (lbs)	0	13,275	6,147	0	13,275	6,147	0	13,275	6,147

Table 4 to paragraph (c)(3)(iii) of § 1036.540—Vehicle Configurations for Testing Heavy HDE Installed in Heavy-Haul Tractors

Parameter	Configuration					
	1	2	3	4	5	6
$C_{tr}$ (N/kN)	6.9	6.9	6.9	6.9	6.9	6.9
$C_{dA}$	5.0	5.4	5.0	5.4	5.0	5.4
Engine speed for $\frac{f_{ntire}}{v_{vehicle}}$ and $k_a$	$f_{nrefD}$	$f_{nrefD}$	$f_{nrefB}$	$f_{nrefB}$	$f_{ntest}$	$f_{ntest}$
Drive Axle Configuration	6x4	6x4	6x4	6x4	6x4	6x4
GEM Regulatory Subcategory	C8_HH	C8_SC_HR	C8_HH	C8_SC_HR	C8_HH	C8_SC_HR

(iv) *Vehicle configurations for mixed-use engines.* If the engine will be installed in a combination of vehicles defined in paragraphs (c)(3)(ii) and (iii) of this section, use good engineering judgment to select at least nine vehicle configurations from Table 2 and Table 3 in this section that best represent the range of vehicles your engine will be sold in. This may require you to define additional representative vehicle configurations. For example, if your engines will be installed in vocational Medium HDV and vocational Heavy HDV, you might select Tests 2, 4, 6 and 8 of Table 2 of this section to represent vocational Medium HDV and Tests 3, 6, and 9 of Table 3 in this section to represent vocational Heavy HDV and add two more vehicle configurations that you define.

(v) *Programming GEM.* Use the defined values in Tables 1 through 4 in this section to set up GEM with the correct regulatory subcategory and vehicle weight reduction.

(d) *Test the engine with GEM cycles.* Test the engine over each of the transient engine duty cycles generated in paragraph (c) of this section as follows:

(1) Operate the engine over a sequence of required and optional engine duty cycles as follows:

(i) Sort the list of engine duty cycles into three separate groups by vehicle duty cycle: Transient vehicle cycle, 55 mi/hr highway cruise cycle, and 65 mi/hr highway cruise cycle.

(ii) Within each group of engine duty cycles derived from the same vehicle duty cycle, first run the engine duty cycle with the highest reference cycle work, followed by the cycle with the lowest cycle work; followed by the cycle with second-highest cycle work, followed by the cycle with the second-lowest cycle work; continuing through all the cycles for that vehicle duty cycle. The series of engine duty cycles to represent a single vehicle duty cycle is a single fuel-mapping sequence. Each engine duty cycle represents a different interval. Repeat the fuel-mapping sequence for the engine duty cycles derived from the other vehicle duty cycles until testing is complete.

(iii) Operate the engine over two full engine duty cycles to precondition before each interval in the fuel-mapping sequence. Precondition the engine before the first and second engine duty cycle in each fuel-mapping sequence by repeating operation with the engine duty cycle with the highest reference cycle work over the relevant vehicle duty cycle. The preconditioning for the remaining cycles in the fuel-mapping

sequence consists of operation over the preceding two engine duty cycles in the fuel-mapping sequence (with or without measurement). For transient vehicle duty cycles, start each engine duty cycle within 10 seconds after finishing the preceding engine duty cycle (with or without measurement). For highway cruise cycles, start each engine duty cycle and interval after linearly ramping to the speed and torque setpoints over 5 seconds and stabilizing for 15 seconds.

(2) If the engine has an adjustable warm idle speed setpoint, set it to the value defined in 40 CFR 1037.520(h)(1).

(3) Control speed and torque to meet the cycle validation criteria in 40 CFR 1065.514 for each interval, except that the standard error of the estimate in Table 2 of 40 CFR 1065.514 is the only speed criterion that applies if the range of reference speeds is less than 10 percent of the mean reference speed. For spark-ignition gaseous-fueled engines with fuel delivery at a single point in the intake manifold, you may apply the statistical criteria in Table 5 in this section for transient testing. Note that 40 CFR part 1065 does not allow reducing cycle precision to a lower frequency than the 10 Hz reference cycle generated by GEM.

TABLE 5 TO PARAGRAPH (c)(3) OF § 1036.540—STATISTICAL CRITERIA FOR VALIDATING DUTY CYCLES FOR SPARK-IGNITION GASEOUS-FUELED ENGINES

Parameter	Speed	Torque	Power
Slope, $a_1$ .....	See 40 CFR 1065.514 ...	See 40 CFR 1065.514 .....	See 40 CFR 1065.514.
Absolute value of intercept, $ a_0 $ .....	See 40 CFR 1065.514 ...	$\leq 3\%$ of maximum mapped torque .....	See 40 CFR 1065.514.
Standard error of the estimate, $SEE$ .....	See 40 CFR 1065.514 ...	$\leq 15\%$ of maximum mapped torque ...	$\leq 15\%$ of maximum mapped power.
Coefficient of determination, $r^2$ .....	See 40 CFR 1065.514 ...	$\geq 0.700$ .....	$\geq 0.750$ .

(4) Record measurements using direct and/or indirect measurement of fuel flow as follows:

(i) *Direct fuel-flow measurement.* Record speed and torque and measure fuel consumption with a fuel flow meter for the interval defined by the engine duty cycle. Determine the corresponding mean values for the interval. Use of redundant direct fuel-flow measurements require prior EPA approval.

(ii) *Indirect fuel-flow measurement.* Record speed and torque and measure emissions and other inputs needed to run the chemical balance in 40 CFR 1065.655(c) for the interval defined by the engine duty cycle. Determine the corresponding mean values for the interval. Use of redundant indirect fuel-flow measurements require prior EPA approval. Measure background concentration as described in 40 CFR

1065.140, except that you may use one of the following methods to apply a single background reading to multiple intervals:

(A) If you use batch sampling to measure background emissions, you may sample periodically into the bag over the course of multiple intervals. If you use this provision, you must apply the same background readings to correct emissions from each of the applicable intervals.

(B) You may determine background emissions by sampling from the dilution air over multiple engine duty cycles. If you use this provision, you must allow sufficient time for stabilization of the background measurement; followed by an averaging period of at least 30 seconds. Use the average of the two background readings to correct the measurement from each engine duty cycle. The first background reading

must be taken no greater than 30 minutes before the start of the first applicable engine duty cycle and the second background reading must be taken no later than 30 minutes after the end of the last applicable engine duty cycle. Background readings may not span more than a full fuel-mapping sequence for a vehicle duty cycle.

(5) Warm up the engine as described in 40 CFR 1065.510(b)(2). Within 60 seconds after concluding the warm-up, start the linear ramp of speed and torque over 20 seconds to the first speed and torque setpoint of the preconditioning cycle.

(6) Precondition the engine before the start of testing as described in paragraph (d)(1)(iii) of this section.

(7) Operate the engine over the first engine duty cycle. Record measurements during the interval. Measure and report NO<sub>x</sub> emissions over

each interval as described in paragraph (b)(2) of this section.

(8) Continue testing engine duty cycles that are derived from the other vehicle duty cycles until testing is complete.

(9) You may interrupt the fuel-mapping sequence after completing any interval. You may calibrate analyzers, read and evacuate background bag samples, or sample dilution air for measuring background concentration before restarting. Shut down the engine during any interruption. If you restart the sequence within 30 minutes or less, restart the sequence at paragraph (d)(6) of this section and then restart testing at the next interval in the fuel-mapping sequence. If you restart the sequence after more than 30 minutes, restart the sequence at paragraph (d)(5) of this section and then restart testing at the next interval in the fuel-mapping sequence.

(10) The following provisions apply for infrequent regeneration events, other interruptions during intervals, and otherwise voided intervals:

(i) Stop testing if an infrequent regeneration event occurs during a interval or a interval is interrupted for any other reason. Void the interrupted interval and any additional intervals for which you are not able to meet requirements for measuring background concentration. If the infrequent regeneration event occurs between intervals, void completed intervals only if you are not able to meet requirements

for measuring background concentration for those intervals.

(ii) If an infrequent regeneration event occurs, allow the regeneration event to finish with the engine operating at a speed and load that allows effective regeneration.

(iii) If you interrupt testing during an interval, if you restart the sequence within 30 minutes or less, restart the sequence at paragraph (d)(6) of this section and then restart testing at the next interval in the fuel-mapping sequence. If you restart the sequence after more than 30 minutes, restart the sequence at paragraph (d)(5) of this section and then restart testing at the next interval in the fuel-mapping sequence.

(iv) If you void one or more intervals, you must perform additional testing to get results for all intervals. You may rerun a complete fuel-mapping sequence or any contiguous part of the fuel-mapping sequence. If you get a second valid measurement for any interval, use only the result from the last valid interval. If you restart the sequence within 30 minutes or less, restart the sequence at paragraph (d)(6) of this section and then restart testing at the first selected interval in the fuel-mapping sequence. If you restart the sequence after more than 30 minutes, restart the sequence at paragraph (d)(5) of this section and then restart testing at the first selected interval in the fuel-mapping sequence. Continue testing

until you have valid results for all intervals. The following examples illustrate possible scenarios for a partial run through a fuel-mapping sequence:

(A) If you voided only the interval associated with the fourth engine duty cycle in the sequence, you may restart the sequence using the second and third engine duty cycles as the preconditioning cycles and stop after completing the interval associated with the fourth engine duty cycle.

(B) If you voided the intervals associated with the fourth and sixth engine duty cycles, you may restart the sequence using the second and third engine duty cycles for preconditioning and stop after completing the interval associated with the sixth engine duty cycle.

(11) You may send signals to the engine controller during the test, such as current transmission gear and vehicle speed, if that allows engine operation during the to better represent in-use operation.

(12) Calculate the fuel mass flow rate,  $m_{\text{fuel}}$ , for each duty cycle using one of the following equations:

(i) Determine fuel-consumption rates using emission measurements from the raw or diluted exhaust, calculate the mass of fuel for each duty cycle,  $m_{\text{fuel[cycle]}}$ , as follows:

(A) For calculations that use continuous measurement of emissions and continuous CO<sub>2</sub> from urea, calculate  $m_{\text{fuel[cycle]}}$  using the following equation:

$$m_{\text{fuel[cycle]}} = \frac{M_C}{w_{\text{Cmeas}}} \cdot \left( \sum_{i=1}^N \left( \dot{n}_{\text{exhi}} \cdot \frac{x_{\text{Ccombdryi}}}{1 + x_{\text{H2Oexhdryi}}} \cdot \Delta t \right) - \frac{1}{M_{\text{CO2}}} \sum_{i=1}^N (\dot{m}_{\text{CO2DEFi}} \cdot \Delta t) \right)$$

Eq. 1036.540-3

Where:

$M_C$  = molar mass of carbon.

$w_{\text{Cmeas}}$  = carbon mass fraction of fuel (or mixture of fuels) as determined in 40 CFR 1065.655(d), except that you may not use the default properties in Table 2 of 40 CFR 1065.655 to determine  $\alpha$ ,  $\beta$ , and  $w_C$ . You may not account for the contribution to  $\alpha$ ,  $\beta$ ,  $\gamma$ , and  $\delta$  of diesel exhaust fluid or other non-fuel fluids injected into the exhaust.

$i$  = an indexing variable that represents one recorded emission value.

$N$  = total number of measurements over the duty cycle.

$\dot{n}_{\text{exh}}$  = exhaust molar flow rate from which you measured emissions.

$x_{\text{Ccombdry}}$  = amount of carbon from fuel and any injected fluids in the exhaust per mole of dry exhaust as determined in 40 CFR 1065.655(c).

$x_{\text{H2Oexhdry}}$  = amount of H<sub>2</sub>O in exhaust per mole of exhaust as determined in 40 CFR 1065.655(c).

$\Delta t = 1/f_{\text{record}}$

$M_{\text{CO2}}$  = molar mass of carbon dioxide.

$\dot{m}_{\text{CO2DEFi}}$  = mass emission rate of CO<sub>2</sub> resulting from diesel exhaust fluid decomposition over the duty cycle as determined from § 1036.535(b)(9). If your engine does not utilize diesel exhaust fluid for emission control, or if you choose not to perform this correction, set  $\dot{m}_{\text{CO2DEFi}}$  equal to 0.

Example:

$M_C = 12.0107$  g/mol

$w_{\text{Cmeas}} = 0.867$

$N = 6680$

$\dot{n}_{\text{exh1}} = 2.876$  mol/s

$\dot{n}_{\text{exh2}} = 2.224$  mol/s

$x_{\text{Ccombdry1}} = 2.61 \cdot 10^{-3}$  mol/mol

$x_{\text{Ccombdry2}} = 1.91 \cdot 10^{-3}$  mol/mol

$x_{\text{H2Oexh1}} = 3.53 \cdot 10^{-2}$  mol/mol

$x_{\text{H2Oexh2}} = 3.13 \cdot 10^{-2}$  mol/mol

$f_{\text{record}} = 10$  Hz

$\Delta t = 1/10 = 0.1$  s

$M_{\text{CO2}} = 44.0095$  g/mol

$\dot{m}_{\text{CO2DEF1}} = 0.0726$  g/s

$\dot{m}_{\text{CO2DEF2}} = 0.0751$  g/s

$m_{\text{fueltransientTest1}} =$

$$\frac{12.0107}{0.867} \cdot \left( \begin{array}{l} \left( 2.876 \cdot \frac{2.61 \cdot 10^{-3}}{1 + 3.53 \cdot 10^{-2}} \cdot 0.1 + \right. \\ \left. 2.224 \cdot \frac{1.91 \cdot 10^{-3}}{1 + 3.13 \cdot 10^{-2}} \cdot 0.1 + \right. \\ \left. \dots + \dot{n}_{\text{exh6680}} \cdot \frac{x_{\text{Ccombr6680}}}{1 + x_{\text{H2Oexhdry6680}}} \cdot \Delta t_{6680} \right) \\ - \frac{1}{44.0095} \cdot (0.0726 \cdot 1.0 + 0.0751 \cdot 1.0 + \dots + \dot{m}_{\text{CO2DEF6680}} \cdot \Delta t_{6680}) \end{array} \right)$$

$m_{\text{fueltransientTest1}} = 1619.6 \text{ g}$

(B) If you measure batch emissions and continuous CO<sub>2</sub> from urea, calculate

$m_{\text{fuel[cycle]}}$  using the following equation:

$$m_{\text{fuel[cycle]}} = \frac{M_C}{w_{\text{Cmeas}}} \cdot \left( \frac{\bar{x}_{\text{Ccombdry}}}{1 + \bar{x}_{\text{H2Oexhdry}}} \cdot \sum_{i=1}^N (\dot{n}_{\text{exhi}} \cdot \Delta t) - \frac{1}{M_{\text{CO2}}} \sum_{i=1}^N (\dot{m}_{\text{CO2DEFi}} \cdot \Delta t) \right)$$

Eq. 1036.540-4

(C) If you measure continuous emissions and batch CO<sub>2</sub> from urea, calculate

$m_{\text{fuel[cycle]}}$  using the following equation:

$$m_{\text{fuel[cycle]}} = \frac{M_C}{w_{\text{Cmeas}}} \cdot \left( \sum_{i=1}^N \left( \dot{n}_{\text{exhi}} \cdot \frac{x_{\text{Ccombdryi}}}{1 + x_{\text{H2Oexhdryi}}} \cdot \Delta t \right) - \frac{m_{\text{CO2DEF}}}{M_{\text{CO2}}} \right)$$

Eq. 1036.540-5

(D) If you measure batch emissions and batch CO<sub>2</sub> from urea, calculate  $m_{\text{fuel[cycle]}}$

using the following equation:

$$m_{\text{fuel[cycle]}} = \frac{M_C}{w_{\text{Cmeas}}} \cdot \left( \frac{\bar{x}_{\text{Ccombdry}}}{1 + \bar{x}_{\text{H2Oexhdry}}} \cdot \sum_{i=1}^N (\dot{n}_{\text{exhi}} \cdot \Delta t) - \frac{m_{\text{CO2DEF}}}{M_{\text{CO2}}} \right)$$

Eq. 1036.540-6

(ii) Manufacturers may choose to measure fuel mass flow rate. Calculate the mass of fuel

for each duty cycle,  $m_{\text{fuel[cycle]}}$ , as follows:

$$m_{\text{fuel}} = \sum_{i=1}^N \dot{m}_{\text{fueli}} \cdot \Delta t$$

Eq. 1036.540-7

Where:

$i$  = an indexing variable that represents one recorded value.

$N$  = total number of measurements over the duty cycle. For batch fuel mass measurements, set  $N = 1$ .

$\dot{m}_{fueli}$  = the fuel mass flow rate, for each point,  $i$ , starting from  $i = 1$ .

$\Delta t = 1/f_{record}$

$f_{record}$  = the data recording frequency.

Example:

$N = 6680$

$\dot{m}_{fuel1} = 1.856 \text{ g/s}$

$\dot{m}_{fuel2} = 1.962 \text{ g/s}$

$f_{record} = 10 \text{ Hz}$

$\Delta t = 1/10 = 0.1 \text{ s}$

$m_{fueltransient} = (1.856 + 1.962 + \dots + \dot{m}_{fuel6680}) \cdot 0.1$

$m_{fueltransient} = 111.95 \text{ g}$

(13) Correct the measured or calculated fuel mass flow rate,  $m_{fuel}$ , for each result to a mass-specific net energy content of a reference fuel as described in § 1036.535(e), replacing  $\bar{m}_{fuel}$  with  $m_{fuel}$  in Eq. 1036.535–4.

(e) *Determine GEM inputs.* Use the results of engine testing in paragraph (d) of this section to determine the GEM inputs for the transient duty cycle and

optionally for each of the highway cruise cycles corresponding to each simulated vehicle configuration as follows:

(1) Your declared fuel mass consumption,  $m_{fuel[cycle]}$ . Using the calculated fuel mass consumption values described in paragraph (d) of this section, declare values using the methods described in § 1036.535(g)(2) and (3).

(2) We will determine  $m_{fuel[cycle]}$  values using the method described in § 1036.535(g)(3).

(3) Engine output speed per unit vehicle speed,  $\left[ \frac{\bar{f}_{engine}}{\bar{v}_{vehicle}} \right]_{[cycle]}$ , by taking the average engine

speed measured during the engine test while the vehicle is moving and dividing it by the

average vehicle speed provided by GEM. Note that the engine cycle created by GEM has a

flag to indicate when the vehicle is moving.

(4) Positive work determined according to 40 CFR part 1065,  $W_{[cycle]}$ , by using the engine speed and engine torque measured during the engine test while the vehicle is moving. Note that the engine cycle created by GEM has a

flag to indicate when the vehicle is moving.

(5) The engine idle speed and torque, by taking the average engine speed and torque measured during the engine test while the vehicle is not moving. Note that the engine cycle created by GEM

has a flag to indicate when the vehicle is moving.

(6) The following table illustrates the GEM data inputs corresponding to the different vehicle configurations for a given duty cycle:

Table 6 to paragraph (e)(6) of § 1036.540—Example vehicle configuration test result output matrix for Class 8 vocational vehicles

	Vehicle Configuration Number								
	1	2	3	4	5	6	7	8	9
$m_{fuel[cycle]}$									
$\left[ \frac{\bar{f}_{engine}}{\bar{v}_{vehicle}} \right]_{[cycle]}$									
$W_{[cycle]}$									
$\bar{f}_{idle}^a$									
$\bar{T}_{idle}^a$									

<sup>a</sup>Idle speed and torque apply only for the transient duty cycle.

**§ 1036.543 Carbon balance error verification.**

The optional carbon balance error verification in 40 CFR 1065.543 compares independent assessments of the flow of carbon through the system (engine plus aftertreatment). This procedure applies for each individual interval in § 1036.535(b), (c), and (d), § 1036.540, and 40 CFR 1037.550.

**Subpart G—Special Compliance Provisions**

**§ 1036.601 Overview of compliance provisions.**

(a) Engine and vehicle manufacturers, as well as owners, operators, and rebuilders of engines subject to the requirements of this part, and all other persons, must observe the provisions of this part, the provisions of 40 CFR part

1068, and the provisions of the Clean Air Act. The provisions of 40 CFR part 1068 apply for heavy-duty highway engines as specified in that part, subject to the following provisions:

(1) The exemption provisions of 40 CFR 1068.201 through 1068.230, 1068.240, and 1068.260 through 265 apply for heavy-duty motor vehicle engines. The other exemption provisions, which are specific to

nonroad engines, do not apply for heavy-duty vehicles or heavy-duty engines.

(2) Engine signals to indicate a need for maintenance under § 1036.125(a)(1)(ii) are considered an element of design of the emission control system. Disabling, resetting, or otherwise rendering such signals inoperative without also performing the indicated maintenance procedure is therefore prohibited under 40 CFR 1068.101(b)(1).

(3) The warranty-related prohibitions in section 203(a)(4) of the Act (42 U.S.C. 7522(a)(4)) apply to manufacturers of new heavy-duty highway engines in addition to the prohibitions described in 40 CFR 1068.101(b)(6). We may assess a civil penalty up to \$44,539 for each engine or vehicle in violation.

(b) The following provisions from 40 CFR parts 85 and 86 continue to apply after model year 2026 for engines subject to the requirements of this part:

(1) The tampering prohibition in 40 CFR 1068.101(b)(1) applies for alternative fuel conversions as specified in 40 CFR part 85, subpart F.

(2) Engine manufacturers must meet service information requirements as specified in 40 CFR 86.010–38(j).

(3) Provisions related to nonconformance penalties apply as described in 40 CFR part 86, subpart L.

(4) The manufacturer-run in-use testing program applies as described in 40 CFR part 86, subpart T.

(c) The emergency vehicle field modification provisions of 40 CFR 85.1716 apply with respect to the standards of this part.

(d) Subpart C of this part describes how to test and certify dual-fuel and flexible-fuel engines. Some multi-fuel engines may not fit either of those defined terms. For such engines, we will determine whether it is most appropriate to treat them as single-fuel engines, dual-fuel engines, or flexible-fuel engines based on the range of possible and expected fuel mixtures. For example, an engine might burn natural gas but initiate combustion with a pilot injection of diesel fuel. If the engine is designed to operate with a single fueling algorithm (*i.e.*, fueling rates are fixed at a given engine speed and load condition), we would generally treat it as a single-fuel engine. In this context, the combination of diesel fuel and natural gas would be its own fuel type. If the engine is designed to also operate on diesel fuel alone, we would generally treat it as a dual-fuel engine. If the engine is designed to operate on varying mixtures of the two fuels, we would generally treat it as a flexible-fuel engine. To the extent that requirements

vary for the different fuels or fuel mixtures, we may apply the more stringent requirements.

#### **§ 1036.605 Alternate emission standards for engines used in specialty vehicles.**

Starting in model year 2027, compression-ignition engines at or above 56 kW and spark-ignition engines of any size that will be installed in specialty vehicles as allowed by 40 CFR 1037.605 are exempt from the standards of subpart B this part. Qualifying engines must certify under this part by meeting alternate emission standards as follows:

(a) Spark-ignition engines must be of a configuration that is identical to one that is certified under 40 CFR part 1048 to Blue Sky standards under 40 CFR 1048.140.

(b) Compression-ignition engines must be of a configuration that is identical to one that is certified under 40 CFR part 1039, and meet the following additional standards using the same duty cycles that apply under 40 CFR part 1039:

(1) The engines must be certified with a Family Emission Limit for PM of 0.020 g/kW-hr.

(2) Diesel-fueled engines using selective catalytic reduction must meet an emission standard of 0.1 g/kW-hr for N<sub>2</sub>O.

(c) Except as specified in this section, engines certified under this section must meet all the requirements that apply under 40 CFR part 1039 or 1048 instead of the comparable provisions in this part. Before shipping engines under this section, you must have written assurance from vehicle manufacturers that they need a certain number of exempted engines under this section. In your annual production report under 40 CFR 1039.250 or 1048.250, count these engines separately and identify the vehicle manufacturers that will be installing them. Treat these engines as part of the corresponding engine family under 40 CFR part 1039 or part 1048 for compliance purposes such as testing production engines, in-use testing, defect reporting, and recall.

(d) The engines must be labeled as described in § 1036.135, with the following statement instead of the one specified in § 1036.135(c)(8): “This engine conforms to alternate standards for specialty vehicles under 40 CFR 1036.605.” Engines certified under this section may not have the label specified for nonroad engines in 40 CFR part 1039 or part 1048 or any other label identifying them as nonroad engines.

(e) In a separate application for a certificate of conformity, identify the corresponding nonroad engine family,

describe the label required under section, state that you meet applicable diagnostic requirements under 40 CFR part 1039 or part 1048, and identify your projected U.S.-directed production volume.

(f) No additional certification fee applies for engines certified under this section.

(g) Engines certified under this section may not generate or use emission credits under this part or under 40 CFR part 1039. The vehicles in which these engines are installed may generate or use emission credits as described in 40 CFR part 1037.

#### **§ 1036.610 Off-cycle technology credits and adjustments for reducing greenhouse gas emissions.**

(a) You may ask us to apply the provisions of this section for CO<sub>2</sub> emission reductions resulting from powertrain technologies that were not in common use with heavy-duty vehicles before model year 2010 that are not reflected in the specified procedure. While you are not required to prove that such technologies were not in common use with heavy-duty vehicles before model year 2010, we will not approve your request if we determine that they do not qualify. We will apply these provisions only for technologies that will result in a measurable, demonstrable, and verifiable real-world CO<sub>2</sub> reduction. Note that prior to model year 2016, these technologies were referred to as “innovative technologies”.

(b) The provisions of this section may be applied as either an improvement factor (used to adjust emission results) or as a separate credit, consistent with good engineering judgment. Note that the term “credit” in this section describes an additive adjustment to emission rates and is not equivalent to an emission credit in the ABT program of subpart H of this part. We recommend that you base your credit/adjustment on A to B testing of pairs of engines/vehicles differing only with respect to the technology in question.

(1) Calculate improvement factors as the ratio of in-use emissions with the technology divided by the in-use emissions without the technology. Adjust the emission results by multiplying by the improvement factor. Use the improvement-factor approach where good engineering judgment indicates that the actual benefit will be proportional to emissions measured over the procedures specified in this part. For example, the benefits from technologies that reduce engine operation would generally be proportional to the engine’s emission rate.

(2) Calculate separate credits based on the difference between the in-use emission rate (g/ton-mile) with the technology and the in-use emission rate without the technology. Subtract this value from your measured emission result and use this adjusted value to determine your FEL. We may also allow you to calculate the credits based on g/hp-hr emission rates. Use the separate-credit approach where good engineering judgment indicates that the actual benefit will not be proportional to emissions measured over the procedures specified in this part.

(3) We may require you to discount or otherwise adjust your improvement factor or credit to account for uncertainty or other relevant factors.

(c) Send your request to the Designated Compliance Officer. We recommend that you do not begin collecting data (for submission to EPA) before contacting us. For technologies for which the vehicle manufacturer could also claim credits (such as transmissions in certain circumstances), we may require you to include a letter from the vehicle manufacturer stating that it will not seek credits for the same technology. Your request must contain the following items:

(1) A detailed description of the off-cycle technology and how it functions to reduce CO<sub>2</sub> emissions under conditions not represented on the duty cycles required for certification.

(2) A list of the engine configurations that will be equipped with the technology.

(3) A detailed description and justification of the selected engines.

(4) All testing and simulation data required under this section, plus any other data you have considered in your analysis. You may ask for our preliminary approval of your plan under § 1036.210.

(5) A complete description of the methodology used to estimate the off-cycle benefit of the technology and all supporting data, including engine testing and in-use activity data. Also include a statement regarding your recommendation for applying the provisions of this section for the given technology as an improvement factor or a credit.

(6) An estimate of the off-cycle benefit by engine model, and the fleetwide benefit based on projected sales of engine models equipped with the technology.

(7) A demonstration of the in-use durability of the off-cycle technology, based on any available engineering analysis or durability testing data (either by testing components or whole engines).

(d) We may seek public comment on your request, consistent with the provisions of 40 CFR 86.1869–12(d). However, we will generally not seek public comment on credits/adjustments based on A to B engine dynamometer testing, chassis testing, or in-use testing.

(e) We may approve an improvement factor or credit for any configuration that is properly represented by your testing.

(1) For model years before 2021, you may continue to use an approved improvement factor or credit for any appropriate engine families in future model years through 2020.

(2) For model years 2021 and later, you may not rely on an approval for model years before 2021. You must separately request our approval before applying an improvement factor or credit under this section for 2021 and later engines, even if we approved an improvement factor or credit for similar engine models before model year 2021. Note that approvals for model year 2021 and later may carry over for multiple years.

**§ 1036.615 Engines with Rankine cycle waste heat recovery and hybrid powertrains.**

This section specifies how to generate advanced-technology emission credits for hybrid powertrains that include energy storage systems and regenerative braking (including regenerative engine braking) and for engines that include Rankine-cycle (or other bottoming cycle) exhaust energy recovery systems. This section applies only for model year 2020 and earlier engines.

(a) *Pre-transmission hybrid powertrains.* Test pre-transmission hybrid powertrains with the hybrid engine procedures of 40 CFR part 1065 or with the post-transmission procedures in 40 CFR 1037.550. Pre-transmission hybrid powertrains are those engine systems that include features to recover and store energy during engine motoring operation but not from the vehicle's wheels. Engines certified with pre-transmission hybrid powertrains must be certified to meet the diagnostic requirements as specified in § 1036.110 with respect to powertrain components and systems; if different manufacturers produce the engine and the hybrid powertrain, the hybrid powertrain manufacturer may separately certify its powertrain relative to diagnostic requirements.

(b) *Rankine engines.* Test engines that include Rankine-cycle exhaust energy recovery systems according to the procedures specified in subpart F of this part unless we approve alternate procedures.

(c) *Calculating credits.* Calculate credits as specified in subpart H of this part. Credits generated from engines and powertrains certified under this section may be used in other averaging sets as described in § 1036.740(c).

(d) *Off-cycle technologies.* You may certify using both the provisions of this section and the off-cycle technology provisions of § 1036.610, provided you do not double-count emission benefits.

**§ 1036.620 Alternate CO<sub>2</sub> standards based on model year 2011 compression-ignition engines.**

For model years 2014 through 2016, you may certify your compression-ignition engines to the CO<sub>2</sub> standards of this section instead of the CO<sub>2</sub> standards in § 1036.108. However, you may not certify engines to these alternate standards if they are part of an averaging set in which you carry a balance of banked credits. You may submit applications for certifications before using up banked credits in the averaging set, but such certificates will not become effective until you have used up (or retired) your banked credits in the averaging set. For purposes of this section, you are deemed to carry credits in an averaging set if you carry credits from advanced technology that are allowed to be used in that averaging set.

(a) The standards of this section are determined from the measured emission rate of the engine of the applicable baseline 2011 engine family or families as described in paragraphs (b) and (c) of this section. Calculate the CO<sub>2</sub> emission rate of the baseline engine using the same equations used for showing compliance with the otherwise applicable standard. The alternate CO<sub>2</sub> standard for light and medium heavy-duty vocational-certified engines (certified for CO<sub>2</sub> using the transient cycle) is equal to the baseline emission rate multiplied by 0.975. The alternate CO<sub>2</sub> standard for tractor-certified engines (certified for CO<sub>2</sub> using the SET duty cycle) and all other Heavy HDE is equal to the baseline emission rate multiplied by 0.970. The in-use FEL for these engines is equal to the alternate standard multiplied by 1.03.

(b) This paragraph (b) applies if you do not certify all your engine families in the averaging set to the alternate standards of this section. Identify separate baseline engine families for each engine family that you are certifying to the alternate standards of this section. For an engine family to be considered the baseline engine family, it must meet the following criteria:

(1) It must have been certified to all applicable emission standards in model year 2011. If the baseline engine was



certified to a NO<sub>x</sub> FEL above the standard and incorporated the same emission control technologies as the new engine family, you may adjust the baseline CO<sub>2</sub> emission rate to be equivalent to an engine meeting the 0.20 g/hp-hr NO<sub>x</sub> standard (or your higher FEL as specified in this paragraph (b)(1)), using certification results from model years 2009 through 2011, consistent with good engineering judgment.

(i) Use the following equation to relate model year 2009–2011 NO<sub>x</sub> and CO<sub>2</sub> emission rates (g/hp-hr):  $CO_2 = a \times \log(NO_x) + b$ .

(ii) For model year 2014–2016 engines certified to NO<sub>x</sub> FELs above 0.20 g/hp-hr, correct the baseline CO<sub>2</sub> emissions to the actual NO<sub>x</sub> FELs of the 2014–2016 engines.

(iii) Calculate separate adjustments for emissions over the SET duty cycle and the transient cycle.

(2) The baseline configuration tested for certification must have the same engine displacement as the engines in the engine family being certified to the alternate standards, and its rated power must be within five percent of the highest rated power in the engine family being certified to the alternate standards.

(3) The model year 2011 U.S.-directed production volume of the configuration tested must be at least one percent of the total 2011 U.S.-directed production volume for the engine family.

(4) The tested configuration must have cycle-weighted BSFC equivalent to or better than all other configurations in the engine family.

(c) This paragraph (c) applies if you certify all your engine families in the primary intended service class to the alternate standards of this section. For purposes of this section, you may combine Light HDE and Medium HDE into a single averaging set. Determine your baseline CO<sub>2</sub> emission rate as the production-weighted emission rate of the certified engine families you produced in the 2011 model year. If you produce engines for both tractors and vocational vehicles, treat them as separate averaging sets. Adjust the CO<sub>2</sub> emission rates to be equivalent to an engine meeting the average NO<sub>x</sub> FEL of new engines (assuming engines certified to the 0.20 g/hp-hr NO<sub>x</sub> standard have a NO<sub>x</sub> FEL equal to 0.20 g/hp-hr), as described in paragraph (b)(1) of this section.

(d) Include the following statement on the emission control information label: “THIS ENGINE WAS CERTIFIED TO AN ALTERNATE CO<sub>2</sub> STANDARD UNDER § 1036.620.”

(e) You may not bank CO<sub>2</sub> emission credits for any engine family in the same averaging set and model year in which you certify engines to the standards of this section. You may not bank any advanced-technology credits in any averaging set for the model year you certify under this section (since such credits would be available for use in this averaging set). Note that the provisions of § 1036.745 apply for deficits generated with respect to the standards of this section.

(f) You need our approval before you may certify engines under this section, especially with respect to the numerical value of the alternate standards. We will not approve your request if we determine that you manipulated your engine families or engine configurations to certify to less stringent standards, or that you otherwise have not acted in good faith. You must keep and provide to us any information we need to determine that your engine families meet the requirements of this section. Keep these records for at least five years after you stop producing engines certified under this section.

#### **§ 1036.625 In-use compliance with CO<sub>2</sub> family emission limits (FELs).**

Section 1036.225 describes how to change the FEL for an engine family during the model year. This section, which describes how you may ask us to increase an engine family's CO<sub>2</sub> FEL after the end of the model year, is intended to address circumstances in which it is in the public interest to apply a higher in-use CO<sub>2</sub> FEL based on forfeiting an appropriate number of emission credits. For example, this may be appropriate where we determine that recalling vehicles would not significantly reduce in-use emissions. We will generally not allow this option where we determine the credits being forfeited would likely have expired.

(a) You may ask us to increase an engine family's FEL after the end of the model year if you believe some of your in-use engines exceed the CO<sub>2</sub> FEL that applied during the model year (or the CO<sub>2</sub> emission standard if the family did not generate or use emission credits). We may consider any available information in making our decision to approve or deny your request.

(b) If we approve your request under this section, you must apply emission credits to cover the increased FEL for all affected engines. Apply the emission credits as part of your credit demonstration for the current production year. Include the appropriate calculations in your final report under § 1036.730.

(c) Submit your request to the Designated Compliance Officer. Include the following in your request:

(1) Identify the names of each engine family that is the subject of your request. Include separate family names for different model years

(2) Describe why your request does not apply for similar engine models or additional model years, as applicable.

(3) Identify the FEL(s) that applied during the model year and recommend a replacement FEL for in-use engines; include a supporting rationale to describe how you determined the recommended replacement FEL.

(4) Describe whether the needed emission credits will come from averaging, banking, or trading.

(d) If we approve your request, we will identify the replacement FEL. The value we select will reflect our best judgment to accurately reflect the actual in-use performance of your engines, consistent with the testing provisions specified in this part. We may apply the higher FELs to other engine families from the same or different model years to the extent they used equivalent emission controls. We may include any appropriate conditions with our approval.

(e) If we order a recall for an engine family under 40 CFR 1068.505, we will no longer approve a replacement FEL under this section for any of your engines from that engine family, or from any other engine family that relies on equivalent emission controls.

#### **§ 1036.630 Certification of engine greenhouse gas emissions for powertrain testing.**

For engines included in powertrain families under 40 CFR part 1037, you may choose to include the corresponding engine emissions in your engine families under this part instead of (or in addition to) the otherwise applicable engine fuel maps.

(a) If you choose to certify powertrain fuel maps in an engine family, the declared powertrain emission levels become standards that apply for selective enforcement audits and in-use testing. We may require that you provide to us the engine cycle (not normalized) corresponding to a given powertrain for each of the specified duty cycles.

(b) If you choose to certify only fuel map emissions for an engine family and to not certify emissions over powertrain cycles under 40 CFR 1037.550, we will not presume you are responsible for emissions over the powertrain cycles. However, where we determine that you are responsible in whole or in part for the emission exceedance in such cases,

we may require that you participate in any recall of the affected vehicles. Note that this provision to limit your responsibility does not apply if you also hold the certificate of conformity for the vehicle.

(c) If you split an engine family into subfamilies based on different fuel-mapping procedures as described in § 1036.230(f)(2), the fuel-mapping procedures you identify for certifying each subfamily also apply for selective enforcement audits and in-use testing.

#### § 1036.635 [Reserved]

#### § 1036.655 Special provisions for diesel-fueled engines sold in American Samoa or the Commonwealth of the Northern Mariana Islands.

(a) The prohibitions in 40 CFR 1068.101(a)(1) do not apply to diesel-fueled engines, subject to the following conditions:

(1) The engine is intended for use and will be used in American Samoa or the Commonwealth of the Northern Mariana Islands.

(2) The engine meets the emission standards that applied to model year 2006 engines as specified in appendix A of this part.

(3) You meet all the requirements of 40 CFR 1068.265.

(b) If you introduce an engine into U.S. commerce under this section, you must meet the labeling requirements in § 1036.135, but add the following statement instead of the compliance statement in § 1036.135(c)(8):

THIS ENGINE (or VEHICLE, as applicable) CONFORMS TO US EPA EMISSION STANDARDS APPLICABLE TO MODEL YEAR 2006. THIS ENGINE (or VEHICLE, as applicable) DOES NOT CONFORM TO US EPA EMISSION REQUIREMENTS IN EFFECT AT TIME OF PRODUCTION AND MAY NOT BE IMPORTED INTO THE UNITED STATES OR ANY TERRITORY OF THE UNITED STATES EXCEPT AMERICAN SAMOA OR THE COMMONWEALTH OF THE NORTHERN MARIANA ISLANDS.

(c) Introducing into U.S. commerce an engine exempted under this section in any state or territory of the United States other than American Samoa or the Commonwealth of the Northern Mariana Islands, throughout its lifetime, violates the prohibitions in 40 CFR 1068.101(a)(1), unless it is exempt under a different provision.

(d) The exemption provisions in this section also applied for model year 2007 and later engines introduced into commerce in Guam before [the effective date of the final rule].

#### Subpart H—Averaging, Banking, and Trading for Certification

##### § 1036.701 General provisions.

(a) You may average, bank, and trade (ABT) emission credits for purposes of certification as described in this subpart and in subpart B of this part to show compliance with the standards of §§ 1036.104 and 1036.108. Participation in this program is voluntary. Note that certification to NO<sub>x</sub> standards in § 1036.104 is based on a Family Emission Limit (FEL) and certification to CO<sub>2</sub> standards in § 1036.108 is based on a Family Certification Level (FCL). This subpart refers to “FEL/FCL” to simultaneously refer to FELs for NO<sub>x</sub> and FCLs for CO<sub>2</sub>. Note also that subpart B of this part requires you to assign an FCL to all engine families, whether or not they participate in the ABT provisions of this subpart.

(b) The definitions of subpart I of this part apply to this subpart in addition to the following definitions:

(1) *Actual emission credits* means emission credits you have generated that we have verified by reviewing your final report.

(2) *Averaging set* means a set of engines in which emission credits may be exchanged. See § 1036.740.

(3) *Broker* means any entity that facilitates a trade of emission credits between a buyer and seller.

(4) *Buyer* means the entity that receives emission credits as a result of a trade.

(5) *Reserved emission credits* means emission credits you have generated that we have not yet verified by reviewing your final report.

(6) *Seller* means the entity that provides emission credits during a trade.

(7) *Standard* means the emission standard that applies under subpart B of this part for engines not participating in the ABT program of this subpart.

(8) *Trade* means to exchange emission credits, either as a buyer or seller.

(c) Emission credits may be exchanged only within an averaging set, except as specified in § 1036.740.

(d) You may not use emission credits generated under this subpart to offset any emissions that exceed an FEL/FCL or standard. This paragraph (d) applies for all testing, including certification testing, in-use testing, selective enforcement audits, and other production-line testing. However, if emissions from an engine exceed an FEL/FCL or standard (for example, during a selective enforcement audit), you may use emission credits to recertify the engine family with a higher

FEL/FCL that applies only to future production.

(e) You may use either of the following approaches to retire or forego emission credits:

(1) You may retire emission credits generated from any number of your engines. This may be considered donating emission credits to the environment. Identify any such credits in the reports described in § 1036.730. Engines must comply with the applicable FELs even if you donate or sell the corresponding emission credits. Donated credits may no longer be used by anyone to demonstrate compliance with any EPA emission standards.

(2) You may certify an engine family using an FEL/FCL below the emission standard as described in this part and choose not to generate emission credits for that family. If you do this, you do not need to calculate emission credits for those engine families, and you do not need to submit or keep the associated records described in this subpart for that family.

(f) Emission credits may be used in the model year they are generated. Surplus emission credits may be banked for future model years. Surplus emission credits may sometimes be used for past model years, as described in § 1036.745.

(g) You may increase or decrease an FEL/FCL during the model year by amending your application for certification under § 1036.225. The new FEL/FCL may apply only to engines you have not already introduced into commerce.

(h) See § 1036.740 for special credit provisions that apply for greenhouse gas credits generated under 40 CFR 86.1819–14(k)(7) or § 1036.615 or 40 CFR 1037.615.

(i) Unless the regulations in this part explicitly allow it, you may not calculate Phase 1 credits more than once for any emission reduction. For example, if you generate Phase 1 CO<sub>2</sub> emission credits for a hybrid engine under this part for a given vehicle, no one may generate CO<sub>2</sub> emission credits for that same hybrid engine and the associated vehicle under 40 CFR part 1037. However, Phase 1 credits could be generated for identical vehicles using engines that did not generate credits under this part.

(j) Credits you generate with compression-ignition engines in 2020 and earlier model years may be used in model year 2021 and later as follows:

(1) For credit-generating engines certified to the tractor engine standards in § 1036.108, you may use credits calculated relative to the tractor engine standards.

(2) For credit-generating engines certified to the vocational engine standards in § 1036.108, you may optionally carry over adjusted vocational credits from an averaging set, and you may use credits calculated relative to the emission levels in the following table:

TABLE 1 TO PARAGRAPH (j)(2) OF § 1036.701—EMISSION LEVELS FOR CREDIT CALCULATION

Medium heavy-duty engines	Heavy heavy-duty engines
558 g/hp-hr .....	525 g/hp-hr.

(k) Engine families you certify with a nonconformance penalty under 40 CFR part 86, subpart L, may not generate emission credits.

**§ 1036.705 Generating and calculating emission credits.**

(a) The provisions of this section apply separately for calculating emission credits for each pollutant.

(b) For each participating family, calculate positive or negative emission credits relative to the otherwise applicable emission standard. Calculate positive emission credits for a family that has an FEL/FCL below the standard. Calculate negative emission

credits for a family that has an FEL/FCL above the standard. Sum your positive and negative credits for the model year before rounding.

(1) Calculate emission credits to the nearest megagram (Mg) for each family or subfamily using the following equation:

$$Emission\ credits\ (Mg) = (Std - FL) \cdot CF \cdot Volume \cdot UL \cdot c$$

Eq. 1036.705-1

Where:

*Std* = the emission standard, in (mg NO<sub>x</sub>)/hp-hr or (g CO<sub>2</sub>)/hp-hr, that applies under subpart B of this part for engines not participating in the ABT program of this subpart (the “otherwise applicable standard”).

*FL* = the engine family’s FEL for NO<sub>x</sub>, in mg/hp-hr, and FCL for CO<sub>2</sub>, in g/hp-hr, rounded to the same number of decimal places as the emission standard.

*CF* = a transient cycle conversion factor (hp-hr/mile), calculated by dividing the total (integrated) horsepower-hour over the applicable duty cycle by 6.3 miles for engines subject to spark-ignition standards and 6.5 miles for engines subject to compression-ignition standards. This represents the average work performed over the duty cycle. See paragraph (b)(3) of this section for provisions that apply for CO<sub>2</sub>.

*Volume* = the number of engines eligible to participate in the averaging, banking, and trading program within the given engine family or subfamily during the model year, as described in paragraph (c) of this section.

*UL* = the useful life for the standard that applies for a given primary intended service class, in miles.

*c* = use 10<sup>-6</sup> for CO<sub>2</sub> and 10<sup>-9</sup> for NO<sub>x</sub>.

*Example for model year 2025 Heavy HDE generating CO<sub>2</sub> credits for a model year 2028 Heavy HDE:*

*Std* = 432 g/hp-hr

*FL* = 401 g/hp-hr

*CF* = 9.78 hp-hr/mile

*Volume* = 15,342

*UL* = 435,000 miles

*c* = 10<sup>-6</sup>

*Emission credits* = (432 – 401) · 9.78 · 15,342 · 435,000 · 10<sup>-6</sup> = 28,131,142 Mg

(2) [Reserved]

(3) The following additional provisions apply for calculating CO<sub>2</sub> credits:

(i) For engine families certified to both the vocational and tractor engine standards, calculate credits separately for the vocational engines and the tractor engines. We may allow you to use statistical methods to estimate the total production volumes where a small fraction of the engines cannot be tracked precisely.

(ii) Calculate the transient cycle conversion factor for vocational engines based on the average of vocational engine configurations weighted by their production volumes. Similarly, calculate the transient cycle conversion factor for tractor engines based on the average of tractor engine configurations weighted by their production volumes. Note that calculating the transient cycle conversion factor for tractors requires you to use the conversion factor even for engines certified to standards based on the SET duty cycle.

(iii) The FCL for CO<sub>2</sub> is based on measurement over the FTP duty cycle for vocational engines and over the SET duty cycle for tractor engines.

(4) You may not generate emission credits for tractor engines (*i.e.*, engines not certified to the transient cycle for CO<sub>2</sub>) installed in vocational vehicles (including vocational tractors certified under 40 CFR 1037.630 or exempted under 40 CFR 1037.631). We will waive this provision where you demonstrate that less than five percent of the engines in your tractor family were installed in vocational vehicles. For example, if you know that 96 percent of your tractor engines were installed in non-vocational tractors but cannot determine the

vehicle type for the remaining four percent, you may generate credits for all the engines in the family.

(5) You may generate CO<sub>2</sub> emission credits from a model year 2021 or later medium heavy-duty engine family subject to spark-ignition standards for exchanging with other engine families only if the engines in the family are gasoline-fueled. You may generate CO<sub>2</sub> credits from non-gasoline engine families only for the purpose of offsetting CH<sub>4</sub> and/or N<sub>2</sub>O emissions within the same engine family as described in paragraph (d) of this section.

(c) As described in § 1036.730, compliance with the requirements of this subpart is determined at the end of the model year based on actual U.S.-directed production volumes. Keep appropriate records to document these production volumes. Do not include any of the following engines to calculate emission credits:

(1) Engines that you do not certify to the CO<sub>2</sub> standards of this part because they are permanently exempted under subpart G of this part or under 40 CFR part 1068.

(2) Exported engines.

(3) Engines not subject to the requirements of this part, such as those excluded under § 1036.5. For example, do not include engines used in vehicles certified to the greenhouse gas standards of 40 CFR 86.1819.

(4) Any other engines if we indicate elsewhere in this part that they are not to be included in the calculations of this subpart.

(d) You may use CO<sub>2</sub> emission credits to show compliance with CH<sub>4</sub> and/or N<sub>2</sub>O FELs instead of the otherwise applicable emission standards. To do

this, calculate the CH<sub>4</sub> and/or N<sub>2</sub>O emission credits needed (negative credits) using the equation in paragraph (b) of this section, using the FEL(s) you specify for your engines during certification instead of the FCL. You must use 34 Mg of positive CO<sub>2</sub> credits to offset 1 Mg of negative CH<sub>4</sub> credits for model year 2021 and later engines, and you must use 25 Mg of positive CO<sub>2</sub> credits to offset 1 Mg of negative CH<sub>4</sub> credits for earlier engines. You must use 298 Mg of positive CO<sub>2</sub> credits to offset 1 Mg of negative N<sub>2</sub>O credits.

#### **§ 1036.710 Averaging.**

(a) Averaging is the exchange of emission credits among your engine families. You may average emission credits only within the same averaging set, except as specified in § 1036.740.

(b) You may certify one or more engine families to an FEL/FCL above the applicable standard, subject to any applicable FEL caps and other the provisions in subpart B of this part, if you show in your application for certification that your projected balance of all emission-credit transactions in that model year is greater than or equal to zero, or that a negative balance is allowed under § 1036.745.

(c) If you certify an engine family to an FEL/FCL that exceeds the otherwise applicable standard, you must obtain enough emission credits to offset the engine family's deficit by the due date for the final report required in § 1036.730. The emission credits used to address the deficit may come from your other engine families that generate emission credits in the same model year (or from later model years as specified in § 1036.745), from emission credits you have banked, or from emission credits you obtain through trading.

#### **§ 1036.715 Banking.**

(a) Banking is the retention of surplus emission credits by the manufacturer generating the emission credits for use in future model years for averaging or trading.

(b) You may designate any emission credits you plan to bank in the reports you submit under § 1036.730 as reserved credits. During the model year and before the due date for the final report, you may designate your reserved emission credits for averaging or trading.

(c) Reserved credits become actual emission credits when you submit your final report. However, we may revoke these emission credits if we are unable to verify them after reviewing your reports or auditing your records.

(d) Banked credits retain the designation of the averaging set in which they were generated.

#### **§ 1036.720 Trading.**

(a) Trading is the exchange of emission credits between manufacturers. You may use traded emission credits for averaging, banking, or further trading transactions. Traded emission credits remain subject to the averaging-set restrictions based on the averaging set in which they were generated.

(b) You may trade actual emission credits as described in this subpart. You may also trade reserved emission credits, but we may revoke these emission credits based on our review of your records or reports or those of the company with which you traded emission credits. You may trade banked credits within an averaging set to any certifying manufacturer.

(c) If a negative emission credit balance results from a transaction, both the buyer and seller are liable, except in cases we deem to involve fraud. See § 1036.255(e) for cases involving fraud. We may void the certificates of all engine families participating in a trade that results in a manufacturer having a negative balance of emission credits. See § 1036.745.

#### **§ 1036.725 Required information for certification.**

(a) You must declare in your application for certification your intent to use the provisions of this subpart for each engine family that will be certified using the ABT program. You must also declare the FEL/FCL you select for the engine family for each pollutant for which you are using the ABT program. Your FELs must comply with the specifications of subpart B of this part, including the FEL caps.

(b) Include the following in your application for certification:

(1) A statement that, to the best of your belief, you will not have a negative balance of emission credits for any averaging set when all emission credits are calculated at the end of the year; or a statement that you will have a negative balance of emission credits for one or more averaging sets, but that it is allowed under § 1036.745.

(2) Detailed calculations of projected emission credits (positive or negative) based on projected U.S.-directed production volumes. We may require you to include similar calculations from your other engine families to project your net credit balances for the model year. If you project negative emission credits for a family, state the source of positive emission credits you expect to

use to offset the negative emission credits.

#### **§ 1036.730 ABT reports.**

(a) If you certify any of your engine families using the ABT provisions of this subpart, you must send us a final report by September 30 following the end of the model year.

(b) Your report must include the following information for each engine family participating in the ABT program:

(1) Engine-family designation and averaging set.

(2) The emission standards that would otherwise apply to the engine family.

(3) The FEL/FCL for each pollutant. If you change the FEL/FCL after the start of production, identify the date that you started using the new FEL/FCL and/or give the engine identification number for the first engine covered by the new FEL/FCL. In this case, identify each applicable FEL/FCL and calculate the positive or negative emission credits as specified in § 1036.225(f).

(4) The projected and actual U.S.-directed production volumes for the model year. If you changed an FEL/FCL during the model year, identify the actual U.S.-directed production volume associated with each FEL/FCL.

(5) The transient cycle conversion factor for each engine configuration as described in § 1036.705.

(6) Useful life.

(7) Calculated positive or negative emission credits for the whole engine family. Identify any emission credits that you traded, as described in paragraph (d)(1) of this section.

(c) Your report must include the following additional information:

(1) Show that your net balance of emission credits from all your participating engine families in each averaging set in the applicable model year is not negative, except as allowed under § 1036.745. Your credit tracking must account for the limitation on credit life under § 1036.740(d).

(2) State whether you will reserve any emission credits for banking.

(3) State that the report's contents are accurate.

(d) If you trade emission credits, you must send us a report within 90 days after the transaction, as follows:

(1) As the seller, you must include the following information in your report:

(i) The corporate names of the buyer and any brokers.

(ii) A copy of any contracts related to the trade.

(iii) The averaging set corresponding to the engine families that generated emission credits for the trade, including the number of emission credits from each averaging set.

(2) As the buyer, you must include the following information in your report:

(i) The corporate names of the seller and any brokers.

(ii) A copy of any contracts related to the trade.

(iii) How you intend to use the emission credits, including the number of emission credits you intend to apply for each averaging set.

(e) Send your reports electronically to the Designated Compliance Officer using an approved information format. If you want to use a different format, send us a written request with justification for a waiver.

(f) Correct errors in your report as follows:

(1) If you or we determine by September 30 after the end of the model year that errors mistakenly decreased your balance of emission credits, you may correct the errors and recalculate the balance of emission credits. You may not make these corrections for errors that are determined later than September 30 after the end of the model year. If you report a negative balance of emission credits, we may disallow corrections under this paragraph (f)(1).

(2) If you or we determine any time that errors mistakenly increased your balance of emission credits, you must correct the errors and recalculate the balance of emission credits.

#### § 1036.735 Recordkeeping.

(a) You must organize and maintain your records as described in this section. We may review your records at any time.

(b) Keep the records required by this section for at least eight years after the due date for the end-of-year report. You may not use emission credits for any engines if you do not keep all the records required under this section. You must therefore keep these records to continue to bank valid credits. Store these records in any format and on any media, as long as you can promptly send us organized, written records in English if we ask for them. You must keep these records readily available. We may review them at any time.

(c) Keep a copy of the reports we require in §§ 1036.725 and 1036.730.

(d) Keep records of the engine identification number (usually the serial number) for each engine you produce that generates or uses emission credits under the ABT program. You may identify these numbers as a range. If you change the FEL after the start of production, identify the date you started using each FEL/FCL and the range of engine identification numbers associated with each FEL/FCL. You must also identify the purchaser and

destination for each engine you produce to the extent this information is available.

(e) We may require you to keep additional records or to send us relevant information not required by this section in accordance with the Clean Air Act.

#### § 1036.740 Restrictions for using emission credits.

The following restrictions apply for using emission credits:

(a) *Averaging sets.* Except as specified in paragraph (c) of this section, emission credits may be exchanged only within the following averaging sets based on primary intended service class:

- (1) Spark-ignition HDE.
- (2) Light HDE.
- (3) Medium HDE.
- (4) Heavy HDE.

(b) *Applying credits to prior year deficits.* Where your CO<sub>2</sub> credit balance for the previous year is negative, you may apply credits to that deficit only after meeting your credit obligations for the current year.

(c) *CO<sub>2</sub> credits from hybrid engines and other advanced technologies.* CO<sub>2</sub> credits you generate under § 1036.615 may be used for any of the averaging sets identified in paragraph (a) of this section; you may also use those credits to demonstrate compliance with the CO<sub>2</sub> emission standards in 40 CFR 86.1819 and 40 CFR part 1037. Similarly, you may use Phase 1 advanced-technology credits generated under 40 CFR 86.1819–14(k)(7) or 40 CFR 1037.615 to demonstrate compliance with the CO<sub>2</sub> standards in this part. In the case of Spark-ignition HDE and Light HDE you may not use more than 60,000 Mg of credits from other averaging sets in any model year.

(1) The maximum CO<sub>2</sub> credits you may bring into the following service class groups is 60,000 Mg per model year:

(i) Spark-ignition HDE, Light HDE, and Light HDV. This group comprises the averaging sets listed in paragraphs (a)(1) and (2) of this section and the averaging set listed in 40 CFR 1037.740(a)(1).

(ii) Medium HDE and Medium HDV. This group comprises the averaging sets listed in paragraph (a)(3) of this section and 40 CFR 1037.740(a)(2).

(iii) Heavy HDE and Heavy HDV. This group comprises the averaging sets listed in paragraph (a)(4) of this section and 40 CFR 1037.740(a)(3).

(2) Paragraph (c)(1) of this section does not limit the advanced-technology credits that can be used within a service class group if they were generated in that same service class group.

(d) *NO<sub>x</sub> and CO<sub>2</sub> credit life.* NO<sub>x</sub> and CO<sub>2</sub> credits may be used only for five

model years after the year in which they are generated. For example, credits you generate in model year 2027 may be used to demonstrate compliance with emission standards only through model year 2032.

(e) *Other restrictions.* Other sections of this part specify additional restrictions for using emission credits under certain special provisions.

#### § 1036.741 Using emission credits from electric vehicles and hydrogen fuel-cell vehicles.

NO<sub>x</sub> credits you generate under 40 CFR 1037.616 from electric vehicles may be used to demonstrate compliance with the NO<sub>x</sub> emission standards in this part as follows:

(a) Credits may be averaged, banked, or traded as described in this subpart H.

(b) Averaging sets apply as specified in § 1036.740 and 40 CFR 1037.102(b)(1).

(c) Banked credits may be used only for five model years as described in § 1036.740(d).

#### § 1036.745 End-of-year CO<sub>2</sub> credit deficits.

Except as allowed by this section, we may void the certificate of any engine family certified to an FCL above the applicable standard for which you do not have sufficient credits by the deadline for submitting the final report.

(a) Your certificate for an engine family for which you do not have sufficient CO<sub>2</sub> credits will not be void if you remedy the deficit with surplus credits within three model years. For example, if you have a credit deficit of 500 Mg for an engine family at the end of model year 2015, you must generate (or otherwise obtain) a surplus of at least 500 Mg in that same averaging set by the end of model year 2018.

(b) You may not bank or trade away CO<sub>2</sub> credits in the averaging set in any model year in which you have a deficit.

(c) You may apply only surplus credits to your deficit. You may not apply credits to a deficit from an earlier model year if they were generated in a model year for which any of your engine families for that averaging set had an end-of-year credit deficit.

(d) You must notify us in writing how you plan to eliminate the credit deficit within the specified time frame. If we determine that your plan is unreasonable or unrealistic, we may deny an application for certification for a vehicle family if its FEL would increase your credit deficit. We may determine that your plan is unreasonable or unrealistic based on a consideration of past and projected use of specific technologies, the historical sales mix of your vehicle models, your

commitment to limit production of higher-emission vehicles, and expected access to traded credits. We may also consider your plan unreasonable if your credit deficit increases from one model year to the next. We may require that you send us interim reports describing your progress toward resolving your credit deficit over the course of a model year.

(e) If you do not remedy the deficit with surplus credits within three model years, we may void your certificate for that engine family. We may void the certificate based on your end-of-year report. Note that voiding a certificate applies *ab initio*. Where the net deficit is less than the total amount of negative credits originally generated by the family, we will void the certificate only with respect to the number of engines needed to reach the amount of the net deficit. For example, if the original engine family generated 500 Mg of negative credits, and the manufacturer's net deficit after three years was 250 Mg, we would void the certificate with respect to half of the engines in the family.

(f) For purposes of calculating the statute of limitations, the following actions are all considered to occur at the expiration of the deadline for offsetting a deficit as specified in paragraph (a) of this section:

- (1) Failing to meet the requirements of paragraph (a) of this section.
- (2) Failing to satisfy the conditions upon which a certificate was issued relative to offsetting a deficit.
- (3) Selling, offering for sale, introducing or delivering into U.S. commerce, or importing vehicles that are found not to be covered by a certificate as a result of failing to offset a deficit.

#### **§ 1036.750 Consequences for noncompliance.**

(a) For each engine family participating in the ABT program, the certificate of conformity is conditioned upon full compliance with the provisions of this subpart during and after the model year. You are responsible to establish to our satisfaction that you fully comply with applicable requirements. We may void the certificate of conformity for an engine family if you fail to comply with any provisions of this subpart.

(b) You may certify your engine family to an FEL/FCL above an applicable standard based on a projection that you will have enough emission credits to offset the deficit for the engine family. See § 1036.745 for provisions specifying what happens if you cannot show in your final report

that you have enough actual emission credits to offset a deficit for any pollutant in an engine family.

(c) We may void the certificate of conformity for an engine family if you fail to keep records, send reports, or give us information we request. Note that failing to keep records, send reports, or give us information we request is also a violation of 42 U.S.C. 7522(a)(2).

(d) You may ask for a hearing if we void your certificate under this section (see § 1036.820).

#### **§ 1036.755 Information provided to the Department of Transportation.**

After receipt of each manufacturer's final report as specified in § 1036.730 and completion of any verification testing required to validate the manufacturer's submitted final data, we will issue a report to the Department of Transportation with CO<sub>2</sub> emission information and will verify the accuracy of each manufacturer's equivalent fuel consumption data that required by NHTSA under 49 CFR 535.8. We will send a report to DOT for each engine manufacturer based on each regulatory category and subcategory, including sufficient information for NHTSA to determine fuel consumption and associated credit values. See 49 CFR 535.8 to determine if NHTSA deems submission of this information to EPA to also be a submission to NHTSA.

#### **Subpart I—Definitions and Other Reference Information**

##### **§ 1036.801 Definitions.**

The following definitions apply to this part. The definitions apply to all subparts unless we note otherwise. All undefined terms have the meaning the Act gives to them. The definitions follow:

*Act* means the Clean Air Act, as amended, 42 U.S.C. 7401–7671q.

*Adjustable parameter* has the meaning given in 40 CFR 1068.50.

*Advanced technology* means technology certified under 40 CFR 86.1819–14(k)(7), § 1036.615, or 40 CFR 1037.615.

*Aftertreatment* means relating to a catalytic converter, particulate filter, or any other system, component, or technology mounted downstream of the exhaust valve (or exhaust port) whose design function is to decrease emissions in the engine exhaust before it is exhausted to the environment. Exhaust gas recirculation (EGR) and turbochargers are not aftertreatment.

*Aircraft* means any vehicle capable of sustained air travel more than 100 feet above the ground.

*Alcohol-fueled engine* mean an engine that is designed to run using an alcohol

fuel. For purposes of this definition, alcohol fuels do not include fuels with a nominal alcohol content below 25 percent by volume.

*Auxiliary emission control device* means any element of design that senses temperature, motive speed, engine speed (r/min), transmission gear, or any other parameter for the purpose of activating, modulating, delaying, or deactivating the operation of any part of the emission control system.

*Averaging set* has the meaning given in § 1036.740.

*Calibration* means the set of specifications and tolerances specific to a particular design, version, or application of a component or assembly capable of functionally describing its operation over its working range.

*Carryover* means relating to certification based on emission data generated from an earlier model year as described in § 1036.235(d).

*Certification* means relating to the process of obtaining a certificate of conformity for an engine family that complies with the emission standards and requirements in this part.

*Certified emission level* means the highest deteriorated emission level in an engine family for a given pollutant from the applicable transient and/or steady-state testing, rounded to the same number of decimal places as the applicable standard. Note that you may have two certified emission levels for CO<sub>2</sub> if you certify a family for both vocational and tractor use.

*Charge-depleting* has the meaning given in 40 CFR 1066.1001.

*Charge-sustaining* has the meaning given in 40 CFR 1066.1001.

*Complete vehicle* means a vehicle meeting the definition of complete vehicle in 40 CFR 1037.801 when it is first sold as a vehicle. For example, where a vehicle manufacturer sells an incomplete vehicle to a secondary vehicle manufacturer, the vehicle is not a complete vehicle under this part, even after its final assembly.

*Compression-ignition* means relating to a type of reciprocating, internal-combustion engine that is not a spark-ignition engine. Note that § 1036.1 also deems gas turbine engines and other engines to be compression-ignition engines.

*Crankcase emissions* means airborne substances emitted to the atmosphere from any part of the engine crankcase's ventilation or lubrication systems. The crankcase is the housing for the crankshaft and other related internal parts.

*Criteria pollutants* means emissions of NO<sub>x</sub>, HC, PM, and CO.

*Critical emission-related component* has the meaning given in 40 CFR 1068.30.

*Defeat device* has the meaning given in § 1036.115(h).

*Designated Compliance Officer* means one of the following:

(1) For engines subject to compression-ignition standards, *Designated Compliance Officer* means Director, Diesel Engine Compliance Center, U.S. Environmental Protection Agency, 2000 Traverwood Drive, Ann Arbor, MI 48105; [complianceinfo@epa.gov](mailto:complianceinfo@epa.gov); [www.epa.gov/ve-certification](http://www.epa.gov/ve-certification).

(2) For engines subject to spark-ignition standards, *Designated Compliance Officer* means Director, Gasoline Engine Compliance Center, U.S. Environmental Protection Agency, 2000 Traverwood Drive, Ann Arbor, MI 48105; [nonroad-si-cert@epa.gov](mailto:nonroad-si-cert@epa.gov); [www.epa.gov/ve-certification](http://www.epa.gov/ve-certification).

*Deteriorated emission level* means the emission level that results from applying the appropriate deterioration factor to the official emission result of the emission-data engine. Note that where no deterioration factor applies, references in this part to the *deteriorated emission level* mean the official emission result.

*Deterioration factor* means the relationship between emissions at the end of useful life (or point of highest emissions if it occurs before the end of useful life) and emissions at the low-hour/low-mileage point, expressed in one of the following ways:

(1) For multiplicative deterioration factors, the ratio of emissions at the end of useful life (or point of highest emissions) to emissions at the low-hour point.

(2) For additive deterioration factors, the difference between emissions at the end of useful life (or point of highest emissions) and emissions at the low-hour point.

*Diesel exhaust fluid (DEF)* means a liquid reducing agent (other than the engine fuel) used in conjunction with selective catalytic reduction to reduce NO<sub>x</sub> emissions. *Diesel exhaust fluid* is generally understood to be an aqueous solution of urea conforming to the specifications of ISO 22241.

*Dual-fuel* means relating to an engine designed for operation on two different types of fuel but not on a continuous mixture of those fuels (see § 1036.601(d)). For purposes of this part, such an engine remains a dual-fuel engine even if it is designed for operation on three or more different fuels.

*Electronic control module (ECM)* means an engine's electronic device that

uses data from engine sensors to control engine parameters.

*Engine control system* means any device, system, or element of design that controls or reduces the emissions of regulated pollutants from an engine.

*Emission-data engine* means an engine that is tested for certification. This includes engines tested to establish deterioration factors.

*Emission-related component* has the meaning given in 40 CFR part 1068, appendix A.

*Emission-related maintenance* means maintenance that substantially affects emissions or is likely to substantially affect emission deterioration.

*Engine configuration* means a unique combination of engine hardware and calibration (related to the emission standards) within an engine family, which would include hybrid components for engines certified as hybrid engines and hybrid powertrains. Engines within a single engine configuration differ only with respect to normal production variability or factors unrelated to compliance with emission standards.

*Engine family* has the meaning given in § 1036.230.

*Excluded* means relating to engines that are not subject to some or all of the requirements of this part as follows:

(1) An engine that has been determined not to be a heavy-duty engine is excluded from this part.

(2) Certain heavy-duty engines are excluded from the requirements of this part under § 1036.5.

(3) Specific regulatory provisions of this part may exclude a heavy-duty engine generally subject to this part from one or more specific standards or requirements of this part.

*Exempted* has the meaning given in 40 CFR 1068.30.

*Exhaust gas recirculation* means a technology that reduces emissions by routing exhaust gases that had been exhausted from the combustion chamber(s) back into the engine to be mixed with incoming air before or during combustion. The use of valve timing to increase the amount of residual exhaust gas in the combustion chamber(s) that is mixed with incoming air before or during combustion is not considered exhaust gas recirculation for the purposes of this part.

*Family certification level (FCL)* means a CO<sub>2</sub> emission level declared by the manufacturer that is at or above emission results for all emission-data engines. The FCL serves as the emission standard for the engine family with respect to certification testing if it is different than the otherwise applicable standard.

*Family emission limit (FEL)* means one of the following:

(1) For NO<sub>x</sub> emissions, *family emission limit (FEL)* means a NO<sub>x</sub> emission level declared by the manufacturer to serve in place of an otherwise applicable emission standard under the ABT program in subpart H of this part. The FEL serves as the emission standard for the engine family with respect to all required testing.

(2) For greenhouse gas standards, *family emission limit (FEL)* is the standard that applies for testing individual engines. The CO<sub>2</sub> FEL is equal to the CO<sub>2</sub> FCL multiplied by 1.03 and rounded to the same number of decimal places as the standard.

*Federal Test Procedure (FTP)* means the applicable transient duty cycle described in § 1036.510 designed to measure exhaust emissions during urban driving.

*Flexible-fuel* means relating to an engine designed for operation on any mixture of two or more different types of fuels (see § 1036.601(d)).

*Fuel type* means a general category of fuels such as diesel fuel, gasoline, or natural gas. There can be multiple grades within a single fuel type, such as premium gasoline, regular gasoline, or gasoline with 10 percent ethanol.

*Good engineering judgment* has the meaning given in 40 CFR 1068.30. See 40 CFR 1068.5 for the administrative process we use to evaluate good engineering judgment.

*Greenhouse gas* means one or more compounds regulated under this part based primarily on their impact on the climate. This generally includes CO<sub>2</sub>, CH<sub>4</sub>, and N<sub>2</sub>O.

*Greenhouse gas Emissions Model (GEM)* means the GEM simulation tool described in 40 CFR 1037.520. Note that an updated version of GEM applies starting in model year 2021.

*Gross vehicle weight rating (GVWR)* means the value specified by the vehicle manufacturer as the maximum design loaded weight of a single vehicle, consistent with good engineering judgment.

*Heavy-duty engine* means any engine which the engine manufacturer could reasonably expect to be used for motive power in a heavy-duty vehicle. For purposes of this definition in this part, the term "engine" includes internal combustion engines and other devices that convert chemical fuel into motive power. For example, a fuel cell or a gas turbine used in a heavy-duty vehicle is a heavy-duty engine.

*Heavy-duty vehicle* means any motor vehicle above 8,500 pounds GVWR. An incomplete vehicle is also a heavy-duty vehicle if it has a curb weight above

6,000 pounds or a basic vehicle frontal area greater than 45 square feet. *Curb weight* and *basic vehicle frontal area* have the meaning given in 40 CFR 86.1803–01.

*Hybrid* means an engine or powertrain that includes energy storage features other than a conventional battery system or conventional flywheel. Supplemental electrical batteries and hydraulic accumulators are examples of hybrid energy storage systems. Note that certain provisions in this part treat hybrid engines and hybrid powertrains intended for vehicles that include regenerative braking different than those intended for vehicles that do not include regenerative braking.

*Hybrid engine* means a hybrid system with features for storing and recovering energy that are integral to the engine or are otherwise upstream of the vehicle's transmission other than a conventional battery system or conventional flywheel. Supplemental electrical batteries and hydraulic accumulators are examples of hybrid energy storage systems.

Examples of hybrids that could be considered hybrid engines are P0, P1, and P2 hybrids where hybrid features are connected to the front end of the engine, at the crankshaft, or connected between the clutch and the transmission where the clutch upstream of the hybrid feature is in addition to the transmission clutch(s), respectively. Note other examples of systems that qualify as hybrid engines are systems that recover kinetic energy and use it to power an electric heater in the aftertreatment.

*Hybrid powertrain* means a powertrain that includes energy storage features other than a conventional battery system or conventional flywheel. Supplemental electrical batteries and hydraulic accumulators are examples of hybrid energy storage systems. Note other examples of systems that qualify as hybrid powertrains are systems that recover kinetic energy and use it to power an electric heater in the aftertreatment.

*Hydrocarbon (HC)* has the meaning given in 40 CFR 1065.1001.

*Identification number* means a unique specification (for example, a model number/serial number combination) that allows someone to distinguish a particular engine from other similar engines.

*Incomplete vehicle* means a vehicle meeting the definition of incomplete vehicle in 40 CFR 1037.801 when it is first sold (or otherwise delivered to another entity) as a vehicle.

*Innovative technology* means technology certified under § 1036.610 (also described as “off-cycle technology”).

*Liquefied petroleum gas (LPG)* means a liquid hydrocarbon fuel that is stored under pressure and is composed primarily of nonmethane compounds that are gases at atmospheric conditions. Note that, although this commercial term includes the word “petroleum”, LPG is not considered to be a petroleum fuel under the definitions of this section.

*Low-hour* means relating to an engine that has stabilized emissions and represents the undeteriorated emission level. This would generally involve less than 300 hours of operation for engines with NO<sub>x</sub> aftertreatment and 125 hours of operation for other engines.

*Manufacture* means the physical and engineering process of designing, constructing, and/or assembling a heavy-duty engine or a heavy-duty vehicle.

*Manufacturer* has the meaning given in 40 CFR 1068.30.

*Medium-duty passenger vehicle* has the meaning given in 40 CFR 86.1803.

*Mild hybrid* means a hybrid engine or powertrain with regenerative braking capability where the system recovers less than 20 percent of the total braking energy over the transient cycle defined in appendix A of 40 CFR part 1037.

*Model year* means the manufacturer's annual new model production period, except as restricted under this definition. It must include January 1 of the calendar year for which the model year is named, may not begin before January 2 of the previous calendar year, and it must end by December 31 of the named calendar year. Manufacturers may not adjust model years to circumvent or delay compliance with emission standards or to avoid the obligation to certify annually.

*Motor vehicle* has the meaning given in 40 CFR 85.1703.

*Natural gas* means a fuel whose primary constituent is methane.

*New motor vehicle engine* has the meaning given in the Act. This generally means a motor vehicle engine meeting any of the following:

(1) A motor vehicle engine for which the ultimate purchaser has never received the equitable or legal title is a *new motor vehicle engine*. This kind of engine might commonly be thought of as “brand new” although a *new motor vehicle engine* may include previously used parts. Under this definition, the engine is new from the time it is produced until the ultimate purchaser receives the title or places it into service, whichever comes first.

(2) An imported motor vehicle engine is a *new motor vehicle engine* if it was originally built on or after January 1, 1970.

(3) Any motor vehicle engine installed in a new motor vehicle.

*Noncompliant engine* means an engine that was originally covered by a certificate of conformity, but is not in the certified configuration or otherwise does not comply with the conditions of the certificate.

*Nonconforming engine* means an engine not covered by a certificate of conformity that would otherwise be subject to emission standards.

*Nonmethane hydrocarbon (NMHC)* means the sum of all hydrocarbon species except methane, as measured according to 40 CFR part 1065.

*Nonmethane hydrocarbon equivalent (NMHCE)* has the meaning given in 40 CFR 1065.1001.

*Nonmethane nonethane hydrocarbon equivalent (NMNEHC)* has the meaning given in 40 CFR 1065.1001.

*Off-cycle technology* means technology certified under § 1036.610 (also described as “innovative technology”).

*Official emission result* means the measured emission rate for an emission-data engine on a given duty cycle before the application of any deterioration factor, but after the applicability of any required regeneration or other adjustment factors.

*Owners manual* means a document or collection of documents prepared by the engine or vehicle manufacturer for the owner or operator to describe appropriate engine maintenance, applicable warranties, and any other information related to operating or keeping the engine. The owners manual is typically provided to the ultimate purchaser at the time of sale. The owners manual may be in paper or electronic format.

*Oxides of nitrogen* has the meaning given in 40 CFR 1065.1001.

*Percent* has the meaning given in 40 CFR 1065.1001. Note that this means percentages identified in this part are assumed to be infinitely precise without regard to the number of significant figures. For example, one percent of 1,493 is 14.93.

*Placed into service* means put into initial use for its intended purpose, excluding incidental use by the manufacturer or a dealer.

*Preliminary approval* means approval granted by an authorized EPA representative prior to submission of an application for certification, consistent with the provisions of § 1036.210.

*Primary intended service class* has the meaning given in § 1036.140.

*QR Code* means Quick Response Code, which is a registered trademark of Denso Wave, Incorporated.



*Rechargeable Energy Storage System (RESS)* has the meaning given in 40 CFR 1065.1001.

*Relating to* as used in this section means relating to something in a specific, direct manner. This expression is used in this section only to define terms as adjectives and not to broaden the meaning of the terms.

*Revoke* has the meaning given in 40 CFR 1068.30.

*Round* has the meaning given in 40 CFR 1065.1001.

*Sample* means the collection of engines selected from the population of an engine family for emission testing. This may include testing for certification, production-line testing, or in-use testing.

*Scheduled maintenance* means adjusting, removing, disassembling, cleaning, or replacing components or systems periodically to keep a part or system from failing, malfunctioning, or wearing prematurely.

*Small manufacturer* means a manufacturer meeting the criteria specified in 13 CFR 121.201. The employee and revenue limits apply to the total number of employees and total revenue together for affiliated companies. Note that manufacturers with low production volumes may or may not be “small manufacturers”.

*Spark-ignition* means relating to a gasoline-fueled engine or any other type of engine with a spark plug (or other sparking device) and with operating characteristics significantly similar to the theoretical Otto combustion cycle. Spark-ignition engines usually use a throttle to regulate intake air flow to control power during normal operation.

*Steady-state* has the meaning given in 40 CFR 1065.1001. This includes fuel mapping and idle testing where engine speed and load are held at a finite set of nominally constant values.

*Suspend* has the meaning given in 40 CFR 1068.30.

*Test engine* means an engine in a sample.

*Tractor* means a vehicle meeting the definition of “tractor” in 40 CFR

1037.801, but not classified as a “vocational tractor” under 40 CFR 1037.630, or relating to such a vehicle.

*Tractor engine* means an engine certified for use in tractors. Where an engine family is certified for use in both tractors and vocational vehicles, “tractor engine” means an engine that the engine manufacturer reasonably believes will be (or has been) installed in a tractor. Note that the provisions of this part may require a manufacturer to document how it determines that an engine is a tractor engine.

*Ultimate purchaser* means, with respect to any new engine or vehicle, the first person who in good faith purchases such new engine or vehicle for purposes other than resale.

*United States* has the meaning given in 40 CFR 1068.30.

*Upcoming model year* means for an engine family the model year after the one currently in production.

*U.S.-directed production volume* means the number of engines, subject to the requirements of this part, produced by a manufacturer for which the manufacturer has a reasonable assurance that sale was or will be made to ultimate purchasers in the United States. This does not include engines certified to state emission standards that are different than the emission standards in this part.

*Vehicle* has the meaning given in 40 CFR 1037.801.

*Vocational engine* means an engine certified for use in vocational vehicles. Where an engine family is certified for use in both tractors and vocational vehicles, “vocational engine” means an engine that the engine manufacturer reasonably believes will be (or has been) installed in a vocational vehicle. Note that the provisions of this part may require a manufacturer to document how it determines that an engine is a vocational engine.

*Vocational vehicle* means a vehicle meeting the definition of “vocational” vehicle in 40 CFR 1037.801.

*Void* has the meaning given in 40 CFR 1068.30.

*We (us, our)* means the Administrator of the Environmental Protection Agency and any authorized representatives.

**§ 1036.805 Symbols, abbreviations, and acronyms.**

The procedures in this part generally follow either the International System of Units (SI) or the United States customary units, as detailed in NIST Special Publication 811 (incorporated by reference in § 1036.810). See 40 CFR 1065.20 for specific provisions related to these conventions. This section summarizes the way we use symbols, units of measure, and other abbreviations.

(a) *Symbols for chemical species.* This part uses the following symbols for chemical species and exhaust constituents:

TABLE 1 TO PARAGRAPH (a) OF § 1036.805—SYMBOLS FOR CHEMICAL SPECIES AND EXHAUST CONSTITUENTS

Symbol	Species
C	carbon.
CH <sub>4</sub>	methane.
CH <sub>4</sub> N <sub>2</sub> O	urea.
CO	carbon monoxide.
CO <sub>2</sub>	carbon dioxide.
H <sub>2</sub> O	water.
HC	hydrocarbon.
NMHC	nonmethane hydrocarbon.
NMHCE	nonmethane hydrocarbon equivalent.
NMNEHC	nonmethane nonethane hydrocarbon.
NO	nitric oxide.
NO <sub>2</sub>	nitrogen dioxide.
NO <sub>x</sub>	oxides of nitrogen.
N <sub>2</sub> O	nitrous oxide.
PM	particulate matter.

(b) *Symbols for quantities.* This part uses the following symbols and units of measure for various quantities:

TABLE 2 TO PARAGRAPH (b) OF § 1036.805—SYMBOLS FOR QUANTITIES

Symbol	Quantity	Unit	Unit symbol	Unit in terms of SI base units
$\alpha$	atomic hydrogen-to-carbon ratio ..	mole per mole .....	mol/mol .....	1
A	Area .....	square meter .....	m <sup>2</sup> .....	m <sup>2</sup>
$\beta$	atomic oxygen-to-carbon ratio .....	mole per mole .....	mol/mol .....	1
C <sub>dA</sub>	drag area .....	meter squared .....	m <sup>2</sup> .....	m <sup>2</sup>
C <sub>rr</sub>	coefficient of rolling resistance ....	newton per kilonewton .....	N/kN .....	10 <sup>-3</sup>
D	distance .....	miles or meters .....	mi or m .....	m
$\epsilon$	efficiency			
E	Difference or error quantity			
e	mass weighted emission result ...	grams/ton-mile .....	g/ton-mi .....	g/kg-km
Eff	efficiency			
E <sub>m</sub>	mass-specific net energy content	megajoules/kilogram .....	MJ/kg .....	m <sup>2</sup> ·s <sup>-2</sup>
f <sub>n</sub>	angular speed (shaft) .....	revolutions per minute .....	r/min .....	$\pi \cdot 30 \cdot s^{-1}$

TABLE 2 TO PARAGRAPH (b) OF § 1036.805—SYMBOLS FOR QUANTITIES—Continued

Symbol	Quantity	Unit	Unit symbol	Unit in terms of SI base units
<i>g</i> .....	gravitational acceleration .....	meters per second squared .....	m/s <sup>2</sup> .....	m·s <sup>-2</sup>
<i>i</i> .....	indexing variable			
<i>k<sub>a</sub></i> .....	drive axle ratio .....			1
<i>k<sub>topgear</sub></i> .....	highest available transmission gear			
<i>m</i> .....	Mass .....	pound mass or kilogram .....	lbm or kg .....	kg
<i>M</i> .....	molar mass .....	gram per mole .....	g/mol .....	10 <sup>-3</sup> ·kg·mol <sup>-1</sup>
<i>M</i> .....	total number in a series			
<i>M</i> .....	vehicle mass .....	kilogram .....	kg .....	kg
<i>M<sub>rotating</sub></i> .....	inertial mass of rotating components.	kilogram .....	kg .....	kg
<i>N</i> .....	total number in a series			
<i>Q</i> .....	total number in a series			
<i>P</i> .....	Power .....	kilowatt .....	kW .....	10 <sup>3</sup> ·m <sup>2</sup> ·kg·s <sup>-3</sup>
<i>ρ</i> .....	mass density .....	kilogram per cubic meter .....	kg/m <sup>3</sup> .....	m <sup>-3</sup> ·kg
<i>r</i> .....	tire radius .....	meter .....	m .....	m
<i>SEE</i> .....	standard error of the estimate			
<i>σ</i> .....	standard deviation			
<i>T</i> .....	torque (moment of force) .....	newton meter .....	N·m .....	m <sup>2</sup> ·kg·s <sup>-2</sup>
<i>t</i> .....	Time .....	second .....	s .....	s
<i>Δt</i> .....	time interval, period, 1/frequency	second .....	s .....	s
<i>UF</i> .....	utility factor			
<i>v</i> .....	Speed .....	miles per hour or meters per second.	mi/hr or m/s .....	m·s <sup>-1</sup>
<i>W</i> .....	Work .....	kilowatt-hour .....	kW·hr .....	3.6·m <sup>2</sup> ·kg·s <sup>-1</sup>
<i>W<sub>C</sub></i> .....	carbon mass fraction .....	gram/gram .....	g/g .....	1
<i>W<sub>CH4N2O</sub></i> .....	urea mass fraction .....	gram/gram .....	g/g .....	1
<i>X</i> .....	amount of substance mole fraction.	mole per mole .....	mol/mol .....	1
<i>X<sub>b</sub></i> .....	brake energy fraction			
<i>X<sub>bl</sub></i> .....	brake energy limit			

(c) *Superscripts.* This part uses the following superscripts for modifying quantity symbols:

TABLE 3 TO PARAGRAPH (c) OF § 1036.805—SUPERSCRIPTS

Superscript	Meaning
overbar (such as $\bar{y}$ ) ...	arithmetic mean.
overdot (such as $\dot{y}$ ) ...	quantity per unit time.

(d) *Subscripts.* This part uses the following subscripts for modifying quantity symbols:

TABLE 4 TO PARAGRAPH (d) OF § 1036.805—SUBSCRIPTS

Subscript	Meaning
65 .....	65 miles per hour.
A .....	A speed.
a .....	absolute (e.g., absolute difference or error).
acc .....	accessory.
app .....	approved.
axle .....	axle.
B .....	B speed.
C .....	C speed.
C .....	carbon mass.
C <sub>combdry</sub> .....	carbon from fuel per mole of dry exhaust.
CD .....	charge-depleting.
CO <sub>2</sub> DEF .....	CO <sub>2</sub> resulting from diesel exhaust fluid decomposition.
comb .....	combustion.
comp .....	composite.
cor .....	corrected.
CS .....	charge-sustaining.
cycle .....	cycle.
D .....	distance.
D .....	D speed.
DEF .....	diesel exhaust fluid.
engine .....	engine.
exh .....	raw exhaust.
front .....	frontal.
fuel .....	fuel.
H <sub>2</sub> Oexhaustdry .....	H <sub>2</sub> O in exhaust per mole of exhaust.

TABLE 4 TO PARAGRAPH (d) OF § 1036.805—SUBSCRIPTS—Continued

Subscript	Meaning
hi	high.
i	an individual of a series.
idle	idle.
int	test interval.
j	an individual of a series.
k	an individual of a series.
m	mass.
max	maximum.
mapped	mapped.
meas	measured quantity.
MY	model year.
neg	negative.
pos	positive.
R	range.
r	relative (e.g., relative difference or error).
rate	rate (divided by time).
rated	rated.
record	record.
ref	reference quantity.
speed	speed.
stall	stall.
test	test.
tire	tire.
transient	transient.
μ	vector.
UF	utility factor.
vehicle	vehicle.

(e) Other acronyms and abbreviations. This part uses the following additional abbreviations and acronyms:

TABLE 5 TO PARAGRAPH (e) OF § 1036.805—OTHER ACRONYMS AND ABBREVIATIONS

Acronym	Meaning
ABT	averaging, banking, and trading.
AECD	auxiliary emission control device.
ASTM	American Society for Testing and Materials.
BTU	British thermal units.
CD	charge-depleting.
CFR	Code of Federal Regulations.
CI	compression-ignition.
COV	coefficient of variation.
CS	charge-sustaining.
DEF	diesel exhaust fluid.
DF	deterioration factor.
DOT	Department of Transportation.
E85	gasoline blend including nominally 85 percent denatured ethanol.
ECM	Electronic Control Module.
EGR	exhaust gas recirculation.
EPA	Environmental Protection Agency.
FCL	Family Certification Level.
FEL	Family Emission Limit.
FTP	Federal Test Procedure.
GEM	Greenhouse gas Emissions Model.
g/hp-hr	grams per brake horsepower-hour.
GPS	global positioning system.
GVWR	gross vehicle weight rating.
Heavy HDE	heavy heavy-duty engine (see § 1036.140).
Heavy HDV	heavy heavy-duty vehicle (see 40 CFR 1037.140).
Light HDE	light heavy-duty engine (see § 1036.140).
Light HDV	light heavy-duty vehicle (see 40 CFR 1037.140).
LLC	Low Load Cycle.
LPG	liquefied petroleum gas.
Medium HDE	medium heavy-duty engine (see § 1036.140).
Medium HDV	medium heavy-duty vehicle (see 40 CFR 1037.140).
NARA	National Archives and Records Administration.
NHTSA	National Highway Traffic Safety Administration.

TABLE 5 TO PARAGRAPH (e) OF § 1036.805—OTHER ACRONYMS AND ABBREVIATIONS—Continued

Acronym	Meaning
NTE	not-to-exceed.
PEMS	portable emission measurement system.
RESS	rechargeable energy storage system.
SCR	selective catalytic reduction.
SEE	standard error of the estimate.
SET	Supplemental Emission Test.
Spark-ignition HDE	spark-ignition heavy-duty engine (see § 1036.140).
SI	spark-ignition.
UL	useful life.
U.S	United States.
U.S.C	United States Code.

(f) *Constants.* This part uses the following constants:

TABLE 6 TO PARAGRAPH (f) OF § 1036.805—CONSTANTS

Symbol	Quantity	Value
<i>g</i>	gravitational constant	9.80665 m·s <sup>-2</sup> .

(g) *Prefixes.* This part uses the following prefixes to define a quantity:

TABLE 7 TO PARAGRAPH (g) OF § 1036.805—PREFIXES

Symbol	Quantity	Value
$\mu$	micro	10 <sup>-6</sup>
m	milli	10 <sup>-3</sup>
c	centi	10 <sup>-2</sup>
k	kilo	10 <sup>3</sup>
M	mega	10 <sup>6</sup>

**§ 1036.810 Incorporation by reference.**

Certain material is incorporated by reference into this part with the approval of the Director of the Federal Register in accordance with 5 U.S.C. 552(a) and 1 CFR part 51. To enforce any edition other than that specified in this section, the Environmental Protection Agency (EPA) must publish a document in the **Federal Register** and the material must be available to the public. All approved material is available for inspection at the EPA and at the National Archives and Records Administration (NARA). Contact EPA at: U.S. EPA, Air and Radiation Docket and Information Center, 1301 Constitution Ave. NW, Room B102, EPA West Building, Washington, DC 20460, [www.epa.gov/dockets](http://www.epa.gov/dockets), (202) 202-1744. For information on the availability of this material at NARA, email: [fr.inspection@nara.gov](mailto:fr.inspection@nara.gov), or go to: [www.archives.gov/federal-register/cfr/ibr-locations.html](http://www.archives.gov/federal-register/cfr/ibr-locations.html). The material may be obtained from the following sources:

(a) ASTM International, 100 Barr Harbor Drive, P.O. Box C700, West

Conshohocken, PA 19428-2959, (877) 909-2786, or [www.astm.org](http://www.astm.org).

(1) ASTM D975-21, Standard Specification for Diesel Fuel, approved August 1, 2021 (“ASTM D975”); IBR approved for § 1036.415(c).

(2) ASTM D3588-98 (Reapproved 2017)e1, Standard Practice for Calculating Heat Value, Compressibility Factor, and Relative Density of Gaseous Fuels, approved April 1, 2017 (“ASTM D3588”); IBR approved for § 1036.530(b).

(3) ASTM D4809-13, Standard Method for Heat of Combustion of Liquid Hydrocarbon Fuels by Bomb Calorimeter (Precision Method), approved May 1, 2013 (“ASTM D4809”); IBR approved for § 1036.530(b).

(4) ASTM D4814-21c, Standard Specification for Automotive Spark-Ignition Engine Fuel, approved December 15, 2021 (“ASTM D4814”); IBR approved for § 1036.415(c).

(5) ASTM D7467-20a, Standard Specification for Diesel Fuel Oil, Biodiesel Blend (B6 to B20), approved

June 1, 2020 (“ASTM D7467”); IBR approved for § 1036.415(c).

(b) National Institute of Standards and Technology, 100 Bureau Drive, Stop 1070, Gaithersburg, MD 20899-1070, (301) 975-6478, or [www.nist.gov](http://www.nist.gov).

(1) NIST Special Publication 811, Guide for the Use of the International System of Units (SI), 2008 Edition, March 2008; IBR approved for § 1036.805.

(2) [Reserved]

(c) International Organization for Standardization, Case Postale 56, CH-1211 Geneva 20, Switzerland, (41) 22749 0111, [www.iso.org](http://www.iso.org), or [central@iso.org](mailto:central@iso.org).

(1) ISO/IEC 18004:2015(E), Information technology—Automatic identification and data capture techniques—QR Code bar code symbology specification, Third Edition, February 2015; IBR approved for § 1036.135(c).

(2) [Reserved]

(d) California Air Resources Board, 1001 I Street, Sacramento, CA 95812, (916) 322-2884, or [www.arb.ca.gov](http://www.arb.ca.gov):

(1) California's 2019 heavy-duty OBD requirements adopted under 13 CCR 1968.2, 1968.5, and 1971.5; IBR approved for § 1036.110(b).

(2) California's 2019 heavy-duty OBD requirements adopted under 13 CCR 1971.1; IBR approved for §§ 1036.110(b) and (c); 1036.111(a) and (c).

(e) SAE International, 400 Commonwealth Dr., Warrendale, PA 15096-0001, (877) 606-7323 (U.S. and Canada) or (724) 776-4970 (outside the U.S. and Canada), or [www.sae.org](http://www.sae.org);

(1) SAE J1979-2, E/E Diagnostic Test Modes: OBDonUDS, April 22, 2021; IBR approved for § 1036.150(u).

(2) [Reserved]

#### § 1036.815 Confidential information.

(a) The provisions of 40 CFR 1068.10 and 1068.11 apply for submitted information you submit under this part.

(b) Emission data or information that is publicly available cannot be treated as confidential business information as described in 40 CFR 1068.11. Data that vehicle manufacturers need for demonstrating compliance with greenhouse gas emission standards, including fuel-consumption data as described in § 1036.535 and 40 CFR 1037.550, also qualify as emission data for purposes of confidentiality determinations.

#### § 1036.820 Requesting a hearing.

(a) You may request a hearing under certain circumstances, as described elsewhere in this part. To do this, you must file a written request, including a description of your objection and any supporting data, within 30 days after we make a decision.

(b) For a hearing you request under the provisions of this part, we will approve your request if we find that your request raises a substantial factual issue.

(c) If we agree to hold a hearing, we will use the procedures specified in 40 CFR part 1068, subpart G.

#### § 1036.825 Reporting and recordkeeping requirements.

(a) This part includes various requirements to submit and record data or other information. Unless we specify otherwise, store required records in any format and on any media and keep them readily available for eight years after you send an associated application for certification, or eight years after you generate the data if they do not support an application for certification. We may review these records at any time. You must promptly give us organized, written records in English if we ask for them. We may require you to submit written records in an electronic format.

(b) The regulations in § 1036.255 and 40 CFR 1068.25 and 1068.101 describe your obligation to report truthful and complete information. This includes information not related to certification. Failing to properly report information and keep the records we specify violates 40 CFR 1068.101(a)(2), which may involve civil or criminal penalties.

(c) Send all reports and requests for approval to the Designated Compliance Officer (see § 1036.801).

(d) Any written information we require you to send to or receive from another company is deemed to be a required record under this section. Such records are also deemed to be submissions to EPA. Keep these records for eight years unless the regulations specify a different period. We may require you to send us these records whether or not you are a certificate holder.

(e) Under the Paperwork Reduction Act (44 U.S.C. 3501 *et seq.*), the Office of Management and Budget approves the reporting and recordkeeping specified in the applicable regulations. The following items illustrate the kind of reporting and recordkeeping we require for engines and vehicles regulated under this part:

(1) We specify the following requirements related to engine certification in this part:

(i) In § 1036.135 we require engine manufacturers to keep certain records related to duplicate labels sent to vehicle manufacturers.

(ii) In § 1036.150 we include various reporting and recordkeeping requirements related to interim provisions.

(iii) In subpart C of this part we identify a wide range of information required to certify engines.

(iv) In §§ 1036.430 and 1036.435 we identify reporting and recordkeeping requirements related to field testing in-use engines.

(v) In subpart G of this part we identify several reporting and recordkeeping items for making demonstrations and getting approval related to various special compliance provisions.

(vi) In §§ 1036.725, 1036.730, and 1036.735 we specify certain records related to averaging, banking, and trading.

(2) We specify the following requirements related to testing in 40 CFR part 1065:

(i) In 40 CFR 1065.2 we give an overview of principles for reporting information.

(ii) In 40 CFR 1065.10 and 1065.12 we specify information needs for

establishing various changes to published procedures.

(iii) In 40 CFR 1065.25 we establish basic guidelines for storing information.

(iv) In 40 CFR 1065.695 we identify the specific information and data items to record when measuring emissions.

(3) We specify the following requirements related to the general compliance provisions in 40 CFR part 1068:

(i) In 40 CFR 1068.5 we establish a process for evaluating good engineering judgment related to testing and certification.

(ii) In 40 CFR 1068.25 we describe general provisions related to sending and keeping information

(iii) In 40 CFR 1068.27 we require manufacturers to make engines available for our testing or inspection if we make such a request.

(iv) In 40 CFR 1068.105 we require vehicle manufacturers to keep certain records related to duplicate labels from engine manufacturers.

(v) In 40 CFR 1068.120 we specify recordkeeping related to rebuilding engines.

(vi) In 40 CFR part 1068, subpart C, we identify several reporting and recordkeeping items for making demonstrations and getting approval related to various exemptions.

(vii) In 40 CFR part 1068, subpart D, we identify several reporting and recordkeeping items for making demonstrations and getting approval related to importing engines.

(viii) In 40 CFR 1068.450 and 1068.455 we specify certain records related to testing production-line engines in a selective enforcement audit.

(ix) In 40 CFR 1068.501 we specify certain records related to investigating and reporting emission-related defects.

(x) In 40 CFR 1068.525 and 1068.530 we specify certain records related to recalling nonconforming engines.

(xi) In 40 CFR part 1068, subpart G, we specify certain records for requesting a hearing.

#### Appendix A of Part 1036—Summary of Previous Emission Standards

The following standards, which EPA originally adopted under 40 CFR part 85 or part 86, apply to compression-ignition engines produced before model year 2007 and to spark-ignition engines produced before model year 2008:

(a) *Smoke*. Smoke standards applied for compression-ignition engines based on opacity measurement using the test procedures in 40 CFR part 86, subpart I, as follows:

(1) Engines were subject to the following smoke standards for model years 1970 through 1973:

(i) 40 percent during the engine acceleration mode.  
 (ii) 20 percent during the engine lugging mode.  
 (2) The smoke standards in 40 CFR 86.007–11 started to apply in model year 1974.  
 (b) *Idle CO.* A standard of 0.5 percent of exhaust gas flow at curb idle applied through model year 2016 to the following engines:  
 (1) Spark-ignition engines with aftertreatment starting in model year 1987. This standard applied only for gasoline-fueled engines through model year 1997. Starting in model year 1998, the same standard applied for engines fueled by methanol, LPG, and natural gas. The idle CO

standard no longer applied for engines certified to meet onboard diagnostic requirements starting in model year 2005.  
 (2) Methanol-fueled compression-ignition engines starting in model year 1990. This standard also applied for natural gas and LPG engines starting in model year 1997. The idle CO standard no longer applied for engines certified to meet onboard diagnostic requirements starting in model year 2007.  
 (c) *Crankcase emissions.* The requirement to design engines to prevent crankcase emissions applied starting with the following engines:  
 (1) Spark-ignition engines starting in model year 1968. This standard applied only for

gasoline-fueled engines through model year 1989, and applied for spark-ignition engines using other fuels starting in model year 1990.  
 (2) Naturally aspirated diesel-fueled engines starting in model year 1985.  
 (3) Methanol-fueled compression-ignition engines starting in model year 1990.  
 (4) Naturally aspirated gaseous-fueled engines starting in model year 1997, and all other gaseous-fueled engines starting in 1998.  
 (d) *Early steady-state standards.* The following criteria standards applied to heavy-duty engines based on steady-state measurement procedures:

TABLE 1 OF APPENDIX A—EARLY STEADY-STATE EMISSION STANDARDS FOR HEAVY-DUTY ENGINES

Model year	Fuel	Pollutant		
		HC	NO <sub>x</sub> + HC	CO
1970–1973 .....	gasoline .....	275 ppm .....	.....	1.5 volume percent.
1974–1978 .....	gasoline and diesel .....	.....	16 g/hp-hr .....	40 g/hp-hr.
1979–1984 <sup>a</sup> .....	gasoline and diesel .....	.....	5 g/hp-hr for diesel .....	25 g/hp-hr.
			5.0 g/hp-hr for gasoline .....	

<sup>a</sup> An optional NO<sub>x</sub> + HC standard of 10 g/hp-hr applied in 1979 through 1984 in conjunction with a separate HC standard of 1.5 g/hp-hr.

(e) Transient emission standards for spark-ignition engines. The following criteria standards applied for spark-ignition engines

based on transient measurement using the test procedures in 40 CFR part 86, subpart N. Starting in model year 1991, manufacturers

could generate or use emission credits for NO<sub>x</sub> and NO<sub>x</sub> + NMHC standards. Table 2 to this appendix follows:

TABLE 2 OF APPENDIX A—TRANSIENT EMISSION STANDARDS FOR SPARK-IGNITION ENGINES<sup>A B</sup>

Model year	Pollutant (g/hp-hr)			
	HC	CO	NO <sub>x</sub>	NO <sub>x</sub> + NMHC
1985–1987 .....	1.1	14.4	10.6	.....
1988–1990 .....	1.1	14.4	6.0	.....
1991–1997 .....	1.1	14.4	5.0	.....
1998–2004 <sup>c</sup> .....	1.1	14.4	4.0	.....
2005–2007 .....	.....	14.4	.....	<sup>d</sup> 1.0

<sup>a</sup> Standards applied only for gasoline-fueled engines through model year 1989. Standards started to apply for methanol in model year 1990, and for LPG and natural gas in model year 1998.

<sup>b</sup> Engines intended for installation only in heavy-duty vehicles above 14,000 pounds GVWR were subject to an HC standard of 1.9 g/hp-hr for model years 1987 through 2004, and a CO standard of 37.1 g/hp-hr for model years 1987 through 2007. In addition, for model years 1987 through 2007, up to 5 percent of a manufacturer's sales of engines intended for installation in heavy-duty vehicles at or below 14,000 pounds GVWR could be certified to the alternative HC and CO standards.

<sup>c</sup> For natural gas engines in model years 1998 through 2004, the NO<sub>x</sub> standard was 5.0 g/hp-hr; the HC standards were 1.7 g/hp-hr for engines intended for installation only in vehicles above 14,000 pounds GVWR, and 0.9 g/hp-hr for other engines.

<sup>d</sup> Manufacturers could delay the 1.0 g/hp-hr NO<sub>x</sub> + NMHC standard until model year 2008 by meeting an alternate NO<sub>x</sub> + NMHC standard of 1.5 g/hp-hr applied for model years 2004 through 2007.

(f) Transient emission standards for compression-ignition engines. The following criteria standards applied for compression-ignition engines based on transient

measurement using the test procedures in 40 CFR part 86, subpart N. Starting in model year 1991, manufacturers could generate or use emission credits for NO<sub>x</sub>, NO<sub>x</sub> + NMHC,

and PM standards. Table 3 to this appendix follows:

TABLE 3 OF APPENDIX A—TRANSIENT EMISSION STANDARDS FOR COMPRESSION-IGNITION ENGINES<sup>a</sup>

Model year	Pollutant (g/hp-hr)				
	HC	CO	NO <sub>x</sub>	NO <sub>x</sub> + NMHC	PM
1985–1987 .....	1.3	15.5	10.7	.....	
1988–1989 .....	1.3	15.5	10.7	.....	0.60.
1990 .....	1.3	15.5	6.0	.....	0.60.
1991–1992 .....	1.3	15.5	5.0	.....	0.25.
1993 .....	1.3	15.5	5.0	.....	0.25 truck, 0.10 bus.
1994–1995 .....	1.3	15.5	5.0	.....	0.10 truck, 0.07 urban bus.

TABLE 3 OF APPENDIX A—TRANSIENT EMISSION STANDARDS FOR COMPRESSION-IGNITION ENGINES <sup>a</sup>—Continued

Model year	Pollutant (g/hp-hr)				
	HC	CO	NO <sub>x</sub>	NO <sub>x</sub> + NMHC	PM
1996–1997 .....	1.3	15.5	5.0	.....	0.10 truck, 0.05 urban bus. <sup>b</sup>
1998–2003 .....	1.3	15.5	4.0	.....	0.10 truck, 0.05 urban bus. <sup>b</sup>
2004–2006 .....	.....	15.5	.....	<sup>c</sup> 2.4	0.10 truck, 0.05 urban bus. <sup>b</sup>

<sup>a</sup> Standards applied only for diesel-fueled engines through model year 1989. Standards started to apply for methanol in model year 1990, and for LPG and natural gas in model year 1997. An alternate HC standard of 1.2 g/hp-hr applied for natural gas engines for model years 1997 through 2003.

<sup>b</sup> The in-use PM standard for urban bus engines in model years 1996 through 2006 was 0.07 g/hp-hr.

<sup>c</sup> An optional NO<sub>x</sub> + NMHC standard of 2.5 g/hp-hr applied in 2004 through 2006 in conjunction with a separate NMHC standard of 0.5 g/hp-hr.

**Appendix B of Part 1036—Transient Duty Cycles**

(a) This appendix specifies transient duty cycles for the engine and powertrain testing described in §§ 1036.510 and 1036.512, as follows:

(1) The transient duty cycle for testing engines involves a schedule of normalized engine speed and torque values.

(2) The transient duty cycles for powertrain testing involves a schedule of vehicle speeds and road grade. Determine road grade at each point based on the peak rated power of the powertrain system,  $P_{rated}$ , determined in

§ 1036.527 and road grade coefficients using the following equation: Road grade =  $a \cdot P_{rated}^2 + b \cdot P_{rated} + c$

(b) The following transient duty cycle applies for spark-ignition engines and powertrains:

**BILLING CODE 6560–50–P**

Table 1 of Appendix B—Transient Duty Cycle for Spark-Ignition Engines and Powertrains

Record (seconds)	Engine testing		Vehicle speed (mi/hr)	Powertrain testing		
	Normalized revolutions per minute (percent)	Normalized torque (percent)		Road grade coefficients		
				a	b	c
1	0	0	0	0	0	0
2	0	0	0	0	0	0
3	0	0	0	1.837E-05	-1.876E-02	2.369E+00
4	0	0	0	2.756E-05	-2.814E-02	3.553E+00
24	0	0	0	2.756E-05	-2.814E-02	3.553E+00
25	7	44.4	0	2.756E-05	-2.814E-02	3.553E+00
26	16	85.4	3.04	2.756E-05	-2.814E-02	3.553E+00
27	27	97.8	5.59	2.756E-05	-2.814E-02	3.553E+00
28	38	100	8.37	2.756E-05	-2.814E-02	3.553E+00
29	45	100	11.06	2.756E-05	-2.814E-02	3.553E+00
30	51	100	13.63	2.756E-05	-2.814E-02	3.553E+00
31	54	97.5	15.87	2.756E-05	-2.814E-02	3.553E+00
32	53	90	18.09	2.756E-05	-2.814E-02	3.553E+00
33	49	75.2	20.66	2.756E-05	-2.814E-02	3.553E+00
34	45	50	22.26	9.186E-06	-9.380E-03	1.184E+00
35	40	10	22.08	-9.186E-06	9.380E-03	-1.184E+00
36	34	2.3	20.58	-2.756E-05	2.814E-02	-3.553E+00
37	27	0	18.65	-2.756E-05	2.814E-02	-3.553E+00
38	21	2.3	16.5	-2.756E-05	2.814E-02	-3.553E+00
39	16	12	14.19	-2.756E-05	2.814E-02	-3.553E+00
40	12	35.3	11.65	-2.756E-05	2.814E-02	-3.553E+00
41	8.5	4.9	9.16	-2.756E-05	2.814E-02	-3.553E+00
42	5	( <sup>a</sup> )	8.01	-2.756E-05	2.814E-02	-3.553E+00
43	3	( <sup>a</sup> )	6.86	-2.756E-05	2.814E-02	-3.553E+00
44	0	0	3.19	-2.756E-05	2.814E-02	-3.553E+00
45	0	0	0	-2.756E-05	2.814E-02	-3.553E+00
46	0	0	0	-2.756E-05	2.814E-02	-3.553E+00
47	0	0	0	-1.587E-05	1.622E-02	-2.202E+00
48	0	0	0	-4.187E-06	4.310E-03	-8.511E-01
49	0	0	0	7.498E-06	-7.604E-03	5.001E-01
50	0	0	0	7.498E-06	-7.604E-03	5.001E-01
51	3	10	1.05	7.498E-06	-7.604E-03	5.001E-01
52	11	40.2	2.13	7.498E-06	-7.604E-03	5.001E-01
53	20	53	3.26	7.498E-06	-7.604E-03	5.001E-01
54	27.5	64.8	4.31	7.498E-06	-7.604E-03	5.001E-01
55	32	78	5.35	7.498E-06	-7.604E-03	5.001E-01
56	32	78	6.38	7.498E-06	-7.604E-03	5.001E-01
57	27.5	56	7.42	7.498E-06	-7.604E-03	5.001E-01
58	26	24.4	8.45	7.498E-06	-7.604E-03	5.001E-01
59	24	( <sup>a</sup> )	9.43	7.498E-06	-7.604E-03	5.001E-01
60	23	( <sup>a</sup> )	10.18	7.498E-06	-7.604E-03	5.001E-01
61	24	( <sup>a</sup> )	10.71	7.498E-06	-7.604E-03	5.001E-01
62	27	( <sup>a</sup> )	11.1	7.498E-06	-7.604E-03	5.001E-01
63	34	( <sup>a</sup> )	11.62	7.498E-06	-7.604E-03	5.001E-01
64	44	28	12.44	7.498E-06	-7.604E-03	5.001E-01
65	57	74.4	13.55	7.498E-06	-7.604E-03	5.001E-01
66	60	74.4	14.69	7.498E-06	-7.604E-03	5.001E-01
67	53	33.6	15.42	7.498E-06	-7.604E-03	5.001E-01
68	48	( <sup>a</sup> )	16.06	7.498E-06	-7.604E-03	5.001E-01
69	44	( <sup>a</sup> )	16.64	7.498E-06	-7.604E-03	5.001E-01
70	40	( <sup>a</sup> )	17.36	8.991E-06	-9.177E-03	2.234E+00
71	40	7	17.86	1.048E-05	-1.075E-02	3.968E+00
72	44	22.7	18.05	1.198E-05	-1.232E-02	5.701E+00
73	46	30	18.09	1.198E-05	-1.232E-02	5.701E+00
74	46	32	18.19	1.198E-05	-1.232E-02	5.701E+00
75	44	25	18.55	1.198E-05	-1.232E-02	5.701E+00
76	40	18	19.04	1.198E-05	-1.232E-02	5.701E+00
77	37	14	19.58	1.198E-05	-1.232E-02	5.701E+00
78	36	10	19.9	1.198E-05	-1.232E-02	5.701E+00
79	34	0	19.99	1.198E-05	-1.232E-02	5.701E+00
80	34	( <sup>a</sup> )	19.85	1.198E-05	-1.232E-02	5.701E+00
81	32	( <sup>a</sup> )	19.73	1.198E-05	-1.232E-02	5.701E+00
82	31	( <sup>a</sup> )	19.7	1.198E-05	-1.232E-02	5.701E+00
83	36	39.9	19.84	1.198E-05	-1.232E-02	5.701E+00
84	42	84.7	20.1	1.198E-05	-1.232E-02	5.701E+00
85	48	90	20.44	1.198E-05	-1.232E-02	5.701E+00



86	50	90	20.98	1.198E-05	-1.232E-02	5.701E+00
87	50	90	21.52	1.198E-05	-1.232E-02	5.701E+00
88	47	85	22.06	1.198E-05	-1.232E-02	5.701E+00
89	43	75	22.24	1.198E-05	-1.232E-02	5.701E+00
90	38	60	22.35	1.198E-05	-1.232E-02	5.701E+00
91	36	36	22.37	3.992E-06	-4.107E-03	1.900E+00
92	36	7.5	22.35	-3.992E-06	4.107E-03	-1.900E+00
93	36.3	(°)	22.27	-1.198E-05	1.232E-02	-5.701E+00
94	45	64.5	22.05	-1.198E-05	1.232E-02	-5.701E+00
95	53	67	21.79	-1.198E-05	1.232E-02	-5.701E+00
96	58	64.5	21.5	-1.198E-05	1.232E-02	-5.701E+00
97	62	60.3	21.2	-1.198E-05	1.232E-02	-5.701E+00
98	63	55.5	20.9	-1.198E-05	1.232E-02	-5.701E+00
99	62	52.3	20.59	-1.198E-05	1.232E-02	-5.701E+00
100	61	47	20.42	-1.198E-05	1.232E-02	-5.701E+00
101	55	44	20.25	-1.198E-05	1.232E-02	-5.701E+00
102	50	39	20.07	-1.198E-05	1.232E-02	-5.701E+00
103	45	36	19.75	-1.198E-05	1.232E-02	-5.701E+00
104	40	34	19.38	-1.198E-05	1.232E-02	-5.701E+00
105	36	30	19	-1.198E-05	1.232E-02	-5.701E+00
106	34	25.8	18.61	-1.198E-05	1.232E-02	-5.701E+00
107	32	20	18.2	-1.198E-05	1.232E-02	-5.701E+00
108	30	14.6	17.75	-1.198E-05	1.232E-02	-5.701E+00
109	26	10	17.27	-1.198E-05	1.232E-02	-5.701E+00
110	23	0	16.75	-1.198E-05	1.232E-02	-5.701E+00
111	18	(°)	16.2	-1.198E-05	1.232E-02	-5.701E+00
112	16	(°)	15.66	-1.198E-05	1.232E-02	-5.701E+00
113	18	(°)	15.15	-1.198E-05	1.232E-02	-5.701E+00
114	20	27.6	14.65	-1.198E-05	1.232E-02	-5.701E+00
115	17	4	14.16	-1.198E-05	1.232E-02	-5.701E+00
116	14	(°)	13.67	-1.198E-05	1.232E-02	-5.701E+00
117	12	(°)	12.59	-1.198E-05	1.232E-02	-5.701E+00
118	9	(°)	10.93	-1.198E-05	1.232E-02	-5.701E+00
119	7	(°)	9.28	-1.198E-05	1.232E-02	-5.701E+00
120	7	(°)	7.62	-1.198E-05	1.232E-02	-5.701E+00
121	5	(°)	5.96	-1.198E-05	1.232E-02	-5.701E+00
122	4	(°)	4.3	-1.198E-05	1.232E-02	-5.701E+00
123	3	(°)	2.64	-1.198E-05	1.232E-02	-5.701E+00
124	2	(°)	0.99	-1.198E-05	1.232E-02	-5.701E+00
125	0	0	0.19	-1.198E-05	1.232E-02	-5.701E+00
126	0	0	0	-1.198E-05	1.232E-02	-5.701E+00
127	0	0	0	-1.198E-05	1.232E-02	-5.701E+00
128	0	0	0	5.354E-07	1.492E-03	-6.315E+00
129	0	0	0	1.305E-05	-9.337E-03	-6.929E+00
130	5	8	3.25	2.556E-05	-2.017E-02	-7.543E+00
131	8	16.3	5.47	2.556E-05	-2.017E-02	-7.543E+00
132	10	27.5	6.71	2.556E-05	-2.017E-02	-7.543E+00
133	8	27.5	6.71	2.556E-05	-2.017E-02	-7.543E+00
134	5	9	6.71	2.556E-05	-2.017E-02	-7.543E+00
135	2	1.8	6.55	8.520E-06	-6.722E-03	-2.514E+00
136	0	0	6.01	-8.520E-06	6.722E-03	2.514E+00
137	0	0	5.15	-2.556E-05	2.017E-02	7.543E+00
138	0	0	3.9	-2.556E-05	2.017E-02	7.543E+00
139	0	0	2.19	-2.556E-05	2.017E-02	7.543E+00
140	0	0	0	-2.556E-05	2.017E-02	7.543E+00
141	0	0	0	-9.124E-06	5.441E-03	6.132E+00
142	0	0	0	7.313E-06	-9.284E-03	4.722E+00
143	0	0	0	2.375E-05	-2.401E-02	3.312E+00
148	0	0	0	2.375E-05	-2.401E-02	3.312E+00
149	2	4.8	0	2.375E-05	-2.401E-02	3.312E+00
150	1	4.5	0	2.375E-05	-2.401E-02	3.312E+00
151	0	0	0	2.375E-05	-2.401E-02	3.312E+00
166	0	0	0	2.375E-05	-2.401E-02	3.312E+00
167	8	27	1.95	2.375E-05	-2.401E-02	3.312E+00
168	18	65	3.7	2.375E-05	-2.401E-02	3.312E+00
169	23	82.5	5.53	2.375E-05	-2.401E-02	3.312E+00
170	23	88	7.22	2.375E-05	-2.401E-02	3.312E+00
171	21	88	8.64	2.375E-05	-2.401E-02	3.312E+00
172	18	81.3	10.33	2.375E-05	-2.401E-02	3.312E+00
173	17	32	11.18	7.917E-06	-8.003E-03	1.104E+00
174	15	(°)	10.57	-7.917E-06	8.003E-03	-1.104E+00
175	13	(°)	9.33	-2.375E-05	2.401E-02	-3.312E+00

176	11	(°)	7.87	-2.375E-05	2.401E-02	-3.312E+00
177	8	(°)	6.27	-2.375E-05	2.401E-02	-3.312E+00
178	6	(°)	4.58	-2.375E-05	2.401E-02	-3.312E+00
179	4	(°)	3.81	-2.375E-05	2.401E-02	-3.312E+00
180	2	(°)	2.35	-2.375E-05	2.401E-02	-3.312E+00
181	0	0	0	-2.375E-05	2.401E-02	-3.312E+00
182	0	0	0	-2.375E-05	2.401E-02	-3.312E+00
183	0	0	0	-1.078E-05	1.103E-02	-1.145E+00
184	0	0	0	2.190E-06	-1.954E-03	1.022E+00
185	0	0	0	1.516E-05	-1.494E-02	3.189E+00
203	0	0	0	1.516E-05	-1.494E-02	3.189E+00
204	0	4	0	1.516E-05	-1.494E-02	3.189E+00
205	0.5	7.7	1.6	1.516E-05	-1.494E-02	3.189E+00
206	5	14	4.24	1.516E-05	-1.494E-02	3.189E+00
207	11	24.7	7.5	1.516E-05	-1.494E-02	3.189E+00
208	15	42.3	9.18	1.516E-05	-1.494E-02	3.189E+00
209	16	70	10.11	1.516E-05	-1.494E-02	3.189E+00
210	17	70	10.34	1.516E-05	-1.494E-02	3.189E+00
211	17	50	10.46	1.516E-05	-1.494E-02	3.189E+00
212	16	26.3	9.93	1.516E-05	-1.494E-02	3.189E+00
213	14	5	8.7	1.516E-05	-1.494E-02	3.189E+00
214	10	(°)	7.43	1.516E-05	-1.494E-02	3.189E+00
215	10	(°)	9.14	1.516E-05	-1.494E-02	3.189E+00
216	14	73.3	9.72	1.516E-05	-1.494E-02	3.189E+00
217	18	83	9.84	1.516E-05	-1.494E-02	3.189E+00
218	19	84.8	10.02	1.516E-05	-1.494E-02	3.189E+00
219	18	84.8	9.92	5.053E-06	-4.979E-03	1.063E+00
220	16	82.8	9.14	-5.053E-06	4.979E-03	-1.063E+00
221	11	74	8.23	-1.516E-05	1.494E-02	-3.189E+00
222	7	8.5	6.64	-1.516E-05	1.494E-02	-3.189E+00
223	4	0	4.51	-1.516E-05	1.494E-02	-3.189E+00
224	0	0	0	-1.516E-05	1.494E-02	-3.189E+00
225	0	0	0	-1.516E-05	1.494E-02	-3.189E+00
226	0	0	0	-6.857E-06	6.357E-03	-2.057E+00
227	0	0	0	1.446E-06	-2.223E-03	-9.251E-01
228	0	0	0	9.749E-06	-1.080E-02	2.071E-01
232	0	0	0	9.749E-06	-1.080E-02	2.071E-01
233	6	17.6	0	9.749E-06	-1.080E-02	2.071E-01
234	6	19.6	0	9.749E-06	-1.080E-02	2.071E-01
235	5	14	0	9.749E-06	-1.080E-02	2.071E-01
236	3	9.8	0	9.749E-06	-1.080E-02	2.071E-01
237	1	5.5	0	9.749E-06	-1.080E-02	2.071E-01
238	0	3	0	9.749E-06	-1.080E-02	2.071E-01
239	0	0	0	9.749E-06	-1.080E-02	2.071E-01
280	0	0	0	9.749E-06	-1.080E-02	2.071E-01
281	0	7	0	9.749E-06	-1.080E-02	2.071E-01
282	1	10	0	9.749E-06	-1.080E-02	2.071E-01
283	2	11.5	0	9.749E-06	-1.080E-02	2.071E-01
284	1	10	0	9.749E-06	-1.080E-02	2.071E-01
285	0	0	0	9.749E-06	-1.080E-02	2.071E-01
298	0	0	0	9.749E-06	-1.080E-02	2.071E-01
299	0	28	0	9.749E-06	-1.080E-02	2.071E-01
300	0	30	0	9.749E-06	-1.080E-02	2.071E-01
301	2	32	0.55	9.749E-06	-1.080E-02	2.071E-01
302	6	34	1.92	9.749E-06	-1.080E-02	2.071E-01
303	14	36	3.18	9.749E-06	-1.080E-02	2.071E-01
304	19	36	4.8	9.749E-06	-1.080E-02	2.071E-01
305	24.5	36	6.63	9.749E-06	-1.080E-02	2.071E-01
306	24.5	36	7.87	9.749E-06	-1.080E-02	2.071E-01
307	24	30	8.32	9.749E-06	-1.080E-02	2.071E-01
308	19	24	9.66	9.749E-06	-1.080E-02	2.071E-01
309	13	18	11.46	9.749E-06	-1.080E-02	2.071E-01
310	9	14	13.28	9.749E-06	-1.080E-02	2.071E-01
311	7	8	14.61	9.749E-06	-1.080E-02	2.071E-01
312	6	0	14.39	9.749E-06	-1.080E-02	2.071E-01
313	4	3	13.5	9.749E-06	-1.080E-02	2.071E-01
314	3	6.8	12.41	9.749E-06	-1.080E-02	2.071E-01
315	0	0	11.3	9.749E-06	-1.080E-02	2.071E-01
316	0	0	11.25	9.749E-06	-1.080E-02	2.071E-01
317	0	0	12.29	9.749E-06	-1.080E-02	2.071E-01
318	0	0	13.26	9.749E-06	-1.080E-02	2.071E-01
319	0	0	13.66	9.749E-06	-1.080E-02	2.071E-01

320	0	0	14.27	9.749E-06	-1.080E-02	2.071E-01
321	0	0	15.17	9.749E-06	-1.080E-02	2.071E-01
322	0	0	16.05	9.749E-06	-1.080E-02	2.071E-01
323	0	18	16.49	9.749E-06	-1.080E-02	2.071E-01
324	3	40	17.52	9.749E-06	-1.080E-02	2.071E-01
325	8	86	18.06	9.749E-06	-1.080E-02	2.071E-01
326	18	97	18.18	9.749E-06	-1.080E-02	2.071E-01
327	38	100	18.95	9.749E-06	-1.080E-02	2.071E-01
328	45.5	100	20.48	9.749E-06	-1.080E-02	2.071E-01
329	45	96	20.48	3.250E-06	-3.601E-03	6.902E-02
330	44	84.4	19.5	-3.250E-06	3.601E-03	-6.902E-02
331	43	53.6	18.43	-9.749E-06	1.080E-02	-2.071E-01
332	41	5	17.44	-9.749E-06	1.080E-02	-2.071E-01
333	43	47.6	16.77	-9.749E-06	1.080E-02	-2.071E-01
334	44	90	16.36	-9.749E-06	1.080E-02	-2.071E-01
335	45	90	16.34	-9.749E-06	1.080E-02	-2.071E-01
336	44	73	16.79	-9.749E-06	1.080E-02	-2.071E-01
337	40	54	16.34	-9.749E-06	1.080E-02	-2.071E-01
338	38	34.7	15.13	-9.749E-06	1.080E-02	-2.071E-01
339	36	10	13.72	-9.749E-06	1.080E-02	-2.071E-01
340	35	10	12.04	-9.749E-06	1.080E-02	-2.071E-01
341	35	10	10.44	-9.749E-06	1.080E-02	-2.071E-01
342	35.5	60	9.71	-9.749E-06	1.080E-02	-2.071E-01
343	36	57.9	9.81	-9.749E-06	1.080E-02	-2.071E-01
344	37	53	10.65	-9.749E-06	1.080E-02	-2.071E-01
345	39	50	11.42	-9.749E-06	1.080E-02	-2.071E-01
346	40.5	50	10.54	-9.749E-06	1.080E-02	-2.071E-01
347	43	50	8.87	-9.749E-06	1.080E-02	-2.071E-01
348	45	50	9.26	-3.250E-06	3.601E-03	-6.902E-02
349	48	50	10.33	3.250E-06	-3.601E-03	6.902E-02
350	51	52	10.79	9.749E-06	-1.080E-02	2.071E-01
351	56	58.7	11.8	9.749E-06	-1.080E-02	2.071E-01
352	64	70	14.06	9.749E-06	-1.080E-02	2.071E-01
353	68	70	16.77	9.749E-06	-1.080E-02	2.071E-01
354	70	70	18.83	9.749E-06	-1.080E-02	2.071E-01
355	65.5	64.6	22.12	9.749E-06	-1.080E-02	2.071E-01
356	61	28.9	24.1	9.749E-06	-1.080E-02	2.071E-01
357	55	( <sup>g</sup> )	25.97	9.749E-06	-1.080E-02	2.071E-01
358	50	( <sup>g</sup> )	27.04	9.749E-06	-1.080E-02	2.071E-01
359	45	( <sup>g</sup> )	27.18	9.749E-06	-1.080E-02	2.071E-01
360	38	( <sup>g</sup> )	28.34	9.749E-06	-1.080E-02	2.071E-01
361	28	( <sup>g</sup> )	29.69	9.749E-06	-1.080E-02	2.071E-01
362	19	( <sup>g</sup> )	29.86	9.749E-06	-1.080E-02	2.071E-01
363	14	( <sup>g</sup> )	29.51	9.749E-06	-1.080E-02	2.071E-01
364	7	( <sup>g</sup> )	29.91	9.749E-06	-1.080E-02	2.071E-01
365	2	( <sup>g</sup> )	30.99	9.749E-06	-1.080E-02	2.071E-01
366	3	5	32.55	9.749E-06	-1.080E-02	2.071E-01
367	7	25	33.43	9.749E-06	-1.080E-02	2.071E-01
368	9	38	33.56	3.250E-06	-3.601E-03	6.902E-02
369	7	17	33.36	-3.250E-06	3.601E-03	-6.902E-02
370	4	2	32.65	-9.749E-06	1.080E-02	-2.071E-01
371	3	( <sup>g</sup> )	31.8	-9.749E-06	1.080E-02	-2.071E-01
372	3	( <sup>g</sup> )	30.92	-9.749E-06	1.080E-02	-2.071E-01
373	11	70	30.42	-9.749E-06	1.080E-02	-2.071E-01
374	15	97.6	29.73	-9.749E-06	1.080E-02	-2.071E-01
375	16	100	28.65	-9.749E-06	1.080E-02	-2.071E-01
376	19	100	27.5	-9.749E-06	1.080E-02	-2.071E-01
377	26	100	26.22	-9.749E-06	1.080E-02	-2.071E-01
378	29	95	24.69	-9.749E-06	1.080E-02	-2.071E-01
379	25	63	23.13	-9.749E-06	1.080E-02	-2.071E-01
380	19	( <sup>g</sup> )	21.68	-9.749E-06	1.080E-02	-2.071E-01
381	12	( <sup>g</sup> )	20.25	-9.749E-06	1.080E-02	-2.071E-01
382	8	( <sup>g</sup> )	15.73	-9.749E-06	1.080E-02	-2.071E-01
383	5	( <sup>g</sup> )	10.93	-9.749E-06	1.080E-02	-2.071E-01
384	2	( <sup>g</sup> )	6.12	-9.749E-06	1.080E-02	-2.071E-01
385	1	( <sup>g</sup> )	1.31	-9.749E-06	1.080E-02	-2.071E-01
386	0	0	0	-9.749E-06	1.080E-02	-2.071E-01
392	0	0	0	-9.749E-06	1.080E-02	-2.071E-01
393	0	0	0	-1.165E-06	1.625E-03	1.971E+00
394	0	0	0	7.420E-06	-7.553E-03	4.149E+00
395	0	0	0	1.600E-05	-1.673E-02	6.327E+00
418	0	0	0	1.600E-05	-1.673E-02	6.327E+00

419	4	20	0	1.600E-05	-1.673E-02	6.327E+00
420	4	20	0	1.600E-05	-1.673E-02	6.327E+00
421	0	0	0	1.600E-05	-1.673E-02	6.327E+00
429	0	0	0	1.600E-05	-1.673E-02	6.327E+00
430	2	0	1.18	1.600E-05	-1.673E-02	6.327E+00
431	6	2	2.85	1.600E-05	-1.673E-02	6.327E+00
432	14	28.8	4.57	1.600E-05	-1.673E-02	6.327E+00
433	20	30	7.42	1.600E-05	-1.673E-02	6.327E+00
434	24.4	11	10.79	1.600E-05	-1.673E-02	6.327E+00
435	24	10	13.51	1.600E-05	-1.673E-02	6.327E+00
436	24	12	15.48	1.600E-05	-1.673E-02	6.327E+00
437	28	52	16.82	1.600E-05	-1.673E-02	6.327E+00
438	32	52	17.86	1.600E-05	-1.673E-02	6.327E+00
439	34	46	18.7	1.600E-05	-1.673E-02	6.327E+00
440	34	30	19.11	1.600E-05	-1.673E-02	6.327E+00
441	34.5	30	19.28	1.600E-05	-1.673E-02	6.327E+00
442	35	30	19.38	1.600E-05	-1.673E-02	6.327E+00
443	36	35	19.53	1.600E-05	-1.673E-02	6.327E+00
444	39	40	19.57	1.600E-05	-1.673E-02	6.327E+00
445	45	50	19.09	1.600E-05	-1.673E-02	6.327E+00
446	49	56	18.2	1.600E-05	-1.673E-02	6.327E+00
447	50	( <sup>o</sup> )	17.14	1.600E-05	-1.673E-02	6.327E+00
448	45	( <sup>o</sup> )	15.9	1.600E-05	-1.673E-02	6.327E+00
449	39	( <sup>o</sup> )	14.42	1.600E-05	-1.673E-02	6.327E+00
450	34	( <sup>o</sup> )	13.86	1.600E-05	-1.673E-02	6.327E+00
451	28	( <sup>o</sup> )	15.45	1.600E-05	-1.673E-02	6.327E+00
452	25	( <sup>o</sup> )	17.32	1.600E-05	-1.673E-02	6.327E+00
453	21	( <sup>o</sup> )	18.03	1.600E-05	-1.673E-02	6.327E+00
454	18	( <sup>o</sup> )	18.19	1.600E-05	-1.673E-02	6.327E+00
455	15	( <sup>o</sup> )	18.3	1.600E-05	-1.673E-02	6.327E+00
456	12	( <sup>o</sup> )	18.4	1.600E-05	-1.673E-02	6.327E+00
457	18	( <sup>o</sup> )	18.33	1.600E-05	-1.673E-02	6.327E+00
458	29	19.8	18.68	1.600E-05	-1.673E-02	6.327E+00
459	40	54	19.1	5.335E-06	-5.577E-03	2.109E+00
460	52	82	18.69	-5.335E-06	5.577E-03	-2.109E+00
461	64	95	17.89	-1.600E-05	1.673E-02	-6.327E+00
462	71	99	17.23	-1.600E-05	1.673E-02	-6.327E+00
463	77	100	16.65	-1.600E-05	1.673E-02	-6.327E+00
464	84	100	15.76	-1.600E-05	1.673E-02	-6.327E+00
465	85	99	14.53	-1.600E-05	1.673E-02	-6.327E+00
466	85	95	13.07	-1.600E-05	1.673E-02	-6.327E+00
467	84	90	11.26	-1.600E-05	1.673E-02	-6.327E+00
468	82	84.6	9.32	-1.600E-05	1.673E-02	-6.327E+00
469	80	78.5	8.04	-1.600E-05	1.673E-02	-6.327E+00
470	78	78.5	8.15	-7.218E-06	7.554E-03	-2.785E+00
471	77	70	9.43	1.567E-06	-1.623E-03	7.568E-01
472	76	65.5	10.8	1.035E-05	-1.080E-02	4.299E+00
473	74	61.5	12.16	1.035E-05	-1.080E-02	4.299E+00
474	72	56	14.25	1.035E-05	-1.080E-02	4.299E+00
475	70	52	16.38	1.035E-05	-1.080E-02	4.299E+00
476	68	46	17.48	1.035E-05	-1.080E-02	4.299E+00
477	66.5	40	17.41	1.035E-05	-1.080E-02	4.299E+00
478	65	32	16.78	1.035E-05	-1.080E-02	4.299E+00
479	63	26	16.06	1.035E-05	-1.080E-02	4.299E+00
480	61	25.6	15.24	1.035E-05	-1.080E-02	4.299E+00
481	61	72	14.69	1.035E-05	-1.080E-02	4.299E+00
482	61	78	15.38	1.035E-05	-1.080E-02	4.299E+00
483	58	72	16.86	1.035E-05	-1.080E-02	4.299E+00
484	50	64	17.35	1.035E-05	-1.080E-02	4.299E+00
485	44	55	16.98	1.035E-05	-1.080E-02	4.299E+00
486	35	40	16.57	1.035E-05	-1.080E-02	4.299E+00
487	26	20	16.12	1.035E-05	-1.080E-02	4.299E+00
488	21	( <sup>o</sup> )	15.67	1.035E-05	-1.080E-02	4.299E+00
489	18	( <sup>o</sup> )	15.46	1.035E-05	-1.080E-02	4.299E+00
490	16	( <sup>o</sup> )	15.52	1.035E-05	-1.080E-02	4.299E+00
491	19	( <sup>o</sup> )	15.89	1.035E-05	-1.080E-02	4.299E+00
492	24	2	16.77	1.035E-05	-1.080E-02	4.299E+00
493	32	68.5	18.08	1.035E-05	-1.080E-02	4.299E+00
494	45	78	19.31	1.035E-05	-1.080E-02	4.299E+00
495	51	86	20.11	1.035E-05	-1.080E-02	4.299E+00
496	58	92	20.75	1.035E-05	-1.080E-02	4.299E+00
497	64	97	21.23	1.035E-05	-1.080E-02	4.299E+00

498	71	100	21.4	1.035E-05	-1.080E-02	4.299E+00
499	73	98	21.51	1.035E-05	-1.080E-02	4.299E+00
500	73	94	22.18	1.035E-05	-1.080E-02	4.299E+00
501	73	86	22.48	1.035E-05	-1.080E-02	4.299E+00
502	73	82	22.49	1.035E-05	-1.080E-02	4.299E+00
503	76	84	23.27	1.035E-05	-1.080E-02	4.299E+00
504	80	98	24.39	1.035E-05	-1.080E-02	4.299E+00
505	84	100	25.09	1.035E-05	-1.080E-02	4.299E+00
506	85	100	25.26	1.035E-05	-1.080E-02	4.299E+00
507	84	100	25.15	1.035E-05	-1.080E-02	4.299E+00
508	81	92	24.8	1.035E-05	-1.080E-02	4.299E+00
509	75	80	24.3	1.035E-05	-1.080E-02	4.299E+00
510	73	70	23.92	1.035E-05	-1.080E-02	4.299E+00
511	70	60	23.82	1.035E-05	-1.080E-02	4.299E+00
512	67	53	23.75	1.035E-05	-1.080E-02	4.299E+00
513	65	45	24.34	1.035E-05	-1.080E-02	4.299E+00
514	63	36.5	25.03	1.035E-05	-1.080E-02	4.299E+00
515	62	28	25.13	1.035E-05	-1.080E-02	4.299E+00
516	61	22.5	25.14	1.035E-05	-1.080E-02	4.299E+00
517	60	23	25.14	1.035E-05	-1.080E-02	4.299E+00
518	60	24	25.15	1.035E-05	-1.080E-02	4.299E+00
519	60	24	25.15	1.035E-05	-1.080E-02	4.299E+00
520	60	26	25.16	1.035E-05	-1.080E-02	4.299E+00
521	61	60	25.17	1.035E-05	-1.080E-02	4.299E+00
522	62	64	25.24	1.035E-05	-1.080E-02	4.299E+00
523	63	64	25.41	1.035E-05	-1.080E-02	4.299E+00
524	64	64	26.56	1.035E-05	-1.080E-02	4.299E+00
525	62	64	28.84	1.035E-05	-1.080E-02	4.299E+00
526	56	60	31.08	1.035E-05	-1.080E-02	4.299E+00
527	53	( <sup>o</sup> )	32.37	1.035E-05	-1.080E-02	4.299E+00
528	49	( <sup>o</sup> )	32.7	1.035E-05	-1.080E-02	4.299E+00
529	47	( <sup>o</sup> )	32.76	1.035E-05	-1.080E-02	4.299E+00
530	46	( <sup>o</sup> )	32.82	6.288E-06	-6.906E-03	2.331E+00
531	45	( <sup>o</sup> )	32.88	2.223E-06	-3.012E-03	3.623E-01
532	45	30	33.19	-1.842E-06	8.816E-04	-1.606E+00
533	46	50	33.89	-1.842E-06	8.816E-04	-1.606E+00
534	46	50	35.07	-1.842E-06	8.816E-04	-1.606E+00
535	47	50	36.61	-1.842E-06	8.816E-04	-1.606E+00
536	47	50	37.63	-1.842E-06	8.816E-04	-1.606E+00
537	47	30	38.05	-1.842E-06	8.816E-04	-1.606E+00
538	46	12	38.67	-1.842E-06	8.816E-04	-1.606E+00
539	45	10.5	39.32	-1.842E-06	8.816E-04	-1.606E+00
540	44	10	39.54	-1.842E-06	8.816E-04	-1.606E+00
541	41	10	39.55	-1.842E-06	8.816E-04	-1.606E+00
542	37	9	39.56	-1.842E-06	8.816E-04	-1.606E+00
543	36	2	39.58	-1.842E-06	8.816E-04	-1.606E+00
544	35	( <sup>o</sup> )	39.59	-1.842E-06	8.816E-04	-1.606E+00
545	38	67	39.61	-1.842E-06	8.816E-04	-1.606E+00
546	35	( <sup>o</sup> )	39.6	-1.842E-06	8.816E-04	-1.606E+00
547	31	15	39.69	-1.842E-06	8.816E-04	-1.606E+00
548	28	55	39.99	-1.842E-06	8.816E-04	-1.606E+00
549	34	44	40.39	-1.842E-06	8.816E-04	-1.606E+00
550	35	38.5	41.01	-1.842E-06	8.816E-04	-1.606E+00
551	36	38.5	41.65	-1.842E-06	8.816E-04	-1.606E+00
552	36	38.5	41.69	-1.842E-06	8.816E-04	-1.606E+00
553	37	38.5	41.17	-1.842E-06	8.816E-04	-1.606E+00
554	39	36	40.47	-1.842E-06	8.816E-04	-1.606E+00
555	42	27	39.83	-1.842E-06	8.816E-04	-1.606E+00
556	45	62	39.39	-1.842E-06	8.816E-04	-1.606E+00
557	48	45	39.14	-1.842E-06	8.816E-04	-1.606E+00
558	51	15	38.99	-1.842E-06	8.816E-04	-1.606E+00
559	51	8	38.88	-1.842E-06	8.816E-04	-1.606E+00
560	51	6	38.86	-1.842E-06	8.816E-04	-1.606E+00
561	48	10	39.17	-1.842E-06	8.816E-04	-1.606E+00
562	46	11	39.37	-6.139E-07	2.939E-04	-5.353E-01
563	44	13	38.63	6.139E-07	-2.939E-04	5.353E-01
564	41	17	36.96	1.842E-06	-8.816E-04	1.606E+00
565	37	20	34.87	1.842E-06	-8.816E-04	1.606E+00
566	34	20	32.73	1.842E-06	-8.816E-04	1.606E+00
567	30	17	30.53	1.842E-06	-8.816E-04	1.606E+00
568	26	14	28.27	1.842E-06	-8.816E-04	1.606E+00
569	23	7	26.02	1.842E-06	-8.816E-04	1.606E+00

570	19	2	23.76	1.842E-06	-8.816E-04	1.606E+00
571	15	(°)	21.37	1.842E-06	-8.816E-04	1.606E+00
572	11	(°)	18.79	1.842E-06	-8.816E-04	1.606E+00
573	8	(°)	16.06	1.842E-06	-8.816E-04	1.606E+00
574	5	(°)	13.05	1.842E-06	-8.816E-04	1.606E+00
575	2	(°)	9.54	1.842E-06	-8.816E-04	1.606E+00
576	0	0	4.59	1.842E-06	-8.816E-04	1.606E+00
577	0	0	0	1.842E-06	-8.816E-04	1.606E+00
580	0	0	0	1.842E-06	-8.816E-04	1.606E+00
581	0	0	0	8.289E-06	-7.507E-03	1.023E+00
582	0	0	0	1.474E-05	-1.413E-02	4.394E-01
583	4	15	0	2.118E-05	-2.076E-02	-1.439E-01
584	19	31	0.78	2.118E-05	-2.076E-02	-1.439E-01
585	30	46	1.94	2.118E-05	-2.076E-02	-1.439E-01
586	37	68	3.83	2.118E-05	-2.076E-02	-1.439E-01
587	40	76	5.98	2.118E-05	-2.076E-02	-1.439E-01
588	41	77	8.07	2.118E-05	-2.076E-02	-1.439E-01
589	40.5	78	10.09	2.118E-05	-2.076E-02	-1.439E-01
590	40	77	10.29	2.118E-05	-2.076E-02	-1.439E-01
591	40	64	7.34	2.118E-05	-2.076E-02	-1.439E-01
592	38	10	3.27	2.118E-05	-2.076E-02	-1.439E-01
593	38	25	3.24	2.118E-05	-2.076E-02	-1.439E-01
594	40	50	5.98	2.118E-05	-2.076E-02	-1.439E-01
595	40	36	8.48	2.118E-05	-2.076E-02	-1.439E-01
596	40	31	11	2.118E-05	-2.076E-02	-1.439E-01
597	40	31	13.62	2.118E-05	-2.076E-02	-1.439E-01
598	41	37	16.07	2.118E-05	-2.076E-02	-1.439E-01
599	42	97	18.51	2.118E-05	-2.076E-02	-1.439E-01
600	43	100	21.51	1.588E-05	-1.615E-02	-7.554E-01
601	45	100	24.71	1.058E-05	-1.153E-02	-1.367E+00
602	47	100	27.57	5.283E-06	-6.920E-03	-1.978E+00
603	48	100	30.04	5.283E-06	-6.920E-03	-1.978E+00
604	49	100	32.22	5.283E-06	-6.920E-03	-1.978E+00
605	51	97	34.28	5.283E-06	-6.920E-03	-1.978E+00
606	52	94	36.22	5.283E-06	-6.920E-03	-1.978E+00
607	53	90	38.08	5.283E-06	-6.920E-03	-1.978E+00
608	54	87	39.83	5.283E-06	-6.920E-03	-1.978E+00
609	56	86	41.63	5.283E-06	-6.920E-03	-1.978E+00
610	56	85	43.18	5.283E-06	-6.920E-03	-1.978E+00
611	55.5	85	44.33	5.283E-06	-6.920E-03	-1.978E+00
612	55	81	45.38	5.283E-06	-6.920E-03	-1.978E+00
613	54	77	46.14	5.283E-06	-6.920E-03	-1.978E+00
614	53	72	46.39	5.283E-06	-6.920E-03	-1.978E+00
615	52	67	46.34	5.283E-06	-6.920E-03	-1.978E+00
616	49	60	46.24	5.283E-06	-6.920E-03	-1.978E+00
617	46	45	46.14	5.283E-06	-6.920E-03	-1.978E+00
618	45	12	46.05	5.283E-06	-6.920E-03	-1.978E+00
619	44	10	46.13	5.283E-06	-6.920E-03	-1.978E+00
620	44	10	46.49	5.283E-06	-6.920E-03	-1.978E+00
621	45	12	46.78	5.283E-06	-6.920E-03	-1.978E+00
622	46	14	46.81	5.283E-06	-6.920E-03	-1.978E+00
623	47	24	46.95	5.283E-06	-6.920E-03	-1.978E+00
624	49	88	47.37	5.283E-06	-6.920E-03	-1.978E+00
625	50	90	47.62	2.349E-06	-3.713E-03	-1.409E+00
626	51	90	47.58	-5.848E-07	-5.058E-04	-8.401E-01
627	52	90	48	-3.519E-06	2.701E-03	-2.710E-01
628	53	90	48.46	-3.519E-06	2.701E-03	-2.710E-01
629	54	90	48.45	-3.519E-06	2.701E-03	-2.710E-01
630	54	90	48.4	-3.519E-06	2.701E-03	-2.710E-01
631	54	87	48.59	-3.519E-06	2.701E-03	-2.710E-01
632	54	84	49.3	-3.519E-06	2.701E-03	-2.710E-01
633	54	80	50.02	-3.519E-06	2.701E-03	-2.710E-01
634	53.5	77	50.27	-3.519E-06	2.701E-03	-2.710E-01
635	53	76	50	-3.519E-06	2.701E-03	-2.710E-01
636	53	75	49.73	-3.519E-06	2.701E-03	-2.710E-01
637	52	73	49.57	-3.519E-06	2.701E-03	-2.710E-01
638	51	69	49.31	-3.519E-06	2.701E-03	-2.710E-01
639	50	65	49.29	-3.519E-06	2.701E-03	-2.710E-01
640	50	60	49.71	-3.519E-06	2.701E-03	-2.710E-01
641	49	55	50.02	-3.519E-06	2.701E-03	-2.710E-01
642	49	50	50.05	-3.519E-06	2.701E-03	-2.710E-01
643	49	50	50.07	-3.519E-06	2.701E-03	-2.710E-01

644	49.5	60	50.33	-3.519E-06	2.701E-03	-2.710E-01
645	49.5	65	50.75	-3.519E-06	2.701E-03	-2.710E-01
646	50	70	51.03	-3.519E-06	2.701E-03	-2.710E-01
647	50.5	75	51.47	-3.519E-06	2.701E-03	-2.710E-01
648	51	80	51.92	-3.519E-06	2.701E-03	-2.710E-01
649	52	85	51.93	-3.519E-06	2.701E-03	-2.710E-01
650	53	90	51.9	-4.549E-06	3.697E-03	-6.366E-01
651	54	90	51.87	-5.579E-06	4.693E-03	-1.002E+00
652	55	90	51.85	-6.609E-06	5.688E-03	-1.368E+00
653	55	88	51.82	-6.609E-06	5.688E-03	-1.368E+00
654	55	84	51.82	-6.609E-06	5.688E-03	-1.368E+00
655	55	79	52.54	-6.609E-06	5.688E-03	-1.368E+00
656	55	74	53.59	-6.609E-06	5.688E-03	-1.368E+00
657	55	69	54.19	-6.609E-06	5.688E-03	-1.368E+00
658	55	64	54.26	-6.609E-06	5.688E-03	-1.368E+00
659	55	59	54.07	-6.609E-06	5.688E-03	-1.368E+00
660	55	54	53.93	-6.609E-06	5.688E-03	-1.368E+00
661	55	49	53.92	-6.609E-06	5.688E-03	-1.368E+00
662	55	44.5	53.9	-6.609E-06	5.688E-03	-1.368E+00
663	55	39	53.89	-6.609E-06	5.688E-03	-1.368E+00
664	55	34	53.88	-6.609E-06	5.688E-03	-1.368E+00
665	55	27	53.87	-6.609E-06	5.688E-03	-1.368E+00
666	55	18	53.85	-6.609E-06	5.688E-03	-1.368E+00
667	55	8	53.81	-6.609E-06	5.688E-03	-1.368E+00
668	55	6	53.67	-6.609E-06	5.688E-03	-1.368E+00
669	55	13	53.67	-6.609E-06	5.688E-03	-1.368E+00
670	55	27	54.32	-6.609E-06	5.688E-03	-1.368E+00
671	55.5	30	54.88	-6.609E-06	5.688E-03	-1.368E+00
672	56	30	54.87	-6.609E-06	5.688E-03	-1.368E+00
673	57	30	54.86	-6.609E-06	5.688E-03	-1.368E+00
674	58	34	54.75	-6.609E-06	5.688E-03	-1.368E+00
675	59	46	54.28	-5.500E-06	4.582E-03	-7.225E-01
676	59	89	53.84	-4.390E-06	3.477E-03	-7.706E-02
677	59	90	54.02	-3.280E-06	2.371E-03	5.683E-01
678	59	91	54.48	-3.280E-06	2.371E-03	5.683E-01
679	59	91	54.76	-3.280E-06	2.371E-03	5.683E-01
680	60	91	54.84	-3.280E-06	2.371E-03	5.683E-01
681	60	91	54.87	-3.280E-06	2.371E-03	5.683E-01
682	60.5	90	54.9	-3.280E-06	2.371E-03	5.683E-01
683	61	89	54.93	-3.280E-06	2.371E-03	5.683E-01
684	61.5	88	54.97	-3.280E-06	2.371E-03	5.683E-01
685	62	83	55	-3.280E-06	2.371E-03	5.683E-01
686	63	73	55.03	-3.280E-06	2.371E-03	5.683E-01
687	65	70	55.06	-3.280E-06	2.371E-03	5.683E-01
688	66	71	55.1	-3.280E-06	2.371E-03	5.683E-01
689	67	74	55.12	-3.280E-06	2.371E-03	5.683E-01
690	67.5	79	55.15	-3.280E-06	2.371E-03	5.683E-01
691	68	85	55.16	-3.280E-06	2.371E-03	5.683E-01
692	68.5	90	55.18	-3.280E-06	2.371E-03	5.683E-01
693	69	94	55.33	-3.280E-06	2.371E-03	5.683E-01
694	69.5	96	55.85	-3.280E-06	2.371E-03	5.683E-01
695	70	98	56.52	-3.280E-06	2.371E-03	5.683E-01
696	70.5	100	57.05	-3.280E-06	2.371E-03	5.683E-01
697	71	100	57.31	-3.280E-06	2.371E-03	5.683E-01
698	72	100	57.35	-3.280E-06	2.371E-03	5.683E-01
699	72	100	57.34	-3.280E-06	2.371E-03	5.683E-01
700	72	100	57.34	-2.967E-06	2.047E-03	8.641E-01
701	72	100	57.33	-2.653E-06	1.723E-03	1.160E+00
702	72	100	57.33	-2.340E-06	1.399E-03	1.456E+00
703	72	100	57.33	-2.340E-06	1.399E-03	1.456E+00
704	72	100	57.32	-2.340E-06	1.399E-03	1.456E+00
705	72	100	57.31	-2.340E-06	1.399E-03	1.456E+00
706	72	100	57.3	-2.340E-06	1.399E-03	1.456E+00
707	72.5	100	57.39	-2.340E-06	1.399E-03	1.456E+00
708	73	100	57.71	-2.340E-06	1.399E-03	1.456E+00
709	73.5	100	58.14	-2.340E-06	1.399E-03	1.456E+00
710	74	100	58.34	-2.340E-06	1.399E-03	1.456E+00
711	74	100	58.34	-2.340E-06	1.399E-03	1.456E+00
712	74.5	100	58.33	-2.340E-06	1.399E-03	1.456E+00
713	75	100	58.33	-2.340E-06	1.399E-03	1.456E+00
714	75	100	58.32	-2.340E-06	1.399E-03	1.456E+00
715	75	100	58.31	-2.340E-06	1.399E-03	1.456E+00

716	75	100	58.3	-2.340E-06	1.399E-03	1.456E+00
717	75	100	58.3	-2.340E-06	1.399E-03	1.456E+00
718	75	100	58.3	-2.340E-06	1.399E-03	1.456E+00
719	75	100	58.3	-2.340E-06	1.399E-03	1.456E+00
720	75	100	58.48	-2.340E-06	1.399E-03	1.456E+00
721	75	100	58.92	-2.340E-06	1.399E-03	1.456E+00
722	75	100	59.26	-2.340E-06	1.399E-03	1.456E+00
723	75	98	59.34	-2.340E-06	1.399E-03	1.456E+00
724	75	90	59.32	-2.340E-06	1.399E-03	1.456E+00
725	75	34	59.37	-3.622E-06	2.640E-03	9.220E-01
726	74	15	59.67	-4.905E-06	3.881E-03	3.883E-01
727	72	3	60.11	-6.187E-06	5.122E-03	-1.455E-01
728	70	( <sup>o</sup> )	60.32	-6.187E-06	5.122E-03	-1.455E-01
729	69	( <sup>o</sup> )	60.3	-6.187E-06	5.122E-03	-1.455E-01
730	68	( <sup>o</sup> )	60.29	-6.187E-06	5.122E-03	-1.455E-01
731	70.5	53	60.27	-6.187E-06	5.122E-03	-1.455E-01
732	73	80	60.26	-6.187E-06	5.122E-03	-1.455E-01
733	75	88	60.25	-6.187E-06	5.122E-03	-1.455E-01
734	77	94	60.18	-6.187E-06	5.122E-03	-1.455E-01
735	79	97	59.83	-6.187E-06	5.122E-03	-1.455E-01
736	82	97	59.36	-6.187E-06	5.122E-03	-1.455E-01
737	85	98	59.65	-6.187E-06	5.122E-03	-1.455E-01
738	85	98	60.12	-6.187E-06	5.122E-03	-1.455E-01
739	87	97	59.8	-6.187E-06	5.122E-03	-1.455E-01
740	90	95	59.82	-6.187E-06	5.122E-03	-1.455E-01
741	92	90	60.18	-6.187E-06	5.122E-03	-1.455E-01
742	93	88	60.27	-6.187E-06	5.122E-03	-1.455E-01
743	94	86	60.31	-6.187E-06	5.122E-03	-1.455E-01
744	95	83	60.35	-6.187E-06	5.122E-03	-1.455E-01
745	96	79	60.37	-6.187E-06	5.122E-03	-1.455E-01
746	97	74	60.35	-6.187E-06	5.122E-03	-1.455E-01
747	98	68	60.33	-6.187E-06	5.122E-03	-1.455E-01
748	99	62	60.3	-6.187E-06	5.122E-03	-1.455E-01
749	100	54	60.26	-6.187E-06	5.122E-03	-1.455E-01
750	100	30	60.45	-7.791E-06	6.722E-03	-9.485E-01
751	100	22	61.12	-9.395E-06	8.322E-03	-1.752E+00
752	100	20	61.91	-1.100E-05	9.923E-03	-2.555E+00
753	100	22	62.23	-1.100E-05	9.923E-03	-2.555E+00
754	100	30	62.19	-1.100E-05	9.923E-03	-2.555E+00
755	100	65	62.17	-1.100E-05	9.923E-03	-2.555E+00
756	100	76	62.19	-1.100E-05	9.923E-03	-2.555E+00
757	100	80	62.24	-1.100E-05	9.923E-03	-2.555E+00
758	100	78	62.28	-1.100E-05	9.923E-03	-2.555E+00
759	100	72	62.3	-1.100E-05	9.923E-03	-2.555E+00
760	100	54	62.79	-1.100E-05	9.923E-03	-2.555E+00
761	95	30	63.22	-1.100E-05	9.923E-03	-2.555E+00
762	85	12	63.11	-1.100E-05	9.923E-03	-2.555E+00
763	68	( <sup>o</sup> )	62.97	-1.100E-05	9.923E-03	-2.555E+00
764	57	( <sup>o</sup> )	62.82	-1.100E-05	9.923E-03	-2.555E+00
765	56	( <sup>o</sup> )	62.67	-1.100E-05	9.923E-03	-2.555E+00
766	57	( <sup>o</sup> )	62.52	-1.100E-05	9.923E-03	-2.555E+00
767	57	( <sup>o</sup> )	62.37	-1.100E-05	9.923E-03	-2.555E+00
768	57	22	62.32	-1.100E-05	9.923E-03	-2.555E+00
769	58	40	62.45	-1.100E-05	9.923E-03	-2.555E+00
770	59	45	62.64	-1.100E-05	9.923E-03	-2.555E+00
771	59	46	62.69	-1.100E-05	9.923E-03	-2.555E+00
772	59.5	45	62.66	-1.100E-05	9.923E-03	-2.555E+00
773	60	33	62.62	-1.100E-05	9.923E-03	-2.555E+00
774	60	0	62.59	-1.100E-05	9.923E-03	-2.555E+00
775	60	( <sup>o</sup> )	62.55	-1.027E-05	9.176E-03	-2.095E+00
776	60	( <sup>o</sup> )	62.51	-9.541E-06	8.429E-03	-1.636E+00
777	60	34	62.44	-8.813E-06	7.683E-03	-1.177E+00
778	60	50	62.37	-8.813E-06	7.683E-03	-1.177E+00
779	60	60	62.29	-8.813E-06	7.683E-03	-1.177E+00
780	60	69	62.21	-8.813E-06	7.683E-03	-1.177E+00
781	60	75	62.15	-8.813E-06	7.683E-03	-1.177E+00
782	60	79	62.46	-8.813E-06	7.683E-03	-1.177E+00
783	61	83	63.4	-8.813E-06	7.683E-03	-1.177E+00
784	61	84	63.97	-8.813E-06	7.683E-03	-1.177E+00
785	61	85	63.98	-8.813E-06	7.683E-03	-1.177E+00
786	62	85	63.94	-8.813E-06	7.683E-03	-1.177E+00
787	62	85	63.93	-8.813E-06	7.683E-03	-1.177E+00



788	62	85	63.92	-8.813E-06	7.683E-03	-1.177E+00
789	63	85	63.92	-8.813E-06	7.683E-03	-1.177E+00
790	63	85	63.91	-8.813E-06	7.683E-03	-1.177E+00
791	64	85	64.21	-8.813E-06	7.683E-03	-1.177E+00
792	64	85	64.61	-8.813E-06	7.683E-03	-1.177E+00
793	64	85	64.5	-8.813E-06	7.683E-03	-1.177E+00
794	64	85	64.05	-8.813E-06	7.683E-03	-1.177E+00
795	64	85	63.83	-8.813E-06	7.683E-03	-1.177E+00
796	64	84.5	63.81	-8.813E-06	7.683E-03	-1.177E+00
797	64	84	63.79	-8.813E-06	7.683E-03	-1.177E+00
798	64	83	63.77	-8.813E-06	7.683E-03	-1.177E+00
799	64	82	63.76	-8.813E-06	7.683E-03	-1.177E+00
800	64	81	63.75	-8.873E-06	7.725E-03	-1.104E+00
801	64	77	63.73	-8.933E-06	7.767E-03	-1.032E+00
802	64	72	63.72	-8.993E-06	7.810E-03	-9.592E-01
803	65	67	63.7	-8.993E-06	7.810E-03	-9.592E-01
804	66	64	63.69	-8.993E-06	7.810E-03	-9.592E-01
805	67	60	63.69	-8.993E-06	7.810E-03	-9.592E-01
806	69	62.3	63.68	-8.993E-06	7.810E-03	-9.592E-01
807	72	84	64.1	-8.993E-06	7.810E-03	-9.592E-01
808	73	90.5	64.6	-8.993E-06	7.810E-03	-9.592E-01
809	74	91	64.73	-8.993E-06	7.810E-03	-9.592E-01
810	74	90	64.73	-8.993E-06	7.810E-03	-9.592E-01
811	74	84.5	64.73	-8.993E-06	7.810E-03	-9.592E-01
812	73	74	64.72	-8.993E-06	7.810E-03	-9.592E-01
813	72	66	64.71	-8.993E-06	7.810E-03	-9.592E-01
814	71	60	64.71	-8.993E-06	7.810E-03	-9.592E-01
815	70	54	64.7	-8.993E-06	7.810E-03	-9.592E-01
816	69	50	64.69	-8.993E-06	7.810E-03	-9.592E-01
817	68	49	64.68	-8.993E-06	7.810E-03	-9.592E-01
818	68	48	64.82	-8.993E-06	7.810E-03	-9.592E-01
819	68	48	65.27	-8.993E-06	7.810E-03	-9.592E-01
820	68	48.5	65.65	-8.993E-06	7.810E-03	-9.592E-01
821	68	49	65.71	-8.993E-06	7.810E-03	-9.592E-01
822	68	51	65.72	-8.993E-06	7.810E-03	-9.592E-01
823	68	53.5	65.72	-8.993E-06	7.810E-03	-9.592E-01
824	68	55	65.72	-8.993E-06	7.810E-03	-9.592E-01
825	68	58	65.71	-8.993E-06	7.810E-03	-9.592E-01
826	68	60	65.7	-8.993E-06	7.810E-03	-9.592E-01
827	68	62	65.69	-8.993E-06	7.810E-03	-9.592E-01
828	68	64	65.67	-8.993E-06	7.810E-03	-9.592E-01
829	68	67	65.27	-8.993E-06	7.810E-03	-9.592E-01
830	69	68.5	64.33	-8.993E-06	7.810E-03	-9.592E-01
831	70	70	63.65	-8.993E-06	7.810E-03	-9.592E-01
832	70	70	63.5	-8.993E-06	7.810E-03	-9.592E-01
833	70	70	63.49	-8.993E-06	7.810E-03	-9.592E-01
834	70	70	63.49	-8.993E-06	7.810E-03	-9.592E-01
835	70	70	63.37	-8.993E-06	7.810E-03	-9.592E-01
836	70	70	63.01	-8.993E-06	7.810E-03	-9.592E-01
837	71	66	62.6	-8.993E-06	7.810E-03	-9.592E-01
838	73	64	62.44	-8.993E-06	7.810E-03	-9.592E-01
839	75	64	62.45	-8.993E-06	7.810E-03	-9.592E-01
840	77	98	62.47	-5.933E-06	4.759E-03	5.464E-01
841	79	100	62.5	-2.873E-06	1.709E-03	2.052E+00
842	81	100	62.52	1.865E-07	-1.342E-03	3.558E+00
843	82	100	62.54	1.865E-07	-1.342E-03	3.558E+00
844	83	100	62.57	1.865E-07	-1.342E-03	3.558E+00
845	84	98	62.7	1.865E-07	-1.342E-03	3.558E+00
846	84	94	62.9	1.865E-07	-1.342E-03	3.558E+00
847	85	93	63.11	1.865E-07	-1.342E-03	3.558E+00
848	86	94	63.32	1.865E-07	-1.342E-03	3.558E+00
849	87	98	63.53	1.865E-07	-1.342E-03	3.558E+00
850	89	100	63.74	1.865E-07	-1.342E-03	3.558E+00
851	92	100	62.2	1.865E-07	-1.342E-03	3.558E+00
852	95	100	62.67	1.865E-07	-1.342E-03	3.558E+00
853	97.5	100	63.19	1.865E-07	-1.342E-03	3.558E+00
854	100	100	63.62	1.865E-07	-1.342E-03	3.558E+00
855	100	100	64.06	1.865E-07	-1.342E-03	3.558E+00
856	100	100	64.19	6.218E-08	-4.474E-04	1.186E+00
857	100	100	63.87	-6.218E-08	4.474E-04	-1.186E+00
858	100	97	63.38	-1.865E-07	1.342E-03	-3.558E+00
859	96	( <sup>e</sup> )	62.62	-1.865E-07	1.342E-03	-3.558E+00

860	94	(°)	61.32	-1.865E-07	1.342E-03	-3.558E+00
861	91	(°)	59.72	-1.865E-07	1.342E-03	-3.558E+00
862	88	(°)	58.3	-1.865E-07	1.342E-03	-3.558E+00
863	86	(°)	57.08	-1.865E-07	1.342E-03	-3.558E+00
864	84	(°)	55.85	-1.865E-07	1.342E-03	-3.558E+00
865	82	(°)	54.61	-1.865E-07	1.342E-03	-3.558E+00
866	79	(°)	53.36	-1.865E-07	1.342E-03	-3.558E+00
867	77	(°)	52.1	-1.865E-07	1.342E-03	-3.558E+00
868	75	(°)	50.74	-1.865E-07	1.342E-03	-3.558E+00
869	73	(°)	49.34	-1.865E-07	1.342E-03	-3.558E+00
870	72	(°)	48.05	-1.865E-07	1.342E-03	-3.558E+00
871	72	(°)	46.82	-1.865E-07	1.342E-03	-3.558E+00
872	72	(°)	45.61	-1.865E-07	1.342E-03	-3.558E+00
873	71	8	44.37	-1.865E-07	1.342E-03	-3.558E+00
874	68	9	43.06	-1.865E-07	1.342E-03	-3.558E+00
875	64	(°)	41.65	-1.865E-07	1.342E-03	-3.558E+00
876	58	(°)	40.32	-1.865E-07	1.342E-03	-3.558E+00
877	56	53	39.28	-1.865E-07	1.342E-03	-3.558E+00
878	56	67	38.4	-1.865E-07	1.342E-03	-3.558E+00
879	56	70	37.3	-1.865E-07	1.342E-03	-3.558E+00
880	56	67	35.79	-1.865E-07	1.342E-03	-3.558E+00
881	55	60	34.14	-1.865E-07	1.342E-03	-3.558E+00
882	54	60	32.69	-1.865E-07	1.342E-03	-3.558E+00
883	49	75	31.38	-1.865E-07	1.342E-03	-3.558E+00
884	38	80	29.63	-1.865E-07	1.342E-03	-3.558E+00
885	30	78	27.22	-1.865E-07	1.342E-03	-3.558E+00
886	25	53	25.01	-1.865E-07	1.342E-03	-3.558E+00
887	18	32	23.09	-1.865E-07	1.342E-03	-3.558E+00
888	14	16	20.23	-1.865E-07	1.342E-03	-3.558E+00
889	9	3	17.2	-1.865E-07	1.342E-03	-3.558E+00
890	5	(°)	12.61	-1.865E-07	1.342E-03	-3.558E+00
891	1	(°)	7.43	-1.865E-07	1.342E-03	-3.558E+00
892	0	0	2.81	-1.865E-07	1.342E-03	-3.558E+00
893	0	0	0	-1.865E-07	1.342E-03	-3.558E+00
900	0	0	0	-1.865E-07	1.342E-03	-3.558E+00
901	0	0	0	8.801E-06	-7.855E-03	-7.493E-01
902	0	0	0	1.779E-05	-1.705E-02	2.059E+00
903	0	0	0	2.678E-05	-2.625E-02	4.867E+00
919	0	0	0	2.678E-05	-2.625E-02	4.867E+00
920	4.5	47	2.63	2.678E-05	-2.625E-02	4.867E+00
921	12	85	4.93	2.678E-05	-2.625E-02	4.867E+00
922	30	97	7.24	2.678E-05	-2.625E-02	4.867E+00
923	42	100	9.73	2.678E-05	-2.625E-02	4.867E+00
924	51	100	11.91	2.678E-05	-2.625E-02	4.867E+00
925	54	100	14.16	2.678E-05	-2.625E-02	4.867E+00
926	54	97	16.04	2.678E-05	-2.625E-02	4.867E+00
927	52	90	17.98	2.678E-05	-2.625E-02	4.867E+00
928	48	75	20.21	2.678E-05	-2.625E-02	4.867E+00
929	44	57	22.03	2.678E-05	-2.625E-02	4.867E+00
930	37	47	22.35	8.925E-06	-8.749E-03	1.622E+00
931	29	40	21.52	-8.925E-06	8.749E-03	-1.622E+00
932	24	34	20.04	-2.678E-05	2.625E-02	-4.867E+00
933	21	27	18.29	-2.678E-05	2.625E-02	-4.867E+00
934	22	24	16.4	-2.678E-05	2.625E-02	-4.867E+00
935	22.5	22	14.4	-2.678E-05	2.625E-02	-4.867E+00
936	20	16	12.23	-2.678E-05	2.625E-02	-4.867E+00
937	15	7	9.84	-2.678E-05	2.625E-02	-4.867E+00
938	10	0	8.55	-2.678E-05	2.625E-02	-4.867E+00
939	5	(°)	7.56	-2.678E-05	2.625E-02	-4.867E+00
940	2	(°)	6.14	-2.678E-05	2.625E-02	-4.867E+00
941	1	(°)	2.6	-2.678E-05	2.625E-02	-4.867E+00
942	0	0	0	-2.678E-05	2.625E-02	-4.867E+00
943	0	0	0	-2.678E-05	2.625E-02	-4.867E+00
944	0	0	0	-1.658E-05	1.607E-02	-3.386E+00
945	1	0	1.06	-6.376E-06	5.889E-03	-1.905E+00
946	5	20	2.16	3.823E-06	-4.291E-03	-4.241E-01
947	15	43	3.3	3.823E-06	-4.291E-03	-4.241E-01
948	28	52	4.37	3.823E-06	-4.291E-03	-4.241E-01
949	34	64	5.42	3.823E-06	-4.291E-03	-4.241E-01
950	37	74	6.47	3.823E-06	-4.291E-03	-4.241E-01
951	37.5	90	7.51	3.823E-06	-4.291E-03	-4.241E-01
952	37	56	8.55	3.823E-06	-4.291E-03	-4.241E-01

953	36	27	9.55	3.823E-06	-4.291E-03	-4.241E-01
954	35	( <sup>6</sup> )	10.25	3.823E-06	-4.291E-03	-4.241E-01
955	33	( <sup>6</sup> )	10.78	3.823E-06	-4.291E-03	-4.241E-01
956	29	( <sup>6</sup> )	11.16	3.823E-06	-4.291E-03	-4.241E-01
957	29	( <sup>6</sup> )	11.76	3.823E-06	-4.291E-03	-4.241E-01
958	29	( <sup>6</sup> )	12.59	3.823E-06	-4.291E-03	-4.241E-01
959	34	30	13.8	3.823E-06	-4.291E-03	-4.241E-01
960	38	75	14.85	3.823E-06	-4.291E-03	-4.241E-01
961	34	70	15.59	3.823E-06	-4.291E-03	-4.241E-01
962	31	25	16.2	3.823E-06	-4.291E-03	-4.241E-01
963	28	( <sup>6</sup> )	16.82	3.823E-06	-4.291E-03	-4.241E-01
964	26	( <sup>6</sup> )	17.55	3.823E-06	-4.291E-03	-4.241E-01
965	24	( <sup>6</sup> )	17.91	3.823E-06	-4.291E-03	-4.241E-01
966	23	4	18.08	3.823E-06	-4.291E-03	-4.241E-01
967	23	22	18.1	3.823E-06	-4.291E-03	-4.241E-01
968	24	30	18.31	3.823E-06	-4.291E-03	-4.241E-01
969	23	32	18.67	3.823E-06	-4.291E-03	-4.241E-01
970	22	25	19.23	7.198E-06	-7.629E-03	2.015E+00
971	18	18	19.69	1.057E-05	-1.097E-02	4.453E+00
972	16	14	20.02	1.395E-05	-1.430E-02	6.892E+00
973	15	10	19.94	1.395E-05	-1.430E-02	6.892E+00
974	15	0	19.8	1.395E-05	-1.430E-02	6.892E+00
975	15	( <sup>6</sup> )	19.69	1.395E-05	-1.430E-02	6.892E+00
976	15	( <sup>6</sup> )	19.76	1.395E-05	-1.430E-02	6.892E+00
977	18	( <sup>6</sup> )	19.93	1.395E-05	-1.430E-02	6.892E+00
978	25	40	20.24	1.395E-05	-1.430E-02	6.892E+00
979	37	90	20.69	1.395E-05	-1.430E-02	6.892E+00
980	46	90	21.23	1.395E-05	-1.430E-02	6.892E+00
981	49	90	21.78	1.395E-05	-1.430E-02	6.892E+00
982	49	90	22.15	1.395E-05	-1.430E-02	6.892E+00
983	49	85	22.33	1.395E-05	-1.430E-02	6.892E+00
984	47	77	22.36	1.395E-05	-1.430E-02	6.892E+00
985	44	59	22.36	4.650E-06	-4.768E-03	2.297E+00
986	43	36	22.33	-4.650E-06	4.768E-03	-2.297E+00
987	42	13	22.15	-1.395E-05	1.430E-02	-6.892E+00
988	40	( <sup>6</sup> )	21.91	-1.395E-05	1.430E-02	-6.892E+00
989	41	65	21.62	-1.395E-05	1.430E-02	-6.892E+00
990	44	65	21.32	-1.395E-05	1.430E-02	-6.892E+00
991	45	65	21.01	-1.395E-05	1.430E-02	-6.892E+00
992	45	62	20.7	-1.395E-05	1.430E-02	-6.892E+00
993	44	56	20.48	-1.395E-05	1.430E-02	-6.892E+00
994	42	46	20.31	-1.395E-05	1.430E-02	-6.892E+00
995	41	36	20.13	-1.395E-05	1.430E-02	-6.892E+00
996	39	20	19.86	-1.395E-05	1.430E-02	-6.892E+00
997	38	4	19.49	-1.395E-05	1.430E-02	-6.892E+00
998	37	33	19.11	-1.395E-05	1.430E-02	-6.892E+00
999	38	39	18.71	-1.395E-05	1.430E-02	-6.892E+00
1,000	36	40	18.3	-1.395E-05	1.430E-02	-6.892E+00
1,001	35	40	17.86	-1.395E-05	1.430E-02	-6.892E+00
1,002	33	39	17.39	-1.395E-05	1.430E-02	-6.892E+00
1,003	30	36	16.86	-1.395E-05	1.430E-02	-6.892E+00
1,004	27	33	16.31	-1.395E-05	1.430E-02	-6.892E+00
1,005	22	24	15.75	-1.395E-05	1.430E-02	-6.892E+00
1,006	21	( <sup>6</sup> )	15.24	-1.395E-05	1.430E-02	-6.892E+00
1,007	20	( <sup>6</sup> )	14.73	-1.395E-05	1.430E-02	-6.892E+00
1,008	18	( <sup>6</sup> )	14.23	-1.395E-05	1.430E-02	-6.892E+00
1,009	17	28	13.73	-1.395E-05	1.430E-02	-6.892E+00
1,010	16	5	12.79	-1.395E-05	1.430E-02	-6.892E+00
1,011	14	( <sup>6</sup> )	11.11	-1.395E-05	1.430E-02	-6.892E+00
1,012	12	( <sup>6</sup> )	9.43	-1.395E-05	1.430E-02	-6.892E+00
1,013	9	( <sup>6</sup> )	7.75	-1.395E-05	1.430E-02	-6.892E+00
1,014	7	( <sup>6</sup> )	6.07	-1.395E-05	1.430E-02	-6.892E+00
1,015	5	( <sup>6</sup> )	4.39	-4.650E-06	4.768E-03	-2.297E+00
1,016	4	( <sup>6</sup> )	2.71	4.650E-06	-4.768E-03	2.297E+00
1,017	3	( <sup>6</sup> )	1.03	1.395E-05	-1.430E-02	6.892E+00
1,018	2	( <sup>6</sup> )	0.19	1.395E-05	-1.430E-02	6.892E+00
1,019	0	0	0	1.395E-05	-1.430E-02	6.892E+00
1,020	0	0	0	1.395E-05	-1.430E-02	6.892E+00
1,021	0	0	0	1.458E-05	-1.532E-02	5.630E+00
1,022	0	0	0	1.520E-05	-1.634E-02	4.368E+00
1,023	0	0	0	1.583E-05	-1.736E-02	3.105E+00
1,024	0	0	0	1.583E-05	-1.736E-02	3.105E+00

1,025	2	7	3.25	1.583E-05	-1.736E-02	3.105E+00
1,026	6	15	5.47	1.583E-05	-1.736E-02	3.105E+00
1,027	10	28	6.71	1.583E-05	-1.736E-02	3.105E+00
1,028	11	26	6.71	1.583E-05	-1.736E-02	3.105E+00
1,029	10	10	6.71	5.277E-06	-5.787E-03	1.035E+00
1,030	8	3	6.55	-5.277E-06	5.787E-03	-1.035E+00
1,031	5	0	6.01	-1.583E-05	1.736E-02	-3.105E+00
1,032	2	0	5.15	-1.583E-05	1.736E-02	-3.105E+00
1,033	0	0	3.9	-1.583E-05	1.736E-02	-3.105E+00
1,034	0	0	2.19	-1.583E-05	1.736E-02	-3.105E+00
1,035	0	0	0	-5.277E-06	5.787E-03	-1.035E+00
1,036	0	0	0	5.277E-06	-5.787E-03	1.035E+00
1,037	0	0	0	1.583E-05	-1.736E-02	3.105E+00
1,060	0	0	0	1.583E-05	-1.736E-02	3.105E+00
1,061	4	5	1.95	1.583E-05	-1.736E-02	3.105E+00
1,062	11	35	3.7	1.583E-05	-1.736E-02	3.105E+00
1,063	21	73	5.53	1.583E-05	-1.736E-02	3.105E+00
1,064	25	86	7.22	1.583E-05	-1.736E-02	3.105E+00
1,065	26	90	8.64	1.583E-05	-1.736E-02	3.105E+00
1,066	25	90	10.33	1.583E-05	-1.736E-02	3.105E+00
1,067	23	83	11.18	5.277E-06	-5.787E-03	1.035E+00
1,068	20	32	10.57	-5.277E-06	5.787E-03	-1.035E+00
1,069	16	(*)	9.33	-1.583E-05	1.736E-02	-3.105E+00
1,070	14	(*)	7.87	-1.583E-05	1.736E-02	-3.105E+00
1,071	10	(*)	6.27	-1.583E-05	1.736E-02	-3.105E+00
1,072	7	(*)	4.58	-1.583E-05	1.736E-02	-3.105E+00
1,073	3	(*)	3.81	-1.583E-05	1.736E-02	-3.105E+00
1,074	1	(*)	2.35	-1.583E-05	1.736E-02	-3.105E+00
1,075	0	0	0	-1.583E-05	1.736E-02	-3.105E+00
1,076	0	0	0	-6.540E-06	7.597E-03	-2.563E+00
1,077	0	0	0	2.749E-06	-2.167E-03	-2.021E+00
1,078	0	0	0	1.204E-05	-1.193E-02	-1.480E+00
1,097	0	0	0	1.204E-05	-1.193E-02	-1.480E+00
1,098	1	3	1.35	1.204E-05	-1.193E-02	-1.480E+00
1,099	3	6	3.37	1.204E-05	-1.193E-02	-1.480E+00
1,100	6	13	6.4	1.204E-05	-1.193E-02	-1.480E+00
1,101	9	14	8.47	1.204E-05	-1.193E-02	-1.480E+00
1,102	12	16	9.57	1.204E-05	-1.193E-02	-1.480E+00
1,103	15	28	10.19	1.204E-05	-1.193E-02	-1.480E+00
1,104	18	60	10.35	1.204E-05	-1.193E-02	-1.480E+00
1,105	20	47	10.46	1.204E-05	-1.193E-02	-1.480E+00
1,106	21	31	10.11	1.204E-05	-1.193E-02	-1.480E+00
1,107	21	15	9.12	1.204E-05	-1.193E-02	-1.480E+00
1,108	20	(*)	7.81	1.133E-05	-1.140E-02	1.667E-01
1,109	20	(*)	7.87	1.062E-05	-1.087E-02	1.813E+00
1,110	20	(*)	9.57	9.917E-06	-1.035E-02	3.459E+00
1,111	20	70	9.75	9.917E-06	-1.035E-02	3.459E+00
1,112	21	83	9.84	9.917E-06	-1.035E-02	3.459E+00
1,113	22	84	9.96	9.917E-06	-1.035E-02	3.459E+00
1,114	22	83	10.13	3.306E-06	-3.449E-03	1.153E+00
1,115	18	78	9.36	-3.306E-06	3.449E-03	-1.153E+00
1,116	14	68	8.8	-9.917E-06	1.035E-02	-3.459E+00
1,117	8	10	7.67	-9.917E-06	1.035E-02	-3.459E+00
1,118	4	4	6.08	-9.917E-06	1.035E-02	-3.459E+00
1,119	1	0	4.03	-9.917E-06	1.035E-02	-3.459E+00
1,120	0	0	0	-3.306E-06	3.449E-03	-1.153E+00
1,121	0	0	0	3.306E-06	-3.449E-03	1.153E+00
1,122	0	0	0	9.917E-06	-1.035E-02	3.459E+00
1,125	0	1	0	9.917E-06	-1.035E-02	3.459E+00
1,126	1	5	3.25	9.917E-06	-1.035E-02	3.459E+00
1,127	5	18	5.47	9.917E-06	-1.035E-02	3.459E+00
1,128	9	19	6.71	9.917E-06	-1.035E-02	3.459E+00
1,129	12	18	6.71	9.917E-06	-1.035E-02	3.459E+00
1,130	12	15	6.71	9.917E-06	-1.035E-02	3.459E+00
1,131	9	10	6.55	9.917E-06	-1.035E-02	3.459E+00
1,132	5	5	6.01	9.917E-06	-1.035E-02	3.459E+00
1,133	2	2	5.15	9.917E-06	-1.035E-02	3.459E+00
1,134	0	0	3.9	9.917E-06	-1.035E-02	3.459E+00
1,135	0	0	2.19	9.917E-06	-1.035E-02	3.459E+00
1,136	0	0	0	6.611E-06	-6.897E-03	2.306E+00
1,137	0	0	0	3.306E-06	-3.449E-03	1.153E+00
1,138	0	0	0	0	0	0
1,167	0	0	0	0	0	0

\*Closed throttle motoring.

(c) The following transient duty cycle applies for compression-ignition engines and powertrains:

Table 2 of Appendix B—Transient Duty Cycle for Compression-Ignition Engines and Powertrains

Record (seconds)	Engine testing		Vehicle speed (mi/hr)	Powertrain testing		
	Normalized revolutions per minute (percent)	Normalized torque (percent)		Road grade coefficients		
				a	b	c
1	0	0	0	0	0	0
2	0	0	0	1.248E-05	-1.073E-02	1.064E+00
3	0	0	0	1.872E-05	-1.609E-02	1.596E+00
24	0	0	0	1.872E-05	-1.609E-02	1.596E+00
25	0	3.67	0	1.872E-05	-1.609E-02	1.596E+00
26	0	47.69	0	1.872E-05	-1.609E-02	1.596E+00
27	2.78	59.41	0.33	1.872E-05	-1.609E-02	1.596E+00
28	8.12	84.54	1.67	1.872E-05	-1.609E-02	1.596E+00
29	13.95	80	2.83	1.872E-05	-1.609E-02	1.596E+00
30	29.9	80	4.02	1.872E-05	-1.609E-02	1.596E+00
31	33.87	79.29	5.64	1.872E-05	-1.609E-02	1.596E+00
32	27.86	38.25	7.39	1.872E-05	-1.609E-02	1.596E+00
33	19.63	26.67	8.83	1.872E-05	-1.609E-02	1.596E+00
34	26.79	15.1	9.15	1.872E-05	-1.609E-02	1.596E+00
35	19.85	16.47	9.7	1.872E-05	-1.609E-02	1.596E+00
36	17.51	28.05	11.37	1.872E-05	-1.609E-02	1.596E+00
37	17.86	20.38	13.04	1.872E-05	-1.609E-02	1.596E+00
38	16.37	( <sup>g</sup> )	14.74	1.872E-05	-1.609E-02	1.596E+00
39	5.85	( <sup>g</sup> )	16.41	2.033E-05	-1.775E-02	3.890E+00
40	14.13	( <sup>g</sup> )	16.85	2.194E-05	-1.941E-02	6.184E+00
41	21.1	( <sup>g</sup> )	16.09	2.356E-05	-2.107E-02	8.477E+00
42	15.63	( <sup>g</sup> )	15.23	2.356E-05	-2.107E-02	8.477E+00
43	12.67	62.52	14.22	2.356E-05	-2.107E-02	8.477E+00
44	14.86	69.36	13.02	2.356E-05	-2.107E-02	8.477E+00
45	24.79	60	12.47	2.356E-05	-2.107E-02	8.477E+00
46	33.06	63.79	13.05	2.356E-05	-2.107E-02	8.477E+00
47	42.29	75.36	14.26	2.356E-05	-2.107E-02	8.477E+00
48	48.9	80	15.09	2.356E-05	-2.107E-02	8.477E+00
49	51.52	80	15.42	2.356E-05	-2.107E-02	8.477E+00
50	48.24	79.92	15.96	2.356E-05	-2.107E-02	8.477E+00
51	51.79	65.03	16.58	2.356E-05	-2.107E-02	8.477E+00
52	52.37	43.23	17.61	2.356E-05	-2.107E-02	8.477E+00
53	56.14	50	18.33	2.356E-05	-2.107E-02	8.477E+00
54	62.35	50	18.65	2.356E-05	-2.107E-02	8.477E+00
55	64.29	42.05	19.67	2.356E-05	-2.107E-02	8.477E+00
56	67.69	40	20.47	2.356E-05	-2.107E-02	8.477E+00
57	75.2	42.2	20.57	2.356E-05	-2.107E-02	8.477E+00
58	74.88	41.28	20.68	2.356E-05	-2.107E-02	8.477E+00
59	71.92	( <sup>g</sup> )	21.56	2.356E-05	-2.107E-02	8.477E+00
60	71.88	( <sup>g</sup> )	23.19	2.356E-05	-2.107E-02	8.477E+00
61	69.64	( <sup>g</sup> )	23.64	7.852E-06	-7.024E-03	2.826E+00
62	71.24	( <sup>g</sup> )	22.75	-7.852E-06	7.024E-03	-2.826E+00
63	71.72	30.54	21.81	-2.356E-05	2.107E-02	-8.477E+00
64	76.41	42.12	20.79	-2.356E-05	2.107E-02	-8.477E+00
65	73.02	50	19.86	-2.356E-05	2.107E-02	-8.477E+00
66	69.64	50	19.18	-2.356E-05	2.107E-02	-8.477E+00
67	72.09	43.16	18.75	-2.356E-05	2.107E-02	-8.477E+00
68	82.23	73.65	18.43	-2.356E-05	2.107E-02	-8.477E+00
69	78.58	( <sup>g</sup> )	18.61	-2.356E-05	2.107E-02	-8.477E+00
70	75	( <sup>g</sup> )	19.11	-2.356E-05	2.107E-02	-8.477E+00
71	75	( <sup>g</sup> )	18.76	-2.356E-05	2.107E-02	-8.477E+00
72	72.47	( <sup>g</sup> )	17.68	-2.356E-05	2.107E-02	-8.477E+00
73	62.91	( <sup>g</sup> )	16.46	-2.356E-05	2.107E-02	-8.477E+00
74	58.93	13.57	15.06	-2.356E-05	2.107E-02	-8.477E+00
75	55.56	29.43	13.41	-2.356E-05	2.107E-02	-8.477E+00
76	57.14	20	11.91	-2.356E-05	2.107E-02	-8.477E+00
77	56.68	17.42	11.09	-2.356E-05	2.107E-02	-8.477E+00

78	53.88	10	10.9	-2.356E-05	2.107E-02	-8.477E+00
79	50.76	10	11.4	-2.356E-05	2.107E-02	-8.477E+00
80	50	(°)	12.38	-2.356E-05	2.107E-02	-8.477E+00
81	46.83	(°)	13.02	-2.356E-05	2.107E-02	-8.477E+00
82	35.63	10	12.3	-2.356E-05	2.107E-02	-8.477E+00
83	32.48	10	10.32	-2.356E-05	2.107E-02	-8.477E+00
84	26.79	10	9.7	-2.356E-05	2.107E-02	-8.477E+00
85	24.94	10	11.05	-2.356E-05	2.107E-02	-8.477E+00
86	23.21	16.74	11.88	-2.356E-05	2.107E-02	-8.477E+00
87	24.7	3.36	12.21	-2.356E-05	2.107E-02	-8.477E+00
88	25	(°)	13.29	-2.356E-05	2.107E-02	-8.477E+00
89	24.47	(°)	13.73	-2.356E-05	2.107E-02	-8.477E+00
90	18.71	(°)	12.77	-2.356E-05	2.107E-02	-8.477E+00
91	10.85	(°)	11.46	-2.356E-05	2.107E-02	-8.477E+00
92	3.4	(°)	9.84	-2.356E-05	2.107E-02	-8.477E+00
93	0	0	7.62	-2.356E-05	2.107E-02	-8.477E+00
94	0	0	3.57	-2.356E-05	2.107E-02	-8.477E+00
95	0	0.91	1.33	-2.356E-05	2.107E-02	-8.477E+00
96	0	7.52	0	-2.356E-05	2.107E-02	-8.477E+00
97	0	0	0	-2.356E-05	2.107E-02	-8.477E+00
99	0	0	0	-2.356E-05	2.107E-02	-8.477E+00
100	0	0	0	-9.275E-06	8.450E-03	-4.643E+00
101	0	0	0	5.004E-06	-4.171E-03	-8.092E-01
102	0	0	0	1.928E-05	-1.679E-02	3.025E+00
128	0	0	0	1.928E-05	-1.679E-02	3.025E+00
129	1.58	(°)	0	1.928E-05	-1.679E-02	3.025E+00
130	1.43	(°)	0	1.928E-05	-1.679E-02	3.025E+00
131	0	0	0	1.928E-05	-1.679E-02	3.025E+00
132	0	0	0	1.928E-05	-1.679E-02	3.025E+00
133	1.91	9.28	0	1.928E-05	-1.679E-02	3.025E+00
134	2.75	0	0	1.928E-05	-1.679E-02	3.025E+00
135	0	0	0	1.928E-05	-1.679E-02	3.025E+00
146	0	0	0	1.928E-05	-1.679E-02	3.025E+00
147	0	5.51	0	1.928E-05	-1.679E-02	3.025E+00
148	0	11.34	0	1.928E-05	-1.679E-02	3.025E+00
149	0	0	0	1.928E-05	-1.679E-02	3.025E+00
157	0	0	0	1.928E-05	-1.679E-02	3.025E+00
158	0	0.21	0	1.928E-05	-1.679E-02	3.025E+00
159	0	30	0	1.928E-05	-1.679E-02	3.025E+00
160	0	26.78	0	1.928E-05	-1.679E-02	3.025E+00
161	0	20	0	1.928E-05	-1.679E-02	3.025E+00
162	0	20	0	1.928E-05	-1.679E-02	3.025E+00
163	0	4.12	0	1.928E-05	-1.679E-02	3.025E+00
164	0	0	0	1.928E-05	-1.679E-02	3.025E+00
183	0	0	0	1.928E-05	-1.679E-02	3.025E+00
184	0	20	0	1.928E-05	-1.679E-02	3.025E+00
185	0	20	0	1.928E-05	-1.679E-02	3.025E+00
186	0	11.73	0	1.928E-05	-1.679E-02	3.025E+00
187	0	0	0	1.928E-05	-1.679E-02	3.025E+00
213	0	0	0	1.928E-05	-1.679E-02	3.025E+00
214	0	73.41	0	1.928E-05	-1.679E-02	3.025E+00
215	0	90	0	1.928E-05	-1.679E-02	3.025E+00
216	27.95	81.3	0	1.928E-05	-1.679E-02	3.025E+00
217	36.74	90	2.8	1.928E-05	-1.679E-02	3.025E+00
218	39.29	90	5.59	1.928E-05	-1.679E-02	3.025E+00
219	41.44	90	8.39	1.928E-05	-1.679E-02	3.025E+00
220	45.57	82.41	11.19	1.928E-05	-1.679E-02	3.025E+00
221	59.52	80	14.3	1.928E-05	-1.679E-02	3.025E+00
222	66.99	90	16.03	1.928E-05	-1.679E-02	3.025E+00
223	80.22	90	17.3	1.928E-05	-1.679E-02	3.025E+00
224	86.41	93.88	19.72	1.928E-05	-1.679E-02	3.025E+00
225	86.53	50.94	23.18	1.928E-05	-1.679E-02	3.025E+00
226	84.46	17.02	25.27	1.928E-05	-1.679E-02	3.025E+00
227	88.54	28.6	26.91	1.928E-05	-1.679E-02	3.025E+00
228	89.29	39.83	28.89	1.928E-05	-1.679E-02	3.025E+00
229	89.29	30	29.43	1.928E-05	-1.679E-02	3.025E+00
230	89.29	26.69	29.5	1.928E-05	-1.679E-02	3.025E+00
231	90.16	20	30.49	1.928E-05	-1.679E-02	3.025E+00
232	89.92	20	32.02	1.928E-05	-1.679E-02	3.025E+00
233	89.29	36.06	32.91	1.928E-05	-1.679E-02	3.025E+00
234	85.86	40	32.55	1.928E-05	-1.679E-02	3.025E+00
235	85.51	30	32.26	1.928E-05	-1.679E-02	3.025E+00

236	84.42	32.75	32.65	1.928E-05	-1.679E-02	3.025E+00
237	86.48	35.68	33.5	1.928E-05	-1.679E-02	3.025E+00
238	88.55	30	34.96	1.928E-05	-1.679E-02	3.025E+00
239	89.29	44.93	36.44	1.928E-05	-1.679E-02	3.025E+00
240	90.9	50	36.95	6.428E-06	-5.597E-03	1.008E+00
241	77.27	(°)	37.02	-6.428E-06	5.597E-03	-1.008E+00
242	56.75	(°)	36.97	-1.928E-05	1.679E-02	-3.025E+00
243	50	(°)	36.37	-1.928E-05	1.679E-02	-3.025E+00
244	41.07	(°)	35.56	-1.928E-05	1.679E-02	-3.025E+00
245	37.38	45.18	34.72	-1.928E-05	1.679E-02	-3.025E+00
246	34.21	78.47	33.84	-1.928E-05	1.679E-02	-3.025E+00
247	32.13	80	33.4	-1.928E-05	1.679E-02	-3.025E+00
248	27.71	80	32.93	-1.928E-05	1.679E-02	-3.025E+00
249	22.64	80	31.98	-1.928E-05	1.679E-02	-3.025E+00
250	20.58	60.97	30.98	-1.928E-05	1.679E-02	-3.025E+00
251	16.25	27.34	29.91	-1.928E-05	1.679E-02	-3.025E+00
252	11.46	43.71	28.73	-1.928E-05	1.679E-02	-3.025E+00
253	9.02	68.95	27.34	-1.928E-05	1.679E-02	-3.025E+00
254	3.38	68.95	25.85	-1.928E-05	1.679E-02	-3.025E+00
255	1.32	44.28	24.49	-1.928E-05	1.679E-02	-3.025E+00
256	0	0	23.19	-1.928E-05	1.679E-02	-3.025E+00
257	0	0	21.87	-1.928E-05	1.679E-02	-3.025E+00
258	0	0	17.39	-1.928E-05	1.679E-02	-3.025E+00
259	0	0	12.92	-1.928E-05	1.679E-02	-3.025E+00
260	0	0	8.45	-1.928E-05	1.679E-02	-3.025E+00
261	0	0	3.97	-1.928E-05	1.679E-02	-3.025E+00
262	0	0	0	-1.928E-05	1.679E-02	-3.025E+00
263	0	24.97	0	-1.928E-05	1.679E-02	-3.025E+00
264	0	17.16	0	-1.928E-05	1.679E-02	-3.025E+00
265	0	6.2	0	-6.926E-06	5.240E-03	8.504E-01
266	0	10	0	5.431E-06	-6.313E-03	4.726E+00
267	0	10	0	1.779E-05	-1.787E-02	8.601E+00
268	0	0	0	1.779E-05	-1.787E-02	8.601E+00
320	0	0	0	1.779E-05	-1.787E-02	8.601E+00
321	0	15.55	0	1.779E-05	-1.787E-02	8.601E+00
322	0	20	0	1.779E-05	-1.787E-02	8.601E+00
323	21.59	19.08	1.2	1.779E-05	-1.787E-02	8.601E+00
324	20.54	10	2.18	1.779E-05	-1.787E-02	8.601E+00
325	10.32	1.86	2.88	1.779E-05	-1.787E-02	8.601E+00
326	6.13	(°)	3	1.779E-05	-1.787E-02	8.601E+00
327	5.36	(°)	2.28	1.779E-05	-1.787E-02	8.601E+00
328	0.64	(°)	0	1.779E-05	-1.787E-02	8.601E+00
329	0	0	0	1.779E-05	-1.787E-02	8.601E+00
374	0	0	0	1.779E-05	-1.787E-02	8.601E+00
375	0	0	0	2.077E-05	-1.947E-02	7.751E+00
376	0	0	0	2.376E-05	-2.108E-02	6.900E+00
377	0	29.59	0	2.674E-05	-2.269E-02	6.050E+00
378	-1.34	87.46	0	2.674E-05	-2.269E-02	6.050E+00
379	7.93	100	1.15	2.674E-05	-2.269E-02	6.050E+00
380	41.11	100	3.82	2.674E-05	-2.269E-02	6.050E+00
381	68.65	100	6.11	2.674E-05	-2.269E-02	6.050E+00
382	71.43	100	10	2.674E-05	-2.269E-02	6.050E+00
383	73.34	94.64	14.52	2.674E-05	-2.269E-02	6.050E+00
384	76.24	83.07	18.09	2.674E-05	-2.269E-02	6.050E+00
385	78.3	88.51	20.64	2.674E-05	-2.269E-02	6.050E+00
386	82.14	79.83	22.36	2.674E-05	-2.269E-02	6.050E+00
387	82.14	61.66	23.7	2.674E-05	-2.269E-02	6.050E+00
388	84.45	66.77	24.8	2.674E-05	-2.269E-02	6.050E+00
389	91.86	60	25.26	2.674E-05	-2.269E-02	6.050E+00
390	94.64	72.76	25.44	2.674E-05	-2.269E-02	6.050E+00
391	97.48	8.43	25.57	2.674E-05	-2.269E-02	6.050E+00
392	99.92	(°)	25.79	2.674E-05	-2.269E-02	6.050E+00
393	73.21	(°)	25.8	2.674E-05	-2.269E-02	6.050E+00
394	70.83	(°)	24.98	2.674E-05	-2.269E-02	6.050E+00
395	63.53	(°)	23.7	2.674E-05	-2.269E-02	6.050E+00
396	61.46	(°)	22.23	2.674E-05	-2.269E-02	6.050E+00
397	69.96	49.17	20.51	2.674E-05	-2.269E-02	6.050E+00
398	73.21	70	18.44	2.674E-05	-2.269E-02	6.050E+00
399	72.01	69.46	18.19	2.674E-05	-2.269E-02	6.050E+00
400	82.9	60	21.27	2.674E-05	-2.269E-02	6.050E+00
401	87.04	60	23.53	2.674E-05	-2.269E-02	6.050E+00
402	88.35	60	23.88	2.674E-05	-2.269E-02	6.050E+00

403	89.95	60	24.03	2.674E-05	-2.269E-02	6.050E+00
404	92.57	43.17	24.17	2.228E-05	-1.969E-02	5.457E+00
405	92.86	10.04	24.3	1.781E-05	-1.670E-02	4.864E+00
406	71.98	20	24.09	1.335E-05	-1.370E-02	4.271E+00
407	74.44	20	24.97	1.335E-05	-1.370E-02	4.271E+00
408	72.38	15.29	25.32	4.449E-06	-4.566E-03	1.424E+00
409	71.43	10	24.15	-4.449E-06	4.566E-03	-1.424E+00
410	68.63	( <sup>o</sup> )	23.14	-1.335E-05	1.370E-02	-4.271E+00
411	66.17	( <sup>o</sup> )	22.38	-1.335E-05	1.370E-02	-4.271E+00
412	63.93	( <sup>o</sup> )	21.58	-1.335E-05	1.370E-02	-4.271E+00
413	63.02	( <sup>o</sup> )	20.06	-1.335E-05	1.370E-02	-4.271E+00
414	69.64	( <sup>o</sup> )	18.29	-1.335E-05	1.370E-02	-4.271E+00
415	71.69	1.45	16.16	-1.335E-05	1.370E-02	-4.271E+00
416	71.91	17.3	13.44	-1.335E-05	1.370E-02	-4.271E+00
417	69.85	11.13	11	-1.335E-05	1.370E-02	-4.271E+00
418	70.04	19.55	10.13	-7.827E-06	7.759E-03	-3.711E+00
419	75.32	24.16	11.5	-2.306E-06	1.819E-03	-3.150E+00
420	64.43	80	13.65	3.214E-06	-4.121E-03	-2.590E+00
421	70.63	74.83	15.03	3.214E-06	-4.121E-03	-2.590E+00
422	80.44	16.04	17.5	3.214E-06	-4.121E-03	-2.590E+00
423	66.11	( <sup>o</sup> )	20.79	3.214E-06	-4.121E-03	-2.590E+00
424	60.73	( <sup>o</sup> )	22.92	3.214E-06	-4.121E-03	-2.590E+00
425	61.19	( <sup>o</sup> )	23.23	3.214E-06	-4.121E-03	-2.590E+00
426	53.03	( <sup>o</sup> )	22.42	3.214E-06	-4.121E-03	-2.590E+00
427	56.73	( <sup>o</sup> )	21.51	3.214E-06	-4.121E-03	-2.590E+00
428	62.5	2.38	20.46	3.214E-06	-4.121E-03	-2.590E+00
429	65.27	17.76	19.25	3.214E-06	-4.121E-03	-2.590E+00
430	64.4	( <sup>o</sup> )	19.61	3.214E-06	-4.121E-03	-2.590E+00
431	60.06	( <sup>o</sup> )	21.94	3.214E-06	-4.121E-03	-2.590E+00
432	32.17	( <sup>o</sup> )	22.99	3.214E-06	-4.121E-03	-2.590E+00
433	18.53	( <sup>o</sup> )	22.51	3.214E-06	-4.121E-03	-2.590E+00
434	10.26	( <sup>o</sup> )	21.98	3.214E-06	-4.121E-03	-2.590E+00
435	-1.87	0	21.39	3.214E-06	-4.121E-03	-2.590E+00
436	-0.65	0	20.73	3.214E-06	-4.121E-03	-2.590E+00
437	7.65	60	20.38	3.214E-06	-4.121E-03	-2.590E+00
438	27.28	61.93	20.38	3.214E-06	-4.121E-03	-2.590E+00
439	59.91	63	20.78	3.214E-06	-4.121E-03	-2.590E+00
440	76.81	39.85	21.84	3.214E-06	-4.121E-03	-2.590E+00
441	79.76	30	23.6	3.214E-06	-4.121E-03	-2.590E+00
442	81.82	30	25.31	3.214E-06	-4.121E-03	-2.590E+00
443	87.39	10.4	26.41	3.214E-06	-4.121E-03	-2.590E+00
444	87.26	1.37	27.29	3.214E-06	-4.121E-03	-2.590E+00
445	85.71	10	27.97	3.214E-06	-4.121E-03	-2.590E+00
446	85.71	0.96	28.2	3.214E-06	-4.121E-03	-2.590E+00
447	85.71	( <sup>o</sup> )	28.31	3.214E-06	-4.121E-03	-2.590E+00
448	76.13	28.34	29.22	3.214E-06	-4.121E-03	-2.590E+00
449	78.16	30.76	29.63	3.214E-06	-4.121E-03	-2.590E+00
450	76.93	29.18	29.64	3.214E-06	-4.121E-03	-2.590E+00
451	78.57	20	30.67	3.214E-06	-4.121E-03	-2.590E+00
452	77.87	20	32.17	3.214E-06	-4.121E-03	-2.590E+00
453	76.79	20	33.1	3.214E-06	-4.121E-03	-2.590E+00
454	78.05	20	33.3	3.214E-06	-4.121E-03	-2.590E+00
455	78.57	11.32	33.15	3.214E-06	-4.121E-03	-2.590E+00
456	69.5	( <sup>o</sup> )	32.66	3.214E-06	-4.121E-03	-2.590E+00
457	64.29	( <sup>o</sup> )	31.98	3.214E-06	-4.121E-03	-2.590E+00
458	63.68	( <sup>o</sup> )	31.48	3.214E-06	-4.121E-03	-2.590E+00
459	62.5	0.04	31.39	3.214E-06	-4.121E-03	-2.590E+00
460	62.5	( <sup>o</sup> )	31.3	3.214E-06	-4.121E-03	-2.590E+00
461	66.86	( <sup>o</sup> )	32.2	3.214E-06	-4.121E-03	-2.590E+00
462	66.13	( <sup>o</sup> )	33.13	3.214E-06	-4.121E-03	-2.590E+00
463	60.48	( <sup>o</sup> )	33.13	3.214E-06	-4.121E-03	-2.590E+00
464	58.93	( <sup>o</sup> )	33.14	3.214E-06	-4.121E-03	-2.590E+00
465	57.35	( <sup>o</sup> )	33.14	3.214E-06	-4.121E-03	-2.590E+00
466	55.36	( <sup>o</sup> )	33.15	3.214E-06	-4.121E-03	-2.590E+00
467	49.95	( <sup>o</sup> )	33.16	3.214E-06	-4.121E-03	-2.590E+00
468	48.21	( <sup>o</sup> )	33.16	3.214E-06	-4.121E-03	-2.590E+00
469	59.31	( <sup>o</sup> )	33.17	2.308E-06	-3.167E-03	-2.524E+00
470	67.15	70	33.3	1.401E-06	-2.214E-03	-2.458E+00
471	76.79	54.53	33.56	4.942E-07	-1.260E-03	-2.391E+00
472	76.79	24.56	35.59	4.942E-07	-1.260E-03	-2.391E+00
473	79.29	( <sup>o</sup> )	39.04	4.942E-07	-1.260E-03	-2.391E+00
474	80.36	( <sup>o</sup> )	41.83	4.942E-07	-1.260E-03	-2.391E+00



475	94.18	(°)	43.06	4.942E-07	-1.260E-03	-2.391E+00
476	66.07	(°)	43.13	4.942E-07	-1.260E-03	-2.391E+00
477	65.48	(°)	43.21	4.942E-07	-1.260E-03	-2.391E+00
478	63.41	10	43.29	4.942E-07	-1.260E-03	-2.391E+00
479	68.27	29.38	43.37	4.942E-07	-1.260E-03	-2.391E+00
480	72.87	40	44	4.942E-07	-1.260E-03	-2.391E+00
481	69.79	30.39	45.13	4.942E-07	-1.260E-03	-2.391E+00
482	66.19	26.46	47.02	4.942E-07	-1.260E-03	-2.391E+00
483	80.36	0	49.2	4.942E-07	-1.260E-03	-2.391E+00
484	81.13	0	49.92	4.942E-07	-1.260E-03	-2.391E+00
485	82.14	(°)	50.36	4.942E-07	-1.260E-03	-2.391E+00
486	83.48	(°)	51.52	4.942E-07	-1.260E-03	-2.391E+00
487	83.93	(°)	52.11	4.942E-07	-1.260E-03	-2.391E+00
488	84.04	(°)	52.12	4.942E-07	-1.260E-03	-2.391E+00
489	79.43	(°)	52.14	4.942E-07	-1.260E-03	-2.391E+00
490	56.47	(°)	52.16	4.942E-07	-1.260E-03	-2.391E+00
491	55.36	(°)	52.18	4.942E-07	-1.260E-03	-2.391E+00
492	44.23	45.37	52.2	4.942E-07	-1.260E-03	-2.391E+00
493	46.87	86.99	52.22	4.942E-07	-1.260E-03	-2.391E+00
494	57.14	90	52.16	4.942E-07	-1.260E-03	-2.391E+00
495	58.03	90	52.53	4.942E-07	-1.260E-03	-2.391E+00
496	64.22	93.22	52.98	4.942E-07	-1.260E-03	-2.391E+00
497	70.42	95.21	53.65	4.942E-07	-1.260E-03	-2.391E+00
498	73.21	83.64	54.77	4.942E-07	-1.260E-03	-2.391E+00
499	77.46	80	55.14	4.942E-07	-1.260E-03	-2.391E+00
500	83.67	80	54.57	4.942E-07	-1.260E-03	-2.391E+00
501	84.71	80	53.63	4.942E-07	-1.260E-03	-2.391E+00
502	92.5	80	52.7	4.942E-07	-1.260E-03	-2.391E+00
503	90.38	41.89	52.03	4.942E-07	-1.260E-03	-2.391E+00
504	85.25	24.85	51.66	4.942E-07	-1.260E-03	-2.391E+00
505	87.5	50	51.42	4.942E-07	-1.260E-03	-2.391E+00
506	89.1	50	51.28	4.942E-07	-1.260E-03	-2.391E+00
507	94.83	46.82	51.13	4.942E-07	-1.260E-03	-2.391E+00
508	98.96	(°)	51.53	4.942E-07	-1.260E-03	-2.391E+00
509	87.99	(°)	52.04	1.647E-07	-4.200E-04	-7.972E-01
510	63.35	(°)	51.32	-1.647E-07	4.200E-04	7.972E-01
511	60.06	(°)	49.2	-4.942E-07	1.260E-03	2.391E+00
512	54.43	(°)	46.43	-4.942E-07	1.260E-03	2.391E+00
513	42.88	(°)	43.58	-4.942E-07	1.260E-03	2.391E+00
514	46.71	(°)	40.65	-4.942E-07	1.260E-03	2.391E+00
515	48.21	(°)	37.62	-4.942E-07	1.260E-03	2.391E+00
516	58.28	(°)	34.62	-4.942E-07	1.260E-03	2.391E+00
517	69.64	(°)	31.62	-4.942E-07	1.260E-03	2.391E+00
518	51.44	(°)	28.44	-4.942E-07	1.260E-03	2.391E+00
519	38.02	(°)	25.01	-4.942E-07	1.260E-03	2.391E+00
520	34.65	(°)	21.38	-4.942E-07	1.260E-03	2.391E+00
521	19.97	(°)	17.39	-4.942E-07	1.260E-03	2.391E+00
522	3.14	(°)	12.76	-4.942E-07	1.260E-03	2.391E+00
523	0	0	6.14	-4.942E-07	1.260E-03	2.391E+00
524	-1.3	36.39	0	-4.942E-07	1.260E-03	2.391E+00
525	-0.21	5.75	0	-4.942E-07	1.260E-03	2.391E+00
526	0	0	0	-4.942E-07	1.260E-03	2.391E+00
527	0	0	0	-4.942E-07	1.260E-03	2.391E+00
528	0	0	0	-4.942E-07	1.260E-03	2.391E+00
529	0	0	0	-4.942E-07	1.260E-03	2.391E+00
530	0	0	0	7.439E-06	-5.768E-03	1.455E+00
531	0	0	0	1.537E-05	-1.280E-02	5.195E-01
532	0	0	0	2.331E-05	-1.982E-02	-4.165E-01
543	0	0	0	2.331E-05	-1.982E-02	-4.165E-01
544	0	(°)	0	2.331E-05	-1.982E-02	-4.165E-01
545	0	0	0	2.331E-05	-1.982E-02	-4.165E-01
546	-0.67	0	0	2.331E-05	-1.982E-02	-4.165E-01
547	-0.5	0	0	2.331E-05	-1.982E-02	-4.165E-01
548	3.57	(°)	0	2.331E-05	-1.982E-02	-4.165E-01
549	0.61	(°)	0	2.331E-05	-1.982E-02	-4.165E-01
550	0	0	0	2.331E-05	-1.982E-02	-4.165E-01
551	0	0	0	2.331E-05	-1.982E-02	-4.165E-01
552	0	2.6	0	2.331E-05	-1.982E-02	-4.165E-01
553	0	20	0	2.331E-05	-1.982E-02	-4.165E-01
554	0	20	0	2.331E-05	-1.982E-02	-4.165E-01
555	0	7.96	0	2.331E-05	-1.982E-02	-4.165E-01
556	0	0	0	2.331E-05	-1.982E-02	-4.165E-01

557	0	0	0	2.331E-05	-1.982E-02	-4.165E-01
558	0	78.53	0	2.331E-05	-1.982E-02	-4.165E-01
559	1.65	60	0	2.331E-05	-1.982E-02	-4.165E-01
560	9.91	63.88	2.8	2.331E-05	-1.982E-02	-4.165E-01
561	14.29	70	6.02	2.331E-05	-1.982E-02	-4.165E-01
562	26.83	70	8.57	2.331E-05	-1.982E-02	-4.165E-01
563	38.29	70	11.07	2.331E-05	-1.982E-02	-4.165E-01
564	50.09	70	13.68	2.331E-05	-1.982E-02	-4.165E-01
565	56.6	66.52	16.52	2.331E-05	-1.982E-02	-4.165E-01
566	63.09	59.94	19.38	2.331E-05	-1.982E-02	-4.165E-01
567	65.16	80	21.91	2.331E-05	-1.982E-02	-4.165E-01
568	69.53	86.46	24.34	2.331E-05	-1.982E-02	-4.165E-01
569	78.6	90	27.02	2.331E-05	-1.982E-02	-4.165E-01
570	80.36	90	29.41	2.331E-05	-1.982E-02	-4.165E-01
571	82.35	100	31.57	2.331E-05	-1.982E-02	-4.165E-01
572	83.93	100	33.52	2.331E-05	-1.982E-02	-4.165E-01
573	84.7	100	35.75	2.331E-05	-1.982E-02	-4.165E-01
574	85.71	100	38.34	2.331E-05	-1.982E-02	-4.165E-01
575	87.04	100	40.83	2.331E-05	-1.982E-02	-4.165E-01
576	97.18	100	43.37	2.331E-05	-1.982E-02	-4.165E-01
577	98.21	83.92	44.9	2.331E-05	-1.982E-02	-4.165E-01
578	93.54	(°)	45.32	7.769E-06	-6.608E-03	-1.388E-01
579	78.13	(°)	45.25	-7.769E-06	6.608E-03	1.388E-01
580	80.36	0	44.24	-2.331E-05	1.982E-02	4.165E-01
581	81.59	(°)	42.61	-2.331E-05	1.982E-02	4.165E-01
582	73.07	(°)	40.93	-2.331E-05	1.982E-02	4.165E-01
583	58.92	(°)	39.03	-2.331E-05	1.982E-02	4.165E-01
584	56.86	(°)	36.96	-2.331E-05	1.982E-02	4.165E-01
585	54.22	(°)	34.84	-2.331E-05	1.982E-02	4.165E-01
586	50.94	(°)	32.66	-2.331E-05	1.982E-02	4.165E-01
587	47.74	(°)	30.4	-2.331E-05	1.982E-02	4.165E-01
588	45.02	(°)	28.04	-2.331E-05	1.982E-02	4.165E-01
589	39.56	(°)	25.57	-2.331E-05	1.982E-02	4.165E-01
590	33.55	37.91	22.94	-2.331E-05	1.982E-02	4.165E-01
591	29.89	20	20.11	-2.331E-05	1.982E-02	4.165E-01
592	27.82	20	18.17	-2.331E-05	1.982E-02	4.165E-01
593	25.76	20	17.2	-2.331E-05	1.982E-02	4.165E-01
594	19.76	20	16.06	-2.331E-05	1.982E-02	4.165E-01
595	8.31	(°)	14.93	-2.331E-05	1.982E-02	4.165E-01
596	0	0	13.78	-2.331E-05	1.982E-02	4.165E-01
597	0	0	10.72	-2.331E-05	1.982E-02	4.165E-01
598	0	0	6.24	-2.331E-05	1.982E-02	4.165E-01
599	0	0	1.77	-2.331E-05	1.982E-02	4.165E-01
600	0	0	0	-2.331E-05	1.982E-02	4.165E-01
605	0	0	0	-2.331E-05	1.982E-02	4.165E-01
606	2.25	6.3	0	-2.331E-05	1.982E-02	4.165E-01
607	9.2	17.87	0	-1.029E-05	8.762E-03	1.296E+00
608	12.4	20	0.75	2.727E-06	-2.302E-03	2.176E+00
609	18.04	20	1.9	1.574E-05	-1.337E-02	3.055E+00
610	21.49	22.59	3.81	1.574E-05	-1.337E-02	3.055E+00
611	29.76	17.5	5.91	1.574E-05	-1.337E-02	3.055E+00
612	35.98	(°)	7.92	1.574E-05	-1.337E-02	3.055E+00
613	42.72	(°)	9.86	1.574E-05	-1.337E-02	3.055E+00
614	58.93	7.78	9.37	1.574E-05	-1.337E-02	3.055E+00
615	60.71	10.93	5.32	1.574E-05	-1.337E-02	3.055E+00
616	60.35	32.04	1.45	1.574E-05	-1.337E-02	3.055E+00
617	58.93	40	4.28	1.574E-05	-1.337E-02	3.055E+00
618	59.86	40	6.78	1.574E-05	-1.337E-02	3.055E+00
619	60.71	40	9.12	1.574E-05	-1.337E-02	3.055E+00
620	60.71	48.33	11.69	1.574E-05	-1.337E-02	3.055E+00
621	67.79	99.53	14.17	1.574E-05	-1.337E-02	3.055E+00
622	69.64	100	16.35	1.574E-05	-1.337E-02	3.055E+00
623	69.64	100	19.18	1.574E-05	-1.337E-02	3.055E+00
624	68.81	100	22.35	1.574E-05	-1.337E-02	3.055E+00
625	67.86	100	25.17	1.574E-05	-1.337E-02	3.055E+00
626	67.86	100	27.6	1.574E-05	-1.337E-02	3.055E+00
627	67.86	100	29.72	1.574E-05	-1.337E-02	3.055E+00
628	67.53	100	31.71	1.574E-05	-1.337E-02	3.055E+00
629	65.18	97.5	33.6	1.574E-05	-1.337E-02	3.055E+00
630	68.58	90	35.39	1.574E-05	-1.337E-02	3.055E+00
631	71.66	90	37.08	1.574E-05	-1.337E-02	3.055E+00
632	74.5	90	38.83	1.574E-05	-1.337E-02	3.055E+00

633	75	98.79	40.28	1.574E-05	-1.337E-02	3.055E+00
634	75	100	41.29	1.574E-05	-1.337E-02	3.055E+00
635	74.65	100	42.31	1.574E-05	-1.337E-02	3.055E+00
636	73.21	100	42.9	1.574E-05	-1.337E-02	3.055E+00
637	74.13	94.91	42.94	1.574E-05	-1.337E-02	3.055E+00
638	77.38	90	42.83	1.574E-05	-1.337E-02	3.055E+00
639	80.04	90	42.74	1.574E-05	-1.337E-02	3.055E+00
640	80.36	99.81	42.65	1.574E-05	-1.337E-02	3.055E+00
641	79.87	100	42.56	1.574E-05	-1.337E-02	3.055E+00
642	76.79	100	42.88	1.574E-05	-1.337E-02	3.055E+00
643	76.79	95.47	43.29	1.574E-05	-1.337E-02	3.055E+00
644	77.88	90	43.3	1.574E-05	-1.337E-02	3.055E+00
645	78.57	90	43.37	1.574E-05	-1.337E-02	3.055E+00
646	78.57	80.74	43.79	1.574E-05	-1.337E-02	3.055E+00
647	78.57	79.17	44.07	1.574E-05	-1.337E-02	3.055E+00
648	78.57	77.21	44.01	1.574E-05	-1.337E-02	3.055E+00
649	78.57	100	44.41	1.046E-05	-8.994E-03	2.433E+00
650	78.57	94.45	44.85	5.183E-06	-4.623E-03	1.811E+00
651	78.57	90	44.83	-9.733E-08	-2.513E-04	1.190E+00
652	78.57	90	44.78	-9.733E-08	-2.513E-04	1.190E+00
653	80.36	90	45	-9.733E-08	-2.513E-04	1.190E+00
654	80.03	90	45.8	-9.733E-08	-2.513E-04	1.190E+00
655	79.18	90	46.46	-9.733E-08	-2.513E-04	1.190E+00
656	80.36	90	46.54	-9.733E-08	-2.513E-04	1.190E+00
657	80.36	90	46.12	-9.733E-08	-2.513E-04	1.190E+00
658	81.81	81.86	45.94	-9.733E-08	-2.513E-04	1.190E+00
659	82.14	80	45.81	-9.733E-08	-2.513E-04	1.190E+00
660	80.36	81.29	45.45	-9.733E-08	-2.513E-04	1.190E+00
661	79.85	92.86	45.81	-9.733E-08	-2.513E-04	1.190E+00
662	77.78	100	46.26	-9.733E-08	-2.513E-04	1.190E+00
663	76.79	100	46.32	-9.733E-08	-2.513E-04	1.190E+00
664	76.79	100	46.28	-9.733E-08	-2.513E-04	1.190E+00
665	80.05	100	46.46	-9.733E-08	-2.513E-04	1.190E+00
666	80.36	99.27	46.92	-9.733E-08	-2.513E-04	1.190E+00
667	80.77	90	47.16	-9.733E-08	-2.513E-04	1.190E+00
668	82.84	90	47.58	-9.733E-08	-2.513E-04	1.190E+00
669	84.9	90	48.04	-9.733E-08	-2.513E-04	1.190E+00
670	89.48	82.97	48.05	-9.733E-08	-2.513E-04	1.190E+00
671	91.07	80	48.02	-9.733E-08	-2.513E-04	1.190E+00
672	91.07	70.18	48	-9.733E-08	-2.513E-04	1.190E+00
673	91.07	80	47.97	-9.733E-08	-2.513E-04	1.190E+00
674	86.91	50.07	47.95	-9.733E-08	-2.513E-04	1.190E+00
675	77.7	(°)	47.95	-9.733E-08	-2.513E-04	1.190E+00
676	76.79	(°)	48.86	-9.733E-08	-2.513E-04	1.190E+00
677	65.29	22.19	49.92	-9.733E-08	-2.513E-04	1.190E+00
678	67.65	39.62	50.26	-9.733E-08	-2.513E-04	1.190E+00
679	67.64	48.8	50.18	-9.733E-08	-2.513E-04	1.190E+00
680	67.06	37.23	49.91	-9.733E-08	-2.513E-04	1.190E+00
681	69.64	34.34	49.9	-9.733E-08	-2.513E-04	1.190E+00
682	71.76	40	49.88	-9.733E-08	-2.513E-04	1.190E+00
683	69.21	47.49	49.87	-9.733E-08	-2.513E-04	1.190E+00
684	72.71	50	49.86	-9.733E-08	-2.513E-04	1.190E+00
685	73.33	39.36	49.85	-9.733E-08	-2.513E-04	1.190E+00
686	75	27.79	49.83	-9.733E-08	-2.513E-04	1.190E+00
687	75	16.21	49.82	-9.733E-08	-2.513E-04	1.190E+00
688	75	15.36	49.67	-9.733E-08	-2.513E-04	1.190E+00
689	76.24	26.93	49.6	-9.733E-08	-2.513E-04	1.190E+00
690	76.79	30	50.23	-9.733E-08	-2.513E-04	1.190E+00
691	76.79	30.08	50.78	-9.733E-08	-2.513E-04	1.190E+00
692	76.49	40	50.77	-9.733E-08	-2.513E-04	1.190E+00
693	75.58	40	50.76	-9.733E-08	-2.513E-04	1.190E+00
694	76.79	35.2	50.64	-9.733E-08	-2.513E-04	1.190E+00
695	77.93	30	50.14	-9.733E-08	-2.513E-04	1.190E+00
696	78.57	22.05	49.74	-9.733E-08	-2.513E-04	1.190E+00
697	76.87	(°)	50.07	-9.733E-08	-2.513E-04	1.190E+00
698	74.8	(°)	50.56	-9.733E-08	-2.513E-04	1.190E+00
699	72.74	(°)	50.73	-2.744E-06	1.973E-03	3.071E-01
700	72.95	(°)	50.76	-5.391E-06	4.198E-03	-5.755E-01
701	76.04	(°)	50.79	-8.038E-06	6.423E-03	-1.458E+00
702	75.46	(°)	50.82	-8.038E-06	6.423E-03	-1.458E+00
703	73.4	(°)	50.85	-8.038E-06	6.423E-03	-1.458E+00
704	71.33	(°)	50.88	-8.038E-06	6.423E-03	-1.458E+00

705	69.27	(°)	50.91	-8.038E-06	6.423E-03	-1.458E+00
706	67.86	6.31	50.94	-8.038E-06	6.423E-03	-1.458E+00
707	70.68	0	50.98	-8.038E-06	6.423E-03	-1.458E+00
708	67.11	27.36	51	-8.038E-06	6.423E-03	-1.458E+00
709	64.29	40	51.03	-8.038E-06	6.423E-03	-1.458E+00
710	64.29	40	51.04	-8.038E-06	6.423E-03	-1.458E+00
711	66.07	38.44	51.05	-8.038E-06	6.423E-03	-1.458E+00
712	66.07	30	51.19	-8.038E-06	6.423E-03	-1.458E+00
713	66.07	30	51.69	-8.038E-06	6.423E-03	-1.458E+00
714	66.07	36.28	52.35	-8.038E-06	6.423E-03	-1.458E+00
715	64.67	47.86	52.85	-8.038E-06	6.423E-03	-1.458E+00
716	60.92	59.43	53.06	-8.038E-06	6.423E-03	-1.458E+00
717	65.89	50	53.07	-8.038E-06	6.423E-03	-1.458E+00
718	64.75	50	53.06	-8.038E-06	6.423E-03	-1.458E+00
719	66.07	45.85	53.06	-8.038E-06	6.423E-03	-1.458E+00
720	65.04	57.18	53.05	-8.038E-06	6.423E-03	-1.458E+00
721	68.2	62.7	53.05	-8.038E-06	6.423E-03	-1.458E+00
722	72.81	60	53.05	-8.038E-06	6.423E-03	-1.458E+00
723	71.59	60	53.04	-8.038E-06	6.423E-03	-1.458E+00
724	74.64	60	53.03	-6.308E-06	4.994E-03	-7.637E-01
725	74.5	56.4	53.02	-4.577E-06	3.565E-03	-6.931E-02
726	76.79	50	53.24	-2.847E-06	2.136E-03	6.251E-01
727	77.99	50	53.73	-2.847E-06	2.136E-03	6.251E-01
728	77.09	50	53.98	-2.847E-06	2.136E-03	6.251E-01
729	76.79	40.11	53.98	-2.847E-06	2.136E-03	6.251E-01
730	78.83	61.47	53.98	-2.847E-06	2.136E-03	6.251E-01
731	79.27	63.92	53.98	-2.847E-06	2.136E-03	6.251E-01
732	77.61	50	53.97	-2.847E-06	2.136E-03	6.251E-01
733	77.46	50	53.95	-2.847E-06	2.136E-03	6.251E-01
734	78.17	42.24	53.95	-2.847E-06	2.136E-03	6.251E-01
735	78.57	49.34	53.94	-2.847E-06	2.136E-03	6.251E-01
736	76.79	50.91	53.94	-2.847E-06	2.136E-03	6.251E-01
737	76.79	67.45	53.94	-2.847E-06	2.136E-03	6.251E-01
738	76.79	81.88	54.15	-2.847E-06	2.136E-03	6.251E-01
739	77.79	70	54.65	-2.847E-06	2.136E-03	6.251E-01
740	79.86	77.21	54.92	-2.847E-06	2.136E-03	6.251E-01
741	81.93	88.78	54.9	-2.847E-06	2.136E-03	6.251E-01
742	80.42	89.65	54.89	-2.847E-06	2.136E-03	6.251E-01
743	82.14	80	54.97	-2.847E-06	2.136E-03	6.251E-01
744	82.77	80	55.44	-2.847E-06	2.136E-03	6.251E-01
745	83.93	80	55.82	-2.847E-06	2.136E-03	6.251E-01
746	83.93	80	55.8	-2.847E-06	2.136E-03	6.251E-01
747	83.93	80	55.79	-2.847E-06	2.136E-03	6.251E-01
748	83.93	80	55.78	-2.847E-06	2.136E-03	6.251E-01
749	83.93	81.37	55.76	-5.174E-06	4.059E-03	-2.026E-01
750	84.46	87.05	55.75	-7.501E-06	5.983E-03	-1.030E+00
751	85.71	57.4	55.74	-9.827E-06	7.906E-03	-1.858E+00
752	85.71	42.19	55.42	-9.827E-06	7.906E-03	-1.858E+00
753	85.71	42.33	54.91	-9.827E-06	7.906E-03	-1.858E+00
754	85.71	40	55.19	-9.827E-06	7.906E-03	-1.858E+00
755	85.71	38.37	55.64	-9.827E-06	7.906E-03	-1.858E+00
756	85.71	12.83	55.31	-9.827E-06	7.906E-03	-1.858E+00
757	85.71	(°)	55.36	-9.827E-06	7.906E-03	-1.858E+00
758	85.71	(°)	55.75	-9.827E-06	7.906E-03	-1.858E+00
759	85.71	(°)	55.78	-9.827E-06	7.906E-03	-1.858E+00
760	87.27	7.37	55.81	-9.827E-06	7.906E-03	-1.858E+00
761	89.33	19.74	55.85	-9.827E-06	7.906E-03	-1.858E+00
762	91.07	11.83	55.86	-9.827E-06	7.906E-03	-1.858E+00
763	91.07	26.81	55.84	-9.827E-06	7.906E-03	-1.858E+00
764	91.96	49.96	55.81	-9.827E-06	7.906E-03	-1.858E+00
765	92.86	60	55.78	-9.827E-06	7.906E-03	-1.858E+00
766	91.4	60	55.74	-9.827E-06	7.906E-03	-1.858E+00
767	92.8	60	56.19	-9.827E-06	7.906E-03	-1.858E+00
768	92.86	40	57.13	-9.827E-06	7.906E-03	-1.858E+00
769	92.86	25.75	57.59	-9.827E-06	7.906E-03	-1.858E+00
770	92.07	(°)	57.55	-9.827E-06	7.906E-03	-1.858E+00
771	90	(°)	57.52	-9.827E-06	7.906E-03	-1.858E+00
772	89.29	(°)	57.53	-9.827E-06	7.906E-03	-1.858E+00
773	90.92	44.88	57.58	-9.827E-06	7.906E-03	-1.858E+00
774	91.07	36.4	57.63	-1.014E-05	8.189E-03	-1.873E+00
775	91.07	(°)	57.64	-1.045E-05	8.472E-03	-1.887E+00
776	91.07	(°)	58.11	-1.077E-05	8.756E-03	-1.902E+00

777	90.1	(°)	58.52	-1.077E-05	8.756E-03	-1.902E+00
778	90.54	(°)	58.38	-1.077E-05	8.756E-03	-1.902E+00
779	89.54	(°)	58.24	-1.077E-05	8.756E-03	-1.902E+00
780	87.47	(°)	58.1	-1.077E-05	8.756E-03	-1.902E+00
781	85.71	(°)	57.96	-1.077E-05	8.756E-03	-1.902E+00
782	85.71	10	57.81	-1.077E-05	8.756E-03	-1.902E+00
783	85.71	0.23	57.67	-1.077E-05	8.756E-03	-1.902E+00
784	85.71	(°)	57.66	-1.077E-05	8.756E-03	-1.902E+00
785	85.71	(°)	57.89	-1.077E-05	8.756E-03	-1.902E+00
786	84	(°)	58.03	-1.077E-05	8.756E-03	-1.902E+00
787	69.64	(°)	57.99	-1.077E-05	8.756E-03	-1.902E+00
788	69.15	(°)	57.96	-1.077E-05	8.756E-03	-1.902E+00
789	63.99	28.96	57.93	-1.077E-05	8.756E-03	-1.902E+00
790	59.98	80	57.89	-1.077E-05	8.756E-03	-1.902E+00
791	59.38	87.48	57.85	-1.077E-05	8.756E-03	-1.902E+00
792	63.78	90	57.8	-1.077E-05	8.756E-03	-1.902E+00
793	66.19	90	57.72	-1.077E-05	8.756E-03	-1.902E+00
794	67.46	92.2	57.65	-1.077E-05	8.756E-03	-1.902E+00
795	66.74	100	57.57	-1.077E-05	8.756E-03	-1.902E+00
796	68.81	94.65	57.5	-1.077E-05	8.756E-03	-1.902E+00
797	70.88	83.08	57.8	-1.077E-05	8.756E-03	-1.902E+00
798	71.43	71.51	58.72	-1.077E-05	8.756E-03	-1.902E+00
799	71.44	69.93	59.25	-8.819E-06	7.137E-03	-1.079E+00
800	73.51	58.36	59.19	-6.873E-06	5.518E-03	-2.559E-01
801	75	50	59.16	-4.927E-06	3.899E-03	5.670E-01
802	75	59.58	59.15	-4.927E-06	3.899E-03	5.670E-01
803	75	76.36	59.15	-4.927E-06	3.899E-03	5.670E-01
804	75	80	59.14	-4.927E-06	3.899E-03	5.670E-01
805	75	70.49	59.14	-4.927E-06	3.899E-03	5.670E-01
806	73.21	80	59.62	-4.927E-06	3.899E-03	5.670E-01
807	72.74	82.66	59.93	-4.927E-06	3.899E-03	5.670E-01
808	71.43	90	59.42	-4.927E-06	3.899E-03	5.670E-01
809	69.36	90	59.07	-4.927E-06	3.899E-03	5.670E-01
810	66.54	75.24	59.05	-4.927E-06	3.899E-03	5.670E-01
811	69.27	78.96	59.03	-4.927E-06	3.899E-03	5.670E-01
812	73.12	80	59.02	-4.927E-06	3.899E-03	5.670E-01
813	71.8	80	59	-4.927E-06	3.899E-03	5.670E-01
814	73.21	83.68	58.99	-4.927E-06	3.899E-03	5.670E-01
815	74.15	79.5	58.97	-4.927E-06	3.899E-03	5.670E-01
816	75	70	58.96	-4.927E-06	3.899E-03	5.670E-01
817	75	61.6	58.95	-4.927E-06	3.899E-03	5.670E-01
818	75	50.03	58.94	-4.927E-06	3.899E-03	5.670E-01
819	76.79	60	58.93	-4.927E-06	3.899E-03	5.670E-01
820	76.79	60	58.93	-4.927E-06	3.899E-03	5.670E-01
821	76.79	69.39	59.38	-4.927E-06	3.899E-03	5.670E-01
822	79.03	73.73	59.87	-4.927E-06	3.899E-03	5.670E-01
823	78.96	70	59.91	-4.927E-06	3.899E-03	5.670E-01
824	78.57	70	59.9	-4.927E-06	3.899E-03	5.670E-01
825	83.93	70.99	59.89	-4.927E-06	3.899E-03	5.670E-01
826	84.38	80	59.88	-4.927E-06	3.899E-03	5.670E-01
827	84.97	80	59.88	-4.927E-06	3.899E-03	5.670E-01
828	84.95	80	59.87	-4.927E-06	3.899E-03	5.670E-01
829	84.41	80	59.86	-5.382E-06	4.139E-03	6.372E-01
830	83.93	80	59.85	-5.838E-06	4.378E-03	7.074E-01
831	83.93	77.89	59.84	-6.294E-06	4.618E-03	7.776E-01
832	83.93	31.99	60.25	-6.294E-06	4.618E-03	7.776E-01
833	83.93	43.57	60.73	-6.294E-06	4.618E-03	7.776E-01
834	83.93	60.28	60.8	-6.294E-06	4.618E-03	7.776E-01
835	83.93	63.29	60.81	-6.294E-06	4.618E-03	7.776E-01
836	83.93	76.57	60.81	-6.294E-06	4.618E-03	7.776E-01
837	83.93	89.86	60.81	-6.294E-06	4.618E-03	7.776E-01
838	84.19	90	60.8	-6.294E-06	4.618E-03	7.776E-01
839	87.32	87	60.79	-6.294E-06	4.618E-03	7.776E-01
840	91.88	80	60.78	-6.294E-06	4.618E-03	7.776E-01
841	92.86	73.85	60.77	-6.294E-06	4.618E-03	7.776E-01
842	92.86	62.28	60.34	-6.294E-06	4.618E-03	7.776E-01
843	92.86	69.29	59.34	-6.294E-06	4.618E-03	7.776E-01
844	94.64	70	58.76	-6.294E-06	4.618E-03	7.776E-01
845	94.64	62.7	58.76	-6.294E-06	4.618E-03	7.776E-01
846	94.64	40	58.75	-6.294E-06	4.618E-03	7.776E-01
847	93.64	40	58.75	-6.294E-06	4.618E-03	7.776E-01
848	92.86	32.85	58.57	-6.294E-06	4.618E-03	7.776E-01

849	92.86	30	58.08	-7.448E-06	5.557E-03	8.947E-02
850	92.86	0.3	57.77	-8.602E-06	6.495E-03	-5.987E-01
851	92.53	11.87	57.78	-9.756E-06	7.434E-03	-1.287E+00
852	89.84	13.12	57.8	-9.756E-06	7.434E-03	-1.287E+00
853	87.5	5.01	57.82	-9.756E-06	7.434E-03	-1.287E+00
854	86.32	10	57.84	-9.756E-06	7.434E-03	-1.287E+00
855	85.71	(°)	57.86	-9.756E-06	7.434E-03	-1.287E+00
856	85.71	(°)	57.88	-9.756E-06	7.434E-03	-1.287E+00
857	85.71	(°)	57.99	-9.756E-06	7.434E-03	-1.287E+00
858	85.21	(°)	58.19	-9.756E-06	7.434E-03	-1.287E+00
859	83.93	(°)	58.39	-9.756E-06	7.434E-03	-1.287E+00
860	83.93	(°)	58.59	-9.756E-06	7.434E-03	-1.287E+00
861	85.29	5.18	58.79	-9.756E-06	7.434E-03	-1.287E+00
862	87.35	(°)	59	-9.756E-06	7.434E-03	-1.287E+00
863	87.5	(°)	57.32	-9.756E-06	7.434E-03	-1.287E+00
864	87.5	(°)	58.15	-9.756E-06	7.434E-03	-1.287E+00
865	86.8	(°)	58.57	-9.756E-06	7.434E-03	-1.287E+00
866	85.71	6.35	58.99	-9.756E-06	7.434E-03	-1.287E+00
867	85.71	12.98	59.41	-3.252E-06	2.478E-03	-4.290E-01
868	85.71	10	59.38	3.252E-06	-2.478E-03	4.290E-01
869	85.65	10	58.9	9.756E-06	-7.434E-03	1.287E+00
870	82.14	10	58.42	9.756E-06	-7.434E-03	1.287E+00
871	82.14	10	57.46	9.756E-06	-7.434E-03	1.287E+00
872	83.02	14.89	55.85	9.756E-06	-7.434E-03	1.287E+00
873	83.93	13.54	54.38	9.756E-06	-7.434E-03	1.287E+00
874	81.06	42.12	53.19	9.756E-06	-7.434E-03	1.287E+00
875	78.64	40.4	52	9.756E-06	-7.434E-03	1.287E+00
876	76.99	30	50.8	9.756E-06	-7.434E-03	1.287E+00
877	78.57	32.75	49.59	9.756E-06	-7.434E-03	1.287E+00
878	77.8	44.32	48.39	9.756E-06	-7.434E-03	1.287E+00
879	75.73	50	47.07	9.756E-06	-7.434E-03	1.287E+00
880	73.67	50	45.71	9.756E-06	-7.434E-03	1.287E+00
881	73.21	50	44.46	9.756E-06	-7.434E-03	1.287E+00
882	73.32	40	43.27	9.756E-06	-7.434E-03	1.287E+00
883	74.22	35.64	42.1	9.756E-06	-7.434E-03	1.287E+00
884	71.43	20	40.89	9.756E-06	-7.434E-03	1.287E+00
885	75.23	51.95	39.61	9.756E-06	-7.434E-03	1.287E+00
886	77.34	66.21	38.22	9.756E-06	-7.434E-03	1.287E+00
887	75.28	60	36.96	9.756E-06	-7.434E-03	1.287E+00
888	73.21	9.96	36.06	9.756E-06	-7.434E-03	1.287E+00
889	70.85	1.61	35.23	9.756E-06	-7.434E-03	1.287E+00
890	67.29	19.56	34.02	9.756E-06	-7.434E-03	1.287E+00
891	65.22	40	32.37	9.756E-06	-7.434E-03	1.287E+00
892	63.15	8.35	30.81	9.756E-06	-7.434E-03	1.287E+00
893	61.09	(°)	29.57	9.756E-06	-7.434E-03	1.287E+00
894	42.1	8.95	28.26	9.756E-06	-7.434E-03	1.287E+00
895	31.96	10	25.94	9.756E-06	-7.434E-03	1.287E+00
896	29.42	7.38	23.56	9.756E-06	-7.434E-03	1.287E+00
897	26.04	(°)	22	9.756E-06	-7.434E-03	1.287E+00
898	14.71	(°)	19.21	9.756E-06	-7.434E-03	1.287E+00
899	1.9	(°)	16.51	9.756E-06	-7.434E-03	1.287E+00
900	0	0	12.12	9.756E-06	-7.434E-03	1.287E+00
901	0	0	7.07	9.756E-06	-7.434E-03	1.287E+00
902	0	0	2.6	9.756E-06	-7.434E-03	1.287E+00
903	0	0	0	9.756E-06	-7.434E-03	1.287E+00
904	0	0	0	1.390E-05	-1.206E-02	3.180E+00
905	0	0	0	1.805E-05	-1.669E-02	5.073E+00
906	0	0	0	2.219E-05	-2.131E-02	6.967E+00
926	0	0	0	2.219E-05	-2.131E-02	6.967E+00
927	0	3.67	0	2.219E-05	-2.131E-02	6.967E+00
928	0	47.69	0	2.219E-05	-2.131E-02	6.967E+00
929	2.78	59.41	0.33	2.219E-05	-2.131E-02	6.967E+00
930	8.12	84.54	1.67	2.219E-05	-2.131E-02	6.967E+00
931	13.95	80	2.83	2.219E-05	-2.131E-02	6.967E+00
932	29.9	80	4.02	2.219E-05	-2.131E-02	6.967E+00
933	33.87	79.29	5.64	2.219E-05	-2.131E-02	6.967E+00
934	27.86	38.25	7.39	2.219E-05	-2.131E-02	6.967E+00
935	19.63	26.67	8.83	2.219E-05	-2.131E-02	6.967E+00
936	26.79	15.1	9.15	2.219E-05	-2.131E-02	6.967E+00
937	19.85	16.47	9.7	2.219E-05	-2.131E-02	6.967E+00
938	17.51	28.05	11.37	2.219E-05	-2.131E-02	6.967E+00
939	17.86	20.38	13.04	2.219E-05	-2.131E-02	6.967E+00

940	16.37	(°)	14.74	2.219E-05	-2.131E-02	6.967E+00
941	5.85	(°)	16.41	2.219E-05	-2.131E-02	6.967E+00
942	14.13	(°)	16.85	2.219E-05	-2.131E-02	6.967E+00
943	21.1	(°)	16.09	2.219E-05	-2.131E-02	6.967E+00
944	15.63	(°)	15.23	2.219E-05	-2.131E-02	6.967E+00
945	12.67	62.52	14.22	2.219E-05	-2.131E-02	6.967E+00
946	14.86	69.36	13.02	2.219E-05	-2.131E-02	6.967E+00
947	24.79	60	12.47	2.219E-05	-2.131E-02	6.967E+00
948	33.06	63.79	13.05	2.219E-05	-2.131E-02	6.967E+00
949	42.29	75.36	14.26	2.219E-05	-2.131E-02	6.967E+00
950	48.9	80	15.09	2.219E-05	-2.131E-02	6.967E+00
951	51.52	80	15.42	2.219E-05	-2.131E-02	6.967E+00
952	48.24	79.92	15.96	2.219E-05	-2.131E-02	6.967E+00
953	51.79	65.03	16.58	2.219E-05	-2.131E-02	6.967E+00
954	52.37	43.23	17.61	2.219E-05	-2.131E-02	6.967E+00
955	56.14	50	18.33	2.219E-05	-2.131E-02	6.967E+00
956	62.35	50	18.65	2.219E-05	-2.131E-02	6.967E+00
957	64.29	42.05	19.67	2.219E-05	-2.131E-02	6.967E+00
958	67.69	40	20.47	2.219E-05	-2.131E-02	6.967E+00
959	75.2	42.2	20.57	2.219E-05	-2.131E-02	6.967E+00
960	74.88	41.28	20.68	2.219E-05	-2.131E-02	6.967E+00
961	71.92	(°)	21.56	2.219E-05	-2.131E-02	6.967E+00
962	71.88	(°)	23.19	2.219E-05	-2.131E-02	6.967E+00
963	69.64	(°)	23.64	7.398E-06	-7.105E-03	2.322E+00
964	71.24	(°)	22.75	-7.398E-06	7.105E-03	-2.322E+00
965	71.72	30.54	21.81	-2.219E-05	2.131E-02	-6.967E+00
966	76.41	42.12	20.79	-2.219E-05	2.131E-02	-6.967E+00
967	73.02	50	19.86	-2.219E-05	2.131E-02	-6.967E+00
968	69.64	50	19.18	-2.219E-05	2.131E-02	-6.967E+00
969	72.09	43.16	18.75	-2.219E-05	2.131E-02	-6.967E+00
970	82.23	73.65	18.43	-2.219E-05	2.131E-02	-6.967E+00
971	78.58	(°)	18.61	-2.219E-05	2.131E-02	-6.967E+00
972	75	(°)	19.11	-2.219E-05	2.131E-02	-6.967E+00
973	75	(°)	18.76	-2.219E-05	2.131E-02	-6.967E+00
974	72.47	(°)	17.68	-2.219E-05	2.131E-02	-6.967E+00
975	62.91	(°)	16.46	-2.219E-05	2.131E-02	-6.967E+00
976	58.93	13.57	15.06	-2.219E-05	2.131E-02	-6.967E+00
977	55.56	29.43	13.41	-2.219E-05	2.131E-02	-6.967E+00
978	57.14	20	11.91	-2.219E-05	2.131E-02	-6.967E+00
979	56.68	17.42	11.09	-2.219E-05	2.131E-02	-6.967E+00
980	53.88	10	10.9	-2.219E-05	2.131E-02	-6.967E+00
981	50.76	10	11.4	-2.219E-05	2.131E-02	-6.967E+00
982	50	(°)	12.38	-2.219E-05	2.131E-02	-6.967E+00
983	46.83	(°)	13.02	-2.219E-05	2.131E-02	-6.967E+00
984	35.63	10	12.3	-2.219E-05	2.131E-02	-6.967E+00
985	32.48	10	10.32	-2.219E-05	2.131E-02	-6.967E+00
986	26.79	10	9.7	-2.219E-05	2.131E-02	-6.967E+00
987	24.94	10	11.05	-2.219E-05	2.131E-02	-6.967E+00
988	23.21	16.74	11.88	-2.219E-05	2.131E-02	-6.967E+00
989	24.7	3.36	12.21	-2.219E-05	2.131E-02	-6.967E+00
990	25	(°)	13.29	-2.219E-05	2.131E-02	-6.967E+00
991	24.47	(°)	13.73	-2.219E-05	2.131E-02	-6.967E+00
992	18.71	(°)	12.77	-2.219E-05	2.131E-02	-6.967E+00
993	10.85	(°)	11.46	-2.219E-05	2.131E-02	-6.967E+00
994	3.4	(°)	9.84	-2.219E-05	2.131E-02	-6.967E+00
995	0	0	7.62	-2.219E-05	2.131E-02	-6.967E+00
996	0	0	3.57	-2.219E-05	2.131E-02	-6.967E+00
997	0	0.91	1.33	-2.219E-05	2.131E-02	-6.967E+00
998	0	7.52	0	-2.219E-05	2.131E-02	-6.967E+00
999	0	0	0	-2.219E-05	2.131E-02	-6.967E+00
1,000	0	0	0	-4.577E-06	5.686E-03	-3.784E+00
1,001	0	0	0	1.304E-05	-9.944E-03	-6.018E-01
1,002	0	0	0	3.066E-05	-2.557E-02	2.581E+00
1,030	0	0	0	3.066E-05	-2.557E-02	2.581E+00
1,031	1.58	(°)	0	3.066E-05	-2.557E-02	2.581E+00
1,032	1.43	(°)	0	3.066E-05	-2.557E-02	2.581E+00
1,033	0	0	0	3.066E-05	-2.557E-02	2.581E+00
1,034	0	0	0	3.066E-05	-2.557E-02	2.581E+00
1,035	1.91	9.28	0	3.066E-05	-2.557E-02	2.581E+00
1,036	2.75	0	0	3.066E-05	-2.557E-02	2.581E+00
1,037	0	0	0	3.066E-05	-2.557E-02	2.581E+00
1,048	0	0	0	3.066E-05	-2.557E-02	2.581E+00

1,049	0	5.51	0	3.066E-05	-2.557E-02	2.581E-00
1,050	0	11.34	0	3.066E-05	-2.557E-02	2.581E-00
1,051	0	0	0	3.066E-05	-2.557E-02	2.581E-00
1,059	0	0	0	3.066E-05	-2.557E-02	2.581E-00
1,060	0	0.21	0	3.066E-05	-2.557E-02	2.581E-00
1,061	0	30	0	3.066E-05	-2.557E-02	2.581E-00
1,062	0	26.78	0	3.066E-05	-2.557E-02	2.581E-00
1,063	0	20	0	3.066E-05	-2.557E-02	2.581E-00
1,064	0	20	0	3.066E-05	-2.557E-02	2.581E-00
1,065	0	4.12	0	3.066E-05	-2.557E-02	2.581E-00
1,066	0	0	0	3.066E-05	-2.557E-02	2.581E-00
1,085	0	0	0	3.066E-05	-2.557E-02	2.581E-00
1,086	0	20	0	3.066E-05	-2.557E-02	2.581E-00
1,087	0	20	0	3.066E-05	-2.557E-02	2.581E-00
1,088	0	11.73	0	3.066E-05	-2.557E-02	2.581E-00
1,089	0	0	0	3.066E-05	-2.557E-02	2.581E-00
1,115	0	0	0	3.066E-05	-2.557E-02	2.581E-00
1,116	0	73.41	0	3.066E-05	-2.557E-02	2.581E-00
1,117	0	90	0	3.066E-05	-2.557E-02	2.581E-00
1,118	27.95	81.3	2.83	3.066E-05	-2.557E-02	2.581E-00
1,119	36.74	90	5.87	3.066E-05	-2.557E-02	2.581E-00
1,120	39.29	90	8.67	3.066E-05	-2.557E-02	2.581E-00
1,121	41.44	90	11.47	3.066E-05	-2.557E-02	2.581E-00
1,122	45.57	82.41	14.26	3.066E-05	-2.557E-02	2.581E-00
1,123	59.52	80	16.91	3.066E-05	-2.557E-02	2.581E-00
1,124	66.99	90	18.33	3.066E-05	-2.557E-02	2.581E-00
1,125	80.22	90	19.35	3.066E-05	-2.557E-02	2.581E-00
1,126	86.41	93.88	21.55	3.066E-05	-2.557E-02	2.581E-00
1,127	86.53	50.94	24.84	3.066E-05	-2.557E-02	2.581E-00
1,128	84.46	17.02	26.81	3.066E-05	-2.557E-02	2.581E-00
1,129	88.54	28.6	28.36	2.397E-05	-2.025E-02	2.539E-00
1,130	89.29	39.83	30.31	1.729E-05	-1.494E-02	2.498E-00
1,131	89.29	30	30.82	1.060E-05	-9.616E-03	2.457E-00
1,132	89.29	26.69	30.86	1.060E-05	-9.616E-03	2.457E-00
1,133	90.16	20	31.82	1.060E-05	-9.616E-03	2.457E-00
1,134	89.92	20	33.33	1.060E-05	-9.616E-03	2.457E-00
1,135	89.29	36.06	34.2	1.060E-05	-9.616E-03	2.457E-00
1,136	85.86	40	33.82	1.060E-05	-9.616E-03	2.457E-00
1,137	85.51	30	33.51	1.060E-05	-9.616E-03	2.457E-00
1,138	84.42	32.75	33.87	1.060E-05	-9.616E-03	2.457E-00
1,139	86.48	35.68	34.7	1.060E-05	-9.616E-03	2.457E-00
1,140	88.55	30	36.14	1.060E-05	-9.616E-03	2.457E-00
1,141	89.29	44.93	37.6	1.060E-05	-9.616E-03	2.457E-00
1,142	90.9	50	38.09	1.060E-05	-9.616E-03	2.457E-00
1,143	77.27	( <sup>a</sup> )	38.13	3.535E-06	-3.205E-03	8.188E-01
1,144	56.75	( <sup>a</sup> )	38.05	-3.535E-06	3.205E-03	-8.188E-01
1,145	50	( <sup>a</sup> )	37.47	-1.060E-05	9.616E-03	-2.457E+00
1,146	41.07	( <sup>a</sup> )	36.69	-1.060E-05	9.616E-03	-2.457E+00
1,147	37.38	45.18	35.89	-1.060E-05	9.616E-03	-2.457E+00
1,148	34.21	78.47	35.06	-1.060E-05	9.616E-03	-2.457E+00
1,149	32.13	80	34.63	-1.060E-05	9.616E-03	-2.457E+00
1,150	27.71	80	34.13	-1.060E-05	9.616E-03	-2.457E+00
1,151	22.64	80	33.15	-1.060E-05	9.616E-03	-2.457E+00
1,152	20.58	60.97	32.12	-1.060E-05	9.616E-03	-2.457E+00
1,153	16.25	27.34	31.02	-1.060E-05	9.616E-03	-2.457E+00
1,154	11.46	43.71	29.82	-1.060E-05	9.616E-03	-2.457E+00
1,155	9.02	68.95	28.41	-1.060E-05	9.616E-03	-2.457E+00
1,156	3.38	68.95	26.91	-1.060E-05	9.616E-03	-2.457E+00
1,157	1.32	44.28	25.53	-1.060E-05	9.616E-03	-2.457E+00
1,158	0	0	24.21	-1.060E-05	9.616E-03	-2.457E+00
1,159	0	0	22.88	-1.060E-05	9.616E-03	-2.457E+00
1,160	0	0	18.4	-1.060E-05	9.616E-03	-2.457E+00
1,161	0	0	13.93	-1.060E-05	9.616E-03	-2.457E+00
1,162	0	0	9.45	-1.060E-05	9.616E-03	-2.457E+00
1,163	0	0	4.98	-1.060E-05	9.616E-03	-2.457E+00
1,164	0	0	0.5	-7.069E-06	6.411E-03	-1.638E+00
1,165	0	24.97	0	-3.535E-06	3.205E-03	-8.188E-01
1,166	0	17.16	0	0	0	0
1,167	0	6.2	0	0	0	0
1,168	0	10	0	0	0	0
1,169	0	10	0	0	0	0
1,170	0	0	0	0	0	0
1,199	0	0	0	0	0	0

<sup>a</sup>Closed throttle motoring.



(d) The following transient Low Load Cycle applies for compression-ignition engines and powertrains:

Table 3 of Appendix B—Low Load Cycle for Compression-Ignition Engines and Powertrains

Record (seconds)	Engine testing		Vehicle speed (mi/hr)	Powertrain testing		
	Normalized revolutions per minute (percent)	Normalized torque (percent)		Road grade coefficients		
				a	b	c
1	0	0	0	0	0	0
2	0	0	0	-4.441E-06	-1.101E-03	-8.083E-02
3	0	0	0	-6.661E-06	-1.651E-03	-1.213E-01
69	0	0	0	-6.661E-06	-1.651E-03	-1.213E-01
70	3	5	0	-6.661E-06	-1.651E-03	-1.213E-01
71	7	10	0	-6.661E-06	-1.651E-03	-1.213E-01
72	15.1	16.5	2.81	-6.661E-06	-1.651E-03	-1.213E-01
73	28.3	10.4	3.37	-6.661E-06	-1.651E-03	-1.213E-01
74	46	11.1	4.13	-6.661E-06	-1.651E-03	-1.213E-01
75	66.5	12.3	5.01	-6.661E-06	-1.651E-03	-1.213E-01
76	37.6	1	4.76	-6.661E-06	-1.651E-03	-1.213E-01
77	54.6	20.7	5.82	-6.661E-06	-1.651E-03	-1.213E-01
78	76.6	15.9	7.07	-6.661E-06	-1.651E-03	-1.213E-01
79	47.9	2	6.8	-6.661E-06	-1.651E-03	-1.213E-01
80	64.7	36.4	8.13	-6.661E-06	-1.651E-03	-1.213E-01
81	77.4	29.6	9.59	-6.661E-06	-1.651E-03	-1.213E-01
82	28.2	2.9	9.11	-6.661E-06	-1.651E-03	-1.213E-01
83	48.4	54.9	11.38	-6.661E-06	-1.651E-03	-1.213E-01
84	72.1	17.7	14.2	-6.661E-06	-1.651E-03	-1.213E-01
85	82.5	10.7	15.43	-6.661E-06	-1.651E-03	-1.213E-01
86	60.2	1.1	16.12	-6.661E-06	-1.651E-03	-1.213E-01
87	64.4	( <sup>a</sup> )	16.88	-6.661E-06	-1.651E-03	-1.213E-01
88	67.8	( <sup>a</sup> )	17.38	-6.661E-06	-1.651E-03	-1.213E-01
89	62.7	12	17.72	-6.661E-06	-1.651E-03	-1.213E-01
90	47	28.9	18.17	-6.661E-06	-1.651E-03	-1.213E-01
91	52.3	( <sup>a</sup> )	19.23	-6.661E-06	-1.651E-03	-1.213E-01
92	54.5	( <sup>a</sup> )	19.66	-6.661E-06	-1.651E-03	-1.213E-01
93	54.7	( <sup>a</sup> )	19.7	-6.661E-06	-1.651E-03	-1.213E-01
94	53.6	( <sup>a</sup> )	19.49	-6.661E-06	-1.651E-03	-1.213E-01
95	50.4	( <sup>a</sup> )	18.89	-6.661E-06	-1.651E-03	-1.213E-01
96	46	( <sup>a</sup> )	18.06	-6.661E-06	-1.651E-03	-1.213E-01
97	44.1	( <sup>a</sup> )	17.69	-6.661E-06	-1.651E-03	-1.213E-01
98	42.5	( <sup>a</sup> )	17.39	-6.661E-06	-1.651E-03	-1.213E-01
99	42.4	( <sup>a</sup> )	17.38	-6.661E-06	-1.651E-03	-1.213E-01
100	43	( <sup>a</sup> )	17.5	-6.661E-06	-1.651E-03	-1.213E-01
101	42.5	( <sup>a</sup> )	17.39	-6.661E-06	-1.651E-03	-1.213E-01
102	41.4	( <sup>a</sup> )	17.18	-6.661E-06	-1.651E-03	-1.213E-01
103	41.6	( <sup>a</sup> )	17.21	-6.661E-06	-1.651E-03	-1.213E-01
104	42.1	( <sup>a</sup> )	17.31	-2.220E-06	-5.503E-04	-4.042E-02
105	41.4	( <sup>a</sup> )	17.18	2.220E-06	5.503E-04	4.042E-02
106	40.6	( <sup>a</sup> )	17.06	6.661E-06	1.651E-03	1.213E-01
107	38.2	( <sup>a</sup> )	16.57	6.661E-06	1.651E-03	1.213E-01
108	35.4	0.8	16.04	6.661E-06	1.651E-03	1.213E-01
109	34	2.8	15.78	6.661E-06	1.651E-03	1.213E-01
110	33	4.5	15.59	6.661E-06	1.651E-03	1.213E-01
111	32.3	5.3	15.45	6.661E-06	1.651E-03	1.213E-01
112	31.5	0	15.31	6.661E-06	1.651E-03	1.213E-01
113	28.9	( <sup>a</sup> )	14.85	6.661E-06	1.651E-03	1.213E-01
114	28.8	( <sup>a</sup> )	14.84	6.661E-06	1.651E-03	1.213E-01
115	24.9	( <sup>a</sup> )	14.1	6.661E-06	1.651E-03	1.213E-01
116	19.1	( <sup>a</sup> )	13.06	6.661E-06	1.651E-03	1.213E-01
117	29.8	( <sup>a</sup> )	11.8	6.661E-06	1.651E-03	1.213E-01
118	20.6	( <sup>a</sup> )	10.43	6.661E-06	1.651E-03	1.213E-01
119	14.7	( <sup>a</sup> )	9.55	6.661E-06	1.651E-03	1.213E-01
120	19.7	16.8	9.1	6.661E-06	1.651E-03	1.213E-01

121	21.8	(°)	8.39	6.661E-06	1.651E-03	1.213E-01
122	15.2	(°)	7.62	6.661E-06	1.651E-03	1.213E-01
123	24.8	10.6	6.59	6.661E-06	1.651E-03	1.213E-01
124	20.5	9.5	5.05	6.661E-06	1.651E-03	1.213E-01
125	19.7	15.6	4.15	6.661E-06	1.651E-03	1.213E-01
126	8.5	(°)	3.29	6.661E-06	1.651E-03	1.213E-01
127	0	0	2.77	6.661E-06	1.651E-03	1.213E-01
128	0.5	5.4	2.69	6.661E-06	1.651E-03	1.213E-01
129	0	0	2.45	6.661E-06	1.651E-03	1.213E-01
130	0.5	5.7	2.08	6.661E-06	1.651E-03	1.213E-01
131	1.7	9.8	1.69	6.661E-06	1.651E-03	1.213E-01
132	6.7	14.6	1.64	2.220E-06	5.503E-04	4.042E-02
133	6.5	12	1.83	-2.220E-06	-5.503E-04	-4.042E-02
134	6.5	9.8	2.02	-6.661E-06	-1.651E-03	-1.213E-01
135	6.6	8.6	2.14	-6.661E-06	-1.651E-03	-1.213E-01
136	6	8.1	2.21	-6.661E-06	-1.651E-03	-1.213E-01
137	4.5	7.3	2.21	-6.661E-06	-1.651E-03	-1.213E-01
138	3.4	8.2	2.22	-6.661E-06	-1.651E-03	-1.213E-01
139	8	17	2.44	-6.661E-06	-1.651E-03	-1.213E-01
140	17.4	8	2.91	-6.661E-06	-1.651E-03	-1.213E-01
141	28.3	6.2	3.38	-6.661E-06	-1.651E-03	-1.213E-01
142	35.4	9.6	3.68	-6.661E-06	-1.651E-03	-1.213E-01
143	51	9.7	4.35	-6.661E-06	-1.651E-03	-1.213E-01
144	62	10.6	4.82	-6.661E-06	-1.651E-03	-1.213E-01
145	32.4	1	4.49	-6.661E-06	-1.651E-03	-1.213E-01
146	58.1	24.4	6.01	-6.661E-06	-1.651E-03	-1.213E-01
147	89.1	27.9	7.71	-6.661E-06	-1.651E-03	-1.213E-01
148	32.4	3	7.32	-6.661E-06	-1.651E-03	-1.213E-01
149	38.6	17.1	8.08	-6.661E-06	-1.651E-03	-1.213E-01
150	48.9	19.8	9.02	-6.661E-06	-1.651E-03	-1.213E-01
151	61.4	18.7	10.16	-6.661E-06	-1.651E-03	-1.213E-01
152	70.7	14.8	11.03	-6.661E-06	-1.651E-03	-1.213E-01
153	45.7	0.8	10.91	-6.661E-06	-1.651E-03	-1.213E-01
154	49	20.7	11.51	-6.661E-06	-1.651E-03	-1.213E-01
155	57.5	23.4	12.49	-6.661E-06	-1.651E-03	-1.213E-01
156	66.7	22.1	13.56	-6.661E-06	-1.651E-03	-1.213E-01
157	48.7	5.8	13.8	-6.661E-06	-1.651E-03	-1.213E-01
158	44.5	14.3	13.91	-6.661E-06	-1.651E-03	-1.213E-01
159	45	6.9	14	-6.661E-06	-1.651E-03	-1.213E-01
160	44.3	1.5	13.91	-6.661E-06	-1.651E-03	-1.213E-01
161	46.4	19.2	14.19	-6.661E-06	-1.651E-03	-1.213E-01
162	48.3	6.9	14.48	-2.220E-06	-5.503E-04	-4.042E-02
163	48.2	5.8	14.47	2.220E-06	5.503E-04	4.042E-02
164	47.6	5.8	14.38	6.661E-06	1.651E-03	1.213E-01
165	46.6	4	14.24	6.661E-06	1.651E-03	1.213E-01
166	45.1	3.6	14.02	6.661E-06	1.651E-03	1.213E-01
167	44	2.9	13.86	6.661E-06	1.651E-03	1.213E-01
168	42.4	3.4	13.63	6.661E-06	1.651E-03	1.213E-01
169	41.7	1	13.52	6.661E-06	1.651E-03	1.213E-01
170	37.9	(°)	12.97	6.661E-06	1.651E-03	1.213E-01
171	32.7	(°)	12.22	6.661E-06	1.651E-03	1.213E-01
172	20.8	(°)	10.49	6.661E-06	1.651E-03	1.213E-01
173	18.8	13.7	8	6.661E-06	1.651E-03	1.213E-01
174	16.3	3.5	5.87	6.661E-06	1.651E-03	1.213E-01
175	14.1	5.3	4.27	6.661E-06	1.651E-03	1.213E-01
176	6.7	1.3	2.95	6.661E-06	1.651E-03	1.213E-01
177	0.1	5.9	1.76	6.661E-06	1.651E-03	1.213E-01
178	0	0	0.96	2.220E-06	5.503E-04	4.042E-02
179	0	0	0	-2.220E-06	-5.503E-04	-4.042E-02
180	0	0	0	-6.661E-06	-1.651E-03	-1.213E-01
181	0	0	0	-6.661E-06	-1.651E-03	-1.213E-01
182	1.2	6.3	0	-6.661E-06	-1.651E-03	-1.213E-01
183	2	9.9	0.14	-6.661E-06	-1.651E-03	-1.213E-01
184	5.1	12	0.51	-6.661E-06	-1.651E-03	-1.213E-01
185	4.6	8.7	0.72	-6.661E-06	-1.651E-03	-1.213E-01
186	0	0	0.84	-6.661E-06	-1.651E-03	-1.213E-01
187	0	0	0.93	-6.661E-06	-1.651E-03	-1.213E-01
188	0	0	0.71	-6.661E-06	-1.651E-03	-1.213E-01
189	0	0	0	-6.661E-06	-1.651E-03	-1.213E-01
199	0	0	0	-6.661E-06	-1.651E-03	-1.213E-01
200	0	0	0	-7.610E-07	-4.944E-03	1.232E+00
201	0	0	0	5.139E-06	-8.238E-03	2.586E+00

202	0	0	0	1.104E-05	-1.153E-02	3.939E+00
206	0	0	0	1.104E-05	-1.153E-02	3.939E+00
207	1.1	9.2	0.02	1.104E-05	-1.153E-02	3.939E+00
208	5.9	22	0.55	1.104E-05	-1.153E-02	3.939E+00
209	6.7	24.1	1.47	1.104E-05	-1.153E-02	3.939E+00
210	7	18.6	2.39	1.104E-05	-1.153E-02	3.939E+00
211	14.8	11.2	2.79	1.104E-05	-1.153E-02	3.939E+00
212	24.9	10.8	3.23	1.104E-05	-1.153E-02	3.939E+00
213	37.7	8.2	3.78	1.104E-05	-1.153E-02	3.939E+00
214	50.4	7.7	4.33	1.104E-05	-1.153E-02	3.939E+00
215	62.3	8.3	4.84	1.104E-05	-1.153E-02	3.939E+00
216	30.7	4.7	4.37	1.104E-05	-1.153E-02	3.939E+00
217	34.2	19.4	4.69	1.104E-05	-1.153E-02	3.939E+00
218	52.4	12.2	5.72	1.104E-05	-1.153E-02	3.939E+00
219	63.4	7.7	6.35	3.680E-06	-3.844E-03	1.313E+00
220	46.8	0.5	6.78	-3.680E-06	3.844E-03	-1.313E+00
221	41.8	2.7	6.57	-1.104E-05	1.153E-02	-3.939E+00
222	38.8	3.8	6.35	-1.104E-05	1.153E-02	-3.939E+00
223	36.3	4.7	6.17	-1.104E-05	1.153E-02	-3.939E+00
224	36.1	3.5	6.16	-1.104E-05	1.153E-02	-3.939E+00
225	35.4	1.6	6.11	-1.104E-05	1.153E-02	-3.939E+00
226	34.9	(°)	6.08	-1.104E-05	1.153E-02	-3.939E+00
227	29.9	(°)	5.72	-1.104E-05	1.153E-02	-3.939E+00
228	24.6	(°)	5.34	-1.104E-05	1.153E-02	-3.939E+00
229	17.9	(°)	4.87	-1.104E-05	1.153E-02	-3.939E+00
230	17.3	16.4	4.41	-1.104E-05	1.153E-02	-3.939E+00
231	22	(°)	4.05	-1.104E-05	1.153E-02	-3.939E+00
232	14.1	(°)	3.6	-1.104E-05	1.153E-02	-3.939E+00
233	5.4	1.4	3.26	-1.104E-05	1.153E-02	-3.939E+00
234	0.1	5.8	2.63	-1.104E-05	1.153E-02	-3.939E+00
235	0	0	2.18	-1.104E-05	1.153E-02	-3.939E+00
236	0	0	1.93	-1.104E-05	1.153E-02	-3.939E+00
237	0	0	1.6	-1.104E-05	1.153E-02	-3.939E+00
238	0	0	1.23	-3.680E-06	3.844E-03	-1.313E+00
239	0	0	0	3.680E-06	-3.844E-03	1.313E+00
240	0	0	0	1.104E-05	-1.153E-02	3.939E+00
249	0	0	0	1.104E-05	-1.153E-02	3.939E+00
250	1	5.3	0.19	1.104E-05	-1.153E-02	3.939E+00
251	1.1	9.9	0.83	1.104E-05	-1.153E-02	3.939E+00
252	3.4	9.1	1.57	1.104E-05	-1.153E-02	3.939E+00
253	1.1	7.6	2.11	1.104E-05	-1.153E-02	3.939E+00
254	2.8	9.5	2.28	1.104E-05	-1.153E-02	3.939E+00
255	7.7	11.8	2.49	1.104E-05	-1.153E-02	3.939E+00
256	11.9	14.4	2.66	1.104E-05	-1.153E-02	3.939E+00
257	19.1	14.4	2.98	1.104E-05	-1.153E-02	3.939E+00
258	34.6	10.2	3.64	1.104E-05	-1.153E-02	3.939E+00
259	48	9.5	4.22	1.104E-05	-1.153E-02	3.939E+00
260	57.2	10.1	4.62	1.104E-05	-1.153E-02	3.939E+00
261	52	12.7	4.84	1.104E-05	-1.153E-02	3.939E+00
262	40.4	23.7	5.03	1.104E-05	-1.153E-02	3.939E+00
263	69.3	13.6	6.67	1.104E-05	-1.153E-02	3.939E+00
264	58.9	7.7	7.26	1.104E-05	-1.153E-02	3.939E+00
265	59.1	17.7	7.77	1.104E-05	-1.153E-02	3.939E+00
266	67.1	6.2	8.37	3.680E-06	-3.844E-03	1.313E+00
267	43.5	2.9	8.25	-3.680E-06	3.844E-03	-1.313E+00
268	35.8	(°)	7.87	-1.104E-05	1.153E-02	-3.939E+00
269	24.1	(°)	6.81	-1.104E-05	1.153E-02	-3.939E+00
270	14	12.1	5.29	-1.104E-05	1.153E-02	-3.939E+00
271	18.6	9.1	3.71	-1.104E-05	1.153E-02	-3.939E+00
272	0	0	2.81	-1.104E-05	1.153E-02	-3.939E+00
273	0	0	2.43	-1.104E-05	1.153E-02	-3.939E+00
274	0	0	1.88	-1.104E-05	1.153E-02	-3.939E+00
275	0	0	1.27	-1.104E-05	1.153E-02	-3.939E+00
276	0	0	0	-1.104E-05	1.153E-02	-3.939E+00
299	0	0	0	-1.104E-05	1.153E-02	-3.939E+00
300	0	0	0	-5.060E-06	5.253E-03	-2.462E+00
301	0	0	0	9.196E-07	-1.025E-03	-9.843E-01
302	0	0	0	6.899E-06	-7.304E-03	4.932E-01
314	0	0	0	6.899E-06	-7.304E-03	4.932E-01
315	0.9	9	0.08	6.899E-06	-7.304E-03	4.932E-01
316	7.2	32.1	0.9	6.899E-06	-7.304E-03	4.932E-01
317	8.2	21.3	2.5	6.899E-06	-7.304E-03	4.932E-01

318	19.5	20.4	2.98	6.899E-06	-7.304E-03	4.932E-01
319	35.5	11	3.68	6.899E-06	-7.304E-03	4.932E-01
320	54.3	10.6	4.49	6.899E-06	-7.304E-03	4.932E-01
321	59.1	13.7	4.93	6.899E-06	-7.304E-03	4.932E-01
322	28	5.9	4.13	6.899E-06	-7.304E-03	4.932E-01
323	35	17.6	4.75	6.899E-06	-7.304E-03	4.932E-01
324	50.2	9.8	5.61	6.899E-06	-7.304E-03	4.932E-01
325	62.3	5.7	6.29	6.899E-06	-7.304E-03	4.932E-01
326	52.2	3.7	6.99	6.899E-06	-7.304E-03	4.932E-01
327	47.5	( <sup>o</sup> )	6.98	6.899E-06	-7.304E-03	4.932E-01
328	43.5	( <sup>o</sup> )	6.7	6.899E-06	-7.304E-03	4.932E-01
329	39.8	3.7	6.42	6.899E-06	-7.304E-03	4.932E-01
330	44.2	7.2	6.73	6.899E-06	-7.304E-03	4.932E-01
331	54.1	7.2	7.43	6.899E-06	-7.304E-03	4.932E-01
332	60.4	10.3	7.88	6.899E-06	-7.304E-03	4.932E-01
333	70.3	13.2	8.51	6.899E-06	-7.304E-03	4.932E-01
334	41.7	2.3	8.39	6.899E-06	-7.304E-03	4.932E-01
335	57.1	18.5	9.77	6.899E-06	-7.304E-03	4.932E-01
336	74.6	21.3	11.37	6.899E-06	-7.304E-03	4.932E-01
337	60.4	9.2	11.8	6.899E-06	-7.304E-03	4.932E-01
338	56	33.9	12.3	6.899E-06	-7.304E-03	4.932E-01
339	72.4	35.4	14.2	6.899E-06	-7.304E-03	4.932E-01
340	86.3	23.8	15.85	6.899E-06	-7.304E-03	4.932E-01
341	37	0.5	15.94	6.899E-06	-7.304E-03	4.932E-01
342	38.1	32.8	16.49	6.899E-06	-7.304E-03	4.932E-01
343	44.6	28.9	17.72	6.899E-06	-7.304E-03	4.932E-01
344	49.2	17.2	18.61	6.899E-06	-7.304E-03	4.932E-01
345	50.2	0.1	18.82	2.300E-06	-2.435E-03	1.644E-01
346	48.5	( <sup>o</sup> )	18.52	-2.300E-06	2.435E-03	-1.644E-01
347	46.7	( <sup>o</sup> )	18.17	-6.899E-06	7.304E-03	-4.932E-01
348	43.9	( <sup>o</sup> )	17.66	-6.899E-06	7.304E-03	-4.932E-01
349	41.2	( <sup>o</sup> )	17.14	-6.899E-06	7.304E-03	-4.932E-01
350	38	( <sup>o</sup> )	16.55	-6.899E-06	7.304E-03	-4.932E-01
351	34	( <sup>o</sup> )	15.8	-6.899E-06	7.304E-03	-4.932E-01
352	28.8	( <sup>o</sup> )	14.83	-6.899E-06	7.304E-03	-4.932E-01
353	21.2	( <sup>o</sup> )	13.42	-6.899E-06	7.304E-03	-4.932E-01
354	31.1	5.3	11.61	-6.899E-06	7.304E-03	-4.932E-01
355	18.6	( <sup>o</sup> )	10.13	-6.899E-06	7.304E-03	-4.932E-01
356	13	( <sup>o</sup> )	9.29	-6.899E-06	7.304E-03	-4.932E-01
357	23.6	12.3	8.6	-6.899E-06	7.304E-03	-4.932E-01
358	14.2	( <sup>o</sup> )	7.51	-6.899E-06	7.304E-03	-4.932E-01
359	14.2	5.5	5.49	-6.899E-06	7.304E-03	-4.932E-01
360	19.1	12.4	3.82	-6.899E-06	7.304E-03	-4.932E-01
361	0	0	2.45	-6.899E-06	7.304E-03	-4.932E-01
362	0.1	5.6	1.45	-6.899E-06	7.304E-03	-4.932E-01
363	0	0	0.71	-6.899E-06	7.304E-03	-4.932E-01
364	0	0	0	-6.899E-06	7.304E-03	-4.932E-01
399	0	0	0	-6.899E-06	7.304E-03	-4.932E-01
400	0	0	0	-2.724E-06	2.689E-03	2.988E-01
401	0	0	0	1.450E-06	-1.927E-03	1.091E+00
402	0	0	0	5.625E-06	-6.542E-03	1.883E+00
421	0	0	0	5.625E-06	-6.542E-03	1.883E+00
422	0.6	9.9	0.03	5.625E-06	-6.542E-03	1.883E+00
423	5	14	0.21	5.625E-06	-6.542E-03	1.883E+00
424	5.1	12.1	0.57	5.625E-06	-6.542E-03	1.883E+00
425	1.7	7.9	0.71	5.625E-06	-6.542E-03	1.883E+00
426	0.1	5.8	0.6	5.625E-06	-6.542E-03	1.883E+00
427	0	0	0	5.625E-06	-6.542E-03	1.883E+00
435	0	0	0	5.625E-06	-6.542E-03	1.883E+00
436	4.4	15.4	0.06	5.625E-06	-6.542E-03	1.883E+00
437	6	20.4	0.92	5.625E-06	-6.542E-03	1.883E+00
438	6	14.1	1.52	5.625E-06	-6.542E-03	1.883E+00
439	6	10.3	1.84	5.625E-06	-6.542E-03	1.883E+00
440	4.4	8.7	2.03	5.625E-06	-6.542E-03	1.883E+00
441	2.5	9.1	2.09	5.625E-06	-6.542E-03	1.883E+00
442	7.5	15.1	2.24	5.625E-06	-6.542E-03	1.883E+00
443	12	13.2	2.68	5.625E-06	-6.542E-03	1.883E+00
444	24.5	12.2	3.21	5.625E-06	-6.542E-03	1.883E+00
445	45.3	9.5	4.1	5.625E-06	-6.542E-03	1.883E+00
446	68.4	11.4	5.09	5.625E-06	-6.542E-03	1.883E+00
447	45.7	1.5	5.35	5.625E-06	-6.542E-03	1.883E+00
448	72.7	23	6.84	5.625E-06	-6.542E-03	1.883E+00

449	64.8	9.8	7.54	5.625E-06	-6.542E-03	1.883E+00
450	66.2	29.8	8.25	5.625E-06	-6.542E-03	1.883E+00
451	86.5	23.4	9.88	5.625E-06	-6.542E-03	1.883E+00
452	36.8	2.3	10.12	5.625E-06	-6.542E-03	1.883E+00
453	43.3	21.8	10.84	5.625E-06	-6.542E-03	1.883E+00
454	51.4	24.5	11.78	5.625E-06	-6.542E-03	1.883E+00
455	58.2	21.2	12.58	5.625E-06	-6.542E-03	1.883E+00
456	60.8	16.9	12.9	5.625E-06	-6.542E-03	1.883E+00
457	34.8	0.7	12.15	5.625E-06	-6.542E-03	1.883E+00
458	34.4	31.3	12.41	5.625E-06	-6.542E-03	1.883E+00
459	36.8	2.8	12.8	5.625E-06	-6.542E-03	1.883E+00
460	36	(°)	12.7	5.625E-06	-6.542E-03	1.883E+00
461	35.9	(°)	12.7	5.625E-06	-6.542E-03	1.883E+00
462	31.1	(°)	11.97	5.625E-06	-6.542E-03	1.883E+00
463	25	5.7	11.05	5.625E-06	-6.542E-03	1.883E+00
464	24.2	0.4	10.94	5.625E-06	-6.542E-03	1.883E+00
465	22.1	3.9	10.64	5.625E-06	-6.542E-03	1.883E+00
466	22.4	30.1	10.65	5.625E-06	-6.542E-03	1.883E+00
467	28.8	20.2	11.59	1.875E-06	-2.181E-03	6.276E-01
468	30.6	1.6	11.89	-1.875E-06	2.181E-03	-6.276E-01
469	27.9	(°)	11.5	-5.625E-06	6.542E-03	-1.883E+00
470	21.3	(°)	10.54	-5.625E-06	6.542E-03	-1.883E+00
471	13.9	(°)	9.43	-5.625E-06	6.542E-03	-1.883E+00
472	25.3	11.7	8.58	-5.625E-06	6.542E-03	-1.883E+00
473	17.8	(°)	7.91	-5.625E-06	6.542E-03	-1.883E+00
474	12.1	1.4	7.29	-5.625E-06	6.542E-03	-1.883E+00
475	24.1	(°)	6.8	-5.625E-06	6.542E-03	-1.883E+00
476	16.4	(°)	6.09	-5.625E-06	6.542E-03	-1.883E+00
477	21.6	16.5	5.65	-5.625E-06	6.542E-03	-1.883E+00
478	26.4	(°)	5.48	-5.625E-06	6.542E-03	-1.883E+00
479	16.2	(°)	4.74	-5.625E-06	6.542E-03	-1.883E+00
480	24.6	10.5	4.03	-5.625E-06	6.542E-03	-1.883E+00
481	8.2	1.1	3.27	-5.625E-06	6.542E-03	-1.883E+00
482	0	0	2.33	-5.625E-06	6.542E-03	-1.883E+00
483	0	0	1.15	-5.625E-06	6.542E-03	-1.883E+00
484	0	0	0.43	-5.625E-06	6.542E-03	-1.883E+00
485	0	0	0	-5.625E-06	6.542E-03	-1.883E+00
499	0	0	0	-5.625E-06	6.542E-03	-1.883E+00
500	0	0	0	-1.425E-06	1.947E-03	-4.329E-01
501	0	0	0	2.774E-06	-2.648E-03	1.017E+00
502	0	0	0	6.974E-06	-7.244E-03	2.467E+00
511	0	0	0	6.974E-06	-7.244E-03	2.467E+00
512	7.5	45.3	0.58	6.974E-06	-7.244E-03	2.467E+00
513	6.5	32.7	1.79	6.974E-06	-7.244E-03	2.467E+00
514	7.6	23.8	2.49	6.974E-06	-7.244E-03	2.467E+00
515	12.7	8.8	2.71	6.974E-06	-7.244E-03	2.467E+00
516	18.8	14.4	2.96	6.974E-06	-7.244E-03	2.467E+00
517	30.4	12.7	3.47	6.974E-06	-7.244E-03	2.467E+00
518	44	10.6	4.05	6.974E-06	-7.244E-03	2.467E+00
519	53.2	8.3	4.46	6.974E-06	-7.244E-03	2.467E+00
520	57.7	10	4.65	6.974E-06	-7.244E-03	2.467E+00
521	48.5	11.5	4.82	6.974E-06	-7.244E-03	2.467E+00
522	33.7	25.7	4.67	6.974E-06	-7.244E-03	2.467E+00
523	49.9	16	5.59	6.974E-06	-7.244E-03	2.467E+00
524	68.1	20.4	6.6	6.974E-06	-7.244E-03	2.467E+00
525	50.4	5.3	6.85	6.974E-06	-7.244E-03	2.467E+00
526	51.1	21.9	7.21	6.974E-06	-7.244E-03	2.467E+00
527	65	22.8	8.2	6.974E-06	-7.244E-03	2.467E+00
528	78.1	19.5	9.02	6.974E-06	-7.244E-03	2.467E+00
529	46.8	2.9	8.85	6.974E-06	-7.244E-03	2.467E+00
530	51.1	19.3	9.24	6.974E-06	-7.244E-03	2.467E+00
531	59.7	26.7	10.01	6.974E-06	-7.244E-03	2.467E+00
532	68.8	23.9	10.86	6.974E-06	-7.244E-03	2.467E+00
533	45	0.5	10.83	6.974E-06	-7.244E-03	2.467E+00
534	46.8	44.3	11.24	6.974E-06	-7.244E-03	2.467E+00
535	55.7	25	12.3	6.974E-06	-7.244E-03	2.467E+00
536	58.9	11.6	12.68	6.974E-06	-7.244E-03	2.467E+00
537	45.1	8.5	12.61	6.974E-06	-7.244E-03	2.467E+00
538	35.7	39.3	12.6	6.974E-06	-7.244E-03	2.467E+00
539	43.2	34.4	13.7	6.974E-06	-7.244E-03	2.467E+00
540	46.2	16.8	14.18	2.325E-06	-2.415E-03	8.223E-01
541	46.7	9.6	14.25	-2.325E-06	2.415E-03	-8.223E-01

542	45.6	(°)	14.1	-6.974E-06	7.244E-03	-2.467E+00
543	42.7	(°)	13.67	-6.974E-06	7.244E-03	-2.467E+00
544	38.4	(°)	13.04	-6.974E-06	7.244E-03	-2.467E+00
545	33.4	(°)	12.3	-6.974E-06	7.244E-03	-2.467E+00
546	28	(°)	11.51	-6.974E-06	7.244E-03	-2.467E+00
547	23.9	(°)	10.9	-6.974E-06	7.244E-03	-2.467E+00
548	18.9	(°)	10.18	-6.974E-06	7.244E-03	-2.467E+00
549	12.9	8.6	8.96	-6.974E-06	7.244E-03	-2.467E+00
550	15.4	(°)	7.54	-6.974E-06	7.244E-03	-2.467E+00
551	25.2	8.4	6.62	-6.974E-06	7.244E-03	-2.467E+00
552	11.1	2.8	5.48	-6.974E-06	7.244E-03	-2.467E+00
553	15.6	6.4	3.51	-6.974E-06	7.244E-03	-2.467E+00
554	0.3	13.3	2.71	-2.325E-06	2.415E-03	-8.223E-01
555	3.8	31.8	3.01	2.325E-06	-2.415E-03	8.223E-01
556	16.6	25.5	3.73	6.974E-06	-7.244E-03	2.467E+00
557	25.4	25.7	4.22	6.974E-06	-7.244E-03	2.467E+00
558	48.8	26.5	5.52	6.974E-06	-7.244E-03	2.467E+00
559	77.9	30.8	7.14	6.974E-06	-7.244E-03	2.467E+00
560	55.5	3.1	7.32	6.974E-06	-7.244E-03	2.467E+00
561	61	36.7	7.9	6.974E-06	-7.244E-03	2.467E+00
562	78.8	26.1	9.19	6.974E-06	-7.244E-03	2.467E+00
563	65.7	26	9.75	6.974E-06	-7.244E-03	2.467E+00
564	31.5	17.9	9.49	6.974E-06	-7.244E-03	2.467E+00
565	43.2	45.2	10.82	6.974E-06	-7.244E-03	2.467E+00
566	48.7	15.9	11.49	6.974E-06	-7.244E-03	2.467E+00
567	49.3	10.9	11.57	6.974E-06	-7.244E-03	2.467E+00
568	50.1	12.6	11.66	6.974E-06	-7.244E-03	2.467E+00
569	56.6	37.8	12.39	6.974E-06	-7.244E-03	2.467E+00
570	61.9	18.7	13.03	6.974E-06	-7.244E-03	2.467E+00
571	64.6	12.8	13.17	6.974E-06	-7.244E-03	2.467E+00
572	37.2	2.8	12.85	6.974E-06	-7.244E-03	2.467E+00
573	44.1	64.1	13.82	6.974E-06	-7.244E-03	2.467E+00
574	53.1	39.7	15.16	6.974E-06	-7.244E-03	2.467E+00
575	56.8	23.5	15.73	6.974E-06	-7.244E-03	2.467E+00
576	59.2	24.4	16.07	6.974E-06	-7.244E-03	2.467E+00
577	43.3	7.9	16.09	6.974E-06	-7.244E-03	2.467E+00
578	35.4	41.4	16.01	6.974E-06	-7.244E-03	2.467E+00
579	37.7	21.3	16.47	6.974E-06	-7.244E-03	2.467E+00
580	37.9	17.9	16.49	6.974E-06	-7.244E-03	2.467E+00
581	38.4	17.3	16.59	2.325E-06	-2.415E-03	8.223E-01
582	38.8	13.3	16.67	-2.325E-06	2.415E-03	-8.223E-01
583	37.4	10.8	16.41	-6.974E-06	7.244E-03	-2.467E+00
584	36.6	11.5	16.26	-6.974E-06	7.244E-03	-2.467E+00
585	34.8	6.5	15.92	-6.974E-06	7.244E-03	-2.467E+00
586	33	(°)	15.59	-6.974E-06	7.244E-03	-2.467E+00
587	29.9	(°)	15.04	-6.974E-06	7.244E-03	-2.467E+00
588	24	(°)	13.92	-6.974E-06	7.244E-03	-2.467E+00
589	29.3	13.3	12.46	-6.974E-06	7.244E-03	-2.467E+00
590	20.2	(°)	10.38	-6.974E-06	7.244E-03	-2.467E+00
591	17	14.9	8.45	-6.974E-06	7.244E-03	-2.467E+00
592	15.4	8.8	5.03	-6.974E-06	7.244E-03	-2.467E+00
593	2.5	1.3	2.58	-6.974E-06	7.244E-03	-2.467E+00
594	0.1	5.7	1.52	-6.974E-06	7.244E-03	-2.467E+00
595	0	0	1.09	-6.974E-06	7.244E-03	-2.467E+00
596	0	0	0.71	-2.325E-06	2.415E-03	-8.223E-01
597	0	0	0	2.325E-06	-2.415E-03	8.223E-01
598	0	0	0	6.974E-06	-7.244E-03	2.467E+00
599	6.4	30.8	0.13	6.974E-06	-7.244E-03	2.467E+00
600	6.8	38.6	1.14	6.974E-06	-7.244E-03	2.467E+00
601	6.7	31.6	2.17	6.974E-06	-7.244E-03	2.467E+00
602	12.7	18.1	2.71	6.974E-06	-7.244E-03	2.467E+00
603	25.1	8.8	3.25	6.974E-06	-7.244E-03	2.467E+00
604	31.3	14	3.51	6.974E-06	-7.244E-03	2.467E+00
605	48.5	8.2	4.25	6.974E-06	-7.244E-03	2.467E+00
606	57.3	7.4	4.63	6.974E-06	-7.244E-03	2.467E+00
607	49.5	15	4.48	6.974E-06	-7.244E-03	2.467E+00
608	16.2	6.7	3.48	6.974E-06	-7.244E-03	2.467E+00
609	29.3	45.7	4.41	6.974E-06	-7.244E-03	2.467E+00
610	69.5	40.4	6.66	6.974E-06	-7.244E-03	2.467E+00
611	70.3	25.8	7.73	6.974E-06	-7.244E-03	2.467E+00
612	35.7	13.9	7.84	6.974E-06	-7.244E-03	2.467E+00
613	38	4.9	8.05	6.974E-06	-7.244E-03	2.467E+00

614	37.8	4.4	8.04	6.974E-06	-7.244E-03	2.467E+00
615	37.5	4.3	8.01	6.974E-06	-7.244E-03	2.467E+00
616	37.3	4.3	7.99	6.974E-06	-7.244E-03	2.467E+00
617	37	4.4	7.96	6.974E-06	-7.244E-03	2.467E+00
618	36.7	4.4	7.94	6.974E-06	-7.244E-03	2.467E+00
619	36.5	4.5	7.92	6.974E-06	-7.244E-03	2.467E+00
620	36.9	12.3	7.95	6.974E-06	-7.244E-03	2.467E+00
621	44.6	20.6	8.65	6.974E-06	-7.244E-03	2.467E+00
622	51.4	10.4	9.28	6.974E-06	-7.244E-03	2.467E+00
623	53.7	(°)	9.49	6.974E-06	-7.244E-03	2.467E+00
624	53.5	(°)	9.48	6.974E-06	-7.244E-03	2.467E+00
625	54.2	16.7	9.52	6.974E-06	-7.244E-03	2.467E+00
626	62.2	18.4	10.26	6.974E-06	-7.244E-03	2.467E+00
627	65.7	8.9	10.78	6.974E-06	-7.244E-03	2.467E+00
628	43.8	(°)	10.94	6.974E-06	-7.244E-03	2.467E+00
629	42.4	1.5	10.77	6.974E-06	-7.244E-03	2.467E+00
630	41.8	4.6	10.7	6.974E-06	-7.244E-03	2.467E+00
631	41.6	5.1	10.67	6.974E-06	-7.244E-03	2.467E+00
632	41.4	5.1	10.66	6.974E-06	-7.244E-03	2.467E+00
633	41.3	5.2	10.65	6.974E-06	-7.244E-03	2.467E+00
634	41.2	5.2	10.63	6.974E-06	-7.244E-03	2.467E+00
635	41.1	5.2	10.62	6.974E-06	-7.244E-03	2.467E+00
636	41	5.2	10.61	6.974E-06	-7.244E-03	2.467E+00
637	41	5.3	10.6	6.974E-06	-7.244E-03	2.467E+00
638	40.9	5.3	10.59	6.974E-06	-7.244E-03	2.467E+00
639	40.8	5.3	10.58	6.974E-06	-7.244E-03	2.467E+00
640	40.7	5.3	10.58	6.974E-06	-7.244E-03	2.467E+00
641	42.1	13.3	10.73	6.974E-06	-7.244E-03	2.467E+00
642	45.4	13.6	11.11	6.974E-06	-7.244E-03	2.467E+00
643	50.5	9.9	11.71	6.974E-06	-7.244E-03	2.467E+00
644	53.2	5.7	12.03	6.974E-06	-7.244E-03	2.467E+00
645	54.6	(°)	12.2	6.974E-06	-7.244E-03	2.467E+00
646	53.9	0.3	12.12	6.974E-06	-7.244E-03	2.467E+00
647	53.3	4.7	12.04	6.974E-06	-7.244E-03	2.467E+00
648	53.1	5.3	12.02	6.974E-06	-7.244E-03	2.467E+00
649	53.1	5.4	12.01	4.837E-06	-5.146E-03	1.740E+00
650	53	5.4	12.01	2.700E-06	-3.048E-03	1.013E+00
651	53	5.4	12	5.632E-07	-9.497E-04	2.854E-01
652	52.9	5.4	12	5.632E-07	-9.497E-04	2.854E-01
653	52.9	5.4	12	5.632E-07	-9.497E-04	2.854E-01
654	52.9	5.4	11.99	5.632E-07	-9.497E-04	2.854E-01
655	52.8	5.4	11.99	5.632E-07	-9.497E-04	2.854E-01
656	52.8	5.4	11.98	5.632E-07	-9.497E-04	2.854E-01
657	52.8	5.4	11.98	5.632E-07	-9.497E-04	2.854E-01
658	52.8	5.4	11.98	5.632E-07	-9.497E-04	2.854E-01
659	52.7	5.4	11.97	5.632E-07	-9.497E-04	2.854E-01
660	55.2	16.3	12.25	5.632E-07	-9.497E-04	2.854E-01
661	58.7	16.1	12.65	5.632E-07	-9.497E-04	2.854E-01
662	54	10.8	12.89	5.632E-07	-9.497E-04	2.854E-01
663	38.1	35.5	12.97	5.632E-07	-9.497E-04	2.854E-01
664	44.3	23.7	13.88	5.632E-07	-9.497E-04	2.854E-01
665	46.3	1.7	14.19	5.632E-07	-9.497E-04	2.854E-01
666	46.4	(°)	14.22	5.632E-07	-9.497E-04	2.854E-01
667	45.8	7.8	14.11	5.632E-07	-9.497E-04	2.854E-01
668	50.4	34.7	14.77	5.632E-07	-9.497E-04	2.854E-01
669	54.7	15.2	15.43	5.632E-07	-9.497E-04	2.854E-01
670	57.6	(°)	15.88	5.632E-07	-9.497E-04	2.854E-01
671	54.1	(°)	15.37	5.632E-07	-9.497E-04	2.854E-01
672	52.1	(°)	15.06	5.632E-07	-9.497E-04	2.854E-01
673	52	(°)	15.04	5.632E-07	-9.497E-04	2.854E-01
674	51.3	5.7	14.94	5.632E-07	-9.497E-04	2.854E-01
675	51.3	6.8	14.93	5.632E-07	-9.497E-04	2.854E-01
676	51.6	11.2	14.97	5.632E-07	-9.497E-04	2.854E-01
677	54.2	11.5	15.35	5.632E-07	-9.497E-04	2.854E-01
678	54.7	16.5	15.43	5.632E-07	-9.497E-04	2.854E-01
679	54.4	22.6	15.38	5.632E-07	-9.497E-04	2.854E-01
680	55.3	8.6	15.52	5.632E-07	-9.497E-04	2.854E-01
681	55.8	1.3	15.6	5.632E-07	-9.497E-04	2.854E-01
682	55.5	4.3	15.56	5.632E-07	-9.497E-04	2.854E-01
683	55.3	6.3	15.53	5.632E-07	-9.497E-04	2.854E-01
684	55.3	6.5	15.52	5.632E-07	-9.497E-04	2.854E-01
685	55.3	6.5	15.52	5.632E-07	-9.497E-04	2.854E-01

686	55.3	6.5	15.52	5.632E-07	-9.497E-04	2.854E-01
687	55.3	6.5	15.51	5.632E-07	-9.497E-04	2.854E-01
688	55.2	4.8	15.51	5.632E-07	-9.497E-04	2.854E-01
689	54.4	2.7	15.39	5.632E-07	-9.497E-04	2.854E-01
690	55.2	(°)	15.52	5.632E-07	-9.497E-04	2.854E-01
691	54.2	13.3	15.36	5.632E-07	-9.497E-04	2.854E-01
692	54.1	11.8	15.34	5.632E-07	-9.497E-04	2.854E-01
693	54.7	5.3	15.43	5.632E-07	-9.497E-04	2.854E-01
694	55.4	(°)	15.54	5.632E-07	-9.497E-04	2.854E-01
695	54.9	1.9	15.46	5.632E-07	-9.497E-04	2.854E-01
696	54.5	6.2	15.4	5.632E-07	-9.497E-04	2.854E-01
697	54.5	7.2	15.41	5.632E-07	-9.497E-04	2.854E-01
698	54.5	6.3	15.41	5.632E-07	-9.497E-04	2.854E-01
699	54	(°)	15.33	4.087E-07	-8.219E-04	3.495E-01
700	54.8	(°)	15.46	2.542E-07	-6.940E-04	4.136E-01
701	54.1	(°)	15.36	9.973E-08	-5.661E-04	4.778E-01
702	53.2	6.7	15.21	9.973E-08	-5.661E-04	4.778E-01
703	53.5	5.8	15.25	9.973E-08	-5.661E-04	4.778E-01
704	53	(°)	15.19	9.973E-08	-5.661E-04	4.778E-01
705	50.9	8.6	14.87	9.973E-08	-5.661E-04	4.778E-01
706	50.7	11.7	14.84	9.973E-08	-5.661E-04	4.778E-01
707	51.1	7.8	14.9	9.973E-08	-5.661E-04	4.778E-01
708	51.2	6.6	14.92	9.973E-08	-5.661E-04	4.778E-01
709	51.2	6.5	14.92	9.973E-08	-5.661E-04	4.778E-01
710	51.2	6.5	14.92	9.973E-08	-5.661E-04	4.778E-01
711	51.2	6.5	14.92	9.973E-08	-5.661E-04	4.778E-01
712	51.3	6.5	14.92	9.973E-08	-5.661E-04	4.778E-01
713	51.3	6.5	14.92	9.973E-08	-5.661E-04	4.778E-01
714	51.3	6.5	14.93	9.973E-08	-5.661E-04	4.778E-01
732	51.3	6.5	14.93	9.973E-08	-5.661E-04	4.778E-01
733	51.3	6.5	14.94	9.973E-08	-5.661E-04	4.778E-01
734	51.4	10.5	14.95	9.973E-08	-5.661E-04	4.778E-01
735	53.1	11.2	15.19	9.973E-08	-5.661E-04	4.778E-01
736	52.9	5.3	15.17	9.973E-08	-5.661E-04	4.778E-01
737	53.8	2.9	15.3	9.973E-08	-5.661E-04	4.778E-01
738	55.5	(°)	15.56	9.973E-08	-5.661E-04	4.778E-01
739	55.1	2	15.5	9.973E-08	-5.661E-04	4.778E-01
740	55.7	6.8	15.58	9.973E-08	-5.661E-04	4.778E-01
741	55.9	5.3	15.61	9.973E-08	-5.661E-04	4.778E-01
742	54.1	18	15.33	9.973E-08	-5.661E-04	4.778E-01
743	53.9	14.8	15.3	9.973E-08	-5.661E-04	4.778E-01
744	55	9.5	15.47	9.973E-08	-5.661E-04	4.778E-01
745	55.4	1.9	15.54	9.973E-08	-5.661E-04	4.778E-01
746	55.7	8.4	15.58	9.973E-08	-5.661E-04	4.778E-01
747	57.4	(°)	15.85	9.973E-08	-5.661E-04	4.778E-01
748	56.7	(°)	15.77	9.973E-08	-5.661E-04	4.778E-01
749	32.2	(°)	15.36	9.973E-08	-5.661E-04	4.778E-01
750	30.2	25.4	15.05	9.973E-08	-5.661E-04	4.778E-01
751	28.9	43.8	14.8	9.973E-08	-5.661E-04	4.778E-01
752	29.6	37.9	14.93	9.973E-08	-5.661E-04	4.778E-01
753	30.5	13.4	15.11	3.324E-08	-1.887E-04	1.593E-01
754	30.6	(°)	15.14	-3.324E-08	1.887E-04	-1.593E-01
755	29.2	(°)	14.88	-9.973E-08	5.661E-04	-4.778E-01
756	28.7	(°)	14.79	-9.973E-08	5.661E-04	-4.778E-01
757	28.2	(°)	14.69	-9.973E-08	5.661E-04	-4.778E-01
758	27.7	8.5	14.6	-9.973E-08	5.661E-04	-4.778E-01
759	27.5	(°)	14.55	-9.973E-08	5.661E-04	-4.778E-01
760	24.9	(°)	14.09	-9.973E-08	5.661E-04	-4.778E-01
761	23.1	(°)	13.76	-9.973E-08	5.661E-04	-4.778E-01
762	21	8.9	12.81	-9.973E-08	5.661E-04	-4.778E-01
763	34.4	(°)	12.32	-9.973E-08	5.661E-04	-4.778E-01
764	30.1	(°)	11.83	-9.973E-08	5.661E-04	-4.778E-01
765	22.8	(°)	10.76	-9.973E-08	5.661E-04	-4.778E-01
766	13.2	(°)	9.35	-9.973E-08	5.661E-04	-4.778E-01
767	17.9	7.1	7.87	-9.973E-08	5.661E-04	-4.778E-01
768	21.7	10.3	6.32	-9.973E-08	5.661E-04	-4.778E-01
769	15.3	(°)	4.47	-9.973E-08	5.661E-04	-4.778E-01
770	0.9	(°)	2.49	-9.973E-08	5.661E-04	-4.778E-01
771	0.1	5.6	1.67	-9.973E-08	5.661E-04	-4.778E-01
772	0	0	1.55	-9.973E-08	5.661E-04	-4.778E-01
773	0	0	1.46	-9.973E-08	5.661E-04	-4.778E-01
774	0	0	0.71	-9.973E-08	5.661E-04	-4.778E-01



775	0	0	0	-9.973E-08	5.661E-04	-4.778E-01
799	0	0	0	-9.973E-08	5.661E-04	-4.778E-01
800	0	0	0	3.522E-06	-3.252E-03	6.821E-01
801	0	0	0	7.144E-06	-7.070E-03	1.842E+00
802	0	0	0	1.077E-05	-1.089E-02	3.002E+00
810	0	0	0	1.077E-05	-1.089E-02	3.002E+00
811	7.7	34.4	1.28	1.077E-05	-1.089E-02	3.002E+00
812	16.2	15.7	2.87	1.077E-05	-1.089E-02	3.002E+00
813	37.9	5.1	3.79	1.077E-05	-1.089E-02	3.002E+00
814	51.4	10.8	4.37	1.077E-05	-1.089E-02	3.002E+00
815	71.1	18.9	5.19	1.077E-05	-1.089E-02	3.002E+00
816	49.8	( <sup>o</sup> )	5.6	1.077E-05	-1.089E-02	3.002E+00
817	65.6	18.1	6.47	1.077E-05	-1.089E-02	3.002E+00
818	43.5	4.8	6.4	1.077E-05	-1.089E-02	3.002E+00
819	47.4	35.6	6.93	1.077E-05	-1.089E-02	3.002E+00
820	73	32.8	8.77	1.077E-05	-1.089E-02	3.002E+00
821	76.2	29	9.82	1.077E-05	-1.089E-02	3.002E+00
822	33.1	6.8	9.69	1.077E-05	-1.089E-02	3.002E+00
823	44.9	51	11.01	1.077E-05	-1.089E-02	3.002E+00
824	60.1	44.1	12.8	1.077E-05	-1.089E-02	3.002E+00
825	67	22.5	13.62	1.077E-05	-1.089E-02	3.002E+00
826	72.5	28.6	14.25	1.077E-05	-1.089E-02	3.002E+00
827	46	2.8	13.95	1.077E-05	-1.089E-02	3.002E+00
828	51	60.5	14.84	1.077E-05	-1.089E-02	3.002E+00
829	63	33.5	16.62	1.077E-05	-1.089E-02	3.002E+00
830	65.5	25.2	17	1.077E-05	-1.089E-02	3.002E+00
831	57.8	12.7	17.13	1.077E-05	-1.089E-02	3.002E+00
832	40.4	36	16.96	1.077E-05	-1.089E-02	3.002E+00
833	43.6	24.7	17.56	1.077E-05	-1.089E-02	3.002E+00
834	44.1	21.8	17.66	3.588E-06	-3.630E-03	1.001E+00
835	45	10.9	17.84	-3.588E-06	3.630E-03	-1.001E+00
836	44.3	( <sup>o</sup> )	17.71	-1.077E-05	1.089E-02	-3.002E+00
837	42	( <sup>o</sup> )	17.28	-1.077E-05	1.089E-02	-3.002E+00
838	38.5	( <sup>o</sup> )	16.63	-1.077E-05	1.089E-02	-3.002E+00
839	35.3	( <sup>o</sup> )	16.03	-1.077E-05	1.089E-02	-3.002E+00
840	31.3	( <sup>o</sup> )	15.29	-1.077E-05	1.089E-02	-3.002E+00
841	24.9	( <sup>o</sup> )	14.1	-1.077E-05	1.089E-02	-3.002E+00
842	29.1	12.7	12.28	-1.077E-05	1.089E-02	-3.002E+00
843	20.4	( <sup>o</sup> )	10.41	-1.077E-05	1.089E-02	-3.002E+00
844	14.7	12.9	8.82	-1.077E-05	1.089E-02	-3.002E+00
845	14.7	( <sup>o</sup> )	7.57	-1.077E-05	1.089E-02	-3.002E+00
846	17.2	6.5	5.93	-1.077E-05	1.089E-02	-3.002E+00
847	16.7	12.3	3.77	-1.077E-05	1.089E-02	-3.002E+00
848	0	0	1.51	-1.077E-05	1.089E-02	-3.002E+00
849	0	0	0	-1.077E-05	1.089E-02	-3.002E+00
864	0	0	0	-1.077E-05	1.089E-02	-3.002E+00
865	0	0	0	-3.199E-06	3.169E-03	-1.698E+00
866	0	0	0	4.367E-06	-4.551E-03	-3.934E-01
867	0	0	0	1.193E-05	-1.227E-02	9.108E-01
869	0	0	0	1.193E-05	-1.227E-02	9.108E-01
870	3	5	0	1.193E-05	-1.227E-02	9.108E-01
871	7	10	0	1.193E-05	-1.227E-02	9.108E-01
872	58.6	22.6	5.59	1.193E-05	-1.227E-02	9.108E-01
873	84.8	19.9	6.92	1.193E-05	-1.227E-02	9.108E-01
874	46.7	3.3	6.66	1.193E-05	-1.227E-02	9.108E-01
875	51.2	10.4	7.09	1.193E-05	-1.227E-02	9.108E-01
876	56.5	10.6	7.46	1.193E-05	-1.227E-02	9.108E-01
877	70.3	14.4	8.4	1.193E-05	-1.227E-02	9.108E-01
878	53.2	10.4	8.86	1.193E-05	-1.227E-02	9.108E-01
879	50.4	34.3	9.51	9.979E-06	-1.043E-02	9.264E-01
880	81.5	54.8	12.38	8.023E-06	-8.594E-03	9.420E-01
881	91.3	5.4	13.38	6.068E-06	-6.755E-03	9.576E-01
882	63.6	10.3	13.29	6.068E-06	-6.755E-03	9.576E-01
883	57.9	37.8	13.65	6.068E-06	-6.755E-03	9.576E-01
884	80.1	61.2	16.37	6.068E-06	-6.755E-03	9.576E-01
885	89.5	24	17.62	6.068E-06	-6.755E-03	9.576E-01
886	60.8	7.4	17.9	6.068E-06	-6.755E-03	9.576E-01
887	57.2	41.9	18.28	6.068E-06	-6.755E-03	9.576E-01
888	65.4	8.4	19.71	6.068E-06	-6.755E-03	9.576E-01
889	65.6	5.5	19.75	5.713E-06	-6.392E-03	4.768E-01
890	35.9	0.3	19.56	5.358E-06	-6.028E-03	-3.992E-03
891	35.4	31.2	19.87	5.004E-06	-5.665E-03	-4.848E-01

892	37.3	19	20.32	5.004E-06	-5.665E-03	-4.848E-01
893	40.5	38	21	5.004E-06	-5.665E-03	-4.848E-01
894	46.4	56.4	22.32	5.004E-06	-5.665E-03	-4.848E-01
895	52.5	39.6	23.74	5.004E-06	-5.665E-03	-4.848E-01
896	54.6	7.8	24.26	5.004E-06	-5.665E-03	-4.848E-01
897	53.3	( <sup>6</sup> )	23.98	5.004E-06	-5.665E-03	-4.848E-01
898	51.2	( <sup>6</sup> )	23.51	5.004E-06	-5.665E-03	-4.848E-01
899	49.3	( <sup>6</sup> )	23.08	3.154E-06	-3.810E-03	-3.535E-01
900	47.4	( <sup>6</sup> )	22.66	1.304E-06	-1.954E-03	-2.222E-01
901	46	6.4	22.31	-5.462E-07	-9.930E-05	-9.097E-02
902	45.9	7.6	22.29	-5.462E-07	-9.930E-05	-9.097E-02
903	46.4	18.3	22.38	-5.462E-07	-9.930E-05	-9.097E-02
904	48.1	23.5	22.75	-5.462E-07	-9.930E-05	-9.097E-02
905	50	22.5	23.2	-5.462E-07	-9.930E-05	-9.097E-02
906	50.5	8.6	23.34	-5.462E-07	-9.930E-05	-9.097E-02
907	48.9	( <sup>6</sup> )	22.99	-5.462E-07	-9.930E-05	-9.097E-02
908	48.2	11	22.8	-5.462E-07	-9.930E-05	-9.097E-02
909	47.5	3.6	22.66	9.609E-07	-1.656E-03	1.853E-01
910	48.3	14.9	22.82	2.468E-06	-3.213E-03	4.616E-01
911	48.7	13	22.92	3.975E-06	-4.769E-03	7.379E-01
912	47.8	( <sup>6</sup> )	22.74	3.975E-06	-4.769E-03	7.379E-01
913	47.8	14.5	22.71	3.975E-06	-4.769E-03	7.379E-01
914	48.3	10.1	22.82	3.975E-06	-4.769E-03	7.379E-01
915	48.3	6.4	22.84	3.975E-06	-4.769E-03	7.379E-01
916	48.2	7	22.8	3.975E-06	-4.769E-03	7.379E-01
917	48.3	12.5	22.83	3.975E-06	-4.769E-03	7.379E-01
918	48.1	6.6	22.79	3.975E-06	-4.769E-03	7.379E-01
919	48.2	12.1	22.79	3.975E-06	-4.769E-03	7.379E-01
920	49.2	17.9	23.02	1.325E-06	-1.590E-03	2.460E-01
921	50.7	11.7	23.36	-1.325E-06	1.590E-03	-2.460E-01
922	49.4	( <sup>6</sup> )	23.1	-3.975E-06	4.769E-03	-7.379E-01
923	47.2	( <sup>6</sup> )	22.61	-3.975E-06	4.769E-03	-7.379E-01
924	44.8	( <sup>6</sup> )	22.06	-3.975E-06	4.769E-03	-7.379E-01
925	42.1	( <sup>6</sup> )	21.45	-3.975E-06	4.769E-03	-7.379E-01
926	39.1	( <sup>6</sup> )	20.76	-3.975E-06	4.769E-03	-7.379E-01
927	36.2	( <sup>6</sup> )	20.11	-3.975E-06	4.769E-03	-7.379E-01
928	33.5	( <sup>6</sup> )	19.48	-3.975E-06	4.769E-03	-7.379E-01
929	29.8	( <sup>6</sup> )	18.65	-3.975E-06	4.769E-03	-7.379E-01
930	25.1	( <sup>6</sup> )	17.59	-3.975E-06	4.769E-03	-7.379E-01
931	20.4	( <sup>6</sup> )	16.52	-3.975E-06	4.769E-03	-7.379E-01
932	23.8	13.5	15.18	-3.975E-06	4.769E-03	-7.379E-01
933	29.8	1.8	13.26	-3.975E-06	4.769E-03	-7.379E-01
934	15.6	( <sup>6</sup> )	11.39	-3.975E-06	4.769E-03	-7.379E-01
935	19.4	14.3	9.71	-3.975E-06	4.769E-03	-7.379E-01
936	16.1	( <sup>6</sup> )	8.52	-3.975E-06	4.769E-03	-7.379E-01
937	16.3	13.1	6.98	-3.975E-06	4.769E-03	-7.379E-01
938	17.8	11.5	4.9	-3.975E-06	4.769E-03	-7.379E-01
939	8.6	1.8	2.92	-3.975E-06	4.769E-03	-7.379E-01
940	0	0	2.39	-3.975E-06	4.769E-03	-7.379E-01
941	0	0	2.44	-3.975E-06	4.769E-03	-7.379E-01
942	0	0	2.37	-3.975E-06	4.769E-03	-7.379E-01
943	1	5	1.67	-3.975E-06	4.769E-03	-7.379E-01
944	5	8.7	1.17	-3.975E-06	4.769E-03	-7.379E-01
945	5.4	7.6	1.34	-3.975E-06	4.769E-03	-7.379E-01
946	0	0	1.28	-3.975E-06	4.769E-03	-7.379E-01
947	0	0	0.56	-1.325E-06	1.590E-03	-2.460E-01
948	0	0	0	1.325E-06	-1.590E-03	2.460E-01
949	0	0	0	3.975E-06	-4.769E-03	7.379E-01
952	0	0	0	3.975E-06	-4.769E-03	7.379E-01
953	5.4	16.3	0.27	3.975E-06	-4.769E-03	7.379E-01
954	7.2	26	1.4	3.975E-06	-4.769E-03	7.379E-01
955	27.1	23	2.96	3.975E-06	-4.769E-03	7.379E-01
956	64.4	18	4.35	3.975E-06	-4.769E-03	7.379E-01
957	44.8	3.7	4.75	3.975E-06	-4.769E-03	7.379E-01
958	60.6	28.7	5.67	3.975E-06	-4.769E-03	7.379E-01
959	92.5	23.9	7.29	3.975E-06	-4.769E-03	7.379E-01
960	53	1.3	7.23	3.975E-06	-4.769E-03	7.379E-01
961	85.2	41.6	9.37	3.975E-06	-4.769E-03	7.379E-01
962	56.3	0.4	9.93	3.975E-06	-4.769E-03	7.379E-01
963	67.8	48.8	11.11	3.975E-06	-4.769E-03	7.379E-01
964	101.7	55.3	13.96	3.975E-06	-4.769E-03	7.379E-01
965	31.9	2.4	13.82	3.975E-06	-4.769E-03	7.379E-01

966	37.3	57.2	14.93	3.975E-06	-4.769E-03	7.379E-01
967	54.7	82.5	17.81	3.975E-06	-4.769E-03	7.379E-01
968	64.3	12.2	19.52	3.975E-06	-4.769E-03	7.379E-01
969	65.1	8.7	19.67	3.461E-06	-4.200E-03	7.130E-01
970	36.8	1	19.69	2.947E-06	-3.630E-03	6.882E-01
971	35.5	20.2	19.9	2.433E-06	-3.060E-03	6.633E-01
972	36.9	14.6	20.23	2.433E-06	-3.060E-03	6.633E-01
973	38.2	14.8	20.52	2.433E-06	-3.060E-03	6.633E-01
974	38.9	8	20.69	8.109E-07	-1.020E-03	2.211E-01
975	39	7.7	20.7	-8.109E-07	1.020E-03	-2.211E-01
976	37.5	(°)	20.38	-2.433E-06	3.060E-03	-6.633E-01
977	35.6	(°)	19.95	-2.433E-06	3.060E-03	-6.633E-01
978	33.1	(°)	19.4	-2.433E-06	3.060E-03	-6.633E-01
979	30	(°)	18.69	-2.433E-06	3.060E-03	-6.633E-01
980	26.2	(°)	17.83	-2.433E-06	3.060E-03	-6.633E-01
981	21.9	(°)	16.86	-2.433E-06	3.060E-03	-6.633E-01
982	18.1	(°)	15.98	-2.433E-06	3.060E-03	-6.633E-01
983	40.7	16.1	15.23	-2.433E-06	3.060E-03	-6.633E-01
984	36	(°)	14.81	-2.433E-06	3.060E-03	-6.633E-01
985	33.7	(°)	14.4	-2.433E-06	3.060E-03	-6.633E-01
986	32	(°)	14.12	-2.433E-06	3.060E-03	-6.633E-01
987	29.3	(°)	13.67	-2.433E-06	3.060E-03	-6.633E-01
988	27	(°)	13.29	-2.433E-06	3.060E-03	-6.633E-01
989	24.6	(°)	12.89	-2.433E-06	3.060E-03	-6.633E-01
990	21.8	(°)	12.41	-2.433E-06	3.060E-03	-6.633E-01
991	18.2	(°)	11.82	-2.433E-06	3.060E-03	-6.633E-01
992	9.9	6.7	9.97	-2.433E-06	3.060E-03	-6.633E-01
993	16	2.1	8.01	-2.433E-06	3.060E-03	-6.633E-01
994	13.4	4	5.89	-2.433E-06	3.060E-03	-6.633E-01
995	11.3	5.7	3.93	-2.433E-06	3.060E-03	-6.633E-01
996	0	0	2.5	-2.433E-06	3.060E-03	-6.633E-01
997	0.3	3.9	2.18	-2.433E-06	3.060E-03	-6.633E-01
998	0.2	3.5	1.91	-2.433E-06	3.060E-03	-6.633E-01
999	0	0	2.01	-2.433E-06	3.060E-03	-6.633E-01
1000	0	0	2.13	-2.433E-06	3.060E-03	-6.633E-01
1001	0	0	2.04	-2.433E-06	3.060E-03	-6.633E-01
1002	0	0	0.61	-2.433E-06	3.060E-03	-6.633E-01
1003	0	0	0	-2.433E-06	3.060E-03	-6.633E-01
1014	0	0	0	-2.433E-06	3.060E-03	-6.633E-01
1015	0	0	0	-1.410E-06	1.623E-03	-4.817E-01
1016	0	0	0	-3.875E-07	1.855E-04	-3.001E-01
1017	1	7.6	0.01	6.352E-07	-1.252E-03	-1.186E-01
1018	7.8	34.2	0.94	6.352E-07	-1.252E-03	-1.186E-01
1019	27.5	19.7	2.99	6.352E-07	-1.252E-03	-1.186E-01
1020	67.8	18.4	4.47	6.352E-07	-1.252E-03	-1.186E-01
1021	39.9	5.8	4.45	6.352E-07	-1.252E-03	-1.186E-01
1022	39.1	27.8	4.59	6.352E-07	-1.252E-03	-1.186E-01
1023	90.5	36.7	7.17	6.352E-07	-1.252E-03	-1.186E-01
1024	55.7	1.3	7.32	6.352E-07	-1.252E-03	-1.186E-01
1025	81.4	46.8	9.1	6.352E-07	-1.252E-03	-1.186E-01
1026	56.6	2.7	9.86	6.352E-07	-1.252E-03	-1.186E-01
1027	62.2	36.5	10.61	6.352E-07	-1.252E-03	-1.186E-01
1028	81	44.1	12.35	6.352E-07	-1.252E-03	-1.186E-01
1029	64.2	11	13.32	6.352E-07	-1.252E-03	-1.186E-01
1030	56.2	37.2	13.44	6.352E-07	-1.252E-03	-1.186E-01
1031	77.1	77.9	15.98	6.352E-07	-1.252E-03	-1.186E-01
1032	103.6	47.7	18.47	6.352E-07	-1.252E-03	-1.186E-01
1033	56.1	2.9	18.15	6.352E-07	-1.252E-03	-1.186E-01
1034	65	62.1	19.55	6.352E-07	-1.252E-03	-1.186E-01
1035	72.1	27.2	20.81	6.352E-07	-1.252E-03	-1.186E-01
1036	75	19.5	21.31	6.352E-07	-1.252E-03	-1.186E-01
1037	42.6	1.6	21.12	6.352E-07	-1.252E-03	-1.186E-01
1038	43.4	47.9	21.65	6.352E-07	-1.252E-03	-1.186E-01
1039	47.3	26.8	22.57	6.352E-07	-1.252E-03	-1.186E-01
1040	49	21.4	22.98	6.352E-07	-1.252E-03	-1.186E-01
1041	50.5	23.2	23.32	6.352E-07	-1.252E-03	-1.186E-01
1042	51.9	20.3	23.63	6.352E-07	-1.252E-03	-1.186E-01
1043	53.2	19.4	23.92	6.352E-07	-1.252E-03	-1.186E-01
1044	54.1	14.5	24.14	6.352E-07	-1.252E-03	-1.186E-01
1045	54	6.5	24.13	6.352E-07	-1.252E-03	-1.186E-01
1046	54.9	26.4	24.3	6.352E-07	-1.252E-03	-1.186E-01
1047	58	38	24.99	6.352E-07	-1.252E-03	-1.186E-01

1048	60.7	25.2	25.63	6.352E-07	-1.252E-03	-1.186E-01
1049	32.4	( <sup>o</sup> )	25.39	6.352E-07	-1.252E-03	-1.186E-01
1050	29.8	7.6	25.06	6.352E-07	-1.252E-03	-1.186E-01
1051	28.4	( <sup>o</sup> )	24.66	6.352E-07	-1.252E-03	-1.186E-01
1052	26.2	( <sup>o</sup> )	23.99	6.352E-07	-1.252E-03	-1.186E-01
1053	25.2	14.1	23.63	6.352E-07	-1.252E-03	-1.186E-01
1054	26.9	47.6	24.13	6.352E-07	-1.252E-03	-1.186E-01
1055	30.5	70.4	25.2	6.352E-07	-1.252E-03	-1.186E-01
1056	32.1	12.2	25.77	6.352E-07	-1.252E-03	-1.186E-01
1057	32.6	26.7	25.89	6.352E-07	-1.252E-03	-1.186E-01
1058	34.5	44	26.46	6.352E-07	-1.252E-03	-1.186E-01
1059	36.5	34.5	27.06	6.352E-07	-1.252E-03	-1.186E-01
1060	37.7	26.5	27.46	6.352E-07	-1.252E-03	-1.186E-01
1061	38.6	23.3	27.72	6.352E-07	-1.252E-03	-1.186E-01
1062	39.3	20.6	27.95	6.352E-07	-1.252E-03	-1.186E-01
1063	39.6	19.9	28.03	6.352E-07	-1.252E-03	-1.186E-01
1064	40.1	23.2	28.19	6.352E-07	-1.252E-03	-1.186E-01
1065	40.7	25.2	28.38	6.352E-07	-1.252E-03	-1.186E-01
1066	41.6	27.3	28.64	6.352E-07	-1.252E-03	-1.186E-01
1067	42.4	23.5	28.9	6.352E-07	-1.252E-03	-1.186E-01
1068	42.9	22.5	29.04	6.352E-07	-1.252E-03	-1.186E-01
1069	43.2	15.8	29.14	6.352E-07	-1.252E-03	-1.186E-01
1070	43.1	15.6	29.13	6.352E-07	-1.252E-03	-1.186E-01
1071	43.2	17.1	29.17	6.352E-07	-1.252E-03	-1.186E-01
1072	43.2	13.8	29.17	6.352E-07	-1.252E-03	-1.186E-01
1073	43.2	14.7	29.15	6.352E-07	-1.252E-03	-1.186E-01
1074	43	22.7	29.09	6.352E-07	-1.252E-03	-1.186E-01
1075	43.8	24.6	29.31	6.352E-07	-1.252E-03	-1.186E-01
1076	44.2	13.7	29.46	6.352E-07	-1.252E-03	-1.186E-01
1077	44	6.9	29.39	6.352E-07	-1.252E-03	-1.186E-01
1078	42.9	( <sup>o</sup> )	29.08	6.352E-07	-1.252E-03	-1.186E-01
1079	41.4	2.9	28.62	6.352E-07	-1.252E-03	-1.186E-01
1080	41	14	28.48	6.352E-07	-1.252E-03	-1.186E-01
1081	41.1	17.7	28.5	6.352E-07	-1.252E-03	-1.186E-01
1082	41.7	15	28.69	6.352E-07	-1.252E-03	-1.186E-01
1083	42.4	19.8	28.91	6.352E-07	-1.252E-03	-1.186E-01
1084	43.5	17.4	29.24	6.352E-07	-1.252E-03	-1.186E-01
1085	44	10.8	29.41	6.352E-07	-1.252E-03	-1.186E-01
1086	44.3	10	29.51	6.352E-07	-1.252E-03	-1.186E-01
1087	44.5	6.5	29.55	6.352E-07	-1.252E-03	-1.186E-01
1088	44.1	0.4	29.46	6.352E-07	-1.252E-03	-1.186E-01
1089	43.4	1.2	29.24	6.352E-07	-1.252E-03	-1.186E-01
1090	43.2	7.3	29.17	6.352E-07	-1.252E-03	-1.186E-01
1091	43.1	4.7	29.14	6.352E-07	-1.252E-03	-1.186E-01
1092	42.8	4.7	29.04	6.352E-07	-1.252E-03	-1.186E-01
1093	42.6	5.8	28.97	6.352E-07	-1.252E-03	-1.186E-01
1094	42.6	9.8	28.97	6.352E-07	-1.252E-03	-1.186E-01
1095	42.9	13.4	29.06	6.352E-07	-1.252E-03	-1.186E-01
1096	43.4	19	29.22	6.352E-07	-1.252E-03	-1.186E-01
1097	44.2	15	29.47	6.352E-07	-1.252E-03	-1.186E-01
1098	44.6	11.5	29.59	6.352E-07	-1.252E-03	-1.186E-01
1099	44.8	5.5	29.66	3.896E-07	-1.022E-03	-3.475E-01
1100	44.1	( <sup>o</sup> )	29.47	1.440E-07	-7.913E-04	-5.765E-01
1101	43.1	( <sup>o</sup> )	29.25	-1.016E-07	-5.610E-04	-8.055E-01
1102	42.8	10.3	29.03	-1.016E-07	-5.610E-04	-8.055E-01
1103	43	0.7	29.1	-1.016E-07	-5.610E-04	-8.055E-01
1104	42	( <sup>o</sup> )	28.82	-1.016E-07	-5.610E-04	-8.055E-01
1105	41.3	( <sup>o</sup> )	28.60	-1.016E-07	-5.610E-04	-8.055E-01
1106	40.7	( <sup>o</sup> )	28.41	-1.016E-07	-5.610E-04	-8.055E-01
1107	40	1.3	28.19	-1.016E-07	-5.610E-04	-8.055E-01
1108	39.6	6.1	28.07	-1.016E-07	-5.610E-04	-8.055E-01
1109	39.4	2.4	28.01	-1.016E-07	-5.610E-04	-8.055E-01
1110	38.8	( <sup>o</sup> )	27.84	-1.016E-07	-5.610E-04	-8.055E-01
1111	38.1	0.1	27.62	-1.016E-07	-5.610E-04	-8.055E-01
1112	37.4	( <sup>o</sup> )	27.4	-1.016E-07	-5.610E-04	-8.055E-01
1113	36.1	( <sup>o</sup> )	27.01	-1.016E-07	-5.610E-04	-8.055E-01
1114	35	( <sup>o</sup> )	26.68	-1.016E-07	-5.610E-04	-8.055E-01
1115	34	( <sup>o</sup> )	26.35	-1.016E-07	-5.610E-04	-8.055E-01
1116	32.7	( <sup>o</sup> )	25.98	-1.016E-07	-5.610E-04	-8.055E-01
1117	31	( <sup>o</sup> )	25.46	-1.016E-07	-5.610E-04	-8.055E-01
1118	29.8	0.8	25.05	-1.016E-07	-5.610E-04	-8.055E-01
1119	30	8.2	25.12	-1.016E-07	-5.610E-04	-8.055E-01

1120	29.8	1.2	25.07	-1.016E-07	-5.610E-04	-8.055E-01
1121	29.1	(°)	24.86	-1.016E-07	-5.610E-04	-8.055E-01
1122	28	(°)	24.51	-1.016E-07	-5.610E-04	-8.055E-01
1123	26.8	(°)	24.15	-1.016E-07	-5.610E-04	-8.055E-01
1124	25.7	(°)	23.82	-1.016E-07	-5.610E-04	-8.055E-01
1125	24	(°)	23.3	-1.016E-07	-5.610E-04	-8.055E-01
1126	22.3	(°)	22.79	-1.016E-07	-5.610E-04	-8.055E-01
1127	21.1	(°)	22.39	-1.016E-07	-5.610E-04	-8.055E-01
1128	21	21.6	22.35	-1.016E-07	-5.610E-04	-8.055E-01
1129	22.6	36.9	22.82	-1.016E-07	-5.610E-04	-8.055E-01
1130	24.9	37.1	23.52	-1.016E-07	-5.610E-04	-8.055E-01
1131	26.9	30.8	24.15	-1.016E-07	-5.610E-04	-8.055E-01
1132	28.5	29.6	24.65	-1.016E-07	-5.610E-04	-8.055E-01
1133	29.8	23.4	25.04	-1.016E-07	-5.610E-04	-8.055E-01
1134	30.7	21.9	25.31	-1.016E-07	-5.610E-04	-8.055E-01
1135	31.8	20.3	25.65	-3.387E-08	-1.870E-04	-2.685E-01
1136	32.2	(°)	25.81	3.387E-08	1.870E-04	2.685E-01
1137	30.6	(°)	25.35	1.016E-07	5.610E-04	8.055E-01
1138	27.7	(°)	24.45	1.016E-07	5.610E-04	8.055E-01
1139	24.8	(°)	23.57	1.016E-07	5.610E-04	8.055E-01
1140	22.1	(°)	22.73	1.016E-07	5.610E-04	8.055E-01
1141	20.1	(°)	22.1	1.016E-07	5.610E-04	8.055E-01
1142	18.5	(°)	21.62	1.016E-07	5.610E-04	8.055E-01
1143	21.2	11.1	20.87	1.016E-07	5.610E-04	8.055E-01
1144	36.3	(°)	20.12	1.016E-07	5.610E-04	8.055E-01
1145	33.4	(°)	19.46	1.016E-07	5.610E-04	8.055E-01
1146	30.7	(°)	18.86	1.016E-07	5.610E-04	8.055E-01
1147	27.9	(°)	18.21	1.016E-07	5.610E-04	8.055E-01
1148	24.4	(°)	17.42	1.016E-07	5.610E-04	8.055E-01
1149	21.2	(°)	16.68	1.016E-07	5.610E-04	8.055E-01
1150	17.9	(°)	15.94	1.016E-07	5.610E-04	8.055E-01
1151	38.8	9.1	14.61	1.016E-07	5.610E-04	8.055E-01
1152	20.3	(°)	12.21	1.016E-07	5.610E-04	8.055E-01
1153	15.9	12.7	8.78	1.016E-07	5.610E-04	8.055E-01
1154	12.6	(°)	4.16	1.016E-07	5.610E-04	8.055E-01
1155	0	0	1.53	3.387E-08	1.870E-04	2.685E-01
1156	0	0	0.05	-3.387E-08	-1.870E-04	-2.685E-01
1157	0	0	0	-1.016E-07	-5.610E-04	-8.055E-01
1163	0	0	0	-1.016E-07	-5.610E-04	-8.055E-01
1164	0	0	0	1.960E-06	-2.704E-03	-3.877E-01
1165	2	7.7	0	4.021E-06	-4.848E-03	3.015E-02
1166	8.3	40.4	1.67	6.082E-06	-6.991E-03	4.480E-01
1167	34.3	17.6	3.22	6.082E-06	-6.991E-03	4.480E-01
1168	65.7	16.8	4.4	6.082E-06	-6.991E-03	4.480E-01
1169	35.6	5.8	4.25	6.082E-06	-6.991E-03	4.480E-01
1170	13.2	5.7	3.18	6.082E-06	-6.991E-03	4.480E-01
1171	0	0	2.29	6.082E-06	-6.991E-03	4.480E-01
1172	0	0	1.95	6.082E-06	-6.991E-03	4.480E-01
1173	57.3	38.8	4.02	6.082E-06	-6.991E-03	4.480E-01
1174	59.1	9.7	5.22	6.082E-06	-6.991E-03	4.480E-01
1175	63.4	29.7	5.81	6.082E-06	-6.991E-03	4.480E-01
1176	76	29.9	7.71	6.082E-06	-6.991E-03	4.480E-01
1177	24	4.9	6.89	6.082E-06	-6.991E-03	4.480E-01
1178	42.7	53.3	8.77	6.082E-06	-6.991E-03	4.480E-01
1179	81.2	36.8	12.38	6.082E-06	-6.991E-03	4.480E-01
1180	85.8	(°)	12.88	6.082E-06	-6.991E-03	4.480E-01
1181	50.4	(°)	12.56	6.082E-06	-6.991E-03	4.480E-01
1182	45.6	9.1	12.17	6.082E-06	-6.991E-03	4.480E-01
1183	57.4	46.7	13.57	6.082E-06	-6.991E-03	4.480E-01
1184	77.6	53.7	16.08	6.082E-06	-6.991E-03	4.480E-01
1185	89.2	19.2	17.59	6.082E-06	-6.991E-03	4.480E-01
1186	69.4	15.3	17.8	6.082E-06	-6.991E-03	4.480E-01
1187	56.2	36.1	18.12	6.082E-06	-6.991E-03	4.480E-01
1188	67.1	29.4	19.96	6.082E-06	-6.991E-03	4.480E-01
1189	72.5	36.6	20.86	6.082E-06	-6.991E-03	4.480E-01
1190	45.1	5.9	20.96	6.082E-06	-6.991E-03	4.480E-01
1191	41.1	43.2	21.15	6.082E-06	-6.991E-03	4.480E-01
1192	48.2	57.4	22.73	6.082E-06	-6.991E-03	4.480E-01
1193	53.6	36.3	24	6.082E-06	-6.991E-03	4.480E-01
1194	56.9	28.7	24.76	6.082E-06	-6.991E-03	4.480E-01
1195	58.6	15.2	25.16	6.082E-06	-6.991E-03	4.480E-01
1196	34	4.8	25.14	6.082E-06	-6.991E-03	4.480E-01

1197	28.5	(°)	24.67	6.082E-06	-6.991E-03	4.480E-01
1198	28.6	16.6	24.68	6.082E-06	-6.991E-03	4.480E-01
1199	28.3	2.3	24.6	5.416E-06	-6.524E-03	4.641E-01
1200	29	25.8	24.79	4.750E-06	-6.058E-03	4.802E-01
1201	29.5	20.8	24.95	4.084E-06	-5.591E-03	4.963E-01
1202	30.3	31.8	25.18	4.084E-06	-5.591E-03	4.963E-01
1203	31.7	29.4	25.6	4.084E-06	-5.591E-03	4.963E-01
1204	32.7	26.6	25.94	4.084E-06	-5.591E-03	4.963E-01
1205	33.8	20.6	26.27	4.084E-06	-5.591E-03	4.963E-01
1206	34.1	14.2	26.38	4.084E-06	-5.591E-03	4.963E-01
1207	34.3	8.5	26.45	4.084E-06	-5.591E-03	4.963E-01
1208	34.2	7.6	26.41	4.084E-06	-5.591E-03	4.963E-01
1209	34.2	15.7	26.41	4.084E-06	-5.591E-03	4.963E-01
1210	34.9	17	26.6	4.084E-06	-5.591E-03	4.963E-01
1211	35.2	14.2	26.7	4.084E-06	-5.591E-03	4.963E-01
1212	35.2	13.2	26.7	4.084E-06	-5.591E-03	4.963E-01
1213	35.2	7.2	26.72	1.361E-06	-1.864E-03	1.654E-01
1214	34.9	(°)	26.62	-1.361E-06	1.864E-03	-1.654E-01
1215	33.8	(°)	26.32	-4.084E-06	5.591E-03	-4.963E-01
1216	31.6	(°)	25.65	-4.084E-06	5.591E-03	-4.963E-01
1217	29.2	(°)	24.9	-4.084E-06	5.591E-03	-4.963E-01
1218	26.7	(°)	24.15	-4.084E-06	5.591E-03	-4.963E-01
1219	24.4	(°)	23.44	-4.084E-06	5.591E-03	-4.963E-01
1220	22.1	(°)	22.74	-4.084E-06	5.591E-03	-4.963E-01
1221	20	(°)	22.07	-4.084E-06	5.591E-03	-4.963E-01
1222	17.8	(°)	21.41	-4.084E-06	5.591E-03	-4.963E-01
1223	36.2	16.7	20.77	-4.084E-06	5.591E-03	-4.963E-01
1224	36.2	(°)	20.11	-4.084E-06	5.591E-03	-4.963E-01
1225	32.5	(°)	19.26	-4.084E-06	5.591E-03	-4.963E-01
1226	28.3	(°)	18.3	-4.084E-06	5.591E-03	-4.963E-01
1227	22.2	(°)	16.94	-4.084E-06	5.591E-03	-4.963E-01
1228	25.2	13.9	14.9	-4.084E-06	5.591E-03	-4.963E-01
1229	25.8	2	12.71	-4.084E-06	5.591E-03	-4.963E-01
1230	14.1	(°)	11.12	-4.084E-06	5.591E-03	-4.963E-01
1231	10.6	7.4	10.12	-4.084E-06	5.591E-03	-4.963E-01
1232	20.8	0.2	8.74	-4.084E-06	5.591E-03	-4.963E-01
1233	12.3	(°)	8.03	-4.084E-06	5.591E-03	-4.963E-01
1234	10.5	3.1	7.8	-4.084E-06	5.591E-03	-4.963E-01
1235	12.8	9.3	7.68	-4.084E-06	5.591E-03	-4.963E-01
1236	29.4	3.1	7.48	-1.361E-06	1.864E-03	-1.654E-01
1237	37.4	23.4	8.32	1.361E-06	-1.864E-03	1.654E-01
1238	53.5	32.7	9.8	4.084E-06	-5.591E-03	4.963E-01
1239	77.8	51.3	12.04	4.084E-06	-5.591E-03	4.963E-01
1240	80.8	31	13.87	4.084E-06	-5.591E-03	4.963E-01
1241	29.1	2.8	13.62	4.084E-06	-5.591E-03	4.963E-01
1242	38.6	63.7	15.13	4.084E-06	-5.591E-03	4.963E-01
1243	56.9	37.5	18.23	1.361E-06	-1.864E-03	1.654E-01
1244	58.8	(°)	18.63	-1.361E-06	1.864E-03	-1.654E-01
1245	55.1	(°)	18.02	-4.084E-06	5.591E-03	-4.963E-01
1246	51.3	(°)	17.37	-4.084E-06	5.591E-03	-4.963E-01
1247	47.4	(°)	16.71	-4.084E-06	5.591E-03	-4.963E-01
1248	43.4	(°)	16.04	-4.084E-06	5.591E-03	-4.963E-01
1249	38.5	(°)	15.23	-4.084E-06	5.591E-03	-4.963E-01
1250	30.4	(°)	13.88	-4.084E-06	5.591E-03	-4.963E-01
1251	19.7	(°)	12.09	-4.084E-06	5.591E-03	-4.963E-01
1252	11.8	(°)	10.75	-4.084E-06	5.591E-03	-4.963E-01
1253	29.1	16.9	10.16	-1.361E-06	1.864E-03	-1.654E-01
1254	29.1	4.3	10.12	1.361E-06	-1.864E-03	1.654E-01
1255	34.4	24.4	10.75	4.084E-06	-5.591E-03	4.963E-01
1256	46.4	34.7	12.22	4.084E-06	-5.591E-03	4.963E-01
1257	61.2	45.4	14.05	4.084E-06	-5.591E-03	4.963E-01
1258	79.1	53.2	16.27	4.084E-06	-5.591E-03	4.963E-01
1259	95.4	38.8	17.96	4.084E-06	-5.591E-03	4.963E-01
1260	54.9	2.5	17.77	4.084E-06	-5.591E-03	4.963E-01
1261	56.1	5.8	18.16	4.084E-06	-5.591E-03	4.963E-01
1262	55.1	0.8	18	4.084E-06	-5.591E-03	4.963E-01
1263	53.7	0.4	17.76	4.084E-06	-5.591E-03	4.963E-01
1264	52.2	0.1	17.51	1.361E-06	-1.864E-03	1.654E-01
1265	51.4	4.3	17.37	-1.361E-06	1.864E-03	-1.654E-01
1266	48.8	(°)	16.94	-4.084E-06	5.591E-03	-4.963E-01
1267	44.2	(°)	16.19	-4.084E-06	5.591E-03	-4.963E-01
1268	35.3	(°)	14.72	-4.084E-06	5.591E-03	-4.963E-01

1269	23.4	(°)	12.72	-4.084E-06	5.591E-03	-4.963E-01
1270	11.3	(°)	10.68	-4.084E-06	5.591E-03	-4.963E-01
1271	24.3	5.9	9.21	-4.084E-06	5.591E-03	-4.963E-01
1272	10.1	(°)	7.77	-4.084E-06	5.591E-03	-4.963E-01
1273	20	1.1	6.54	-4.084E-06	5.591E-03	-4.963E-01
1274	17.9	11.7	4.66	-4.084E-06	5.591E-03	-4.963E-01
1275	6.3	0.7	2.8	-1.361E-06	1.864E-03	-1.654E-01
1276	9.6	23.3	3.12	1.361E-06	-1.864E-03	1.654E-01
1277	33.1	16.3	4.31	4.084E-06	-5.591E-03	4.963E-01
1278	58.7	18.9	5.6	4.084E-06	-5.591E-03	4.963E-01
1279	87.6	26.5	6.99	4.084E-06	-5.591E-03	4.963E-01
1280	48.5	1.8	6.84	4.084E-06	-5.591E-03	4.963E-01
1281	74.4	41.3	8.63	4.084E-06	-5.591E-03	4.963E-01
1282	64.1	12.5	9.83	4.084E-06	-5.591E-03	4.963E-01
1283	57.1	34.6	10.14	4.084E-06	-5.591E-03	4.963E-01
1284	91	78.4	13.22	4.084E-06	-5.591E-03	4.963E-01
1285	38.6	8.5	13.95	4.084E-06	-5.591E-03	4.963E-01
1286	32.8	40	14.2	4.084E-06	-5.591E-03	4.963E-01
1287	47	74.3	16.52	4.084E-06	-5.591E-03	4.963E-01
1288	64.2	53.9	19.43	4.084E-06	-5.591E-03	4.963E-01
1289	70.4	21.4	20.54	4.084E-06	-5.591E-03	4.963E-01
1290	71.9	7.4	20.81	4.084E-06	-5.591E-03	4.963E-01
1291	39.8	2.4	20.61	4.084E-06	-5.591E-03	4.963E-01
1292	39.6	32	20.81	4.084E-06	-5.591E-03	4.963E-01
1293	42.7	24	21.52	4.084E-06	-5.591E-03	4.963E-01
1294	44.6	20.6	21.98	4.084E-06	-5.591E-03	4.963E-01
1295	47.3	31.6	22.58	4.084E-06	-5.591E-03	4.963E-01
1296	49.9	22.2	23.18	4.084E-06	-5.591E-03	4.963E-01
1297	50.7	9.1	23.38	4.084E-06	-5.591E-03	4.963E-01
1298	50.1	0.8	23.24	4.084E-06	-5.591E-03	4.963E-01
1299	49.4	4.5	23.08	4.084E-06	-5.591E-03	4.963E-01
1300	48	(°)	22.79	1.361E-06	-1.864E-03	1.654E-01
1301	46.9	1.9	22.53	-1.361E-06	1.864E-03	-1.654E-01
1302	45.9	0	22.29	-4.084E-06	5.591E-03	-4.963E-01
1303	44.2	(°)	21.93	-4.084E-06	5.591E-03	-4.963E-01
1304	42.2	(°)	21.47	-4.084E-06	5.591E-03	-4.963E-01
1305	39.1	(°)	20.77	-4.084E-06	5.591E-03	-4.963E-01
1306	33.2	(°)	19.45	-4.084E-06	5.591E-03	-4.963E-01
1307	25.5	(°)	17.72	-4.084E-06	5.591E-03	-4.963E-01
1308	16	3.5	15.24	-4.084E-06	5.591E-03	-4.963E-01
1309	27.1	(°)	12.8	-4.084E-06	5.591E-03	-4.963E-01
1310	8.7	(°)	10.26	-4.084E-06	5.591E-03	-4.963E-01
1311	11.4	5.9	7.19	-4.084E-06	5.591E-03	-4.963E-01
1312	13.8	6.7	5.46	-4.084E-06	5.591E-03	-4.963E-01
1313	14.3	(°)	4.52	-4.084E-06	5.591E-03	-4.963E-01
1314	30	14.9	4.17	-1.361E-06	1.864E-03	-1.654E-01
1315	27.8	0.3	4.06	1.361E-06	-1.864E-03	1.654E-01
1316	41.8	16.8	4.74	4.084E-06	-5.591E-03	4.963E-01
1317	68.8	20.7	6.11	4.084E-06	-5.591E-03	4.963E-01
1318	65.3	16.6	6.88	4.084E-06	-5.591E-03	4.963E-01
1319	50.9	30.1	7.04	4.084E-06	-5.591E-03	4.963E-01
1320	71.4	14.2	8.48	4.084E-06	-5.591E-03	4.963E-01
1321	65.7	16.8	8.79	4.084E-06	-5.591E-03	4.963E-01
1322	41.5	12.7	8.72	4.084E-06	-5.591E-03	4.963E-01
1323	45.3	9	9.08	1.361E-06	-1.864E-03	1.654E-01
1324	47	(°)	9.26	-1.361E-06	1.864E-03	-1.654E-01
1325	41.1	(°)	8.71	-4.084E-06	5.591E-03	-4.963E-01
1326	34.1	(°)	8.06	-4.084E-06	5.591E-03	-4.963E-01
1327	23.5	(°)	7.08	-4.084E-06	5.591E-03	-4.963E-01
1328	8.1	1.2	5.51	-4.084E-06	5.591E-03	-4.963E-01
1329	19.1	9.4	3.49	-4.084E-06	5.591E-03	-4.963E-01
1330	0	0	2.56	-4.084E-06	5.591E-03	-4.963E-01
1331	0.9	7.7	2.34	-1.361E-06	1.864E-03	-1.654E-01
1332	0.7	3.4	2.53	1.361E-06	-1.864E-03	1.654E-01
1333	0	0	2.45	4.084E-06	-5.591E-03	4.963E-01
1334	7.5	17.5	3.02	4.084E-06	-5.591E-03	4.963E-01
1335	22.4	12	3.77	4.084E-06	-5.591E-03	4.963E-01
1336	36	10.8	4.46	4.084E-06	-5.591E-03	4.963E-01
1337	48.2	6.5	5.09	1.361E-06	-1.864E-03	1.654E-01
1338	48	0.2	5.09	-1.361E-06	1.864E-03	-1.654E-01
1339	39.2	(°)	4.65	-4.084E-06	5.591E-03	-4.963E-01
1340	27.4	(°)	4.05	-4.084E-06	5.591E-03	-4.963E-01

1341	15.9	(°)	3.46	-4.084E-06	5.591E-03	-4.963E-01
1342	2	0.2	2.89	-4.084E-06	5.591E-03	-4.963E-01
1343	0.1	3.8	1.88	-4.084E-06	5.591E-03	-4.963E-01
1344	0	0	1.24	-4.084E-06	5.591E-03	-4.963E-01
1345	0	0	0	-4.084E-06	5.591E-03	-4.963E-01
1349	0	0	0	-4.084E-06	5.591E-03	-4.963E-01
1350	0	0	0	2.872E-07	7.170E-04	1.226E-01
1351	0	0	0	4.658E-06	-4.157E-03	7.415E-01
1352	1.1	6.8	0.02	9.029E-06	-9.032E-03	1.360E+00
1353	6.1	21.6	0.65	9.029E-06	-9.032E-03	1.360E+00
1354	6.4	18.5	1.96	9.029E-06	-9.032E-03	1.360E+00
1355	17.4	10.1	2.61	9.029E-06	-9.032E-03	1.360E+00
1356	30.9	7.8	3.11	9.029E-06	-9.032E-03	1.360E+00
1357	44.5	8.4	3.62	9.029E-06	-9.032E-03	1.360E+00
1358	61.1	10.5	4.24	9.029E-06	-9.032E-03	1.360E+00
1359	35.1	0.4	4.33	9.029E-06	-9.032E-03	1.360E+00
1360	52.5	23.7	5.27	9.029E-06	-9.032E-03	1.360E+00
1361	83.5	20.9	6.86	9.029E-06	-9.032E-03	1.360E+00
1362	50.3	0.8	6.89	9.029E-06	-9.032E-03	1.360E+00
1363	68	37.5	8.2	9.029E-06	-9.032E-03	1.360E+00
1364	85.5	25.2	9.88	9.029E-06	-9.032E-03	1.360E+00
1365	52.7	8.2	9.77	9.029E-06	-9.032E-03	1.360E+00
1366	73.4	39.6	11.65	9.029E-06	-9.032E-03	1.360E+00
1367	89.5	27.4	13.24	9.029E-06	-9.032E-03	1.360E+00
1368	53	6	13.1	9.029E-06	-9.032E-03	1.360E+00
1369	63.6	11.9	14.41	9.029E-06	-9.032E-03	1.360E+00
1370	65.6	12.2	14.65	7.296E-06	-7.440E-03	1.057E+00
1371	37.4	1	14.67	5.562E-06	-5.849E-03	7.534E-01
1372	38.7	40	15.19	3.829E-06	-4.257E-03	4.499E-01
1373	45.5	24.5	16.35	3.829E-06	-4.257E-03	4.499E-01
1374	49	17.2	16.95	3.829E-06	-4.257E-03	4.499E-01
1375	51.4	13.6	17.35	3.829E-06	-4.257E-03	4.499E-01
1376	52.5	7.2	17.56	3.829E-06	-4.257E-03	4.499E-01
1377	51.4	(°)	17.38	3.829E-06	-4.257E-03	4.499E-01
1378	48.9	(°)	16.96	3.829E-06	-4.257E-03	4.499E-01
1379	45.8	(°)	16.44	3.829E-06	-4.257E-03	4.499E-01
1380	42.4	(°)	15.88	3.829E-06	-4.257E-03	4.499E-01
1381	38.5	(°)	15.23	3.829E-06	-4.257E-03	4.499E-01
1382	38.6	11.6	15.22	3.829E-06	-4.257E-03	4.499E-01
1383	39.9	6.5	15.44	1.276E-06	-1.419E-03	1.500E-01
1384	39.3	2	15.34	-1.276E-06	1.419E-03	-1.500E-01
1385	37.9	(°)	15.12	-3.829E-06	4.257E-03	-4.499E-01
1386	35.1	(°)	14.65	-3.829E-06	4.257E-03	-4.499E-01
1387	32.2	(°)	14.16	-3.829E-06	4.257E-03	-4.499E-01
1388	27.3	(°)	13.35	-3.829E-06	4.257E-03	-4.499E-01
1389	18.7	(°)	11.92	-3.829E-06	4.257E-03	-4.499E-01
1390	10.4	8.1	9.91	-3.829E-06	4.257E-03	-4.499E-01
1391	14.8	4.6	7.88	-3.829E-06	4.257E-03	-4.499E-01
1392	13.2	3.6	5.88	-3.829E-06	4.257E-03	-4.499E-01
1393	13.6	8.9	3.69	-3.829E-06	4.257E-03	-4.499E-01
1394	0	0	2.44	-5.773E-06	6.214E-03	-9.832E-01
1395	0	0	2.26	-7.717E-06	8.171E-03	-1.516E+00
1396	0.5	9.5	2.01	-3.221E-06	3.376E-03	-6.833E-01
1397	5.4	7.1	1.94	3.221E-06	-3.376E-03	6.833E-01
1398	8.2	9	2.27	9.662E-06	-1.013E-02	2.050E+00
1399	21.2	10.3	2.74	9.662E-06	-1.013E-02	2.050E+00
1400	43.7	13.1	3.58	9.662E-06	-1.013E-02	2.050E+00
1401	68.2	16.2	4.51	9.662E-06	-1.013E-02	2.050E+00
1402	35.2	2	4.36	9.662E-06	-1.013E-02	2.050E+00
1403	67.5	31.5	6.02	9.662E-06	-1.013E-02	2.050E+00
1404	78.2	22.2	7.27	9.662E-06	-1.013E-02	2.050E+00
1405	54	18.5	7.27	9.662E-06	-1.013E-02	2.050E+00
1406	89.3	35.3	9.67	9.662E-06	-1.013E-02	2.050E+00
1407	54.6	0.9	9.76	9.662E-06	-1.013E-02	2.050E+00
1408	64.4	29.5	10.83	9.662E-06	-1.013E-02	2.050E+00
1409	77.2	23.7	12.04	9.662E-06	-1.013E-02	2.050E+00
1410	49	2.1	12.27	9.662E-06	-1.013E-02	2.050E+00
1411	52.1	40.4	12.93	9.662E-06	-1.013E-02	2.050E+00
1412	63.3	18.4	14.36	9.662E-06	-1.013E-02	2.050E+00
1413	62.3	(°)	14.27	9.662E-06	-1.013E-02	2.050E+00
1414	29.7	(°)	13.64	9.662E-06	-1.013E-02	2.050E+00
1415	24.2	(°)	12.82	9.662E-06	-1.013E-02	2.050E+00



1416	18.8	(°)	11.92	9.662E-06	-1.013E-02	2.050E+00
1417	14.1	(°)	11.12	9.662E-06	-1.013E-02	2.050E+00
1418	10.5	(°)	10.5	8.531E-06	-9.269E-03	1.714E+00
1419	11.3	25.6	10.63	7.400E-06	-8.410E-03	1.379E+00
1420	14.9	15.2	11.24	6.269E-06	-7.552E-03	1.044E+00
1421	12.8	(°)	10.9	6.269E-06	-7.552E-03	1.044E+00
1422	25	9.3	9.25	6.269E-06	-7.552E-03	1.044E+00
1423	18.6	9.1	8.81	6.269E-06	-7.552E-03	1.044E+00
1424	24.5	24.4	9.52	6.269E-06	-7.552E-03	1.044E+00
1425	32.7	24.2	10.54	6.269E-06	-7.552E-03	1.044E+00
1426	41.1	24.4	11.59	6.269E-06	-7.552E-03	1.044E+00
1427	50	26	12.69	6.269E-06	-7.552E-03	1.044E+00
1428	58.6	18.7	13.77	6.269E-06	-7.552E-03	1.044E+00
1429	64	25.5	14.44	6.269E-06	-7.552E-03	1.044E+00
1430	37.7	1.4	14.67	6.269E-06	-7.552E-03	1.044E+00
1431	38.4	30.5	15.15	2.090E-06	-2.517E-03	3.478E-01
1432	39.3	(°)	15.34	-2.090E-06	2.517E-03	-3.478E-01
1433	36.4	(°)	14.86	-6.269E-06	7.552E-03	-1.044E+00
1434	33.4	(°)	14.36	-6.269E-06	7.552E-03	-1.044E+00
1435	29.7	(°)	13.74	-6.269E-06	7.552E-03	-1.044E+00
1436	25.8	(°)	13.08	-6.269E-06	7.552E-03	-1.044E+00
1437	21.3	(°)	12.34	-6.269E-06	7.552E-03	-1.044E+00
1438	17.5	(°)	11.69	-6.269E-06	7.552E-03	-1.044E+00
1439	15.1	1.2	11.28	-6.269E-06	7.552E-03	-1.044E+00
1440	14.3	2.3	11.14	-6.269E-06	7.552E-03	-1.044E+00
1441	12.6	(°)	10.86	-6.269E-06	7.552E-03	-1.044E+00
1442	9.9	(°)	10.42	-6.269E-06	7.552E-03	-1.044E+00
1443	27.4	13.6	9.89	-6.269E-06	7.552E-03	-1.044E+00
1444	23	(°)	9.37	-6.269E-06	7.552E-03	-1.044E+00
1445	20.8	3.5	9.09	-6.269E-06	7.552E-03	-1.044E+00
1446	20.5	5.3	9.05	-6.269E-06	7.552E-03	-1.044E+00
1447	18.5	(°)	8.8	-6.269E-06	7.552E-03	-1.044E+00
1448	11.9	(°)	8	-6.269E-06	7.552E-03	-1.044E+00
1449	22.4	6.1	6.71	-6.269E-06	7.552E-03	-1.044E+00
1450	10	8.7	5.21	-6.269E-06	7.552E-03	-1.044E+00
1451	6.7	0.6	2.72	-6.269E-06	7.552E-03	-1.044E+00
1452	0	0	0.95	-6.269E-06	7.552E-03	-1.044E+00
1453	0	0	0	-6.269E-06	7.552E-03	-1.044E+00
1454	0	0	0	-6.269E-06	7.552E-03	-1.044E+00
1455	0	0	0	-1.593E-06	2.190E-03	-8.036E-01
1456	0	0	0	3.083E-06	-3.171E-03	-5.636E-01
1457	0	0	0	7.759E-06	-8.533E-03	-3.236E-01
1518	0	0	0	7.759E-06	-8.533E-03	-3.236E-01
1519	5.1	15	0.14	7.759E-06	-8.533E-03	-3.236E-01
1520	7	25.8	1.71	7.759E-06	-8.533E-03	-3.236E-01
1521	18.1	9.5	2.64	7.759E-06	-8.533E-03	-3.236E-01
1522	28.4	7.1	3.02	7.759E-06	-8.533E-03	-3.236E-01
1523	44.9	9.8	3.64	7.759E-06	-8.533E-03	-3.236E-01
1524	57.8	6.7	4.13	7.759E-06	-8.533E-03	-3.236E-01
1525	33.6	4.5	4.17	7.759E-06	-8.533E-03	-3.236E-01
1526	37.9	12.1	4.56	7.759E-06	-8.533E-03	-3.236E-01
1527	48.5	6.2	5.11	2.586E-06	-2.844E-03	-1.079E-01
1528	49.9	1.3	5.19	-2.586E-06	2.844E-03	1.079E-01
1529	42.5	(°)	4.82	-7.759E-06	8.533E-03	3.236E-01
1530	30.4	(°)	4.2	-7.759E-06	8.533E-03	3.236E-01
1531	18.7	(°)	3.61	-7.759E-06	8.533E-03	3.236E-01
1532	4	0.9	2.85	-7.759E-06	8.533E-03	3.236E-01
1533	0.1	3.9	1.94	-7.759E-06	8.533E-03	3.236E-01
1534	0	0	1.16	-2.586E-06	2.844E-03	1.079E-01
1535	0	0	0	2.586E-06	-2.844E-03	-1.079E-01
1536	0	0	0	7.759E-06	-8.533E-03	-3.236E-01
1560	0	0	0	7.759E-06	-8.533E-03	-3.236E-01
1561	3	5	0	7.759E-06	-8.533E-03	-3.236E-01
1562	7	10	0	7.759E-06	-8.533E-03	-3.236E-01
1563	4.7	8.1	0.62	7.759E-06	-8.533E-03	-3.236E-01
1564	2	6.4	1.04	7.759E-06	-8.533E-03	-3.236E-01
1565	6.2	11.6	1.54	7.759E-06	-8.533E-03	-3.236E-01
1566	8.6	8.9	2.49	7.759E-06	-8.533E-03	-3.236E-01
1567	20.7	5.2	2.98	7.759E-06	-8.533E-03	-3.236E-01
1568	28	1.9	3.28	2.586E-06	-2.844E-03	-1.079E-01
1569	25.6	(°)	3.19	-2.586E-06	2.844E-03	1.079E-01
1570	14.9	(°)	2.75	-7.759E-06	8.533E-03	3.236E-01

1571	0	0	1.3	-2.586E-06	2.844E-03	1.079E-01
1572	0	0	0	2.586E-06	-2.844E-03	-1.079E-01
1573	1.2	6.5	0.05	7.759E-06	-8.533E-03	-3.236E-01
1574	6.8	23.2	1.12	7.759E-06	-8.533E-03	-3.236E-01
1575	16.6	14.1	2.81	7.759E-06	-8.533E-03	-3.236E-01
1576	52.5	14.5	4.24	7.759E-06	-8.533E-03	-3.236E-01
1577	76.9	22.6	5.6	7.759E-06	-8.533E-03	-3.236E-01
1578	52.1	12.3	5.96	7.759E-06	-8.533E-03	-3.236E-01
1579	94.5	27.6	8.32	7.759E-06	-8.533E-03	-3.236E-01
1580	56.4	1	8.63	7.759E-06	-8.533E-03	-3.236E-01
1581	66	5.3	9.37	2.586E-06	-2.844E-03	-1.079E-01
1582	49.2	6.7	9.62	-2.586E-06	2.844E-03	1.079E-01
1583	31.3	( <sup>o</sup> )	9.11	-7.759E-06	8.533E-03	3.236E-01
1584	22.1	( <sup>o</sup> )	8.11	-7.759E-06	8.533E-03	3.236E-01
1585	12.1	( <sup>o</sup> )	7.01	-7.759E-06	8.533E-03	3.236E-01
1586	27.3	8.2	6.04	-7.759E-06	8.533E-03	3.236E-01
1587	16	( <sup>o</sup> )	5.42	-2.586E-06	2.844E-03	1.079E-01
1588	17.4	10.5	5.5	2.586E-06	-2.844E-03	-1.079E-01
1589	33.7	15.4	6.79	7.759E-06	-8.533E-03	-3.236E-01
1590	43.6	( <sup>o</sup> )	7.61	7.759E-06	-8.533E-03	-3.236E-01
1591	37.7	( <sup>o</sup> )	7.15	7.759E-06	-8.533E-03	-3.236E-01
1592	34.8	6.5	6.89	7.759E-06	-8.533E-03	-3.236E-01
1593	60.7	30.4	8.88	7.759E-06	-8.533E-03	-3.236E-01
1594	90.6	21.4	11.28	7.759E-06	-8.533E-03	-3.236E-01
1595	54.9	( <sup>o</sup> )	11.48	7.759E-06	-8.533E-03	-3.236E-01
1596	48.4	( <sup>o</sup> )	10.97	7.759E-06	-8.533E-03	-3.236E-01
1597	56.5	19.6	11.78	7.759E-06	-8.533E-03	-3.236E-01
1598	72	21.8	13.47	7.759E-06	-8.533E-03	-3.236E-01
1599	85.8	26.9	14.92	7.759E-06	-8.533E-03	-3.236E-01
1600	32.2	2.2	15.21	7.759E-06	-8.533E-03	-3.236E-01
1601	42.2	31.8	17.03	7.759E-06	-8.533E-03	-3.236E-01
1602	46.5	1.9	17.89	7.759E-06	-8.533E-03	-3.236E-01
1603	57.8	21.7	19.09	2.586E-06	-2.844E-03	-1.079E-01
1604	37.1	4.8	19.37	-2.586E-06	2.844E-03	1.079E-01
1605	36.7	( <sup>o</sup> )	19.31	-7.759E-06	8.533E-03	3.236E-01
1606	32.8	( <sup>o</sup> )	18.5	-7.759E-06	8.533E-03	3.236E-01
1607	27.8	( <sup>o</sup> )	17.4	-7.759E-06	8.533E-03	3.236E-01
1608	22.8	( <sup>o</sup> )	16.33	-7.759E-06	8.533E-03	3.236E-01
1609	16.5	( <sup>o</sup> )	14.97	-7.759E-06	8.533E-03	3.236E-01
1610	10.3	7.6	12.74	-7.759E-06	8.533E-03	3.236E-01
1611	12.8	6.4	10.27	-7.759E-06	8.533E-03	3.236E-01
1612	30.4	11.4	8.67	-7.759E-06	8.533E-03	3.236E-01
1613	12.4	( <sup>o</sup> )	7.07	-7.992E-06	8.661E-03	1.236E+00
1614	0	0	4.45	-8.224E-06	8.788E-03	2.148E+00
1615	1.1	1.4	3.71	-2.819E-06	2.972E-03	1.020E+00
1616	43.1	4.2	5.47	2.819E-06	-2.972E-03	-1.020E+00
1617	54.9	6.5	6.15	8.457E-06	-8.916E-03	-3.061E+00
1618	74.6	17.4	7.24	8.457E-06	-8.916E-03	-3.061E+00
1619	52.3	1.4	8.08	8.457E-06	-8.916E-03	-3.061E+00
1620	67.1	23.5	9.41	8.457E-06	-8.916E-03	-3.061E+00
1621	79.1	1.9	10.43	2.819E-06	-2.972E-03	-1.020E+00
1622	46.4	( <sup>o</sup> )	10.52	-2.819E-06	2.972E-03	1.020E+00
1623	39	( <sup>o</sup> )	9.95	-8.457E-06	8.916E-03	3.061E+00
1624	28.8	( <sup>o</sup> )	8.85	-8.457E-06	8.916E-03	3.061E+00
1625	16.6	( <sup>o</sup> )	7.52	-8.457E-06	8.916E-03	3.061E+00
1626	20.1	14.2	6.17	-8.457E-06	8.916E-03	3.061E+00
1627	15.4	( <sup>o</sup> )	5.37	-2.819E-06	2.972E-03	1.020E+00
1628	17.1	10.6	5.48	2.819E-06	-2.972E-03	-1.020E+00
1629	40.8	26.5	7.31	8.457E-06	-8.916E-03	-3.061E+00
1630	69.8	18.3	9.64	8.457E-06	-8.916E-03	-3.061E+00
1631	85.7	13.1	10.91	8.457E-06	-8.916E-03	-3.061E+00
1632	51.9	1.7	11.25	8.457E-06	-8.916E-03	-3.061E+00
1633	72.1	42.7	13.42	8.457E-06	-8.916E-03	-3.061E+00
1634	84.4	29.2	15.77	8.457E-06	-8.916E-03	-3.061E+00
1635	35.6	( <sup>o</sup> )	15.91	8.457E-06	-8.916E-03	-3.061E+00
1636	40.5	30.3	16.73	8.457E-06	-8.916E-03	-3.061E+00
1637	52.7	44.5	18.91	8.457E-06	-8.916E-03	-3.061E+00
1638	65.4	19.1	21.27	2.819E-06	-2.972E-03	-1.020E+00
1639	67.1	( <sup>o</sup> )	21.64	-2.819E-06	2.972E-03	1.020E+00
1640	34	( <sup>o</sup> )	21.56	-8.457E-06	8.916E-03	3.061E+00
1641	31.3	( <sup>o</sup> )	21.28	-8.457E-06	8.916E-03	3.061E+00
1642	29.3	( <sup>o</sup> )	20.79	-8.457E-06	8.916E-03	3.061E+00

1643	25.4	(°)	19.83	-8.457E-06	8.916E-03	3.061E+00
1644	19.9	(°)	18.43	-8.457E-06	8.916E-03	3.061E+00
1645	23	5.7	16.06	-8.457E-06	8.916E-03	3.061E+00
1646	8.9	5.7	12.52	-8.457E-06	8.916E-03	3.061E+00
1647	12.4	7.5	8.98	-8.457E-06	8.916E-03	3.061E+00
1648	16.5	2.7	7.22	-8.457E-06	8.916E-03	3.061E+00
1649	25	10.8	5.92	-8.457E-06	8.916E-03	3.061E+00
1650	16.3	4.1	5.43	-2.819E-06	2.972E-03	1.020E+00
1651	41.5	28.9	7.37	2.819E-06	-2.972E-03	-1.020E+00
1652	82.3	43.6	10.55	8.457E-06	-8.916E-03	-3.061E+00
1653	56.9	0.2	11.66	8.457E-06	-8.916E-03	-3.061E+00
1654	70.1	45.2	13.2	8.457E-06	-8.916E-03	-3.061E+00
1655	72.7	29.1	15.78	8.457E-06	-8.916E-03	-3.061E+00
1656	36.9	16.9	16.11	8.457E-06	-8.916E-03	-3.061E+00
1657	42.7	(°)	17.2	2.819E-06	-2.972E-03	-1.020E+00
1658	41.3	(°)	16.96	-2.819E-06	2.972E-03	1.020E+00
1659	37.7	(°)	16.32	-8.457E-06	8.916E-03	3.061E+00
1660	34.5	(°)	15.73	-8.457E-06	8.916E-03	3.061E+00
1661	27	(°)	14.41	-8.457E-06	8.916E-03	3.061E+00
1662	15	(°)	12.23	-8.457E-06	8.916E-03	3.061E+00
1663	11.6	0.1	9.56	-8.457E-06	8.916E-03	3.061E+00
1664	10	(°)	6.48	-8.457E-06	8.916E-03	3.061E+00
1665	15.6	9.8	3.7	-8.457E-06	8.916E-03	3.061E+00
1666	0	0	0.19	-8.457E-06	8.916E-03	3.061E+00
1667	0	0	0	-8.457E-06	8.916E-03	3.061E+00
1668	0	0	0	1.191E-06	-1.811E-04	2.220E+00
1669	0	0	0	1.084E-05	-9.278E-03	1.379E+00
1670	0	0	0	2.049E-05	-1.837E-02	5.378E-01
1678	0	0	0	2.049E-05	-1.837E-02	5.378E-01
1679	1.4	7.2	0.05	2.049E-05	-1.837E-02	5.378E-01
1680	6.6	22.6	0.85	2.049E-05	-1.837E-02	5.378E-01
1681	16.2	15.4	2.8	2.049E-05	-1.837E-02	5.378E-01
1682	59.1	19.5	4.49	2.049E-05	-1.837E-02	5.378E-01
1683	67.4	17.1	5.91	2.049E-05	-1.837E-02	5.378E-01
1684	62.3	17.7	6.54	2.049E-05	-1.837E-02	5.378E-01
1685	77.8	11.5	7.55	2.049E-05	-1.837E-02	5.378E-01
1686	41.8	(°)	7.48	2.049E-05	-1.837E-02	5.378E-01
1687	35.9	(°)	7	2.049E-05	-1.837E-02	5.378E-01
1688	39.3	0.2	7.27	6.829E-06	-6.125E-03	1.793E-01
1689	34.3	(°)	6.88	-6.829E-06	6.125E-03	-1.793E-01
1690	9.5	3.5	4.95	-6.829E-06	6.125E-03	-1.793E-01
1691	0	0	0	6.829E-06	-6.125E-03	1.793E-01
1692	0	0	0	2.049E-05	-1.837E-02	5.378E-01
1693	0	0	0	2.049E-05	-1.837E-02	5.378E-01
1694	0.5	6.5	0.15	2.049E-05	-1.837E-02	5.378E-01
1695	3.6	6.9	0.57	2.049E-05	-1.837E-02	5.378E-01
1696	5.4	9.3	1.14	2.049E-05	-1.837E-02	5.378E-01
1697	5.5	6.2	1.71	2.049E-05	-1.837E-02	5.378E-01
1698	3.1	3.5	2.03	2.049E-05	-1.837E-02	5.378E-01
1699	0	0	2.12	2.049E-05	-1.837E-02	5.378E-01
1700	0	0	1.59	2.049E-05	-1.837E-02	5.378E-01
1701	0	0	0	2.049E-05	-1.837E-02	5.378E-01
1702	3.1	7.4	0.27	2.049E-05	-1.837E-02	5.378E-01
1703	6.8	20.3	1.79	2.049E-05	-1.837E-02	5.378E-01
1704	24.6	12.8	3.14	2.049E-05	-1.837E-02	5.378E-01
1705	64.5	18.2	4.72	2.049E-05	-1.837E-02	5.378E-01
1706	53.8	7.7	5.69	2.049E-05	-1.837E-02	5.378E-01
1707	66.6	27.9	6.75	2.049E-05	-1.837E-02	5.378E-01
1708	72.2	18.5	8.42	2.049E-05	-1.837E-02	5.378E-01
1709	63.5	31.1	9.1	2.049E-05	-1.837E-02	5.378E-01
1710	94.7	29.7	11.46	2.049E-05	-1.837E-02	5.378E-01
1711	55.9	2.1	11.77	2.049E-05	-1.837E-02	5.378E-01
1712	82.9	60.8	14.55	2.049E-05	-1.837E-02	5.378E-01
1713	39.6	4.9	15.87	6.829E-06	-6.125E-03	1.793E-01
1714	38.7	4.2	16.46	-6.829E-06	6.125E-03	-1.793E-01
1715	37.4	(°)	16.26	-2.049E-05	1.837E-02	-5.378E-01
1716	32.9	(°)	15.46	-2.049E-05	1.837E-02	-5.378E-01
1717	27.7	(°)	14.51	-2.049E-05	1.837E-02	-5.378E-01
1718	23.1	(°)	13.67	-2.049E-05	1.837E-02	-5.378E-01
1719	17.1	(°)	12.6	-2.049E-05	1.837E-02	-5.378E-01
1720	9.1	6.4	10.02	-1.891E-05	1.685E-02	4.276E-01
1721	10.6	3	6.37	-6.829E-06	6.125E-03	-1.793E-01

1722	37.5	15.4	7.09	5.248E-06	-4.601E-03	-7.862E-01
1723	73.5	38.4	9.87	1.574E-05	-1.380E-02	-2.358E+00
1724	87.7	20.1	11.51	1.574E-05	-1.380E-02	-2.358E+00
1725	56.6	5.6	11.83	1.574E-05	-1.380E-02	-2.358E+00
1726	85.3	41.3	14.86	1.574E-05	-1.380E-02	-2.358E+00
1727	41.9	7.1	15.88	1.574E-05	-1.380E-02	-2.358E+00
1728	40.7	38.8	16.75	1.574E-05	-1.380E-02	-2.358E+00
1729	51.4	13	18.75	1.574E-05	-1.380E-02	-2.358E+00
1730	51.6	( <sup>o</sup> )	18.82	1.574E-05	-1.380E-02	-2.358E+00
1731	33.9	( <sup>o</sup> )	18.77	1.574E-05	-1.380E-02	-2.358E+00
1732	34	( <sup>o</sup> )	18.71	1.574E-05	-1.380E-02	-2.358E+00
1733	35	1.8	18.92	1.574E-05	-1.380E-02	-2.358E+00
1734	35.6	( <sup>o</sup> )	19.07	5.248E-06	-4.601E-03	-7.862E-01
1735	33.9	( <sup>o</sup> )	18.71	-5.248E-06	4.601E-03	7.862E-01
1736	30.3	( <sup>o</sup> )	17.95	-1.574E-05	1.380E-02	2.358E+00
1737	25.8	( <sup>o</sup> )	16.97	-1.574E-05	1.380E-02	2.358E+00
1738	21	( <sup>o</sup> )	15.93	-1.574E-05	1.380E-02	2.358E+00
1739	16.3	( <sup>o</sup> )	14.9	-1.574E-05	1.380E-02	2.358E+00
1740	11.5	( <sup>o</sup> )	13.86	-1.574E-05	1.380E-02	2.358E+00
1741	18.5	5.5	12.45	-1.722E-05	1.520E-02	1.428E+00
1742	12.4	8.2	10.28	-1.870E-05	1.660E-02	4.983E-01
1743	24.2	7.3	7.92	-2.018E-05	1.800E-02	-4.318E-01
1744	17	6.9	5.23	-2.018E-05	1.800E-02	-4.318E-01
1745	21.2	11.5	4.36	-6.726E-06	6.000E-03	-1.439E-01
1746	52.4	26	5.94	6.726E-06	-6.000E-03	1.439E-01
1747	89.6	29.8	8.35	2.018E-05	-1.800E-02	4.318E-01
1748	57.8	11.2	8.7	2.018E-05	-1.800E-02	4.318E-01
1749	97.7	41.2	11.46	2.018E-05	-1.800E-02	4.318E-01
1750	55.9	( <sup>o</sup> )	11.77	2.018E-05	-1.800E-02	4.318E-01
1751	80.7	31.1	14.39	2.018E-05	-1.800E-02	4.318E-01
1752	71.6	28.9	15.8	2.018E-05	-1.800E-02	4.318E-01
1753	37	17	16.13	2.018E-05	-1.800E-02	4.318E-01
1754	41.1	7.7	16.88	2.018E-05	-1.800E-02	4.318E-01
1755	44.3	7.3	17.47	2.018E-05	-1.800E-02	4.318E-01
1756	46.7	( <sup>o</sup> )	17.93	2.018E-05	-1.800E-02	4.318E-01
1757	30.6	( <sup>o</sup> )	17.61	2.018E-05	-1.800E-02	4.318E-01
1758	24.8	( <sup>o</sup> )	16.74	2.018E-05	-1.800E-02	4.318E-01
1759	21.2	( <sup>o</sup> )	15.93	2.018E-05	-1.800E-02	4.318E-01
1760	21.2	4.1	15.91	2.018E-05	-1.800E-02	4.318E-01
1761	23.4	2.4	16.39	6.726E-06	-6.000E-03	1.439E-01
1762	23.4	( <sup>o</sup> )	16.42	-6.726E-06	6.000E-03	-1.439E-01
1763	19.7	( <sup>o</sup> )	15.63	-2.018E-05	1.800E-02	-4.318E-01
1764	13.8	( <sup>o</sup> )	14.36	-2.018E-05	1.800E-02	-4.318E-01
1765	12.6	9.7	12.98	-2.018E-05	1.800E-02	-4.318E-01
1766	12.5	( <sup>o</sup> )	11.75	-2.018E-05	1.800E-02	-4.318E-01
1767	15.5	10.3	10.96	-2.018E-05	1.800E-02	-4.318E-01
1768	12.4	( <sup>o</sup> )	9.99	-2.018E-05	1.800E-02	-4.318E-01
1769	23.1	7.5	7.76	-2.018E-05	1.800E-02	-4.318E-01
1770	20.1	7.4	5.51	-2.018E-05	1.800E-02	-4.318E-01
1771	17.8	5.9	3.84	-6.726E-06	6.000E-03	-1.439E-01
1772	0	0	2.83	-3.978E-06	4.119E-04	-8.900E-02
1773	0.3	4.2	2.6	-1.229E-06	-5.176E-03	-3.405E-02
1774	4.6	13.8	3.25	-1.193E-05	1.236E-03	-2.670E-01
1775	30.1	18.8	4.69	-1.193E-05	1.236E-03	-2.670E-01
1776	65.5	20.4	6.71	-1.193E-05	1.236E-03	-2.670E-01
1777	82.3	18	8.02	-1.193E-05	1.236E-03	-2.670E-01
1778	49	( <sup>o</sup> )	8.05	-1.193E-05	1.236E-03	-2.670E-01
1779	42.4	( <sup>o</sup> )	7.53	-1.193E-05	1.236E-03	-2.670E-01
1780	34.8	( <sup>o</sup> )	6.92	-1.193E-05	1.236E-03	-2.670E-01
1781	29.4	( <sup>o</sup> )	6.48	-1.193E-05	1.236E-03	-2.670E-01
1782	25.5	( <sup>o</sup> )	6.17	-1.193E-05	1.236E-03	-2.670E-01
1783	22.5	( <sup>o</sup> )	5.93	-1.193E-05	1.236E-03	-2.670E-01
1784	18.6	( <sup>o</sup> )	5.63	-1.193E-05	1.236E-03	-2.670E-01
1785	13.6	( <sup>o</sup> )	5.22	-1.193E-05	1.236E-03	-2.670E-01
1786	12	9.3	4.97	-1.193E-05	1.236E-03	-2.670E-01
1787	41.9	( <sup>o</sup> )	5.43	-1.193E-05	1.236E-03	-2.670E-01
1788	35.6	( <sup>o</sup> )	5.06	-1.193E-05	1.236E-03	-2.670E-01
1789	37.1	2	5.14	-1.193E-05	1.236E-03	-2.670E-01
1790	39.1	0.7	5.25	-1.193E-05	1.236E-03	-2.670E-01
1791	41.4	2	5.38	-1.193E-05	1.236E-03	-2.670E-01
1792	42.3	( <sup>o</sup> )	5.44	-1.193E-05	1.236E-03	-2.670E-01
1793	39	( <sup>o</sup> )	5.26	-1.193E-05	1.236E-03	-2.670E-01

1794	36.5	0.4	5.1	-1.193E-05	1.236E-03	-2.670E-01
1795	40.6	4.2	5.33	-1.193E-05	1.236E-03	-2.670E-01
1796	49.4	4.5	5.84	-1.193E-05	1.236E-03	-2.670E-01
1797	55	1	6.17	-1.193E-05	1.236E-03	-2.670E-01
1798	53	(°)	6.06	-1.193E-05	1.236E-03	-2.670E-01
1799	48.6	(°)	5.81	-1.193E-05	1.236E-03	-2.670E-01
1800	49.8	3.9	5.86	-1.193E-05	1.236E-03	-2.670E-01
1801	60.1	4.3	6.45	-1.193E-05	1.236E-03	-2.670E-01
1802	59.2	12.8	6.71	-3.978E-06	4.119E-04	-8.900E-02
1803	35.1	(°)	6.94	3.978E-06	-4.119E-04	8.900E-02
1804	29.4	(°)	6.49	1.193E-05	-1.236E-03	2.670E-01
1805	23.2	(°)	5.99	1.193E-05	-1.236E-03	2.670E-01
1806	13.8	(°)	5.25	1.193E-05	-1.236E-03	2.670E-01
1807	20.3	7.8	3.96	1.193E-05	-1.236E-03	2.670E-01
1808	0	0	3.07	1.193E-05	-1.236E-03	2.670E-01
1809	0	0	2.21	1.193E-05	-1.236E-03	2.670E-01
1810	0	0	0.78	3.978E-06	-4.119E-04	8.900E-02
1811	7.1	19.8	1.71	-3.978E-06	4.119E-04	-8.900E-02
1812	19.5	10.8	2.93	-1.193E-05	1.236E-03	-2.670E-01
1813	43.5	8.5	3.89	-1.193E-05	1.236E-03	-2.670E-01
1814	61.5	5.7	4.64	-1.193E-05	1.236E-03	-2.670E-01
1815	39.7	5.8	4.98	-1.193E-05	1.236E-03	-2.670E-01
1816	33.9	(°)	4.96	-1.193E-05	1.236E-03	-2.670E-01
1817	33	1.1	4.9	-1.193E-05	1.236E-03	-2.670E-01
1818	37.8	3.2	5.17	-1.193E-05	1.236E-03	-2.670E-01
1819	36.2	(°)	5.1	-1.193E-05	1.236E-03	-2.670E-01
1820	36.4	2.4	5.09	-1.193E-05	1.236E-03	-2.670E-01
1821	44	5.4	5.52	-1.193E-05	1.236E-03	-2.670E-01
1822	49	0.9	5.82	-1.193E-05	1.236E-03	-2.670E-01
1823	52.2	2.6	6.01	-1.193E-05	1.236E-03	-2.670E-01
1824	55.4	1.1	6.19	-1.193E-05	1.236E-03	-2.670E-01
1825	58.4	2.2	6.36	-1.193E-05	1.236E-03	-2.670E-01
1826	66.4	9.6	6.81	-1.193E-05	1.236E-03	-2.670E-01
1827	37.6	1.9	7.12	-1.193E-05	1.236E-03	-2.670E-01
1828	37.6	(°)	7.12	-1.193E-05	1.236E-03	-2.670E-01
1829	39.3	1.9	7.26	-1.193E-05	1.236E-03	-2.670E-01
1830	42.6	2.4	7.52	-1.193E-05	1.236E-03	-2.670E-01
1831	44.4	0.2	7.66	-1.193E-05	1.236E-03	-2.670E-01
1832	45.7	0.9	7.77	-1.193E-05	1.236E-03	-2.670E-01
1833	48	1	7.95	-3.978E-06	4.119E-04	-8.900E-02
1834	45	(°)	7.73	3.978E-06	-4.119E-04	8.900E-02
1835	38.7	(°)	7.23	1.193E-05	-1.236E-03	2.670E-01
1836	32.8	(°)	6.76	1.193E-05	-1.236E-03	2.670E-01
1837	25.6	(°)	6.2	1.193E-05	-1.236E-03	2.670E-01
1838	4.9	0.8	4.18	3.978E-06	-4.119E-04	8.900E-02
1839	0.1	3.9	0	-3.978E-06	4.119E-04	-8.900E-02
1840	0	0	0	-1.193E-05	1.236E-03	-2.670E-01
1852	0	0	0	-1.193E-05	1.236E-03	-2.670E-01
1853	1	6.7	0.15	-1.193E-05	1.236E-03	-2.670E-01
1854	6.8	21.9	1.3	-1.193E-05	1.236E-03	-2.670E-01
1855	17.1	11.1	2.83	-1.193E-05	1.236E-03	-2.670E-01
1856	35	5.6	3.56	-1.193E-05	1.236E-03	-2.670E-01
1857	35.7	(°)	3.61	-1.193E-05	1.236E-03	-2.670E-01
1858	21.8	(°)	3.05	-1.193E-05	1.236E-03	-2.670E-01
1859	0	0	1.16	-1.193E-05	1.236E-03	-2.670E-01
1860	0	0	0	-1.193E-05	1.236E-03	-2.670E-01
1865	0	0	0	-1.193E-05	1.236E-03	-2.670E-01
1866	2.5	6.8	0.17	-1.193E-05	1.236E-03	-2.670E-01
1867	5.6	12.3	1.42	-1.193E-05	1.236E-03	-2.670E-01
1868	4.4	4.8	1.97	-1.193E-05	1.236E-03	-2.670E-01
1869	0	0	1.94	-1.193E-05	1.236E-03	-2.670E-01
1870	0	0	0.16	-1.193E-05	1.236E-03	-2.670E-01
1871	0	0	0	-1.193E-05	1.236E-03	-2.670E-01
1872	1.6	6.5	0.17	-1.193E-05	1.236E-03	-2.670E-01
1873	5.1	9.6	1.08	-1.193E-05	1.236E-03	-2.670E-01
1874	3.4	5.8	1.54	-1.193E-05	1.236E-03	-2.670E-01
1875	0	0	1.56	-1.193E-05	1.236E-03	-2.670E-01
1876	0	0	0	-1.193E-05	1.236E-03	-2.670E-01
1878	0	0	0	-1.193E-05	1.236E-03	-2.670E-01
1879	1.3	6.6	0.18	-1.193E-05	1.236E-03	-2.670E-01
1880	4.8	7.7	0.88	-1.193E-05	1.236E-03	-2.670E-01
1881	0.8	5.4	1.29	-1.193E-05	1.236E-03	-2.670E-01

1882	0	0	1.67	-1.193E-05	1.236E-03	-2.670E-01
1883	0.3	4.4	2.01	-1.193E-05	1.236E-03	-2.670E-01
1884	0	0	2.09	-1.193E-05	1.236E-03	-2.670E-01
1885	0	0	2.14	-1.193E-05	1.236E-03	-2.670E-01
1886	0	0	2.12	-1.193E-05	1.236E-03	-2.670E-01
1887	0	0	1.9	-1.193E-05	1.236E-03	-2.670E-01
1888	0	0	0.4	-1.193E-05	1.236E-03	-2.670E-01
1889	0	0	0	-1.193E-05	1.236E-03	-2.670E-01
1899	0	0	0	-1.193E-05	1.236E-03	-2.670E-01
1900	0	0	0	-7.980E-06	-5.261E-04	6.348E-01
1901	0	0	0	-4.026E-06	-2.288E-03	1.537E+00
1902	0	0	0	-7.340E-08	-4.050E-03	2.438E+00
2135	0	0	0	-7.340E-08	-4.050E-03	2.438E+00
2136	51.7	18.5	4.1	-7.340E-08	-4.050E-03	2.438E+00
2137	10.6	6.5	3.04	-7.340E-08	-4.050E-03	2.438E+00
2138	0	0	2.62	-7.340E-08	-4.050E-03	2.438E+00
2139	18.6	7.7	3.59	-7.340E-08	-4.050E-03	2.438E+00
2140	6.2	0.7	2.95	-7.340E-08	-4.050E-03	2.438E+00
2141	0	0	0	-7.340E-08	-4.050E-03	2.438E+00
2167	0	0	0	-7.340E-08	-4.050E-03	2.438E+00
2168	7.1	34.5	0.61	-7.340E-08	-4.050E-03	2.438E+00
2169	10.6	19.6	2.34	-7.340E-08	-4.050E-03	2.438E+00
2170	29.3	11.2	3.07	-7.340E-08	-4.050E-03	2.438E+00
2171	41.5	3.5	3.52	-7.340E-08	-4.050E-03	2.438E+00
2172	37	(°)	3.36	-7.340E-08	-4.050E-03	2.438E+00
2173	22.1	(°)	2.8	-7.340E-08	-4.050E-03	2.438E+00
2174	2.6	0.5	1.82	-7.340E-08	-4.050E-03	2.438E+00
2175	0.1	2.5	0	-7.340E-08	-4.050E-03	2.438E+00
2176	8.3	41.2	1.26	-7.340E-08	-4.050E-03	2.438E+00
2177	27	19.8	2.97	-7.340E-08	-4.050E-03	2.438E+00
2178	48.7	11.1	3.78	-7.340E-08	-4.050E-03	2.438E+00
2179	61.9	9.8	4.28	-7.340E-08	-4.050E-03	2.438E+00
2180	30.5	2.3	4.11	-7.340E-08	-4.050E-03	2.438E+00
2181	25.4	(°)	3.95	-7.340E-08	-4.050E-03	2.438E+00
2182	5.8	0.5	2.82	-7.340E-08	-4.050E-03	2.438E+00
2183	0	0	0	-7.340E-08	-4.050E-03	2.438E+00
2192	0	0	0	-7.340E-08	-4.050E-03	2.438E+00
2193	0.9	7.1	0.05	-7.340E-08	-4.050E-03	2.438E+00
2194	8.1	40.6	1.58	-7.340E-08	-4.050E-03	2.438E+00
2195	27.4	18.8	2.99	-7.340E-08	-4.050E-03	2.438E+00
2196	46.8	10	3.71	-7.340E-08	-4.050E-03	2.438E+00
2197	54.8	2	4.02	-7.340E-08	-4.050E-03	2.438E+00
2198	54.2	1.2	4	-7.340E-08	-4.050E-03	2.438E+00
2199	50.7	2.7	3.87	-7.340E-08	-4.050E-03	2.438E+00
2200	50.4	4.4	3.85	-7.340E-08	-4.050E-03	2.438E+00
2201	53.4	4	3.97	-7.340E-08	-4.050E-03	2.438E+00
2202	56.1	3.1	4.07	-7.340E-08	-4.050E-03	2.438E+00
2203	34.8	6.4	4.13	-7.340E-08	-4.050E-03	2.438E+00
2204	31.5	2.3	4.25	-7.340E-08	-4.050E-03	2.438E+00
2205	32.1	2.4	4.28	-7.340E-08	-4.050E-03	2.438E+00
2206	31.4	2.7	4.24	-7.340E-08	-4.050E-03	2.438E+00
2207	31.4	2.4	4.24	-7.340E-08	-4.050E-03	2.438E+00
2208	32.5	2.3	4.3	-7.340E-08	-4.050E-03	2.438E+00
2209	31.8	1.5	4.27	-7.340E-08	-4.050E-03	2.438E+00
2210	29.8	(°)	4.17	-7.340E-08	-4.050E-03	2.438E+00
2211	21.4	(°)	3.74	-7.340E-08	-4.050E-03	2.438E+00
2212	8.8	0.5	3.11	-7.340E-08	-4.050E-03	2.438E+00
2213	0	0	0	-7.340E-08	-4.050E-03	2.438E+00
2222	0	0	0	-7.340E-08	-4.050E-03	2.438E+00
2223	3.6	10.8	0.05	-7.340E-08	-4.050E-03	2.438E+00
2224	6.7	25.7	1.52	-7.340E-08	-4.050E-03	2.438E+00
2225	14.1	13.6	2.48	-7.340E-08	-4.050E-03	2.438E+00
2226	27.4	8	3	-7.340E-08	-4.050E-03	2.438E+00
2227	44	10.3	3.6	-7.340E-08	-4.050E-03	2.438E+00
2228	59	7.6	4.17	-7.340E-08	-4.050E-03	2.438E+00
2229	33.4	1.8	4.21	-7.340E-08	-4.050E-03	2.438E+00
2230	39.5	11.1	4.64	-7.340E-08	-4.050E-03	2.438E+00
2231	47.5	4.3	5.06	-7.340E-08	-4.050E-03	2.438E+00
2232	43.9	(°)	4.89	-7.340E-08	-4.050E-03	2.438E+00
2233	33.7	(°)	4.37	-7.340E-08	-4.050E-03	2.438E+00
2234	21.6	(°)	3.76	-7.340E-08	-4.050E-03	2.438E+00
2235	10.3	(°)	3.18	-7.340E-08	-4.050E-03	2.438E+00

2236	0	0	2.52	-7.340E-08	-4.050E-03	2.438E+00
2237	0	0	0.23	-7.340E-08	-4.050E-03	2.438E+00
2238	0	0	0	-7.340E-08	-4.050E-03	2.438E+00
2239	0	0	0	-7.340E-08	-4.050E-03	2.438E+00
2240	0	0	0	2.707E-06	-6.116E-03	2.089E+00
2241	0	0	0	5.488E-06	-8.182E-03	1.740E+00
2242	0	0	0	8.269E-06	-1.025E-02	1.390E+00
2298	0	0	0	8.269E-06	-1.025E-02	1.390E+00
2299	2.1	7.2	0	8.269E-06	-1.025E-02	1.390E+00
2300	8.7	49.6	1.87	8.269E-06	-1.025E-02	1.390E+00
2301	51.5	35.1	3.84	8.269E-06	-1.025E-02	1.390E+00
2302	68.4	21.2	5.23	8.269E-06	-1.025E-02	1.390E+00
2303	72.7	25.8	6.26	8.269E-06	-1.025E-02	1.390E+00
2304	57.9	7.7	7.16	8.269E-06	-1.025E-02	1.390E+00
2305	58.4	36.2	7.53	8.269E-06	-1.025E-02	1.390E+00
2306	106.4	37.8	10.52	8.269E-06	-1.025E-02	1.390E+00
2307	32.6	2.2	10.28	8.269E-06	-1.025E-02	1.390E+00
2308	42.1	98.8	11.65	8.269E-06	-1.025E-02	1.390E+00
2309	64.9	21	14.54	2.756E-06	-3.416E-03	4.635E-01
2310	65	0.2	14.6	-2.756E-06	3.416E-03	-4.635E-01
2311	36.2	(°)	14.29	-8.269E-06	1.025E-02	-1.390E+00
2312	29.8	(°)	13.76	-8.269E-06	1.025E-02	-1.390E+00
2313	25.8	(°)	13.08	-8.269E-06	1.025E-02	-1.390E+00
2314	22.5	(°)	12.52	-8.269E-06	1.025E-02	-1.390E+00
2315	19.3	(°)	11.99	-8.269E-06	1.025E-02	-1.390E+00
2316	17	(°)	11.6	-8.269E-06	1.025E-02	-1.390E+00
2317	15.4	4.1	11.32	-8.269E-06	1.025E-02	-1.390E+00
2318	14.4	1.5	11.15	-8.269E-06	1.025E-02	-1.390E+00
2319	12.9	(°)	10.91	-8.269E-06	1.025E-02	-1.390E+00
2320	11.6	8.8	10.11	-8.269E-06	1.025E-02	-1.390E+00
2321	24.3	1.8	9.3	-8.269E-06	1.025E-02	-1.390E+00
2322	18.2	(°)	8.77	-8.269E-06	1.025E-02	-1.390E+00
2323	14.3	(°)	8.28	-8.269E-06	1.025E-02	-1.390E+00
2324	9.9	(°)	7.75	-8.269E-06	1.025E-02	-1.390E+00
2325	10.9	3	5.41	-8.269E-06	1.025E-02	-1.390E+00
2326	5.6	0.7	2.62	-8.269E-06	1.025E-02	-1.390E+00
2327	0	0	1.42	-8.269E-06	1.025E-02	-1.390E+00
2328	3.4	7	1.3	-2.756E-06	3.416E-03	-4.635E-01
2329	6.3	10.9	2.04	2.756E-06	-3.416E-03	4.635E-01
2330	6.2	3.5	2.17	8.269E-06	-1.025E-02	1.390E+00
2331	0	0	1.97	8.269E-06	-1.025E-02	1.390E+00
2332	0	0	1.16	8.269E-06	-1.025E-02	1.390E+00
2333	8.7	36.1	1.99	8.269E-06	-1.025E-02	1.390E+00
2334	47.4	34.5	3.7	8.269E-06	-1.025E-02	1.390E+00
2335	74.6	30.1	4.78	8.269E-06	-1.025E-02	1.390E+00
2336	38.3	1.3	4.59	8.269E-06	-1.025E-02	1.390E+00
2337	88.1	38	7.02	8.269E-06	-1.025E-02	1.390E+00
2338	50.5	0.8	6.88	8.269E-06	-1.025E-02	1.390E+00
2339	68.9	46.4	8.24	8.269E-06	-1.025E-02	1.390E+00
2340	69.6	16.4	9.79	8.269E-06	-1.025E-02	1.390E+00
2341	55.1	35.9	9.94	8.269E-06	-1.025E-02	1.390E+00
2342	83.9	29.4	12.63	8.269E-06	-1.025E-02	1.390E+00
2343	87.2	12.3	12.98	8.269E-06	-1.025E-02	1.390E+00
2344	58.8	6.3	13.3	8.269E-06	-1.025E-02	1.390E+00
2345	59.1	52.5	13.78	8.269E-06	-1.025E-02	1.390E+00
2346	85.8	67.1	17.03	8.269E-06	-1.025E-02	1.390E+00
2347	67.4	11.5	18.36	8.269E-06	-1.025E-02	1.390E+00
2348	56.8	47.6	18.22	8.269E-06	-1.025E-02	1.390E+00
2349	69.9	76.1	20.33	8.269E-06	-1.025E-02	1.390E+00
2350	86.8	76.3	23.13	8.269E-06	-1.025E-02	1.390E+00
2351	49.1	0.6	22.57	8.269E-06	-1.025E-02	1.390E+00
2352	45.4	64.4	22.1	8.269E-06	-1.025E-02	1.390E+00
2353	51.4	80.2	23.4	8.269E-06	-1.025E-02	1.390E+00
2354	60.2	89.5	25.38	8.269E-06	-1.025E-02	1.390E+00
2355	69.5	87.4	27.47	8.269E-06	-1.025E-02	1.390E+00
2356	77.8	85.8	29.37	8.269E-06	-1.025E-02	1.390E+00
2357	48.5	7.2	29.12	8.269E-06	-1.025E-02	1.390E+00
2358	40.2	50.8	28.2	8.269E-06	-1.025E-02	1.390E+00
2359	42	78.2	28.69	8.269E-06	-1.025E-02	1.390E+00
2360	45.9	91.3	29.83	8.269E-06	-1.025E-02	1.390E+00
2361	50.4	95.9	31.2	8.269E-06	-1.025E-02	1.390E+00
2362	50.7	6.9	31.45	8.269E-06	-1.025E-02	1.390E+00

2363	48.4	11.9	30.75	2.756E-06	-3.416E-03	4.635E-01
2364	49.2	(°)	31.06	-2.756E-06	3.416E-03	-4.635E-01
2365	45.8	(°)	30.05	-8.269E-06	1.025E-02	-1.390E+00
2366	44.2	(°)	29.49	-8.269E-06	1.025E-02	-1.390E+00
2367	41.5	(°)	28.7	-8.269E-06	1.025E-02	-1.390E+00
2368	38.7	(°)	27.84	-8.269E-06	1.025E-02	-1.390E+00
2369	36.4	(°)	27.12	-8.269E-06	1.025E-02	-1.390E+00
2370	34.2	(°)	26.47	-8.269E-06	1.025E-02	-1.390E+00
2371	33.2	(°)	26.14	-8.269E-06	1.025E-02	-1.390E+00
2372	31.5	(°)	25.6	-8.269E-06	1.025E-02	-1.390E+00
2373	30.4	(°)	25.27	-8.269E-06	1.025E-02	-1.390E+00
2374	29.3	13.2	24.91	-8.269E-06	1.025E-02	-1.390E+00
2375	28.7	(°)	24.76	-8.269E-06	1.025E-02	-1.390E+00
2376	23.6	(°)	23.24	-8.269E-06	1.025E-02	-1.390E+00
2377	16.8	3.9	20.72	-8.269E-06	1.025E-02	-1.390E+00
2378	36	(°)	20.05	-8.269E-06	1.025E-02	-1.390E+00
2379	36.6	(°)	20.21	-8.269E-06	1.025E-02	-1.390E+00
2380	32.9	(°)	19.43	-8.269E-06	1.025E-02	-1.390E+00
2381	26.9	(°)	18.01	-8.269E-06	1.025E-02	-1.390E+00
2382	26.4	(°)	17.88	-8.269E-06	1.025E-02	-1.390E+00
2383	25.6	(°)	17.73	-8.269E-06	1.025E-02	-1.390E+00
2384	18.1	(°)	16.06	-8.269E-06	1.025E-02	-1.390E+00
2385	33	5.8	13.87	-8.269E-06	1.025E-02	-1.390E+00
2386	19.4	(°)	12.07	-8.269E-06	1.025E-02	-1.390E+00
2387	9.8	4.3	10.05	-8.269E-06	1.025E-02	-1.390E+00
2388	20.7	1.1	8.91	-8.269E-06	1.025E-02	-1.390E+00
2389	18.7	(°)	8.83	-8.269E-06	1.025E-02	-1.390E+00
2390	13.9	(°)	8.25	-8.269E-06	1.025E-02	-1.390E+00
2391	12.8	(°)	8.1	-2.756E-06	3.416E-03	-4.635E-01
2392	14.2	(°)	8.27	2.756E-06	-3.416E-03	4.635E-01
2393	16.4	4.2	8.54	8.269E-06	-1.025E-02	1.390E+00
2394	21.4	9.2	9.15	8.269E-06	-1.025E-02	1.390E+00
2395	23.7	4.3	9.45	8.269E-06	-1.025E-02	1.390E+00
2396	24.9	5.7	9.59	8.269E-06	-1.025E-02	1.390E+00
2397	27.2	6.4	9.87	8.269E-06	-1.025E-02	1.390E+00
2398	29.1	10.6	10.11	8.269E-06	-1.025E-02	1.390E+00
2399	34.4	19.3	10.75	8.269E-06	-1.025E-02	1.390E+00
2400	44.5	25.5	12	8.269E-06	-1.025E-02	1.390E+00
2401	55.9	22	13.43	8.269E-06	-1.025E-02	1.390E+00
2402	58	4.2	13.72	8.269E-06	-1.025E-02	1.390E+00
2403	50.3	14.9	13.98	8.269E-06	-1.025E-02	1.390E+00
2404	31.4	31.9	13.97	8.269E-06	-1.025E-02	1.390E+00
2405	38.9	18.9	15.25	8.269E-06	-1.025E-02	1.390E+00
2406	39.4	(°)	15.36	8.269E-06	-1.025E-02	1.390E+00
2407	36.4	(°)	14.87	8.269E-06	-1.025E-02	1.390E+00
2408	31.3	(°)	14.03	8.269E-06	-1.025E-02	1.390E+00
2409	24.5	(°)	12.87	8.269E-06	-1.025E-02	1.390E+00
2410	18.6	(°)	11.89	8.269E-06	-1.025E-02	1.390E+00
2411	14.9	(°)	11.27	8.269E-06	-1.025E-02	1.390E+00
2412	8.9	(°)	10.3	8.269E-06	-1.025E-02	1.390E+00
2413	33	6	10.6	8.269E-06	-1.025E-02	1.390E+00
2414	36.4	28.9	11.01	8.269E-06	-1.025E-02	1.390E+00
2415	45.1	24.4	12.08	8.269E-06	-1.025E-02	1.390E+00
2416	50.9	12.1	12.82	8.269E-06	-1.025E-02	1.390E+00
2417	54.2	6.3	13.24	8.269E-06	-1.025E-02	1.390E+00
2418	53.3	(°)	13.14	8.269E-06	-1.025E-02	1.390E+00
2419	52.5	3.6	13.04	8.269E-06	-1.025E-02	1.390E+00
2420	53.9	6.8	13.2	8.269E-06	-1.025E-02	1.390E+00
2421	54.2	7.5	13.24	8.269E-06	-1.025E-02	1.390E+00
2422	53	6	13.09	8.269E-06	-1.025E-02	1.390E+00
2423	54.2	7.9	13.24	8.269E-06	-1.025E-02	1.390E+00
2424	57.8	8.1	13.69	8.269E-06	-1.025E-02	1.390E+00
2425	61.4	14	14.12	8.269E-06	-1.025E-02	1.390E+00
2426	34.1	1	14.14	8.269E-06	-1.025E-02	1.390E+00
2427	38.7	56.4	15.16	8.269E-06	-1.025E-02	1.390E+00
2428	57.6	68.8	18.28	8.269E-06	-1.025E-02	1.390E+00
2429	68.9	33.9	20.25	4.866E-06	-6.427E-03	5.912E-01
2430	79.9	55.8	22.04	1.464E-06	-2.605E-03	-2.080E-01
2431	72.1	21.5	23.5	-1.939E-06	1.217E-03	-1.007E+00
2432	51.1	43.7	23.42	-1.939E-06	1.217E-03	-1.007E+00
2433	59.3	80.6	25.21	-1.939E-06	1.217E-03	-1.007E+00
2434	71.3	82	27.89	-1.939E-06	1.217E-03	-1.007E+00



2435	78.4	27.2	29.63	-1.939E-06	1.217E-03	-1.007E+00
2436	45.9	2.1	29.47	-1.939E-06	1.217E-03	-1.007E+00
2437	46.3	70.5	30.03	-1.939E-06	1.217E-03	-1.007E+00
2438	52.4	83.4	31.83	-1.939E-06	1.217E-03	-1.007E+00
2439	59.1	50.7	33.93	-1.939E-06	1.217E-03	-1.007E+00
2440	59.6	21.4	34.17	-1.939E-06	1.217E-03	-1.007E+00
2441	61.4	19	34.46	-1.939E-06	1.217E-03	-1.007E+00
2442	30.4	2.9	34.14	-1.939E-06	1.217E-03	-1.007E+00
2443	31	36.2	34.54	-1.939E-06	1.217E-03	-1.007E+00
2444	31.7	30.6	34.83	-1.939E-06	1.217E-03	-1.007E+00
2445	32.1	13	35.01	-1.939E-06	1.217E-03	-1.007E+00
2446	32.1	22	35	-1.939E-06	1.217E-03	-1.007E+00
2447	31.8	( <sup>o</sup> )	34.93	-1.939E-06	1.217E-03	-1.007E+00
2448	31.2	17.8	34.64	-1.939E-06	1.217E-03	-1.007E+00
2449	30.8	( <sup>o</sup> )	34.51	-1.939E-06	1.217E-03	-1.007E+00
2450	29.5	( <sup>o</sup> )	33.99	-1.939E-06	1.217E-03	-1.007E+00
2451	28.4	( <sup>o</sup> )	33.51	-1.939E-06	1.217E-03	-1.007E+00
2452	28.4	28.8	33.46	-1.939E-06	1.217E-03	-1.007E+00
2453	29.1	23.2	33.77	-1.939E-06	1.217E-03	-1.007E+00
2454	29.8	21.1	34.07	-1.939E-06	1.217E-03	-1.007E+00
2455	30.6	19.6	34.4	-1.939E-06	1.217E-03	-1.007E+00
2456	31.6	15	34.8	-1.939E-06	1.217E-03	-1.007E+00
2457	32.4	7.4	35.18	-1.939E-06	1.217E-03	-1.007E+00
2458	33.4	7.3	35.58	-1.939E-06	1.217E-03	-1.007E+00
2459	34.2	( <sup>o</sup> )	35.94	-1.939E-06	1.217E-03	-1.007E+00
2460	35	( <sup>o</sup> )	36.27	-1.939E-06	1.217E-03	-1.007E+00
2461	35.8	( <sup>o</sup> )	36.6	-1.939E-06	1.217E-03	-1.007E+00
2462	36	( <sup>o</sup> )	36.71	-1.939E-06	1.217E-03	-1.007E+00
2463	35.9	( <sup>o</sup> )	36.64	-1.939E-06	1.217E-03	-1.007E+00
2464	35.6	( <sup>o</sup> )	36.51	-1.939E-06	1.217E-03	-1.007E+00
2465	34.9	( <sup>o</sup> )	36.22	-1.939E-06	1.217E-03	-1.007E+00
2466	34	( <sup>o</sup> )	35.86	-1.939E-06	1.217E-03	-1.007E+00
2467	33.3	16.5	35.53	-1.939E-06	1.217E-03	-1.007E+00
2468	33.2	14.2	35.51	-1.939E-06	1.217E-03	-1.007E+00
2469	33.6	38.9	35.61	-1.939E-06	1.217E-03	-1.007E+00
2470	34.4	47.8	35.93	-1.939E-06	1.217E-03	-1.007E+00
2471	34.9	38.6	36.15	-1.939E-06	1.217E-03	-1.007E+00
2472	34.8	40.6	36.09	-1.939E-06	1.217E-03	-1.007E+00
2473	34.7	45.1	36.05	-1.939E-06	1.217E-03	-1.007E+00
2474	34.3	38.1	35.92	-1.939E-06	1.217E-03	-1.007E+00
2475	34.4	60.8	35.91	-1.939E-06	1.217E-03	-1.007E+00
2476	33.6	( <sup>o</sup> )	35.69	-1.939E-06	1.217E-03	-1.007E+00
2477	30.3	1	34.29	-1.939E-06	1.217E-03	-1.007E+00
2478	28.4	( <sup>o</sup> )	33.5	-1.939E-06	1.217E-03	-1.007E+00
2479	26.7	11.3	32.79	-1.939E-06	1.217E-03	-1.007E+00
2480	26.4	37.8	32.61	-1.939E-06	1.217E-03	-1.007E+00
2481	27.2	60.2	32.93	-1.939E-06	1.217E-03	-1.007E+00
2482	30	78.9	34.07	-1.939E-06	1.217E-03	-1.007E+00
2483	32	65.3	34.93	-1.939E-06	1.217E-03	-1.007E+00
2484	33.1	11.8	35.46	-1.939E-06	1.217E-03	-1.007E+00
2485	33.4	25.9	35.55	-1.939E-06	1.217E-03	-1.007E+00
2486	34.1	31	35.85	-1.939E-06	1.217E-03	-1.007E+00
2487	34.2	0.5	35.92	-1.939E-06	1.217E-03	-1.007E+00
2488	34.9	47.5	36.12	-1.939E-06	1.217E-03	-1.007E+00
2489	36.9	39.9	37	-1.939E-06	1.217E-03	-1.007E+00
2490	38.1	44.3	37.5	-1.939E-06	1.217E-03	-1.007E+00
2491	40.2	62.9	38.31	-1.939E-06	1.217E-03	-1.007E+00
2492	42.4	52.1	39.27	-1.939E-06	1.217E-03	-1.007E+00
2493	42.9	4.8	39.53	-1.939E-06	1.217E-03	-1.007E+00
2494	42.5	12.5	39.36	-1.939E-06	1.217E-03	-1.007E+00
2495	42.5	17	39.34	-1.939E-06	1.217E-03	-1.007E+00
2496	42.7	28	39.43	-1.939E-06	1.217E-03	-1.007E+00
2497	42.8	15	39.5	-1.939E-06	1.217E-03	-1.007E+00
2498	42.9	17.8	39.51	-1.939E-06	1.217E-03	-1.007E+00
2499	43	21.5	39.57	-1.939E-06	1.217E-03	-1.007E+00
2500	43.2	20	39.64	-1.939E-06	1.217E-03	-1.007E+00
2501	43.5	24.6	39.76	-1.939E-06	1.217E-03	-1.007E+00
2502	44.2	31.9	40.02	-1.939E-06	1.217E-03	-1.007E+00
2503	44.1	4.6	40.03	-1.939E-06	1.217E-03	-1.007E+00
2504	44	24.5	39.98	-1.939E-06	1.217E-03	-1.007E+00
2505	44	8.7	39.99	-1.939E-06	1.217E-03	-1.007E+00
2506	43.4	4.4	39.75	-1.939E-06	1.217E-03	-1.007E+00

2507	43.1	14	39.6	-1.939E-06	1.217E-03	-1.007E+00
2508	42.6	4.2	39.43	-1.939E-06	1.217E-03	-1.007E+00
2509	41.7	(°)	39.05	-1.939E-06	1.217E-03	-1.007E+00
2510	41.2	13.6	38.82	-1.939E-06	1.217E-03	-1.007E+00
2511	40.8	6.5	38.69	-1.939E-06	1.217E-03	-1.007E+00
2512	40.7	20.3	38.62	-1.939E-06	1.217E-03	-1.007E+00
2513	39.8	(°)	38.3	-1.939E-06	1.217E-03	-1.007E+00
2514	39	14.7	37.92	-1.939E-06	1.217E-03	-1.007E+00
2515	39.3	24.9	37.99	-1.939E-06	1.217E-03	-1.007E+00
2516	38.9	(°)	37.87	-1.939E-06	1.217E-03	-1.007E+00
2517	38.5	15.5	37.69	-1.939E-06	1.217E-03	-1.007E+00
2518	38	(°)	37.49	-1.939E-06	1.217E-03	-1.007E+00
2519	37.3	7	37.22	-1.939E-06	1.217E-03	-1.007E+00
2520	36.4	(°)	36.84	-1.939E-06	1.217E-03	-1.007E+00
2521	35.3	(°)	36.4	-1.939E-06	1.217E-03	-1.007E+00
2522	34.1	(°)	35.89	-1.939E-06	1.217E-03	-1.007E+00
2523	32.8	(°)	35.34	-1.939E-06	1.217E-03	-1.007E+00
2524	30.7	(°)	34.5	-1.939E-06	1.217E-03	-1.007E+00
2525	28.9	(°)	33.74	-1.939E-06	1.217E-03	-1.007E+00
2526	27.8	(°)	33.25	-1.939E-06	1.217E-03	-1.007E+00
2527	26.7	(°)	32.79	-1.939E-06	1.217E-03	-1.007E+00
2528	26.4	20	32.65	-1.939E-06	1.217E-03	-1.007E+00
2529	26.8	24.1	32.81	-1.939E-06	1.217E-03	-1.007E+00
2530	27.1	15.6	32.94	-1.939E-06	1.217E-03	-1.007E+00
2531	27.6	29.9	33.13	-1.939E-06	1.217E-03	-1.007E+00
2532	28.3	31.9	33.43	-1.939E-06	1.217E-03	-1.007E+00
2533	28.6	14.2	33.58	-1.939E-06	1.217E-03	-1.007E+00
2534	29.3	37.8	33.83	-1.939E-06	1.217E-03	-1.007E+00
2535	30.6	43.6	34.36	-1.939E-06	1.217E-03	-1.007E+00
2536	31.9	34.4	34.91	-1.939E-06	1.217E-03	-1.007E+00
2537	31.6	0.9	34.86	-1.939E-06	1.217E-03	-1.007E+00
2538	32.1	38.6	35	-1.939E-06	1.217E-03	-1.007E+00
2539	32.6	0.8	35.28	-1.939E-06	1.217E-03	-1.007E+00
2540	32	(°)	35.02	-1.939E-06	1.217E-03	-1.007E+00
2541	32	20	34.99	-1.939E-06	1.217E-03	-1.007E+00
2542	32.1	2.5	35.06	-1.939E-06	1.217E-03	-1.007E+00
2543	31.3	(°)	34.72	-1.939E-06	1.217E-03	-1.007E+00
2544	30.3	(°)	34.3	-1.939E-06	1.217E-03	-1.007E+00
2545	29.5	(°)	34.06	-1.939E-06	1.217E-03	-1.007E+00
2546	27.9	(°)	33.4	-1.939E-06	1.217E-03	-1.007E+00
2547	26.1	(°)	32.58	-1.939E-06	1.217E-03	-1.007E+00
2548	24.8	(°)	32.04	-1.939E-06	1.217E-03	-1.007E+00
2549	23.1	39.1	31.24	-1.939E-06	1.217E-03	-1.007E+00
2550	22.3	56.9	30.88	-1.939E-06	1.217E-03	-1.007E+00
2551	24.3	68.3	31.7	-1.939E-06	1.217E-03	-1.007E+00
2552	25.9	40.5	32.4	-1.939E-06	1.217E-03	-1.007E+00
2553	26.8	24.7	32.8	-1.939E-06	1.217E-03	-1.007E+00
2554	27.5	38.9	33.07	-1.939E-06	1.217E-03	-1.007E+00
2555	28.3	44.5	33.4	-1.939E-06	1.217E-03	-1.007E+00
2556	29	26	33.71	-1.939E-06	1.217E-03	-1.007E+00
2557	29.3	28.1	33.82	-1.939E-06	1.217E-03	-1.007E+00
2558	29.8	33.5	34.06	-1.939E-06	1.217E-03	-1.007E+00
2559	30.4	16.3	34.31	-1.939E-06	1.217E-03	-1.007E+00
2560	30.5	17.6	34.34	-1.939E-06	1.217E-03	-1.007E+00
2561	30.4	9.3	34.34	-1.939E-06	1.217E-03	-1.007E+00
2562	30	1	34.16	-1.939E-06	1.217E-03	-1.007E+00
2563	29.1	(°)	33.82	-1.939E-06	1.217E-03	-1.007E+00
2564	28.4	11.9	33.48	-1.939E-06	1.217E-03	-1.007E+00
2565	28.1	(°)	33.38	-1.939E-06	1.217E-03	-1.007E+00
2566	28.1	30.8	33.33	-1.939E-06	1.217E-03	-1.007E+00
2567	29.1	37.6	33.75	-1.939E-06	1.217E-03	-1.007E+00
2568	30.3	40.6	34.26	-1.939E-06	1.217E-03	-1.007E+00
2569	31.5	24.7	34.77	-1.939E-06	1.217E-03	-1.007E+00
2570	32.4	37.8	35.1	-1.939E-06	1.217E-03	-1.007E+00
2571	33.7	44.2	35.63	-1.939E-06	1.217E-03	-1.007E+00
2572	35.1	37.5	36.22	-1.939E-06	1.217E-03	-1.007E+00
2573	36.2	38.5	36.7	-1.939E-06	1.217E-03	-1.007E+00
2574	36.2	(°)	36.77	-1.939E-06	1.217E-03	-1.007E+00
2575	36.2	31	36.7	-1.939E-06	1.217E-03	-1.007E+00
2576	36.8	24.9	36.96	-1.939E-06	1.217E-03	-1.007E+00
2577	37.4	26.1	37.21	-1.939E-06	1.217E-03	-1.007E+00
2578	37.8	25.3	37.4	-1.939E-06	1.217E-03	-1.007E+00

2579	38	15.1	37.48	-1.939E-06	1.217E-03	-1.007E+00
2580	38.1	20.9	37.5	-1.939E-06	1.217E-03	-1.007E+00
2581	38.2	18.4	37.56	-1.939E-06	1.217E-03	-1.007E+00
2582	37.7	( <sup>6</sup> )	37.37	-1.939E-06	1.217E-03	-1.007E+00
2583	37.7	29.6	37.34	-1.939E-06	1.217E-03	-1.007E+00
2584	38.4	21.6	37.63	-1.939E-06	1.217E-03	-1.007E+00
2585	38.7	19.5	37.75	-1.939E-06	1.217E-03	-1.007E+00
2586	39.2	28.1	37.96	-1.939E-06	1.217E-03	-1.007E+00
2587	39.8	27.4	38.21	-1.939E-06	1.217E-03	-1.007E+00
2588	40.2	21.7	38.41	-1.939E-06	1.217E-03	-1.007E+00
2589	40.4	21.5	38.48	-1.939E-06	1.217E-03	-1.007E+00
2590	40.9	32.8	38.66	-1.939E-06	1.217E-03	-1.007E+00
2591	41.7	44.7	38.99	-1.939E-06	1.217E-03	-1.007E+00
2592	41.5	( <sup>6</sup> )	38.97	-1.939E-06	1.217E-03	-1.007E+00
2593	41	29.5	38.69	-1.939E-06	1.217E-03	-1.007E+00
2594	40.4	12.9	38.48	-1.939E-06	1.217E-03	-1.007E+00
2595	39.7	22.7	38.17	-1.939E-06	1.217E-03	-1.007E+00
2596	39.3	22.7	38	-1.939E-06	1.217E-03	-1.007E+00
2597	38.8	21.6	37.81	-1.939E-06	1.217E-03	-1.007E+00
2598	38.5	34.9	37.67	-1.939E-06	1.217E-03	-1.007E+00
2599	38.4	21.9	37.65	-2.270E-06	1.516E-03	-9.082E-01
2600	38.6	31.5	37.73	-2.601E-06	1.815E-03	-8.092E-01
2601	39.1	10.7	37.96	-2.932E-06	2.115E-03	-7.102E-01
2602	39	9.8	37.89	-2.932E-06	2.115E-03	-7.102E-01
2603	38.9	4.6	37.88	-2.932E-06	2.115E-03	-7.102E-01
2604	40	37.2	38.27	-2.932E-06	2.115E-03	-7.102E-01
2605	40.2	( <sup>6</sup> )	38.45	-2.932E-06	2.115E-03	-7.102E-01
2606	41	41.4	38.69	-2.932E-06	2.115E-03	-7.102E-01
2607	42.9	36	39.48	-2.932E-06	2.115E-03	-7.102E-01
2608	42.5	( <sup>6</sup> )	39.39	-2.932E-06	2.115E-03	-7.102E-01
2609	41.2	( <sup>6</sup> )	38.87	-2.932E-06	2.115E-03	-7.102E-01
2610	40.9	23.2	38.69	-2.932E-06	2.115E-03	-7.102E-01
2611	40.9	8.6	38.71	-2.932E-06	2.115E-03	-7.102E-01
2612	40.4	7.5	38.49	-2.932E-06	2.115E-03	-7.102E-01
2613	40.2	13.8	38.42	-2.932E-06	2.115E-03	-7.102E-01
2614	40.4	23.4	38.48	-2.932E-06	2.115E-03	-7.102E-01
2615	40.9	31.8	38.65	-2.932E-06	2.115E-03	-7.102E-01
2616	41.1	21.4	38.77	-2.932E-06	2.115E-03	-7.102E-01
2617	41.8	39	39.02	-2.932E-06	2.115E-03	-7.102E-01
2618	43.1	38.6	39.58	-2.932E-06	2.115E-03	-7.102E-01
2619	43.1	5.1	39.63	-2.932E-06	2.115E-03	-7.102E-01
2620	43.6	42.2	39.79	-2.932E-06	2.115E-03	-7.102E-01
2621	44.9	40.6	40.32	-2.932E-06	2.115E-03	-7.102E-01
2622	44.2	( <sup>6</sup> )	40.09	-2.932E-06	2.115E-03	-7.102E-01
2623	42.8	( <sup>6</sup> )	39.52	-2.932E-06	2.115E-03	-7.102E-01
2624	42.2	29.3	39.22	-2.932E-06	2.115E-03	-7.102E-01
2625	41.8	13.5	39.06	-2.932E-06	2.115E-03	-7.102E-01
2626	41.4	30.6	38.86	-2.932E-06	2.115E-03	-7.102E-01
2627	41.2	15.3	38.8	-2.932E-06	2.115E-03	-7.102E-01
2628	40.8	26.4	38.62	-2.932E-06	2.115E-03	-7.102E-01
2629	40.3	21.9	38.44	-2.932E-06	2.115E-03	-7.102E-01
2630	40.2	30.7	38.39	-2.932E-06	2.115E-03	-7.102E-01
2631	40.2	28.1	38.4	-2.932E-06	2.115E-03	-7.102E-01
2632	40	26.8	38.31	-2.932E-06	2.115E-03	-7.102E-01
2633	40.2	36	38.38	-2.932E-06	2.115E-03	-7.102E-01
2634	40.4	30.7	38.46	-2.932E-06	2.115E-03	-7.102E-01
2635	40.7	38.9	38.58	-2.932E-06	2.115E-03	-7.102E-01
2636	41.2	36.4	38.79	-2.932E-06	2.115E-03	-7.102E-01
2637	41.5	36.5	38.93	-2.932E-06	2.115E-03	-7.102E-01
2638	41.8	35.6	39.02	-2.932E-06	2.115E-03	-7.102E-01
2639	42	35.8	39.1	-2.932E-06	2.115E-03	-7.102E-01
2640	41.6	13.2	38.99	-2.932E-06	2.115E-03	-7.102E-01
2641	41	22.6	38.73	-2.932E-06	2.115E-03	-7.102E-01
2642	41.2	36.5	38.77	-2.932E-06	2.115E-03	-7.102E-01
2643	41.4	29.7	38.88	-2.932E-06	2.115E-03	-7.102E-01
2644	41.5	21.1	38.92	-2.932E-06	2.115E-03	-7.102E-01
2645	41.4	21.8	38.91	-2.932E-06	2.115E-03	-7.102E-01
2646	41.5	20.2	38.92	-2.932E-06	2.115E-03	-7.102E-01
2647	41.6	24	38.96	-2.932E-06	2.115E-03	-7.102E-01
2648	41.7	21.9	39.03	-2.932E-06	2.115E-03	-7.102E-01
2649	41.9	25.3	39.07	-2.932E-06	2.115E-03	-7.102E-01
2650	41	( <sup>6</sup> )	38.79	-2.932E-06	2.115E-03	-7.102E-01

2651	40.9	36.6	38.67	-2.932E-06	2.115E-03	-7.102E-01
2652	41.2	14.7	38.82	-2.932E-06	2.115E-03	-7.102E-01
2653	41.5	32.6	38.9	-2.932E-06	2.115E-03	-7.102E-01
2654	41.8	21.5	39.05	-2.932E-06	2.115E-03	-7.102E-01
2655	41.8	24.1	39.07	-2.932E-06	2.115E-03	-7.102E-01
2656	42	26.5	39.13	-2.932E-06	2.115E-03	-7.102E-01
2657	42	16.9	39.15	-2.932E-06	2.115E-03	-7.102E-01
2658	41.6	18.7	38.98	-2.932E-06	2.115E-03	-7.102E-01
2659	41.6	33.4	38.93	-2.932E-06	2.115E-03	-7.102E-01
2660	42	42.5	39.1	-2.932E-06	2.115E-03	-7.102E-01
2661	43.5	72	39.66	-2.932E-06	2.115E-03	-7.102E-01
2662	45.9	51.3	40.71	-2.932E-06	2.115E-03	-7.102E-01
2663	45.4	( <sup>o</sup> )	40.61	-2.932E-06	2.115E-03	-7.102E-01
2664	46.1	46.3	40.8	-2.932E-06	2.115E-03	-7.102E-01
2665	47.1	( <sup>o</sup> )	41.32	-2.932E-06	2.115E-03	-7.102E-01
2666	46.7	9.4	41.11	-2.932E-06	2.115E-03	-7.102E-01
2667	45.7	( <sup>o</sup> )	40.74	-2.932E-06	2.115E-03	-7.102E-01
2668	44.4	0.1	40.2	-2.932E-06	2.115E-03	-7.102E-01
2669	43.2	( <sup>o</sup> )	39.7	-2.932E-06	2.115E-03	-7.102E-01
2670	42.5	5.9	39.38	-2.932E-06	2.115E-03	-7.102E-01
2671	42.6	7	39.41	-2.932E-06	2.115E-03	-7.102E-01
2672	42.8	8.9	39.52	-2.932E-06	2.115E-03	-7.102E-01
2673	43.2	( <sup>o</sup> )	39.69	-2.932E-06	2.115E-03	-7.102E-01
2674	43.4	( <sup>o</sup> )	39.78	-2.932E-06	2.115E-03	-7.102E-01
2675	43.7	( <sup>o</sup> )	39.91	-2.932E-06	2.115E-03	-7.102E-01
2676	44.2	( <sup>o</sup> )	40.1	-2.932E-06	2.115E-03	-7.102E-01
2677	43.3	( <sup>o</sup> )	39.81	-2.932E-06	2.115E-03	-7.102E-01
2678	42	( <sup>o</sup> )	39.24	-2.932E-06	2.115E-03	-7.102E-01
2679	40.9	( <sup>o</sup> )	38.77	-2.932E-06	2.115E-03	-7.102E-01
2680	41	( <sup>o</sup> )	38.78	-9.772E-07	7.048E-04	-2.367E-01
2681	40.5	( <sup>o</sup> )	38.59	9.772E-07	-7.048E-04	2.367E-01
2682	39	( <sup>o</sup> )	37.99	2.932E-06	-2.115E-03	7.102E-01
2683	37.6	( <sup>o</sup> )	37.38	2.932E-06	-2.115E-03	7.102E-01
2684	36	( <sup>o</sup> )	36.67	2.932E-06	-2.115E-03	7.102E-01
2685	33.2	( <sup>o</sup> )	35.53	2.932E-06	-2.115E-03	7.102E-01
2686	32.2	( <sup>o</sup> )	35.18	2.932E-06	-2.115E-03	7.102E-01
2687	29.5	( <sup>o</sup> )	34.02	2.932E-06	-2.115E-03	7.102E-01
2688	27.2	( <sup>o</sup> )	33.01	2.932E-06	-2.115E-03	7.102E-01
2689	24.5	( <sup>o</sup> )	31.93	2.932E-06	-2.115E-03	7.102E-01
2690	21.5	( <sup>o</sup> )	30.64	2.932E-06	-2.115E-03	7.102E-01
2691	17.9	( <sup>o</sup> )	29.19	2.932E-06	-2.115E-03	7.102E-01
2692	37.6	9.6	26.34	2.932E-06	-2.115E-03	7.102E-01
2693	24.4	( <sup>o</sup> )	23.47	2.932E-06	-2.115E-03	7.102E-01
2694	19.8	( <sup>o</sup> )	22.01	2.932E-06	-2.115E-03	7.102E-01
2695	16.8	15.6	21.07	2.932E-06	-2.115E-03	7.102E-01
2696	38.2	4.6	20.04	2.932E-06	-2.115E-03	7.102E-01
2697	35.3	53.2	19.82	2.932E-06	-2.115E-03	7.102E-01
2698	34.8	( <sup>o</sup> )	19.79	2.932E-06	-2.115E-03	7.102E-01
2699	28	( <sup>o</sup> )	18.28	2.932E-06	-2.115E-03	7.102E-01
2700	18.9	( <sup>o</sup> )	16.18	2.932E-06	-2.115E-03	7.102E-01
2701	40.1	12.9	14.95	2.932E-06	-2.115E-03	7.102E-01
2702	28.6	( <sup>o</sup> )	13.58	2.932E-06	-2.115E-03	7.102E-01
2703	16.4	( <sup>o</sup> )	11.53	2.932E-06	-2.115E-03	7.102E-01
2704	10.4	( <sup>o</sup> )	10.49	2.932E-06	-2.115E-03	7.102E-01
2705	33.4	9.5	10.27	2.932E-06	-2.115E-03	7.102E-01
2706	28.5	3.5	10.04	2.932E-06	-2.115E-03	7.102E-01
2707	29.1	14.7	10.11	9.772E-07	-7.048E-04	2.367E-01
2708	36.1	19.7	10.96	-9.772E-07	7.048E-04	-2.367E-01
2709	43.7	21.1	11.91	-2.932E-06	2.115E-03	-7.102E-01
2710	51.1	14.7	12.84	-2.932E-06	2.115E-03	-7.102E-01
2711	55.9	21.4	13.43	-2.932E-06	2.115E-03	-7.102E-01
2712	66.5	34.1	14.71	-2.932E-06	2.115E-03	-7.102E-01
2713	68.3	19.9	15.86	-2.932E-06	2.115E-03	-7.102E-01
2714	40.6	23.4	15.53	-2.932E-06	2.115E-03	-7.102E-01
2715	53.5	75.5	17.59	-2.932E-06	2.115E-03	-7.102E-01
2716	63.9	17.2	19.44	-2.932E-06	2.115E-03	-7.102E-01
2717	64.5	11.6	19.56	-2.932E-06	2.115E-03	-7.102E-01
2718	36.4	2.4	19.47	-2.932E-06	2.115E-03	-7.102E-01
2719	34.5	50	19.63	-2.932E-06	2.115E-03	-7.102E-01
2720	39.1	24	20.72	-2.932E-06	2.115E-03	-7.102E-01
2721	41.7	26.3	21.3	-2.932E-06	2.115E-03	-7.102E-01
2722	43.6	20.8	21.75	-2.932E-06	2.115E-03	-7.102E-01

2723	45.5	28.8	22.16	-2.932E-06	2.115E-03	-7.102E-01
2724	47.5	27.2	22.62	-2.932E-06	2.115E-03	-7.102E-01
2725	47.6	20.8	22.65	-2.932E-06	2.115E-03	-7.102E-01
2726	48.4	30.2	22.8	-2.932E-06	2.115E-03	-7.102E-01
2727	48.3	20.1	22.8	-2.932E-06	2.115E-03	-7.102E-01
2728	50.2	( <sup>6</sup> )	23.3	-9.772E-07	7.048E-04	-2.367E-01
2729	49.6	( <sup>6</sup> )	23.19	9.772E-07	-7.048E-04	2.367E-01
2730	46.6	( <sup>6</sup> )	22.46	2.932E-06	-2.115E-03	7.102E-01
2731	44.7	( <sup>6</sup> )	22.03	2.932E-06	-2.115E-03	7.102E-01
2732	43.1	( <sup>6</sup> )	21.67	2.932E-06	-2.115E-03	7.102E-01
2733	41.2	( <sup>6</sup> )	21.23	2.932E-06	-2.115E-03	7.102E-01
2734	40.1	1.5	20.97	2.932E-06	-2.115E-03	7.102E-01
2735	39.5	( <sup>6</sup> )	20.86	2.932E-06	-2.115E-03	7.102E-01
2736	37.2	( <sup>6</sup> )	20.33	2.932E-06	-2.115E-03	7.102E-01
2737	34.7	( <sup>6</sup> )	19.76	2.932E-06	-2.115E-03	7.102E-01
2738	29.9	( <sup>6</sup> )	18.71	2.932E-06	-2.115E-03	7.102E-01
2739	21.9	( <sup>6</sup> )	16.9	2.932E-06	-2.115E-03	7.102E-01
2740	27.2	14.2	14.92	2.932E-06	-2.115E-03	7.102E-01
2741	29.7	0.3	13.71	2.932E-06	-2.115E-03	7.102E-01
2742	24.4	( <sup>6</sup> )	12.88	2.932E-06	-2.115E-03	7.102E-01
2743	10.1	( <sup>6</sup> )	10.5	2.932E-06	-2.115E-03	7.102E-01
2744	10.4	( <sup>6</sup> )	7.5	2.932E-06	-2.115E-03	7.102E-01
2745	16.1	11.8	5.02	2.932E-06	-2.115E-03	7.102E-01
2746	16.5	9.6	3.25	2.932E-06	-2.115E-03	7.102E-01
2747	0	0	0.16	2.932E-06	-2.115E-03	7.102E-01
2748	0	0	0	2.932E-06	-2.115E-03	7.102E-01
2749	0	0	0	2.932E-06	-2.115E-03	7.102E-01
2750	0	0	0	2.537E-06	-2.528E-03	-2.959E-02
2751	0	0	0	2.143E-06	-2.941E-03	-7.694E-01
2752	0	0	0	1.749E-06	-3.354E-03	-1.509E+00
2754	0	0	0	1.749E-06	-3.354E-03	-1.509E+00
2755	5.6	23	0.1	1.749E-06	-3.354E-03	-1.509E+00
2756	19.9	33.9	2.7	1.749E-06	-3.354E-03	-1.509E+00
2757	74.4	32.9	4.69	1.749E-06	-3.354E-03	-1.509E+00
2758	60.9	1	5.72	1.749E-06	-3.354E-03	-1.509E+00
2759	97.8	33.1	7.34	1.749E-06	-3.354E-03	-1.509E+00
2760	55.9	2.2	7.4	1.749E-06	-3.354E-03	-1.509E+00
2761	89.4	50.7	9.63	1.749E-06	-3.354E-03	-1.509E+00
2762	54.9	1.2	9.81	1.749E-06	-3.354E-03	-1.509E+00
2763	71.2	57.1	11.41	1.749E-06	-3.354E-03	-1.509E+00
2764	90.9	17.2	13.4	1.749E-06	-3.354E-03	-1.509E+00
2765	55.2	0.8	13.37	1.749E-06	-3.354E-03	-1.509E+00
2766	75	77.5	15.71	1.749E-06	-3.354E-03	-1.509E+00
2767	85.3	20.8	17.87	1.749E-06	-3.354E-03	-1.509E+00
2768	52.8	13.4	17.59	1.749E-06	-3.354E-03	-1.509E+00
2769	65.9	80.7	19.67	1.749E-06	-3.354E-03	-1.509E+00
2770	85.7	74.1	22.96	1.749E-06	-3.354E-03	-1.509E+00
2771	53.9	0.2	23.66	1.749E-06	-3.354E-03	-1.509E+00
2772	55.1	62.4	24.3	1.749E-06	-3.354E-03	-1.509E+00
2773	65.1	77	26.51	1.749E-06	-3.354E-03	-1.509E+00
2774	77.2	83	29.24	1.749E-06	-3.354E-03	-1.509E+00
2775	51.1	6.5	29.99	1.749E-06	-3.354E-03	-1.509E+00
2776	46.7	52.1	30.18	1.749E-06	-3.354E-03	-1.509E+00
2777	51.7	78.3	31.64	1.749E-06	-3.354E-03	-1.509E+00
2778	58.5	62.4	33.74	1.749E-06	-3.354E-03	-1.509E+00
2779	60.8	33.9	34.5	1.749E-06	-3.354E-03	-1.509E+00
2780	62	48.1	34.83	1.749E-06	-3.354E-03	-1.509E+00
2781	65.4	41.7	35.89	1.749E-06	-3.354E-03	-1.509E+00
2782	67.2	23.3	36.47	1.749E-06	-3.354E-03	-1.509E+00
2783	68.2	10.3	37	1.749E-06	-3.354E-03	-1.509E+00
2784	36.5	3.2	36.85	1.749E-06	-3.354E-03	-1.509E+00
2785	36	7.7	36.65	1.749E-06	-3.354E-03	-1.509E+00
2786	36	27.9	36.64	1.749E-06	-3.354E-03	-1.509E+00
2787	36.5	14.5	36.86	1.749E-06	-3.354E-03	-1.509E+00
2788	35.9	( <sup>6</sup> )	36.64	1.749E-06	-3.354E-03	-1.509E+00
2789	34.7	( <sup>6</sup> )	36.15	1.749E-06	-3.354E-03	-1.509E+00
2790	33.3	( <sup>6</sup> )	35.59	1.749E-06	-3.354E-03	-1.509E+00
2791	32	( <sup>6</sup> )	35.04	1.749E-06	-3.354E-03	-1.509E+00
2792	30.6	( <sup>6</sup> )	34.44	1.749E-06	-3.354E-03	-1.509E+00
2793	29.2	( <sup>6</sup> )	33.85	1.749E-06	-3.354E-03	-1.509E+00
2794	29.2	39.4	33.79	1.749E-06	-3.354E-03	-1.509E+00
2795	30	( <sup>6</sup> )	34.16	1.749E-06	-3.354E-03	-1.509E+00

2796	30	36.7	34.11	1.749E-06	-3.354E-03	-1.509E+00
2797	32.3	24.1	35.11	1.749E-06	-3.354E-03	-1.509E+00
2798	33.2	37.9	35.47	1.749E-06	-3.354E-03	-1.509E+00
2799	33.8	53.5	35.68	1.749E-06	-3.354E-03	-1.509E+00
2800	35.7	53.5	36.45	1.749E-06	-3.354E-03	-1.509E+00
2801	36.9	29	37.02	1.749E-06	-3.354E-03	-1.509E+00
2802	37.2	26.9	37.15	1.749E-06	-3.354E-03	-1.509E+00
2803	37.8	1.8	37.44	1.749E-06	-3.354E-03	-1.509E+00
2804	37.4	17.4	37.25	1.749E-06	-3.354E-03	-1.509E+00
2805	37.4	9.8	37.26	1.749E-06	-3.354E-03	-1.509E+00
2806	37.6	16.8	37.3	1.749E-06	-3.354E-03	-1.509E+00
2807	38.5	36.7	37.66	1.749E-06	-3.354E-03	-1.509E+00
2808	38.8	0.3	37.86	1.749E-06	-3.354E-03	-1.509E+00
2809	39.5	( <sup>o</sup> )	38.14	1.749E-06	-3.354E-03	-1.509E+00
2810	40.2	( <sup>o</sup> )	38.46	1.749E-06	-3.354E-03	-1.509E+00
2811	41.3	38.9	38.82	1.749E-06	-3.354E-03	-1.509E+00
2812	42	59.2	39.1	1.749E-06	-3.354E-03	-1.509E+00
2813	42.8	83.1	39.37	1.749E-06	-3.354E-03	-1.509E+00
2814	44.5	93.3	40.07	1.749E-06	-3.354E-03	-1.509E+00
2815	45.6	19.9	40.66	1.749E-06	-3.354E-03	-1.509E+00
2816	46.3	40.8	40.89	5.830E-07	-1.118E-03	-5.031E-01
2817	45.6	( <sup>o</sup> )	40.72	-5.830E-07	1.118E-03	5.031E-01
2818	43.7	( <sup>o</sup> )	39.89	-1.749E-06	3.354E-03	1.509E+00
2819	42.4	10.3	39.33	-1.749E-06	3.354E-03	1.509E+00
2820	41.8	20	39.06	-1.749E-06	3.354E-03	1.509E+00
2821	41.6	36.9	38.94	-1.749E-06	3.354E-03	1.509E+00
2822	41	30.8	38.71	-1.749E-06	3.354E-03	1.509E+00
2823	38.3	( <sup>o</sup> )	37.68	-1.749E-06	3.354E-03	1.509E+00
2824	35.1	( <sup>o</sup> )	36.3	-1.749E-06	3.354E-03	1.509E+00
2825	32.5	5	35.22	-1.749E-06	3.354E-03	1.509E+00
2826	31.5	( <sup>o</sup> )	34.89	-1.749E-06	3.354E-03	1.509E+00
2827	29.4	( <sup>o</sup> )	34.01	-1.749E-06	3.354E-03	1.509E+00
2828	27.3	17.8	33.02	-1.749E-06	3.354E-03	1.509E+00
2829	26	( <sup>o</sup> )	32.53	-1.749E-06	3.354E-03	1.509E+00
2830	24.1	( <sup>o</sup> )	31.76	-1.749E-06	3.354E-03	1.509E+00
2831	21.2	2.8	30.51	-1.749E-06	3.354E-03	1.509E+00
2832	18.8	18.7	29.5	-1.749E-06	3.354E-03	1.509E+00
2833	17.5	( <sup>o</sup> )	28.98	-1.749E-06	3.354E-03	1.509E+00
2834	37.4	20.4	28.34	-1.749E-06	3.354E-03	1.509E+00
2835	36.9	( <sup>o</sup> )	27.3	-1.749E-06	3.354E-03	1.509E+00
2836	31.3	( <sup>o</sup> )	25.61	-1.749E-06	3.354E-03	1.509E+00
2837	25.4	( <sup>o</sup> )	23.8	-1.749E-06	3.354E-03	1.509E+00
2838	22.2	( <sup>o</sup> )	22.76	-1.749E-06	3.354E-03	1.509E+00
2839	20.2	( <sup>o</sup> )	22.13	-1.749E-06	3.354E-03	1.509E+00
2840	17.8	( <sup>o</sup> )	21.41	-1.749E-06	3.354E-03	1.509E+00
2841	39.4	19.9	20.54	-1.749E-06	3.354E-03	1.509E+00
2842	30.1	( <sup>o</sup> )	18.82	-1.749E-06	3.354E-03	1.509E+00
2843	23.8	( <sup>o</sup> )	17.32	-1.749E-06	3.354E-03	1.509E+00
2844	18	0.7	15.96	-1.749E-06	3.354E-03	1.509E+00
2845	40.1	10.2	14.79	-1.749E-06	3.354E-03	1.509E+00
2846	30.6	20.8	13.86	-1.749E-06	3.354E-03	1.509E+00
2847	26.2	( <sup>o</sup> )	13.15	-1.749E-06	3.354E-03	1.509E+00
2848	22.5	( <sup>o</sup> )	12.52	-1.749E-06	3.354E-03	1.509E+00
2849	20.6	( <sup>o</sup> )	12.22	-1.749E-06	3.354E-03	1.509E+00
2850	18.4	( <sup>o</sup> )	11.84	-1.749E-06	3.354E-03	1.509E+00
2851	17.5	( <sup>o</sup> )	11.7	-5.830E-07	1.118E-03	5.031E-01
2852	19	( <sup>o</sup> )	11.94	5.830E-07	-1.118E-03	-5.031E-01
2853	21.8	3.9	12.39	1.749E-06	-3.354E-03	-1.509E+00
2854	28.5	24.2	13.5	1.749E-06	-3.354E-03	-1.509E+00
2855	36.5	10	14.85	1.749E-06	-3.354E-03	-1.509E+00
2856	44.9	26	16.23	1.749E-06	-3.354E-03	-1.509E+00
2857	56.8	27.8	18.22	1.749E-06	-3.354E-03	-1.509E+00
2858	61.9	( <sup>o</sup> )	19.16	1.749E-06	-3.354E-03	-1.509E+00
2859	55.5	13.5	19.76	1.749E-06	-3.354E-03	-1.509E+00
2860	38.2	( <sup>o</sup> )	20.55	1.749E-06	-3.354E-03	-1.509E+00
2861	40.9	( <sup>o</sup> )	21.16	1.749E-06	-3.354E-03	-1.509E+00
2862	43.5	( <sup>o</sup> )	21.76	1.749E-06	-3.354E-03	-1.509E+00
2863	44.3	( <sup>o</sup> )	21.97	1.749E-06	-3.354E-03	-1.509E+00
2864	41.6	( <sup>o</sup> )	21.39	1.749E-06	-3.354E-03	-1.509E+00
2865	39.5	( <sup>o</sup> )	20.87	1.749E-06	-3.354E-03	-1.509E+00
2866	37.3	( <sup>o</sup> )	20.39	1.749E-06	-3.354E-03	-1.509E+00
2867	37	( <sup>o</sup> )	20.28	1.749E-06	-3.354E-03	-1.509E+00

2868	37.4	(°)	20.38	1.749E-06	-3.354E-03	-1.509E+00
2869	37.7	(°)	20.44	1.749E-06	-3.354E-03	-1.509E+00
2870	38.8	(°)	20.69	1.749E-06	-3.354E-03	-1.509E+00
2871	39	(°)	20.75	1.749E-06	-3.354E-03	-1.509E+00
2872	38.5	(°)	20.63	1.749E-06	-3.354E-03	-1.509E+00
2873	38.5	(°)	20.63	1.749E-06	-3.354E-03	-1.509E+00
2874	38.7	(°)	20.67	1.749E-06	-3.354E-03	-1.509E+00
2875	38.6	(°)	20.64	1.749E-06	-3.354E-03	-1.509E+00
2876	41	7.9	21.18	1.749E-06	-3.354E-03	-1.509E+00
2877	41.1	(°)	21.21	1.749E-06	-3.354E-03	-1.509E+00
2878	42.5	18.9	21.5	1.749E-06	-3.354E-03	-1.509E+00
2879	46.9	37.1	22.46	1.749E-06	-3.354E-03	-1.509E+00
2880	54	59.6	24.02	1.749E-06	-3.354E-03	-1.509E+00
2881	59.1	32.2	25.23	1.749E-06	-3.354E-03	-1.509E+00
2882	64.1	48.6	26.33	1.749E-06	-3.354E-03	-1.509E+00
2883	71.8	61.2	28.08	1.749E-06	-3.354E-03	-1.509E+00
2884	88.5	48.4	30.11	1.749E-06	-3.354E-03	-1.509E+00
2885	46.5	2.9	29.79	1.749E-06	-3.354E-03	-1.509E+00
2886	47.6	80.3	30.43	1.749E-06	-3.354E-03	-1.509E+00
2887	53.5	84.4	32.17	1.749E-06	-3.354E-03	-1.509E+00
2888	60.7	91.2	34.34	1.749E-06	-3.354E-03	-1.509E+00
2889	68	89.5	36.57	1.749E-06	-3.354E-03	-1.509E+00
2890	83.8	30	38.16	1.749E-06	-3.354E-03	-1.509E+00
2891	38.8	3.1	37.86	1.749E-06	-3.354E-03	-1.509E+00
2892	40.5	84.5	38.44	1.749E-06	-3.354E-03	-1.509E+00
2893	43.8	87.5	39.75	1.749E-06	-3.354E-03	-1.509E+00
2894	47.6	94.8	41.35	1.749E-06	-3.354E-03	-1.509E+00
2895	51.6	97.2	43.01	1.749E-06	-3.354E-03	-1.509E+00
2896	55.2	89.3	44.52	1.749E-06	-3.354E-03	-1.509E+00
2897	57.4	71.7	45.47	1.749E-06	-3.354E-03	-1.509E+00
2898	59.1	71.9	46.15	1.749E-06	-3.354E-03	-1.509E+00
2899	61	85.6	46.91	8.186E-08	-1.400E-03	-1.640E+00
2900	62.4	77.7	47.54	-1.585E-06	5.535E-04	-1.771E+00
2901	63.3	66.2	47.93	-3.252E-06	2.507E-03	-1.901E+00
2902	63.7	57.5	48.09	-3.252E-06	2.507E-03	-1.901E+00
2903	64.8	12.5	48.73	-3.252E-06	2.507E-03	-1.901E+00
2904	36.2	0.2	48.99	-3.252E-06	2.507E-03	-1.901E+00
2905	36.1	40.1	48.91	-3.252E-06	2.507E-03	-1.901E+00
2906	36.4	53.8	49.02	-3.252E-06	2.507E-03	-1.901E+00
2907	37.2	62.7	49.46	-3.252E-06	2.507E-03	-1.901E+00
2908	38.3	67.1	50.09	-3.252E-06	2.507E-03	-1.901E+00
2909	39.6	51.8	50.81	-3.252E-06	2.507E-03	-1.901E+00
2910	40.1	54.1	51.09	-3.252E-06	2.507E-03	-1.901E+00
2911	40.1	34.6	51.12	-3.252E-06	2.507E-03	-1.901E+00
2912	39.8	40.2	50.96	-3.252E-06	2.507E-03	-1.901E+00
2913	40.8	56.1	51.48	-3.252E-06	2.507E-03	-1.901E+00
2914	40.3	37.3	51.21	-3.252E-06	2.507E-03	-1.901E+00
2915	40.6	45.8	51.36	-3.252E-06	2.507E-03	-1.901E+00
2916	40.6	(°)	51.47	-3.252E-06	2.507E-03	-1.901E+00
2917	40	11.8	51.13	-3.252E-06	2.507E-03	-1.901E+00
2918	40.1	18.5	51.14	-3.252E-06	2.507E-03	-1.901E+00
2919	39.2	25.2	50.64	-3.252E-06	2.507E-03	-1.901E+00
2920	38.8	40.6	50.38	-3.252E-06	2.507E-03	-1.901E+00
2921	39	38.4	50.51	-3.252E-06	2.507E-03	-1.901E+00
2922	39	40	50.51	-3.252E-06	2.507E-03	-1.901E+00
2923	38.6	71.7	50.24	-3.252E-06	2.507E-03	-1.901E+00
2924	38.9	89.2	50.37	-3.252E-06	2.507E-03	-1.901E+00
2925	40.1	18.1	51.15	-3.252E-06	2.507E-03	-1.901E+00
2926	40.5	(°)	51.42	-3.252E-06	2.507E-03	-1.901E+00
2927	40.5	(°)	51.4	-1.084E-06	8.357E-04	-6.338E-01
2928	40.1	(°)	51.2	1.084E-06	-8.357E-04	6.338E-01
2929	38.6	(°)	50.4	3.252E-06	-2.507E-03	1.901E+00
2930	36.9	(°)	49.46	3.252E-06	-2.507E-03	1.901E+00
2931	35.6	(°)	48.7	3.252E-06	-2.507E-03	1.901E+00
2932	34.3	(°)	47.97	3.252E-06	-2.507E-03	1.901E+00
2933	33.2	(°)	47.36	3.252E-06	-2.507E-03	1.901E+00
2934	32.4	7.6	46.87	3.252E-06	-2.507E-03	1.901E+00
2935	32.2	(°)	46.78	3.252E-06	-2.507E-03	1.901E+00
2936	31.3	30.2	46.25	3.252E-06	-2.507E-03	1.901E+00
2937	31.9	21.1	46.58	3.252E-06	-2.507E-03	1.901E+00
2938	31.2	8.6	46.21	3.252E-06	-2.507E-03	1.901E+00
2939	31.2	34.6	46.2	3.252E-06	-2.507E-03	1.901E+00

2940	31.4	5.8	46.33	3.252E-06	-2.507E-03	1.901E+00
2941	30.6	(°)	45.9	3.252E-06	-2.507E-03	1.901E+00
2942	29.8	(°)	45.44	3.252E-06	-2.507E-03	1.901E+00
2943	29.4	37.9	45.2	3.252E-06	-2.507E-03	1.901E+00
2944	30.2	66.9	45.55	3.252E-06	-2.507E-03	1.901E+00
2945	30.9	44.1	46.01	3.252E-06	-2.507E-03	1.901E+00
2946	31.1	35.5	46.15	3.252E-06	-2.507E-03	1.901E+00
2947	31.1	9.2	46.18	3.252E-06	-2.507E-03	1.901E+00
2948	30.4	20.2	45.75	3.252E-06	-2.507E-03	1.901E+00
2949	30.5	38.2	45.79	3.252E-06	-2.507E-03	1.901E+00
2950	31	51.1	46.04	3.252E-06	-2.507E-03	1.901E+00
2951	32.1	79.8	46.62	3.252E-06	-2.507E-03	1.901E+00
2952	32.8	30.1	47.1	3.252E-06	-2.507E-03	1.901E+00
2953	32.1	0.1	46.75	3.252E-06	-2.507E-03	1.901E+00
2954	31.2	(°)	46.21	3.252E-06	-2.507E-03	1.901E+00
2955	30.1	(°)	45.66	3.252E-06	-2.507E-03	1.901E+00
2956	29	(°)	45.04	3.252E-06	-2.507E-03	1.901E+00
2957	28.1	0.8	44.54	3.252E-06	-2.507E-03	1.901E+00
2958	28	19.9	44.41	3.252E-06	-2.507E-03	1.901E+00
2959	27.8	22	44.32	3.252E-06	-2.507E-03	1.901E+00
2960	27.4	(°)	44.13	3.252E-06	-2.507E-03	1.901E+00
2961	26.2	(°)	43.49	3.252E-06	-2.507E-03	1.901E+00
2962	25.3	(°)	42.96	3.252E-06	-2.507E-03	1.901E+00
2963	24.7	14.5	42.59	3.252E-06	-2.507E-03	1.901E+00
2964	24.4	34.1	42.43	3.252E-06	-2.507E-03	1.901E+00
2965	24.6	47.9	42.51	3.252E-06	-2.507E-03	1.901E+00
2966	25	59.8	42.68	3.252E-06	-2.507E-03	1.901E+00
2967	25	57.9	42.7	3.252E-06	-2.507E-03	1.901E+00
2968	24.6	66.1	42.5	3.252E-06	-2.507E-03	1.901E+00
2969	24	22.9	42.21	3.252E-06	-2.507E-03	1.901E+00
2970	21.8	40	40.98	3.252E-06	-2.507E-03	1.901E+00
2971	21.7	68.7	40.86	3.252E-06	-2.507E-03	1.901E+00
2972	22.8	(°)	41.59	3.252E-06	-2.507E-03	1.901E+00
2973	21.1	(°)	40.72	3.252E-06	-2.507E-03	1.901E+00
2974	18.3	(°)	39.16	3.252E-06	-2.507E-03	1.901E+00
2975	20.6	10.1	38.09	3.252E-06	-2.507E-03	1.901E+00
2976	40.2	3.7	37.78	1.084E-06	-8.357E-04	6.338E-01
2977	39.6	62.7	38.09	-1.084E-06	8.357E-04	-6.338E-01
2978	41.5	38.1	38.92	-3.252E-06	2.507E-03	-1.901E+00
2979	41.8	11.7	39.06	-3.252E-06	2.507E-03	-1.901E+00
2980	41.6	(°)	39.04	-3.252E-06	2.507E-03	-1.901E+00
2981	39.9	(°)	38.34	-3.252E-06	2.507E-03	-1.901E+00
2982	38.9	(°)	37.87	-3.252E-06	2.507E-03	-1.901E+00
2983	38.2	12.5	37.57	-3.252E-06	2.507E-03	-1.901E+00
2984	37.8	27	37.4	-3.252E-06	2.507E-03	-1.901E+00
2985	38.3	25.4	37.6	-3.252E-06	2.507E-03	-1.901E+00
2986	39	21	37.9	-3.252E-06	2.507E-03	-1.901E+00
2987	39.9	17.6	38.29	-3.252E-06	2.507E-03	-1.901E+00
2988	40.7	36.7	38.56	-3.252E-06	2.507E-03	-1.901E+00
2989	41.1	47.3	38.74	-3.252E-06	2.507E-03	-1.901E+00
2990	40.5	34.5	38.48	-3.252E-06	2.507E-03	-1.901E+00
2991	40.6	3.8	38.57	-3.252E-06	2.507E-03	-1.901E+00
2992	40.2	(°)	38.45	-3.252E-06	2.507E-03	-1.901E+00
2993	40	(°)	38.35	-3.252E-06	2.507E-03	-1.901E+00
2994	40.4	18.4	38.47	-3.252E-06	2.507E-03	-1.901E+00
2995	41.7	30.6	39	-3.252E-06	2.507E-03	-1.901E+00
2996	42.6	27.8	39.37	-3.252E-06	2.507E-03	-1.901E+00
2997	43.4	18.8	39.73	-3.252E-06	2.507E-03	-1.901E+00
2998	43.2	15.5	39.66	-3.252E-06	2.507E-03	-1.901E+00
2999	43.5	21.1	39.76	-2.595E-06	1.697E-03	-2.144E+00
3000	43.9	16.5	39.95	-1.937E-06	8.875E-04	-2.387E+00
3001	44.1	11	40.03	-1.279E-06	7.771E-05	-2.629E+00
3002	43.6	0.9	39.83	-1.279E-06	7.771E-05	-2.629E+00
3003	42.8	2.5	39.49	-1.279E-06	7.771E-05	-2.629E+00
3004	42.4	31.4	39.28	-1.279E-06	7.771E-05	-2.629E+00
3005	43.2	48.8	39.59	-1.279E-06	7.771E-05	-2.629E+00
3006	44.3	39.9	40.05	-1.279E-06	7.771E-05	-2.629E+00
3007	44.9	41.2	40.32	-1.279E-06	7.771E-05	-2.629E+00
3008	45.2	46.6	40.41	-1.279E-06	7.771E-05	-2.629E+00
3009	45.7	53.4	40.63	-1.279E-06	7.771E-05	-2.629E+00
3010	46.7	44.3	41.06	-1.279E-06	7.771E-05	-2.629E+00
3011	47.4	40.7	41.35	-1.279E-06	7.771E-05	-2.629E+00



3012	47.7	21.3	41.53	-1.279E-06	7.771E-05	-2.629E+00
3013	46.5	10.7	41.02	-1.279E-06	7.771E-05	-2.629E+00
3014	45.9	14	40.8	-1.279E-06	7.771E-05	-2.629E+00
3015	45.5	12.2	40.6	-1.279E-06	7.771E-05	-2.629E+00
3016	45.4	9.7	40.57	-1.279E-06	7.771E-05	-2.629E+00
3017	45	8.3	40.43	-1.279E-06	7.771E-05	-2.629E+00
3018	44.3	37.6	40.07	-1.279E-06	7.771E-05	-2.629E+00
3019	43.8	63.1	39.82	-1.279E-06	7.771E-05	-2.629E+00
3020	44.9	85.9	40.24	-1.279E-06	7.771E-05	-2.629E+00
3021	48.1	94.1	41.54	-1.279E-06	7.771E-05	-2.629E+00
3022	51	50.2	42.85	-1.279E-06	7.771E-05	-2.629E+00
3023	52.9	22.7	43.67	-1.279E-06	7.771E-05	-2.629E+00
3024	53.3	0.9	43.88	-1.279E-06	7.771E-05	-2.629E+00
3025	52.8	3.9	43.66	-1.279E-06	7.771E-05	-2.629E+00
3026	52.1	(°)	43.4	-1.279E-06	7.771E-05	-2.629E+00
3027	51.5	(°)	43.16	-1.279E-06	7.771E-05	-2.629E+00
3028	50.8	(°)	42.86	-1.279E-06	7.771E-05	-2.629E+00
3029	49.9	(°)	42.45	-1.279E-06	7.771E-05	-2.629E+00
3030	48.4	20.6	41.79	-1.279E-06	7.771E-05	-2.629E+00
3031	47.7	33.2	41.51	-1.279E-06	7.771E-05	-2.629E+00
3032	48.2	1.7	41.74	-1.279E-06	7.771E-05	-2.629E+00
3033	48.7	(°)	42.03	-1.279E-06	7.771E-05	-2.629E+00
3034	47.7	(°)	41.57	-1.279E-06	7.771E-05	-2.629E+00
3035	45.6	38.3	40.62	-1.279E-06	7.771E-05	-2.629E+00
3036	45.8	49.5	40.69	-1.279E-06	7.771E-05	-2.629E+00
3037	47	(°)	41.29	-1.279E-06	7.771E-05	-2.629E+00
3038	47.1	6.7	41.29	-1.279E-06	7.771E-05	-2.629E+00
3039	46.7	12.3	41.12	-1.279E-06	7.771E-05	-2.629E+00
3040	46.4	20.6	40.99	-1.279E-06	7.771E-05	-2.629E+00
3041	46.6	32.4	41.02	-1.279E-06	7.771E-05	-2.629E+00
3042	47.3	11.8	41.34	-1.279E-06	7.771E-05	-2.629E+00
3043	46.3	(°)	41	-1.279E-06	7.771E-05	-2.629E+00
3044	44.9	(°)	40.4	-1.279E-06	7.771E-05	-2.629E+00
3045	43.6	15.7	39.84	-1.279E-06	7.771E-05	-2.629E+00
3046	44	29.1	39.95	-1.279E-06	7.771E-05	-2.629E+00
3047	44.4	17.1	40.16	-1.279E-06	7.771E-05	-2.629E+00
3048	44.8	23	40.3	-1.279E-06	7.771E-05	-2.629E+00
3049	44.9	21.9	40.35	-1.279E-06	7.771E-05	-2.629E+00
3050	45.1	21.5	40.44	-1.279E-06	7.771E-05	-2.629E+00
3051	44.8	36.8	40.28	-1.279E-06	7.771E-05	-2.629E+00
3052	44.8	40	40.29	-1.279E-06	7.771E-05	-2.629E+00
3053	45.4	8.4	40.57	-1.279E-06	7.771E-05	-2.629E+00
3054	44.5	22.7	40.19	-1.279E-06	7.771E-05	-2.629E+00
3055	44	43	39.92	-1.279E-06	7.771E-05	-2.629E+00
3056	45.2	16.5	40.48	-1.279E-06	7.771E-05	-2.629E+00
3057	45.5	(°)	40.62	-1.279E-06	7.771E-05	-2.629E+00
3058	45	4	40.43	-4.265E-07	2.590E-05	-8.763E-01
3059	47	12.5	41.24	4.265E-07	-2.590E-05	8.763E-01
3060	45.8	(°)	40.82	1.279E-06	-7.771E-05	2.629E+00
3061	45.6	(°)	40.72	1.279E-06	-7.771E-05	2.629E+00
3062	45.2	(°)	40.56	1.279E-06	-7.771E-05	2.629E+00
3063	44.2	(°)	40.13	1.279E-06	-7.771E-05	2.629E+00
3064	42.6	(°)	39.45	1.279E-06	-7.771E-05	2.629E+00
3065	41.2	(°)	38.88	1.279E-06	-7.771E-05	2.629E+00
3066	39.6	(°)	38.22	1.279E-06	-7.771E-05	2.629E+00
3067	37.3	(°)	37.22	1.279E-06	-7.771E-05	2.629E+00
3068	35.6	(°)	36.53	1.279E-06	-7.771E-05	2.629E+00
3069	34.6	(°)	36.11	1.279E-06	-7.771E-05	2.629E+00
3070	33.4	(°)	35.63	1.279E-06	-7.771E-05	2.629E+00
3071	31.9	(°)	34.99	1.279E-06	-7.771E-05	2.629E+00
3072	29.8	(°)	34.12	1.279E-06	-7.771E-05	2.629E+00
3073	28.2	2.7	33.44	1.279E-06	-7.771E-05	2.629E+00
3074	28.7	25	33.59	1.279E-06	-7.771E-05	2.629E+00
3075	28	(°)	33.36	1.279E-06	-7.771E-05	2.629E+00
3076	27.2	(°)	33.07	1.279E-06	-7.771E-05	2.629E+00
3077	24.8	(°)	32.09	1.279E-06	-7.771E-05	2.629E+00
3078	21.8	(°)	30.8	1.279E-06	-7.771E-05	2.629E+00
3079	19.5	(°)	29.84	1.279E-06	-7.771E-05	2.629E+00
3080	17.4	(°)	28.96	1.279E-06	-7.771E-05	2.629E+00
3081	41.9	19.2	28.16	1.279E-06	-7.771E-05	2.629E+00
3082	38	(°)	27.61	1.279E-06	-7.771E-05	2.629E+00
3083	35.2	(°)	26.78	1.279E-06	-7.771E-05	2.629E+00

3084	31.2	(°)	25.54	1.279E-06	-7.771E-05	2.629E+00
3085	27.6	3	24.41	1.279E-06	-7.771E-05	2.629E+00
3086	29.3	42.9	24.87	1.279E-06	-7.771E-05	2.629E+00
3087	29.7	38.8	24.98	1.279E-06	-7.771E-05	2.629E+00
3088	27	(°)	24.23	1.279E-06	-7.771E-05	2.629E+00
3089	25.1	(°)	23.7	1.279E-06	-7.771E-05	2.629E+00
3090	20	(°)	22.18	1.279E-06	-7.771E-05	2.629E+00
3091	34.3	15.3	19.97	1.279E-06	-7.771E-05	2.629E+00
3092	25.8	(°)	17.8	1.279E-06	-7.771E-05	2.629E+00
3093	22.1	(°)	16.89	1.279E-06	-7.771E-05	2.629E+00
3094	20.7	(°)	16.57	1.279E-06	-7.771E-05	2.629E+00
3095	19	(°)	16.19	1.279E-06	-7.771E-05	2.629E+00
3096	34	17.2	15.05	1.279E-06	-7.771E-05	2.629E+00
3097	26.1	1.2	13.21	1.279E-06	-7.771E-05	2.629E+00
3098	11.7	7.9	8.67	1.279E-06	-7.771E-05	2.629E+00
3099	14.6	7.5	4.71	1.279E-06	-7.771E-05	2.629E+00
3100	2.1	0.3	2.23	1.279E-06	-7.771E-05	2.629E+00
3101	0.1	2.1	0.64	4.265E-07	-2.590E-05	8.763E-01
3102	0	0	0	-4.265E-07	2.590E-05	-8.763E-01
3103	0	0	0	-1.279E-06	7.771E-05	-2.629E+00
3124	0	0	0	-1.279E-06	7.771E-05	-2.629E+00
3125	0.6	10.4	0.19	-1.279E-06	7.771E-05	-2.629E+00
3126	7.6	32.5	1.28	-1.279E-06	7.771E-05	-2.629E+00
3127	14.8	14.4	2.8	-1.279E-06	7.771E-05	-2.629E+00
3128	33.9	8.5	3.61	-1.279E-06	7.771E-05	-2.629E+00
3129	57.6	11.5	4.62	-1.279E-06	7.771E-05	-2.629E+00
3130	66.3	12.2	5.82	-1.279E-06	7.771E-05	-2.629E+00
3131	71.7	30.5	6.74	-1.279E-06	7.771E-05	-2.629E+00
3132	44.1	5.8	8.12	-1.279E-06	7.771E-05	-2.629E+00
3133	53.4	37.5	9.38	-1.279E-06	7.771E-05	-2.629E+00
3134	106.1	78.9	13.44	-1.279E-06	7.771E-05	-2.629E+00
3135	43.8	1.9	13.76	-1.279E-06	7.771E-05	-2.629E+00
3136	60	59.6	16.08	-1.279E-06	7.771E-05	-2.629E+00
3137	90.4	70.2	20.49	-1.279E-06	7.771E-05	-2.629E+00
3138	62.1	1.8	20.87	-1.279E-06	7.771E-05	-2.629E+00
3139	71.3	61.6	22.66	-1.279E-06	7.771E-05	-2.629E+00
3140	85.2	26.5	25.16	-1.279E-06	7.771E-05	-2.629E+00
3141	54.6	20.2	25.48	-1.279E-06	7.771E-05	-2.629E+00
3142	64.1	71.4	27.67	-1.279E-06	7.771E-05	-2.629E+00
3143	76.1	46.3	30.65	-1.279E-06	7.771E-05	-2.629E+00
3144	51.8	0.8	31.12	-1.279E-06	7.771E-05	-2.629E+00
3145	50.9	(°)	31.4	-1.279E-06	7.771E-05	-2.629E+00
3146	51.3	(°)	31.52	-1.279E-06	7.771E-05	-2.629E+00
3147	51.6	(°)	31.63	-1.279E-06	7.771E-05	-2.629E+00
3148	51.9	(°)	31.73	-1.279E-06	7.771E-05	-2.629E+00
3149	51.9	(°)	31.71	-1.279E-06	7.771E-05	-2.629E+00
3150	51.4	(°)	31.57	-1.279E-06	7.771E-05	-2.629E+00
3151	50.2	(°)	31.23	-1.279E-06	7.771E-05	-2.629E+00
3152	48.6	(°)	30.73	-1.279E-06	7.771E-05	-2.629E+00
3153	47.3	(°)	30.3	-1.279E-06	7.771E-05	-2.629E+00
3154	47.1	(°)	30.21	-1.279E-06	7.771E-05	-2.629E+00
3155	47.9	4.9	30.46	-1.279E-06	7.771E-05	-2.629E+00
3156	49.6	14	30.96	-1.279E-06	7.771E-05	-2.629E+00
3157	52.5	26	31.86	-1.279E-06	7.771E-05	-2.629E+00
3158	54.8	14.1	32.6	-1.279E-06	7.771E-05	-2.629E+00
3159	56.1	5.8	33.02	-1.279E-06	7.771E-05	-2.629E+00
3160	57	3.4	33.28	-1.279E-06	7.771E-05	-2.629E+00
3161	57.9	5.5	33.57	-1.279E-06	7.771E-05	-2.629E+00
3162	58	7.5	33.87	-1.279E-06	7.771E-05	-2.629E+00
3163	34.6	(°)	33.8	-1.279E-06	7.771E-05	-2.629E+00
3164	34.3	(°)	33.67	-1.279E-06	7.771E-05	-2.629E+00
3165	34.2	20.5	33.61	-1.279E-06	7.771E-05	-2.629E+00
3166	34.8	25.1	33.83	-1.279E-06	7.771E-05	-2.629E+00
3167	35.3	24.8	34.04	-1.279E-06	7.771E-05	-2.629E+00
3168	36.1	30.5	34.35	-1.279E-06	7.771E-05	-2.629E+00
3169	37.2	32.4	34.77	-3.252E-07	-6.690E-04	-2.393E+00
3170	38.1	28.6	35.16	6.290E-07	-1.416E-03	-2.157E+00
3171	38.8	25.7	35.44	1.583E-06	-2.162E-03	-1.921E+00
3172	39.5	26.4	35.7	1.583E-06	-2.162E-03	-1.921E+00
3173	40.2	27	36	1.583E-06	-2.162E-03	-1.921E+00
3174	40.9	23.3	36.27	1.583E-06	-2.162E-03	-1.921E+00
3175	41.2	21.8	36.4	1.583E-06	-2.162E-03	-1.921E+00

3176	42	32.6	36.67	1.583E-06	-2.162E-03	-1.921E+00
3177	43.4	41.2	37.21	1.583E-06	-2.162E-03	-1.921E+00
3178	46.2	74.3	38.28	1.583E-06	-2.162E-03	-1.921E+00
3179	50.5	90.2	39.97	1.583E-06	-2.162E-03	-1.921E+00
3180	53.9	41.2	41.41	1.583E-06	-2.162E-03	-1.921E+00
3181	54.1	13.4	41.56	5.277E-07	-7.208E-04	-6.402E-01
3182	53.5	(°)	41.33	-5.277E-07	7.208E-04	6.402E-01
3183	51.9	(°)	40.72	-1.583E-06	2.162E-03	1.921E+00
3184	50.3	(°)	40.07	-1.583E-06	2.162E-03	1.921E+00
3185	48.4	(°)	39.34	-1.583E-06	2.162E-03	1.921E+00
3186	47	(°)	38.75	-1.583E-06	2.162E-03	1.921E+00
3187	46	(°)	38.34	-1.583E-06	2.162E-03	1.921E+00
3188	44.6	(°)	37.79	-1.583E-06	2.162E-03	1.921E+00
3189	42.5	(°)	37.02	-1.583E-06	2.162E-03	1.921E+00
3190	38.1	(°)	35.28	-1.583E-06	2.162E-03	1.921E+00
3191	35.1	(°)	34.03	-1.583E-06	2.162E-03	1.921E+00
3192	33	(°)	33.19	-1.583E-06	2.162E-03	1.921E+00
3193	31.5	(°)	32.55	-1.583E-06	2.162E-03	1.921E+00
3194	30.8	11.8	32.27	-1.583E-06	2.162E-03	1.921E+00
3195	30.8	15.6	32.23	-1.583E-06	2.162E-03	1.921E+00
3196	30.6	(°)	32.19	-1.583E-06	2.162E-03	1.921E+00
3197	28	(°)	31.26	-1.583E-06	2.162E-03	1.921E+00
3198	21.4	(°)	28.69	-1.583E-06	2.162E-03	1.921E+00
3199	33.8	6	25.33	-1.583E-06	2.162E-03	1.921E+00
3200	20.7	(°)	22.12	-1.583E-06	2.162E-03	1.921E+00
3201	32	8.3	19.64	-1.583E-06	2.162E-03	1.921E+00
3202	24	(°)	18.09	-1.583E-06	2.162E-03	1.921E+00
3203	19.9	(°)	17.06	-1.583E-06	2.162E-03	1.921E+00
3204	40.2	16.1	16.91	-1.583E-06	2.162E-03	1.921E+00
3205	43.3	26	17.48	-1.583E-06	2.162E-03	1.921E+00
3206	49.5	24.1	18.65	-1.583E-06	2.162E-03	1.921E+00
3207	52.6	16.2	19.24	-1.583E-06	2.162E-03	1.921E+00
3208	56.1	16.8	19.91	-1.583E-06	2.162E-03	1.921E+00
3209	57.4	1.5	20.18	-1.583E-06	2.162E-03	1.921E+00
3210	54.3	(°)	19.61	-1.583E-06	2.162E-03	1.921E+00
3211	51	(°)	18.99	-1.583E-06	2.162E-03	1.921E+00
3212	47.8	(°)	18.39	-1.583E-06	2.162E-03	1.921E+00
3213	44.7	(°)	17.8	-1.583E-06	2.162E-03	1.921E+00
3214	41	(°)	17.12	-1.583E-06	2.162E-03	1.921E+00
3215	37.3	(°)	16.42	-1.583E-06	2.162E-03	1.921E+00
3216	31.4	(°)	15.33	-1.583E-06	2.162E-03	1.921E+00
3217	20.8	(°)	13.35	-1.583E-06	2.162E-03	1.921E+00
3218	34.5	10.9	12.3	-1.583E-06	2.162E-03	1.921E+00
3219	29	(°)	11.67	-1.583E-06	2.162E-03	1.921E+00
3220	22.3	(°)	10.68	-1.583E-06	2.162E-03	1.921E+00
3221	13.8	(°)	9.44	-1.583E-06	2.162E-03	1.921E+00
3222	21.9	6.8	8.17	-1.583E-06	2.162E-03	1.921E+00
3223	16.8	6.7	7.78	-1.583E-06	2.162E-03	1.921E+00
3224	18.1	12.5	7.93	-1.583E-06	2.162E-03	1.921E+00
3225	19.5	9.6	8.1	-1.583E-06	2.162E-03	1.921E+00
3226	20.9	10.3	8.26	-1.583E-06	2.162E-03	1.921E+00
3227	21.1	4.8	8.28	-1.583E-06	2.162E-03	1.921E+00
3228	16.2	(°)	7.74	-1.583E-06	2.162E-03	1.921E+00
3229	19.6	9.3	6.1	-1.583E-06	2.162E-03	1.921E+00
3230	13.5	1.1	4.38	-1.583E-06	2.162E-03	1.921E+00
3231	18.2	(°)	3.83	-1.583E-06	2.162E-03	1.921E+00
3232	13.9	6.2	3.58	-5.277E-07	7.208E-04	6.402E-01
3233	20.5	14.6	3.94	5.277E-07	-7.208E-04	-6.402E-01
3234	33.4	9.2	4.66	1.583E-06	-2.162E-03	-1.921E+00
3235	43.5	8	5.23	1.583E-06	-2.162E-03	-1.921E+00
3236	54.4	8.7	5.84	1.583E-06	-2.162E-03	-1.921E+00
3237	66.2	9.2	6.5	1.583E-06	-2.162E-03	-1.921E+00
3238	43.1	1	6.49	1.583E-06	-2.162E-03	-1.921E+00
3239	54	16.4	7.41	1.583E-06	-2.162E-03	-1.921E+00
3240	69.3	13.6	8.51	1.583E-06	-2.162E-03	-1.921E+00
3241	65.5	13.2	8.99	1.583E-06	-2.162E-03	-1.921E+00
3242	50	26.4	9.1	1.583E-06	-2.162E-03	-1.921E+00
3243	62.2	8.9	10.26	1.583E-06	-2.162E-03	-1.921E+00
3244	60.4	4.5	10.19	1.583E-06	-2.162E-03	-1.921E+00
3245	33.7	(°)	9.77	1.583E-06	-2.162E-03	-1.921E+00
3246	27.5	(°)	9.05	1.583E-06	-2.162E-03	-1.921E+00
3247	16.4	(°)	7.78	1.583E-06	-2.162E-03	-1.921E+00

3248	23.9	6.8	6.52	1.583E-06	-2.162E-03	-1.921E+00
3249	13.5	(°)	5.82	2.099E-06	-3.681E-03	-1.983E+00
3250	21.9	1	4.99	2.615E-06	-5.199E-03	-2.046E+00
3251	15.2	8.3	4.66	3.131E-06	-6.718E-03	-2.109E+00
3252	24.2	16.5	5.29	3.131E-06	-6.718E-03	-2.109E+00
3253	35.3	10.4	6.09	3.131E-06	-6.718E-03	-2.109E+00
3254	41.6	5.6	6.54	3.131E-06	-6.718E-03	-2.109E+00
3255	39.6	(°)	6.41	3.131E-06	-6.718E-03	-2.109E+00
3256	37.9	3.5	6.29	3.131E-06	-6.718E-03	-2.109E+00
3257	40.2	5.7	6.44	3.131E-06	-6.718E-03	-2.109E+00
3258	43.8	5.7	6.7	3.131E-06	-6.718E-03	-2.109E+00
3259	47	5.1	6.93	3.131E-06	-6.718E-03	-2.109E+00
3260	51.7	7.4	7.26	3.131E-06	-6.718E-03	-2.109E+00
3261	60.2	10.7	7.86	3.131E-06	-6.718E-03	-2.109E+00
3262	69.7	10	8.54	3.131E-06	-6.718E-03	-2.109E+00
3263	45	0.1	8.49	3.131E-06	-6.718E-03	-2.109E+00
3264	37	(°)	7.97	3.131E-06	-6.718E-03	-2.109E+00
3265	29.3	(°)	7.28	3.131E-06	-6.718E-03	-2.109E+00
3266	20.4	(°)	6.46	3.131E-06	-6.718E-03	-2.109E+00
3267	12.8	(°)	5.76	3.131E-06	-6.718E-03	-2.109E+00
3268	30.2	4.2	5.62	3.131E-06	-6.718E-03	-2.109E+00
3269	45.6	23.4	6.79	3.131E-06	-6.718E-03	-2.109E+00
3270	66.8	15.6	8.32	1.044E-06	-2.239E-03	-7.030E-01
3271	77.2	13.6	9.08	-1.044E-06	2.239E-03	7.030E-01
3272	48.2	2.2	8.93	-3.131E-06	6.718E-03	2.109E+00
3273	41.3	(°)	8.38	-3.131E-06	6.718E-03	2.109E+00
3274	33.5	(°)	7.66	-3.131E-06	6.718E-03	2.109E+00
3275	26	(°)	6.97	-3.131E-06	6.718E-03	2.109E+00
3276	18.7	(°)	6.3	-3.131E-06	6.718E-03	2.109E+00
3277	12.2	0.2	5.74	-3.131E-06	6.718E-03	2.109E+00
3278	20.9	(°)	4.92	-3.131E-06	6.718E-03	2.109E+00
3279	12.8	6.5	3.34	-3.131E-06	6.718E-03	2.109E+00
3280	0	0	0.54	-1.044E-06	2.239E-03	7.030E-01
3281	0	0	0	1.044E-06	-2.239E-03	-7.030E-01
3282	0	0	0	3.131E-06	-6.718E-03	-2.109E+00
3556	0	0	0	3.131E-06	-6.718E-03	-2.109E+00
3557	0.6	11.9	0	3.131E-06	-6.718E-03	-2.109E+00
3558	6.5	28.8	0.49	3.131E-06	-6.718E-03	-2.109E+00
3559	7.2	27	2	3.131E-06	-6.718E-03	-2.109E+00
3560	15.7	15	2.83	3.131E-06	-6.718E-03	-2.109E+00
3561	34.4	12.3	3.62	3.131E-06	-6.718E-03	-2.109E+00
3562	64.6	16.7	4.91	3.131E-06	-6.718E-03	-2.109E+00
3563	50.3	4.6	5.41	3.131E-06	-6.718E-03	-2.109E+00
3564	65.3	30.7	6.38	3.131E-06	-6.718E-03	-2.109E+00
3565	47.8	14.2	7.69	3.131E-06	-6.718E-03	-2.109E+00
3566	38.7	32.5	8.06	3.131E-06	-6.718E-03	-2.109E+00
3567	84.4	74.8	12.11	3.131E-06	-6.718E-03	-2.109E+00
3568	42.8	4.5	13.12	3.131E-06	-6.718E-03	-2.109E+00
3569	44	39.1	13.79	1.044E-06	-2.239E-03	-7.030E-01
3570	45.5	(°)	14.11	-1.044E-06	2.239E-03	7.030E-01
3571	39.2	(°)	13.18	-3.131E-06	6.718E-03	2.109E+00
3572	30.6	(°)	11.93	-3.131E-06	6.718E-03	2.109E+00
3573	13.5	0.7	9.43	-3.131E-06	6.718E-03	2.109E+00
3574	14.7	7.9	5.1	-3.131E-06	6.718E-03	2.109E+00
3575	1.2	(°)	2.51	-3.131E-06	6.718E-03	2.109E+00
3576	0.1	5.8	1.8	-1.044E-06	2.239E-03	7.030E-01
3577	4.1	10.8	1.74	1.044E-06	-2.239E-03	-7.030E-01
3578	6.8	10.2	2.16	3.131E-06	-6.718E-03	-2.109E+00
3579	5.3	4.6	2.17	3.131E-06	-6.718E-03	-2.109E+00
3580	0.9	5.4	2	3.131E-06	-6.718E-03	-2.109E+00
3581	0.3	10.6	2.03	3.131E-06	-6.718E-03	-2.109E+00
3582	6.1	12.3	2.12	3.131E-06	-6.718E-03	-2.109E+00
3583	14.3	15.2	2.77	3.131E-06	-6.718E-03	-2.109E+00
3584	27.3	8.3	3.33	3.131E-06	-6.718E-03	-2.109E+00
3585	33.1	3.6	3.59	3.131E-06	-6.718E-03	-2.109E+00
3586	31.1	2.5	3.51	3.131E-06	-6.718E-03	-2.109E+00
3587	33.3	5.1	3.59	3.131E-06	-6.718E-03	-2.109E+00
3588	40.7	5.2	3.91	3.131E-06	-6.718E-03	-2.109E+00
3589	43.5	2.3	4.04	3.131E-06	-6.718E-03	-2.109E+00
3590	38.6	1.8	3.83	3.131E-06	-6.718E-03	-2.109E+00
3591	44.8	6.7	4.09	3.131E-06	-6.718E-03	-2.109E+00
3592	57.6	8.2	4.63	3.131E-06	-6.718E-03	-2.109E+00

3593	49.5	10.2	4.96	3.131E-06	-6.718E-03	-2.109E+00
3594	44.3	16.7	5.26	3.131E-06	-6.718E-03	-2.109E+00
3595	73.3	20.3	6.86	3.131E-06	-6.718E-03	-2.109E+00
3596	46.1	13	7.63	3.131E-06	-6.718E-03	-2.109E+00
3597	38.4	32.8	8.03	3.131E-06	-6.718E-03	-2.109E+00
3598	75	46	11.34	3.131E-06	-6.718E-03	-2.109E+00
3599	48.3	13.8	12.5	3.131E-06	-6.718E-03	-2.109E+00
3600	36.9	36.6	12.76	3.131E-06	-6.718E-03	-2.109E+00
3601	59.4	72.6	15.98	3.131E-06	-6.718E-03	-2.109E+00
3602	82.2	57.1	19.37	3.131E-06	-6.718E-03	-2.109E+00
3603	59.9	2.7	20.07	3.131E-06	-6.718E-03	-2.109E+00
3604	60.4	43.6	20.65	1.044E-06	-2.239E-03	-7.030E-01
3605	59.8	(°)	20.68	-1.044E-06	2.239E-03	7.030E-01
3606	47.9	(°)	18.48	-3.131E-06	6.718E-03	2.109E+00
3607	35.5	(°)	16.12	-3.131E-06	6.718E-03	2.109E+00
3608	26.5	(°)	14.4	-3.131E-06	6.718E-03	2.109E+00
3609	21.3	(°)	13.41	-3.131E-06	6.718E-03	2.109E+00
3610	33	7.2	11.79	-3.131E-06	6.718E-03	2.109E+00
3611	11.3	(°)	9.06	-3.131E-06	6.718E-03	2.109E+00
3612	19.5	12.5	6.43	-3.131E-06	6.718E-03	2.109E+00
3613	13.9	(°)	4.34	-3.131E-06	6.718E-03	2.109E+00
3614	0	0	2.11	-1.044E-06	2.239E-03	7.030E-01
3615	0	0	0	1.044E-06	-2.239E-03	-7.030E-01
3616	0	0	0	3.131E-06	-6.718E-03	-2.109E+00
3631	0	0	0	3.131E-06	-6.718E-03	-2.109E+00
3632	1.1	7.1	0	3.131E-06	-6.718E-03	-2.109E+00
3633	4.3	13.6	0.11	3.131E-06	-6.718E-03	-2.109E+00
3634	6.3	22.9	1.02	3.131E-06	-6.718E-03	-2.109E+00
3635	6.6	17	1.96	3.131E-06	-6.718E-03	-2.109E+00
3636	6.4	9.9	2.33	3.131E-06	-6.718E-03	-2.109E+00
3637	7.9	9.9	2.5	3.131E-06	-6.718E-03	-2.109E+00
3638	15.2	14	2.81	3.131E-06	-6.718E-03	-2.109E+00
3639	31.5	9.6	3.51	3.131E-06	-6.718E-03	-2.109E+00
3640	46.2	8.1	4.14	3.131E-06	-6.718E-03	-2.109E+00
3641	68.3	14.2	5.08	3.131E-06	-6.718E-03	-2.109E+00
3642	44.3	1.2	5.14	3.131E-06	-6.718E-03	-2.109E+00
3643	75.6	38.8	6.93	3.131E-06	-6.718E-03	-2.109E+00
3644	46	8.5	8.06	3.131E-06	-6.718E-03	-2.109E+00
3645	45	33.7	8.63	3.131E-06	-6.718E-03	-2.109E+00
3646	89.9	66.8	12.65	3.131E-06	-6.718E-03	-2.109E+00
3647	40.7	0.4	13.06	3.131E-06	-6.718E-03	-2.109E+00
3648	46	48	14.06	3.131E-06	-6.718E-03	-2.109E+00
3649	72.2	82.4	17.83	3.131E-06	-6.718E-03	-2.109E+00
3650	75.6	17.4	20.25	3.131E-06	-6.718E-03	-2.109E+00
3651	58.3	36	20.27	3.131E-06	-6.718E-03	-2.109E+00
3652	71.6	75	22.69	3.131E-06	-6.718E-03	-2.109E+00
3653	83.1	25.7	24.95	3.131E-06	-6.718E-03	-2.109E+00
3654	51.8	20.3	24.78	3.131E-06	-6.718E-03	-2.109E+00
3655	59.3	70.8	26.5	3.131E-06	-6.718E-03	-2.109E+00
3656	70.7	80.1	29.27	3.131E-06	-6.718E-03	-2.109E+00
3657	76.9	26.6	30.86	3.131E-06	-6.718E-03	-2.109E+00
3658	49.2	2.5	30.59	3.131E-06	-6.718E-03	-2.109E+00
3659	49.7	15.4	31	1.044E-06	-2.239E-03	-7.030E-01
3660	49.1	(°)	30.84	-1.044E-06	2.239E-03	7.030E-01
3661	47.5	(°)	30.33	-3.131E-06	6.718E-03	2.109E+00
3662	46.3	(°)	29.98	-3.131E-06	6.718E-03	2.109E+00
3663	44	(°)	29.27	-3.131E-06	6.718E-03	2.109E+00
3664	39.4	(°)	27.91	-3.131E-06	6.718E-03	2.109E+00
3665	33.2	(°)	25.96	-3.131E-06	6.718E-03	2.109E+00
3666	28.7	(°)	24.56	-3.131E-06	6.718E-03	2.109E+00
3667	23.1	(°)	22.84	-3.131E-06	6.718E-03	2.109E+00
3668	33.7	13.1	20.96	-3.131E-06	6.718E-03	2.109E+00
3669	30.5	(°)	19.66	-3.131E-06	6.718E-03	2.109E+00
3670	24.9	(°)	18.32	-3.131E-06	6.718E-03	2.109E+00
3671	28.2	13.5	15.79	-3.131E-06	6.718E-03	2.109E+00
3672	22.4	4.6	12.51	-3.131E-06	6.718E-03	2.109E+00
3673	16.2	2.1	9.73	-3.131E-06	6.718E-03	2.109E+00
3674	16.5	5.1	7.5	-3.131E-06	6.718E-03	2.109E+00
3675	14	7.2	5.34	-3.131E-06	6.718E-03	2.109E+00
3676	13.5	5.4	3.39	-3.131E-06	6.718E-03	2.109E+00
3677	0	0	2.14	-3.131E-06	6.718E-03	2.109E+00
3678	0	0	0.73	-1.044E-06	2.239E-03	7.030E-01

3679	0	0	0	1.044E-06	-2.239E-03	-7.030E-01
3680	0	0	0	3.131E-06	-6.718E-03	-2.109E+00
3681	0	0	0	3.131E-06	-6.718E-03	-2.109E+00
3682	6	24.4	0.26	3.131E-06	-6.718E-03	-2.109E+00
3683	7.7	33.4	2.05	3.131E-06	-6.718E-03	-2.109E+00
3684	25.5	15.4	3.24	3.131E-06	-6.718E-03	-2.109E+00
3685	50.1	13	4.29	3.131E-06	-6.718E-03	-2.109E+00
3686	77	16.7	5.45	3.131E-06	-6.718E-03	-2.109E+00
3687	45.5	1.1	5.36	3.131E-06	-6.718E-03	-2.109E+00
3688	96	52.9	7.76	3.131E-06	-6.718E-03	-2.109E+00
3689	34.5	2.6	7.59	3.131E-06	-6.718E-03	-2.109E+00
3690	59.4	53.3	9.89	3.131E-06	-6.718E-03	-2.109E+00
3691	89.5	33.2	13.3	3.131E-06	-6.718E-03	-2.109E+00
3692	39.2	2	13.14	3.131E-06	-6.718E-03	-2.109E+00
3693	56.1	63.8	15.5	3.131E-06	-6.718E-03	-2.109E+00
3694	83.3	70	19.5	3.131E-06	-6.718E-03	-2.109E+00
3695	59.2	0.3	20.13	3.131E-06	-6.718E-03	-2.109E+00
3696	61.6	50.6	20.86	3.131E-06	-6.718E-03	-2.109E+00
3697	77.6	83.9	23.79	3.131E-06	-6.718E-03	-2.109E+00
3698	57.3	6	24.88	3.131E-06	-6.718E-03	-2.109E+00
3699	53.5	43.8	25.15	3.131E-06	-6.718E-03	-2.109E+00
3700	62.9	79.6	27.36	3.131E-06	-6.718E-03	-2.109E+00
3701	75	95.3	30.28	3.131E-06	-6.718E-03	-2.109E+00
3702	53.6	4.6	31.04	3.131E-06	-6.718E-03	-2.109E+00
3703	50.6	46.1	31.22	3.131E-06	-6.718E-03	-2.109E+00
3704	56.4	79.9	32.96	3.131E-06	-6.718E-03	-2.109E+00
3705	64	93.9	35.29	3.131E-06	-6.718E-03	-2.109E+00
3706	69.6	37.6	37.14	3.131E-06	-6.718E-03	-2.109E+00
3707	70.6	21.5	37.49	3.131E-06	-6.718E-03	-2.109E+00
3708	68	11.4	37.47	3.131E-06	-6.718E-03	-2.109E+00
3709	43	12.2	37.14	3.131E-06	-6.718E-03	-2.109E+00
3710	44.5	29.6	37.67	3.131E-06	-6.718E-03	-2.109E+00
3711	44.4	10.1	37.68	1.044E-06	-2.239E-03	-7.030E-01
3712	44	7	37.52	-1.044E-06	2.239E-03	7.030E-01
3713	43.1	2	37.2	-3.131E-06	6.718E-03	2.109E+00
3714	42.3	1.1	36.88	-3.131E-06	6.718E-03	2.109E+00
3715	41.2	( <sup>o</sup> )	36.45	-3.131E-06	6.718E-03	2.109E+00
3716	40	( <sup>o</sup> )	35.98	-3.131E-06	6.718E-03	2.109E+00
3717	38.7	( <sup>o</sup> )	35.45	-3.131E-06	6.718E-03	2.109E+00
3718	37.5	( <sup>o</sup> )	34.98	-3.131E-06	6.718E-03	2.109E+00
3719	36	( <sup>o</sup> )	34.35	-3.131E-06	6.718E-03	2.109E+00
3720	34.9	( <sup>o</sup> )	33.94	-3.131E-06	6.718E-03	2.109E+00
3721	32.8	( <sup>o</sup> )	33.13	-3.131E-06	6.718E-03	2.109E+00
3722	29.5	( <sup>o</sup> )	31.82	-3.131E-06	6.718E-03	2.109E+00
3723	25.9	( <sup>o</sup> )	30.38	-3.131E-06	6.718E-03	2.109E+00
3724	22.6	( <sup>o</sup> )	29.06	-3.131E-06	6.718E-03	2.109E+00
3725	19.9	( <sup>o</sup> )	27.94	-3.131E-06	6.718E-03	2.109E+00
3726	37	7.2	27.13	-3.131E-06	6.718E-03	2.109E+00
3727	32.7	( <sup>o</sup> )	25.82	-3.131E-06	6.718E-03	2.109E+00
3728	25.5	( <sup>o</sup> )	23.6	-3.131E-06	6.718E-03	2.109E+00
3729	19.6	4.9	21.48	-3.131E-06	6.718E-03	2.109E+00
3730	31.1	( <sup>o</sup> )	19.84	-3.131E-06	6.718E-03	2.109E+00
3731	25.9	( <sup>o</sup> )	18.54	-3.131E-06	6.718E-03	2.109E+00
3732	22.1	( <sup>o</sup> )	17.61	-3.131E-06	6.718E-03	2.109E+00
3733	36.9	12.8	16.17	-3.131E-06	6.718E-03	2.109E+00
3734	23.5	( <sup>o</sup> )	13.88	-3.131E-06	6.718E-03	2.109E+00
3735	30.2	6.8	11.44	-3.131E-06	6.718E-03	2.109E+00
3736	15.8	( <sup>o</sup> )	9.74	-3.131E-06	6.718E-03	2.109E+00
3737	22.3	3.5	8.06	-3.131E-06	6.718E-03	2.109E+00
3738	19.3	15.3	6.77	-3.131E-06	6.718E-03	2.109E+00
3739	15.8	9.3	5.41	-3.131E-06	6.718E-03	2.109E+00
3740	16.9	8.5	4.04	-3.131E-06	6.718E-03	2.109E+00
3741	0	0	2.53	-3.131E-06	6.718E-03	2.109E+00
3742	0	0	1.29	-1.044E-06	2.239E-03	7.030E-01
3743	0	0	0	1.044E-06	-2.239E-03	-7.030E-01
3744	1.7	9.1	0.06	3.131E-06	-6.718E-03	-2.109E+00
3745	7.1	31.5	1.17	3.131E-06	-6.718E-03	-2.109E+00
3746	10.3	21.5	2.59	3.131E-06	-6.718E-03	-2.109E+00
3747	43	17.4	3.98	3.131E-06	-6.718E-03	-2.109E+00
3748	89.3	31.2	5.76	3.131E-06	-6.718E-03	-2.109E+00
3749	52.3	1.8	5.74	3.131E-06	-6.718E-03	-2.109E+00
3750	101.6	65.3	8.02	3.131E-06	-6.718E-03	-2.109E+00

3751	38	1.8	7.95	3.131E-06	-6.718E-03	-2.109E+00
3752	65.1	55.2	10.4	3.131E-06	-6.718E-03	-2.109E+00
3753	78.5	29.8	13.35	3.131E-06	-6.718E-03	-2.109E+00
3754	40.6	15.2	13.34	3.131E-06	-6.718E-03	-2.109E+00
3755	60.4	67.5	16.13	3.131E-06	-6.718E-03	-2.109E+00
3756	90	70.2	20.44	3.131E-06	-6.718E-03	-2.109E+00
3757	60.3	2.3	20.41	3.131E-06	-6.718E-03	-2.109E+00
3758	66.9	60.6	21.82	3.131E-06	-6.718E-03	-2.109E+00
3759	79.2	30	24.21	3.131E-06	-6.718E-03	-2.109E+00
3760	51.3	1.2	24.25	3.131E-06	-6.718E-03	-2.109E+00
3761	53.4	47.7	25.13	3.131E-06	-6.718E-03	-2.109E+00
3762	55.7	8.4	25.76	3.131E-06	-6.718E-03	-2.109E+00
3763	55.4	( <sup>o</sup> )	25.7	3.131E-06	-6.718E-03	-2.109E+00
3764	54.3	1.4	25.43	3.131E-06	-6.718E-03	-2.109E+00
3765	53.9	4.1	25.33	3.131E-06	-6.718E-03	-2.109E+00
3766	54.1	9.3	25.38	3.131E-06	-6.718E-03	-2.109E+00
3767	55.6	18.5	25.7	3.131E-06	-6.718E-03	-2.109E+00
3768	59.3	36.6	26.57	3.131E-06	-6.718E-03	-2.109E+00
3769	63.8	30.1	27.69	3.131E-06	-6.718E-03	-2.109E+00
3770	66.4	18.2	28.36	3.131E-06	-6.718E-03	-2.109E+00
3771	43.1	0.4	28.38	3.131E-06	-6.718E-03	-2.109E+00
3772	43	51.1	28.85	3.131E-06	-6.718E-03	-2.109E+00
3773	49.6	81	30.82	3.131E-06	-6.718E-03	-2.109E+00
3774	55.1	49	32.61	-4.060E-06	-1.596E-03	-2.202E+00
3775	58.9	44.6	33.79	-1.125E-05	3.526E-03	-2.294E+00
3776	62.5	46.7	34.91	-1.844E-05	8.648E-03	-2.387E+00
3777	64.9	25.7	35.71	-1.844E-05	8.648E-03	-2.387E+00
3778	65.7	13.7	35.98	-1.844E-05	8.648E-03	-2.387E+00
3779	41.7	0.4	35.85	-1.844E-05	8.648E-03	-2.387E+00
3780	40.5	31.8	36.07	-1.844E-05	8.648E-03	-2.387E+00
3781	41.2	21	36.4	-1.844E-05	8.648E-03	-2.387E+00
3782	41.2	7.1	36.43	-1.844E-05	8.648E-03	-2.387E+00
3783	41.2	11.4	36.39	-1.844E-05	8.648E-03	-2.387E+00
3784	41.6	20.9	36.54	-1.844E-05	8.648E-03	-2.387E+00
3785	42.2	21.1	36.79	-1.844E-05	8.648E-03	-2.387E+00
3786	42.8	19.8	37.01	-1.844E-05	8.648E-03	-2.387E+00
3787	43.8	30.5	37.39	-1.844E-05	8.648E-03	-2.387E+00
3788	44.4	17.7	37.66	-1.844E-05	8.648E-03	-2.387E+00
3789	45.2	27.6	37.98	-1.844E-05	8.648E-03	-2.387E+00
3790	45.7	16.6	38.18	-1.844E-05	8.648E-03	-2.387E+00
3791	46.7	31.9	38.56	-1.844E-05	8.648E-03	-2.387E+00
3792	47.7	27.1	38.96	-1.844E-05	8.648E-03	-2.387E+00
3793	49.1	37.5	39.52	-1.844E-05	8.648E-03	-2.387E+00
3794	50.8	40.8	40.19	-1.844E-05	8.648E-03	-2.387E+00
3795	52.7	45.9	40.94	-1.844E-05	8.648E-03	-2.387E+00
3796	54.7	44.6	41.74	-1.844E-05	8.648E-03	-2.387E+00
3797	56.7	46.3	42.52	-1.844E-05	8.648E-03	-2.387E+00
3798	58.9	52.6	43.37	-1.844E-05	8.648E-03	-2.387E+00
3799	60.1	16.2	43.94	-1.844E-05	8.648E-03	-2.387E+00
3800	58	( <sup>o</sup> )	43.21	-1.844E-05	8.648E-03	-2.387E+00
3801	34.9	( <sup>o</sup> )	42.38	-1.844E-05	8.648E-03	-2.387E+00
3802	32.8	3.8	41.99	-1.844E-05	8.648E-03	-2.387E+00
3803	32.2	( <sup>o</sup> )	41.68	-1.844E-05	8.648E-03	-2.387E+00
3804	31.2	( <sup>o</sup> )	41.2	-1.844E-05	8.648E-03	-2.387E+00
3805	29.8	( <sup>o</sup> )	40.52	-1.844E-05	8.648E-03	-2.387E+00
3806	28.7	( <sup>o</sup> )	39.92	-1.844E-05	8.648E-03	-2.387E+00
3807	27.3	( <sup>o</sup> )	39.25	-1.844E-05	8.648E-03	-2.387E+00
3808	25.7	( <sup>o</sup> )	38.45	-1.844E-05	8.648E-03	-2.387E+00
3809	24.9	( <sup>o</sup> )	37.98	-1.844E-05	8.648E-03	-2.387E+00
3810	23.7	( <sup>o</sup> )	37.42	-1.844E-05	8.648E-03	-2.387E+00
3811	22.7	( <sup>o</sup> )	36.9	-1.844E-05	8.648E-03	-2.387E+00
3812	21.9	( <sup>o</sup> )	36.47	-1.844E-05	8.648E-03	-2.387E+00
3813	20.7	( <sup>o</sup> )	35.88	-1.844E-05	8.648E-03	-2.387E+00
3814	19.4	( <sup>o</sup> )	35.48	-1.844E-05	8.648E-03	-2.387E+00
3815	38.2	1.1	35.24	-1.844E-05	8.648E-03	-2.387E+00
3816	38.1	22.8	35.17	-1.844E-05	8.648E-03	-2.387E+00
3817	39.7	39.3	35.76	-1.844E-05	8.648E-03	-2.387E+00
3818	41.4	29.7	36.43	-1.844E-05	8.648E-03	-2.387E+00
3819	41.8	14.7	36.65	-1.342E-05	6.645E-03	-2.027E+00
3820	41.9	12.7	36.69	-8.405E-06	4.643E-03	-1.667E+00
3821	42.2	21.3	36.77	-3.386E-06	2.640E-03	-1.307E+00
3822	43.4	31.2	37.26	-3.386E-06	2.640E-03	-1.307E+00

3823	44.2	21	37.59	-3.386E-06	2.640E-03	-1.307E+00
3824	44.7	18.6	37.78	-3.386E-06	2.640E-03	-1.307E+00
3825	45.1	17.6	37.96	-3.386E-06	2.640E-03	-1.307E+00
3826	45.4	16.8	38.05	-3.386E-06	2.640E-03	-1.307E+00
3827	45.9	18.5	38.25	-3.386E-06	2.640E-03	-1.307E+00
3828	46	13	38.32	-3.386E-06	2.640E-03	-1.307E+00
3829	46	14.4	38.33	-3.386E-06	2.640E-03	-1.307E+00
3830	46.4	10.9	38.46	-3.386E-06	2.640E-03	-1.307E+00
3831	45.5	(°)	38.15	-3.386E-06	2.640E-03	-1.307E+00
3832	44.4	(°)	37.72	-3.386E-06	2.640E-03	-1.307E+00
3833	42.8	(°)	37.08	-3.386E-06	2.640E-03	-1.307E+00
3834	41.1	(°)	36.43	-3.386E-06	2.640E-03	-1.307E+00
3835	39.2	(°)	35.66	-3.386E-06	2.640E-03	-1.307E+00
3836	38.1	(°)	35.2	-3.386E-06	2.640E-03	-1.307E+00
3837	37.9	10.9	35.1	-3.386E-06	2.640E-03	-1.307E+00
3838	37.9	12.9	35.1	-3.386E-06	2.640E-03	-1.307E+00
3839	38.3	17.9	35.22	-3.386E-06	2.640E-03	-1.307E+00
3840	38.7	8.5	35.4	-3.386E-06	2.640E-03	-1.307E+00
3841	37.6	(°)	35.02	-3.386E-06	2.640E-03	-1.307E+00
3842	37.6	14.5	34.95	-3.386E-06	2.640E-03	-1.307E+00
3843	37.5	8.5	34.93	-3.386E-06	2.640E-03	-1.307E+00
3844	37.4	7.6	34.88	-3.386E-06	2.640E-03	-1.307E+00
3845	36.9	5.2	34.72	-3.386E-06	2.640E-03	-1.307E+00
3846	36.9	13.2	34.69	-3.386E-06	2.640E-03	-1.307E+00
3847	37.2	13.9	34.8	-3.386E-06	2.640E-03	-1.307E+00
3848	37	6.9	34.75	-3.386E-06	2.640E-03	-1.307E+00
3849	36.8	2.4	34.65	-3.386E-06	2.640E-03	-1.307E+00
3850	35.8	(°)	34.27	-3.386E-06	2.640E-03	-1.307E+00
3851	35.2	3.1	34.02	-3.386E-06	2.640E-03	-1.307E+00
3852	34.6	2.3	33.78	-3.386E-06	2.640E-03	-1.307E+00
3853	34.4	10.4	33.7	-3.386E-06	2.640E-03	-1.307E+00
3854	34.5	10.5	33.71	-3.386E-06	2.640E-03	-1.307E+00
3855	34.3	6.5	33.64	-3.386E-06	2.640E-03	-1.307E+00
3856	34	4.6	33.52	-3.386E-06	2.640E-03	-1.307E+00
3857	33.5	6	33.34	-3.386E-06	2.640E-03	-1.307E+00
3858	33.8	20.3	33.42	-3.386E-06	2.640E-03	-1.307E+00
3859	34.7	28.4	33.77	-3.386E-06	2.640E-03	-1.307E+00
3860	35.8	31.3	34.24	-3.386E-06	2.640E-03	-1.307E+00
3861	37.2	29.8	34.76	-3.386E-06	2.640E-03	-1.307E+00
3862	37.8	18.2	35.05	-3.386E-06	2.640E-03	-1.307E+00
3863	38.1	14.9	35.16	-3.386E-06	2.640E-03	-1.307E+00
3864	38.4	11.4	35.28	-3.386E-06	2.640E-03	-1.307E+00
3865	37.6	(°)	35.01	-3.386E-06	2.640E-03	-1.307E+00
3866	37.1	1.7	34.79	-3.386E-06	2.640E-03	-1.307E+00
3867	36.2	(°)	34.42	-3.386E-06	2.640E-03	-1.307E+00
3868	35.2	(°)	34.03	-3.386E-06	2.640E-03	-1.307E+00
3869	34.4	(°)	33.69	-3.386E-06	2.640E-03	-1.307E+00
3870	34.1	10.8	33.59	-3.386E-06	2.640E-03	-1.307E+00
3871	34.3	14.3	33.65	-3.386E-06	2.640E-03	-1.307E+00
3872	34.5	13.3	33.72	-3.386E-06	2.640E-03	-1.307E+00
3873	34.6	12.7	33.78	-3.386E-06	2.640E-03	-1.307E+00
3874	34.7	12.1	33.8	-3.386E-06	2.640E-03	-1.307E+00
3875	34.9	19.8	33.88	-3.386E-06	2.640E-03	-1.307E+00
3876	36.2	30.9	34.36	-3.386E-06	2.640E-03	-1.307E+00
3877	36.6	15.7	34.57	-3.386E-06	2.640E-03	-1.307E+00
3878	37.1	13.5	34.77	-1.129E-06	8.799E-04	-4.358E-01
3879	36.2	(°)	34.44	1.129E-06	-8.799E-04	4.358E-01
3880	33.1	(°)	33.26	3.386E-06	-2.640E-03	1.307E+00
3881	29	(°)	31.65	3.386E-06	-2.640E-03	1.307E+00
3882	24.8	(°)	29.96	3.386E-06	-2.640E-03	1.307E+00
3883	21.1	(°)	28.47	3.386E-06	-2.640E-03	1.307E+00
3884	38.5	15.7	27.48	3.386E-06	-2.640E-03	1.307E+00
3885	35.8	(°)	26.73	3.386E-06	-2.640E-03	1.307E+00
3886	33.7	(°)	26.07	3.386E-06	-2.640E-03	1.307E+00
3887	30.7	(°)	25.15	3.386E-06	-2.640E-03	1.307E+00
3888	27.3	(°)	24.1	3.386E-06	-2.640E-03	1.307E+00
3889	26.6	13.3	23.83	3.386E-06	-2.640E-03	1.307E+00
3890	27.9	30.6	24.19	3.386E-06	-2.640E-03	1.307E+00
3891	30.7	41.6	25.07	3.386E-06	-2.640E-03	1.307E+00
3892	32.5	15.8	25.65	3.386E-06	-2.640E-03	1.307E+00
3893	31.9	(°)	25.51	3.386E-06	-2.640E-03	1.307E+00
3894	21.8	(°)	22.52	3.386E-06	-2.640E-03	1.307E+00



3895	25.6	4.2	17.98	3.386E-06	-2.640E-03	1.307E+00
3896	26.8	3.8	14.07	3.386E-06	-2.640E-03	1.307E+00
3897	20.2	2.5	10.09	3.386E-06	-2.640E-03	1.307E+00
3898	14.3	2.8	5.72	3.386E-06	-2.640E-03	1.307E+00
3899	11.3	6.7	3.24	3.386E-06	-2.640E-03	1.307E+00
3900	0	0	0.61	3.386E-06	-2.640E-03	1.307E+00
3901	0	0	0	3.386E-06	-2.640E-03	1.307E+00
3906	0	0	0	3.386E-06	-2.640E-03	1.307E+00
3907	0	0	0	6.559E-06	-6.283E-03	3.321E+00
3908	0	0	0	9.732E-06	-9.925E-03	5.334E+00
3909	0	0	0	1.291E-05	-1.357E-02	7.347E+00
3918	0	0	0	1.291E-05	-1.357E-02	7.347E+00
3919	3	5	0	1.291E-05	-1.357E-02	7.347E+00
3920	7	10	0	1.291E-05	-1.357E-02	7.347E+00
3921	6.7	32.8	0.66	1.291E-05	-1.357E-02	7.347E+00
3922	6.3	35	1.59	1.291E-05	-1.357E-02	7.347E+00
3923	5.8	25.2	2.33	1.291E-05	-1.357E-02	7.347E+00
3924	6.1	10.4	2.69	1.291E-05	-1.357E-02	7.347E+00
3925	0	0	2.52	1.291E-05	-1.357E-02	7.347E+00
3926	0.1	5.8	1.77	1.291E-05	-1.357E-02	7.347E+00
3927	0	0	0.66	1.291E-05	-1.357E-02	7.347E+00
3928	0	0	0	1.291E-05	-1.357E-02	7.347E+00
3929	0	0	0	1.291E-05	-1.357E-02	7.347E+00
3930	1.3	9.6	0	1.291E-05	-1.357E-02	7.347E+00
3931	6.3	36.6	0.32	1.291E-05	-1.357E-02	7.347E+00
3932	6.5	48.5	1.27	1.291E-05	-1.357E-02	7.347E+00
3933	5.9	38.4	2.24	1.291E-05	-1.357E-02	7.347E+00
3934	9.7	20.5	2.84	1.291E-05	-1.357E-02	7.347E+00
3935	17.5	14.9	3.17	1.291E-05	-1.357E-02	7.347E+00
3936	22.2	9	3.37	1.291E-05	-1.357E-02	7.347E+00
3937	22.6	4.6	3.39	1.291E-05	-1.357E-02	7.347E+00
3938	17.2	3.2	3.16	1.291E-05	-1.357E-02	7.347E+00
3939	10.7	( <sup>c</sup> )	2.89	1.291E-05	-1.357E-02	7.347E+00
3940	0	0	2.72	1.291E-05	-1.357E-02	7.347E+00
3941	0	0	2.11	1.291E-05	-1.357E-02	7.347E+00
3942	0	0	1.33	1.291E-05	-1.357E-02	7.347E+00
3943	0	0	0.85	1.291E-05	-1.357E-02	7.347E+00
3944	0	0	0.42	1.291E-05	-1.357E-02	7.347E+00
3945	0	0	0	1.291E-05	-1.357E-02	7.347E+00
4069	0	0	0	1.291E-05	-1.357E-02	7.347E+00
4070	1.2	9.5	0	1.291E-05	-1.357E-02	7.347E+00
4071	5.2	20.5	0.02	1.291E-05	-1.357E-02	7.347E+00
4072	5	20.8	0.43	1.291E-05	-1.357E-02	7.347E+00
4073	5.4	23.1	0.8	1.291E-05	-1.357E-02	7.347E+00
4074	5.1	18.1	1.22	1.291E-05	-1.357E-02	7.347E+00
4075	4.3	8.7	1.37	1.291E-05	-1.357E-02	7.347E+00
4076	0	0	1.34	1.291E-05	-1.357E-02	7.347E+00
4077	0	0	1.03	1.291E-05	-1.357E-02	7.347E+00
4078	0.8	6.4	0.65	1.291E-05	-1.357E-02	7.347E+00
4079	5.3	18.7	0.3	1.291E-05	-1.357E-02	7.347E+00
4080	4.8	19.6	0.26	1.291E-05	-1.357E-02	7.347E+00
4081	5.5	29.5	0.31	1.291E-05	-1.357E-02	7.347E+00
4082	6	38.2	0.92	1.291E-05	-1.357E-02	7.347E+00
4083	4.3	14.8	1.84	1.291E-05	-1.357E-02	7.347E+00
4084	4.3	8.7	1.92	1.291E-05	-1.357E-02	7.347E+00
4085	0.1	7.5	2.03	1.291E-05	-1.357E-02	7.347E+00
4086	0.1	5.9	2.46	1.291E-05	-1.357E-02	7.347E+00
4087	0.7	5.8	2.47	1.291E-05	-1.357E-02	7.347E+00
4088	0	0	2.68	1.291E-05	-1.357E-02	7.347E+00
4089	0	0	2.3	1.291E-05	-1.357E-02	7.347E+00
4090	0	0	1.2	1.291E-05	-1.357E-02	7.347E+00
4091	0	0	0.41	1.291E-05	-1.357E-02	7.347E+00
4092	0	0	0	1.291E-05	-1.357E-02	7.347E+00
4099	0	0	0	1.291E-05	-1.357E-02	7.347E+00
4100	0	0	0	1.174E-05	-1.229E-02	6.551E+00
4101	0	0	0	1.057E-05	-1.102E-02	5.754E+00
4102	0	0	0	9.395E-06	-9.748E-03	4.957E+00
4107	0	0	0	9.395E-06	-9.748E-03	4.957E+00
4108	0.9	5.4	0	9.395E-06	-9.748E-03	4.957E+00
4109	0.5	5.7	0	9.395E-06	-9.748E-03	4.957E+00
4110	0	0	0	9.395E-06	-9.748E-03	4.957E+00
4113	0	0	0	9.395E-06	-9.748E-03	4.957E+00

4114	0.3	10	0	9.395E-06	-9.748E-03	4.957E+00
4115	1.1	9.9	0	9.395E-06	-9.748E-03	4.957E+00
4116	1.6	9.7	0	9.395E-06	-9.748E-03	4.957E+00
4117	2.8	9.3	0	9.395E-06	-9.748E-03	4.957E+00
4118	2.3	9	0	9.395E-06	-9.748E-03	4.957E+00
4119	0.8	9.8	0	9.395E-06	-9.748E-03	4.957E+00
4120	1.4	9.6	0	9.395E-06	-9.748E-03	4.957E+00
4121	4.6	14	0.05	9.395E-06	-9.748E-03	4.957E+00
4122	4.5	13.1	0.2	9.395E-06	-9.748E-03	4.957E+00
4123	4.8	16	0.38	9.395E-06	-9.748E-03	4.957E+00
4124	5.1	18.8	0.54	9.395E-06	-9.748E-03	4.957E+00
4125	6	31.2	0.73	9.395E-06	-9.748E-03	4.957E+00
4126	7.1	52.5	1.23	9.395E-06	-9.748E-03	4.957E+00
4127	6	46	2.1	9.395E-06	-9.748E-03	4.957E+00
4128	9.5	25.5	2.83	9.395E-06	-9.748E-03	4.957E+00
4129	21.1	18.5	3.31	9.395E-06	-9.748E-03	4.957E+00
4130	32.1	12.2	3.78	9.395E-06	-9.748E-03	4.957E+00
4131	42	7.6	4.19	9.395E-06	-9.748E-03	4.957E+00
4132	48	9.1	4.44	9.395E-06	-9.748E-03	4.957E+00
4133	55.9	9.4	4.77	9.395E-06	-9.748E-03	4.957E+00
4134	33.8	14.3	4.64	9.395E-06	-9.748E-03	4.957E+00
4135	21.5	25	4.56	9.395E-06	-9.748E-03	4.957E+00
4136	24.7	9.1	4.75	9.395E-06	-9.748E-03	4.957E+00
4137	25.5	4.5	4.8	9.395E-06	-9.748E-03	4.957E+00
4138	28.7	9.9	4.98	9.395E-06	-9.748E-03	4.957E+00
4139	34.4	10.7	5.31	9.395E-06	-9.748E-03	4.957E+00
4140	40.5	4.7	5.65	9.395E-06	-9.748E-03	4.957E+00
4141	42.8	3.3	5.79	9.395E-06	-9.748E-03	4.957E+00
4142	43.4	0	5.82	9.395E-06	-9.748E-03	4.957E+00
4143	39.5	(°)	5.61	9.395E-06	-9.748E-03	4.957E+00
4144	34.1	(°)	5.3	9.395E-06	-9.748E-03	4.957E+00
4145	22	(°)	4.62	9.395E-06	-9.748E-03	4.957E+00
4146	0	0	2.84	9.395E-06	-9.748E-03	4.957E+00
4147	0	0	1.03	9.395E-06	-9.748E-03	4.957E+00
4148	0	0	0.44	9.395E-06	-9.748E-03	4.957E+00
4149	1.1	10.1	0.44	9.395E-06	-9.748E-03	4.957E+00
4150	7.2	38.5	1.04	9.395E-06	-9.748E-03	4.957E+00
4151	6.5	34.3	2.07	9.395E-06	-9.748E-03	4.957E+00
4152	6.2	18	2.69	9.395E-06	-9.748E-03	4.957E+00
4153	13.3	18.5	2.99	9.395E-06	-9.748E-03	4.957E+00
4154	21.3	13.1	3.32	9.395E-06	-9.748E-03	4.957E+00
4155	25.8	8.2	3.52	9.395E-06	-9.748E-03	4.957E+00
4156	27.2	6.2	3.57	9.395E-06	-9.748E-03	4.957E+00
4157	29.8	3	3.69	9.395E-06	-9.748E-03	4.957E+00
4158	29.7	3.6	3.68	9.395E-06	-9.748E-03	4.957E+00
4159	31.4	4.4	3.75	9.395E-06	-9.748E-03	4.957E+00
4160	31	5.6	3.73	9.395E-06	-9.748E-03	4.957E+00
4161	29.2	4.6	3.66	9.395E-06	-9.748E-03	4.957E+00
4162	27	5.2	3.57	9.395E-06	-9.748E-03	4.957E+00
4163	24	7.4	3.44	9.395E-06	-9.748E-03	4.957E+00
4164	22.2	8.8	3.37	9.395E-06	-9.748E-03	4.957E+00
4165	21.8	9	3.35	9.395E-06	-9.748E-03	4.957E+00
4166	23.2	8.6	3.41	9.395E-06	-9.748E-03	4.957E+00
4167	23.3	8.9	3.41	9.395E-06	-9.748E-03	4.957E+00
4168	21.2	6.4	3.33	9.395E-06	-9.748E-03	4.957E+00
4169	18.2	3.9	3.2	9.395E-06	-9.748E-03	4.957E+00
4170	13.7	7.6	3.01	9.395E-06	-9.748E-03	4.957E+00
4171	10.5	10.9	2.88	9.395E-06	-9.748E-03	4.957E+00
4172	9.9	7.9	2.85	9.395E-06	-9.748E-03	4.957E+00
4173	5.2	0.5	2.66	9.395E-06	-9.748E-03	4.957E+00
4174	0	0	2.19	9.395E-06	-9.748E-03	4.957E+00
4175	0	0	1.22	9.395E-06	-9.748E-03	4.957E+00
4176	0	0	0.53	9.395E-06	-9.748E-03	4.957E+00
4177	2.7	10	0.26	9.395E-06	-9.748E-03	4.957E+00
4178	5.1	19.6	0.04	9.395E-06	-9.748E-03	4.957E+00
4179	6.8	47.4	0.82	9.395E-06	-9.748E-03	4.957E+00
4180	6.2	45.8	1.96	9.395E-06	-9.748E-03	4.957E+00
4181	5.9	29.5	2.65	9.395E-06	-9.748E-03	4.957E+00
4182	10.2	15.6	2.86	9.395E-06	-9.748E-03	4.957E+00
4183	12.9	13.2	2.98	9.395E-06	-9.748E-03	4.957E+00
4184	13.8	17.7	3.01	9.395E-06	-9.748E-03	4.957E+00
4185	18.1	7.9	3.2	9.395E-06	-9.748E-03	4.957E+00

4186	17.3	3.6	3.16	9.395E-06	-9.748E-03	4.957E+00
4187	13.9	2.4	3.02	9.395E-06	-9.748E-03	4.957E+00
4188	12.6	0.6	2.97	9.395E-06	-9.748E-03	4.957E+00
4189	10.6	(°)	2.89	9.395E-06	-9.748E-03	4.957E+00
4190	8.1	4.3	2.77	9.395E-06	-9.748E-03	4.957E+00
4191	0	0	2.48	9.395E-06	-9.748E-03	4.957E+00
4192	0	0	1.81	9.395E-06	-9.748E-03	4.957E+00
4193	0	0	1.27	9.395E-06	-9.748E-03	4.957E+00
4194	0.8	8.7	1.01	9.395E-06	-9.748E-03	4.957E+00
4195	6.5	25	0.93	9.395E-06	-9.748E-03	4.957E+00
4196	6.3	28.5	1.41	9.395E-06	-9.748E-03	4.957E+00
4197	5.7	19.5	2	9.395E-06	-9.748E-03	4.957E+00
4198	5.4	10.8	2.3	9.395E-06	-9.748E-03	4.957E+00
4199	5.7	10.2	2.32	9.395E-06	-9.748E-03	4.957E+00
4200	6.6	16.4	2.4	9.395E-06	-9.748E-03	4.957E+00
4201	6.9	13.9	2.69	9.395E-06	-9.748E-03	4.957E+00
4202	0	0	2.58	9.395E-06	-9.748E-03	4.957E+00
4203	0	0	2.18	9.395E-06	-9.748E-03	4.957E+00
4204	0	0	1.79	9.395E-06	-9.748E-03	4.957E+00
4205	0	0	1.59	9.395E-06	-9.748E-03	4.957E+00
4206	0.2	5.8	1.44	9.395E-06	-9.748E-03	4.957E+00
4207	0.4	5.8	1.29	9.395E-06	-9.748E-03	4.957E+00
4208	0.7	10	1.24	9.395E-06	-9.748E-03	4.957E+00
4209	0.5	9.9	1.21	9.395E-06	-9.748E-03	4.957E+00
4210	0.1	5.9	1.01	9.395E-06	-9.748E-03	4.957E+00
4211	0	0	0.45	9.395E-06	-9.748E-03	4.957E+00
4212	0.6	8.4	0.07	9.395E-06	-9.748E-03	4.957E+00
4213	4.5	13.9	0	9.395E-06	-9.748E-03	4.957E+00
4214	4.9	19.7	0.06	9.395E-06	-9.748E-03	4.957E+00
4215	4.9	23.1	0.24	9.395E-06	-9.748E-03	4.957E+00
4216	4.7	22	0.44	9.395E-06	-9.748E-03	4.957E+00
4217	4.7	20.2	0.64	9.395E-06	-9.748E-03	4.957E+00
4218	4.4	15.3	0.78	9.395E-06	-9.748E-03	4.957E+00
4219	0	0	0.74	9.395E-06	-9.748E-03	4.957E+00
4220	1.3	9.9	0.72	9.395E-06	-9.748E-03	4.957E+00
4221	5.6	16.9	0.81	9.395E-06	-9.748E-03	4.957E+00
4222	5.3	14.9	1.05	9.395E-06	-9.748E-03	4.957E+00
4223	0.3	8.4	1.06	9.395E-06	-9.748E-03	4.957E+00
4224	0	0	1.04	9.395E-06	-9.748E-03	4.957E+00
4225	0.3	6.2	0.99	9.395E-06	-9.748E-03	4.957E+00
4226	0.1	5.8	0.88	9.395E-06	-9.748E-03	4.957E+00
4227	0	0	1.12	9.395E-06	-9.748E-03	4.957E+00
4228	0	0	1.03	9.395E-06	-9.748E-03	4.957E+00
4229	0	0	0.55	9.395E-06	-9.748E-03	4.957E+00
4230	0.6	8.3	0.01	9.395E-06	-9.748E-03	4.957E+00
4231	0	0	0	9.395E-06	-9.748E-03	4.957E+00
4249	0	0	0	9.395E-06	-9.748E-03	4.957E+00
4250	0	0	0	9.571E-06	-9.949E-03	4.821E+00
4251	0	0	0	9.747E-06	-1.015E-02	4.685E+00
4252	0	0	0	9.923E-06	-1.035E-02	4.549E+00
4871	0	0	0	9.923E-06	-1.035E-02	4.549E+00
4872	0.9	7.3	0	9.923E-06	-1.035E-02	4.549E+00
4873	0	0	0	9.923E-06	-1.035E-02	4.549E+00
4874	0	0	0	9.923E-06	-1.035E-02	4.549E+00
4875	1.1	6.6	0	9.923E-06	-1.035E-02	4.549E+00
4876	5.1	19.6	0	9.923E-06	-1.035E-02	4.549E+00
4877	6.3	42.9	0.4	9.923E-06	-1.035E-02	4.549E+00
4878	5.6	42.1	1.15	9.923E-06	-1.035E-02	4.549E+00
4879	5.1	28.9	1.82	9.923E-06	-1.035E-02	4.549E+00
4880	5.8	26.2	2.12	9.923E-06	-1.035E-02	4.549E+00
4881	6.1	23.6	2.56	9.923E-06	-1.035E-02	4.549E+00
4882	9.3	12.8	2.83	9.923E-06	-1.035E-02	4.549E+00
4883	12.1	12.2	2.94	9.923E-06	-1.035E-02	4.549E+00
4884	16.8	15.6	3.14	9.923E-06	-1.035E-02	4.549E+00
4885	26	16.1	3.52	9.923E-06	-1.035E-02	4.549E+00
4886	39.2	15.2	4.07	9.923E-06	-1.035E-02	4.549E+00
4887	55.7	15.4	4.76	9.923E-06	-1.035E-02	4.549E+00
4888	43.9	13.3	5.16	9.923E-06	-1.035E-02	4.549E+00
4889	36.9	23.2	5.44	9.923E-06	-1.035E-02	4.549E+00
4890	48	11.8	6.08	9.923E-06	-1.035E-02	4.549E+00
4891	55.2	13.7	6.49	9.923E-06	-1.035E-02	4.549E+00
4892	64.8	10.6	7.04	9.923E-06	-1.035E-02	4.549E+00

4893	33.1	0.7	7.06	9.923E-06	-1.035E-02	4.549E+00
4894	34.1	6.1	7.3	9.923E-06	-1.035E-02	4.549E+00
4895	32.1	(°)	7.15	9.923E-06	-1.035E-02	4.549E+00
4896	27.4	(°)	6.79	9.923E-06	-1.035E-02	4.549E+00
4897	18.5	(°)	6.08	9.923E-06	-1.035E-02	4.549E+00
4898	6.8	0.8	5.2	9.923E-06	-1.035E-02	4.549E+00
4899	0	0	4	9.923E-06	-1.035E-02	4.549E+00
4900	0	0	2.69	9.923E-06	-1.035E-02	4.549E+00
4901	0	0	1.3	9.923E-06	-1.035E-02	4.549E+00
4902	0	0	0.37	9.923E-06	-1.035E-02	4.549E+00
4903	0	0	0	9.923E-06	-1.035E-02	4.549E+00
4919	0	0	0	9.923E-06	-1.035E-02	4.549E+00
4920	0	0	0	9.399E-06	-9.777E-03	4.270E+00
4921	0	0	0	8.875E-06	-9.204E-03	3.992E+00
4922	0	0	0	8.351E-06	-8.632E-03	3.713E+00
5120	0	0	0	8.351E-06	-8.632E-03	3.713E+00
5121	1	7.5	0	8.351E-06	-8.632E-03	3.713E+00
5122	0	0	0	8.351E-06	-8.632E-03	3.713E+00
5123	0	0	0	8.351E-06	-8.632E-03	3.713E+00
5124	1.2	6.9	0	8.351E-06	-8.632E-03	3.713E+00
5125	5.9	28.2	0.07	8.351E-06	-8.632E-03	3.713E+00
5126	6	37.9	0.65	8.351E-06	-8.632E-03	3.713E+00
5127	5.7	36.4	1.29	8.351E-06	-8.632E-03	3.713E+00
5128	6.4	40.8	1.88	8.351E-06	-8.632E-03	3.713E+00
5129	7	44.4	2.48	8.351E-06	-8.632E-03	3.713E+00
5130	17.5	30.8	3.16	8.351E-06	-8.632E-03	3.713E+00
5131	33	16.5	3.81	8.351E-06	-8.632E-03	3.713E+00
5132	43.5	15.8	4.25	8.351E-06	-8.632E-03	3.713E+00
5133	54.5	11.2	4.71	8.351E-06	-8.632E-03	3.713E+00
5134	45.5	16.1	4.87	8.351E-06	-8.632E-03	3.713E+00
5135	23.1	31.7	4.65	8.351E-06	-8.632E-03	3.713E+00
5136	32.4	17.3	5.19	8.351E-06	-8.632E-03	3.713E+00
5137	40.6	6.3	5.66	8.351E-06	-8.632E-03	3.713E+00
5138	47.3	(°)	6.05	8.351E-06	-8.632E-03	3.713E+00
5139	50.3	(°)	6.22	8.351E-06	-8.632E-03	3.713E+00
5140	51	(°)	6.26	8.351E-06	-8.632E-03	3.713E+00
5141	48.1	(°)	6.1	8.351E-06	-8.632E-03	3.713E+00
5142	44.8	(°)	5.91	8.351E-06	-8.632E-03	3.713E+00
5143	40.4	(°)	5.66	8.351E-06	-8.632E-03	3.713E+00
5144	37.8	(°)	5.51	8.351E-06	-8.632E-03	3.713E+00
5145	36.4	(°)	5.42	8.351E-06	-8.632E-03	3.713E+00
5146	36.8	3.3	5.44	8.351E-06	-8.632E-03	3.713E+00
5147	41.2	2.4	5.7	8.351E-06	-8.632E-03	3.713E+00
5148	44.7	3.9	5.9	8.351E-06	-8.632E-03	3.713E+00
5149	50.1	5.6	6.21	8.351E-06	-8.632E-03	3.713E+00
5150	57.9	2.6	6.65	2.784E-06	-2.877E-03	1.238E+00
5151	57.9	12.3	6.84	-2.784E-06	2.877E-03	-1.238E+00
5152	24.4	(°)	6.54	-8.351E-06	8.632E-03	-3.713E+00
5153	16.9	1	5.94	-8.351E-06	8.632E-03	-3.713E+00
5154	10.7	0.7	5.45	-8.351E-06	8.632E-03	-3.713E+00
5155	28.2	16.1	4.74	-8.351E-06	8.632E-03	-3.713E+00
5156	5.3	1	3.66	-8.351E-06	8.632E-03	-3.713E+00
5157	0.1	6	2.44	-8.351E-06	8.632E-03	-3.713E+00
5158	0	0	1.55	-8.351E-06	8.632E-03	-3.713E+00
5159	0	0	1.16	-8.351E-06	8.632E-03	-3.713E+00
5160	0.4	5.8	0.82	-8.351E-06	8.632E-03	-3.713E+00
5161	1.4	9.5	0.52	-2.558E-06	2.662E-03	-1.372E+00
5162	6.2	28.4	0.59	3.235E-06	-3.307E-03	9.693E-01
5163	6.8	41	1.18	9.029E-06	-9.277E-03	3.311E+00
5164	5.7	34.4	2.06	9.029E-06	-9.277E-03	3.311E+00
5165	5.4	23.3	2.3	9.029E-06	-9.277E-03	3.311E+00
5166	5.9	22.2	2.34	9.029E-06	-9.277E-03	3.311E+00
5167	6.1	21.1	2.39	9.029E-06	-9.277E-03	3.311E+00
5168	6.2	19.5	2.45	9.029E-06	-9.277E-03	3.311E+00
5169	6.4	20.2	2.42	9.029E-06	-9.277E-03	3.311E+00
5170	6.9	29.3	2.28	9.029E-06	-9.277E-03	3.311E+00
5171	6	18.2	2.49	9.029E-06	-9.277E-03	3.311E+00
5172	6.7	26.6	2.37	9.029E-06	-9.277E-03	3.311E+00
5173	5.8	13.1	2.67	9.029E-06	-9.277E-03	3.311E+00
5174	7	10.2	2.73	9.029E-06	-9.277E-03	3.311E+00
5175	7.4	9.2	2.75	9.029E-06	-9.277E-03	3.311E+00
5176	7.5	9	2.75	9.029E-06	-9.277E-03	3.311E+00

5177	7.5	8.8	2.75	9.029E-06	-9.277E-03	3.311E+00
5178	7.5	8.8	2.75	9.029E-06	-9.277E-03	3.311E+00
5179	8.7	16.8	2.8	9.029E-06	-9.277E-03	3.311E+00
5180	20.1	20.7	3.27	9.029E-06	-9.277E-03	3.311E+00
5181	33.4	16	3.83	9.029E-06	-9.277E-03	3.311E+00
5182	49.7	13.4	4.51	9.029E-06	-9.277E-03	3.311E+00
5183	57.2	6.8	4.83	9.029E-06	-9.277E-03	3.311E+00
5184	26.8	1	4.73	9.029E-06	-9.277E-03	3.311E+00
5185	21.1	24.2	4.54	9.029E-06	-9.277E-03	3.311E+00
5186	25.4	14	4.79	9.029E-06	-9.277E-03	3.311E+00
5187	26.1	11.9	4.83	9.029E-06	-9.277E-03	3.311E+00
5188	28	7.4	4.94	9.029E-06	-9.277E-03	3.311E+00
5189	28.5	6	4.97	9.029E-06	-9.277E-03	3.311E+00
5190	28.5	5.7	4.97	9.029E-06	-9.277E-03	3.311E+00
5191	28.4	5.6	4.96	9.029E-06	-9.277E-03	3.311E+00
5192	28.2	5.6	4.95	9.029E-06	-9.277E-03	3.311E+00
5193	28.1	5.6	4.94	9.029E-06	-9.277E-03	3.311E+00
5194	27.9	5.7	4.94	9.029E-06	-9.277E-03	3.311E+00
5195	29.5	14.7	5.02	9.029E-06	-9.277E-03	3.311E+00
5196	40.8	21.2	5.66	9.029E-06	-9.277E-03	3.311E+00
5197	56.3	21.8	6.54	9.029E-06	-9.277E-03	3.311E+00
5198	68.3	13.8	7.24	9.029E-06	-9.277E-03	3.311E+00
5199	33.3	2.8	7.05	9.029E-06	-9.277E-03	3.311E+00
5200	42.1	40.5	7.9	9.029E-06	-9.277E-03	3.311E+00
5201	59.3	19.7	9.27	9.029E-06	-9.277E-03	3.311E+00
5202	67.3	9.5	9.92	9.029E-06	-9.277E-03	3.311E+00
5203	38.3	0.5	10.23	9.029E-06	-9.277E-03	3.311E+00
5204	42.7	37	10.89	9.029E-06	-9.277E-03	3.311E+00
5205	49.4	19.3	11.64	9.029E-06	-9.277E-03	3.311E+00
5206	56.8	10.7	12.44	9.029E-06	-9.277E-03	3.311E+00
5207	63.5	24.7	13.15	9.029E-06	-9.277E-03	3.311E+00
5208	42.4	13.5	13.24	9.029E-06	-9.277E-03	3.311E+00
5209	25.9	51.3	12.47	9.029E-06	-9.277E-03	3.311E+00
5210	30.8	72.4	13.18	9.029E-06	-9.277E-03	3.311E+00
5211	38.7	13.4	14.38	3.010E-06	-3.092E-03	1.104E+00
5212	38	(°)	14.3	-3.010E-06	3.092E-03	-1.104E+00
5213	31.1	(°)	13.3	-9.029E-06	9.277E-03	-3.311E+00
5214	18.8	(°)	11.48	-9.029E-06	9.277E-03	-3.311E+00
5215	9.7	17.8	9.06	-9.029E-06	9.277E-03	-3.311E+00
5216	2.1	0.2	6.13	-9.029E-06	9.277E-03	-3.311E+00
5217	0.1	5.8	3.32	-9.029E-06	9.277E-03	-3.311E+00
5218	0	0	1.29	-9.029E-06	9.277E-03	-3.311E+00
5219	0	0	0.34	-9.029E-06	9.277E-03	-3.311E+00
5220	0	0	0	-9.029E-06	9.277E-03	-3.311E+00
5249	0	0	0	-9.029E-06	9.277E-03	-3.311E+00
5250	0	0	0	-7.324E-07	8.211E-04	-3.593E-01
5251	0	0	0	7.564E-06	-7.634E-03	2.592E+00
5252	0	0	0	1.586E-05	-1.609E-02	5.543E+00
5282	0	0	0	1.586E-05	-1.609E-02	5.543E+00
5283	0.8	9.8	0	1.586E-05	-1.609E-02	5.543E+00
5284	6.6	37.6	0.49	1.586E-05	-1.609E-02	5.543E+00
5285	6.5	41.8	1.56	1.586E-05	-1.609E-02	5.543E+00
5286	5.7	27.5	2.36	1.586E-05	-1.609E-02	5.543E+00
5287	5.4	14.6	2.62	1.586E-05	-1.609E-02	5.543E+00
5288	4.3	4.8	2.35	1.586E-05	-1.609E-02	5.543E+00
5289	0	0	1.8	1.586E-05	-1.609E-02	5.543E+00
5290	0	0	0.99	1.586E-05	-1.609E-02	5.543E+00
5291	0	0	0.2	1.586E-05	-1.609E-02	5.543E+00
5292	1.8	9.6	0	1.586E-05	-1.609E-02	5.543E+00
5293	7.7	54.2	0.41	1.586E-05	-1.609E-02	5.543E+00
5294	7.2	74	2.08	1.586E-05	-1.609E-02	5.543E+00
5295	26.2	44	3.52	1.586E-05	-1.609E-02	5.543E+00
5296	56.6	26.2	4.78	1.586E-05	-1.609E-02	5.543E+00
5297	41.1	15.5	4.94	1.586E-05	-1.609E-02	5.543E+00
5298	15.7	3.7	4.03	1.586E-05	-1.609E-02	5.543E+00
5299	25.6	54.8	4.78	1.586E-05	-1.609E-02	5.543E+00
5300	58.4	41.3	6.64	1.586E-05	-1.609E-02	5.543E+00
5301	79.3	27.1	7.86	1.586E-05	-1.609E-02	5.543E+00
5302	45	0.8	7.98	1.586E-05	-1.609E-02	5.543E+00
5303	52.4	49	8.7	1.586E-05	-1.609E-02	5.543E+00
5304	84.7	84.8	11.22	1.586E-05	-1.609E-02	5.543E+00
5305	85.6	30.4	12.14	1.586E-05	-1.609E-02	5.543E+00

5306	47.3	2.8	11.42	1.586E-05	-1.609E-02	5.543E+00
5307	52.6	65.9	11.95	1.586E-05	-1.609E-02	5.543E+00
5308	67.5	87.5	13.53	1.586E-05	-1.609E-02	5.543E+00
5309	85.6	57.5	15.51	1.586E-05	-1.609E-02	5.543E+00
5310	92.5	52	16.26	1.586E-05	-1.609E-02	5.543E+00
5311	67.3	17.9	16.49	1.586E-05	-1.609E-02	5.543E+00
5312	50.8	39.2	16.16	1.586E-05	-1.609E-02	5.543E+00
5313	54.7	74.5	16.7	1.586E-05	-1.609E-02	5.543E+00
5314	61.2	90.7	17.65	1.586E-05	-1.609E-02	5.543E+00
5315	70.6	97	19.03	1.586E-05	-1.609E-02	5.543E+00
5316	82.2	95.2	20.76	1.586E-05	-1.609E-02	5.543E+00
5317	90.7	33.2	22.06	1.586E-05	-1.609E-02	5.543E+00
5318	53	2.5	22.66	1.586E-05	-1.609E-02	5.543E+00
5319	58.2	62	23.82	1.586E-05	-1.609E-02	5.543E+00
5320	64.7	43.3	25.15	1.586E-05	-1.609E-02	5.543E+00
5321	68.1	53.2	25.84	1.586E-05	-1.609E-02	5.543E+00
5322	70.3	80.1	26.27	1.586E-05	-1.609E-02	5.543E+00
5323	73.6	35	26.99	1.586E-05	-1.609E-02	5.543E+00
5324	74.1	26.3	27.09	1.586E-05	-1.609E-02	5.543E+00
5325	43.6	7.6	26.9	5.287E-06	-5.363E-03	1.848E+00
5326	37.1	12.3	26.76	-5.287E-06	5.363E-03	-1.848E+00
5327	35.9	8.2	26.41	-1.586E-05	1.609E-02	-5.543E+00
5328	34.1	(°)	25.95	-1.586E-05	1.609E-02	-5.543E+00
5329	30.2	(°)	24.87	-1.586E-05	1.609E-02	-5.543E+00
5330	23.3	(°)	23	-1.586E-05	1.609E-02	-5.543E+00
5331	14.2	(°)	20.44	-1.586E-05	1.609E-02	-5.543E+00
5332	30.7	1.7	17.84	-1.586E-05	1.609E-02	-5.543E+00
5333	19.7	(°)	16	-1.586E-05	1.609E-02	-5.543E+00
5334	15.1	12.6	15.03	-1.586E-05	1.609E-02	-5.543E+00
5335	43.1	5.7	14.64	-1.586E-05	1.609E-02	-5.543E+00
5336	39.2	(°)	14.48	-1.586E-05	1.609E-02	-5.543E+00
5337	35.7	(°)	13.98	-1.586E-05	1.609E-02	-5.543E+00
5338	30.1	(°)	13.14	-1.586E-05	1.609E-02	-5.543E+00
5339	24.4	(°)	12.28	-1.586E-05	1.609E-02	-5.543E+00
5340	21.6	(°)	11.86	-1.586E-05	1.609E-02	-5.543E+00
5341	21.3	(°)	11.81	-1.586E-05	1.609E-02	-5.543E+00
5342	20.1	4.4	11.62	-1.586E-05	1.609E-02	-5.543E+00
5343	20.1	10	11.63	-1.586E-05	1.609E-02	-5.543E+00
5344	20.4	6.1	11.67	-1.586E-05	1.609E-02	-5.543E+00
5345	19.1	(°)	11.48	-1.586E-05	1.609E-02	-5.543E+00
5346	16	(°)	11.03	-1.586E-05	1.609E-02	-5.543E+00
5347	12.8	(°)	10.54	-1.586E-05	1.609E-02	-5.543E+00
5348	9.4	(°)	10.04	-1.586E-05	1.609E-02	-5.543E+00
5349	8.4	(°)	9.9	-1.586E-05	1.609E-02	-5.543E+00
5350	8.2	(°)	9.88	-1.586E-05	1.609E-02	-5.543E+00
5351	32.6	20.1	9.63	-1.586E-05	1.609E-02	-5.543E+00
5352	27.9	(°)	9.32	-5.287E-06	5.363E-03	-1.848E+00
5353	26.6	20.9	9.18	5.287E-06	-5.363E-03	1.848E+00
5354	30.9	32	9.62	1.326E-05	-1.356E-02	4.569E+00
5355	33.2	21.5	9.89	1.065E-05	-1.104E-02	3.596E+00
5356	32.4	2.7	9.8	8.046E-06	-8.510E-03	2.622E+00
5357	34.7	19.6	10.04	8.046E-06	-8.510E-03	2.622E+00
5358	46.7	35.6	11.32	8.046E-06	-8.510E-03	2.622E+00
5359	61.8	44.7	12.94	8.046E-06	-8.510E-03	2.622E+00
5360	74.1	43.8	14.28	8.046E-06	-8.510E-03	2.622E+00
5361	79.1	27.1	14.83	8.046E-06	-8.510E-03	2.622E+00
5362	40	3	14.23	8.046E-06	-8.510E-03	2.622E+00
5363	38.7	58.8	14.35	8.046E-06	-8.510E-03	2.622E+00
5364	47	81.8	15.55	8.046E-06	-8.510E-03	2.622E+00
5365	59.3	92.7	17.36	8.046E-06	-8.510E-03	2.622E+00
5366	72.4	96.5	19.31	8.046E-06	-8.510E-03	2.622E+00
5367	80.9	50.4	20.61	8.046E-06	-8.510E-03	2.622E+00
5368	85.8	58	21.33	8.046E-06	-8.510E-03	2.622E+00
5369	47.8	0.5	21.32	8.046E-06	-8.510E-03	2.622E+00
5370	47.6	52.3	21.65	8.046E-06	-8.510E-03	2.622E+00
5371	52.8	81.7	22.7	8.046E-06	-8.510E-03	2.622E+00
5372	59.2	93.4	23.98	8.046E-06	-8.510E-03	2.622E+00
5373	65.5	98.3	25.28	8.046E-06	-8.510E-03	2.622E+00
5374	72.3	98.2	26.67	8.046E-06	-8.510E-03	2.622E+00
5375	75.3	21.6	27.33	8.046E-06	-8.510E-03	2.622E+00
5376	76.1	42.7	27.48	8.046E-06	-8.510E-03	2.622E+00
5377	40	1.5	27.03	8.046E-06	-8.510E-03	2.622E+00

5378	38.4	58.3	27.09	8.046E-06	-8.510E-03	2.622E+00
5379	40.8	83.1	27.75	8.046E-06	-8.510E-03	2.622E+00
5380	43.6	92.9	28.53	8.046E-06	-8.510E-03	2.622E+00
5381	46.7	96.7	29.38	8.046E-06	-8.510E-03	2.622E+00
5382	50.1	98.4	30.32	8.046E-06	-8.510E-03	2.622E+00
5383	53	99.3	31.15	8.046E-06	-8.510E-03	2.622E+00
5384	56.2	99	32.05	8.046E-06	-8.510E-03	2.622E+00
5385	59.9	58.3	33.11	8.046E-06	-8.510E-03	2.622E+00
5386	61.8	38.7	33.66	8.046E-06	-8.510E-03	2.622E+00
5387	62.9	41	33.95	8.046E-06	-8.510E-03	2.622E+00
5388	30.9	1.4	33.81	8.046E-06	-8.510E-03	2.622E+00
5389	29.2	64.2	33.85	8.046E-06	-8.510E-03	2.622E+00
5390	29.7	86	34.03	8.046E-06	-8.510E-03	2.622E+00
5391	30.5	93.5	34.31	8.046E-06	-8.510E-03	2.622E+00
5392	31.4	60	34.69	8.046E-06	-8.510E-03	2.622E+00
5393	31.8	34.9	34.86	8.046E-06	-8.510E-03	2.622E+00
5394	31.6	45.6	34.78	8.046E-06	-8.510E-03	2.622E+00
5395	31.8	45.8	34.83	2.682E-06	-2.837E-03	8.740E-01
5396	31.8	( <sup>o</sup> )	34.87	-2.682E-06	2.837E-03	-8.740E-01
5397	30.6	( <sup>o</sup> )	34.44	-8.046E-06	8.510E-03	-2.622E+00
5398	29.4	4.1	33.94	-8.046E-06	8.510E-03	-2.622E+00
5399	28.4	( <sup>o</sup> )	33.58	-8.046E-06	8.510E-03	-2.622E+00
5400	27.6	( <sup>o</sup> )	33.26	-8.046E-06	8.510E-03	-2.622E+00
5401	26.6	4.6	32.87	-8.046E-06	8.510E-03	-2.622E+00
5402	26	( <sup>o</sup> )	32.62	-8.046E-06	8.510E-03	-2.622E+00
5403	25	14.2	32.25	-8.046E-06	8.510E-03	-2.622E+00
5404	24.4	8.2	32.02	-8.046E-06	8.510E-03	-2.622E+00
5405	24.1	( <sup>o</sup> )	31.92	-8.046E-06	8.510E-03	-2.622E+00
5406	23.2	( <sup>o</sup> )	31.57	-8.046E-06	8.510E-03	-2.622E+00
5407	22.5	( <sup>o</sup> )	31.29	-8.046E-06	8.510E-03	-2.622E+00
5408	21.8	( <sup>o</sup> )	31	-8.046E-06	8.510E-03	-2.622E+00
5409	20.6	9.5	30.56	-8.046E-06	8.510E-03	-2.622E+00
5410	19.6	4.5	30.15	-8.046E-06	8.510E-03	-2.622E+00
5411	18.7	( <sup>o</sup> )	29.81	-8.046E-06	8.510E-03	-2.622E+00
5412	18	( <sup>o</sup> )	29.56	-8.046E-06	8.510E-03	-2.622E+00
5413	16.5	( <sup>o</sup> )	28.96	-8.046E-06	8.510E-03	-2.622E+00
5414	17.2	13.8	28.18	-8.046E-06	8.510E-03	-2.622E+00
5415	40.8	2.2	27.26	-8.046E-06	8.510E-03	-2.622E+00
5416	36.4	( <sup>o</sup> )	26.59	-8.046E-06	8.510E-03	-2.622E+00
5417	34.8	( <sup>o</sup> )	26.13	-8.046E-06	8.510E-03	-2.622E+00
5418	33.5	( <sup>o</sup> )	25.76	-8.046E-06	8.510E-03	-2.622E+00
5419	31.7	( <sup>o</sup> )	25.28	-8.046E-06	8.510E-03	-2.622E+00
5420	27.1	( <sup>o</sup> )	24	-8.046E-06	8.510E-03	-2.622E+00
5421	20	( <sup>o</sup> )	22.03	-8.046E-06	8.510E-03	-2.622E+00
5422	26.2	22.1	19.59	-8.046E-06	8.510E-03	-2.622E+00
5423	25.5	7.2	16.5	-8.046E-06	8.510E-03	-2.622E+00
5424	33.7	15.3	13.16	-8.046E-06	8.510E-03	-2.622E+00
5425	15.9	( <sup>o</sup> )	11.03	-8.046E-06	8.510E-03	-2.622E+00
5426	10.8	( <sup>o</sup> )	10.25	-8.046E-06	8.510E-03	-2.622E+00
5427	9.4	6.8	10.04	-2.682E-06	2.837E-03	-8.740E-01
5428	11	45	10.27	2.682E-06	-2.837E-03	8.740E-01
5429	15.6	61.7	10.94	8.046E-06	-8.510E-03	2.622E+00
5430	20.1	44.6	11.62	8.046E-06	-8.510E-03	2.622E+00
5431	23.1	47	12.06	8.046E-06	-8.510E-03	2.622E+00
5432	27	43	12.63	8.046E-06	-8.510E-03	2.622E+00
5433	31.6	43.2	13.3	8.046E-06	-8.510E-03	2.622E+00
5434	36.1	33	13.98	8.046E-06	-8.510E-03	2.622E+00
5435	38.7	21	14.38	8.046E-06	-8.510E-03	2.622E+00
5436	41.9	36.1	14.84	8.046E-06	-8.510E-03	2.622E+00
5437	47.2	48.6	15.6	8.046E-06	-8.510E-03	2.622E+00
5438	55.4	69.9	16.8	8.046E-06	-8.510E-03	2.622E+00
5439	65.4	71.9	18.28	8.046E-06	-8.510E-03	2.622E+00
5440	72.7	55	19.38	8.046E-06	-8.510E-03	2.622E+00
5441	76.7	33.4	19.99	8.046E-06	-8.510E-03	2.622E+00
5442	41.3	1.5	19.89	8.046E-06	-8.510E-03	2.622E+00
5443	39.1	49.6	19.92	8.046E-06	-8.510E-03	2.622E+00
5444	44	79.4	20.89	8.046E-06	-8.510E-03	2.622E+00
5445	50.2	58	22.17	8.046E-06	-8.510E-03	2.622E+00
5446	53.4	43.9	22.85	8.046E-06	-8.510E-03	2.622E+00
5447	56.3	52.2	23.42	8.046E-06	-8.510E-03	2.622E+00
5448	60.4	67.4	24.25	8.046E-06	-8.510E-03	2.622E+00
5449	64.7	61.3	25.14	8.046E-06	-8.510E-03	2.622E+00

5450	68	51.4	25.82	8.046E-06	-8.510E-03	2.622E+00
5451	70.9	50.6	26.43	8.046E-06	-8.510E-03	2.622E+00
5452	41	6.3	26.52	8.046E-06	-8.510E-03	2.622E+00
5453	36.5	46.3	26.57	8.046E-06	-8.510E-03	2.622E+00
5454	38	57.7	26.99	8.046E-06	-8.510E-03	2.622E+00
5455	39.9	59.5	27.49	8.046E-06	-8.510E-03	2.622E+00
5456	41.9	65.2	28.07	8.046E-06	-8.510E-03	2.622E+00
5457	44.4	77.2	28.74	8.046E-06	-8.510E-03	2.622E+00
5458	46.9	69.5	29.45	8.046E-06	-8.510E-03	2.622E+00
5459	48.7	48.9	29.97	8.046E-06	-8.510E-03	2.622E+00
5460	49.9	38.1	30.32	8.046E-06	-8.510E-03	2.622E+00
5461	50.3	19.6	30.43	8.046E-06	-8.510E-03	2.622E+00
5462	49.5	( <sup>a</sup> )	30.26	8.046E-06	-8.510E-03	2.622E+00
5463	48.2	( <sup>a</sup> )	29.88	2.682E-06	-2.837E-03	8.740E-01
5464	46.6	( <sup>a</sup> )	29.44	-2.682E-06	2.837E-03	-8.740E-01
5465	45.3	( <sup>a</sup> )	29.06	-8.046E-06	8.510E-03	-2.622E+00
5466	43.5	( <sup>a</sup> )	28.59	-8.046E-06	8.510E-03	-2.622E+00
5467	40.3	( <sup>a</sup> )	27.7	-8.046E-06	8.510E-03	-2.622E+00
5468	35.8	( <sup>a</sup> )	26.44	-8.046E-06	8.510E-03	-2.622E+00
5469	32.1	( <sup>a</sup> )	25.39	-8.046E-06	8.510E-03	-2.622E+00
5470	28.4	( <sup>a</sup> )	24.37	-8.046E-06	8.510E-03	-2.622E+00
5471	22.8	( <sup>a</sup> )	22.82	-8.046E-06	8.510E-03	-2.622E+00
5472	14.5	6.3	20.09	-8.046E-06	8.510E-03	-2.622E+00
5473	22.7	( <sup>a</sup> )	16.17	-8.046E-06	8.510E-03	-2.622E+00
5474	27.5	8.8	12.18	-8.046E-06	8.510E-03	-2.622E+00
5475	6.4	3.7	9.5	-8.046E-06	8.510E-03	-2.622E+00
5476	20.7	( <sup>a</sup> )	8.26	-8.046E-06	8.510E-03	-2.622E+00
5477	13.7	( <sup>a</sup> )	7.79	-8.046E-06	8.510E-03	-2.622E+00
5478	9.9	( <sup>a</sup> )	7.38	-8.046E-06	8.510E-03	-2.622E+00
5479	0	0	6.77	-8.046E-06	8.510E-03	-2.622E+00
5480	0	0	6.1	-8.046E-06	8.510E-03	-2.622E+00
5481	0	0	5.44	-8.046E-06	8.510E-03	-2.622E+00
5482	0	0	5.21	-8.046E-06	8.510E-03	-2.622E+00
5483	0.7	5.9	5.25	-8.046E-06	8.510E-03	-2.622E+00
5484	36.3	46.1	5.77	-8.046E-06	8.510E-03	-2.622E+00
5485	34.1	( <sup>a</sup> )	5.3	-8.046E-06	8.510E-03	-2.622E+00
5486	26.5	( <sup>a</sup> )	4.86	-8.046E-06	8.510E-03	-2.622E+00
5487	20.6	2.3	4.52	-8.046E-06	8.510E-03	-2.622E+00
5488	16	( <sup>a</sup> )	4.26	-8.046E-06	8.510E-03	-2.622E+00
5489	10.2	( <sup>a</sup> )	3.93	-8.046E-06	8.510E-03	-2.622E+00
5490	0	0	3.43	-8.046E-06	8.510E-03	-2.622E+00
5491	0	0	2.99	-8.046E-06	8.510E-03	-2.622E+00
5492	0	0	3.03	-8.046E-06	8.510E-03	-2.622E+00
5493	0	0	2.99	-8.046E-06	8.510E-03	-2.622E+00
5494	0	0	2.61	-8.046E-06	8.510E-03	-2.622E+00
5495	0	0	2.22	-8.046E-06	8.510E-03	-2.622E+00
5496	0	0	1.85	-8.046E-06	8.510E-03	-2.622E+00
5497	0	0	1.69	-8.046E-06	8.510E-03	-2.622E+00
5498	0	0	1.59	-8.046E-06	8.510E-03	-2.622E+00
5499	0	0	1.57	-8.046E-06	8.510E-03	-2.622E+00
5500	0	0	1.59	-8.046E-06	8.510E-03	-2.622E+00
5501	0	0	1.45	-8.046E-06	8.510E-03	-2.622E+00
5502	0	0	1.09	-8.046E-06	8.510E-03	-2.622E+00
5503	0	0	0.62	-8.046E-06	8.510E-03	-2.622E+00
5504	0	0	0.27	-8.046E-06	8.510E-03	-2.622E+00
5505	0	0	0	-8.046E-06	8.510E-03	-2.622E+00

<sup>a</sup>Closed throttle motoring.

### Appendix C of Part 1036—Default Engine Fuel Maps for § 1036.540

GEM contains the default steady-state fuel maps in this appendix for performing cycle-

average engine fuel mapping as described in § 1036.503(b)(2). Note that manufacturers have the option to replace these default values in GEM if they generate a steady-state fuel map as described in § 1036.535(b).

(a) Use the following default fuel map for compression-ignition engines that will be installed in Tractors and Vocational Heavy HDV:



Table 1 of Appendix C—Default Fuel Map for Compression-Ignition Engines Installed in Tractors and Vocational Heavy HDV

Engine Speed (r/min)	Engine Torque (N·m)	Fuel Mass Rate (g/sec)
666.7	0	0.436
833.3	0	0.665
1000.0	0	0.94
1166.7	0	1.002
1333.3	0	1.17
1500.0	0	1.5
1666.7	0	1.899
1833.3	0	2.378
2000.0	0	2.93
2166.7	0	3.516
2333.3	0	4.093
2500.0	0	4.672
500.0	300	0.974
666.7	300	1.405
833.3	300	1.873
1000.0	300	2.324
1166.7	300	2.598
1333.3	300	2.904
1500.0	300	3.397
1666.7	300	3.994
1833.3	300	4.643
2000.0	300	5.372
2166.7	300	6.141
2333.3	300	7.553
2500.0	300	8.449
500.0	600	1.723
666.7	600	2.391
833.3	600	3.121
1000.0	600	3.756
1166.7	600	4.197
1333.3	600	4.776
1500.0	600	5.492
1666.7	600	6.277
1833.3	600	7.129
2000.0	600	8.069
2166.7	600	9.745
2333.3	600	11.213
2500.0	600	12.59
500.0	900	2.637
666.7	900	3.444
833.3	900	4.243
1000.0	900	4.997
1166.7	900	5.802
1333.3	900	6.702
1500.0	900	7.676
1666.7	900	8.7
1833.3	900	9.821
2000.0	900	11.08
2166.7	900	13.051
2333.3	900	15.002
2500.0	900	16.862
500.0	1200	3.833
666.7	1200	4.679
833.3	1200	5.535
1000.0	1200	6.519
1166.7	1200	7.603
1333.3	1200	8.735
1500.0	1200	9.948

1666.7	1200	11.226
1833.3	1200	12.622
2000.0	1200	14.228
2166.7	1200	16.488
2333.3	1200	18.921
2500.0	1200	21.263
500.0	1500	6.299
666.7	1500	6.768
833.3	1500	6.95
1000.0	1500	8.096
1166.7	1500	9.399
1333.3	1500	10.764
1500.0	1500	12.238
1666.7	1500	13.827
1833.3	1500	15.586
2000.0	1500	17.589
2166.7	1500	20.493
2333.3	1500	23.366
2500.0	1500	26.055
500.0	1800	9.413
666.7	1800	9.551
833.3	1800	8.926
1000.0	1800	9.745
1166.7	1800	11.26
1333.3	1800	12.819
1500.0	1800	14.547
1666.7	1800	16.485
1833.3	1800	18.697
2000.0	1800	21.535
2166.7	1800	24.981
2333.3	1800	28.404
2500.0	1800	31.768
500.0	2100	13.128
666.7	2100	12.936
833.3	2100	12.325
1000.0	2100	11.421
1166.7	2100	13.174
1333.3	2100	14.969
1500.0	2100	16.971
1666.7	2100	19.274
1833.3	2100	22.09
2000.0	2100	25.654
2166.7	2100	29.399
2333.3	2100	32.958
2500.0	2100	36.543
500.0	2400	17.446
666.7	2400	16.922
833.3	2400	15.981
1000.0	2400	14.622
1166.7	2400	15.079
1333.3	2400	17.165
1500.0	2400	19.583
1666.7	2400	22.408
1833.3	2400	25.635
2000.0	2400	29.22
2166.7	2400	33.168
2333.3	2400	37.233
2500.0	2400	41.075
500.0	2700	22.365
666.7	2700	21.511
833.3	2700	20.225
1000.0	2700	17.549
1166.7	2700	17.131
1333.3	2700	19.588
1500.0	2700	22.514
1666.7	2700	25.574
1833.3	2700	28.909
2000.0	2700	32.407
2166.7	2700	36.18
2333.3	2700	40.454
2500.0	2700	44.968
500.0	3000	27.476

666.7	3000	22.613
833.3	3000	19.804
1000.0	3000	17.266
1166.7	3000	19.197
1333.3	3000	22.109
1500.0	3000	25.288
1666.7	3000	28.44
1833.3	3000	31.801
2000.0	3000	35.405
2166.7	3000	39.152
2333.3	3000	42.912
2500.0	3000	47.512

(b) Use the following default fuel map for compression-ignition engines that will be installed in Vocational Light HDV and Vocational Medium HDV:

Table 2 of Appendix C—Default Fuel Map for Compression-Ignition Engines Installed in Vocational Light HDV and Vocational Medium HDV

Engine Speed (r/min)	Engine Torque (N·m)	Fuel Mass Rate (g/sec)
708.3	0	0.255
916.7	0	0.263
1125.0	0	0.342
1333.3	0	0.713
1541.7	0	0.885
1750.0	0	1.068
1958.3	0	1.27
2166.7	0	1.593
2375.0	0	1.822
2583.3	0	2.695
2791.7	0	4.016
3000.0	0	5.324
500.0	120	0.515
708.3	120	0.722
916.7	120	0.837
1125.0	120	1.097
1333.3	120	1.438
1541.7	120	1.676
1750.0	120	1.993
1958.3	120	2.35
2166.7	120	2.769
2375.0	120	3.306
2583.3	120	4.004
2791.7	120	4.78
3000.0	120	5.567
500.0	240	0.862
708.3	240	1.158
916.7	240	1.462
1125.0	240	1.85
1333.3	240	2.246
1541.7	240	2.603
1750.0	240	3.086
1958.3	240	3.516
2166.7	240	4.093
2375.0	240	4.726
2583.3	240	5.372
2791.7	240	6.064
3000.0	240	6.745
500.0	360	1.221
708.3	360	1.651
916.7	360	2.099
1125.0	360	2.62

1333.3	360	3.116
1541.7	360	3.604
1750.0	360	4.172
1958.3	360	4.754
2166.7	360	5.451
2375.0	360	6.16
2583.3	360	7.009
2791.7	360	8.007
3000.0	360	8.995
500.0	480	1.676
708.3	480	2.194
916.7	480	2.76
1125.0	480	3.408
1333.3	480	4.031
1541.7	480	4.649
1750.0	480	5.309
1958.3	480	6.052
2166.7	480	6.849
2375.0	480	7.681
2583.3	480	8.783
2791.7	480	10.073
3000.0	480	11.36
500.0	600	2.147
708.3	600	2.787
916.7	600	3.478
1125.0	600	4.227
1333.3	600	4.999
1541.7	600	5.737
1750.0	600	6.511
1958.3	600	7.357
2166.7	600	8.289
2375.0	600	9.295
2583.3	600	10.541
2791.7	600	11.914
3000.0	600	13.286
500.0	720	2.744
708.3	720	3.535
916.7	720	4.356
1125.0	720	5.102
1333.3	720	5.968
1541.7	720	6.826
1750.0	720	7.733
1958.3	720	8.703
2166.7	720	9.792
2375.0	720	10.984
2583.3	720	12.311
2791.7	720	13.697
3000.0	720	15.071
500.0	840	3.518
708.3	840	4.338
916.7	840	5.186
1125.0	840	6.063
1333.3	840	6.929
1541.7	840	7.883
1750.0	840	8.94
1958.3	840	10.093
2166.7	840	11.329
2375.0	840	12.613
2583.3	840	13.983
2791.7	840	15.419
3000.0	840	16.853
500.0	960	4.251
708.3	960	5.098
916.7	960	5.974
1125.0	960	6.917
1333.3	960	7.889
1541.7	960	8.913
1750.0	960	10.152
1958.3	960	11.482
2166.7	960	12.87
2375.0	960	14.195
2583.3	960	15.562

2791.7	960	16.995
3000.0	960	18.492
500.0	1080	4.978
708.3	1080	5.928
916.7	1080	6.877
1125.0	1080	7.827
1333.3	1080	8.838
1541.7	1080	9.91
1750.0	1080	11.347
1958.3	1080	12.85
2166.7	1080	14.398
2375.0	1080	15.745
2583.3	1080	17.051
2791.7	1080	18.477
3000.0	1080	19.971
500.0	1200	5.888
708.3	1200	6.837
916.7	1200	7.787
1125.0	1200	8.736
1333.3	1200	9.786
1541.7	1200	10.908
1750.0	1200	12.541
1958.3	1200	14.217
2166.7	1200	15.925
2375.0	1200	17.3
2583.3	1200	18.606
2791.7	1200	19.912
3000.0	1200	21.357

(c) Use the following default fuel map for all spark-ignition engines:

Table 3 of Appendix C—Default Fuel Map for Spark-Ignition Engines

Engine Speed (r/min)	Engine Torque (N·m)	Fuel Mass Rate (g/sec)
875	0	0.535
1250	0	0.734
1625	0	0.975
2000	0	1.238
2375	0	1.506
2750	0	1.772
3125	0	2.07
3500	0	2.394
3875	0	2.795
4250	0	3.312
4625	0	3.349
5000	0	3.761
500	65	0.458
875	65	0.759
1250	65	1.065
1625	65	1.43
2000	65	1.812
2375	65	2.22
2750	65	2.65
3125	65	3.114
3500	65	3.646
3875	65	4.225
4250	65	4.861
4625	65	5.328
5000	65	6.028
500	130	0.666
875	130	1.063
1250	130	1.497
1625	130	1.976
2000	130	2.469
2375	130	3.015
2750	130	3.59

3125	130	4.218
3500	130	4.9
3875	130	5.652
4250	130	6.484
4625	130	7.308
5000	130	8.294
500	195	0.856
875	195	1.377
1250	195	1.923
1625	195	2.496
2000	195	3.111
2375	195	3.759
2750	195	4.49
3125	195	5.269
3500	195	6.13
3875	195	7.124
4250	195	8.189
4625	195	9.288
5000	195	10.561
500	260	1.079
875	260	1.716
1250	260	2.373
1625	260	3.083
2000	260	3.832
2375	260	4.599
2750	260	5.443
3125	260	6.391
3500	260	7.444
3875	260	8.564
4250	260	9.821
4625	260	11.268
5000	260	12.828
500	325	1.354
875	325	2.06
1250	325	2.844
1625	325	3.696
2000	325	4.579
2375	325	5.466
2750	325	6.434
3125	325	7.542
3500	325	8.685
3875	325	9.768
4250	325	11.011
4625	325	13.249
5000	325	15.095
500	390	1.609
875	390	2.44
1250	390	3.317
1625	390	4.31
2000	390	5.342
2375	390	6.362
2750	390	7.489
3125	390	8.716
3500	390	9.865
3875	390	10.957
4250	390	12.405
4625	390	15.229
5000	390	17.363
500	455	2.245
875	455	2.969
1250	455	3.867
1625	455	4.992
2000	455	6.215
2375	455	7.415
2750	455	8.76
3125	455	10.175
3500	455	11.53
3875	455	12.889
4250	455	14.686
4625	455	17.243
5000	455	19.633
500	520	3.497

875	520	4.444
1250	520	5.084
1625	520	5.764
2000	520	7.205
2375	520	8.597
2750	520	10.135
3125	520	11.708
3500	520	12.962
3875	520	14.225
4250	520	15.647
4625	520	17.579
5000	520	20.031
500	585	5.179
875	585	5.962
1250	585	5.8
1625	585	6.341
2000	585	7.906
2375	585	9.452
2750	585	10.979
3125	585	13.019
3500	585	13.966
3875	585	15.661
4250	585	16.738
4625	585	17.935
5000	585	19.272
500	650	6.834
875	650	7.316
1250	650	5.632
1625	650	6.856
2000	650	8.471
2375	650	10.068
2750	650	11.671
3125	650	14.655
3500	650	14.804
3875	650	16.539
4250	650	18.415
4625	650	19.152
5000	650	20.33

BILLING CODE 6560-50-C

**PART 1037—CONTROL OF EMISSIONS FROM NEW HEAVY-DUTY MOTOR VEHICLES**

■ 87. The authority citation for part 1037 continues to read as follows:

Authority: 42 U.S.C. 7401-7671q.

■ 88. Amend § 1037.1 by revising paragraph (a) to read as follows:

**§ 1037.1 Applicability.**

(a) The regulations in this part 1037 apply for all new heavy-duty vehicles, except as provided in §§ 1037.5 and 1037.104. This includes electric vehicles, fuel cell vehicles, and vehicles fueled by conventional and alternative fuels. This also includes certain trailers as described in §§ 1037.5, 1037.150, and 1037.801.

\* \* \* \* \*

■ 89. Amend § 1037.5 by revising paragraph (e) to read as follows:

**§ 1037.5 Excluded vehicles.**

\* \* \* \* \*

(e) Vehicles subject to the heavy-duty emission standards of 40 CFR part 86.

See 40 CFR 86.1816 and 86.1819 for emission standards that apply for these vehicles. This exclusion generally applies for complete heavy-duty vehicles at or below 14,000 pounds GVWR and all vehicles at or below 14,000 pounds GVWR that have no installed propulsion engine, such as electric vehicles.

\* \* \* \* \*

■ 90. Amend § 1037.10 by revising paragraph (c) to read as follows:

**§ 1037.10 How is this part organized?**

\* \* \* \* \*

(c) Subpart C of this part describes how to apply for a certificate of conformity.

\* \* \* \* \*

■ 91. Revise § 1037.101 to read as follows:

**§ 1037.101 Overview of emission standards.**

This part specifies emission standards for certain vehicles and for certain pollutants. This part contains standards and other regulations applicable to the emission of the air pollutant defined as the aggregate group of six greenhouse

gases: carbon dioxide, nitrous oxide, methane, hydrofluorocarbons, perfluorocarbons, and sulfur hexafluoride.

(a) You must show that vehicles meet the following emission standards:

(1) *Exhaust emissions of criteria pollutants.* Criteria pollutant standards for NO<sub>x</sub>, HC, PM, and CO apply as described in § 1037.102. These pollutants are sometimes described collectively as “criteria pollutants” because they are either criteria pollutants under the Clean Air Act or precursors to the criteria pollutants ozone and PM.

(2) *Exhaust emissions of greenhouse gases.* These pollutants are described collectively in this part as “greenhouse gas pollutants” because they are regulated primarily based on their impact on the climate. Emission standards apply as follows for greenhouse gas (GHG) emissions:

(i) CO<sub>2</sub>, CH<sub>4</sub>, and N<sub>2</sub>O emission standards apply as described in §§ 1037.105 through 1037.107.

(ii) Hydrofluorocarbon standards apply as described in § 1037.115(e). These pollutants are also “greenhouse



gas pollutants” but are treated separately from exhaust greenhouse gas pollutants listed in paragraph (b)(2)(i) of this section.

(3) *Fuel evaporative emissions.*

Requirements related to fuel evaporative emissions are described in § 1037.103.

(b) The regulated heavy-duty vehicles are addressed in different groups as follows:

(1) For criteria pollutants, vocational vehicles and tractors are regulated based on gross vehicle weight rating (GVWR), whether they are considered “spark-ignition” or “compression-ignition,” and whether they are first sold as complete or incomplete vehicles.

(2) For greenhouse gas pollutants, vehicles are regulated in the following groups:

(i) Tractors above 26,000 pounds GVWR.

(ii) Trailers.

(iii) Vocational vehicles.

(3) The greenhouse gas emission standards apply differently depending on the vehicle service class as described in § 1037.140. In addition, standards apply differently for vehicles with spark-ignition and compression-ignition engines. References in this part 1037 to “spark-ignition” or “compression-ignition” generally relate to the application of standards under 40 CFR 1036.140. For example, a vehicle with an engine certified to spark-ignition standards under 40 CFR part 1036 is generally subject to requirements under this part 1037 that apply for spark-ignition vehicles. However, note that emission standards for Heavy HDE are considered to be compression-ignition standards for purposes of applying vehicle emission standards under this part. Also, for spark-ignition engines voluntarily certified as compression-ignition engines under 40 CFR part 1036, you must choose at certification whether your vehicles are subject to spark-ignition standards or compression-ignition standards. Heavy-duty vehicles with no installed propulsion engine, such as electric vehicles, are subject to compression-ignition emission standards for the purpose of calculating emission credits.

(4) For evaporative and refueling emissions, vehicles are regulated based on the type of fuel they use. Vehicles fueled with volatile liquid fuels or gaseous fuels are subject to evaporative emission standards.

■ 92. Revise § 1037.102 to read as follows:

**§ 1037.102 Exhaust emission standards for NO<sub>x</sub>, HC, PM, and CO.**

(a) Engines installed in heavy-duty vehicles are subject to criteria pollutant standards for NO<sub>x</sub>, HC, PM, and CO under 40 CFR part 86 through model year 2026 and 40 CFR part 1036 for model years 2027 and later.

(b) Heavy-duty vehicles with no installed propulsion engine, such as electric vehicles, are subject to criteria pollutant standards under this part. The emission standards that apply are the same as the standards that apply for compression-ignition engines under 40 CFR 86.007–11 and 1036.104 for a given model year. Additional requirements apply to vehicles with no installed propulsion engine as specified in this part.

(1) Where this part references standards or other requirements in 40 CFR part 86 or 1036 that apply differently based on primary intended service class, apply the Light HDE provisions to Light HDV, apply the Medium HDE provisions to Medium HDV, and apply the Heavy HDE provisions to Heavy HDV.

(2) Criteria pollutant emission standards and related requirements apply for the useful life specified in 40 CFR 86.001–2 through model year 2026 and as specified in 40 CFR 1036.104 for model year 2027 and later. You may alternatively select the useful life values identified in § 1037.105(e) if you do not generate NO<sub>x</sub> credits under § 1037.616.

(3) The following requirements apply for vehicles generating NO<sub>x</sub> credits under § 1037.616:

(i) *Electric vehicles.* Measure initial useable battery energy for electric vehicles using the test procedure in § 1037.552. Useable battery energy must remain at or above 70 percent throughout the useful life.

(ii) *Fuel cell vehicles.* Measure initial fuel cell voltage for fuel cell vehicles using the test procedure in § 1037.554. Fuel cell voltage must remain at or above 80 percent throughout the useful life.

■ 93. Amend § 1037.103 by:

■ a. Revising paragraph (b)(1).

■ b. Removing paragraph (b)(6).

■ c. Revising paragraphs (f) and (g)(1) and (2).

The revisions read as follows:

**§ 1037.103 Evaporative and refueling emission standards.**

\* \* \* \* \*

(b) \* \* \*

(1) The refueling standards in 40 CFR 86.1813–17(b) apply to complete vehicles starting in model year 2022; they apply for incomplete vehicles starting in model year 2027.

\* \* \* \* \*

(f) *Useful life.* The evaporative and refueling emission standards of this section apply for the full useful life, expressed in service miles or calendar years, whichever comes first. The useful life values for the standards of this section are the same as the values described for evaporative emission standards in 40 CFR 86.1805.

(g) \* \* \*

(1) Auxiliary engines and associated fuel-system components must be installed when testing fully assembled vehicles. If the auxiliary engine draws fuel from a separate fuel tank, you must fill the extra fuel tank before the start of diurnal testing as described for the vehicle’s main fuel tank. Use good engineering judgment to ensure that any nonmetal portions of the fuel system related to the auxiliary engine have reached stabilized levels of permeation emissions. The auxiliary engine must not operate during the running loss test or any other portion of testing under this section.

(2) For testing with partially assembled vehicles, you may omit installation of auxiliary engines and associated fuel-system components as long as those components installed in the final configuration are certified to meet the applicable emission standards for Small SI equipment described in 40 CFR 1054.112 or for Large SI engines in 40 CFR 1048.105. For any fuel-system components that you do not install, your installation instructions must describe this certification requirement.

■ 94. Amend § 1037.105 by revising paragraphs (b)(1), (g)(2), and (h)(1) and (5) through (7) to read as follows:

**§ 1037.105 CO<sub>2</sub> emission standards for vocational vehicles.**

\* \* \* \* \*

(b) \* \* \*

(1) Model year 2027 and later vehicles are subject to CO<sub>2</sub> standards corresponding to the selected subcategories as shown in the following table:

TABLE 1 OF § 1037.105—PHASE 2 CO<sub>2</sub> STANDARDS FOR MODEL YEAR 2027 AND LATER VOCATIONAL VEHICLES [g/ton-mile]

Engine cycle	Vehicle size	Multi-purpose	Regional	Urban
Compression-ignition	Light HDV	325	286	361
Compression-ignition	Medium HDV	231	215	254
Compression-ignition	Heavy HDV	226	186	265
Spark-ignition	Light HDV	372	319	413
Spark-ignition	Medium HDV	268	247	297

\* \* \* \* \*

(g) \* \* \*  
 (2) Class 8 hybrid vehicles with Light HDE or Medium HDE may be certified to compression-ignition standards for

the Heavy HDV service class. You may generate and use credits as allowed for the Heavy HDV service class.

\* \* \* \* \*

(h) \* \* \*

(1) The following alternative emission standards apply by vehicle type and model year as follows:

TABLE 5 OF § 1037.105—PHASE 2 CUSTOM CHASSIS STANDARDS [g/ton-mile]

Vehicle type <sup>a</sup>	Assigned vehicle service class	MY 2021–2026	MY 2027+
School bus	Medium HDV	291	267
Motor home	Medium HDV	228	226
Coach bus	Heavy HDV	210	205
Other bus	Heavy HDV	300	282
Refuse hauler	Heavy HDV	313	298
Concrete mixer	Heavy HDV	319	316
Mixed-use vehicle	Heavy HDV	319	316
Emergency vehicle	Heavy HDV	324	319

<sup>a</sup> Vehicle types are generally defined in § 1037.801. “Other bus” includes any bus that is not a school bus or a coach bus. A “mixed-use vehicle” is one that meets at least one of the criteria specified in § 1037.631(a)(1) or (2).

\* \* \* \* \*

(5) Emergency vehicles are deemed to comply with the standards of this paragraph (h) if they use tires with TRRL at or below 8.4 N/kN (8.7 N/kN for model years 2021 through 2026).

(6) Concrete mixers and mixed-use vehicles are deemed to comply with the standards of this paragraph (h) if they use tires with TRRL at or below 7.1 N/kN (7.6 N/kN for model years 2021 through 2026).

(7) Motor homes are deemed to comply with the standards of this paragraph (h) if they have tires with TRRL at or below 6.0 N/kN (6.7 N/kN for model years 2021 through 2026) and automatic tire inflation systems or tire pressure monitoring systems with wheels on all axles.

\* \* \* \* \*  
 ■ 95. Amend § 1037.106 by revising paragraphs (b) and (f)(1) to read as follows:

**§ 1037.106 Exhaust emission standards for tractors above 26,000 pounds GVWR.**

\* \* \* \* \*

(b) The CO<sub>2</sub> standards for tractors above 26,000 pounds GVWR in Table 1 of this section apply based on modeling and testing as described in subpart F of this part. The provisions of § 1037.241 specify how to comply with these standards in this paragraph (b).

TABLE 1 OF § 1037.106—CO<sub>2</sub> STANDARDS FOR CLASS 7 AND CLASS 8 TRACTORS BY MODEL YEAR [g/ton-mile]

Subcategory <sup>a</sup>	Phase 1 standards for model years 2014–2016	Phase 1 standards for model years 2017–2020	Phase 2 standards for model years 2021–2023	Phase 2 standards for model years 2024–2026	Phase 2 standards for model years 2027 and later
Class 7 Low-Roof (all cab styles)	107	104	105.5	99.8	94.8
Class 7 Mid-Roof (all cab styles)	119	115	113.2	107.1	101.8
Class 7 High-Roof (all cab styles)	124	120	113.5	106.6	98.5
Class 8 Low-Roof Day Cab	81	80	80.5	76.2	72.3
Class 8 Low-Roof Sleeper Cab	68	66	72.3	68.0	64.1
Class 8 Mid-Roof Day Cab	88	86	85.4	80.9	76.8
Class 8 Mid-Roof Sleeper Cab	76	73	78.0	73.5	69.6
Class 8 High-Roof Day Cab	92	89	85.6	80.4	74.6
Class 8 High-Roof Sleeper Cab	75	72	75.7	70.7	64.3
Heavy-Haul Tractors			52.4	50.2	48.3

<sup>a</sup> Sub-category terms are defined in § 1037.801.

\* \* \* \* \*

(f) \* \* \*

(1) You may optionally certify 4×2 tractors with Heavy HDE to the

standards and useful life for Class 8 tractors, with no restriction on

generating or using emission credits within the Class 8 averaging set.

\* \* \* \* \*

■ 96. Amend § 1037.115 by revising paragraphs (a) and (e)(3) to read as follows:

§ 1037.115 Other requirements.

\* \* \* \* \*

(a) *Adjustable parameters.* Vehicles that have adjustable parameters must meet all the requirements of this part for any adjustment in the physically adjustable range. We may require that you set adjustable parameters to any specification within the adjustable range during any testing. See 40 CFR 1068.50 for general provisions related to adjustable parameters. You must ensure safe vehicle operation throughout the physically adjustable range of each adjustable parameter, including consideration of production tolerances. Note that adjustable roof fairings and trailer rear fairings are deemed not to be adjustable parameters.

\* \* \* \* \*

(e) \* \* \*

(3) If air conditioning systems are designed such that a compliance demonstration under 40 CFR 86.1867–12(a) is impossible or impractical, you may ask to use alternative means to demonstrate that your air conditioning system achieves an equivalent level of control.

■ 97. Amend § 1037.120 by revising paragraphs (b) and (c) to read as follows:

§ 1037.120 Emission-related warranty requirements.

\* \* \* \* \*

(b) *Warranty period.* (1) Except as specified in paragraph (b)(2) of this section, your emission-related warranty must be valid for at least:

(i) 5 years or 50,000 miles for Light HDV (except tires).

(ii) 5 years or 100,000 miles for Medium HDV and Heavy HDV (except tires).

(iii) 5 years for trailers (except tires).

(iv) 1 year for tires installed on trailers, and 2 years or 24,000 miles for all other tires.

(2) Your emission-related warranty with respect to the standards under § 1037.102(b) must be valid for at least the periods specified for engines in 40 CFR 1036.120(b) if you generate NO<sub>x</sub> credits under § 1037.616.

(3) You may offer an emission-related warranty more generous than we require. The emission-related warranty for the vehicle may not be shorter than any basic mechanical warranty you provide to that owner without charge for the vehicle. Similarly, the emission-related warranty for any component

may not be shorter than any warranty you provide to that owner without charge for that component. This means that your warranty for a given vehicle may not treat emission-related and nonemission-related defects differently for any component. The warranty period begins when the vehicle is placed into service.

(c) *Components covered.* The emission-related warranty covers tires, automatic tire inflation systems, tire pressure monitoring systems, vehicle speed limiters, idle-reduction systems, hybrid system components, and devices added to the vehicle to improve aerodynamic performance (not including standard components such as hoods or mirrors even if they have been optimized for aerodynamics), to the extent such emission-related components are included in your application for certification. The emission-related warranty also covers other added emission-related components to the extent they are included in your application for certification. The emission-related warranty covers components designed to meet requirements under § 1037.102(b)(3). The emission-related warranty covers all components whose failure would increase a vehicle's emissions of air conditioning refrigerants (for vehicles subject to air conditioning leakage standards), and it covers all components whose failure would increase a vehicle's evaporative and refueling emissions (for vehicles subject to evaporative and refueling emission standards). The emission-related warranty covers these components even if another company produces the component. Your emission-related warranty does not need to cover components whose failure would not increase a vehicle's emissions of any regulated pollutant.

\* \* \* \* \*  
■ 98. Amend § 1037.125 by revising paragraph (d) to read as follows:

§ 1037.125 Maintenance instructions and allowable maintenance.

\* \* \* \* \*

(d) *Noncritical emission-related maintenance.* Subject to the provisions of this paragraph (d), you may schedule any amount of emission-related inspection or maintenance that is not covered by paragraph (a) of this section (that is, maintenance that is neither explicitly identified as critical emission-related maintenance, nor that we approve as critical emission-related maintenance). Noncritical emission-related maintenance generally includes maintenance on the components we specify in 40 CFR part 1068, appendix

A, that is not covered in paragraph (a) of this section. You must state in the owners manual that these steps are not necessary to keep the emission-related warranty valid. If operators fail to do this maintenance, this does not allow you to disqualify those vehicles from in-use testing or deny a warranty claim. Do not take these inspection or maintenance steps during service accumulation on your emission-data vehicles.

\* \* \* \* \*

■ 99. Amend § 1037.130 by revising paragraph (b)(3) to read as follows:

§ 1037.130 Assembly instructions for secondary vehicle manufacturers.

\* \* \* \* \*

(b) \* \* \*

(3) Describe the necessary steps for installing emission-related diagnostic systems.

\* \* \* \* \*

■ 100. Amend § 1037.135 by revising paragraph (c)(6) to read as follows:

§ 1037.135 Labeling.

\* \* \* \* \*

(c) \* \* \*

(6) Identify the emission control system. Use terms and abbreviations as described in appendix C to this part or other applicable conventions. Phase 2 tractors and Phase 2 vocational vehicles may omit this information.

\* \* \* \* \*

■ 101. Amend § 1037.140 by revising paragraph (g) to read as follows:

§ 1037.140 Classifying vehicles and determining vehicle parameters.

\* \* \* \* \*

(g) The standards and other provisions of this part apply to specific vehicle service classes for tractors and vocational vehicles as follows:

(1) Phase 1 and Phase 2 tractors are divided based on GVWR into Class 7 tractors and Class 8 tractors. Where provisions of this part apply to both tractors and vocational vehicles, Class 7 tractors are considered "Medium HDV" and Class 8 tractors are considered "Heavy HDV". This paragraph (g)(1) applies for hybrid and non-hybrid vehicles.

(2) Phase 1 vocational vehicles are divided based on GVWR. "Light HDV" includes Class 2b through Class 5 vehicles; "Medium HDV" includes Class 6 and Class 7 vehicles; and "Heavy HDV" includes Class 8 vehicles.

(3) Phase 2 vocational vehicles propelled by engines subject to the spark-ignition standards of 40 CFR part 1036 are divided as follows:

(i) Class 2b through Class 5 vehicles are considered "Light HDV".

(ii) Class 6 through Class 8 vehicles are considered “Medium HDV”.

(4) Phase 2 vocational vehicles propelled by engines subject to the compression-ignition standards in 40 CFR part 1036 are divided as follows:

(i) Class 2b through Class 5 vehicles are considered “Light HDV”.

(ii) Class 6 through 8 vehicles are considered “Heavy HDV” if the installed engine’s primary intended service class is Heavy HDE (see 40 CFR 1036.140), except that Class 8 hybrid vehicles are considered “Heavy HDV” regardless of the engine’s primary intended service class.

(iii) All other Class 6 through Class 8 vehicles are considered “Medium HDV”.

(5) Heavy-duty vehicles with no installed propulsion engine, such as electric vehicles, are divided as follows:

(i) Class 2b through Class 5 vehicles are considered “Light HDV”.

(ii) Class 6 and 7 vehicles are considered “Medium HDV”.

(iii) Class 8 vehicles are considered “Heavy HDV”.

(6) In certain circumstances, you may certify vehicles to standards that apply for a different vehicle service class. For example, see §§ 1037.105(g) and 1037.106(f). If you optionally certify vehicles to different standards, those vehicles are subject to all the regulatory requirements as if the standards were mandatory.

\* \* \* \* \*

■ 102. Amend § 1037.150 by revising paragraphs (f) and (y)(1) to read as follows:

**§ 1037.150 Interim provisions.**

\* \* \* \* \*

(f) *Electric and hydrogen fuel cell vehicles.* Tailpipe emissions of regulated GHG pollutants from electric vehicles and hydrogen fuel cell vehicles are deemed to be zero. No CO<sub>2</sub>-related emission testing is required for electric vehicles. Use good engineering judgment to apply other requirements of this part to electric vehicles.

\* \* \* \* \*

(y) \* \* \*

(1) For vocational Light HDV and vocational Medium HDV, emission credits you generate in model years 2018 through 2021 may be used through model year 2027, instead of being limited to a five-year credit life as specified in § 1037.740(c). For Class 8 vocational vehicles with Medium HDE, we will approve your request to generate these credits in and use these credits for the Medium HDV averaging set if you show that these vehicles would qualify as Medium HDV under

the Phase 2 program as described in § 1037.140(g)(4).

\* \* \* \* \*

■ 103. Amend § 1037.205 by revising paragraphs (p) and (q) to read as follows:

**§ 1037.205 What must I include in my application?**

\* \* \* \* \*

(p) Where applicable, describe all adjustable operating parameters (see § 1037.115), including production tolerances. For any operating parameters that do not qualify as adjustable parameters, include a description supporting your conclusion (see 40 CFR 1068.50(c)). Include the following in your description of each adjustable parameter:

(1) For mechanically controlled parameters, include the nominal or recommended setting, the intended physically adjustable range, and the limits or stops used to establish adjustable ranges. Also include information showing why the limits, stops, or other means of inhibiting adjustment are effective in preventing adjustment of parameters on in-use engines to settings outside your intended physically adjustable ranges.

(2) For electronically controlled parameters, describe how your engines are designed to prevent unauthorized adjustments.

(q) Include the following information for electric vehicles and fuel cell vehicles to show that they meet the standards of this part:

(1) You may attest that vehicles comply with the standards of § 1037.102 instead of submitting test data.

(2) For vehicles generating credits under § 1037.616, you may attest that the vehicle meets the durability requirements described in § 1037.102(b)(3) based on an engineering analysis of measured values and other information, consistent with good engineering judgment, instead of testing at the end of the useful life. Send us your test results for work produced over the FTP and initial useable battery energy or initial fuel cell voltage. Also send us your engineering analysis describing how you meet the durability requirements if we ask for it.

\* \* \* \* \*

■ 104. Amend § 1037.225 by revising the introductory text and paragraph (g) to read as follows:

**§ 1037.225 Amending applications for certification.**

Before we issue you a certificate of conformity, you may amend your application to include new or modified vehicle configurations, subject to the

provisions of this section. After we have issued your certificate of conformity, you may send us an amended application any time before the end of the model year requesting that we include new or modified vehicle configurations within the scope of the certificate, subject to the provisions of this section. You must amend your application if any changes occur with respect to any information that is included or should be included in your application.

\* \* \* \* \*

(g) You may produce vehicles or modify in-use vehicles as described in your amended application for certification and consider those vehicles to be in a certified configuration. Modifying a new or in-use vehicle to be in a certified configuration does not violate the tampering prohibition of 40 CFR 1068.101(b)(1), as long as this does not involve changing to a certified configuration with a higher family emission limit. See § 1037.621(g) for special provisions that apply for changing to a different certified configuration in certain circumstances.

■ 105. Amend § 1037.230 by revising paragraph (c) to read as follows:

**§ 1037.230 Vehicle families, sub-families, and configurations.**

\* \* \* \* \*

(c) Group vehicles into configurations consistent with the definition of “vehicle configuration” in § 1037.801. Note that vehicles with hardware or software differences that are related to measured or modeled emissions are considered to be different vehicle configurations even if they have the same modeling inputs and FEL. Note also, that you are not required to separately identify all configurations for certification. Note that you are not required to identify all possible configurations for certification; also, you are required to include in your final ABT report only those configurations you produced.

\* \* \* \* \*

■ 106. Amend § 1037.231 by revising paragraph (b)(1) to read as follows:

**§ 1037.231 Powertrain families.**

\* \* \* \* \*

(b) \* \* \*

(1) Engine family as specified in 40 CFR 1036.230.

\* \* \* \* \*

■ 107. Amend § 1037.250 by revising paragraph (a) to read as follows:

**§ 1037.250 Reporting and recordkeeping.**

(a) By September 30 following the end of the model year, send the Designated Compliance Officer a report including

the total U.S.-directed production volume of vehicles you produced in each vehicle family during the model year (based on information available at the time of the report). Report by vehicle identification number and vehicle configuration and identify the subfamily identifier. Report uncertified vehicles sold to secondary vehicle manufacturers. We may waive the reporting requirements of this paragraph (a) for small manufacturers.

\* \* \* \* \*

■ 108. Amend § 1037.320 by removing Table 1 to § 1037.320 and revising paragraph (b) to read as follows:

**§ 1037.320 Audit procedures for axles and transmissions.**

\* \* \* \* \*

(b) Run GEM for each applicable vehicle configuration and GEM regulatory subcategory identified in 40 CFR 1036.540 and for each vehicle class as defined in § 1037.140(g) using the applicable default engine map in appendix C of 40 CFR part 1036, the cycle-average fuel map in Table 1 of this section, the torque curve in Table 2 of this section for both the engine full-load torque curve and parent engine full-load torque curve, the motoring torque curve in Table 3 of this section, the idle fuel map in Table 4 of this section. For axle

testing, this may require omitting several vehicle configurations based on selecting axle ratios that correspond to the tested axle. For transmission testing, use the test transmission's gear ratios in place of the gear ratios defined in 40 CFR 1036.540. The GEM "Default FEL CO<sub>2</sub> Emissions" result for each vehicle configuration counts as a separate test for determining whether the family passes the audit. For vocational vehicles, use the GEM "Default FEL CO<sub>2</sub> Emissions" result for the Regional subcategory. Table 1 through Table 4 follow:

**BILLING CODE 6560-01-P**

Table 1 to paragraph (b) of § 1037.320—Transient Cycle-Average Fuel Map by Vehicle Class

Light HDV and Medium HDV— Spark-Ignition							Light HDV and Medium HDV— Compression-Ignition							Heavy HDV						
Engine Cycle Work (kW·hr)	N/V (r/min)	Fuel Mass (g)	Idle Speed (r/min)	Idle Torque (N·m)	Engine Cycle Work (kW·hr)	N/V (r/min)	Fuel Mass (g)	Idle Speed (r/min)	Idle Torque (N·m)	Engine Cycle Work (kW·hr)	N/V (r/min)	Fuel Mass (g)	Idle Speed (r/min)	Idle Torque (N·m)	Engine Cycle Work (kW·hr)	N/V (r/min)	Fuel Mass (g)	Idle Speed (r/min)	Idle Torque (N·m)	
3.5404	2.8739	1109.31	600.5	37.997	3.3057	2.3317	919.01	750.3	36.347	11.4255	2.3972	2579.58	600.7	89.658						
3.6574	3.0198	1153.35	600.4	37.951	3.3822	2.5075	982.53	750.2	36.461	11.6112	2.2432	2591.08	601.2	90.428						
3.8119	3.0370	1188.66	600.2	37.956	3.4917	2.5320	998.64	750.2	36.608	12.5052	2.1620	2763.28	602.4	92.014						
4.0121	3.1983	1250.76	600.1	38.153	3.6087	2.6181	1036.34	750.2	36.734	17.7747	2.5195	3835.77	602.2	91.780						
5.5567	3.1325	1585.32	604.6	56.535	5.2397	2.5050	1354.33	753.0	51.992	18.4901	2.4155	3994.29	603.5	93.724						
5.6814	3.2956	1639.08	604.0	56.549	5.3153	2.7289	1417.20	751.9	51.488	20.1904	2.3800	4374.06	605.1	96.340						
5.8720	3.3255	1686.14	602.5	56.234	5.4112	2.6689	1416.75	751.3	51.280											
6.1774	3.4848	1773.39	601.7	56.038	5.5590	2.7231	1450.67	751.0	51.254											

TABLE 2 TO PARAGRAPH (b) OF § 1037.320—FULL-LOAD TORQUE CURVES BY VEHICLE CLASS

Light HDV and medium HDV—spark-ignition		Light HDV and medium HDV—compression-ignition		Heavy HDV	
Engine speed (r/min)	Engine torque (N·m)	Engine speed (r/min)	Engine torque (N·m)	Engine speed (r/min)	Engine torque (N·m)
600	433	750	470	600	1200
700	436	907	579	750	1320
800	445	1055	721	850	1490
900	473	1208	850	950	1700
1000	492	1358	876	1050	1950
1100	515	1507	866	1100	2090
1200	526	1660	870	1200	2100
1300	541	1809	868	1250	2100
1400	542	1954	869	1300	2093
1500	542	2105	878	1400	2092
1600	542	2258	850	1500	2085
1700	547	2405	800	1520	2075
1800	550	2556	734	1600	2010
1900	551	2600	0	1700	1910
2000	554	.....	.....	1800	1801
2100	553	.....	.....	1900	1640
2200	558	.....	.....	2000	1350
2300	558	.....	.....	2100	910
2400	566	.....	.....	2250	0
2500	571				
2600	572				
2700	581				
2800	586				
2900	587				
3000	590				
3100	591				
3200	589				
3300	585				
3400	584				
3500	582				
3600	573				
3700	562				
3800	555				
3900	544				
4000	534				
4100	517				
4200	473				
4291	442				
4500	150				

TABLE 3 TO PARAGRAPH (b) OF § 1037.320—MOTORING TORQUE CURVES BY VEHICLE CLASS

Light HDV and medium HDV—spark-ignition		Light HDV and medium HDV—compression-ignition		Heavy HDV	
Engine speed (r/min)	Engine torque (N·m)	Engine speed (r/min)	Engine torque (N·m)	Engine speed (r/min)	Engine torque (N·m)
700	-41	750	-129	600	-98
800	-42	907	-129	750	-121
900	-43	1055	-130	850	-138
1000	-45	1208	-132	950	-155
1100	-48	1358	-135	1050	-174
1200	-49	1507	-138	1100	-184
1300	-50	1660	-143	1200	-204
1411	-51	1809	-148	1250	-214
1511	-52	1954	-155	1300	-225
1611	-53	2105	-162	1400	-247
1711	-56	2258	-170	1500	-270
1811	-56	2405	-179	1520	-275
1911	-57	2556	-189	1600	-294
2011	-57	.....	.....	1700	-319
2111	-58	.....	.....	1800	-345
2211	-60	.....	.....	1900	-372
2311	-65	.....	.....	2000	-400
2411	-81	.....	.....	2100	-429
2511	-85				
2611	-87				

TABLE 3 TO PARAGRAPH (b) OF § 1037.320—MOTORING TORQUE CURVES BY VEHICLE CLASS—Continued

Light HDV and medium HDV—spark-ignition		Light HDV and medium HDV—compression-ignition		Heavy HDV	
Engine speed (r/min)	Engine torque (N·m)	Engine speed (r/min)	Engine torque (N·m)	Engine speed (r/min)	Engine torque (N·m)
2711	−88				
2811	−89				
2911	−91				
3011	−91				
3111	−96				
3211	−96				
3311	−97				
3411	−98				
3511	−99				
3611	−104				
3711	−105				
3811	−108				
3911	−108				
4011	−111				
4111	−111				
4211	−115				
4291	−112				

TABLE 4 TO PARAGRAPH (b) OF § 1037.320—ENGINE IDLE FUEL MAPS BY VEHICLE CLASS

Light HDV and medium HDV—spark-ignition			Light HDV and medium HDV—compression-ignition			Heavy HDV		
Engine speed (r/min)	Engine torque (N·m)	Fuel mass rate (g/s)	Engine speed (r/min)	Engine torque (N·m)	Fuel mass rate (g/s)	Engine speed (r/min)	Engine torque (N·m)	Fuel mass rate (g/s)
600	0	0.4010	750	0	0.2595	600	0	0.3501
700	0	0.4725	850	0	0.2626	700	0	0.4745
600	100	0.6637	750	100	0.6931	600	100	0.6547
700	100	0.7524	850	100	0.7306	700	100	0.8304

\* \* \* \* \*

■ 109. Amend § 1037.510 by revising paragraphs (a)(1)(i), (2), and (3) and (d) to read as follows:

§ 1037.510 Duty-cycle exhaust testing.

\* \* \* \* \*

- (a) \* \* \*
- (1) \* \* \*

(i) *Transient cycle*. The transient cycle is specified in appendix A of this part. Warm up the vehicle. Start the duty cycle within 30 seconds after concluding the preconditioning procedure. Start sampling emissions at the start of the duty cycle.

\* \* \* \* \*

(2) Perform cycle-average engine fuel mapping as described in 40 CFR 1036.540. For powertrain testing under § 1037.550 or § 1037.555, perform testing as described in this paragraph (a)(2) to generate GEM inputs for each simulated vehicle configuration, and test runs representing different idle conditions. Perform testing as follows:

(i) *Transient cycle*. The transient cycle is specified in appendix A of this part.

(ii) *Highway cruise cycles*. The grade portion of the route corresponding to the 55 mi/hr and 65 mi/hr highway cruise cycles is specified in appendix D of this part. Maintain vehicle speed

between −1.0 mi/hr and 3.0 mi/hr of the speed setpoint; this speed tolerance applies instead of the approach specified in 40 CFR 1066.425(b)(1) and (2).

(iii) *Drive idle*. Perform testing at a loaded idle condition for Phase 2 vocational vehicles. For engines with an adjustable warm idle speed setpoint, test at the minimum warm idle speed and the maximum warm idle speed; otherwise simply test at the engine’s warm idle speed. Warm up the powertrain as described in 40 CFR 1036.527(c)(1). Within 60 seconds after concluding the warm-up, linearly ramp the powertrain down to zero vehicle speed over 20 seconds. Apply the brake and keep the transmission in drive (or clutch depressed for manual transmission). Stabilize the powertrain for (60 ± 1) seconds and then sample emissions for (30 ± 1) seconds.

(iv) *Parked idle*. Perform testing at an no-load idle condition for Phase 2 vocational vehicles. For engines with an adjustable warm idle speed setpoint, test at the minimum warm idle speed and the maximum warm idle speed; otherwise simply test at the engine’s warm idle speed. Warm up the powertrain as described in 40 CFR 1036.527(c)(1). Within 60 seconds after

concluding the warm-up, linearly ramp the powertrain down to zero vehicle speed in 20 seconds. Put the transmission in park (or neutral for manual transmissions and apply the parking brake if applicable). Stabilize the powertrain for (180 ± 1) seconds and then sample emissions for (600 ± 1) seconds.

(3) Where applicable, perform testing on a chassis dynamometer as follows:

(i) *Transient cycle*. The transient cycle is specified in appendix A of this part. Warm up the vehicle by operating over one transient cycle. Within 60 seconds after concluding the warm up cycle, start emission sampling and operate the vehicle over the duty cycle.

(ii) *Highway cruise cycle*. The grade portion of the route corresponding to the 55 mi/hr and 65 mi/hr highway cruise cycles is specified in appendix D of this part. Warm up the vehicle by operating it at the appropriate speed setpoint over the duty cycle. Within 60 seconds after concluding the preconditioning cycle, start emission sampling and operate the vehicle over the duty cycle, maintaining vehicle speed within ±1.0 mi/hr of the speed setpoint; this speed tolerance applies



instead of the approach specified in 40 CFR 1066.425(b)(1) and (2).

\* \* \* \* \*

(d) For highway cruise and transient testing, compare actual second-by-second vehicle speed with the speed specified in the test cycle and ensure any differences are consistent with the criteria as specified in § 1037.550(g)(1). If the speeds do not conform to these criteria, the test is not valid and must be repeated.

\* \* \* \* \*

■ 110. Amend § 1037.520 by revising paragraphs (c)(2) and (3), (f), and (h)(1) to read as follows:

§ 1037.520 Modeling CO<sub>2</sub> emissions to show compliance for vocational vehicles and tractors.

\* \* \* \* \*

(c) \* \* \*

(2) Measure tire rolling resistance in kg per metric ton as specified in ISO 28580 (incorporated by reference in

§ 1037.810), except as specified in this paragraph (c). Use good engineering judgment to ensure that your test results are not biased low. You may ask us to identify a reference test laboratory to which you may correlate your test results. Prior to beginning the test procedure in Section 7 of ISO 28580 for a new bias-ply tire, perform a break-in procedure by running the tire at the specified test speed, load, and pressure for (60 ± 2) minutes.

(3) For each tire design tested, measure rolling resistance of at least three different tires of that specific design and size. Perform the test at least once for each tire. Calculate the arithmetic mean of these results to the nearest 0.1 N/kN and use this value or any higher value as your GEM input for TRRL. You must test at least one tire size for each tire model, and may use engineering analysis to determine the rolling resistance of other tire sizes of

that model. Note that for tire sizes that you do not test, we will treat your analytically derived rolling resistances the same as test results, and we may perform our own testing to verify your values. We may require you to test a small sub-sample of untested tire sizes that we select.

\* \* \* \* \*

(f) *Engine characteristics.* Enter information from the engine manufacturer to describe the installed engine and its operating parameters as described in 40 CFR 1036.503. Note that you do not need fuel consumption at idle for tractors.

\* \* \* \* \*

(h) \* \* \*

(1) For engines with no adjustable warm idle speed, input vehicle idle speed as the manufacturer's declared warm idle speed. For engines with adjustable warm idle speed, input your vehicle idle speed as follows:

If your vehicle is a . . .	And your engine is subject to . . .	Your default vehicle idle speed is . . . <sup>a</sup>
(i) Heavy HDV .....	compression-ignition or spark-ignition standards .....	600 r/min.
(ii) Medium HDV tractor .....	compression-ignition standards .....	700 r/min.
(iii) Light HDV or Medium HDV vocational vehicle .....	compression-ignition standards .....	750 r/min.
(iv) Light HDV or Medium HDV .....	spark-ignition standards .....	600 r/min.

<sup>a</sup> If the default idle speed is above or below the engine manufacturer's whole range of declared warm idle speeds, use the manufacturer's maximum or minimum declared warm idle speed, respectively, instead of the default value.

\* \* \* \* \*

■ 111. Amend § 1037.534 by revising paragraph (d)(2) to read as follows:

§ 1037.534 Constant-speed procedure for calculating drag area (C<sub>d</sub>A).

\* \* \* \* \*

(d) \* \* \*

(2) Perform testing as described in paragraph (d)(3) of this section over a sequence of test segments at constant vehicle speed as follows:

- (i) (300 ± 30) seconds in each direction at 10 mi/hr.
- (ii) (450 ± 30) seconds in each direction at 70 mi/hr.
- (iii) (450 ± 30) seconds in each direction at 50 mi/hr.
- (iv) (450 ± 30) seconds in each direction at 70 mi/hr.
- (v) (450 ± 30) seconds in each direction at 50 mi/hr.
- (vi) (300 ± 30) seconds in each direction at 10 mi/hr.

\* \* \* \* \*

■ 112. Amend § 1037.540 by revising the introductory text and paragraphs (b)(3), (7), and (8), and (f)(3) to read as follows:

§ 1037.540 Special procedures for testing vehicles with hybrid power take-off.

This section describes optional procedures for quantifying the reduction

in greenhouse gas emissions for vehicles as a result of running power take-off (PTO) devices with a hybrid energy delivery system. See § 1037.550 for powertrain testing requirements that apply for drivetrain hybrid systems. The procedures are written to test the PTO by ensuring that the engine produces all of the energy with no net change in stored energy (charge-sustaining), and for plug-in hybrid vehicles, also allowing for drawing down the stored energy (charge-depleting). The full charge-sustaining test for the hybrid vehicle is from a fully charged rechargeable energy storage system (RESS) to a depleted RESS and then back to a fully charged RESS. You must include all hardware for the PTO system. You may ask us to modify the provisions of this section to allow testing hybrid vehicles other than battery electric hybrids, consistent with good engineering judgment. For plug-in hybrids, use a utility factor to properly weight charge-sustaining and charge-depleting operation as described in paragraph (f)(3) of this section.

\* \* \* \* \*

(b) \* \* \*

(3) Denormalize the PTO duty cycle in appendix B of this part using the following equation:

$$p_{refi} = p_i \cdot (\bar{p}_{max} - \bar{p}_{min}) + \bar{p}_{min}$$

Eq. 1037.540-1

Where:

- $p_{refi}$  = the reference pressure at each point  $i$  in the PTO cycle.
- $p_i$  = the normalized pressure at each point  $i$  in the PTO cycle (relative to  $\bar{p}_{max}$ ).
- $\bar{p}_{max}$  = the mean maximum pressure measured in paragraph (b)(2) of this section.
- $\bar{p}_{min}$  = the mean minimum pressure measured in paragraph (b)(2) of this section.

\* \* \* \* \*

(7) Depending on the number of circuits the PTO system has, operate the vehicle over one or concurrently over both of the denormalized PTO duty cycles in appendix B of this part. Measure emissions during operation over each duty cycle using the provisions of 40 CFR part 1066.

(8) Measured pressures must meet the cycle-validation specifications in the following table for each test run over the duty cycle:

TABLE 1 TO PARAGRAPH (b)(8) OF § 1037.540—STATISTICAL CRITERIA FOR VALIDATING EACH TEST RUN OVER THE DUTY CYCLE

Parameter <sup>a</sup>	Pressure
Slope, $a_1$ .....	$0.950 \leq a_1 \leq 1.030$
Absolute value of intercept, $ a_0 $ .	$\leq 2.0\%$ of maximum mapped pressure
Standard error of the estimate, <i>SEE</i> .	$\leq 10\%$ of maximum mapped pressure
Coefficient of determination, $r^2$ .	$\geq 0.970$

<sup>a</sup> Determine values for specified parameters as described in 40 CFR 1065.514(e) by comparing measured values to denormalized pressure values from the duty cycle in appendix B of this part.

$$m_{\text{fuelPTOplug-in}} = \sum_{i=1}^N [m_{\text{fuelPTOCD}i} \cdot (UF_{\text{DCD}i} - UF_{\text{DCD}i-1})] + \sum_{j=1}^M [m_{\text{fuelPTOCS}j}] \cdot \frac{(1 - UF_{\text{RCD}})}{M}$$

Eq. 1037.540-3

Where:

$i$  = an indexing variable that represents one test interval.

$N$  = total number of charge-depleting test intervals.

$m_{\text{fuelPTOCD}}$  = total mass of fuel per ton-mile in the charge-depleting portion of the test for each test interval,  $i$ , starting from  $i = 1$ .

$UF_{\text{DCD}i}$  = utility factor fraction at time  $t_{\text{CD}i}$  as determined in paragraph (f)(3)(i) of this section for each test interval,  $i$ , starting from  $i = 1$ .

$j$  = an indexing variable that represents one test interval.

$M$  = total number of charge-sustaining test intervals.

$m_{\text{fuelPTOCS}}$  = total mass of fuel per ton-mile in the charge-sustaining portion of the test for each test interval,  $j$ , starting from  $j = 1$ .

$UF_{\text{RCD}}$  = utility factor fraction at the full charge-depleting time,  $t_{\text{CD}}$ , as determined by interpolating the approved utility factor curve.  $t_{\text{CD}}$  is the sum of the time over  $N$  charge-depleting test intervals.

\* \* \* \* \*

■ 113. Revise § 1037.550 to read as follows:

**§ 1037.550 Powertrain testing.**

This section describes the procedure to measure fuel consumption and create engine fuel maps by testing a powertrain that includes an engine coupled with a transmission, drive axle, and hybrid components or any assembly with one or more of those hardware elements. Engine fuel maps are part of demonstrating compliance with Phase 2 vehicle standards under this part; the powertrain test procedure in this section is one option for generating this fuel-mapping information as described in 40 CFR 1036.503. Additionally, this powertrain test procedure is one option

\* \* \* \* \*

(f) \* \* \*  
 (3) For plug-in hybrid electric vehicles calculate the utility factor weighted fuel consumption in g/ton-mile, as follows:

(i) Determine the utility factor fraction for the PTO system from the table in appendix E of this part using interpolation based on the total time of the charge-depleting portion of the test as determined in paragraphs (c)(6) and (d)(3) of this section.

(ii) Weight the emissions from the charge-sustaining and charge-depleting portions of the test to determine the

for certifying hybrids to the engine standards in 40 CFR 1036.108.

(a) *General test provisions.* The following provisions apply broadly for testing under this section:

(1) Measure NO<sub>x</sub> emissions as described in paragraph (k) of this section. Include these measured NO<sub>x</sub> values any time you report to us your greenhouse gas emissions or fuel consumption values from testing under this section.

(2) The procedures of 40 CFR part 1065 apply for testing in this section except as specified. This section uses engine parameters and variables that are consistent with 40 CFR part 1065.

(3) Powertrain testing depends on models to calculate certain parameters. You can use the detailed equations in this section to create your own models, or use the GEM HIL model (incorporated by reference in § 1037.810) to simulate vehicle hardware elements as follows:

(i) Create driveline and vehicle models that calculate the angular speed setpoint for the test cell dynamometer,  $f_{\text{ref,dyno}}$ , based on the torque measurement location. Use the detailed equations in paragraph (f) of this section, the GEM HIL model's driveline and vehicle submodels, or a combination of the equations and the submodels. You may use the GEM HIL model's transmission submodel in paragraph (f) of this section to simulate a transmission only if testing hybrid engines.

(ii) Create a driver model or use the GEM HIL model's driver submodel to simulate a human driver modulating the throttle and brake pedals to follow the test cycle as closely as possible.

utility factor-weighted fuel mass,  $m_{\text{fuelUF[cycle]plug-in}}$ , using the following equation:

(iii) Create a cycle-interpolation model or use the GEM HIL model's cycle submodel to interpolate the duty-cycles and feed the driver model the duty-cycle reference vehicle speed for each point in the duty-cycle.

(4) The powertrain test procedure in this section is designed to simulate operation of different vehicle configurations over specific duty cycles. See paragraphs (h) and (j) of this section.

(5) For each test run, record engine speed and torque as defined in 40 CFR 1065.915(d)(5) with a minimum sampling frequency of 1 Hz. These engine speed and torque values represent a duty cycle that can be used for separate testing with an engine mounted on an engine dynamometer under § 1037.551, such as for a selective enforcement audit as described in § 1037.301.

(6) For hybrid powertrains with no plug-in capability, correct for the net energy change of the energy storage device as described in 40 CFR 1066.501. For plug-in hybrid electric powertrains, follow 40 CFR 1066.501 to determine End-of-Test for charge-depleting operation. You must get our approval in advance for your utility factor curve; we will approve it if you can show that you created it, using good engineering judgment, from sufficient in-use data of vehicles in the same application as the vehicles in which the plug-in hybrid electric powertrain will be installed. You may use methodologies described in SAE J2841 (incorporated by reference in § 1037.810) to develop the utility factor curve.

(7) The provisions related to carbon balance error verification in 40 CFR

1036.543 apply for all testing in this section. These procedures are optional if you are only performing direct or indirect fuel-flow measurement, but we will perform carbon balance error verification for all testing under this section.

(8) If you test a powertrain over the duty cycle specified in 40 CFR 1036.512, control and apply the electrical accessory loads using one of the following systems:

- (i) An alternator with dynamic electrical load control.
  - (ii) A load bank connected directly to the powertrain's electrical system.
- (b) *Test configuration.* Select a powertrain for testing as described in § 1037.235 or 40 CFR 1036.235 as applicable. Set up the engine according to 40 CFR 1065.110 and 40 CFR 1065.405(b). Set the engine's idle speed to the minimum warm-idle speed. If warm idle speed is not adjustable, simply let the engine operate at its warm idle speed.

(1) The default test configuration consists of a powertrain with all components upstream of the axle. This involves connecting the powertrain's output shaft directly to the dynamometer or to a gear box with a fixed gear ratio and measuring torque at the axle input shaft. You may instead set up the dynamometer to connect at the wheel hubs and measure torque at that location. The preceding sentence may apply if your powertrain configuration requires it, such as for hybrid powertrains or if you want to represent the axle performance with powertrain test results.

(2) For testing hybrid engines, connect the engine's crankshaft directly to the dynamometer and measure torque at that location.

(c) *Powertrain temperatures during testing.* Cool the powertrain during testing so temperatures for oil, coolant, block, head, transmission, battery, and power electronics are within the manufacturer's expected ranges for normal operation. You may use electronic control module outputs to comply with this paragraph (c). You may use auxiliary coolers and fans.

(d) *Engine break in.* Break in the engine according to 40 CFR 1065.405, the axle assembly according to § 1037.560, and the transmission according to § 1037.565. You may instead break in the powertrain as a complete system using the engine break in procedure in 40 CFR 1065.405.

(e) *Dynamometer setup.* Set the dynamometer to operate in speed-control mode (or torque-control mode for hybrid engine testing at idle, including idle portions of transient duty cycles). Record data as described in 40 CFR 1065.202. Command and control the dynamometer speed at a minimum of 5 Hz, or 10 Hz for testing engine hybrids. Run the vehicle model to calculate the dynamometer setpoints at a rate of at least 100 Hz. If the dynamometer's command frequency is less than the vehicle model dynamometer setpoint frequency, subsample the calculated setpoints for commanding the dynamometer setpoints.

(f) *Driveline and vehicle model.* Use the GEM HIL model's driveline and vehicle submodels or the equations in this paragraph (f) to calculate the dynamometer speed setpoint,  $f_{nref,dyno}$ , based on the torque measurement location. Note that the GEM HIL model is configured to set the accessory load to zero and it comes configured with the tire slip model disabled. Note that the GEM HIL model is configured to set the accessory load to zero and it comes configured with the tire slip model disabled.

(1) *Driveline model with a transmission in hardware.* For testing with torque measurement at the axle input shaft or wheel hubs, calculate,  $f_{nref,dyno}$ , using the GEM HIL model's driveline submodel or the following equation:

$$f_{nrefi,dyno} = \frac{k_{a[speed]} \cdot v_{refi}}{2 \cdot \pi \cdot r_{[speed]}}$$

Eq. 1037.550-1

Where:

$k_{a[speed]}$  = drive axle ratio as determined in paragraph (h) of this section. Set  $k_{a[speed]}$  equal to 1.0 if torque is measured at the wheel hubs.

$v_{refi}$  = simulated vehicle reference speed as calculated in paragraph (f)(3) of this section.

$r_{[speed]}$  = tire radius as determined in paragraph (h) of this section.

(2) *Driveline model with a simulated transmission.* For testing with the torque measurement at the engine's crankshaft,  $f_{nref,dyno}$  is the dynamometer target speed from the GEM HIL model's transmission submodel. You may request our approval to change the transmission submodel, as long as the changes do not affect the gear selection logic. Before testing, initialize the transmission model with the engine's measured

torque curve and the applicable steady-state fuel map from the GEM HIL model. You may request our approval to input your own steady-state fuel map. For example, this request for approval could include using a fuel map that represents the combined performance of the engine and hybrid components. Configure the torque converter to simulate neutral idle when using this procedure to generate engine fuel maps in 40 CFR 1036.503 or to perform the Supplemental Emission Test (SET) testing under 40 CFR 1036.505. You may change engine commanded torque at idle to better represent CITT for transient testing under 40 CFR 1036.510. You may change the simulated engine inertia to match the inertia of the engine under test. We will evaluate your requests under this paragraph (f)(2) based on your demonstration that the adjusted testing better represents in-use operation.

(i) The transmission submodel needs the following model inputs:

(A) Torque measured at the engine's crankshaft.

(B) Engine estimated torque determined from the electronic control module or by converting the instantaneous operator demand to an instantaneous torque in N·m.

(C) Dynamometer mode when idling (speed-control or torque-control).

(D) Measured engine speed when idling.

(E) Transmission output angular speed,  $f_{ni,transmission}$ , calculated as follows:

$$f_{ni,transmission} = \frac{k_{a[speed]} \cdot v_{refi}}{2 \cdot \pi \cdot r_{[speed]}}$$

Eq. 1037.550-2

Where:

$k_{a[speed]}$  = drive axle ratio as determined in paragraph (h) of this section.

$v_{refi}$  = simulated vehicle reference speed as calculated in paragraph (f)(3) of this section.

$r_{[speed]}$  = tire radius as determined in paragraph (h) of this section.

(ii) The transmission submodel generates the following model outputs:

(A) Dynamometer target speed.

(B) Dynamometer idle load.

(C) Transmission engine load limit.

(D) Engine speed target.

(3) *Vehicle model.* Calculate the simulated vehicle reference speed,  $v_{refi}$ , using the GEM HIL model's vehicle submodel or the equations in this paragraph (f)(3):

$$v_{refi} = \left( \frac{k_a \cdot T_{i-1}}{r} \cdot (Eff_{axle}) - \left( M \cdot g \cdot C_{rr} \cdot \cos(\text{atan}(G_{i-1})) + \frac{\rho \cdot C_d A}{2} \cdot v_{ref,i-1}^2 \right) - F_{brake,i-1} - F_{grade,i-1} \right) \cdot \frac{\Delta t_{i-1}}{M + M_{rotating}} + v_{ref,i-1}$$

Eq. 1037.550-3

Where:

*i* = a time-based counter corresponding to each measurement during the sampling period. Let  $v_{ref1} = 0$ ; start calculations at  $i = 2$ . A 10-minute sampling period will generally involve 60,000 measurements.

*T* = instantaneous measured torque at the axle input, measured at the wheel hubs, or simulated by the GEM HIL model's transmission submodel.

$Eff_{axle}$  = axle efficiency. Use  $Eff_{axle} = 0.955$  for  $T \geq 0$ , and use  $Eff_{axle} = 1/0.955$  for  $T < 0$ . Use  $Eff_{axle} = 1.0$  if torque is measured at the wheel hubs.

*M* = vehicle mass for a vehicle class as determined in paragraph (h) of this section.

*g* = gravitational constant = 9.80665 m/s<sup>2</sup>.

$C_{rr}$  = coefficient of rolling resistance for a vehicle class as determined in paragraph (h) of this section.

$G_{i-1}$  = the percent grade interpolated at distance,  $D_{i-1}$ , from the duty cycle in

appendix D to this part corresponding to measurement (*i* - 1).

$$D_{i-1} = \sum_{i=1}^N (v_{ref,i-1} \cdot \Delta t_{i-1})$$

Eq. 1037.550-4

$\rho$  = air density at reference conditions. Use  $\rho = 1.1845$  kg/m<sup>3</sup>.

$C_d A$  = drag area for a vehicle class as determined in paragraph (h) of this section.

$F_{brake,i-1}$  = instantaneous braking force applied by the driver model.

$$F_{grade,i-1} = M \cdot g \cdot \sin(\text{atan}(G_{i-1}))$$

Eq. 1037.550-5  
 $\Delta t$  = the time interval between measurements. For example, at 100 Hz,  $\Delta t = 0.0100$  seconds.

$M_{rotating}$  = inertial mass of rotating components. Let  $M_{rotating} = 340$  kg for vocational Light HDV or vocational Medium HDV. See paragraph (h) of this section for tractors and for vocational Heavy HDV.

(4) *Example.* The following example illustrates a calculation of  $f_{nref,dyno}$  using paragraph (f)(1) of this section where torque is measured at the axle input shaft. This example is for a vocational Light HDV or vocational Medium HDV with 6 speed automatic transmission at B speed (Test 4 in Table 1 to paragraph (h)(2)(ii) of this section).

$k_{aB} = 4.0$   
 $r_B = 0.399$  m  
 $T_{999} = 500.0$  N·m  
 $C_{rr} = 7.7$  N/kN =  $7.7 \cdot 10^{-3}$  N/N  
 $M = 11408$  kg  
 $C_d A = 5.4$  m<sup>2</sup>  
 $G_{999} = 0.39\% = 0.0039$

$$D_{999} = \sum_{i=0}^{998} (19.99 \cdot 0.01 + 20.0 \cdot 0.01 + \dots + v_{ref,998} \cdot \Delta t_{998}) = 1792 \text{ m}$$

$F_{brake,999} = 0$  N  
 $v_{ref,999} = 20.0$  m/s

$F_{grade,999} = 11408 \cdot 981 \cdot \sin(\text{atan}(0.0039)) = 436.5$  N

$\Delta t = 0.0100$  s  
 $M_{rotating} = 340$  kg

$$\frac{\left( \frac{4.0 \cdot 500.0}{0.399} \cdot (0.955) - \left( (11408 \cdot 9.80665 \cdot 7.7 \cdot 10^{-3} \cdot \cos(\text{atan}(0.0039))) + \frac{1.1845 \cdot 5.4}{2} \cdot 20.0^2 \right) - 0 - 436.5 \right) \cdot 0.0100}{11408 + 340} + 20.0 v_{ref1000} = 20.00189 \text{ m/s}$$

$$f_{nref1000,dyno} = \frac{4.0 \cdot 20.00189}{2 \cdot 3.14 \cdot 0.399} = 31.93 \text{ r/s} = 1915.8 \text{ r/min}$$

(g) *Driver model.* Use the GEM HIL model's driver submodel or design a driver model to simulate a human driver modulating the throttle and brake pedals. In either case, tune the model to follow the test cycle as closely as possible meeting the following specifications:

- (1) The driver model must meet the following speed requirements:
  - (i) For operation over the highway cruise cycles, the speed requirements described in 40 CFR 1066.425(b) and (c).
  - (ii) For operation over the transient cycle specified in appendix A of this part, the SET as defined 40 CFR 1036.505, the Federal Test Procedure (FTP) as defined in 40 CFR 1036.510,

and the Low Load Cycle (LLC) as defined in 40 CFR 1036.512, the speed requirements described in 40 CFR 1066.425(b) and (c).

(iii) The exceptions in 40 CFR 1066.425(b)(4) apply to the highway cruise cycles, the transient cycle specified in appendix A of this part, SET, FTP, and LLC.

(iv) If the speeds do not conform to these criteria, the test is not valid and must be repeated.  
 (2) Send a brake signal when operator demand is zero and vehicle speed is greater than the reference vehicle speed

from the test cycle. Include a delay before changing the brake signal to prevent dithering, consistent with good engineering judgment.  
 (3) Allow braking only if operator demand is zero.

(4) Compensate for the distance driven over the duty cycle over the course of the test. Use the following equation to perform the compensation in real time to determine your time in the cycle:

$$t_{\text{cycle}i} = \sum_{i=1}^N \left( \left( \frac{v_{\text{vehicle},i-1}}{v_{\text{cycle},i-1}} \right) \cdot \Delta t_{i-1} \right)$$

Eq. 1037.550-6

Where:

$v_{\text{vehicle}}$  = measured vehicle speed.  
 $v_{\text{cycle}}$  = reference speed from the test cycle. If  $v_{\text{cycle},i-1} < 1.0$  m/s, set  $v_{\text{cycle},i-1} = v_{\text{vehicle},i-1}$ .

(h) *Vehicle configurations to evaluate for generating fuel maps as defined in 40 CFR 1036.503.* Configure the driveline and vehicle models from paragraph (f) of this section in the test cell to test the powertrain. Simulate multiple vehicle configurations that represent the range of intended vehicle applications using one of the following options:

(1) Use at least three equally spaced axle ratios or tire sizes and three different road loads (nine configurations), or at least four equally spaced axle ratios or tire sizes and two

different road loads (eight configurations). Select axle ratios to represent the full range of expected vehicle installations. Instead of selecting axle ratios and tire sizes based on the range of intended vehicle applications as described in paragraph (h)(2) of this section, you may select axle ratios and tire sizes such that the ratio of engine speed to vehicle speed covers the range of ratios of minimum and maximum engine speed to vehicle speed when the transmission is in top gear for the vehicles in which the powertrain will be installed. Note that you do not have to use the same axle ratios and tire sizes for each GEM regulatory subcategory. You may determine your own  $C_{\text{rr}}$ ,  $C_{\text{d}A}$ , and  $M$  to cover the range of intended vehicle applications or you may use the

road loads in paragraph (h)(2) of this section.

(2) Determine the vehicle model inputs for a set of vehicle configurations as described in 40 CFR 1036.540(c)(3) with the following exceptions:

(i) In the equations of 40 CFR 1036.540(c)(3)(i),  $k_{\text{topgear}}$  is the actual top gear ratio of the powertrain instead of the transmission gear ratio in the highest available gear given in Table 1 in 40 CFR 1036.540.

(ii) Test at least eight different vehicle configurations for powertrains that will be installed in Spark-ignition HDE, vocational Light HDV, and vocational Medium HDV using the following table instead of Table 2 in 40 CFR 1036.540:

**BILLING CODE 6560-50-P**

Table 1 to paragraph (h)(2)(ii) of § 1037.550—Vehicle Configurations for Testing Spark-ignition HDE, Light HDE, and Medium HDE

	Test 1	Test 2	Test 3	Test 4	Test 5	Test 6	Test 7	Test 8
$C_{\text{rr}}$ (N/kN)	6.2	7.7	6.2	7.7	6.2	7.7	6.2	7.7
$C_{\text{d}A}$	3.4	5.4	3.4	5.4	3.4	5.4	3.4	5.4
CI engine speed for $\frac{f_{\text{ntire}}}{v_{\text{vehicle}}}$ and $k_{\text{a}}$	$f_{\text{nrefA}}$	$f_{\text{nrefA}}$	$f_{\text{nrefB}}$	$f_{\text{nrefB}}$	$f_{\text{nrefC}}$	$f_{\text{nrefC}}$	$f_{\text{ntest}}$	$f_{\text{ntest}}$
SI engine speed for $\frac{f_{\text{ntire}}}{v_{\text{vehicle}}}$ and $k_{\text{a}}$	$f_{\text{nrefD}}$	$f_{\text{nrefD}}$	$f_{\text{nrefA}}$	$f_{\text{nrefA}}$	$f_{\text{nrefB}}$	$f_{\text{nrefB}}$	$f_{\text{nrefC}}$	$f_{\text{nrefC}}$
$M$ (kg)	7,257	11,408	7,257	11,408	7,257	11,408	7,257	11,408
$M_{\text{rotating}}$ (kg)	340	340	340	340	340	340	340	340
Drive Axle Configuration <sup>a</sup>	4x2	4x2	4x2	4x2	4x2	4x2	4x2	4x2
GEM Regulatory Subcategory <sup>a</sup>	LHD	MHD	LHD	MHD	LHD	MHD	LHD	MHD

<sup>a</sup>Drive axle configuration and GEM Regulatory Subcategory are not used if using the equations in paragraph (f)(3) of this section.

(iii) Select and test vehicle configurations as described in 40 CFR 1036.540(c)(3)(iii) for powertrains that

will be installed in vocational Heavy HDV and tractors using the following

tables instead of Table 3 and Table 4 in 40 CFR 1036.540:

Table 2 to paragraph (h)(2)(iii) of § 1037.550—Vehicle Configurations for Testing General Purpose Tractors and Vocational Heavy HDV

	Test 1	Test 2	Test 3	Test 4	Test 5	Test 6	Test 7	Test 8	Test 9
$C_{rr}$ (N/kN)	6.9	6.9	6.9	6.9	6.9	6.9	6.9	6.9	6.9
$C_{dA}$	5.4	4.7	4.0	5.4	4.7	4.0	5.4	4.7	4.0
Engine speed for $\frac{f_{ntire}}{v_{vehicle}}$ and $k_a$	$f_{nrefD}$	$f_{nrefD}$	$f_{nrefD}$	$f_{nrefB}$	$f_{nrefB}$	$f_{nrefB}$	$f_{ntest}$	$f_{ntest}$	$f_{ntest}$
$M$ (kg)	31,978	25,515	19,051	31,978	25,515	19,051	31,978	25,515	19,051
$M_{rotating}$ (kg)	1,021	794	794	1,021	794	794	1,021	794	794
Drive Axle Configuration <sup>a</sup>	6x4	6x4	4x2	6x4	6x4	4x2	6x4	6x4	4x2
GEM Regulatory Subcategory <sup>a</sup>	C8_SC_HR	C8_DC_MR	C7_DC_MR	C8_SC_HR	C8_DC_MR	C7_DC_MR	C8_SC_HR	C8_DC_MR	C7_DC_MR
Vehicle Weight Reduction (lbs)	0	13,275	6,147	0	13,275	6,147	0	13,275	6,147

<sup>a</sup>Drive axle configuration and GEM Regulatory Subcategory are not used if using the equations in paragraph (f)(3) of this section.

Table 3 to paragraph (h)(2)(iii) of § 1037.550—Vehicle Settings for Testing Heavy HDE Installed in Heavy-Haul Tractors

	Test 1	Test 2	Test 3	Test 4	Test 5	Test 6
$C_{rr}$ (N/kN)	6.9	6.9	6.9	6.9	6.9	6.9
$C_{dA}$	5.0	5.4	5.0	5.4	5.0	5.4
Engine speed for $\frac{f_{ntire}}{v_{vehicle}}$ and $k_a$	$f_{nrefD}$	$f_{nrefD}$	$f_{nrefB}$	$f_{nrefB}$	$f_{ntest}$	$f_{ntest}$
$M$ (kg)	53,751	31,978	53,751	31,978	53,751	31,978
$M_{rotating}$ (kg)	1,021	1,021	1,021	1,021	1,021	1,021
Drive Axle Configuration <sup>a</sup>	6x4	6x4	6x4	6x4	6x4	6x4
GEM Regulatory Subcategory <sup>a</sup>	C8_HH	C8_SC_HR	C8_HH	C8_SC_HR	C8_HH	C8_SC_HR

<sup>a</sup>Drive axle configuration and GEM Regulatory Subcategory are not used if using the equations in paragraph (f)(3) of this section.

## BILLING CODE 6560-50-C

(3) For hybrid powertrain systems where the transmission will be simulated, use the transmission parameters defined in 40 CFR 1036.540(c)(2) to determine transmission type and gear ratio. Use a fixed transmission efficiency of 0.95.

The GEM HIL transmission model uses a transmission parameter file for each test that includes the transmission type, gear ratios, lockup gear, torque limit per gear from 40 CFR 1036.540(c)(2), and the values from 40 CFR 1036.503(b)(4) and (c).

(i) [Reserved]

(j) *Duty cycles to evaluate.* Operate the powertrain over each of the duty cycles specified in § 1037.510(a)(2), and for each applicable vehicle configuration from paragraph (h) of this section. Determine cycle-average powertrain fuel maps by testing the powertrain using

the procedures in 40 CFR 1036.540(d) with the following exceptions:

(1) Understand “engine” to mean “powertrain”.

(2) Warm up the powertrain as described in 40 CFR 1036.527(c)(1).

(3) Within 90 seconds after concluding the warm-up, start the transition to the preconditioning cycle as described in paragraph (j)(5) of this section.

(4) For plug-in hybrid engines, precondition the battery and then complete all back-to-back tests for each vehicle configuration according to 40 CFR 1066.501 before moving to the next vehicle configuration.

(5) If the preceding duty cycle does not end at 0 mi/hr, transition between duty cycles by decelerating at a rate of 2 mi/hr/s at 0% grade until the vehicle reaches zero speed. Shut off the powertrain. Prepare the powertrain and test cell for the next duty-cycle.

(6) Start the next duty-cycle within 60 to 180 seconds after shutting off the powertrain.

(i) To start the next duty-cycle, for hybrid powertrains, key on the vehicle and then start the duty-cycle. For conventional powertrains key on the vehicle, start the engine, wait for the engine to stabilize at idle speed, and then start the duty-cycle.

(ii) If the duty-cycle does not start at 0 mi/hr, transition to the next duty cycle by accelerating at a target rate of 1 mi/hr/s at 0% grade. Stabilize for 10

seconds at the initial duty cycle conditions and start the duty-cycle.

(7) Calculate cycle work using GEM or the speed and torque from the driveline and vehicle models from paragraph (f) of this section to determine the sequence of duty cycles.

(8) Calculate the mass of fuel consumed for idle duty cycles as described in paragraph (n) of this section.

(k) *Measuring NO<sub>x</sub> emissions.* Measure NO<sub>x</sub> emissions for each sampling period in grams. You may perform these measurements using a NO<sub>x</sub> emission-measurement system that meets the requirements of 40 CFR part 1065, subpart J. If a system malfunction prevents you from measuring NO<sub>x</sub> emissions during a test under this section but the test otherwise gives valid results, you may consider this a valid test and omit the NO<sub>x</sub> emission measurements; however, we may require you to repeat the test if we determine that you inappropriately voided the test with respect to NO<sub>x</sub> emission measurement.

(l) [Reserved]

(m) *Measured output speed validation.* For each test point, validate the measured output speed with the corresponding reference values. If the range of reference speed is less than 10 percent of the mean reference speed, you need to meet only the standard error of the estimate in Table 1 of this

section. You may delete points when the vehicle is stopped. If your speed measurement is not at the location of  $f_{nref}$ , correct your measured speed using the constant speed ratio between the two locations. Apply cycle-validation criteria for each separate transient or highway cruise cycle based on the following parameters:

TABLE 4 TO PARAGRAPH (m) OF § 1037.550—STATISTICAL CRITERIA FOR VALIDATING DUTY CYCLES

Parameter <sup>a</sup>	Speed control
Slope, $\alpha_1$ .....	$0.990 \leq \alpha_1 \leq 1.010$ .
Absolute value of intercept, $ \alpha_0 $ .	$\leq 2.0\%$ of maximum $f_{nref}$ speed.
Standard error of the estimate, <i>SEE</i> .	$\leq 2.0\%$ of maximum $f_{nref}$ speed.
Coefficient of determination, $r^2$ .	$\geq 0.990$ .

<sup>a</sup> Determine values for specified parameters as described in 40 CFR 1065.514(e) by comparing measured and reference values for  $f_{nref,dyno}$ .

(n) *Fuel consumption at idle.* Determine the mass of fuel consumed at idle for the applicable duty cycles described in § 1037.510(a)(2) as follows:

(1) Measure fuel consumption with a fuel flow meter and report the mean idle fuel mass flow rate for each duty cycle as applicable,  $\bar{m}_{fuelidle}$ .

(2) If you do not measure fuel mass flow rate, calculate the idle fuel mass flow rate for each duty cycle,  $\bar{m}_{fuelidle}$ , for each set of vehicle settings, as follows:

$$\bar{m}_{fuelidle} = \frac{M_C}{w_{Cmeas}} \cdot \left( \bar{n}_{exh} \cdot \frac{\bar{x}_{Ccombdry}}{1 + \bar{x}_{H2Oexhdry}} - \frac{\bar{m}_{CO2DEF}}{M_{CO2}} \right)$$

Eq. 1037.550-7

Where:

$M_C$  = molar mass of carbon.

$w_{Cmeas}$  = carbon mass fraction of fuel (or mixture of test fuels) as determined in 40 CFR 1065.655(d), except that you may not use the default properties in Table 2 of 40 CFR 1065.655 to determine  $\alpha$ ,  $\beta$ , and  $w_C$  for liquid fuels.

$\bar{n}_{exh}$  = the mean raw exhaust molar flow rate from which you measured emissions according to 40 CFR 1065.655.

$\bar{x}_{Ccombdry}$  = the mean concentration of carbon from fuel and any injected fluids in the exhaust per mole of dry exhaust.

$\bar{x}_{H2Oexhdry}$  = the mean concentration of H<sub>2</sub>O in exhaust per mole of dry exhaust.

$\bar{m}_{CO2DEF}$  = the mean CO<sub>2</sub> mass emission rate resulting from diesel exhaust fluid decomposition over the duty cycle as determined in 40 CFR 1036.535(b)(7). If your engine does not use diesel exhaust fluid, or if you choose not to perform this correction, set  $\bar{m}_{CO2DEF}$  equal to 0.

$M_{CO2}$  = molar mass of carbon dioxide.

*Example:*

$M_C = 12.0107$  g/mol

$w_{Cmeas} = 0.867$

$\bar{n}_{exh} = 25.534$  mol/s

$\bar{x}_{Ccombdry} = 2.805 \cdot 10^{-3}$  mol/mol

$\bar{x}_{H2Oexhdry} = 3.53 \cdot 10^{-2}$  mol/mol

$\bar{m}_{CO2DEF} = 0.0726$  g/s

$M_{CO2} = 44.0095$

$$\bar{m}_{fuelidle} = \frac{12.0107}{0.867} \cdot \left( 25.534 \cdot \frac{2.805 \cdot 10^{-3}}{1 + 3.53 \cdot 10^{-2}} - \frac{0.0726}{44.0095} \right)$$

$\bar{m}_{fuelidle} = 0.405$  g/s = 1458.6 g/hr

(o) *Create GEM inputs.* Use the results of powertrain testing to determine GEM inputs for the different simulated vehicle configurations as follows:

(1) Correct the measured or calculated fuel masses,  $m_{fuel[cycle]}$ , and mean idle fuel mass flow rates,  $\bar{m}_{fuelidle}$ , if applicable, for each test result to a mass-specific net energy content of a

reference fuel as described in 40 CFR 1036.535(f), replacing  $\bar{m}_{fuel}$  with  $m_{mfuel[cycle]}$  where applicable in Eq. 1036.535-4.

(2) Declare fuel masses,  $m_{\text{fuel}[\text{cycle}]}$  and  $\bar{m}_{\text{fuel}[\text{idle}]}$ . Determine  $m_{\text{mfuel}[\text{cycle}]}$  using the calculated fuel mass consumption values described in 40 CFR 1036.540(d). In addition, declare mean fuel mass flow rate for each applicable idle duty cycle,  $\bar{m}_{\text{fuel}[\text{idle}]}$ . These declared values may not be lower than any corresponding measured values

determined in this section. If you use both direct and indirect measurement of fuel flow, determine the corresponding declared values as described in 40 CFR 1036.535(g)(2) and (3). These declared values, which serve as emission standards, collectively represent the powertrain fuel map for certification.

(3) For engines designed for plug-in hybrid electric vehicles, the mass of fuel for each cycle,  $m_{\text{fuel}[\text{cycle}]}$ , is the utility factor-weighted fuel mass,  $m_{\text{fuelUF}[\text{cycle}]}$ . This is determined by calculating  $m_{\text{fuel}}$  for the full charge-depleting and charge-sustaining portions of the test and weighting the results, using the following equation:

$$m_{\text{fuelUF}[\text{cycle}]} = \sum_{i=1}^N [m_{\text{fuel}[\text{cycle}]CDi} \cdot (UF_{DCDi} - UF_{DCDi-1})] + \sum_{j=1}^M [m_{\text{fuel}[\text{cycle}]CSj}] \cdot \frac{(1 - UF_{RCD})}{M}$$

Eq. 1037.550-8

Where:

$i$  = an indexing variable that represents one test interval.

$N$  = total number of charge-depleting test intervals.

$m_{\text{fuel}[\text{cycle}]CDi}$  = total mass of fuel in the charge-depleting portion of the test for each test interval,  $i$ , starting from  $i = 1$ , including the test interval(s) from the transition phase.

$UF_{DCDi}$  = utility factor fraction at distance  $D_{CDi}$  from Eq. 1037.505-9 as determined by interpolating the approved utility factor curve for each test interval,  $i$ , starting from  $i = 1$ . Let  $UF_{DCD0} = 0$

$j$  = an indexing variable that represents one test interval.

$M$  = total number of charge-sustaining test intervals.

$m_{\text{fuel}[\text{cycle}]CSj}$  = total mass of fuel over the charge-sustaining portion of the test for each test interval,  $j$ , starting from  $j = 1$ .

$UF_{RCD}$  = utility factor fraction at the full charge-depleting distance,  $R_{CD}$ , as determined by interpolating the approved utility factor curve.  $R_{CD}$  is the cumulative distance driven over  $N$  charge-depleting test intervals.

$$D_{CDi} = \sum_{k=1}^Q (v_k \cdot \Delta t)$$

Eq. 1037.550-9

Where:

$k$  = an indexing variable that represents one recorded velocity value.

$Q$  = total number of measurements over the test interval.

$v$  = vehicle velocity at each time step,  $k$ , starting from  $k = 1$ . For tests completed under this section,  $v$  is the vehicle

velocity as determined by Eq. 1037.550-1. Note that this should include charge-depleting test intervals that start when the engine is not yet operating.

$\Delta t = 1/f_{\text{record}}$   
 $f_{\text{record}}$  = the record rate

*Example for the 55 mi/hr cruise cycle:*

$Q = 8790$   
 $v_1 = 55.0$  mi/hr  
 $v_2 = 55.0$  mi/hr  
 $v_3 = 55.1$  mi/hr  
 $f_{\text{record}} = 10$  Hz  
 $\Delta t = 1/10$  Hz = 0.1 s

$$D_{CD1} = \sum_{k=1}^{8790} (55.0 \cdot 0.1 + 55.0 \cdot 0.1 + 55.1 \cdot 0.1 + v_{8790} \cdot \Delta t) = 13.4 \text{ mi}$$

$D_{CD2} = 13.4$  mi

$D_{CD3} = 13.4$  mi

$N = 3$

$UF_{DCD1} = 0.05$

$UF_{DCD2} = 0.11$

$UF_{DCD3} = 0.21$

$m_{\text{fuel}55\text{cruise}CD1} = 0$  g

$m_{\text{fuel}55\text{cruise}CD2} = 0$  g

$m_{\text{fuel}55\text{cruise}CD3} = 1675.4$  g

$M = 1$

$m_{\text{fuel}55\text{cruise}CS} = 4884.1$  g

$UF_{RCD} = 0.21$



$$m_{\text{fuelUF55cruise}} = [0 \cdot (0.05 - 0) + 0 \cdot (0.11 - 0.05) + 1675.4 \cdot (0.21 - 0.11)] + 4884.1 \cdot \frac{(1 - 0.21)}{1} = 4026.0 \text{ g}$$

(4) Calculate powertrain output speed per unit of vehicle speed,  $\left[ \frac{\bar{f}_{\text{npowertrain}}}{\bar{v}_{\text{powertrain}}} \right]_{\text{[cycle]}}$ , using one

of the following methods:

(i) For testing with torque measurement at the axle input shaft:

$$\left[ \frac{\bar{f}_{\text{npowertrain}}}{\bar{v}_{\text{powertrain}}} \right]_{\text{[cycle]}} = \frac{k_a}{2 \cdot \pi \cdot r_{\text{[speed]}}}$$

Eq. 1037.550-10

*Example:*

$$k_a = 4.0$$

$$r_B = 0.399 \text{ m}$$

$$\left[ \frac{\bar{f}_{\text{npowertrain}}}{\bar{v}_{\text{powertrain}}} \right]_{\text{transienttest4}} = \frac{4.0}{2 \cdot 3.14 \cdot 0.399} = 1.596 \text{ r/m}$$

(ii) For testing with torque measurement at the wheel hubs, use Eq. 1037.550-8 setting  $k_a$  equal to 1.

(iii) For testing with torque measurement at the engine's crankshaft:

$$\left[ \frac{\bar{f}_{\text{npowertrain}}}{\bar{v}_{\text{powertrain}}} \right]_{\text{[cycle]}} = \frac{\bar{f}_{\text{nengine}}}{\bar{v}_{\text{ref}}}$$

Eq. 1037.550-11

Where:

$\bar{f}_{\text{engine}}$  = average engine speed when vehicle speed is at or above 0.100 m/s.

$\bar{v}_{\text{ref}}$  = average simulated vehicle speed at or above 0.100 m/s.

*Example:*

$$\bar{f}_{\text{engine}} = 1870 \text{ r/min} = 31.17 \text{ r/s}$$

$$\bar{v}_{\text{ref}} = 19.06 \text{ m/s}$$

$$\left[ \frac{\bar{f}_{\text{npowertrain}}}{\bar{v}_{\text{powertrain}}} \right]_{\text{transienttest4}} = \frac{31.17}{19.06} = 1.635 \text{ r/m}$$

(5) Calculate positive work,  $W_{\text{[cycle]}}$ , as the work over the duty cycle at the axle input shaft, wheel hubs, or the engine's crankshaft, as applicable, when vehicle speed is at or above 0.100 m/s. For plug-in hybrids engines and powertrains, calculate,  $W_{\text{[cycle]}}$ , by calculating the

positive work over each of the charge-sustaining and charge-depleting test intervals and then averaging them together.

(6) Calculate engine idle speed, by taking the average engine speed measured during the transient cycle test

while the vehicle speed is below 0.100 m/s.

(7) The following table illustrates the GEM data inputs corresponding to the different vehicle configurations for a given duty cycle:

Table 5 to paragraph (o)(7) of § 1037.550 – Example Vehicle Configuration Test Result Output Matrix for Heavy HDV

	VEHICLE CONFIGURATION NUMBER								
	1	2	3	4	5	6	7	8	9
$m_{fuel[cycle]}$									
$\left[ \begin{matrix} \bar{f}_{npowertrain} \\ \bar{v}_{powertrain} \end{matrix} \right]_{[cycle]}$									
$W_{[cycle]}$									
$\bar{f}_{idle}$									

<sup>a</sup>Idle speed applies only for the transient duty cycle.

■ 114. Amend § 1037.551 by revising the introductory text and paragraphs (b) and (c) to read as follows:

**§ 1037.551 Engine-based simulation of powertrain testing.**

Section 1037.550 describes how to measure fuel consumption over specific duty cycles with an engine coupled to a transmission; § 1037.550(a)(5) describes how to create equivalent duty cycles for repeating those same measurements with just the engine. This § 1037.551 describes how to perform this engine testing to simulate the powertrain test. These engine-based measurements may be used for confirmatory testing as described in § 1037.235, or for selective enforcement audits as described in § 1037.301, as long as the test engine's operation represents the engine operation observed in the powertrain test. If we use this approach for confirmatory testing, when making compliance determinations, we will consider the uncertainty associated with this approach relative to full powertrain testing. Use of this approach for engine SEAs is optional for engine manufacturers.

\* \* \* \* \*

(b) Operate the engine over the applicable engine duty cycles corresponding to the vehicle cycles specified in § 1037.510(a)(2) for powertrain testing over the applicable vehicle simulations described in § 1037.550(j). Warm up the engine to prepare for the transient test or one of the highway cruise cycles by operating it one time over one of the simulations of the corresponding duty cycle. Warm up the engine to prepare for the idle test by operating it over a simulation of the 65-mi/hr highway cruise cycle for 600

seconds. Within 60 seconds after concluding the warm up cycle, start emission sampling while the engine operates over the duty cycle. You may perform any number of test runs directly in succession once the engine is warmed up. Perform cycle validation as described in 40 CFR 1065.514 for engine speed, torque, and power.

(c) Calculate the mass of fuel consumed as described in § 1037.550(n) and (o). Correct each measured value for the test fuel's mass-specific net energy content as described in 40 CFR 1036.530. Use these corrected values to determine whether the engine's emission levels conform to the declared fuel-consumption rates from the powertrain test.

■ 115. Add § 1037.552 to subpart F read as follows:

**§ 1037.552 Multicycle powertrain test for battery electric vehicles.**

This section describes a procedure to measure work produced over the Heavy-Duty Transient Cycle (HDTC), useable battery energy (UBE) of a powertrain that propels a battery electric vehicle, and a transient cycle conversion factor,  $CF_{BEV}$ , for use in § 1037.616. Work produced over the HDTC and UBE are part of demonstrating compliance with criteria pollutant standards under § 1037.102 if you choose to generate  $NO_x$  emission credits under this part. This test procedure is one option for generating work produced over the HDTC and UBE. You may ask to use alternative test methods to demonstrate compliance with the standards.

(a) *General test provisions.* The following provisions apply broadly for testing under this section:

(1) The procedures of 40 CFR part 1065 apply for testing in this section

except as specified. This section uses engine parameters and variables that are consistent with 40 CFR part 1065.

(2) For powertrains that propel a battery electric vehicle, follow the procedures of 40 CFR 1036.505, 1036.510, and 1036.512 for testing the respective duty-cycles in this section except as specified. For the purposes of testing under this section, testing over the HDTC is carried out using the transient duty cycle described in 40 CFR 1036.510(a)(2) with a cold start testing only being required for the first HDTC of the test sequence.

(3) The following instruments are required for determination of the required voltages and currents during testing and must be installed on the powertrain to measure these values during testing:

(i) Measure the voltage and current of the battery pack directly with a DC wideband voltage, Ampere, and Watt-hour meter (power analyzer). Install this meter in such a way as to measure all current leaving and entering the battery pack (no other connections upstream of the measurement point). The maximum integration period for ampere-hour meters using an integration technique is 0.05 seconds to accommodate abrupt current changes without introducing significant integration errors. Use a power analyzer that has an accuracy for current and voltage measurements of 1% of point or 0.3% of max, whichever is greater. Use an instrument that is not susceptible to offset errors while measuring current as very small current offsets can be integrated throughout the cycle and provide erroneous energy or ampere-hour results.

(ii) If voltage sensing is not available, then optionally measure amp hours without directly measuring voltage

using a DC wideband ampere-hour meter. In this case, the voltage is determined from the powertrain ECM.

(iii) Install an AC Watt-hour meter to measure AC recharge energy in such a way as to measure all AC electrical energy entering the powertrain charger. Use an AC Watt-hour meter that has an accuracy for current and voltage measurements of 1% of point or 0.3% of max, whichever is greater.

(4) You must include in the test the powertrain's cooling system (*e.g.*, battery, power electronics, and electric motor(s)) such that the energy used from these accessories is accounted for during the test, including the pre- and post- test soak and charging periods.

(5) Stabilize powertrains tested under this section by following manufacturer recommendations.

(i) For determining the initial UBE, test a powertrain that has accumulated a minimum of 1,000 miles, but no more than 6,200 miles using a manufacturer defined durability driving schedule. Age the battery as follows:

(A) Include it in the powertrain that was operated over the durability driving schedule.

(B) Condition it using test procedure #2, Constant Current Discharge Test Series, in the United States Advanced Battery Consortium's Electric Vehicle Battery Test Procedures Manual (incorporated by reference in § 1037.810). Note that the number of charge/discharge cycles for bench aging a lead acid battery must be equivalent to at least 1000 vehicle miles. You may use other battery aging periods for non-lead-acid battery technologies, if supported by the manufacturer as being equivalent.

(ii) For determining aged UBE, test a powertrain that has accumulated targeted aged miles.

(6) Cycle all batteries in accordance with the powertrain manufacturers' recommendations before starting testing.

(b) Precondition the powertrain by repeatedly operating it over the HDTC, without soaks and leaving the key in the on position between cycles, until the powertrain's battery is fully depleted. This method is recommended to ensure that the subsequent recharge event produces a repeatable battery energy capacity prior to the test; however, a

preconditioning sequence that does not fully deplete the battery but consists of at least one HDTC is also acceptable if it results in equivalent pre-test UBE.

(c) Following the preconditioning, soak the powertrain, including the battery and thermal management system, if any, at (20 to 30) °C for 12 to 36 hours. Charge the powertrain for the duration of the soak period measuring the DC recharge energy,  $E_{DCRC}$ , and do not end the soak period prior to reaching full charge. Upon completion of the soak, install the powertrain, if not already installed, in the test cell and attach it to the dynamometer. The powertrain will be tested in a cold start condition for this test. Start the powertrain test no more than one hour after the powertrain is taken off charge.

(d) Measure DC discharge energy,  $E_{DCD}$ , in Watt-hours and DC discharge current per hour,  $C_D$ , for the entire Multicycle Test (MCT). The measurement points for the battery(ies) must capture all the current flowing into and out of the battery(ies) during powertrain operation, including current associated with regenerative braking. The equation for calculating powertrain  $E_{DCD}$  is given in Eq. 1037.552-1, however, it is expected that this calculation will typically be performed internally by the power analyzer specified in paragraph (a)(3)(i) of this section. Battery voltage measurements made by the powertrain's own on-board sensors (such as those available via a diagnostic port) may be used for calculating  $E_{DCD}$  if these measurements are equivalent to those produced by applicable external measurement equipment, such as a power analyzer.

$$E_{DCD} = \frac{1}{3600 \cdot f} \cdot \sum_{i=0}^N V_i \cdot I_i$$

Eq. 1037.552-1

Where:

$f$  = frequency of the current measurement in Hz.

$i$  = an indexing variable that represents one individual measurement.

$N$  = total number of measurements.

$V$  = battery DC bus voltage in volts.

$I$  = battery current in amps.

(e) The MCT range test consists of four HDTCs, two LLCs, two SETs, and

two constant speed cycles:  $CSC_M$  at the mid-test point and  $CSC_E$  at the end of test.

(1) The test sequence follows: HDTC-HDTC-LLC-SET-CSC<sub>M</sub>-HDTC-HDTC-LLC-SET-CSC<sub>E</sub>.

(2) The CSC is used to rapidly deplete battery energy, and consists of a steady-state speed schedule of 55 mi/hr or 90% of maximum sustainable speed if a powertrain cannot reach 55 mi/hr. When transitioning from the SET to CSC, smoothly accelerate to 55 mi/hr within 1 minute of the key switch being placed in the "on" position. Maintain powertrain speed to within ±1.0 mi/hr of the speed setpoint.

(3) Use one of the following methods to determine the duration of  $CSC_M$ ,  $t_{CSCM}$ , prior to carrying out the test sequence:

(i) *DC recharge energy method.* This method requires data from the recharge event preceding the test as described in paragraph (b) of this section or known UBE, cycle DC discharge energy,  $E_{DCD[dutycycle]}$ , and DC energy consumption rates,  $EC$ , measured either before or during the MCT.

(A) If a reasonable estimate of the powertrain's UBE is not available, determine  $UBE_{est}$  as follows:

$$UBE_{est} = B_{eff} \cdot E_{DCRC}$$

Eq. 1037.552-2

Where:

$B_{eff}$  = estimated battery efficiency = 0.95. You may develop your own estimated battery efficiency.

$E_{DCRC}$  = DC recharge energy measured during the pre-test recharging event. If DC recharge energy is not available, use the AC recharge energy,  $E_{ACRC}$ , from the pre-test recharging event which includes the total AC energy supplied to the powertrain from the electrical grid, including all energy used to power charging equipment (*e.g.*, charger, electrical vehicle supply equipment, 12V battery charger, etc.), and define a suitable (lower) battery plus charger efficiency factor to calculate  $UBE_{est}$ .

*Example:*

$$E_{DCRC} = 600000 \text{ W} \cdot \text{hrs}$$

$$B_{eff} = 0.95$$

$$UBE_{est} = 0.95 \cdot 600000 = 570000 \text{ W} \cdot \text{hrs}$$

(B) Determine length of  $CSC_M$ ,  $D_{CSCM}$ , using the following equation:

$$D_{CSCM} = \frac{CSC_{Mfactor} \cdot UBE_{est} - 4 \cdot E_{DCDHDTC} - 2 \cdot E_{DCDLLC} - 2 \cdot E_{DCDSET}}{EC_{CSC}}$$

Eq. 1037.552-3

Where:

$CSC_{Mfactor}$  = multiplier intended to leave 10% of the total energy for  $CSC_E = 0.9$ . You may choose a smaller factor, but target no more than 20% of the total energy for  $CSC_E$ .

$E_{DCDHDTC}$  = discharge energy from HDTC #2 of the MCT.

$E_{DCDLLC}$  = discharge energy from LLC #1 of the MCT.

$E_{DCDSET}$  = discharge energy from SET #1 of the MCT.

$EC_{CSC}$  = DC energy consumption from the preconditioning run in paragraph (b) of this section.

Example:

$$E_{DCDHDTC} = 25604 \text{ W} \cdot \text{hr}$$

$$E_{DCDLLC} = 37312 \text{ W} \cdot \text{hr}$$

$$E_{DCDSET} = 129009 \text{ W} \cdot \text{hr}$$

$$EC_{CSC} = 1380 \text{ W} \cdot \text{hr/mi}$$

$$CSC_{Mfactor} = 0.9$$

$$D_{CSCM} = \frac{0.9 \cdot 570000 - 4 \cdot 25604 - 2 \cdot 37312 - 2 \cdot 129009}{1380} = 56.5 \text{ mi}$$

(C) Determine  $t_{CSCM}$  using the following equation:

$$t_{CSCM} = \frac{D_{CSCM}}{v_{CSC}}$$

Eq. 1037.552-4

Where:

$v_{CSC}$  = powertrain speed over the CSC = 55 mi/hr.

Example:

$$t_{CSCM} = \frac{56.5}{55} = 1.02 \text{ hrs}$$

(ii) *Projected range method.* Use this method if the DC cycle discharge energy and DC recharge energy are unknown. Determine  $CSC_M$  using the powertrain's projected range on the HDTC, LLC, SET, and CSC.

(A) Using the powertrain's projected range and distance on the duty cycle(s), determine  $D_{CSCM}$  as follows:

$$D_{CSCM} = R_{CSCest} - 4 \cdot D_{HDTC} \cdot \frac{R_{CSCest}}{R_{HDTCest}} - 2 \cdot D_{LLC} \cdot \frac{R_{CSCest}}{R_{LLCest}} - 2 \cdot D_{SET} \cdot \frac{R_{CSCest}}{R_{SETest}} - CSC_{Efactor} \cdot R_{CSCest}$$

Eq. 1037.552-5

Where:

$R_{CSCest}$  = estimated range from the charge depleting test run in paragraph (e)(2) of this section.

$R_{HDTCest}$  = estimated range on repeat HDTC cycles determine in paragraph (k) of this section.

$R_{LLCest}$  = estimated range on repeat LLC cycles determine in paragraph (k) of this section.

$R_{SETest}$  = estimated range on repeat SET cycles determine in paragraph (k) of this section.

$D_{HDTC}$  = scheduled driving distance of one HDTC = 6.75 miles.

$D_{LLC}$  = scheduled driving distance of one LLC = 15.70 miles.

$D_{SET}$  = scheduled driving distance of one SET = 35.47 miles.

$CSC_{Efactor}$  = multiplier intended to leave 20% of the total energy for  $CSC_E = 0.2$ . You may choose a smaller factor if your range estimates allow for accurate determination of the factor.

Example:

$$R_{CSCest} = 413.0 \text{ miles}$$

$$R_{HDTCest} = 180.3 \text{ miles}$$

$$R_{LLCest} = 299.8 \text{ miles}$$

$$R_{SETest} = 156.7 \text{ miles}$$

$$D_{HDTC} = 6.75 \text{ miles}$$

$$D_{LLC} = 15.70 \text{ miles}$$

$$D_{SET} = 35.47 \text{ miles}$$

$$CSC_{Efactor} = 0.2$$

$$D_{CSCM} = 413.0 - 4 \cdot 6.75 \cdot \frac{413.0}{180.3} - 2 \cdot 15.70 \cdot \frac{413.0}{299.8} - 2 \cdot 35.47 \cdot \frac{413.0}{156.7} - 0.2 \cdot 413.0 = 38.4 \text{ mi}$$

(B) Determine  $t_{CSCM}$  using Eq. 1037.552-4.

Example:

$$t_{CSCM} = \frac{38.4}{55} = 0.7 \text{ hrs}$$

(4) Operate the powertrain over the test sequence described in Figure 1 of this section. Measure and report the total work,  $W_{[cycle]}$ ,  $E_{DCD}$ , and  $C_D$  from each of the test intervals. During soaks, use test cell ventilation to maintain a powertrain soak temperature of (20

30) °C with the key or power switch in the "off" position and the brake pedal not depressed.

Figure 1 to paragraph (e)(4) of § 1037.552—MCT Test Sequence

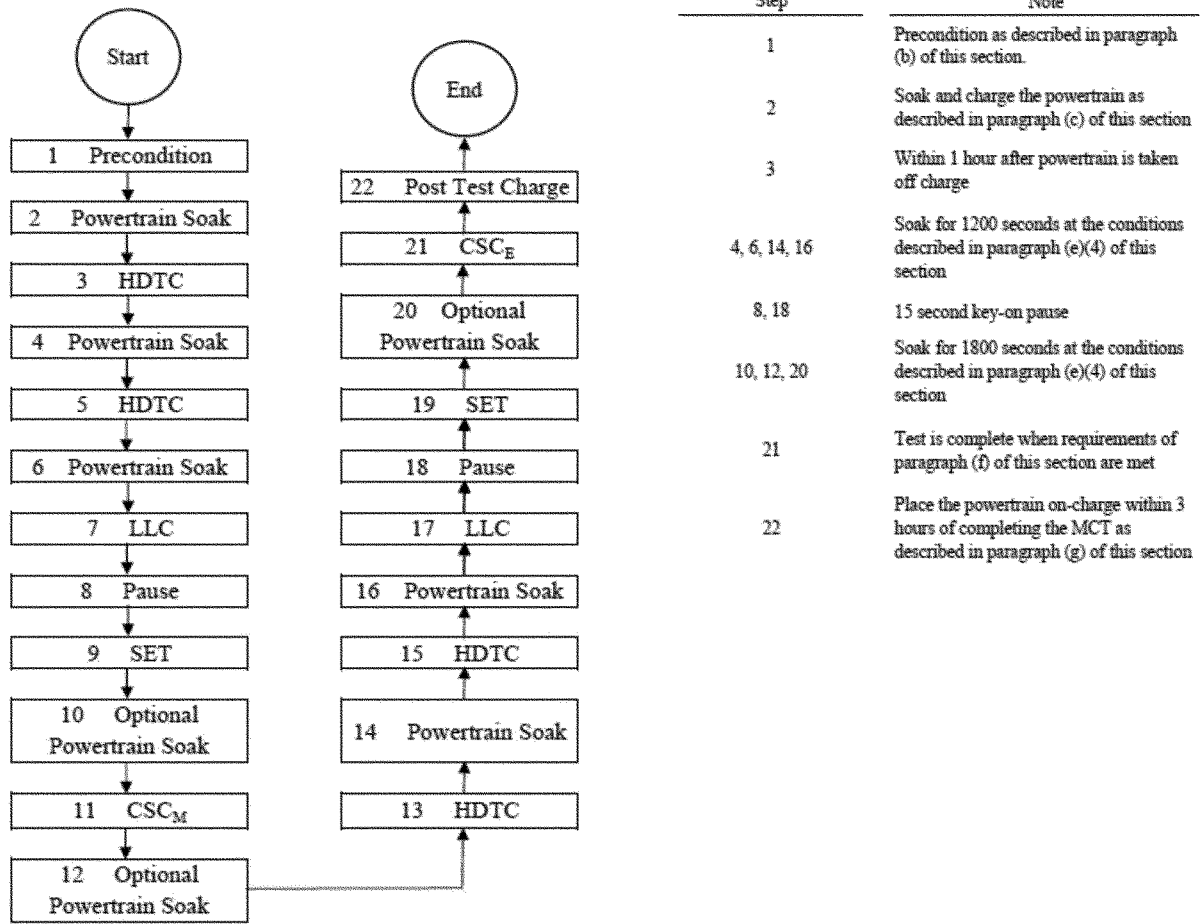

(f) The test is complete when the following end-of-test criteria during CSC<sub>E</sub> have been met.

(1) The test termination criterion for the full-depletion range and energy consumption test for powertrains capable of meeting the prescribed speed vs. time relationship of the applicable drive cycle follows:

(i) The test is complete when the powertrain, due to power limitations, is incapable of maintaining ±1.0 mi/hr of the speed setpoint or the manufacturer determines that the test should be terminated for safety reasons (e.g., excessively high battery temperature, abnormally low battery voltage, etc.).

(ii) Immediately apply the brake and decelerate the powertrain to a stop within 15 seconds once the test termination criteria have been met.

(2) The test termination criterion for the full-depletion range and energy consumption test for powertrains that are not capable of meeting the prescribed speed vs. time relationship of the applicable drive cycle for the initial phase of that cycle (i.e., the phase that begins with the powertrain fully

charged) and operated at maximum available power follows:

(i) The test is complete when the powertrain, while operated at maximum available power or “full throttle”, is unable to reproduce the best-effort speed vs. time relationship established by the powertrain in the first phase of the test.

(ii) The best-effort trace drive tolerance are the speed requirements described in 40 CFR 1066.425(b)(1) and (2).

(g) Place the powertrain on-charge within 3 hours of completing the MCT and charge the battery to full capacity to measure the total AC recharge energy, E<sub>ACRC</sub>, and DC recharge current per hour, C<sub>RC</sub>.

(1) Carryout recharging at the same nominal ambient temperature as the pre-test soak/charging period.

(2) Established that the system is fully charged using the manufacturer’s recommended charging procedure and appropriate equipment. Use the powertrain charger if it came equipped with one. Otherwise, charge the powertrain using an external charger

recommended by the powertrain manufacturer. If multiple charging power levels are available, recharge the powertrain at the power level recommended by the manufacturer. If the manufacturer does not specify a power level, recharging the system at the power level expected to be most widely used by end users. Use this power level for all pre- and post-test recharging events.

(3) Measure all AC energy supplied to the powertrain from the electrical grid, including all energy used to power charging equipment (e.g., charger, electrical vehicle supply equipment, 12V battery charger, etc.).

(4) Determine E<sub>AC</sub> in Watt-hours and C<sub>C</sub> in amp hours, using the instruments specified in paragraph (a)(3) of this section, for powertrains that require less than 12 hours to reach full charge by measuring the E<sub>AC</sub> and C<sub>C</sub> for a 12 hour period following the connection of the powertrain to the electrical vehicle supply equipment.

(5) Collect data for powertrains requiring more than 12 hours to reach full charge, until full charge is achieved.

Note that the 12 hour minimum data collection period is intended to better replicate expected in-use charging practices (*i.e.*, overnight charging) and to provide a standard time period that can be used to quantify any ancillary recharging loads, such as those resulting from battery thermal conditioning.

(6) Charge recovery is used to evaluate the equivalence of the pre- and post-test charge. Since the net amp-hours required to return the battery to a full charge during the post MCT recharging event in paragraph (g)(1) of this section must be greater than or equal to net amp hours discharged by the battery during the MCT, the charge recovery ratio should be  $\geq 1$  for most battery types. Since the determination of full charge verification must also take into account error in the associated measurement devices, the pre- and post-test charge events can be considered equivalent if the charge recovery is greater than 0.97. Verify the charge recovery,  $CR$ , of the post-test battery charge as follows:

$$CR = \frac{|C_{DCRC}|}{|C_{DCD}|} \geq 0.97$$

Eq. 1037.552-6

Where:

$C_{DCRC}$  = total post-MCT DC recharge current per hour.

$C_{DCD}$  = total DC discharge current per hour during the MCT.

*Example:*

$C_{DCRC} = 1425.0$  amp · hrs

$C_{DCD} = 1452.1$  amp · hrs

$$CR = \frac{|1425.0|}{|1452.1|} = 0.98$$

(h) The UBE is defined as the total DC discharge energy,  $E_{DCDtotal}$ , measured in DC Watt hours, over the MCT as determined as described in paragraph (d) of this section. The UBE represents the total deliverable energy the battery is capable of providing while a powertrain is following a duty cycle on a dynamometer. Determine a declared UBE that is at or below the corresponding value determined in paragraph (d) of this section, including

$$CF_{BEV} = \frac{32.62}{6.5} = 5.02 \text{ hp} \cdot \text{hr}/\text{mi}$$

(k) If you use the projected range option for determining the duration of  $CSC_M$ ,  $t_{CSCM}$ , in paragraph (e)(3)(ii) of this section, determine the total range and energy consumption for a BEV over the HDTC, LLC, and SET when operated on a dynamometer over repeats of a respective duty-cycle. This is a single cycle test (SCT) where the powertrain is driven until the useable energy content of the powertrain's battery is fully depleted. The intent of this section is to provide a standard powertrain procedure for testing BEVs so that their performances can be compared when operated over the certification duty cycles. Measure  $C_D$  as described in paragraph (d) of this section during the entire dynamometer test procedure (duty cycles and soaks) in order to validate the equivalence of the pre- and post-test charge.

(1) Precondition and soak the powertrain prior to testing as described in paragraphs (b) and (c) of this section.

(2) Operate the powertrain over one of the following drive cycles:

(i) HDTC.

(ii) LLC.

(iii) SET.

(3) Operate the powertrain over one of the duty-cycles described in paragraph (k)(2) of this section using the following soak times between each duty-cycle;

soak the powertrain as described in paragraph (e)(4) of this section:

(i) HDTC. 10 to 30 minutes between each duty-cycle.

(ii) LLC. A 15 second key on pause.

(iii) SET. A 15 second key on pause.

(4) Repeat testing over the duty cycle until the end-of-test criteria in paragraph (f) of this section have been met. You may specify other earlier test termination criterion, for example, to prevent battery damage. In this case, you may specify a battery characteristic such as terminal voltage under load to be the test termination criterion.

(5) Place the powertrain on-charge within 3 hours of completing the SCT and charge the battery to full capacity as described in paragraph (g) of this section.

(6) The range for an SCT,  $R_{[cycle]}$ , is defined as the total test distance driven in miles from the beginning of the test until the point where the powertrain reaches zero speed after satisfying the end-of-test criteria.

■ 116. Add § 1037.554 to subpart F read as follows:

**§ 1037.554 Multicycle powertrain test for fuel cell vehicles.**

This section describes a procedure to measure work produced over the heavy-duty transient cycle (HDTC) and fuel

those from redundant measurements. This declared UBE serves as the initial UBE that must be submitted under § 1037.205(q)(2).

(i) [Reserved]

(j) Determine the transient cycle conversion factor,  $CF_{BEV}$ , in hp · hr/mile. This represents the average work performed over the test interval for use in the credit calculation for battery electric vehicles in § 1037.616.

$$CF_{BEV} = \frac{W_{HDTC2}}{d}$$

Eq. 1037.552-7

Where:

$W_{HDTC2}$  = total (integrated) work generated over the second HDTC test interval in the MTC.

$d$  = duty-cycle distance for engines subject to compression-ignition standards from the  $CF$  determination for the emission credit calculation in 40 CFR 1036.705 = 6.5 miles.

*Example:*

$W_{HDTC2} = 32.62$  hp · hr

$d = 6.5$  miles

cell voltage (FCV) of a powertrain that propels a fuel cell vehicle. Work produced over the HDTC and FCV are part of demonstrating compliance with criteria pollutant standards under § 1037.102 if you choose to generate  $NO_x$  emission credits under this part. This test procedure is one option for generating work produced over the HDTC and FCV. You may ask to use alternative test methods to demonstrate compliance with the standards.

(a) The following provisions apply broadly for testing under this section:

(1) The procedures of 40 CFR part 1065 apply for testing in this section except as specified. This section uses engine parameters and variables that are consistent with 40 CFR part 1065.

(2) For powertrains that propel a fuel cell vehicle, follow the procedures of 40 CFR 1036.505, 1036.510, and 1036.512 for testing the respective duty-cycles in this section except as specified.

(3) Use the instruments in § 1037.552(a)(3)(i) and (ii) for determination of the required voltages and currents during testing and install these on the powertrain to measure these values during testing.

(4) Stabilize powertrains tested under this section by following manufacturer recommendations.

(i) For determining the initial mean fuel cell voltage, *FCV*, test a powertrain that has accumulated a minimum of 1000 miles, but no more than 6200 miles using a manufacturer defined durability driving schedule.

(ii) For determining aged *FCV*, test a powertrain that has accumulated targeted aged miles.

(b) Operate the powertrain over the SET, FTP, and LLC as defined in 40 CFR 1036.505, 1036.510(a)(2), and 1036.512, while measuring *FCV* and fuel cell current (FCC) upstream of any RESS, if present.

(c) Determine *FCV*, by taking the mean of the *FCV* when the FCC is between 55% and 65% of rated stack current, using the data collected in paragraph (b) of this section. Determine a declared that is at or below the corresponding value determined in this paragraph (c). This declared serves as the *FCV* that must be submitted under § 1037.205(q)(2).

(d) Determine the transient cycle conversion factor,  $CF_{FCEV}$ , in  $hp \cdot hr/mile$ . This represents the average work performed over the test interval for use in the credit calculation for fuel cell vehicles in § 1037.616.

$$CF_{FCEV} = \frac{W_{HDTC}}{D}$$

Eq. 1037.554-1

Where:

$W_{HDTC}$  = total (integrated) work generated over the hot-start HDTC test interval from the FTP test.

$D$  = duty-cycle distance for engine subject to compression-ignition standards from the *CF* determination for the emission credit calculation in 40 CFR 1036.705 = 6.5 miles.

Example:

$W_{HDTC}$  = 31.71  $hp \cdot hr$   
 $D$  = 6.5 miles

$$CF_{FCEV} = \frac{31.71}{6.5} = 4.88 \text{ hp} \cdot \text{hr}/\text{mi}$$

■ 117. Amend § 1037.555 by revising paragraph (g) to read as follows:

**§ 1037.555 Special procedures for testing Phase 1 hybrid systems.**

\* \* \* \* \*

(g) The driver model should be designed to follow the cycle as closely as possible and must meet the requirements of § 1037.510 for steady-state testing and 40 CFR 1066.425 for transient testing. The driver model should be designed so that the brake and throttle are not applied at the same time.

\* \* \* \* \*

■ 118. Amend § 1037.601 by revising paragraph (a)(1) to read as follows:

**§ 1037.601 General compliance provisions.**

(a) \* \* \*

(1) Except as specifically allowed by this part or 40 CFR part 1068, it is a violation of 40 CFR 1068.101(a)(1) to introduce into U.S. commerce a tractor or vocational vehicle that is not certified to the applicable requirements of this part. Similarly, it is a violation of 40 CFR 1068.101(a)(1) to introduce into U.S. commerce a tractor or vocational vehicle containing an engine that is not certified to the applicable requirements of 40 CFR part 86 or 1036. Further, it is a violation to introduce into U.S. commerce a Phase 1 tractor containing an engine not certified for use in tractors; or to introduce into U.S. commerce a vocational vehicle containing a Light HDE or Medium HDE not certified for use in vocational vehicles. These prohibitions apply especially to the vehicle manufacturer. Note that this paragraph (a)(1) allows the use of Heavy heavy-duty tractor engines in vocational vehicles.

\* \* \* \* \*

■ 119. Amend § 1037.605 by revising paragraphs (a) introductory text and (a)(4) to read as follows:

**§ 1037.605 Installing engines certified to alternate standards for specialty vehicles.**

(a) *General provisions.* This section allows vehicle manufacturers to introduce into U.S. commerce certain new motor vehicles using engines certified to alternate emission standards specified in 40 CFR 1036.605 for motor vehicle engines used in specialty vehicles. You may not install an engine certified to these alternate standards if there is an engine certified to the full set of requirements of 40 CFR part 1036 that has the appropriate physical and performance characteristics to power the vehicle. Note that, although these alternate emission standards are mostly equivalent to standards that apply for nonroad engines under 40 CFR part 1039 or 1048, they are specific to motor vehicle engines. The provisions of this section apply for the following types of specialty vehicles:

\* \* \* \* \*

(4) Through model year 2027, vehicles with a hybrid powertrain in which the engine provides energy only for the Rechargeable Energy Storage System.

\* \* \* \* \*

■ 120. Amend § 1037.615 by revising paragraph (f) to read as follows:

**§ 1037.615 Advanced technologies.**

\* \* \* \* \*

(f) For electric vehicles and for fuel cells powered by hydrogen, calculate  $CO_2$  credits using an FEL of 0 g/ton-mile. Note that these vehicles are subject to compression-ignition standards for  $CO_2$ .

\* \* \* \* \*

■ 121. Add § 1037.616 to subpart G to read as follows:

**§ 1037.616 NO<sub>x</sub> credits for electric vehicles and fuel cell vehicles.**

Starting in model year 2024, electric vehicles and fuel cell vehicles may generate  $NO_x$  credits for certifying heavy-duty engines under 40 CFR part 1036 as follows:

(a) Calculate  $NO_x$  credits as described in 40 CFR 1036.705 based on the following values:

(1) Select a useful life value as specified in § 1037.102(b).

(2) Select the family emission limit that represents the  $NO_x$  emission standards that the vehicle will meet throughout the vehicle's useful life.

(3) Use the  $NO_x$  emission standard that applies as specified in § 1037.102(b) for engines tested over the FTP duty cycle corresponding to the vehicle's model year.

(4) For "volume", use the number of vehicles generating emission credits within each averaging set specified in § 1037.740 during the model year.

(5) Determine conversion factors, *CF*, in  $hp \cdot hr/mile$  using the procedures specified in §§ 1037.552 and 1037.554.

(b) You may use  $NO_x$  credits generated under this section as specified in 40 CFR 1036.741.

■ 122. Amend § 1037.635 by revising paragraph (b)(2) to read as follows:

**§ 1037.635 Glider kits and glider vehicles.**

\* \* \* \* \*

(b) \* \* \*

(2) The engine must meet the criteria pollutant standards of 40 CFR part 86 or 40 CFR part 1036 that apply for the engine model year corresponding to the vehicle's date of manufacture.

\* \* \* \* \*

■ 123. Amend § 1037.705 by revising paragraph (b) to read as follows:

**§ 1037.705 Generating and calculating emission credits.**

\* \* \* \* \*

(b) For each participating family or subfamily, calculate positive or negative emission credits relative to the otherwise applicable emission standard. Calculate positive emission credits for a family or subfamily that has an FEL below the standard. Calculate negative emission credits for a family or subfamily that has an FEL above the standard. Sum your positive and negative credits for the model year before rounding. Round the sum of emission credits to the nearest megagram (Mg), using consistent units with the following equation:

$$\text{Emission credits (Mg)} = (\text{Std} - \text{FEL}) \cdot \text{PL} \cdot \text{Volume} \cdot \text{UL} \cdot 10^{-6}$$

Where:

*Std* = the emission standard associated with the specific regulatory subcategory (g/ton-mile).

*FEL* = the family emission limit for the vehicle subfamily (g/ton-mile).

*PL* = standard payload, in tons.

*Volume* = U.S.-directed production volume of the vehicle subfamily. For example, if you produce three configurations with the same FEL, the subfamily production volume would be the sum of the production volumes for these three configurations.

*UL* = useful life of the vehicle, in miles, as described in §§ 1037.105 and 1037.106. Use 250,000 miles for trailers.

\* \* \* \* \*

■ 124. Amend § 1037.725 by revising the section heading to read as follows:

**§ 1037.725 Required information for certification.**

\* \* \* \* \*

■ 125. Amend § 1037.730 by revising paragraphs (a), (b) introductory text, (c), and (f) to read as follows:

**§ 1037.730 ABT reports.**

(a) If you certify any vehicle families using the ABT provisions of this subpart, send us a final report by September 30 following the end of the model year.

(b) Your report must include the following information for each vehicle family participating in the ABT program:

\* \* \* \* \*

(c) Your report must include the following additional information:

(1) Show that your net balance of emission credits from all your participating vehicle families in each averaging set in the applicable model year is not negative, except as allowed under § 1037.745. Your credit tracking

must account for the limitation on credit life under § 1037.740(c).

(2) State whether you will retain any emission credits for banking. If you choose to retire emission credits that would otherwise be eligible for banking, identify the families that generated the emission credits, including the number of emission credits from each family.

(3) State that the report's contents are accurate.

(4) Identify the technologies that make up the certified configuration associated with each vehicle identification number. You may identify this as a range of identification numbers for vehicles involving a single, identical certified configuration.

\* \* \* \* \*

(f) Correct errors in your report as follows:

(1) If you or we determine by September 30 after the end of the model year that errors mistakenly decreased your balance of emission credits, you may correct the errors and recalculate the balance of emission credits. You may not make these corrections for errors that are determined later than September 30 after the end of the model year. If you report a negative balance of emission credits, we may disallow corrections under this paragraph (f)(1).

(2) If you or we determine any time that errors mistakenly increased your balance of emission credits, you must correct the errors and recalculate the balance of emission credits.

■ 126. Amend § 1037.735 by revising paragraph (b) to read as follows:

**§ 1037.735 Recordkeeping.**

\* \* \* \* \*

(b) Keep the records required by this section for at least eight years after the due date for the final report. You may not use emission credits for any vehicles if you do not keep all the records required under this section. You must therefore keep these records to continue to bank valid credits.

\* \* \* \* \*

■ 127. Amend § 1037.740 by revising paragraph (b) to read as follows:

**§ 1037.740 Restrictions for using emission credits.**

\* \* \* \* \*

(b) Credits from hybrid vehicles and other advanced technologies. The following provisions apply for credits you generate under § 1037.615.

(1) Credits generated from Phase 1 vehicles may be used for any of the averaging sets identified in paragraph (a) of this section; you may also use those credits to demonstrate compliance with the CO<sub>2</sub> emission standards in 40 CFR 86.1819 and 40 CFR part 1036.

Similarly, you may use Phase 1 advanced-technology credits generated under 40 CFR 86.1819–14(k)(7) or 40 CFR 1036.615 to demonstrate compliance with the CO<sub>2</sub> standards in this part. The maximum amount of advanced-technology credits generated from Phase 1 vehicles that you may bring into each of the following service class groups is 60,000 Mg per model year:

(i) Spark-ignition HDE, Light HDE, and Light HDV. This group comprises the averaging set listed in paragraph (a)(1) of this section and the averaging set listed in 40 CFR 1036.740(a)(1) and (2).

(ii) Medium HDE and Medium HDV. This group comprises the averaging sets listed in paragraph (a)(2) of this section and 40 CFR 1036.740(a)(3).

(iii) Heavy HDE and Heavy HDV. This group comprises the averaging sets listed in paragraph (a)(3) of this section and 40 CFR 1036.740(a)(4).

(iv) This paragraph (b)(1) does not limit the advanced-technology credits that can be used within a service class group if they were generated in that same service class group.

(2) Credits generated from Phase 2 vehicles are subject to all the averaging-set restrictions that apply to other emission credits.

\* \* \* \* \*

■ 128. Amend § 1037.801 by:

■ a. Adding definitions for “Charge-depleting”, and “Charge-sustaining” in alphabetical order.

■ b. Revising the definitions of “Designated Compliance Officer”.

■ c. Adding a definition for “Emission-related component” in alphabetical order.

■ d. Revising the definitions for “Low rolling resistance tire”, “Neutral coasting”, “Rechargeable Energy Storage System (RESS)”, and “Tire rolling resistance level (TRRL)”.

The additions and revisions read as follows:

**§ 1037.801 Definitions.**

\* \* \* \* \*

*Charge-depleting* has the meaning given in 40 CFR 1066.1001.

*Charge-sustaining* has the meaning given in 40 CFR 1066.1001.

\* \* \* \* \*

*Designated Compliance Officer* means one of the following:

(1) For compression-ignition engines, *Designated Compliance Officer* means Director, Diesel Engine Compliance Center, U.S. Environmental Protection Agency, 2000 Traverwood Drive, Ann Arbor, MI 48105; *complianceinfo@epa.gov*; *www.epa.gov/ve-certification*.



(2) For spark-ignition engines, *Designated Compliance Officer* means Director, Gasoline Engine Compliance Center, U.S. Environmental Protection Agency, 2000 Traverwood Drive, Ann Arbor, MI 48105; *complianceinfo@epa.gov*; *www.epa.gov/ve-certification*.

*Emission-related component* has the meaning given in 40 CFR part 1068, appendix A.

*Low rolling resistance tire* means a tire on a vocational vehicle with a TRRL at or below of 7.7 N/kN, a steer tire on a tractor with a TRRL at or below 7.7 N/kN, a drive tire on a tractor with a TRRL at or below 8.1 N/kN, a tire on a non-box trailer with a TRRL at or below of 6.5 N/kN, or a tire on a box van with a TRRL at or below of 6.0 N/kN.

*Neutral coasting* means a vehicle technology that automatically puts the transmission in neutral when the vehicle has minimal power demand while in motion, such as driving downhill.

*Rechargeable Energy Storage System (RESS)* has the meaning given in 40 CFR 1065.1001.

*Tire rolling resistance level (TRRL)* means a value with units of N/kN that represents the rolling resistance of a tire configuration. TRRLs are used as modeling inputs under §§ 1037.515 and 1037.520. Note that a manufacturer may use the measured value for a tire configuration's coefficient of rolling resistance, or assign some higher value.

■ 129. Amend § 1037.805 by revising paragraphs (a), (b), (d), (e), and (g) to read as follows:

**§ 1037.805 Symbols, abbreviations, and acronyms.**

(a) *Symbols for chemical species.* This part uses the following symbols for chemical species and exhaust constituents:

TABLE 1 TO PARAGRAPH (a) OF § 1037.805—SYMBOLS FOR CHEMICAL SPECIES AND EXHAUST CONSTITUENTS

Symbol	Species
C	carbon.
CH <sub>4</sub>	methane.
CO	carbon monoxide.
CO <sub>2</sub>	carbon dioxide.
H <sub>2</sub> O	water.
HC	hydrocarbon.
NMHC	nonmethane hydrocarbon.
NMHCE	nonmethane hydrocarbon equivalent.
NO	nitric oxide.
NO <sub>2</sub>	nitrogen dioxide.
NO <sub>x</sub>	oxides of nitrogen.
N <sub>2</sub> O	nitrous oxide.
PM	particulate matter.
THC	total hydrocarbon.
THCE	total hydrocarbon equivalent.

(b) *Symbols for quantities.* This part 1037 uses the following symbols and units of measure for various quantities:

TABLE 2 TO PARAGRAPH (b) OF § 1037.805—SYMBOLS FOR QUANTITIES

Symbol	Quantity	Unit	Unit symbol	Unit in terms of SI base units
A	vehicle frictional load	pound force or newton	lbf or N	kg·m·s <sup>-2</sup> .
a	axle position regression coefficient.			
α	atomic hydrogen-to-carbon ratio	mole per mole	mol/mol	1.
α	axle position regression coefficient.			
α <sub>0</sub>	intercept of air speed correction.			
α <sub>1</sub>	slope of air speed correction.			
a <sub>g</sub>	acceleration of Earth's gravity	meters per second squared	m/s <sup>2</sup>	m·s <sup>-2</sup> .
a <sub>0</sub>	intercept of least squares regression.			
a <sub>1</sub>	slope of least squares regression.			
B	vehicle load from drag and rolling resistance.	pound force per mile per hour or newton second per meter.	lbf/(mi/hr) or N·s/m	kg·s <sup>-1</sup> .
b	axle position regression coefficient.			
β	atomic oxygen-to-carbon ratio	mole per mole	mol/mol	1.
β	axle position regression coefficient.			
β <sub>0</sub>	intercept of air direction correction.			
β <sub>1</sub>	slope of air direction correction.			
B <sub>eff</sub>	estimated battery efficiency.			
C	vehicle-specific aerodynamic effects	pound force per mile per hour squared or newton-second squared per meter squared.	lbf/mph <sup>2</sup> or N·s <sup>2</sup> /m <sup>2</sup>	kg·m <sup>-1</sup> .
C	current of one ampere flowing for one hour.	ampere per hour	kA·hr	3.6 kA·s.
c	axle position regression coefficient.			
c <sub>i</sub>	axle test regression coefficients.			
C <sub>i</sub>	constant.			
ΔC <sub>d</sub> A	differential drag area	meter squared	m <sup>2</sup>	m <sup>2</sup> .
C <sub>d</sub> A	drag area	meter squared	m <sup>2</sup>	m <sup>2</sup> .
C <sub>d</sub>	drag coefficient.			
CF	correction factor.			
CF	conversion factor.			
CR	charge recovery.			
C <sub>rr</sub>	coefficient of rolling resistance	newton per kilonewton	N/kN	10 <sup>-3</sup> .
D	distance	miles or meters	mi or m	m.
E	energy	kilowatt-hour	kW·hr	3.6·m <sup>2</sup> ·kg·s <sup>-1</sup> .
e	mass-weighted emission result	grams per ton-mile	g/ton-mi	g/kg·km.
EC	energy consumption	kilowatt-hour per mile	kW·hr/mi	3.6·m <sup>2</sup> ·kg·s <sup>-1</sup> ·mi <sup>-1</sup> .
Eff	efficiency.			
F	adjustment factor.			

TABLE 2 TO PARAGRAPH (b) OF § 1037.805—SYMBOLS FOR QUANTITIES—Continued

Symbol	Quantity	Unit	Unit symbol	Unit in terms of SI base units
<i>F</i>	force	pound force or newton	lbf or N	kg·m·s <sup>-2</sup> .
<i>f<sub>n</sub></i>	angular speed (shaft)	revolutions per minute	r/min	π·30·s <sup>-1</sup> .
<i>G</i>	road grade	percent	%	10 <sup>-2</sup> .
<i>g</i>	gravitational acceleration	meters per second squared	m/s <sup>2</sup>	m·s <sup>-2</sup> .
<i>h</i>	elevation or height	meters	m	m.
<i>I</i>	current	ampere	A	A.
<i>i</i>	indexing variable.			
<i>k<sub>a</sub></i>	drive axle ratio			1.
<i>k<sub>d</sub></i>	transmission gear ratio.			
<i>k<sub>topgear</sub></i>	highest available transmission gear.			
<i>L</i>	load over axle	pound force or newton	lbf or N	kg·m·s <sup>-2</sup> .
<i>m</i>	mass	pound mass or kilogram	lbm or kg	kg.
<i>M</i>	molar mass	gram per mole	g/mol	10 <sup>-3</sup> ·kg·mol <sup>-1</sup> .
<i>M</i>	total number in series.			
<i>M</i>	vehicle mass	kilogram	kg	kg.
<i>M<sub>e</sub></i>	vehicle effective mass	kilogram	kg	kg.
<i>M<sub>rotating</sub></i>	inertial mass of rotating components	kilogram	kg	kg.
<i>N</i>	total number in series.			
<i>n</i>	number of tires.			
<i>ṅ</i>	amount of substance rate	mole per second	mol/s	mol·s <sup>-1</sup> .
<i>Q</i>	total number in series.			
<i>P</i>	power	kilowatt	kW	10 <sup>3</sup> ·m <sup>2</sup> ·kg·s <sup>-3</sup> .
<i>p</i>	pressure	pascal	Pa	kg·m <sup>-1</sup> ·s <sup>-2</sup> .
<i>ρ</i>	mass density	kilogram per cubic meter	kg/m <sup>3</sup>	kg·m <sup>-3</sup> .
<i>PL</i>	payload	tons	ton	kg.
<i>φ</i>	direction	degrees	°	°.
<i>Ψ</i>	direction	degrees	°	°.
<i>R</i>	range	miles or meters	mi or m	m.
<i>r</i>	tire radius	meter	m	m.
<i>r<sup>2</sup></i>	coefficient of determination.			
<i>Re<sup>#</sup></i>	Reynolds number.			
<i>SEE</i>	standard error of the estimate.			
<i>σ</i>	standard deviation.			
<i>TRPM</i>	tire revolutions per mile	revolutions per mile	r/mi.	
<i>TRRL</i>	tire rolling resistance level	newton per kilonewton	N/kN	10 <sup>-3</sup> .
<i>T</i>	absolute temperature	kelvin	K	K.
<i>T</i>	Celsius temperature	degree Celsius	°C	K - 273.15.
<i>T</i>	torque (moment of force)	newton meter	N·m	m <sup>2</sup> ·kg·s <sup>-2</sup> .
<i>t</i>	time	hour or second	hr or s	s.
<i>Δt</i>	time interval, period, 1/frequency	second	s	s.
<i>UBE</i>	useable battery energy	watt-hour	W·hr	3600·m <sup>2</sup> ·kg·s <sup>-1</sup> .
<i>UF</i>	utility factor.			
<i>V</i>	voltage	volts	V	kg·m <sup>2</sup> ·s <sup>-3</sup> ·A <sup>-1</sup> .
<i>v</i>	speed	miles per hour or meters per second	mi/hr or m/s	m·s <sup>-1</sup> .
<i>w</i>	weighting factor.			
<i>w</i>	wind speed	miles per hour	mi/hr	m·s <sup>-1</sup> .
<i>W</i>	work	kilowatt-hour	kW·hr	3.6·m <sup>2</sup> ·kg·s <sup>-1</sup> .
<i>w<sub>C</sub></i>	carbon mass fraction	Gram per gram	g/g	1.
<i>WR</i>	weight reduction	pound mass	lbm	kg.
<i>x</i>	amount of substance mole fraction	mole per mole	mol/mol	1.

\* \* \* \* \*

(d) *Subscripts*. This part uses the following subscripts for modifying quantity symbols:

TABLE 4 TO PARAGRAPH (d) OF § 1037.805—SUBSCRIPTS

Subscript	Meaning
±6	±6° yaw angle sweep.
A	A speed.
AC	alternating current.
ACRC	alternating current recharge.
air	air.
aero	aerodynamic.
alt	alternative.
act	actual or measured condition.
air	air.

TABLE 4 TO PARAGRAPH (d) OF § 1037.805—SUBSCRIPTS—Continued

Subscript	Meaning
axle .....	axle.
B .....	B speed.
BEV .....	battery electric vehicle.
brake .....	brake.
C .....	C speed.
Ccombdry .....	carbon from fuel per mole of dry exhaust.
CD .....	charge-depleting.
circuit .....	circuit.
CO2DEF .....	CO <sub>2</sub> resulting from diesel exhaust fluid decomposition.
CO2PTO .....	CO <sub>2</sub> emissions for PTO cycle.
coastdown .....	coastdown.
comp .....	composite.
CS .....	charge-sustaining.
CSC .....	constant-speed cycle.
CSCM .....	constant-speed cycle midpoint.
cycle .....	test cycle.
D .....	distance.
DC .....	direct current.
DCD .....	direct current discharge.
DCRC .....	direct current recharge.
drive .....	drive axle.
drive-idle .....	idle with the transmission in drive.
driver .....	driver.
dyno .....	dynamometer.
E .....	end-of-test.
effective .....	effective.
end .....	end.
eng .....	engine.
factor .....	factor.
FCEV .....	fuel cell electric vehicle.
est .....	estimate.
event .....	event.
FTP .....	Federal Test Procedure.
fuel .....	fuel.
full .....	full.
grade .....	grade.
H2Oexhaustdry .....	H <sub>2</sub> O in exhaust per mole of exhaust.
HDTC .....	Heavy-Duty Transient Cycle.
hi .....	high.
i .....	an individual of a series.
idle .....	idle.
in .....	inlet.
inc .....	increment.
j .....	an individual of a series.
k .....	an individual of a series.
LLC .....	Low Load Cycle.
lo .....	low.
loss .....	loss.
M .....	midpoint.
max .....	maximum.
meas .....	measured quantity.
med .....	median.
min .....	minimum.
moving .....	moving.
out .....	outlet.
P .....	power.
pair .....	pair of speed segments.
parked-idle .....	idle with the transmission in park.
partial .....	partial.
ploss .....	power loss.
plug-in .....	plug-in hybrid electric vehicle.
powertrain .....	powertrain.
PTO .....	power take-off.
R .....	range.
rated .....	rated speed.
RC .....	recharge.
record .....	record.
ref .....	reference quantity.
RL .....	road load.
rotating .....	rotating.
seg .....	segment.
SET .....	Supplemental Emission Test.

TABLE 4 TO PARAGRAPH (d) OF § 1037.805—SUBSCRIPTS—Continued

Subscript	Meaning
speed .....	speed.
spin .....	axle spin loss.
start .....	start.
steer .....	steer axle.
t .....	tire.
test .....	test.
th .....	theoretical.
total .....	total.
trac .....	traction.
trac10 .....	traction force at 10 mi/hr.
trailer .....	trailer axle.
transient .....	transient.
TRR .....	tire rolling resistance.
UF .....	utility factor.
urea .....	urea.
veh .....	vehicle.
w .....	wind.
wa .....	wind average.
yaw .....	yaw angle.
ys .....	yaw sweep.
zero .....	zero quantity.

(e) *Other acronyms and abbreviations.*

This part uses the following additional abbreviations and acronyms:

TABLE 5 TO PARAGRAPH (e) OF § 1037.805—OTHER ACRONYMS AND ABBREVIATIONS

Acronym	Meaning
ABT .....	averaging, banking, and trading.
AC .....	alternating current.
AECD .....	auxiliary emission control device.
AES .....	automatic engine shutdown.
APU .....	auxiliary power unit.
CD .....	charge-depleting.
CFD .....	computational fluid dynamics.
CFR .....	Code of Federal Regulations.
CITT .....	curb idle transmission torque.
CS .....	charge-sustaining.
CSC .....	constant-speed cycle.
DC .....	direct current.
DOT .....	Department of Transportation.
ECM .....	electronic control module.
EPA .....	Environmental Protection Agency.
FCC .....	fuel cell current.
FCV .....	fuel cell voltage.
FE .....	fuel economy.
FEL .....	Family Emission Limit.
FTP .....	Federal Test Procedure.
GAWR .....	gross axle weight rating.
GCWR .....	gross combination weight rating.
GEM .....	greenhouse gas emission model.
GVWR .....	gross vehicle weight rating.
HDTC .....	Heavy-Duty Transient Cycle.
Heavy HDE .....	heavy heavy-duty engine (see 40 CFR 1036.140).
Heavy HDV .....	heavy heavy-duty vehicle (see § 1037.140).
HVAC .....	heating, ventilating, and air conditioning.
ISO .....	International Organization for Standardization.
Light HDE .....	light heavy-duty engine (see 40 CFR 1036.140).
Light HDV .....	light heavy-duty vehicle (see § 1037.140).
LLC .....	Low Load Cycle.
MCT .....	Multicycle Test.
Medium HDE .....	medium heavy-duty engine (see 40 CFR 1036.140).
Medium HDV .....	medium heavy-duty vehicle (see § 1037.140).
NARA .....	National Archives and Records Administration.
NHTSA .....	National Highway Transportation Safety Administration.
PHEV .....	plug-in hybrid electric vehicle.
PTO .....	power take-off.
RESS .....	rechargeable energy storage system.

TABLE 5 TO PARAGRAPH (e) OF § 1037.805—OTHER ACRONYMS AND ABBREVIATIONS—Continued

Acronym	Meaning
SAE .....	SAE International.
SCT .....	single cycle test.
SEE .....	standard error of the estimate.
SET .....	Supplemental Emission Test.
SKU .....	stock-keeping unit.
Spark-ignition HDE .....	spark-ignition heavy-duty engine (see 40 CFR 1036.140).
TRPM .....	tire revolutions per mile.
TRRL .....	tire rolling resistance level.
UBE .....	useable battery energy.
U.S.C .....	United States Code.
VSL .....	vehicle speed limiter.

\* \* \* \* \*

(g) *Prefixes.* This part uses the following prefixes to define a quantity:

TABLE 7 TO PARAGRAPH (g) OF § 1037.805—PREFIXES

Symbol	Quantity	Value
μ .....	micro .....	10 <sup>-6</sup>
m .....	milli .....	10 <sup>-3</sup>
c .....	centi .....	10 <sup>-2</sup>
k .....	kilo .....	10 <sup>3</sup>
M .....	mega .....	10 <sup>6</sup>

■ 130. Amend § 1037.810 by revising paragraphs (a) and (e) and adding paragraph (f) to read as follows:

**§ 1037.810 Incorporation by reference.**

(a) Certain material is incorporated by reference into this part with the approval of the Director of the Federal Register in accordance with 5 U.S.C. 552(a) and 1 CFR part 51. To enforce any edition other than that specified in this section, the Environmental Protection Agency (EPA) must publish a document in the **Federal Register** and the material must be available to the public. All approved material is available for inspection at the EPA and at the National Archives and Records Administration (NARA). Contact EPA at: U.S. EPA, Air and Radiation Docket and Information Center, 1301 Constitution Ave. NW, Room B102, EPA West Building, Washington, DC 20460, [www.epa.gov/dockets](http://www.epa.gov/dockets), (202) 202–1744. For information on the availability of this material at NARA, email: [fr.inspection@nara.gov](mailto:fr.inspection@nara.gov), or go to: [www.archives.gov/federal-register/cfr/ibr-locations.html](http://www.archives.gov/federal-register/cfr/ibr-locations.html). The material may be obtained from the sources in the following paragraphs of this section.

\* \* \* \* \*

(e) SAE International, 400 Commonwealth Dr., Warrendale, PA 15096–0001, (877) 606–7323 (U.S. and Canada) or (724) 776–4970 (outside the U.S. and Canada), [www.sae.org](http://www.sae.org).

(1) SAE J1025, Test Procedures for Measuring Truck Tire Revolutions Per Kilometer/Mile, Stabilized August 2012, (“SAE J1025”); IBR approved for § 1037.520(c).

(2) SAE J1252, SAE Wind Tunnel Test Procedure for Trucks and Buses, Revised July 2012, (“SAE J1252”); IBR approved for §§ 1037.525(b); 1037.530(a).

(3) SAE J1263, Road Load Measurement and Dynamometer Simulation Using Coastdown Techniques, revised March 2010, (“SAE J1263”); IBR approved for §§ 1037.528 introductory text, (a), (b), (c), (e), and (h); 1037.665(a).

(4) SAE J1594, Vehicle Aerodynamics Terminology, Revised July 2010, (“SAE J1594”); IBR approved for § 1037.530(d).

(5) SAE J2071, Aerodynamic Testing of Road Vehicles—Open Throat Wind Tunnel Adjustment, Revised June 1994, (“SAE J2071”); IBR approved for § 1037.530(b).

(6) SAE J2263, Road Load Measurement Using Onboard Anemometry and Coastdown Techniques, Revised May 2020, (“SAE J2263”); IBR approved for §§ 1037.528 introductory text, (a), (b), (d), and (f); 1037.665(a).

(7) SAE J2343, Recommended Practice for LNG Medium and Heavy-Duty Powered Vehicles, Revised July 2008, (“SAE J2343”); IBR approved for § 1037.103(e).

(8) SAE J2452, Stepwise Coastdown Methodology for Measuring Tire Rolling Resistance, Revised June 1999, (“SAE J2452”); IBR approved for § 1037.528(h).

(9) SAE J2841, Utility Factor Definitions for Plug-In Hybrid Electric Vehicles Using 2001 U.S. DOT National Household Travel Survey Data, Issued March 2009, (“SAE J2841”); IBR approved for § 1037.550(a).

(10) SAE J2966, Guidelines for Aerodynamic Assessment of Medium and Heavy Commercial Ground Vehicles Using Computational Fluid Dynamics, Issued September 2013,

(“SAE J2966”); IBR approved for § 1037.532(a).

(f) Idaho National Laboratory, 2525 Fremont Ave., Idaho Falls, ID 83415–3805, (866) 495–7440, or [www.inl.gov](http://www.inl.gov).

(1) U.S. Advanced Battery Consortium, Electric Vehicle Battery Test Procedures Manual, Revision 2, January 1996; IBR approved for § 1037.552(a).

(2) [Reserved]

■ 131. Revise § 1037.815 to read as follows:

**§ 1037.815 Confidential information.**

The provisions of 40 CFR 1068.10 and 1068.11 apply for information you submit under this part.

**Appendix I to Part 1037—**  
[Redesignated as Appendix A to Part 1037]

**Appendix II to Part 1037—**  
[Redesignated as Appendix B to Part 1037]

**Appendix III to Part 1037—**  
[Redesignated as Appendix C to Part 1037]

**Appendix IV to Part 1037—**  
[Redesignated as Appendix D to Part 1037]

**Appendix V to Part 1037—**  
[Redesignated as Appendix E to Part 1037]

■ 132. Redesignate appendices to part 1037 as follows:

Old appendix	New appendix
appendix I to part 1037	appendix A to part 1037
appendix II to part 1037	appendix B to part 1037
appendix III to part 1037	appendix C to part 1037
appendix IV to part 1037	appendix D to part 1037
appendix V to part 1037	appendix E to part 1037

**PART 1039—CONTROL OF EMISSIONS FROM NEW AND IN-USE NONROAD COMPRESSION-IGNITION ENGINES**

■ 133. The authority citation for part 1039 continues to read as follows:

Authority: 42 U.S.C. 7401–7671q.

■ 134. Amend § 1039.105 by revising the section heading and paragraphs (a) introductory text and (b) introductory text to read as follows:

**§ 1039.105 What smoke opacity standards must my engines meet?**

(a) The smoke opacity standards in this section apply to all engines subject to emission standards under this part, except for the following engines:

\* \* \* \* \*

(b) Measure smoke opacity as specified in § 1039.501(c). Smoke opacity from your engines may not exceed the following standards:

\* \* \* \* \*

■ 135. Amend § 1039.115 by revising paragraphs (e) and (f) to read as follows:

**§ 1039.115 What other requirements apply?**

\* \* \* \* \*

(e) *Adjustable parameters.* Engines that have adjustable parameters must meet all the requirements of this part for any adjustment in the physically adjustable range. We may require that you set adjustable parameters to any specification within the adjustable range during any testing, including certification testing, selective enforcement auditing, or in-use testing. General provisions for adjustable parameters apply as specified in 40 CFR 1068.50.

(f) *Prohibited controls.* (1) *General provisions.* You may not design your engines with emission control devices, systems, or elements of design that cause or contribute to an unreasonable risk to public health, welfare, or safety while operating. For example, an engine may not emit a noxious or toxic substance it would otherwise not emit that contributes to such an unreasonable risk.

(2) *Vanadium sublimation in SCR catalysts.* For engines equipped with vanadium-based SCR catalysts, you must design the engine and its emission controls to prevent vanadium sublimation and protect the catalyst from high temperatures. We will evaluate your engine design based on the following information that you must include in your application for certification:

(i) Identify the threshold temperature for vanadium sublimation for your specified SCR catalyst formulation as described in 40 CFR 1065.1113 through 1065.1121.

(ii) Describe how you designed your engine to prevent catalyst inlet temperatures from exceeding the temperature you identify in paragraph (f)(2)(i) of this section, including consideration of engine wear through

the useful life. Also describe your design for catalyst protection in case catalyst temperatures exceed the specified temperature. In your description, include how you considered elevated catalyst temperature resulting from sustained high-load engine operation, catalyst exotherms, DPF regeneration, and component failure resulting in unburned fuel in the exhaust stream.

\* \* \* \* \*

■ 136. Amend § 1039.205 by revising paragraph (s) to read as follows:

**§ 1039.205 What must I include in my application?**

\* \* \* \* \*

(s) Describe all adjustable operating parameters (see § 1039.115(e)), including production tolerances. For any operating parameters that do not qualify as adjustable parameters, include a description supporting your conclusion (see 40 CFR 1068.50(c)). Include the following in your description of each adjustable parameter:

(1) For mechanically controlled parameters, include the nominal or recommended setting, the intended physically adjustable range, and the limits or stops used to limit adjustable ranges, and production tolerances of the limits or stops used to establish each physically adjustable range. Also include information showing why the limits, stops, or other means of inhibiting adjustment are effective in preventing adjustment of parameters on in-use engines to settings outside your intended physically adjustable ranges.

(2) For electronically controlled parameters, describe how your engines are designed to prevent unauthorized adjustments.

\* \* \* \* \*

■ 137. Amend § 1039.245 by adding paragraph (e) to read as follows:

**§ 1039.245 How do I determine deterioration factors from exhaust durability testing?**

\* \* \* \* \*

(e) You may alternatively determine and verify deterioration factors based on bench-aged aftertreatment as described in 40 CFR 1036.245 and 1036.246, with the following exceptions:

(1) Apply the percentage of useful life from Table 1 of 40 CFR 1036.246 based on hours of operation rather than vehicle mileage.

(2) Use good engineering judgment to perform verification testing using the procedures of § 1039.515 rather than 40 CFR 1036.520. Measure emissions as the equipment goes through its normal

operation over the course of the day (or shift-day).

(3) Apply infrequent regeneration adjustment factors as specified in § 1039.525 rather than 40 CFR 1036.522.

■ 138. Amend § 1039.501 by revising paragraph (c) to read as follows:

**§ 1039.501 How do I run a valid emission test?**

\* \* \* \* \*

(c) Measure smoke opacity using the procedures in 40 CFR part 1065, subpart L, for evaluating whether engines meet the smoke opacity standards in § 1039.105, except that you may test two-cylinder engines with an exhaust muffler like those installed on in-use engines.

\* \* \* \* \*

■ 139. Revise § 1039.655 to read as follows:

**§ 1039.655 What special provisions apply to engines sold in American Samoa or the Commonwealth of the Northern Mariana Islands?**

(a) The prohibitions in 40 CFR 1068.101(a)(1) do not apply to engines at or above 56 kW if the following conditions are met:

(1) The engine is intended for use and will be used in American Samoa or the Commonwealth of the Northern Mariana Islands.

(2) The engine meets the latest applicable emission standards in appendix I of this part.

(3) You meet all the requirements of 40 CFR 1068.265.

(b) If you introduce an engine into commerce in the United States under this section, you must meet the labeling requirements in § 1039.135, but add the following statement instead of the compliance statement in § 1039.135(c)(12):

THIS ENGINE DOES NOT COMPLY WITH U.S. EPA TIER 4 EMISSION REQUIREMENTS. IMPORTING THIS ENGINE INTO THE UNITED STATES OR ANY TERRITORY OF THE UNITED STATES EXCEPT AMERICAN SAMOA OR THE COMMONWEALTH OF THE NORTHERN MARIANA ISLANDS MAY BE A VIOLATION OF FEDERAL LAW SUBJECT TO CIVIL PENALTY.

(c) Introducing into commerce an engine exempted under this section in any state or territory of the United States other than American Samoa or the Commonwealth of the Northern Mariana Islands, throughout its lifetime, violates the prohibitions in 40 CFR 1068.101(a)(1), unless it is exempt under a different provision.

(d) The exemption provisions in this section also applied for engines that were introduced into commerce in

Guam before [the effective date of the final rule] if they would otherwise have been subject to Tier 4 standards.

■ 140. Amend § 1039.801 by revising the definitions of “Critical emission-related component” and “Designated Compliance Officer” to read as follows:

§ 1039.801 What definitions apply to this part?

\* \* \* \* \*

Critical emission-related component has the meaning given in 40 CFR 1068.30.

\* \* \* \* \*

Designated Compliance Officer means the Director, Diesel Engine Compliance Center, U.S. Environmental Protection Agency, 2000 Traverwood Drive, Ann Arbor, MI 48105; complianceinfo@epa.gov; www.epa.gov/ve-certification.

\* \* \* \* \*

PART 1042—CONTROL OF EMISSIONS FROM NEW AND IN-USE MARINE COMPRESSION-IGNITION ENGINES AND VESSELS

■ 141. The authority citation for part 1042 continues to read as follows:

Authority: 42 U.S.C. 7401–7671q.

■ 142. Amend § 1042.110 by revising paragraph (a)(1) to read as follows:

§ 1042.110 Recording reductant use and other diagnostic functions.

(a) \* \* \*

(1) The diagnostic system must monitor reductant supply and alert operators to the need to restore the reductant supply, or to replace the reductant if it does not meet your concentration specifications. Unless we approve other alerts, use a warning lamp and an audible alarm. You do not need to separately monitor reductant quality if your system uses input from an exhaust NOx sensor (or other sensor) to alert operators when reductant quality is inadequate. However, tank level or DEF flow must be monitored in all cases.

\* \* \* \* \*

■ 143. Amend § 1042.115 by revising paragraphs (d) introductory text and (e) to read as follows:

§ 1042.115 Other requirements.

\* \* \* \* \*

(d) Adjustable parameters. General provisions for adjustable parameters apply as specified in 40 CFR 1068.50. The following additional category-specific provisions apply:

\* \* \* \* \*

(e) Prohibited controls. (1) General provisions. You may not design your engines with emission control devices, systems, or elements of design that

cause or contribute to an unreasonable risk to public health, welfare, or safety while operating. For example, an engine may not emit a noxious or toxic substance it would otherwise not emit that contributes to such an unreasonable risk.

(2) Vanadium sublimation in SCR catalysts. For engines equipped with vanadium-based SCR catalysts, you must design the engine and its emission controls to prevent vanadium sublimation and protect the catalyst from high temperatures. We will evaluate your engine design based on the following information that you must include in your application for certification:

(i) Identify the threshold temperature for vanadium sublimation for your specified SCR catalyst formulation as described in 40 CFR 1065.1113 through 1065.1121.

(ii) Describe how you designed your engine to prevent catalyst inlet temperatures from exceeding the temperature you identify in paragraph (e)(2)(i) of this section, including consideration of engine wear through the useful life. Also describe your design for catalyst protection in case catalyst temperatures exceed the specified temperature. In your description, include how you considered elevated catalyst temperature resulting from sustained high-load engine operation, catalyst exotherms, DPF regeneration, and component failure resulting in unburned fuel in the exhaust stream.

\* \* \* \* \*

■ 144. Amend § 1042.145 by adding paragraph (h) to read as follows:

§ 1042.145 Interim provisions.

\* \* \* \* \*

(h) Expanded production-line testing. Production-line testing requirements for Category 1 engine families with a projected U.S.-directed production volume below 100 engines and for all families certified by small-volume engine manufacturers start to apply in model year 2024. All manufacturers must test no more than four engine families in a single model year, and small-volume engine manufacturers must test no more than two engine families in a single model year.

\* \* \* \* \*

■ 145. Amend § 1042.205 by revising paragraphs (c) and (s) to read as follows:

§ 1042.205 Application requirements.

\* \* \* \* \*

(c) If your engines are equipped with an engine diagnostic system as required under § 1042.110, explain how it works, describing especially the engine

conditions (with the corresponding diagnostic trouble codes) that cause the warning lamp to go on. Also identify the communication protocol (SAE J1939, SAE J1979, etc.).

\* \* \* \* \*

(s) Describe all adjustable operating parameters (see § 1042.115(d)), including production tolerances. For any operating parameters that do not qualify as adjustable parameters, include a description supporting your conclusion (see 40 CFR 1068.50(c)). Include the following in your description of each adjustable parameter:

(1) For mechanically controlled parameters, include the nominal or recommended setting, the intended physically adjustable range, and the limits or stops used to establish adjustable ranges.

(i) For Category 1 engines, include information showing why the limits, stops, or other means of inhibiting mechanical adjustment are effective in preventing adjustment of parameters on in-use engines to settings outside your intended physically adjustable ranges.

(ii) For Category 2 and Category 3 engines, propose a range of mechanical adjustment for each adjustable parameter, as described in § 1042.115(d). Include information showing why the limits, stops, or other means of inhibiting mechanical adjustment are effective in preventing adjustment of parameters on in-use engines to settings outside your proposed adjustable ranges.

(2) For electronically controlled parameters, describe how your engines are designed to prevent unauthorized adjustments.

\* \* \* \* \*

■ 146. Amend § 1042.245 by adding paragraph (e) to read as follows:

§ 1042.245 Deterioration factors.

\* \* \* \* \*

(e) You may alternatively determine and verify deterioration factors based on bench-aged aftertreatment as described in 40 CFR 1036.245 and 1036.246, with the following exceptions:

(1) Apply the percentage of useful life from Table 1 of 40 CFR 1036.246 based on hours of operation rather than vehicle mileage.

(2) Use good engineering judgment to perform verification testing using the procedures of § 1042.515 rather than 40 CFR 1036.520. Measure emissions as the vessel goes through its normal operation over the course of the day (or shift-day).

(3) Apply infrequent regeneration adjustment factors as specified in § 1042.525 rather than 40 CFR 1036.522.

■ 147. Revise § 1042.301 to read as follows:

**§ 1042.301 General provisions.**

(a) If you produce freshly manufactured marine engines that are subject to the requirements of this part, you must test them as described in this subpart.

(b) We may suspend or revoke your certificate of conformity for certain engine families if your production-line engines do not meet the requirements of this part or you do not fulfill your obligations under this subpart (see §§ 1042.325 and 1042.340). Similarly, we may deny applications for certification for the upcoming model year if you do not fulfill your obligations under this subpart (see § 1042.255(c)(1)).

(c) Other regulatory provisions authorize us to suspend, revoke, or void your certificate of conformity, or order recalls for engine families, without regard to whether they have passed production-line testing requirements. The requirements of this subpart do not affect our ability to do selective enforcement audits, as described in 40 CFR part 1068. Individual engines in families that pass production-line testing requirements must also conform to all applicable regulations of this part and 40 CFR part 1068.

(d) You may ask to use another alternate program or measurement method for testing production-line engines. In your request, you must show us that the alternate program gives equal assurance that your engines meet the requirements of this part. We may waive some or all of this subpart's requirements if we approve your alternate program.

(e) If you certify a Category 1 or Category 2 engine family with carryover emission data, as described in § 1042.235(d), you may omit production-line testing if you fulfilled your testing requirements with a related engine family in an earlier year, except as follows:

(1) We may require that you perform additional production-line testing under this subpart in any model year for cause, such as if you file a defect report related to the engine family or if you amend your application for certification in any of the following ways:

(i) You designate a different supplier or change technical specifications for any critical emission-related components.

(ii) You add a new or modified engine configuration such that the test data from the original emission-data engine do not clearly continue to serve as worst-case testing for certification.

(iii) You change your family emission limit without submitting new emission data.

(2) If you certify an engine family with carryover emission data with no production-line testing for more than five model years, we may require that you perform production-line testing again for one of those later model years unless you demonstrate that none of the circumstances identified in paragraph (e)(1) of this section apply for the engine family.

(f) We may ask you to make a reasonable number of production-line engines available for a reasonable time so we can test or inspect them for compliance with the requirements of this part. For Category 3 engines, you are not required to deliver engines to us, but we may inspect and test your engines at any facility at which they are assembled or installed in vessels.

■ 148. Amend § 1042.302 by revising the introductory text to read as follows:

**§ 1042.302 Applicability of this subpart for Category 3 engines.**

If you produce Tier 3 or later Category 3 engines that are subject to the requirements of this part, you must test them as described in this subpart, except as specified in this section.

\* \* \* \* \*

■ 149. Amend § 1042.305 by revising paragraph (a) to read as follows:

**§ 1042.305 Preparing and testing production-line engines.**

\* \* \* \* \*

(a) *Test procedures.* Test your production-line engines using the applicable testing procedures in subpart F of this part to show you meet the duty-cycle emission standards in subpart B of this part. For Category 1 and Category 2 engines, the not-to-exceed standards apply for this testing of Category 1 and Category 2 engines, but you need not do additional testing to show that production-line engines meet the not-to-exceed standards. The mode cap standards apply for testing Category 3 engines subject to Tier 3 standards (or for engines subject to the Annex VI Tier III NO<sub>x</sub> standards under § 1042.650(d)).

\* \* \* \* \*

■ 150. Revise § 1042.310 to read as follows:

**§ 1042.310 Engine selection for Category 1 and Category 2 engines.**

(a) For Category 1 and Category 2 engine families, the minimum sample size is one engine. You may ask us to approve treating commercial and recreational engines as being from the same engine family for purposes of production-line testing if you certify

them using the same emission-data engine.

(b) Select engines for testing as follows:

(1) For Category 1 engines, randomly select one engine within the first 60 days of the start of production for each engine family.

(2) For Category 2 engines, randomly select one engine within 60 days after you produce the fifth engine from an engine family (or from successive families that are related based on your use of carryover data under § 1042.230(d)).

(3) If you do not produce an engine from the engine family in the specified time frame, test the next engine you produce.

(4) You may preferentially test engines earlier than we specify.

(5) You meet the requirement to randomly select engines under this section if you assemble the engine in a way that fully represents your normal production and quality procedures.

(c) For each engine that fails to meet emission standards, test two engines from the same engine family from the next fifteen engines produced or within seven days, whichever is later. If you do not produce fifteen additional engines within 90 days, test two additional engines within 90 days or as soon as practicable. If an engine fails to meet emission standards for any pollutant, count it as a failing engine under this paragraph (c).

(d) Continue testing until one of the following things happens:

(1) You test the number of engines required under paragraphs (b) and (c) of this section. For example, if the initial engine fails and then two engines pass, testing is complete for that engine family.

(2) The engine family does not comply according to § 1042.315 or you choose to declare that the engine family does not comply with the requirements of this subpart.

(e) You may elect to test more randomly chosen engines than we require under this section.

■ 151. Amend § 1042.315 by revising paragraphs (a)(1) and (b) to read as follows:

**§ 1042.315 Determining compliance.**

\* \* \* \* \*

(a) \* \* \*

(1) *Initial and final test results.* Calculate and round the test results for each engine. If you do multiple tests on an engine in a given configuration (without modifying the engine), calculate the initial results for each test, then add all the test results together and divide by the number of tests. Round



this final calculated value for the final test results on that engine. Include the Green Engine Factor to determine low-hour emission results, if applicable.

\* \* \* \* \*

(b) For Category 1 and Category 2 engines, if a production-line engine fails to meet emission standards and you test additional engines as described in § 1042.310, calculate the average emission level for each pollutant for all the engines. If the calculated average emission level for any pollutant exceeds the applicable emission standard, the engine family fails the production-line testing requirements of this subpart. Tell us within ten working days if an engine fails. You may request to amend the application for certification to raise the FEL of the engine family as described in § 1042.225(f).

■ 152. Amend § 1042.320 by revising paragraph (c) to read as follows:

**§ 1042.320 What happens if one of my production-line engines fails to meet emission standards?**

\* \* \* \* \*

(c) Use test data from a failing engine for the compliance demonstration under § 1042.315 as follows:

(1) Use the original, failing test results as described in § 1042.315, whether or not you modify the engine or destroy it. However, for catalyst-equipped engines, you may ask us to allow you to exclude an initial failed test if all the following are true:

- (i) The catalyst was in a green condition when tested initially.
(ii) The engine met all emission standards when retested after degreening the catalyst.

(iii) No additional emission-related maintenance or repair was performed between the initial failed test and the subsequent passing test.

(2) Do not use test results from a modified engine as final test results under § 1042.315, unless you change your production process for all engines to match the adjustments you made to the failing engine. If you change production processes and use the test results from a modified engine, count the modified engine as the next engine in the sequence, rather than averaging the results with the testing that occurred before modifying the engine.

■ 153. Amend § 1042.325 by revising paragraph (b) to read as follows:

**§ 1042.325 What happens if an engine family fails the production-line testing requirements?**

\* \* \* \* \*

(b) We will tell you in writing if we suspend your certificate in whole or in part. We will not suspend a certificate

until at least 15 days after the engine family fails as described in § 1042.315(b). The suspension is effective when you receive our notice.

\* \* \* \* \*

■ 154. Revise § 1042.345 to read as follows:

**§ 1042.345 Reporting.**

(a) Send us a test report within 45 days after you complete production-line testing for a Category 1 or Category 2 engine family, and within 45 days after you finish testing each Category 3 engine. We may approve a later submission for Category 3 engines if it allows you to combine test reports for multiple engines.

(b) Include the following information in the report:

(1) Describe any facility used to test production-line engines and state its location.

(2) For Category 1 and Category 2 engines, describe how you randomly selected engines.

(3) Describe each test engine, including the engine family's identification and the engine's model year, build date, model number, identification number, and number of hours of operation before testing. Also describe how you developed and applied the Green Engine Factor, if applicable.

(4) Identify how you accumulated hours of operation on the engines and describe the procedure and schedule you used.

(5) Provide the test number; the date, time and duration of testing; test procedure; all initial test results; final test results; and final deteriorated test results for all tests. Provide the emission results for all measured pollutants. Include information for both valid and invalid tests and the reason for any invalidation.

(6) Describe completely and justify any nonroutine adjustment, modification, repair, preparation, maintenance, or test for the test engine if you did not report it separately under this subpart. Include the results of any emission measurements, regardless of the procedure or type of engine.

(c) We may ask you to add information to your written report so we can determine whether your new engines conform with the requirements of this subpart. We may also ask you to send less information.

(d) An authorized representative of your company must sign the following statement:

We submit this report under sections 208 and 213 of the Clean Air Act. Our production-line testing conformed completely with the requirements of 40

CFR part 1042. We have not changed production processes or quality-control procedures for test engines in a way that might affect emission controls. All the information in this report is true and accurate to the best of my knowledge. I know of the penalties for violating the Clean Air Act and the regulations. (Authorized Company Representative)

(e) Send electronic reports of production-line testing to the Designated Compliance Officer using an approved information format. If you want to use a different format, send us a written request with justification for a waiver. You may combine reports from multiple engines and engine families into a single report.

(f) We will send copies of your reports to anyone from the public who asks for them. See § 1042.915 for information on how we treat information you consider confidential.

■ 155. Amend § 1042.515 by revising paragraph (d) to read as follows:

**§ 1042.515 Test procedures related to not-to-exceed standards.**

\* \* \* \* \*

(d) Engine testing may occur at any conditions expected during normal operation but that are outside the conditions described in paragraph (c) of this section, as long as measured values are corrected to be equivalent to the nearest end of the specified range, using good engineering judgment. Correct NOx emissions for humidity as specified in 40 CFR part 1065, subpart G.

\* \* \* \* \*

■ 156. Amend § 1042.615 by revising paragraph (g) introductory text to read as follows:

**§ 1042.615 Replacement engine exemption.**

\* \* \* \* \*

(g) In unusual circumstances, you may ask us to allow you to apply the replacement engine exemption of this section for repowering a steamship or a vessel that becomes a "new vessel" under § 1042.901 as a result of modifications, as follows:

\* \* \* \* \*

■ 157. Amend § 1042.660 by revising paragraph (b) to read as follows:

**§ 1042.660 Requirements for vessel manufacturers, owners, and operators.**

\* \* \* \* \*

(b) For vessels equipped with SCR systems requiring the use of urea or other reductants, owners and operators must report to the Designated Compliance Officer within 30 days any operation of such vessels without the appropriate reductant. For each

reportable incident, include the cause of the noncompliant operation, the remedy, and an estimate of the extent of operation without reductant. You must remedy the problem as soon as practicable to avoid violating the tampering prohibition in 40 CFR 1068.101(b)(1). If the remedy is not complete within 30 days of the incident, notify the Designated Compliance Officer when the issue is resolved, along with any relevant additional information related to the repair. This reporting requirement applies for all engines on covered vessels even if the engines are certified to Annex VI standards instead of or in addition to EPA standards under this part. Failure to comply with the reporting requirements of this paragraph (b) is a violation of 40 CFR 1068.101(a)(2). Note that operating such engines without reductant is a violation of 40 CFR 1068.101(b)(1).

■ 158. Amend § 1042.901 by revising the definitions of “Category 1”,

“Category 2”, “Critical emission-related component”, and “Designated Compliance Officer” and removing the definition of “Designated Enforcement Officer” to read as follows:

**§ 1042.901 Definitions.**

*Category 1* means relating to a marine engine with specific engine displacement below 7.0 liters per cylinder. See § 1042.670 to determine equivalent per-cylinder displacement for nonreciprocating marine engines (such as gas turbine engines). Note that the maximum specific engine displacement for Category 1 engines subject to Tier 1 and Tier 2 standards was 5.0 liters per cylinder.

*Category 2* means relating to a marine engine with a specific engine displacement at or above 7.0 liters per cylinder but less than 30.0 liters per cylinder. See § 1042.670 to determine equivalent per-cylinder displacement for nonreciprocating marine engines (such as gas turbine engines). Note that

the minimum specific engine displacement for Category 2 engines subject to Tier 1 and Tier 2 standards was 5.0 liters per cylinder.

*Critical emission-related component* has the meaning given in 40 CFR 1068.30.

*Designated Compliance Officer* means the Director, Diesel Engine Compliance Center, U.S. Environmental Protection Agency, 2000 Traverwood Drive, Ann Arbor, MI 48105; *complianceinfo@epa.gov*; *www.epa.gov/ve-certification*.

■ 159. Amend appendix I to part 1042 by revising paragraph (a) to read as follows:

**Appendix I to Part 1042—Summary of Previous Emission Standards**

(a) *Engines below 37 kW*. Tier 1 and Tier 2 standards for engines below 37 kW originally adopted under 40 CFR part 89 apply as follows:

TABLE 1 TO APPENDIX I—EMISSION STANDARDS FOR ENGINES BELOW 37 kW [g/kW-hr]

Rated power (kW)	Tier	Model year	NMHC + NO <sub>x</sub>	CO	PM
kW < 8	Tier 1	2000	10.5	8.0	1.0
	Tier 2	2005	7.5	8.0	0.80
8 ≤ kW ≤ 19	Tier 1	2000	9.5	6.6	0.80
	Tier 2	2005	7.5	6.6	0.80
19 ≥ kW ≥ 37	Tier 1	1999	9.5	5.5	0.80
	Tier 2	2004	7.5	5.5	0.60

**PART 1043—CONTROL OF NO<sub>x</sub>, SO<sub>x</sub>, AND PM EMISSIONS FROM MARINE ENGINES AND VESSELS SUBJECT TO THE MARPOL PROTOCOL**

■ 160. The authority citation for part 1043 continues to read as follows:

**Authority:** 33 U.S.C. 1901–1912.

■ 161. Amend § 1043.20 by removing the definition of “Public vessels” and adding a definition of “Public vessel” in alphabetical order to read as follows:

**§ 1043.20 Definitions.**

*Public vessel* means a warship, naval auxiliary vessel, or other vessel owned or operated by a sovereign country when engaged in noncommercial service. Vessels with a national security exemption under 40 CFR 1042.635 are deemed to be public vessels with respect to compliance with NO<sub>x</sub>-related requirements of this part when engaged in noncommercial service. Similarly,

vessels with one or more installed engines that have a national security exemption under 40 CFR 1090.605 are deemed to be public vessels with respect to compliance with fuel content requirements when engaged in noncommercial service.

■ 162. Amend § 1043.55 by revising paragraphs (a) and (b) to read as follows:

**§ 1043.55 Applying equivalent controls instead of complying with fuel requirements.**

(a) The U.S. Coast Guard is the approving authority under APPS for such equivalent methods for U.S.-flagged vessels.

(b) The provisions of this paragraph (b) apply for vessels equipped with controls certified by the U.S. Coast Guard or the Administration of a foreign-flag vessel to achieve emission levels equivalent to those achieved by the use of fuels meeting the applicable fuel sulfur limits of Regulation 14 of

Annex VI. Fuels not meeting the applicable fuel sulfur limits of Regulation 14 of Annex VI may be used on such vessels consistent with the provisions of the IAPP certificate, APPS and Annex VI.

■ 163. Amend § 1043.95 by revising paragraph (b) to read as follows:

**§ 1043.95 Great Lakes provisions.**

(b) The following exemption provisions apply for ships qualifying under paragraph (a) of this section:

(1) The fuel-use requirements of this part do not apply through December 31, 2025, if we approved an exemption under this section before [effective date of the final rule] based on the use of replacement engines certified to applicable standards under 40 CFR part 1042 corresponding to the date the vessel entered dry dock for service. All other requirements under this part 1043 continue to apply to exempted vessels,

including requirements related to bunker delivery notes.

(2) A marine diesel engine installed to repower a steamship may be a replacement engine under Regulation 13.2.2 of Annex VI. Such an engine may qualify for an exemption from the Tier III NO<sub>x</sub> standard under Regulation 13.2.2 of Annex VI.

\* \* \* \* \*

**PART 1045—CONTROL OF EMISSIONS FROM SPARK-IGNITION PROPULSION MARINE ENGINES AND VESSELS**

■ 164. The authority citation for part 1045 continues to read as follows:

Authority: 42 U.S.C. 7401–7671q.

■ 165. Amend § 1045.115 by revising paragraphs (e) and (f) to read as follows:

**§ 1045.115 What other requirements apply?**

\* \* \* \* \*

(e) *Adjustable parameters.* Engines that have adjustable parameters must meet all the requirements of this part for any adjustment in the physically adjustable range. We may require that you set adjustable parameters to any specification within the adjustable range during any testing, including certification testing, production-line testing, or in-use testing. General provisions for adjustable parameters apply as specified in 40 CFR 1068.50.

(f) *Prohibited controls.* You may not design your engines with emission control devices, systems, or elements of design that cause or contribute to an unreasonable risk to public health, welfare, or safety while operating. For example, an engine may not emit a noxious or toxic substance it would otherwise not emit that contributes to such an unreasonable risk.

\* \* \* \* \*

■ 166. Amend § 1045.205 by revising paragraph (r) to read as follows:

**§ 1045.205 What must I include in my application?**

\* \* \* \* \*

(r) Describe all adjustable operating parameters (see § 1045.115(e)), including production tolerances. For any operating parameters that do not qualify as adjustable parameters, include a description supporting your conclusion (see 40 CFR 1068.50(c)). Include the following in your description of each adjustable parameter:

(1) For mechanically controlled parameters, include the nominal or recommended setting, the intended physically adjustable range, and the limits or stops used to establish adjustable ranges. Also include

information showing why the limits, stops, or other means of inhibiting adjustment are effective in preventing adjustment of parameters on in-use engines to settings outside your intended physically adjustable ranges.

(2) For electronically controlled parameters, describe how your engines are designed to prevent unauthorized adjustments.

\* \* \* \* \*

■ 167. Amend § 1045.801 by revising the definition of “Critical emission-related component” to read as follows:

**§ 1045.801 What definitions apply to this part?**

\* \* \* \* \*

*Critical emission-related component* has the meaning given in 40 CFR 1068.30.

\* \* \* \* \*

■ 168. Revise § 1045.815 to read as follows:

**§ 1045.815 What provisions apply to confidential information?**

The provisions of 40 CFR 1068.10 and 1068.11 apply for information you submit under this part.

**PART 1048—CONTROL OF EMISSIONS FROM NEW, LARGE NONROAD SPARK-IGNITION ENGINES**

■ 169. The authority citation for part 1048 continues to read as follows:

Authority: 42 U.S.C. 7401–7671q.

■ 170. Amend § 1048.115 by revising paragraphs (e) and (f) to read as follows:

**§ 1048.115 What other requirements apply?**

\* \* \* \* \*

(e) *Adjustable parameters.* Engines that have adjustable parameters must meet all the requirements of this part for any adjustment in the physically adjustable range. We may require that you set adjustable parameters to any specification within the adjustable range during any testing, including certification testing, production-line testing, or in-use testing. General provisions for adjustable parameters apply as specified in 40 CFR 1068.50.

(f) *Prohibited controls.* You may not design your engines with emission control devices, systems, or elements of design that cause or contribute to an unreasonable risk to public health, welfare, or safety while operating. For example, an engine may not emit a noxious or toxic substance it would otherwise not emit that contributes to such an unreasonable risk.

\* \* \* \* \*

■ 171. Amend § 1048.205 by revising paragraph (t) to read as follows:

**§ 1048.205 What must I include in my application?**

\* \* \* \* \*

(t) Describe all adjustable operating parameters (see § 1048.115(e)), including production tolerances. For any operating parameters that do not qualify as adjustable parameters, include a description supporting your conclusion (see 40 CFR 1068.50(c)). Include the following in your description of each adjustable parameter:

(1) For mechanically controlled parameters, include the nominal or recommended setting, the intended physically adjustable range, and the limits or stops used to establish adjustable ranges. Also include information showing why the limits, stops, or other means of inhibiting adjustment are effective in preventing adjustment of parameters on in-use engines to settings outside your intended physically adjustable ranges.

(2) For electronically controlled parameters, describe how your engines are designed to prevent unauthorized adjustments.

\* \* \* \* \*

■ 172. Amend § 1048.240 by adding paragraph (f) to read as follows:

**§ 1048.240 How do I demonstrate that my engine family complies with exhaust emission standards?**

\* \* \* \* \*

(f) You may alternatively determine and verify deterioration factors based on bench-aged aftertreatment as described in 40 CFR 1036.245 and 1036.246, with the following exceptions:

(1) Apply the percentage of useful life from Table 1 of 40 CFR 1036.246 based on hours of operation rather than vehicle mileage.

(2) Use good engineering judgment to perform verification testing using the procedures of § 1048.515 rather than 40 CFR 1036.520. Measure emissions as the equipment goes through its normal operation over the course of the day (or shift-day).

■ 173. Amend § 1048.501 by revising paragraph (e)(2) to read as follows:

**§ 1048.501 How do I run a valid emission test?**

\* \* \* \* \*

(e) \* \* \*

(2) For engines equipped with carbon canisters that store fuel vapors that will be purged for combustion in the engine, precondition the canister as specified in 40 CFR 86.132–96(h) and then operate the engine for 60 minutes over repeat runs of the duty cycle specified in appendix II of this part.

\* \* \* \* \*

■ 174. Amend § 1048.620 by revising paragraphs (a)(3), (d), and (e) to read as follows:

**§ 1048.620 What are the provisions for exempting large engines fueled by natural gas or liquefied petroleum gas?**

(a) \* \* \*

(3) The engine must be in an engine family that has a valid certificate of conformity showing that it meets emission standards for engines of that power rating under 40 CFR part 1039.

\* \* \* \* \*

(d) Engines exempted under this section are subject to all the requirements affecting engines under 40 CFR part 1039. The requirements and restrictions of 40 CFR part 1039 apply to anyone manufacturing engines exempted under this section, anyone manufacturing equipment that uses these engines, and all other persons in the same manner as if these were nonroad diesel engines.

(e) You may request an exemption under this section by submitting an application for certification for the engines under 40 CFR part 1039.

■ 175. Amend § 1048.801 by revising the definition of “Critical emission-related component” to read as follows:

**§ 1048.801 What definitions apply to this part?**

\* \* \* \* \*

*Critical emission-related component* has the meaning given in 40 CFR 1068.30.

\* \* \* \* \*

■ 176. Revise § 1048.815 to read as follows:

**§ 1048.815 What provisions apply to confidential information?**

The provisions of 40 CFR 1068.10 and 1068.11 apply for information you submit under this part.

**PART 1051—CONTROL OF EMISSIONS FROM RECREATIONAL ENGINES AND VEHICLES**

■ 177. The authority citation for part 1051 continues to read as follows:

**Authority:** 42 U.S.C. 7401–7671q.

■ 178. Amend § 1051.115 by revising paragraphs (c), (d) introductory text, (d)(1), (d)(2) introductory text, and (e) to read as follows:

**§ 1051.115 What other requirements apply?**

\* \* \* \* \*

(c) *Adjustable parameters.* Vehicles that have adjustable parameters must meet all the requirements of this part for any adjustment in the physically adjustable range. Note that parameters

that control the air-fuel ratio may be treated separately under paragraph (d) of this section. We may require that you set adjustable parameters to any specification within the adjustable range during any testing, including certification testing, production-line testing, or in-use testing. General provisions for adjustable parameters apply as specified in 40 CFR 1068.50.

(d) *Other adjustments.* The following provisions apply for engines with carburetor jets or needles, and for engines with any other technology involving service to adjust air-fuel ratio that falls within the time and cost specifications of 40 CFR 1068.50(d)(1):

(1) In your application for certification, specify the physically adjustable range of air-fuel ratios you expect to occur in use. You may specify it in terms of engine parts (such as the carburetor jet size and needle configuration as a function of atmospheric conditions).

(2) The physically adjustable range specified in paragraph (d)(1) of this section must include all air-fuel ratios between the lean limit and the rich limit, unless you can show that some air-fuel ratios will not occur in use.

\* \* \* \* \*

(e) *Prohibited controls.* You may not design your engines with emission control devices, systems, or elements of design that cause or contribute to an unreasonable risk to public health, welfare, or safety while operating. For example, an engine may not emit a noxious or toxic substance it would otherwise not emit that contributes to such an unreasonable risk.

\* \* \* \* \*

■ 179. Amend § 1051.205 by revising paragraph (q) to read as follows:

**§ 1051.205 What must I include in my application?**

\* \* \* \* \*

(q) Describe all adjustable operating parameters (see § 1051.115(e)), including production tolerances. For any operating parameters that do not qualify as adjustable parameters, include a description supporting your conclusion (see 40 CFR 1068.50(c)). Include the following in your description of each adjustable parameter:

(1) For mechanically controlled parameters, include the nominal or recommended setting, the intended physically adjustable range, and the limits or stops used to establish adjustable ranges. Also include information showing why the limits, stops, or other means of inhibiting adjustment are effective in preventing adjustment of parameters on in-use

engines to settings outside your intended physically adjustable ranges.

(2) For electronically controlled parameters, describe how your vehicles or engines are designed to prevent unauthorized adjustments.

\* \* \* \* \*

■ 180. Amend § 1051.501 by revising paragraphs (c)(2), (d)(2)(i) and (d)(3) to read as follows:

**§ 1051.501 What procedures must I use to test my vehicles or engines?**

\* \* \* \* \*

(c) \* \* \*

(2) Prior to permeation testing of fuel line, precondition the fuel line by filling it with the fuel specified in paragraph (d)(3) of this section, sealing the openings, and soaking it for 4 weeks at (23 ± 5) °C. To measure fuel-line permeation emissions, use the equipment and procedures specified in SAE J30 as described in 40 CFR 1060.810. Use the fuel specified in paragraph (d)(3) of this section. Perform daily measurements for 14 days, except that you may omit up to two daily measurements in any seven-day period. Maintain an ambient temperature of (23 ± 2) °C throughout the sampling period, except for intervals up to 30 minutes for weight measurements.

(d) \* \* \*

(2) \* \* \*

(i) For the preconditioning soak described in § 1051.515(a)(1) and fuel slosh durability test described in § 1051.515(d)(3), use the fuel specified in 40 CFR 1065.710(b), or the fuel specified in 40 CFR 1065.710(c) blended with 10 percent ethanol by volume. As an alternative, you may use Fuel CE10, which is Fuel C as specified in ASTM D471 (see 40 CFR 1060.810) blended with 10 percent ethanol by volume.

\* \* \* \* \*

(3) *Fuel hose permeation.* Use the fuel specified in 40 CFR 1065.710(b), or the fuel specified in 40 CFR 1065.710(c) blended with 10 percent ethanol by volume for permeation testing of fuel lines. As an alternative, you may use Fuel CE10, which is Fuel C as specified in ASTM D471 (see 40 CFR 1060.810) blended with 10 percent ethanol by volume.

\* \* \* \* \*

■ 181. Amend § 1051.515 by revising paragraph (a)(1) to read as follows:

**§ 1051.515 How do I test my fuel tank for permeation emissions?**

\* \* \* \* \*

(a) \* \* \*

(1) Fill the tank with the fuel specified in § 1051.501(d)(2)(i), seal it,

and allow it to soak at 28 ± 5 °C for 20 weeks or at (43 ± 5) °C for 10 weeks.

\* \* \* \* \*

■ 182. Amend § 1051.740 by revising paragraph (b)(5) to read as follows:

**§ 1051.740 Are there special averaging provisions for snowmobiles?**

\* \* \* \* \*

(b) \* \* \*

(5) Credits can also be calculated for Phase 3 using both sets of standards. Without regard to the trigger level values, if your net emission reduction for the redesignated averaging set exceeds the requirements of Phase 3 in § 1051.103 (using both HC and CO in the Phase 3 equation in § 1051.103), then your credits are the difference between the Phase 3 reduction requirement of that section and your calculated value.

■ 183. Amend § 1051.801 by revising the definition of “Critical emission-related component” to read as follows:

**§ 1051.801 What definitions apply to this part?**

\* \* \* \* \*

*Critical emission-related component* has the meaning given in 40 CFR 1068.30.

\* \* \* \* \*

■ 184. Revise § 1051.815 to read as follows:

**§ 1051.815 What provisions apply to confidential information?**

The provisions of 40 CFR 1068.10 and 1068.11 apply for information you submit under this part.

**PART 1054—CONTROL OF EMISSIONS FROM NEW, SMALL NONROAD SPARK-IGNITION ENGINES AND EQUIPMENT**

■ 185. The authority citation for part 1054 continues to read as follows:

**Authority:** 42 U.S.C. 7401–7671q.

■ 186. Amend § 1054.115 by revising paragraphs (b) and (d) to read as follows:

**§ 1054.115 What other requirements apply?**

\* \* \* \* \*

(b) *Adjustable parameters.* Engines that have adjustable parameters must meet all the requirements of this part for any adjustment in the physically adjustable range. We may require that you set adjustable parameters to any specification within the adjustable range during any testing, including certification testing, production-line testing, or in-use testing. You may ask us to limit idle-speed or carburetor adjustments to a smaller range than the

physically adjustable range if you show us that the engine will not be adjusted outside of this smaller range during in-use operation without significantly degrading engine performance. General provisions for adjustable parameters apply as specified in 40 CFR 1068.50.

\* \* \* \* \*

(d) *Prohibited controls.* You may not design your engines with emission control devices, systems, or elements of design that cause or contribute to an unreasonable risk to public health, welfare, or safety while operating. For example, an engine may not emit a noxious or toxic substance it would otherwise not emit that contributes to such an unreasonable risk.

\* \* \* \* \*

■ 187. Amend § 1054.205 by revising paragraph (q) to read as follows:

**§ 1054.205 What must I include in my application?**

\* \* \* \* \*

(q) Describe all adjustable operating parameters (see § 1054.115(b)), including production tolerances. For any operating parameters that do not qualify as adjustable parameters, include a description supporting your conclusion (see 40 CFR 1068.50(c)). Include the following in your description of each adjustable parameter:

(1) For mechanically controlled parameters, include the nominal or recommended setting, the intended physically adjustable range, and the limits or stops used to establish adjustable ranges. Also include information showing why the limits, stops, or other means of inhibiting adjustment are effective in preventing adjustment of parameters on in-use engines to settings outside your intended physically adjustable ranges.

(2) For electronically controlled parameters, describe how your engines are designed to prevent unauthorized adjustments.

\* \* \* \* \*

■ 188. Amend § 1054.230 by revising paragraphs (b)(8) and (9) to read as follows:

**§ 1054.230 How do I select emission families?**

\* \* \* \* \*

(b) \* \* \*

(8) Method of control for engine operation, other than governing. For example, multi-cylinder engines with port fuel injection may not be grouped into an emission family with engines that have a single throttle-body injector or carburetor.

(9) The numerical level of the applicable emission standards. For

example, an emission family may not include engines certified to different family emission limits, though you may change family emission limits without recertifying as specified in § 1054.225.

\* \* \* \* \*

■ 189. Amend § 1054.505 by revising paragraphs (a), (b) introductory text, (b)(2), and (d) to read as follows:

**§ 1054.505 How do I test engines?**

(a) This section describes how to test engines under steady-state conditions. We may also perform other testing as allowed by the Clean Air Act. Sample emissions separately for each mode, then calculate an average emission level for the whole cycle using the weighting factors specified for each mode. Control engine speed as specified in this section. Use one of the following methods for confirming torque values for nonhandheld engines:

(1) Calculate torque-related cycle statistics and compare with the established criteria as specified in 40 CFR 1065.514 to confirm that the test is valid.

(2) Evaluate each mode separately to validate the duty cycle. All torque feedback values recorded during non-idle sampling periods must be within ±2 percent of the reference value or within ±0.27 N·m of the reference value, whichever is greater. Also, the mean torque value during non-idle sampling periods must be within ±1 percent of the reference value or ±0.12 N·m of the reference value, whichever is greater. Control torque during idle as specified in paragraph (c) of this section.

(b) Measure emissions by testing engines on a dynamometer with the test procedures for constant-speed engines in 40 CFR part 1065 while using the steady-state duty cycles identified in this paragraph (b) to determine whether it meets the exhaust emission standards specified in § 1054.101(a). This paragraph (b) applies for all engines, including those not meeting the definition of “constant-speed engine” in 40 CFR 1065.1001.

\* \* \* \* \*

(2) For nonhandheld engines designed to idle, use the six-mode duty cycle described in paragraph (b)(1) of appendix II of this part; use the five-mode duty cycle described in paragraph (b)(2) of appendix II of this part for engines that are not designed to idle. Control engine speed during the full-load operating mode as specified in paragraph (d) of this section. For all other modes, control engine speed to within 5 percent of the nominal speed specified in paragraph (d) of this section or let the installed governor (in the

production configuration) control engine speed. For all modes except idle, control torque as needed to meet the cycle-validation criteria in paragraph (a) of this section. The governor may be adjusted before emission sampling to target the nominal speed identified in paragraph (d) of this section, but the installed governor must control engine speed throughout the emission-sampling period whether the governor is adjusted or not.

\* \* \* \* \*

(d) During full-load operation for nonhandheld engines, operate the engine with the following parameters:

(1) Select an engine speed for testing as follows:

(i) For engines with a governed speed at full load between 2700 and 4000 rpm, select appropriate test speeds for the emission family. If all the engines in the emission family are used in intermediate-speed equipment, select a test speed of 3060 rpm. The test associated with intermediate-speed operation is referred to as the A Cycle. If all the engines in the emission family are used in rated-speed equipment, select a test speed of 3600 rpm. The test associated with rated-speed operation is referred to as the B Cycle. If an emission family includes engines used in both intermediate-speed equipment and rated-speed equipment, measure emissions at test speeds of both 3060 and 3600 rpm. In unusual circumstances, you may ask to use a test speed different than that specified in this paragraph (d)(1)(i) if it better represents in-use operation.

(ii) For engines with a governed speed below 2700 or above 4000 rpm, ask us to approve one or more test speeds to represent those engines using the provisions for special procedures in 40 CFR 1065.10(c)(2).

\* \* \* \* \*

- 190. Amend § 1054.801 by:
  - a. Revising the definition for “Critical emission-related component”.
  - b. Removing the definition for “Discrete mode”.
  - c. Revising the definition for “Intermediate-speed equipment”.
  - d. Removing the definition for “Ramped-modal”.
  - e. Revising the definitions for “Rated-speed equipment” and “Steady-state”.

The revisions read as follows:

**§ 1054.801 What definitions apply to this part?**

\* \* \* \* \*

Critical emission-related component has the meaning given in 40 CFR 1068.30.

\* \* \* \* \*

Intermediate-speed equipment includes all nonhandheld equipment in which the installed engine’s governed speed at full load is below 3330 rpm. It may also include nonhandheld equipment in which the installed engine’s governed speed at full load is as high as 3400 rpm.

\* \* \* \* \*

Rated-speed equipment includes all nonhandheld equipment in which the installed engine’s governed speed at full load is at or above 3400 rpm. It may also include nonhandheld equipment in

which the installed engine’s governed speed at full load is as low as 3330 rpm.

\* \* \* \* \*

Steady-state means relating to emission tests in which engine speed and load are held at a finite set of essentially constant values.

\* \* \* \* \*

■ 191. Revise § 1054.815 to read as follows:

**§ 1054.815 What provisions apply to confidential information?**

The provisions of 40 CFR 1068.10 and 1068.11 apply for information you submit under this part.

■ 192. Redesignate appendix I to part 1054 as appendix A to part 1054 and amend newly redesignated appendix A by revising paragraph (b)(3) introductory text to read as follows:

**Appendix A to Part 1054—Summary of Previous Emission Standards**

\* \* \* \* \*

(b) \* \* \*

(3) Note that engines subject to Phase 1 standards were not subject to useful life, deterioration factor, production-line testing, or in-use testing provisions. In addition, engines subject to Phase 1 standards and engines subject to Phase 2 standards were both not subject to the following provisions:

\* \* \* \* \*

■ 193. Redesignate appendix II to part 1054 as appendix B to part 1054 and revise newly redesignated appendix B to read as follows:

**Appendix B to Part 1054—Duty Cycles for Laboratory Testing**

(a) Test handheld engines with the following steady-state duty cycle:

TABLE 1 TO APPENDIX B—DUTY CYCLE FOR HANDHELD ENGINES

G3 mode No.	Engine speed <sup>a</sup>	Torque (percent) <sup>b</sup>	Weighting factors
1 .....	Rated speed .....	100	0.85
2 .....	Warm idle .....	0	0.15

<sup>a</sup> Test engines at the specified speeds as described in § 1054.505.

<sup>b</sup> Test engines at 100 percent torque by setting operator demand to maximum. Control torque during idle at its warm idle speed as described in 40 CFR 1065.510.

(b) Test nonhandheld engines with one of the following steady-state duty cycles:

(1) The following duty cycle applies for engines designed to idle:

TABLE 2 TO APPENDIX B—DUTY CYCLE FOR NONHANDHELD ENGINES WITH IDLE

G2 mode No. <sup>a</sup>	Torque (percent) <sup>b</sup>	Weighting factors
1 .....	100	0.09
2 .....	75	0.20
3 .....	50	0.29

TABLE 2 TO APPENDIX B—DUTY CYCLE FOR NONHANDHELD ENGINES WITH IDLE—Continued

G2 mode No. <sup>a</sup>	Torque (percent) <sup>b</sup>	Weighting factors
4 .....	25	0.30
5 .....	10	0.07
6 .....	0	0.05

<sup>a</sup> Control engine speed as described in § 1054.505. Control engine speed for Mode 6 as described in § 1054.505(c) for idle operation.

<sup>b</sup> The percent torque is relative to the value established for full-load torque, as described in § 1054.505.

(2) The following duty cycle applies for engines that are not designed to idle:

TABLE 3 TO APPENDIX B—DUTY CYCLE FOR NONHANDHELD ENGINES WITHOUT IDLE

Mode No. <sup>a</sup>	Torque (percent) <sup>b</sup>	Weighting factors
1 .....	100	0.09

TABLE 3 TO APPENDIX B—DUTY CYCLE FOR NONHANDHELD ENGINES WITHOUT IDLE—Continued

Table with 3 columns: Mode No. a, Torque (percent) b, Weighting factors. Rows 2-5 with values: (2, 75, 0.21), (3, 50, 0.31), (4, 25, 0.32), (5, 10, 0.07)

a Control engine speed as described in § 1054.505.

b The percent torque is relative to the value established for full-load torque, as described in § 1054.505.

PART 1060—CONTROL OF EVAPORATIVE EMISSIONS FROM NEW AND IN-USE NONROAD AND STATIONARY EQUIPMENT

194. The authority citation for part 1060 continues to read as follows:

Authority: 42 U.S.C. 7401–7671q.

195. Amend § 1060.515 by revising paragraphs (c) and (d) to read as follows:

§ 1060.515 How do I test EPA Nonroad Fuel Lines and EPA Cold-Weather Fuel Lines for permeation emissions?

\* \* \* \* \*

(c) Except as specified in paragraph (d) of this section, measure fuel line permeation emissions using the equipment and procedures for weight-loss testing specified in SAE J30 or SAE J1527 (incorporated by reference in § 1060.810). Start the measurement procedure within 8 hours after draining and refilling the fuel line. Perform the emission test over a sampling period of 14 days. You may omit up to two daily measurements in any seven-day period. Determine your final emission result based on the average of measured values over the 14-day period. Maintain an ambient temperature of (23±2) °C throughout the sampling period, except for intervals up to 30 minutes for daily weight measurements.

(d) For fuel lines with a nominal inner diameter below 5.0 mm, you may

alternatively measure fuel line permeation emissions using the equipment and procedures for weight-loss testing specified in SAE J2996 (incorporated by reference in § 1060.810). Determine your final emission result based on the average of measured values over the 14-day sampling period. Maintain an ambient temperature of (23±2) °C throughout the sampling period, except for intervals up to 30 minutes for daily weight measurements.

\* \* \* \* \*

196. Amend § 1060.520 by revising paragraph (b)(1) to read as follows:

§ 1060.520 How do I test fuel tanks for permeation emissions?

\* \* \* \* \*

(b) \* \* \*

(1) Fill the fuel tank to its nominal capacity with the fuel specified in paragraph (e) of this section, seal it, and allow it to soak at (28±5) °C for at least 20 weeks. Alternatively, the fuel tank may be soaked for at least 10 weeks at (43±5) °C. You may count the time of the preconditioning steps in paragraph (a) of this section as part of the preconditioning fuel soak as long as the ambient temperature remains within the specified temperature range and the fuel tank continues to be at least 40 percent full throughout the test; you may add or replace fuel as needed to conduct the specified durability procedures. Void the test if you determine that the fuel tank has any kind of leak.

\* \* \* \* \*

PART 1065—ENGINE-TESTING PROCEDURES

197. The authority citation for part 1065 continues to read as follows:

Authority: 42 U.S.C. 7401–7671q.

198. Amend § 1065.1 by revising paragraphs (a)(1) through (5) and (8) to read as follows:

§ 1065.1 Applicability.

(a) \* \* \*

(1) Locomotives we regulate under 40 CFR part 1033.

(2) Heavy-duty highway engines we regulate under 40 CFR parts 86 and 1036.

(3) Nonroad compression-ignition engines we regulate under 40 CFR part 1039 and stationary diesel engines that are certified to the standards in 40 CFR part 1039 as specified in 40 CFR part 60, subpart IIII.

(4) Marine compression-ignition engines we regulate under 40 CFR part 1042.

(5) Marine spark-ignition engines we regulate under 40 CFR part 1045.

\* \* \* \* \*

(8) Small nonroad spark-ignition engines we regulate under 40 CFR part 1054 and stationary engines that are certified to the standards in 40 CFR part 1054 as specified in 40 CFR part 60, subpart JJJJ.

\* \* \* \* \*

199. Amend § 1065.5 by revising paragraphs (a) introductory text and (c) to read as follows:

§ 1065.5 Overview of this part 1065 and its relationship to the standard-setting part.

(a) This part specifies procedures that apply generally to measuring brake-specific emissions from various categories of engines. See subpart L of this part for measurement procedures for testing related to standards other than brake-specific emission standards. See the standard-setting part for directions in applying specific provisions in this part for a particular type of engine. Before using this part's procedures, read the standard-setting part to answer at least the following questions:

\* \* \* \* \*

(c) The following table shows how this part divides testing specifications into subparts:

TABLE 1 OF § 1065.5—DESCRIPTION OF PART 1065 SUBPARTS

Table with 2 columns: This subpart, Describes these specifications or procedures. Rows Subpart A through L with descriptions of applicability, equipment, measurement instruments, calibration, test procedures, etc.

■ 200. Amend § 1065.10 by revising paragraph (c)(7)(ii) to read as follows:

**§ 1065.10 Other procedures.**

\* \* \* \* \*

(c) \* \* \*

(7) \* \* \*

(ii) *Submission.* Submit requests in writing to the EPA Program Officer.

\* \* \* \* \*

■ 201. Amend § 1065.12 by revising paragraph (a) to read as follows:

**§ 1065.12 Approval of alternate procedures.**

(a) To get approval for an alternate procedure under § 1065.10(c), send the EPA Program Officer an initial written request describing the alternate procedure and why you believe it is equivalent to the specified procedure. Anyone may request alternate procedure approval. This means that an individual engine manufacturer may request to use an alternate procedure. This also means that an instrument manufacturer may request to have an instrument, equipment, or procedure approved as an alternate procedure to those specified in this part. We may approve your request based on this information alone, whether or not it includes all the information specified in this section. Where we determine that your original submission does not include enough information for us to determine that the alternate procedure is equivalent to the specified procedure, we may ask you to submit supplemental information showing that your alternate procedure is consistently and reliably at least as accurate and repeatable as the specified procedure.

\* \* \* \* \*

■ 202. Amend § 1065.140 by revising paragraph (b)(2) introductory text, (c)(2) and (6), and (e)(4) to read as follows:

**§ 1065.140 Dilution for gaseous and PM constituents.**

\* \* \* \* \*

(b) \* \* \*

(2) Measure these background concentrations the same way you measure diluted exhaust constituents, or measure them in a way that does not affect your ability to demonstrate compliance with the applicable standards in this chapter. For example, you may use the following simplifications for background sampling:

\* \* \* \* \*

(c) \* \* \*

(2) *Pressure control.* Maintain static pressure at the location where raw exhaust is introduced into the tunnel within  $\pm 1.2$  kPa of atmospheric pressure. You may use a booster blower

to control this pressure. If you test using more careful pressure control and you show by engineering analysis or by test data that you require this level of control to demonstrate compliance at the applicable standards in this chapter, we will maintain the same level of static pressure control when we test.

\* \* \* \* \*

(6) *Aqueous condensation.* You must address aqueous condensation in the CVS as described in this paragraph (c)(6). You may meet these requirements by preventing or limiting aqueous condensation in the CVS from the exhaust inlet to the last emission sample probe. See paragraph (c)(6)(2)(B) of this section for provisions related to the CVS between the last emission sample probe and the CVS flow meter. You may heat and/or insulate the dilution tunnel walls, as well as the bulk stream tubing downstream of the tunnel to prevent or limit aqueous condensation. Where we allow aqueous condensation to occur, use good engineering judgment to ensure that the condensation does not affect your ability to demonstrate that your engines comply with the applicable standards in this chapter (see § 1065.10(a)).

\* \* \* \* \*

(e) \* \* \*

(4) Control sample temperature to a  $(47\pm 5)$  °C tolerance, as measured anywhere within 20 cm upstream or downstream of the PM storage media (such as a filter). You may instead measure sample temperature up to 30 cm upstream of the filter or other PM storage media if it is housed within a chamber with temperature controlled to stay within the specified temperature range. Measure sample temperature with a bare-wire junction thermocouple with wires that are  $(0.500 \pm 0.025)$  mm diameter, or with another suitable instrument that has equivalent performance.

■ 203. Amend § 1065.170 by revising paragraphs (a)(1) and (c)(1)(ii) and (iii) to read as follows:

**§ 1065.170 Batch sampling for gaseous and PM constituents.**

\* \* \* \* \*

(a) \* \* \*

(1) Verify proportional sampling after an emission test as described in § 1065.545. You must exclude from the proportional sampling verification any portion of the test where you are not sampling emissions because the engine is turned off and the batch samplers are not sampling, accounting for exhaust transport delay in the sampling system. Use good engineering judgment to select storage media that will not significantly change measured emission levels (either

up or down). For example, do not use sample bags for storing emissions if the bags are permeable with respect to emissions or if they off gas emissions to the extent that it affects your ability to demonstrate compliance with the applicable gaseous emission standards in this chapter. As another example, do not use PM filters that irreversibly absorb or adsorb gases to the extent that it affects your ability to demonstrate compliance with the applicable PM emission standards in this chapter.

\* \* \* \* \*

(c) \* \* \*

(1) \* \* \*

(ii) The filter must be circular, with an overall diameter of  $(46.50\pm 0.6)$  mm and an exposed diameter of at least 38 mm. See the cassette specifications in paragraph (c)(1)(vii) of this section.

(iii) We highly recommend that you use a pure PTFE filter material that does not have any flow-through support bonded to the back and has an overall thickness of  $(40\pm 20)$  µm. An inert polymer ring may be bonded to the periphery of the filter material for support and for sealing between the filter cassette parts. We consider Polymethylpentene (PMP) and PTFE inert materials for a support ring, but other inert materials may be used. See the cassette specifications in paragraph (c)(1)(vii) of this section. We allow the use of PTFE-coated glass fiber filter material, as long as this filter media selection does not affect your ability to demonstrate compliance with the applicable standards in this chapter, which we base on a pure PTFE filter material. Note that we will use pure PTFE filter material for compliance testing, and we may require you to use pure PTFE filter material for any compliance testing we require, such as for selective enforcement audits.

\* \* \* \* \*

**§ 1065.190 [Amended]**

■ 204. Amend § 1065.190 by removing paragraphs (g)(5) and (6).

■ 205. Amend § 1065.210 by revising paragraph (a) to read as follows:

**§ 1065.210 Work input and output sensors.**

(a) *Application.* Use instruments as specified in this section to measure work inputs and outputs during engine operation. We recommend that you use sensors, transducers, and meters that meet the specifications in Table 1 of § 1065.205. Note that your overall systems for measuring work inputs and outputs must meet the linearity verifications in § 1065.307. We recommend that you measure work inputs and outputs where they cross the system boundary as shown in Figure 1



of § 1065.210. The system boundary is different for air-cooled engines than for liquid-cooled engines. If you choose to measure work before or after a work conversion, relative to the system boundary, use good engineering judgment to estimate any work-conversion losses in a way that avoids overestimation of total work. For example, if it is impractical to instrument the shaft of an exhaust turbine generating electrical work, you may decide to measure its converted electrical work. As another example,

you may decide to measure the tractive (*i.e.*, electrical output) power of a locomotive, rather than the brake power of the locomotive engine. In these cases, divide the electrical work by accurate values of electrical generator efficiency ( $\eta < 1$ ), or assume an efficiency of 1 ( $\eta = 1$ ), which would over-estimate brake-specific emissions. For the example of using locomotive tractive power with a generator efficiency of 1 ( $\eta = 1$ ), this means using the tractive power as the brake power in emission calculations. Do not underestimate any work

conversion efficiencies for any components outside the system boundary that do not return work into the system boundary. And do not overestimate any work conversion efficiencies for components outside the system boundary that do return work into the system boundary. In all cases, ensure that you are able to accurately demonstrate compliance with the applicable standards in this chapter.

**BILLING CODE 6560-50-P**

Figure 1 to paragraph (a) of § 1065.210: Work Inputs, Outputs, and System Boundaries

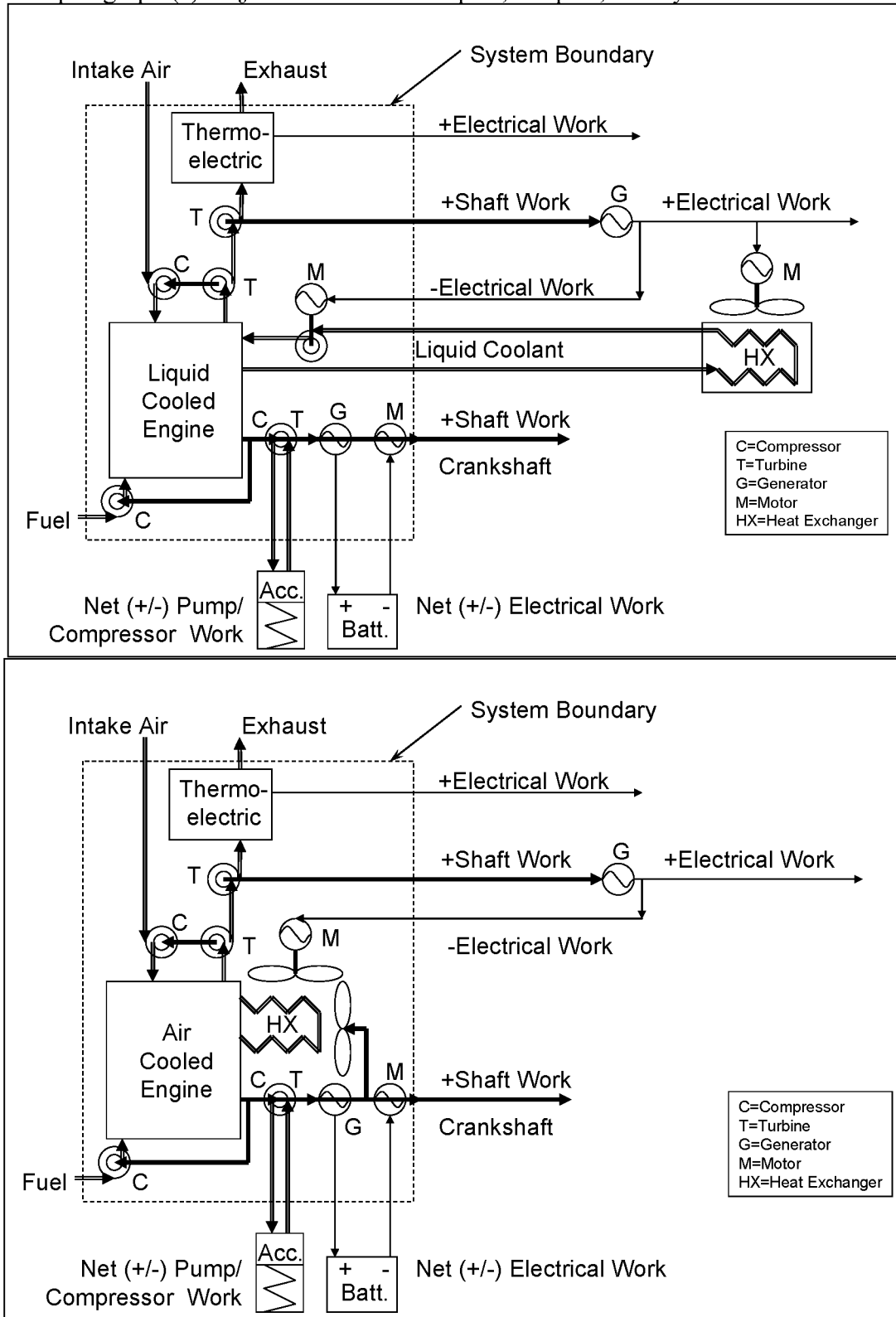

BILLING CODE 6560-50-C

\* \* \* \* \*

■ 206. Add § 1065.274 to subpart C to read as follows:

**§ 1065.274 Zirconium dioxide (ZrO<sub>2</sub>) NO<sub>x</sub> analyzer.**

(a) *Application.* You may use a zirconia oxide (ZrO<sub>2</sub>) analyzer to

measure NO<sub>x</sub> in raw exhaust for field-testing engines.

(b) *Component requirements.* We recommend that you use a ZrO<sub>2</sub> analyzer that meets the specifications in

Table 1 of § 1065.205. Note that your ZrO<sub>2</sub>-based system must meet the linearity verification in § 1065.307.

(c) *Species measured.* The ZrO<sub>2</sub>-based system must be able to measure and report NO and NO<sub>2</sub> together as NO<sub>x</sub>. If the ZrO<sub>2</sub>-based system cannot measure all of the NO<sub>2</sub>, you may develop and apply correction factors based on good engineering judgment to account for this deficiency.

(d) *Interference.* You must account for NH<sub>3</sub> interference with the NO<sub>x</sub> measurement.

■ 207. Amend § 1065.284 by revising the section heading to read as follows:

**§ 1065.284 Zirconium dioxide (ZrO<sub>2</sub>) air-fuel ratio and O<sub>2</sub> analyzer.**

\* \* \* \* \*

■ 208. Add § 1065.298 to subpart C to read as follows:

**§ 1065.298 Correcting real-time PM measurement based on gravimetric PM filter measurement for field-testing analysis.**

(a) *Application.* You may quantify net PM on a sample medium for field testing with a continuous PM measurement with correction based on gravimetric PM filter measurement.

(b) *Measurement principles.* Photoacoustic or electrical aerosol instruments used in field-testing typically under-report PM emissions. Apply the verifications and corrections described in this section to meet accuracy requirements.

(c) *Component requirements.* (1) Gravimetric PM measurement must meet the laboratory measurement requirements of this part 1065, noting that there are specific exceptions to some laboratory requirements and specification for field testing given in § 1065.905(d)(2). In addition to those exceptions, field testing does not require you to verify proportional flow control as specified in § 1065.545. Note also that the linearity requirements of § 1065.307 apply only as specified in this section.

(2) Check the calibration and linearity of the photoacoustic and electrical aerosol instruments according to the instrument manufacturer's instructions and the following recommendations:

(i) For photoacoustic instruments we recommend one of the following:

(A) Use a reference elemental carbon-based PM source to calibrate the instrument. Verify the photoacoustic instrument by comparing results either to a gravimetric PM measurement collected on the filter or to an elemental carbon analysis of collected PM.

(B) Use a light absorber that has a known amount of laser light absorption

to periodically verify the instrument's calibration factor. Place the light absorber in the path of the laser beam. This verification checks the integrity of the microphone sensitivity, the power of the laser diode, and the performance of the analog-to-digital converter.

(C) Verify that you meet the linearity requirements in Table 1 of § 1065.307 by generating a maximum reference PM mass concentration (verified gravimetrically) and then using partial-flow sampling to dilute to various evenly distributed concentrations.

(ii) For electrical aerosol instruments we recommend one of the following:

(A) Use reference monodisperse or polydisperse PM-like particles with a mobility diameter or count median diameter greater than 45 nm. Use an electrometer or condensation particle counter that has a d<sub>50</sub> at or below 10 nm to verify the reference values.

(B) Verify that you meet the linearity requirements in Table 1 of § 1065.307 using a maximum reference particle concentration, a zero-reference concentration, and at least two other evenly distributed points. Use partial-flow dilution to create the additional reference PM concentrations. The difference between measured values from the electrical aerosol and reference instruments at each point must be no greater than 15% of the mean value from the two measurements at that point.

(d) *Loss correction.* You may use PM loss corrections to account for PM loss in the sample handling system.

(e) *Correction.* Develop a multiplicative correction factor to ensure that total PM measured by photoacoustic or electrical aerosol instruments equate to the gravimetric filter-based total PM measurement. Calculate the correction factor by dividing the mass of PM captured on the gravimetric filter by the quantity represented by the total concentration of PM measured by the instrument multiplied by the time over the test interval multiplied by the gravimetric filter sample flow rate.

■ 209. Amend § 1065.301 by revising paragraph (d) to read as follows:

**§ 1065.301 Overview and general provisions.**

\* \* \* \* \*

(d) Use NIST-traceable standards to the tolerances we specify for calibrations and verifications. Where we specify the need to use NIST-traceable standards, you may alternatively use international standards recognized by

the CIPM Mutual Recognition Arrangement that are not NIST-traceable.

■ 210. Amend § 1065.305 by revising paragraph (d)(10)(ii) to read as follows:

**§ 1065.305 Verifications for accuracy, repeatability, and noise.**

\* \* \* \* \*

(d) \* \* \*

(10) \* \* \*

(ii) The measurement deficiency does not adversely affect your ability to demonstrate compliance with the applicable standards in this chapter.

■ 211. Amend § 1065.307 by revising paragraphs (b), (d) introductory text, and (f) to read as follows:

**§ 1065.307 Linearity verification.**

\* \* \* \* \*

(b) *Performance requirements.* If a measurement system does not meet the applicable linearity criteria referenced in Table 1 of this section, correct the deficiency by re-calibrating, servicing, or replacing components as needed. Repeat the linearity verification after correcting the deficiency to ensure that the measurement system meets the linearity criteria. Before you may use a measurement system that does not meet linearity criteria, you must demonstrate to us that the deficiency does not adversely affect your ability to demonstrate compliance with the applicable standards in this chapter.

\* \* \* \* \*

(d) *Reference signals.* This paragraph (d) describes recommended methods for generating reference values for the linearity-verification protocol in paragraph (c) of this section. Use reference values that simulate actual values, or introduce an actual value and measure it with a reference-measurement system. In the latter case, the reference value is the value reported by the reference-measurement system. Reference values and reference-measurement systems must be NIST-traceable. We recommend using calibration reference quantities that are NIST-traceable within ±0.5% uncertainty, if not specified elsewhere in this part 1065. Use the following recommended methods to generate reference values or use good engineering judgment to select a different reference:

\* \* \* \* \*

(f) *Performance criteria for measurement systems.* Table 1 follows:

BILLING CODE 6560-50-P

TABLE 1 OF § 1065.307—MEASUREMENT SYSTEMS THAT REQUIRE LINEARITY VERIFICATION

Measurement system	Quantity	Linearity criteria			
		$ x_{\min}(a_1-1)+a_0 $	$a_1$	$SEE$	$r^2$
Speed	$f_n$	$\leq 0.05\% \cdot f_{n\max}$	0.98-1.02	$\leq 2\% \cdot f_{n\max}$	$\geq 0.990$
Torque	$T$	$\leq 1\% \cdot T_{\max}$	0.98-1.02	$\leq 2\% \cdot T_{\max}$	$\geq 0.990$
Electrical power	$P$	$\leq 1\% \cdot P_{\max}$	0.98-1.02	$\leq 2\% \cdot P_{\max}$	$\geq 0.990$
Current	$I$	$\leq 1\% \cdot I_{\max}$	0.98-1.02	$\leq 2\% \cdot I_{\max}$	$\geq 0.990$
Voltage	$U$	$\leq 1\% \cdot U_{\max}$	0.98-1.02	$\leq 2\% \cdot U_{\max}$	$\geq 0.990$
Fuel flow rate	$\dot{m}$	$\leq 1\% \cdot \dot{m}_{\max}$	0.98-1.02	$\leq 2\% \cdot \dot{m}_{\max}$	$\geq 0.990$
Fuel mass scale	$m$	$\leq 0.3\% \cdot m_{\max}$	0.996-1.004	$\leq 0.4\% \cdot m_{\max}$	$\geq 0.999$
DEF flow rate	$\dot{m}$	$\leq 1\% \cdot \dot{m}_{\max}$	0.98-1.02	$\leq 2\% \cdot \dot{m}_{\max}$	$\geq 0.990$
DEF mass scale	$m$	$\leq 0.3\% \cdot m_{\max}$	0.996-1.004	$\leq 0.4\% \cdot m_{\max}$	$\geq 0.999$
Intake-air flow rate <sup>a</sup>	$\dot{n}$	$\leq 1\% \cdot \dot{n}_{\max}$	0.98-1.02	$\leq 2\% \cdot \dot{n}_{\max}$	$\geq 0.990$
Dilution air flow rate <sup>a</sup>	$\dot{n}$	$\leq 1\% \cdot \dot{n}_{\max}$	0.98-1.02	$\leq 2\% \cdot \dot{n}_{\max}$	$\geq 0.990$
Diluted exhaust flow rate <sup>a</sup>	$\dot{n}$	$\leq 1\% \cdot \dot{n}_{\max}$	0.98-1.02	$\leq 2\% \cdot \dot{n}_{\max}$	$\geq 0.990$
Raw exhaust flow rate <sup>a</sup>	$\dot{n}$	$\leq 1\% \cdot \dot{n}_{\max}$	0.98-1.02	$\leq 2\% \cdot \dot{n}_{\max}$	$\geq 0.990$
Batch sampler flow rates <sup>a</sup>	$\dot{n}$	$\leq 1\% \cdot \dot{n}_{\max}$	0.98-1.02	$\leq 2\% \cdot \dot{n}_{\max}$	$\geq 0.990$
Gas dividers	$x/x_{\text{span}}$	$\leq 0.5\% \cdot x_{\max}/x_{\text{span}}$	0.98-1.02	$\leq 2\% \cdot x_{\max}/x_{\text{span}}$	$\geq 0.990$
Gas analyzers for laboratory testing	$x$	$\leq 0.5\% \cdot x_{\max}$	0.99-1.01	$\leq 1\% \cdot x_{\max}$	$\geq 0.998$
Gas analyzers for field testing	$x$	$\leq 1\% \cdot x_{\max}$	0.99-1.01	$\leq 1\% \cdot x_{\max}$	$\geq 0.998$
Electrical aerosol analyzer for field testing	$x$	$\leq 5\% \cdot x_{\max}$	0.85-1.15	$\leq 10\% \cdot x_{\max}$	$\geq 0.950$
Photoacoustic analyzer for field testing	$x$	$\leq 5\% \cdot x_{\max}$	0.90-1.10	$\leq 10\% \cdot x_{\max}$	$\geq 0.980$
PM balance	$m$	$\leq 1\% \cdot m_{\max}$	0.99-1.01	$\leq 1\% \cdot m_{\max}$	$\geq 0.998$
Pressures	$p$	$\leq 1\% \cdot p_{\max}$	0.99-1.01	$\leq 1\% \cdot p_{\max}$	$\geq 0.998$
Dewpoint for intake air, PM-stabilization and balance environments	$T_{\text{dew}}$	$\leq 0.5\% \cdot T_{\text{dewmax}}$	0.99-1.01	$\leq 0.5\% \cdot T_{\text{dewmax}}$	$\geq 0.998$
Other dewpoint measurements	$T_{\text{dew}}$	$\leq 1\% \cdot T_{\text{dewmax}}$	0.99-1.01	$\leq 1\% \cdot T_{\text{dewmax}}$	$\geq 0.998$
Analog-to-digital conversion of temperature signals	$T$	$\leq 1\% \cdot T_{\max}$	0.99-1.01	$\leq 1\% \cdot T_{\max}$	$\geq 0.998$

<sup>a</sup>For flow meters that determine volumetric flow rate,  $\dot{V}_{\text{std}}$ , you may substitute  $\dot{V}_{\text{std}}$  for  $\dot{n}$  as the quantity and substitute  $\dot{V}_{\text{stdmax}}$  for  $\dot{n}_{\max}$ .

\* \* \* \* \*

BILLING CODE 6560-50-C

■ 212. Amend § 1065.308 by revising paragraph (e)(3) to read as follows:

**§ 1065.308 Continuous gas analyzer system-response and updating-recording verification—for gas analyzers not continuously compensated for other gas species.**

\* \* \* \* \*

(e) \* \* \*

(3) If a measurement system fails the criteria in paragraphs (e)(1) and (2) of this section, you may use the measurement system only if the

deficiency does not adversely affect your ability to show compliance with the applicable standards in this chapter.

\* \* \* \* \*

■ 213. Amend § 1065.309 by revising paragraph (e)(3) to read as follows:

**§ 1065.309 Continuous gas analyzer system-response and updating-recording verification—for gas analyzers continuously compensated for other gas species.**

\* \* \* \* \*

(e) \* \* \*

(3) If a measurement system fails the criteria in paragraphs (e)(1) and (2) of this section, you may use the

measurement system only if the deficiency does not adversely affect your ability to show compliance with the applicable standards in this chapter.

\* \* \* \* \*

■ 214. Amend § 1065.315 by revising paragraphs (a)(1) through (3) and (b) to read as follows:

**§ 1065.315 Pressure, temperature, and dewpoint calibration.**

(a) \* \* \*

(1) *Pressure.* We recommend temperature-compensated, digital-pneumatic, or deadweight pressure calibrators, with data-logging

capabilities to minimize transcription errors. We recommend using calibration reference quantities that are NIST-traceable within ±0.5% uncertainty.

(2) *Temperature.* We recommend digital dry-block or stirred-liquid temperature calibrators, with data logging capabilities to minimize transcription errors. We recommend using calibration reference quantities that are NIST-traceable within ±0.5% uncertainty. You may perform linearity verification for temperature measurement systems with thermocouples, RTDs, and thermistors by removing the sensor from the system and using a simulator in its place. Use a NIST-traceable simulator that is independently calibrated and, as appropriate, cold-junction compensated. The simulator uncertainty scaled to absolute temperature must be less than 0.5% of  $T_{max}$ . If you use this option, you must use sensors that the supplier states are accurate to better than 0.5% of  $T_{max}$  compared with their standard calibration curve.

(3) *Dewpoint.* We recommend a minimum of three different temperature-equilibrated and temperature-monitored calibration salt solutions in containers that seal completely around the dewpoint sensor. We recommend using calibration reference quantities that are NIST-traceable within ±0.5% uncertainty.

(b) You may remove system components for off-site calibration. We recommend specifying calibration reference quantities that are NIST-traceable within ±0.5% uncertainty. ■ 215. Amend § 1065.320 by revising paragraph (c) to read as follows:

**§ 1065.320 Fuel-flow calibration.**

\* \* \* \* \*

(c) You may remove system components for off-site calibration. When installing a flow meter with an off-site calibration, we recommend that you consider the effects of the tubing configuration upstream and downstream of the flow meter. We recommend specifying calibration reference quantities that are NIST-traceable within ±0.5% uncertainty.

■ 216. Amend § 1065.325 by revising paragraphs (a) and (b) to read as follows:

**§ 1065.325 Intake-flow calibration.**

(a) Calibrate intake-air flow meters upon initial installation. Follow the instrument manufacturer's instructions and use good engineering judgment to repeat the calibration. We recommend using a calibration subsonic venturi, ultrasonic flow meter or laminar flow element. We recommend using calibration reference quantities that are

NIST-traceable within ±0.5% uncertainty.

(b) You may remove system components for off-site calibration. When installing a flow meter with an off-site calibration, we recommend that you consider the effects of the tubing configuration upstream and downstream of the flow meter. We recommend specifying calibration reference quantities that are NIST-traceable within ±0.5% uncertainty.

\* \* \* \* \*

■ 217. Amend § 1065.330 by revising paragraphs (a) and (b) to read as follows:

**§ 1065.330 Exhaust-flow calibration.**

(a) Calibrate exhaust-flow meters upon initial installation. Follow the instrument manufacturer's instructions and use good engineering judgment to repeat the calibration. We recommend that you use a calibration subsonic venturi or ultrasonic flow meter and simulate exhaust temperatures by incorporating a heat exchanger between the calibration meter and the exhaust-flow meter. If you can demonstrate that the flow meter to be calibrated is insensitive to exhaust temperatures, you may use other reference meters such as laminar flow elements, which are not commonly designed to withstand typical raw exhaust temperatures. We recommend using calibration reference quantities that are NIST-traceable within ±0.5% uncertainty.

(b) You may remove system components for off-site calibration. When installing a flow meter with an off-site calibration, we recommend that you consider the effects of the tubing configuration upstream and downstream of the flow meter. We recommend specifying calibration reference quantities that are NIST-traceable within ±0.5% uncertainty.

\* \* \* \* \*

■ 218. Amend § 1065.345 by revising paragraph (d) to read as follows:

**§ 1065.345 Vacuum-side leak verification.**

\* \* \* \* \*

(d) Dilution-of-span-gas leak test. You may use any gas analyzer for this test. If you use a FID for this test, correct for any HC contamination in the sampling system according to § 1065.660. If you use an O<sub>2</sub> analyzer described in § 1065.280 for this test, you may use purified N<sub>2</sub> to detect a leak. To avoid misleading results from this test, we recommend using only analyzers that have a repeatability of 0.5% or better at the reference gas concentration used for this test. Perform a vacuum-side leak test as follows:

(1) Prepare a gas analyzer as you would for emission testing.

(2) Supply reference gas to the analyzer span port and record the measured value.

(3) Route overflow reference gas to the inlet of the sample probe or at a tee fitting in the transfer line near the exit of the probe. You may use a valve upstream of the overflow fitting to prevent overflow of reference gas out of the inlet of the probe, but you must then provide an overflow vent in the overflow supply line.

(4) Verify that the measured overflow reference gas concentration is within ±0.5% of the concentration measured in paragraph (d)(2) of this section. A measured value lower than expected indicates a leak, but a value higher than expected may indicate a problem with the reference gas or the analyzer itself. A measured value higher than expected does not indicate a leak.

\* \* \* \* \*

■ 219. Amend § 1065.350 by revising paragraph (e)(1) to read as follows:

**§ 1065.350 H<sub>2</sub>O interference verification for CO<sub>2</sub> NDIR analyzers.**

\* \* \* \* \*

(e) \* \* \*

(1) You may omit this verification if you can show by engineering analysis that for your CO<sub>2</sub> sampling system and your emission-calculation procedures, the H<sub>2</sub>O interference for your CO<sub>2</sub> NDIR analyzer always affects your brake-specific emission results within ±0.5% of each of the applicable standards in this chapter. This specification also applies for vehicle testing, except that it relates to emission results in g/mile or g/kilometer.

\* \* \* \* \*

■ 220. Amend § 1065.405 by revising paragraph (a) to read as follows:

**§ 1065.405 Test engine preparation and maintenance.**

\* \* \* \* \*

(a) If you are testing an emission-data engine for certification, make sure it is built to represent production engines, consistent with paragraph (f) of this section.

(1) This includes governors that you normally install on production engines. Production engines should also be tested with their installed governors. If your engine is equipped with multiple user-selectable governor types and if the governor does not manipulate the emission control system (*i.e.*, the governor only modulates an "operator demand" signal such as commanded fuel rate, torque, or power), choose the governor type that allows the test cell to most accurately follow the duty cycle. If the governor manipulates the emission control system, treat it as an adjustable

parameter. If you do not install governors on production engines, simulate a governor that is representative of a governor that others will install on your production engines.

(2) In certain circumstances, you may incorporate test cell components to simulate an in-use configuration, consistent with good engineering judgment. For example, §§ 1065.122 and 1065.125 allow the use of test cell components to represent engine cooling and intake air systems.

(3) The provisions in § 1065.110(e) also apply to emission-data engines for certification.

(4) For engines using SCR, use any size DEF tank and fuel tank. We may require you to give us a production-type DEF tank, including any associated sensors, for our testing.

\* \* \* \* \*

■ 221. Amend § 1065.410 by revising paragraph (c) to read as follows:

**§ 1065.410 Maintenance limits for stabilized test engines.**

\* \* \* \* \*

(c) If you inspect an engine, keep a record of the inspection and update your application for certification to document any changes that result. You may use any kind of equipment, instrument, or tool that is available at dealerships and other service outlets to identify malfunctioning components or perform maintenance. You may inspect using electronic tools to monitor engine performance, but only if the information is readable without specialized equipment.

\* \* \* \* \*

■ 222. Amend § 1065.501 by revising paragraph (a) introductory text to read as follows:

**§ 1065.501 Overview.**

(a) Use the procedures detailed in this subpart to measure engine emissions over a specified duty cycle. Refer to subpart J of this part for field test procedures that describe how to measure emissions during in-use engine operation. Refer to subpart L of this part for measurement procedures for testing related to standards other than brake-specific emission standards. This section describes how to—

\* \* \* \* \*

■ 223. Amend § 1065.510 by revising paragraphs (a) introductory text, (b) introductory text, (b)(4) through (6), (c)(2), and (g)(2)(i) to read as follows:

**§ 1065.510 Engine mapping.**

(a) *Applicability, scope, and frequency.* An engine map is a data set that consists of a series of paired data points that represent the maximum

brake torque versus engine speed, measured at the engine's primary output shaft. Map your engine if the standard-setting part requires engine mapping to generate a duty cycle for your engine configuration. Map your engine while it is connected to a dynamometer or other device that can absorb work output from the engine's primary output shaft according to § 1065.110. Configure any auxiliary work inputs and outputs such as hybrid, turbo-compounding, or thermoelectric systems to represent their in-use configurations, and use the same configuration for emission testing. See Figure 1 of § 1065.210. This may involve configuring initial states of charge and rates and times of auxiliary-work inputs and outputs. We recommend that you contact the EPA Program Officer before testing to determine how you should configure any auxiliary-work inputs and outputs. If your engine has an auxiliary emission control device to reduce torque output that may activate during engine mapping, turn it off before mapping. Use the most recent engine map to transform a normalized duty cycle from the standard-setting part to a reference duty cycle specific to your engine. Normalized duty cycles are specified in the standard-setting part. You may update an engine map at any time by repeating the engine-mapping procedure. You must map or re-map an engine before a test if any of the following apply:

\* \* \* \* \*

(b) *Mapping variable-speed engines.*

Map variable-speed engines using the procedure in this paragraph (b). Note that under § 1065.10(c) we may allow or require you to use "other procedures" if the specified procedure results in unrepresentative testing or if your engine cannot be tested using the specified procedure. If the engine has a user-adjustable idle speed setpoint, you may set it to its minimum adjustable value for this mapping procedure and the resulting map may be used for any test, regardless of where it is set for running each test.

\* \* \* \* \*

(4) Operate the engine at the minimum mapped speed. A minimum mapped speed equal to (95±1)% of its warm idle speed determined in paragraph (b)(3) of this section may be used for any engine or test. A higher minimum mapped speed may be used if all the duty cycles that the engine is subject to have a minimum reference speed higher than the warm idle speed determined in paragraph (b)(3) of this section. In this case you may use a minimum mapped speed equal to

(95±1)% of the lowest minimum reference speed in all the duty cycles the engine is subject to. Set operator demand to maximum and control engine speed at this minimum mapped speed for at least 15 seconds. Set operator demand to maximum and control engine speed at (95±1)% of its warm idle speed determined in paragraph (b)(3)(i) of this section for at least 15 seconds.

(5) Perform a continuous or discrete engine map as described in paragraphs (b)(5)(i) or (ii) of this section. A continuous engine map may be used for any engine. A discrete engine map may be used for engines subject only to steady-state duty cycles. Use linear interpolation between the series of points generated by either of these maps to determine intermediate torque values. Use the series of points generated by either of these maps to generate the power map as described in paragraph (e) of this section.

(i) For continuous engine mapping, begin recording mean feedback speed and torque at 1 Hz or more frequently and increase speed at a constant rate such that it takes (4 to 6) min to sweep from the minimum mapped speed described in paragraphs (b)(4) of this section to the check point speed described in paragraph (b)(5)(iii) of this section. Use good engineering judgment to determine when to stop recording data to ensure that the sweep is complete. In most cases, this means that you can stop the sweep at any point after the power falls to 50% of the maximum value.

(ii) For discrete engine mapping, select at least 20 evenly spaced setpoints from the minimum mapped speed described in paragraph (b)(4) of this section to the check point speed described in paragraph (b)(5)(iii) of this section. At each setpoint, stabilize speed and allow torque to stabilize. We recommend that you stabilize an engine for at least 15 seconds at each setpoint and record the mean feedback speed and torque of the last (4 to 6) seconds. Record the mean speed and torque at each setpoint.

(iii) The check point speed of the map is the highest speed above maximum power at which 50% of maximum power occurs. If this speed is unsafe or unachievable (e.g., for ungoverned engines or engines that do not operate at that point), use good engineering judgment to map up to the maximum safe speed or maximum achievable speed. For discrete mapping, if the engine cannot be mapped to the check point speed, make sure the map includes at least 20 points from 95% of warm idle to the maximum mapped

speed. For continuous mapping, if the engine cannot be mapped to the check point speed, verify that the sweep time from 95% of warm idle to the maximum mapped speed is (4 to 6) min.

(iv) Note that under § 1065.10(c)(1) we may allow you to disregard portions of the map when selecting maximum test speed if the specified procedure would result in a duty cycle that does not represent in-use operation.

(6) Determine warm high-idle speed for engines with a high-speed governor. You may skip this if the engine is not subject to transient testing with a duty cycle that includes reference speed values above 100%. You may use a manufacturer-declared warm high-idle speed if the engine is electronically governed. For engines with a high-speed governor that regulates speed by disabling and enabling fuel or ignition at two manufacturer-specified speeds, declare the middle of this specified speed range as the warm high-idle speed. You may alternatively measure warm high-idle speed using the following procedure:

(i) Run an operating point targeting zero torque.

(A) Set operator demand to maximum and use the dynamometer to target zero torque on the engine's primary output shaft.

(B) Wait for the engine governor and dynamometer to stabilize. We recommend that you stabilize for at least 15 seconds.

(C) Record 1 Hz means of the feedback speed and torque for at least 30 seconds. You may record means at a higher frequency as long as there are no gaps in the recorded data. For engines with a high-speed governor that regulates speed by disabling and enabling fuel or ignition, you may need to extend this stabilization period to include at least one disabling event at the higher speed and one enabling event at the lower speed.

(D) Determine if the feedback speed is stable over the recording period. The feedback speed is considered stable if all the recorded 1 Hz means are within ±2% of the mean feedback speed over the recording period. If the feedback speed is not stable because of the dynamometer, void the results and repeat measurements after making any necessary corrections. You may void and repeat the entire map sequence, or you may void and replace only the results for establishing warm high-idle speed; use good engineering judgment to warm-up the engine before repeating measurements.

(E) If the feedback speed is stable, use the mean feedback speed over the

recording period as the measured speed for this operating point.

(F) If the feedback speed is not stable because of the engine, determine the mean as the value representing the midpoint between the observed maximum and minimum recorded feedback speed.

(G) If the mean feedback torque over the recording period is within (0±1)% of  $T_{max\ mapped}$ , use the measured speed for this operating point as the warm high-idle speed. Otherwise, continue testing as described in paragraph (b)(6)(ii) of this section.

(ii) Run a second operating point targeting a positive torque. Follow the same procedure in paragraphs (b)(6)(i)(A) through (F) of this section, except that the dynamometer is set to target a torque equal to the mean feedback torque over the recording period from the previous operating point plus 20% of  $T_{max\ mapped}$ .

(iii) Use the mean feedback speed and torque values from paragraphs (b)(6)(i) and (ii) of this section to determine the warm high-idle speed. If the two recorded speed values are the same, use that value as the warm high-idle-speed. Otherwise, use a linear equation passing through these two speed-torque points and extrapolate to solve for the speed at zero torque and use this speed intercept value as the warm high-idle speed.

(iv) You may use a manufacturer-declared  $T_{max}$  instead of the measured  $T_{max\ mapped}$ . If you do this, you may also measure the warm high-idle speed as described in this paragraph (b)(6) before running the operating point and speed sweeps specified in paragraphs (b)(4) and (5) of this section.

\* \* \* \* \*

(2) Map the amount of negative torque required to motor the engine by repeating paragraph (b) of this section with minimum operator demand, as applicable. You may start the negative torque map at either the minimum or maximum speed from paragraph (b) of this section.

\* \* \* \* \*

(g) \* \* \*  
(2) \* \* \*

(i) Perform an engine map by using a series of continuous sweeps to cover the engine's full range of operating speeds. Prepare the engine for hybrid-active mapping by ensuring that the RESS state of charge is representative of normal operation. Perform the sweep as specified in paragraph (b)(5)(i) of this section, but stop the sweep to charge the RESS when the power measured from the RESS drops below the expected maximum power from the RESS by

more than 2% of total system power (including engine and RESS power). Unless good engineering judgment indicates otherwise, assume that the expected maximum power from the RESS is equal to the measured RESS power at the start of the sweep segment. For example, if the 3-second rolling average of total engine-RESS power is 200 kW and the power from the RESS at the beginning of the sweep segment is 50 kW, once the power from the RESS reaches 46 kW, stop the sweep to charge the RESS. Note that this assumption is not valid where the hybrid motor is torque-limited. Calculate total system power as a 3-second rolling average of instantaneous total system power. After each charging event, stabilize the engine for 15 seconds at the speed at which you ended the previous segment with operator demand set to maximum before continuing the sweep from that speed. Repeat the cycle of charging, mapping, and recharging until you have completed the engine map. You may shut down the system or include other operation between segments to be consistent with the intent of this paragraph (g)(2)(i). For example, for systems in which continuous charging and discharging can overheat batteries to an extent that affects performance, you may operate the engine at zero power from the RESS for enough time after the system is recharged to allow the batteries to cool. Use good engineering judgment to smooth the torque curve to eliminate discontinuities between map intervals.

\* \* \* \* \*

■ 224. Amend § 1065.512 by revising paragraph (b)(1) to read as follows:

**§ 1065.512 Duty cycle generation.**

\* \* \* \* \*

(b) \* \* \*  
(1) *Engine speed for variable-speed engines.* For variable-speed engines, normalized speed may be expressed as a percentage between warm idle speed,  $f_{idle}$ , and maximum test speed,  $f_{ntest}$ . Or speed may be expressed by referring to a defined speed by name, such as "warm idle," "intermediate speed," or "A," "B," or "C" speed. Section 1065.610 describes how to transform these normalized values into a sequence of reference speeds,  $f_{nref}$ . Running duty cycles with negative or small normalized speed values near warm idle speed may cause low-speed idle governors to activate and the engine torque to exceed the reference torque even though the operator demand is at a minimum. In such cases, we recommend controlling the dynamometer so it gives priority to follow the reference torque instead of

the reference speed and let the engine govern the speed. Note that the cycle-validation criteria in § 1065.514 allow an engine to govern itself. This allowance permits you to test engines with enhanced-idle devices and to simulate the effects of transmissions such as automatic transmissions. For example, an enhanced-idle device might be an idle speed value that is normally commanded only under cold-start conditions to quickly warm up the engine and aftertreatment devices. In this case, negative and very low normalized speeds will generate reference speeds below this higher enhanced-idle speed. You may do either of the following when using enhanced-idle devices:

(i) Control the dynamometer so it gives priority to follow the reference

torque, controlling the operator demand so it gives priority to follow reference speed and let the engine govern the speed when the operator demand is at minimum.

(ii) While running an engine where the ECM broadcasts an enhanced-idle speed that is above the denormalized speed, use the broadcast speed as the reference speed. Use these new reference points for duty-cycle validation. This does not affect how you determine denormalized reference torque in paragraph (b)(2) of this section.

(iii) If an ECM broadcast signal is not available, perform one or more practice cycles to determine the enhanced-idle speed as a function of cycle time. Generate the reference cycle as you normally would but replace any

reference speed that is lower than the enhanced-idle speed with the enhanced-idle speed. This does not affect how you determine denormalized reference torque in paragraph (b)(2) of this section.

\* \* \* \* \*

■ 225. Amend § 1065.514 by revising paragraph (d) to read as follows

**§ 1065.514 Cycle-validation criteria for operation over specified duty cycles.**

\* \* \* \* \*

(d) *Omitting additional points.* Besides engine cranking, you may omit additional points from cycle-validation statistics as described in the following table:

TABLE 1 OF § 1065.514—PERMISSIBLE CRITERIA FOR OMITTING POINTS FROM DUTY-CYCLE REGRESSION STATISTICS

When operator demand is at its . . . .	you may omit . . . .	if . . . .
<b>For reference duty cycles that are specified in terms of speed and torque (<math>f_{nref}</math>, <math>T_{ref}</math>)</b>		
minimum .....	power and torque .....	$T_{ref} < 0\%$ (motoring).
minimum .....	power and speed .....	$f_{nref} = 0\%$ (idle speed) and $T_{ref} = 0\%$ (idle torque) and $T_{ref} - (2\% \cdot T_{max\ mapped}) < T < T_{ref} + (2\% \cdot T_{max\ mapped})$ .
minimum .....	power and speed .....	$f_{nref} < \text{enhanced-idle speed}^a$ and $T_{ref} > 0\%$ .
minimum .....	power and either torque or speed	$f_n > f_{nref}$ or $T > T_{ref}$ but not if $f_n > (f_{nref} \cdot 102\%)$ and $T > T_{ref} + (2\% \cdot T_{max\ mapped})$ .
maximum .....	power and either torque or speed	$f_n < f_{nref}$ or $T < T_{ref}$ but not if $f_n < (f_{nref} \cdot 98\%)$ and $T < T_{ref} - (2\% \cdot T_{max\ mapped})$ .
<b>For reference duty cycles that are specified in terms of speed and power (<math>f_{nref}</math>, <math>P_{ref}</math>)</b>		
minimum .....	power and torque .....	$P_{ref} < 0\%$ (motoring).
minimum .....	power and speed .....	$f_{nref} = 0\%$ (idle speed) and $P_{ref} = 0\%$ (idle power) and $P_{ref} - (2\% \cdot P_{max\ mapped}) < P < P_{ref} + (2\% \cdot P_{max\ mapped})$ .
minimum .....	power and either torque or speed	$f_n > f_{nref}$ or $P > P_{ref}$ but not if $f_n > (f_{nref} \cdot 102\%)$ and $P > P_{ref} + (2\% \cdot P_{max\ mapped})$ .
maximum .....	power and either torque or speed	$f_n < f_{nref}$ or $P < P_{ref}$ but not if $f_n < (f_{nref} \cdot 98\%)$ and $P < P_{ref} - (2\% \cdot P_{max\ mapped})$ .

<sup>a</sup> Enhanced-idle speed determined from ECM broadcast or practice cycle.

\* \* \* \* \*

■ 226. Amend § 1065.545 by revising paragraphs (a) and (b) introductory text to read as follows:

**§ 1065.545 Verification of proportional flow control for batch sampling.**

\* \* \* \* \*

(a) For any pair of sample and total flow rates, use continuous recorded data or 1 Hz means. Total flow rate means the raw exhaust flow rate for raw exhaust sampling and the dilute exhaust flow rate for CVS sampling. For each test interval, determine the standard error of the estimate, *SEE*, of the sample flow rate versus the total flow rate as described in § 1065.602, forcing the intercept to zero. Determine the mean sample flow rate over each test interval as described in § 1065.602. For each test

interval, demonstrate that *SEE* is at or below 3.5% of the mean sample flow rate.

(b) For any pair of sample and total flow rates, use continuous recorded data or 1 Hz means. Total flow rate means the raw exhaust flow rate for raw exhaust sampling and the dilute exhaust flow rate for CVS sampling. For each test interval, demonstrate that each flow rate is constant within ±2.5% of its respective mean or target flow rate. You may use the following options instead of recording the respective flow rate of each type of meter:

\* \* \* \* \*

■ 227. Amend § 1065.610 by revising paragraph (c)(2) to read as follows:

**§ 1065.610 Duty cycle generation.**

\* \* \* \* \*

(c) \* \* \*

(2) *A, B, C, and D speeds.* If your normalized duty cycle specifies speeds as A, B, C, or D values, use your power-versus-speed curve to determine the lowest speed below maximum power at which 50% of maximum power occurs. Denote this value as  $n_{lo}$ . Take  $n_{lo}$  to be warm idle speed if all power points at speeds below the maximum power speed are higher than 50% of maximum power. Also determine the highest speed above maximum power at which 70% of maximum power occurs. Denote this value as  $n_{hi}$ . If all power points at speeds above the maximum power speed are higher than 70% of maximum power, take  $n_{hi}$  to be the declared maximum safe engine speed or the declared maximum representative engine speed, whichever is lower. Use



$n_{hi}$  and  $n_{lo}$  to calculate reference values for A, B, C, or D speeds as follows:

$$f_{nrefA} = 0.25 \cdot (n_{hi} - n_{lo}) + n_{lo}$$

Eq. 1065.610-4

$$f_{nrefB} = 0.50 \cdot (n_{hi} - n_{lo}) + n_{lo}$$

Eq. 1065.610-5

$$f_{nrefC} = 0.75 \cdot (n_{hi} - n_{lo}) + n_{lo}$$

Eq. 1065.610-6

$$f_{nrefD} = 0.15 \cdot (n_{hi} - n_{lo}) + n_{lo}$$

Eq. 1065.610-7

**Example:**

$$n_{lo} = 1005 \text{ r/min}$$

$$n_{hi} = 2385 \text{ r/min}$$

$$f_{nrefA} = 0.25 \cdot (2385 - 1005) + 1005$$

$$f_{nrefB} = 0.25 \cdot (2385 - 1005) + 1005$$

$$f_{nrefC} = 0.25 \cdot (2385 - 1005) + 1005$$

$$f_{nrefD} = 0.25 \cdot (2385 - 1005) + 1005$$

$$f_{nrefA} = 1350 \text{ r/min}$$

$$f_{nrefB} = 1695 \text{ r/min}$$

$$f_{nrefC} = 2040 \text{ r/min}$$

$$f_{nrefD} = 1212 \text{ r/min}$$

\* \* \* \* \*

■ 228. Amend § 1065.650 by revising paragraphs (a), (c)(2)(i), (3), (4)(i), and (6), (d)(7), (e)(1) and (2), (f)(1) and (2), and (g)(1) and (2) to read as follows:

**§ 1065.650 Emission calculations.**

(a) *General.* Calculate brake-specific emissions over each applicable duty cycle or test interval. For test intervals with zero work (or power), calculate the emission mass (or mass rate), but do not calculate brake-specific emissions. Unless specified otherwise, for the purposes of calculating and reporting emission mass (or mass rate), do not alter any negative values of measured or calculated quantities. You may truncate negative values in chemical balance quantities listed in § 1065.655(c) to facilitate convergence. For duty cycles with multiple test intervals, refer to the standard-setting part for calculations you need to determine a composite result, such as a calculation that weights and sums the results of individual test intervals in a duty cycle. If the standard-setting part does not include those calculations, use the equations in paragraph (g) of this section. This section is written based on rectangular integration, where each indexed value (*i.e.*, “*i*”) represents (or approximates) the mean value of the parameter for its respective time interval, delta-*t*. You may also integrate continuous signals

using trapezoidal integration consistent with good engineering judgment.

\* \* \* \* \*

(c) \* \* \*

(2) \* \* \*

(i) *Varying flow rate.* If you continuously sample from a varying exhaust flow rate, time align and then multiply concentration measurements by the flow rate from which you extracted it. We consider the following to be examples of varying flows that require a continuous multiplication of concentration times molar flow rate: Raw exhaust, exhaust diluted with a constant flow rate of dilution air, and CVS dilution with a CVS flow meter that does not have an upstream heat exchanger or electronic flow control. This multiplication results in the flow rate of the emission itself. Integrate the emission flow rate over a test interval to determine the total emission. If the total emission is a molar quantity, convert this quantity to a mass by multiplying it by its molar mass, *M*. The result is the mass of the emission, *m*. Calculate *m* for continuous sampling with variable flow using the following equations:

$$m = M \cdot \sum_{i=1}^N x_i \cdot \dot{n}_i \cdot \Delta t$$

Eq. 1065.650-4

Where:

$$\Delta t = 1/f_{record}$$

Eq. 1065.650-5

**Example:**

$$M_{NMHC} = 13.875389 \text{ g/mol}$$

$$N = 1200$$

$$x_{NMHC1} = 84.5 \text{ } \mu\text{mol/mol} = 84.5 \cdot 10^{-6} \text{ mol/mol}$$

$$x_{NMHC2} = 86.0 \text{ } \mu\text{mol/mol} = 86.0 \cdot 10^{-6} \text{ mol/mol}$$

$$\dot{n}_{exh1} = 2.876 \text{ mol/s}$$

$$\dot{n}_{exh2} = 2.224 \text{ mol/s}$$

$$f_{record} = 1 \text{ Hz}$$

Using Eq. 1065.650-5,

$$\Delta t = 1/1 = 1 \text{ s}$$

$$m_{NMHC} = 13.875389 \cdot (84.5 \cdot 10^{-6} \cdot 2.876 + 86.0 \cdot 10^{-6} \cdot 2.224 + \dots +$$

$$x_{NMHC1200} \cdot \dot{n}_{exh}) \cdot 1$$

$$m_{NMHC} = 25.23 \text{ g}$$

\* \* \* \* \*

(3) *Batch sampling.* For batch sampling, the concentration is a single value from a proportionally extracted batch sample (such as a bag, filter, impinger, or cartridge). In this case, multiply the mean concentration of the batch sample by the total flow from which the sample was extracted. You may calculate total flow by integrating a varying flow rate or by determining the mean of a constant flow rate, as follows:

(i) *Varying flow rate.* If you collect a batch sample from a varying exhaust flow rate, extract a sample proportional to the varying exhaust flow rate. We consider the following to be examples of varying flows that require proportional sampling: Raw exhaust, exhaust diluted with a constant flow rate of dilution air, and CVS dilution with a CVS flow meter that does not have an upstream heat exchanger or electronic flow control. Integrate the flow rate over a test interval to determine the total flow from which you extracted the proportional sample. Multiply the mean concentration of the batch sample by the total flow from which the sample was extracted to determine the total emission. If the total emission is a molar quantity, convert this quantity to a mass by multiplying it by its molar mass, *M*. The result is the total emission mass, *m*. In the case of PM emissions, where the mean PM concentration is already in

units of mass per mole of exhaust, simply multiply it by the total flow. The result is the total mass of PM,  $m_{PM}$ . Calculate  $m$  for each constituent as follows:

(A) Calculate  $m$  for measuring gaseous emission constituents with sampling that results in a molar concentration,  $\bar{x}$ , using the following equation:

$$m = M \cdot \bar{x} \cdot \sum_{i=1}^N \dot{n}_i \cdot \Delta t$$

Eq. 1065.650-6

Example:

$$M_{NO_x} = 46.0055 \text{ g/mol}$$

$$N = 9000$$

$$\bar{x}_{NO_x} = 85.6 \text{ } \mu\text{mol/mol} = 85.6 \cdot 10^{-6} \text{ mol/mol}$$

$$\dot{n}_{dexh1} = 25.534 \text{ mol/s}$$

$$\dot{n}_{dexh2} = 26.950 \text{ mol/s}$$

$$f_{record} = 5 \text{ Hz}$$

Using Eq. 1065.650-5:

$$\Delta t = 1/5 = 0.2$$

$$m_{NO_x} = 46.0055 \cdot 85.6 \cdot 10^{-6} \cdot (25.534 + 26.950 + \dots + \dot{n}_{exh9000}) \cdot 0.2$$

$$m_{NO_x} = 4.201 \text{ g}$$

(B) Calculate  $m$  for sampling PM or any other analysis of a batch sample that yields a mass per mole of exhaust,  $\bar{M}$ , using the following equation:

$$m = \bar{M} \cdot \sum_{i=1}^N \dot{n}_i \cdot \Delta t$$

Eq. 1065.650-7

(ii) *Proportional or constant flow rate.* If you batch sample from a constant exhaust flow rate, extract a sample at a proportional or constant flow rate. We consider the following to be examples of constant exhaust flows: CVS diluted exhaust with a CVS flow meter that has

either an upstream heat exchanger, electronic flow control, or both. Determine the mean molar flow rate from which you extracted the sample. Multiply the mean concentration of the batch sample by the mean molar flow rate of the exhaust from which the sample was extracted to determine the total emission and multiply the result by the time of the test interval. If the total emission is a molar quantity, convert this quantity to a mass by multiplying it by its molar mass,  $M$ . The result is the total emission mass,  $m$ . In the case of PM emissions, where the mean PM concentration is already in units of mass per mole of exhaust, simply multiply it by the total flow, and the result is the total mass of PM,  $m_{PM}$ . Calculate  $m$  for each constituent as follows:

(A) Calculate  $m$  for measuring gaseous emission constituents with sampling that results in a molar concentration,  $\bar{x}$ , using the following equation:

$$m = M \cdot \bar{x} \cdot \bar{\dot{n}} \cdot \Delta t$$

Eq. 1065.650-8

(B) Calculate  $m$  for sampling PM or any other analysis of a batch sample that yields a mass per mole of exhaust,  $\bar{M}$ , using the following equation:

$$m = \bar{M} \cdot \bar{\dot{n}} \cdot \Delta t$$

Eq. 1065.650-9

(C) The following example illustrates a calculation of  $m_{PM}$ :

$$\bar{M}_{PM} = 144.0 \text{ } \mu\text{g/mol} = 144.0 \cdot 10^{-6} \text{ g/mol}$$

$$\dot{n}_{dexh} = 57.692 \text{ mol/s}$$

$$\Delta t = 1200 \text{ s}$$

$$m_{PM} = 144.0 \cdot 10^{-6} \cdot 57.692 \cdot 1200$$

$$m_{PM} = 9.9692 \text{ g}$$

(4) \* \* \*

(i) For sampling with a constant dilution ratio,  $DR$ , of diluted exhaust

versus exhaust flow (e.g., secondary dilution for PM sampling), calculate  $m$  using the following equation:

$$m_{PM} = m_{PMdil} \cdot DR$$

Eq. 1065.650-10

Example:

$$m_{PMdil} = 6.853 \text{ g}$$

$$DR = 6:1$$

$$m_{PM} = 6.853 \cdot 6$$

$$m_{PM} = 41.118 \text{ g}$$

\* \* \* \* \*

(6) *Mass of NMNEHC.* Determine the mass of NMNEHC using one of the following methods:

(i) If the test fuel has less than 0.010 mol/mol of ethane and you omit the NMNEHC calculations as described in § 1065.660(c)(1), take the corrected mass of NMNEHC to be 0.95 times the corrected mass of NMHC.

(ii) If the test fuel has at least 0.010 mol/mol of ethane and you omit the NMNEHC calculations as described in § 1065.660(c)(1), take the corrected mass of NMNEHC to be 1.0 times the corrected mass of NMHC.

(d) \* \* \*

(7) Integrate the resulting values for power over the test interval. Calculate total work as follows:

$$W = \sum_{i=1}^N P_i \cdot \Delta t$$

Eq. 1065.650-11

Where:

$W$  = total work from the primary output shaft.

$P_i$  = instantaneous power from the primary output shaft over an interval  $i$ .

$$P_i = f_{ni} \cdot T_i$$

Eq. 1065.650-12

*Example:*

$$\begin{aligned}
 N &= 9000 \\
 f_{h1} &= 1800.2 \text{ r/min} \\
 f_{h2} &= 1805.8 \text{ r/min} \\
 T_1 &= 177.23 \text{ N}\cdot\text{m} \\
 T_2 &= 175.00 \text{ N}\cdot\text{m} \\
 C_{rev} &= 2\cdot\pi \text{ rad/r} \\
 C_{t1} &= 60 \text{ s/min} \\
 C_p &= 1000 \text{ (N}\cdot\text{m}\cdot\text{rad/s)/kW} \\
 f_{record} &= 5 \text{ Hz} \\
 C_{t2} &= 3600 \text{ s/hr} \\
 P_1 &= \frac{1800.2 \cdot 177.23 \cdot 2 \cdot 3.14159}{60 \cdot 1000} \\
 P_1 &= 33.41 \text{ kW} \\
 P_2 &= 33.09 \text{ kW} \\
 \text{Using Eq. 1065.650-5:} \\
 \Delta t &= 1/5 = 0.2 \text{ s} \\
 W &= \frac{(33.41 + 33.09 + \dots + P_{9000}) \cdot 0.2}{3600} \\
 W &= 16.875 \text{ kW}\cdot\text{hr}
 \end{aligned}$$

\* \* \* \* \*

(e) \* \* \*  
 (1) To calculate,  $\bar{m}$ , multiply its mean concentration,  $\bar{x}$ , by its corresponding mean molar flow rate,  $\bar{n}$ . If the result is a molar flow rate, convert this quantity to a mass rate by multiplying it by its molar mass,  $M$ . The result is the mean mass rate of the emission,  $\bar{m}$ . In the case of PM emissions, where the mean PM concentration is already in units of mass per mole of exhaust, simply multiply it by the mean molar flow rate,  $\bar{n}$ . The result is the mass rate of PM,  $\dot{m}_{PM}$ . Calculate  $\bar{m}$  using the following equation:

$$\bar{m} = M \cdot \bar{x} \cdot \bar{n}$$

Eq. 1065.650-13

(2) To calculate an engine's mean steady-state total power,  $\bar{P}$ , add the mean steady-state power from all the work paths described in § 1065.210 that cross the system boundary including electrical power, mechanical shaft power, and fluid pumping power. For all work paths, except the engine's primary output shaft (crankshaft), the mean steady-state power over the test interval is the integration of the net work flow rate (power) out of the system boundary divided by the period of the test interval. When power flows into the system boundary, the power/work flow rate signal becomes negative; in this case, include these negative power/work rate values in the integration to calculate the mean power from that work path. Some work paths may result

in a negative mean power. Include negative mean power values from any work path in the mean total power from the engine rather than setting these values to zero. The rest of this paragraph (e)(2) describes how to calculate the mean power from the engine's primary output shaft. Calculate  $\bar{P}$  using Eq. 1065.650-13, noting that  $\bar{P}$ ,  $\bar{f}$ , and  $\bar{T}$  refer to mean power, mean rotational shaft frequency, and mean torque from the primary output shaft. Account for the power of simulated accessories according to § 1065.110 (reducing the mean primary output shaft power or torque by the accessory power or torque). Set the power to zero during actual motoring operation (negative feedback torques), unless the engine was connected to one or more energy storage devices. Examples of such energy storage devices include hybrid powertrain batteries and hydraulic accumulators, like the ones illustrated in Figure 1 of § 1065.210. Set the power to zero for modes with a zero reference load (0 N·m reference torque or 0 kW reference power). Include power during idle modes with simulated minimum torque or power.

$$\bar{P} = \bar{f}_n \cdot \bar{T}$$

Eq. 1065.650-14

\* \* \* \* \*

(f) \* \* \*  
 (1) *Total mass.* To determine a value proportional to the total mass of an emission, determine total mass as

described in paragraph (c) of this section, except substitute for the molar flow rate,  $\dot{n}$ , or the total flow,  $n$ , with a signal that is linearly proportional to molar flow rate,  $\tilde{n}$ , or linearly proportional to total flow,  $\tilde{n}$ , as follows:

$$\tilde{m}_{fueli} = \frac{1}{w_{fuel}} \cdot \frac{M_C \cdot \tilde{n}_i \cdot x_{Ccombdryi}}{1 + x_{H2Oexhdryi}}$$

Eq. 1065.650-15

(2) *Total work.* To calculate a value proportional to total work over a test interval, integrate a value that is proportional to power. Use information about the brake-specific fuel consumption of your engine,  $e_{fuel}$ , to convert a signal proportional to fuel flow rate to a signal proportional to power. To determine a signal proportional to fuel flow rate, divide a signal that is proportional to the mass rate of carbon products by the fraction of carbon in your fuel,  $w_C$ . You may use a measured  $w_C$  or you may use default values for a given fuel as described in § 1065.655(e). Calculate the mass rate of carbon from the amount of carbon and water in the exhaust, which you determine with a chemical balance of fuel, DEF, intake air, and exhaust as described in § 1065.655. In the chemical balance, you must use concentrations from the flow that generated the signal proportional to molar flow rate,  $\tilde{n}$ , in paragraph (e)(1) of this section. Calculate a value proportional to total work as follows:

$$W = \sum_{i=1}^N \tilde{P}_i \cdot \Delta t$$

Eq. 1065.650-16

Where:

$$\tilde{P}_i = \frac{\tilde{m}_{\text{fuel}i}}{e_{\text{fuel}}}$$

Eq. 1065.650-17

\* \* \* \* \*

(g) \* \* \*

(1) Use the following equation to calculate composite brake-specific emissions for duty cycles with multiple test intervals all with prescribed durations, such as cold-start and hot-start transient cycles:

$$e_{\text{comp}} = \frac{\sum_{i=1}^N WF_i \cdot m_i}{\sum_{i=1}^N WF_i \cdot W_i}$$

Eq. 1065.650-18

Where:

$i$  = test interval number.

$N$  = number of test intervals.

$WF$  = weighting factor for the test interval as defined in the standard-setting part.

$m$  = mass of emissions over the test interval as determined in paragraph (c) of this section.

$W$  = total work from the engine over the test interval as determined in paragraph (d) of this section.

Example:

$N = 2$

$WF_1 = 0.1428$

$WF_2 = 0.8572$

$m_1 = 70.125 \text{ g}$

$m_2 = 64.975 \text{ g}$

$W_1 = 25.783 \text{ kW} \cdot \text{hr}$

$W_2 = 25.783 \text{ kW} \cdot \text{hr}$

$$e_{\text{NO}_x \text{comp}} = \frac{(0.1428 \cdot 70.125) + (0.8572 \cdot 64.975)}{(0.1428 \cdot 25.783) + (0.8572 \cdot 25.783)}$$

$e_{\text{NO}_x \text{comp}} = 2.548 \text{ g/kW} \cdot \text{hr}$

(2) Calculate composite brake-specific emissions for duty cycles with multiple test intervals that allow use of varying

duration, such as discrete-mode steady-state duty cycles, as follows:

(i) Use the following equation if you calculate brake-specific emissions over

test intervals based on total mass and total work as described in paragraph

(b)(1) of this section:

$$e_{\text{comp}} = \frac{\sum_{i=1}^N WF_i \cdot \frac{m_i}{t_i}}{\sum_{i=1}^N WF_i \cdot \frac{W_i}{t_i}}$$

Eq. 1065.650-19

Where:

$i$  = test interval number.

$N$  = number of test intervals.

$WF$  = weighting factor for the test interval as defined in the standard-setting part.

$m$  = mass of emissions over the test interval as determined in paragraph (c) of this section.

$W$  = total work from the engine over the test interval as determined in paragraph (d) of this section.

$t$  = duration of the test interval.

Example:

$N = 2$

$WF_1 = 0.85$

$WF_1 = 0.15$

$m_1 = 1.3753 \text{ g}$

$m_2 = 0.4135 \text{ g}$

$t_1 = 120 \text{ s}$

$t_2 = 200 \text{ s}$

$W_1 = 2.8375 \text{ kW} \cdot \text{hr}$

$W_2 = 0.0 \text{ kW} \cdot \text{hr}$

$$e_{\text{NO}_x \text{comp}} = \frac{\left(0.85 \cdot \frac{1.3753}{120}\right) + \left(0.15 \cdot \frac{0.4135}{200}\right)}{\left(0.85 \cdot \frac{2.8375}{120}\right) + \left(0.15 \cdot \frac{0.0}{200}\right)}$$

$e_{\text{NO}_x \text{comp}} = 0.5001 \text{ g/kW} \cdot \text{hr}$

(ii) Use the following equation if you calculate brake-specific emissions over test intervals based on the ratio of mass

rate to power as described in paragraph (b)(2) of this section:

$$e_{\text{comp}} = \frac{\sum_{i=1}^N WF_i \cdot \bar{m}_i}{\sum_{i=1}^N WF_i \cdot \bar{P}_i}$$

Eq. 1065.650-20

Where:

$i$  = test interval number.

$N$  = number of test intervals.

$WF$  = weighting factor for the test interval as defined in the standard-setting part.

$\bar{m}$  = mean steady-state mass rate of emissions over the test interval as determined in paragraph (e) of this section.

$\bar{P}$  = mean steady-state power over the test interval as described in paragraph (e) of this section.

Example:

$N = 2$

$WF_1 = 0.85$   
 $WF_2 = 0.15$   
 $\bar{m}_1 = 2.25842 \text{ g/hr}$

$\bar{m}_2 = 0.063443 \text{ g/hr}$   
 $\bar{P}_1 = 4.5383 \text{ kW}$   
 $\bar{P}_2 = 0.0 \text{ kW}$

$$e_{\text{NO}_x\text{comp}} = \frac{(0.85 \cdot 2.25842) + (0.15 \cdot 0.063443)}{(0.85 \cdot 4.5383) + (0.15 \cdot 0.0)}$$

$e_{\text{NO}_x\text{comp}} = 0.5001 \text{ g/kW} \cdot \text{hr}$

\* \* \* \* \*

■ 229. Amend § 1065.655 by revising paragraph (e)(1)(i) to read as follows:

**§ 1065.655 Chemical balances of fuel, DEF, intake air, and exhaust.**

\* \* \* \* \*

(e) \* \* \*

(1) \* \* \*

(i) Determine the carbon and hydrogen mass fractions according to ASTM D5291 (incorporated by reference in § 1065.1010). When using ASTM D5291 to determine carbon and hydrogen mass fractions of gasoline (with or without blended ethanol), use good engineering judgment to adapt the method as appropriate. This may include consulting with the instrument manufacturer on how to test high-volatility fuels. Allow the weight of volatile fuel samples to stabilize for 20 minutes before starting the analysis; if the weight still drifts after 20 minutes, prepare a new sample). Retest the sample if the carbon, hydrogen, oxygen, sulfur, and nitrogen mass fractions do not add up to a total mass of  $100 \pm 0.5\%$ ; you may assume oxygen has a zero mass contribution for this specification for diesel fuel and neat (E0) gasoline. You may also assume that sulfur and nitrogen have a zero mass contribution for this specification for all fuels except residual fuel blends.

\* \* \* \* \*

■ 230. Amend § 1065.660 by revising paragraph (c)(1) to read as follows:

**§ 1065.660 THC, NMHC, NMNEHC, CH<sub>4</sub>, and C<sub>2</sub>H<sub>6</sub> determination.**

\* \* \* \* \*

(c) \* \* \*

(1) Calculate  $X_{\text{NMNEHC}}$  based on the test fuel's ethane content as follows:  
 (i) If the content of your test fuel contains less than 0.010 mol/mol of ethane, you may omit the calculation of NMNEHC concentration and calculate the mass of NMNEHC as described in § 1065.650(c)(6)(i).  
 (ii) If the content of your fuel test contains at least 0.010 mol/mol of ethane, you may omit the calculation of NMNEHC concentration and calculate the mass of NMNEHC as described in § 1065.650(c)(6)(ii).

\* \* \* \* \*

■ 231. Amend § 1065.667 by revising paragraph (a) to read as follows:

**§ 1065.667 Dilution air background emission correction.**

(a) To determine the mass of background emissions to subtract from a diluted exhaust sample, first determine the total flow of dilution air,  $n_{\text{dil}}$ , over the test interval. This may be a measured quantity or a calculated quantity. Multiply the total flow of dilution air by the mean mole fraction (*i.e.*, concentration) of a background emission. This may be a time-weighted mean or a flow-weighted mean (*e.g.*, a proportionally sampled background). Finally, multiply by the molar mass,  $M$ , of the associated gaseous emission constituent. The product of  $n_{\text{dil}}$  and the mean molar concentration of a background emission and its molar mass,  $M$ , is the total background emission mass,  $m$ . In the case of PM, where the mean PM concentration is already in units of mass per mole of exhaust, multiply it by the total amount of dilution air flow, and the result is the total background mass of PM,  $m_{\text{PM}}$ . Subtract total background mass from total mass to correct for background emissions.

\* \* \* \* \*

■ 232. Amend § 1065.672 by revising paragraphs (d)(3) and (4) to read as follows:

**§ 1065.672 Drift correction.**

\* \* \* \* \*

(d) \* \* \*

(3) For any pre-test interval concentrations, use the last concentration determined before the test interval. For some test intervals, the last pre-zero or pre-span might have occurred before one or more earlier test intervals.

(4) For any post-test interval concentrations, use the first concentration determined after the test interval. For some test intervals, the first post-zero or post-span might occur after one or more later test intervals.

\* \* \* \* \*

■ 233. Amend § 1065.680 by revising the introductory text to read as follows:

**§ 1065.680 Adjusting emission levels to account for infrequently regenerating aftertreatment devices.**

This section describes how to calculate and apply emission adjustment factors for engines using aftertreatment technology with infrequent regeneration events that may occur during testing. These adjustment factors are typically calculated based on measurements conducted for the purposes of engine certification, and then used to adjust the results of testing related to demonstrating compliance with emission standards. For this section, “regeneration” means an intended event during which emission levels change while the system restores aftertreatment performance. For example, exhaust gas temperatures may increase temporarily to remove sulfur from an adsorber or SCR catalyst or to oxidize accumulated particulate matter in a trap. The duration of this event extends until the aftertreatment performance and emission levels have returned to normal baseline levels. Also, “infrequent” refers to regeneration events that are expected to occur on average less than once over a transient or ramped-modal duty cycle, or on average less than once per mode in a discrete-mode test.

\* \* \* \* \*

■ 234. Amend § 1065.695 by revising paragraph (a) to read as follows:

**§ 1065.695 Data requirements.**

(a) To determine the information we require from engine tests, refer to the standard-setting part and request from your EPA Program Officer the format used to apply for certification or demonstrate compliance. We may require different information for different purposes, such as for certification applications, approval requests for alternate procedures, selective enforcement audits, laboratory audits, production-line test reports, and field-test reports.

\* \* \* \* \*

■ 235. Amend § 1065.715 by revising paragraph (b)(3) to read as follows:

**§ 1065.715 Natural gas.**

\* \* \* \* \*

(b) \* \* \*

(3) You may ask for approval to use fuel that does not meet the specifications in paragraph (a) of this section, but only if using the fuel would not adversely affect your ability to

demonstrate compliance with the applicable standards in this chapter.

\* \* \* \* \*  
 ■ 236. Amend § 1065.720 by revising paragraphs (a) and (b)(3) to read as follows:

**§ 1065.720 Data requirements.**

(a) Except as specified in paragraph (b) of this section, liquefied petroleum gas for testing must meet the specifications in the following table:

TABLE 1 TO PARAGRAPH (a) OF § 1065.720—TEST FUEL SPECIFICATIONS FOR LIQUEFIED PETROLEUM GAS

Property	Value	Reference procedure <sup>a</sup>
Propane, C <sub>3</sub> H <sub>8</sub> .....	Minimum, 0.85 m <sup>3</sup> /m <sup>3</sup> ....	ASTM D2163.
Vapor pressure at 38 °C .....	Maximum, 1400 kPa .....	ASTM D1267 or ASTM D2598. <sup>b</sup>
Butanes .....	Maximum, 0.05 m <sup>3</sup> /m <sup>3</sup> ...	ASTM D2163.
Butenes .....	Maximum, 0.02 m <sup>3</sup> /m <sup>3</sup> ...	ASTM D2163.
Pentenes and heavier .....	Maximum, 0.005 m <sup>3</sup> /m <sup>3</sup> .....	ASTM D2163.
Propene .....	Maximum, 0.1 m <sup>3</sup> /m <sup>3</sup> .....	ASTM D2163.
Residual matter (residue on evaporation of 100 ml oil stain observation) .....	Maximum, 0.05 ml pass <sup>c</sup> .....	ASTM D2158.
Corrosion, copper strip .....	Maximum, No. 1 .....	ASTM D1838.
Sulfur .....	Maximum, 80 mg/kg .....	ASTM D6667.
Moisture content .....	pass .....	ASTM D2713.

<sup>a</sup> Incorporated by reference; see § 1065.1010. See § 1065.701(d) for other allowed procedures.

<sup>b</sup> If these two test methods yield different results, use the results from ASTM D1267.

<sup>c</sup> The test fuel must not yield a persistent oil ring when you add 0.3 ml of solvent residue mixture to a filter paper in 0.1 ml increments and examine it in daylight after two minutes.

(b) \* \* \*  
 (3) You may ask for approval to use fuel that does not meet the specifications in paragraph (a) of this section, but only if using the fuel would not adversely affect your ability to demonstrate compliance with the applicable standards in this chapter.

\* \* \* \* \*  
 ■ 237. Revise § 1065.790 to read as follows:

**§ 1065.790 Mass standards.**

(a) *PM balance calibration weights.* Use PM balance calibration weights that are certified as NIST-traceable within ±0.1% uncertainty. Make sure your highest calibration weight has no more than ten times the mass of an unused PM-sample medium.

(b) *Dynamometer, fuel mass scale, and DEF mass scale calibration weights.* Use dynamometer and mass scale calibration weights that are certified as NIST-traceable within ±0.1% uncertainty.

■ 238. Amend § 1065.901 by revising paragraphs (a) and (b)(3) to read as follows:

**§ 1065.901 Applicability.**

(a) *Field testing.* This subpart specifies procedures for field-testing engines to determine brake-specific emissions and mass rate emissions using portable emission measurement systems (PEMS). These procedures are designed primarily for in-field measurements of engines that remain installed in vehicles or equipment the field. Field-test procedures apply to your engines only as specified in the standard-setting part.

(b) \* \* \*

(3) Do not use PEMS for laboratory measurements if it prevents you from demonstrating compliance with the applicable standards in this chapter. Some of the PEMS requirements in this part 1065 are less stringent than the corresponding laboratory requirements. Depending on actual PEMS performance, you might therefore need to account for some additional measurement uncertainty when using PEMS for laboratory testing. If we ask, you must show us by engineering analysis that any additional measurement uncertainty due to your use of PEMS for laboratory testing is offset by the extent to which your engine's emissions are below the applicable standards in this chapter. For example, you might show that PEMS versus laboratory uncertainty represents 5% of the standard, but your engine's deteriorated emissions are at least 20% below the standard for each pollutant.

■ 239. Amend § 1065.910 by revising paragraphs (b) and (d)(2) to read as follows:

**§ 1065.910 PEMS auxiliary equipment for field testing.**

\* \* \* \* \*

(b) Locate the PEMS to minimize the effects of the following parameters or place the PEMS in an environmental enclosure that minimizes the effect of these parameters on the emission measurement:

- (1) Ambient temperature changes.
- (2) Electromagnetic radiation.
- (3) Mechanical shock and vibration.

\* \* \* \* \*

(d) \* \* \*

(2) You may install your own portable power supply. For example, you may use batteries, fuel cells, a portable generator, or any other power supply to supplement or replace your use of vehicle power. You may connect an external power source directly to the vehicle's, vessel's, or equipment's power system; however, you must not supply power to the vehicle's power system in excess of 1% of the engine's maximum power.

■ 240. Amend § 1065.915 by revising paragraph (d)(6) to read as follows:

**§ 1065.915 PEMS instruments.**

\* \* \* \* \*

(d) \* \* \*  
 (6) *Permissible deviations.* ECM signals may deviate from the specifications of this part 1065, but the expected deviation must not prevent you from demonstrating that you meet the applicable standards in this chapter. For example, your emission results may be sufficiently below an applicable standard, such that the deviation would not significantly change the result. As another example, a very low engine-coolant temperature may define a logical statement that determines when a test interval may start. In this case, even if the ECM's sensor for detecting coolant temperature was not very accurate or repeatable, its output would never deviate so far as to significantly affect when a test interval may start.

■ 241. Amend § 1065.920 by:  
 ■ a. Revising paragraphs (b)(2), (b)(4) introductory text, and (b)(4)(iii).  
 ■ b. Removing paragraph (b)(5).  
 ■ c. Redesignating paragraphs (b)(6) and (7) as (b)(5) and (6), respectively.

■ d. Revising newly redesignated paragraph (b)(6)(ii).

The revisions read as follows:

§ 1065.920 PEMS calibrations and verifications.

\* \* \* \* \*

(b) \* \* \*

(2) Select or create a duty cycle that has all the following characteristics:

(i) Engine operation that represents normal in-use speeds, loads, and degree of transient activity. Consider using data from previous field tests to generate a cycle.

(ii) A duration of (6 to 9) hours.

\* \* \* \* \*

(4) Determine the brake-specific emissions and mass rate emissions, as applicable, for each test interval for both laboratory and the PEMS measurements, as follows:

\* \* \* \* \*

(iii) If the standard-setting part specifies the use of a measurement allowance for field testing, also apply the measurement allowance during calibration using good engineering judgment. If the measurement allowance is normally added to the standard, this means you must subtract the measurement allowance from measured PEMS emission results.

\* \* \* \* \*

(6) \* \* \*

(ii) The entire set of test-interval results passes the 95% confidence alternate-procedure statistics for field testing (t-test and F-test) specified in § 1065.12.

■ 242. Amend § 1065.935 by revising paragraphs (d)(4) and (g) to read as follows:

§ 1065.935 Emission test sequence for field testing.

\* \* \* \* \*

(d) \* \* \*

(4) Conduct periodic verifications such as zero and span verifications on PEMS gas analyzers and use these to correct for drift according to paragraph (g) of this section. Do not include data recorded during verifications in emission calculations. Conduct the verifications as follows:

(i) For PEMS gas analyzers used to determine NTE emission values, perform verifications as recommended by the PEMS manufacturer or as indicated by good engineering judgment.

(ii) For PEMS gas analyzers used to determine bin emission values, perform zero verifications at least hourly using purified air. Perform span verification at the end of the shift-day or more frequently as recommended by the

PEMS manufacturer or as indicated by good engineering judgment.

\* \* \* \* \*

(g) Take the following steps after emission sampling is complete:

(1) As soon as practical after emission sampling, analyze any gaseous batch samples.

(2) If you used dilution air, either analyze background samples or assume that background emissions were zero. Refer to § 1065.140 for dilution-air specifications.

(3) After quantifying all exhaust gases, record mean analyzer values after stabilizing a zero gas to each analyzer, then record mean analyzer values after stabilizing the span gas to the analyzer. Stabilization may include time to purge an analyzer of any sample gas and any additional time to account for analyzer response. Use these recorded values, including pre-test verifications and any zero verifications during testing, to correct for drift as described in § 1065.550.

(4) Verify PEMS gas analyzers used to determine NTE emission values as follows:

(i) Invalidate any data that does not meet the range criteria in § 1065.550. Note that it is acceptable that analyzers exceed 100% of their ranges when measuring emissions between test intervals, but not during test intervals. You do not have to retest an engine if the range criteria are not met.

(ii) Invalidate any data that does not meet the drift criterion in § 1065.550. For HC, invalidate any data if the difference between the uncorrected and the corrected brake-specific HC emission values are within ±10% of the uncorrected results or the applicable standard, whichever is greater. For data that does meet the drift criterion, correct those test intervals for drift according to § 1065.672 and use the drift corrected results in emissions calculations.

(5) Verify PEMS gas analyzers used to determine bin emission values as follows:

(i) Invalidate data from a whole shift-day if more than 1% of recorded 1 Hz data exceeds 100% of the selected gas analyzer range. For analyzer outputs exceeding 100% of range, calculate emission results using the reported value. You must retest an engine if the range criteria are not met.

(ii) Invalidate any data for periods in which the CO, CO<sub>2</sub>, and HC gas analyzers do not meet the drift criterion in § 1065.550. For HC, invalidate data if the difference between the uncorrected and the corrected brake-specific HC emission values are within ±10% of the uncorrected results or the applicable

standard, whichever is greater. For data that do meet the drift criterion, correct that data for drift according to § 1065.672 and use the drift corrected results in emissions calculations.

(iii) For PEMS NO<sub>x</sub> analyzers used to determine bin emission values, use the following drift limits to verify drift instead of meeting the drift criteria specified in § 1065.550:

(A) The allowable analyzer zero-drift between successive zero verifications is ±2.5 ppm. The analyzer zero-drift limit over the shift-day is ±10 ppm.

(B) The allowable analyzer span-drift limit is ±4% of the measured span value between successive span verifications.

(6) Unless you weighed PM in-situ, such as by using an inertial PM balance, place any used PM samples into covered or sealed containers and return them to the PM-stabilization environment and weigh them as described in § 1065.595.

■ 243. Amend § 1065.1001 by:

■ a. Removing the definition for “Designated Compliance Officer”.

■ b. Adding definitions for “Dual-fuel”, “EPA Program Officer”, and “Flexible-fuel” in alphabetical order.

■ c. Removing the definition for “Intermediate test speed”.

■ d. Adding a definition for “Intermediate speed” in alphabetical order.

■ e. Revising the definition for “NIST-traceable”.

■ f. Adding definitions for “No-load” and “Rechargeable Energy Storage System (RESS)” in alphabetical order.

■ g. Revising the definition for “Steady-state”.

The additions and revisions read as follows:

§ 1065.1001 Definitions.

\* \* \* \* \*

*Dual-fuel* has the meaning given in the standard-setting part.

\* \* \* \* \*

*EPA Program Officer* means the Director, Compliance Division, U.S. Environmental Protection Agency, 2000 Traverwood Dr., Ann Arbor, MI 48105.

\* \* \* \* \*

*Flexible-fuel* has the meaning given in the standard-setting part.

\* \* \* \* \*

*Intermediate speed* has the meaning given in § 1065.610.

\* \* \* \* \*

*NIST-traceable* means relating to a standard value that can be related to NIST-stated references through an unbroken chain of comparisons, all having stated uncertainties, as specified in NIST Technical Note 1297 (incorporated by reference in § 1065.1010). Allowable uncertainty

limits specified for NIST-traceability refer to the propagated uncertainty specified by NIST.

\* \* \* \* \*

*No-load* means a dynamometer setting of zero torque.

\* \* \* \* \*

*Rechargeable Energy Storage System (RESS)* means the components of a hybrid engine or vehicle that store recovered energy for later use, such as

the battery system in a hybrid electric vehicle.

\* \* \* \* \*

*Steady-state* means relating to emission tests in which engine speed and load are held at a finite set of nominally constant values. Steady-state tests are generally either discrete-mode tests or ramped-modal tests.

\* \* \* \* \*

■ 244. Amend § 1065.1005 by adding a row in Table 1 of paragraph (a) for “κ” in alphanumeric order and revising paragraphs (b), and (f)(1), (3), and (4) to read as follows:

**§ 1065.1005 Symbols, abbreviations, acronyms, and units of measure.**

\* \* \* \* \*

(a) \* \* \*

TABLE 1 OF § 1065.1005—SYMBOLS FOR QUANTITIES

Symbol	Quantity	Unit	Unit symbol	Units in terms of SI base units
κ	opacity.			

\* \* \* \* \*

(b) *Symbols for chemical species.* This part uses the following symbols for

chemical species and exhaust constituents:

TABLE 2 OF § 1065.1005—SYMBOLS FOR CHEMICAL SPECIES AND EXHAUST CONSTITUENTS

Symbol	Species
Ar	argon.
C	carbon.
CH <sub>2</sub> O	formaldehyde.
CH <sub>2</sub> O <sub>2</sub>	formic acid.
CH <sub>3</sub> OH	methanol.
CH <sub>4</sub>	methane.
C <sub>2</sub> H <sub>4</sub> O	acetaldehyde.
C <sub>2</sub> H <sub>5</sub> OH	ethanol.
C <sub>2</sub> H <sub>6</sub>	ethane.
C <sub>3</sub> H <sub>7</sub> OH	propanol.
C <sub>3</sub> H <sub>8</sub>	propane.
C <sub>4</sub> H <sub>10</sub>	butane.
C <sub>5</sub> H <sub>12</sub>	pentane.
CO	carbon monoxide.
CO <sub>2</sub>	carbon dioxide.
H	atomic hydrogen.
H <sub>2</sub>	molecular hydrogen.
H <sub>2</sub> O	water.
H <sub>2</sub> SO <sub>4</sub>	sulfuric acid.
HC	hydrocarbon.
He	helium.
<sup>85</sup> Kr	krypton 85.
N <sub>2</sub>	molecular nitrogen.
NH <sub>3</sub>	ammonia.
NMHC	nonmethane hydrocarbon.
NMHCE	nonmethane hydrocarbon equivalent.
NMNEHC	nonmethane-nonethane hydrocarbon.
NO	nitric oxide.
NO <sub>2</sub>	nitrogen dioxide.
NO <sub>x</sub>	oxides of nitrogen.
N <sub>2</sub> O	nitrous oxide.
NMOG	nonmethane organic gases.
NONMHC	non-oxygenated nonmethane hydrocarbon.
NOTHC	non-oxygenated total hydrocarbon.
O <sub>2</sub>	molecular oxygen.
OHC	oxygenated hydrocarbon.
<sup>210</sup> Po	polonium 210.
PM	particulate matter.
S	sulfur.
SVOC	semi-volatile organic compound.
THC	total hydrocarbon.
THCE	total hydrocarbon equivalent.



TABLE 2 OF § 1065.1005—SYMBOLS FOR CHEMICAL SPECIES AND EXHAUST CONSTITUENTS—Continued

Symbol	Species
ZrO <sub>2</sub> .....	zirconium dioxide.

\* \* \* \* \*  
(f) \* \* \*

(1) This part uses the following constants for the composition of dry air:

TABLE 6 OF § 1065.1005—CONSTANTS

Symbol	Quantity	mol/mol
χ <sub>Air</sub> .....	amount of argon in dry air .....	0.00934
χ <sub>CO<sub>2</sub>air</sub> .....	amount of carbon dioxide in dry air .....	0.000375
χ <sub>N<sub>2</sub>air</sub> .....	amount of nitrogen in dry air .....	0.78084
χ <sub>O<sub>2</sub>air</sub> .....	amount of oxygen in dry air .....	0.209445

\* \* \* \* \*

(3) This part uses the following molar gas constant for ideal gases:

TABLE 8 OF § 1065.1005—MOLAR GAS CONSTANT FOR IDEAL GASES

Symbol	Quantity	J/(-K) (m <sup>2</sup> ·kg·s <sup>-2</sup> ·mol <sup>-1</sup> ·K <sup>-1</sup> )
R .....	molar gas constant .....	8.314472

(4) This part uses the following ratios of specific heats for dilution air and diluted exhaust:

TABLE 9 OF § 1065.1005—RATIOS OF SPECIFIC HEATS FOR DILUTION AIR AND DILUTED EXHAUST

Symbol	Quantity	[J/(kg·K)]/[J/(kg·K)]
γ <sub>air</sub> .....	ratio of specific heats for intake air or dilution air .....	1.399
γ <sub>dil</sub> .....	ratio of specific heats for diluted exhaust .....	1.399
γ <sub>exh</sub> .....	ratio of specific heats for raw exhaust .....	1.385

\* \* \* \* \*

■ 245. Amend subpart L by adding a new center header “VANADIUM SUBLIMATION IN SCR CATALYSTS” after § 1065.1111 and adding §§ 1065.1113, 1065.1115, 1065.1117, 1065.1119, and 1065.1121 under the new center header to read as follows:

**Vanadium Sublimation in SCR Catalysts**

**§ 1065.1113 General provisions related to vanadium sublimation temperatures in SCR catalysts.**

Sections 1065.1113 through 1065.1121 specify procedures for determining vanadium emissions from a catalyst based on catalyst temperature. Vanadium can be emitted from the surface of SCR catalysts at temperatures above 550 °C, dependent on the catalyst formulation. These procedures are appropriate for measuring the vanadium sublimation product from a reactor by sampling onto an equivalent mass of alumina and performing analysis by

Inductively Coupled Plasma—Optical Emission Spectroscopy (ICP—OES). Follow standard analytic chemistry methods for any aspects of the analysis that are not specified.

(a) The procedure is adapted from “Behavior of Titania-supported Vanadia and Tungsta SCR Catalysts at High Temperatures in Reactant Streams: Tungsten and Vanadium Oxide and Hydroxide Vapor Pressure Reduction by Surficial Stabilization” (Chapman, D.M., Applied Catalysis A: General, 2011, 392, 143–150) with modifications to the acid digestion method from “Measuring the trace elemental composition of size-resolved airborne particles” (Herner, J.D. *et al.*, Environmental Science and Technology, 2006, 40, 1925–1933).

(b) Laboratory cleanliness is especially important throughout vanadium testing. Thoroughly clean all sampling system components and glassware before testing to avoid sample contamination.

**§ 1065.1115 Reactor design and setup.**

Vanadium measurements rely on a reactor that adsorbs sublimation vapors of vanadium onto an alumina capture bed with high surface area.

(a) Configure the reactor with the alumina capture bed downstream of the catalyst in the reactor’s hot zone to adsorb vanadium vapors at high temperature. You may use quartz beads upstream of the catalyst to help stabilize reactor gas temperatures. Select an alumina material and design the reactor to minimize sintering of the alumina. For a 1-inch diameter reactor, use 4 to 5 g of 1/8 inch extrudates or –14/+24 mesh (approximately 0.7 to 1.4 mm) gamma alumina (such as Alfa Aesar, aluminum oxide, gamma, catalyst support, high surface area, bimodal). Position the alumina downstream from either an equivalent amount of –14/+24 mesh catalyst sample or an approximately 1-inch diameter by 1 to 3-inch long catalyst-coated monolith sample cored from the production-

intent vanadium catalyst substrate. Separate the alumina from the catalyst with a 0.2 to 0.4 g plug of quartz wool. Place a short 4 g plug of quartz wool downstream of the alumina to maintain the position of that bed. Use good engineering judgment to adjust as appropriate for reactors of different sizes.

(b) Include the quartz wool with the capture bed to measure vanadium content. We recommend analyzing the

downstream quartz wool separately from the alumina to see if the alumina fails to capture some residual vanadium.

(c) Configure the reactor such that both the sample and capture beds are in the reactor's hot zone. Design the reactor to maintain similar temperatures in the capture bed and catalyst. Monitor the catalyst and alumina temperatures with Type K thermocouples inserted into a thermocouple well that is in contact with the catalyst sample bed.

(d) If there is a risk that the quartz wool and capture bed are not able to collect all the vanadium, configure the reactor with an additional capture bed and quartz wool plug just outside the hot zone and analyze the additional capture bed and quartz wool separately.

(e) An example of a catalyst-coated monolith and capture bed arrangement in the reactor tube are shown in the following figure:

Figure 1 to paragraph (e) of § 1065.1115— Example of reactor setup

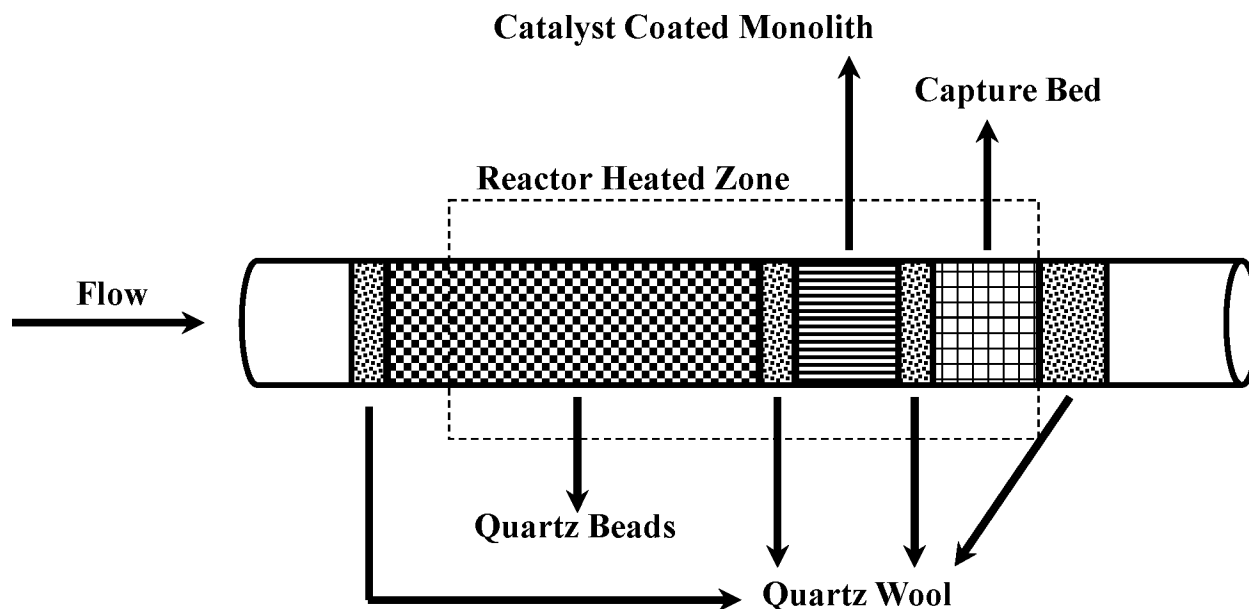

(f) You may need to account for vanadium-loaded particles contaminating catalyst-coated monoliths as a result of physical abrasion. To do this, determine how much titanium is in the capture bed and compare to an alumina blank. Using these values and available information about the ratio of vanadium to titanium in the catalyst, subtract the mass of vanadium catalyst material associated with the catalyst particles from the total measured vanadium on the capture bed to determine the vanadium recovered due to sublimation.

**§ 1065.1117 Reactor aging cycle for determination of vanadium sublimation temperature.**

This section describes the conditions and process required to operate the reactor described in § 1065.1115 for collection of the vanadium sublimation samples for determination of vanadium sublimation temperature. The reactor aging cycle constitutes the process of testing the catalyst sample over all the test conditions described in paragraph (b) of this section.

(a) Set up the reactor to flow gases with a space velocity of at least 35,000/hr with a pressure drop across the catalyst and capture beds less than 35 kPa. Use test gases meeting the following specifications, noting that not all gases will be used at the same time:

- (1) 5 vol% O<sub>2</sub>, balance N<sub>2</sub>.
  - (2) NO, balance N<sub>2</sub>. Use an NO concentration of (200 to 500) ppm.
  - (3) NH<sub>3</sub>, balance N<sub>2</sub>. Use an NH<sub>3</sub> concentration of (200 to 500) ppm.
- (b) Perform testing as follows:
- (1) Add a new catalyst sample and capture bed into the reactor as described in § 1065.1113. Heat the reactor to 550 °C while flowing the oxygen blend specified in paragraph (a)(1) of this section as a pretest gas mixture. Ensure that no H<sub>2</sub>O is added to the pretest gas mixture to reduce the risk of sintering and vanadium sublimation.

(2) Start testing at a temperature that is lower than the point at which vanadium starts to sublime. Start testing when the reactor reaches 550 °C unless testing supports a lower starting temperature. Once the reactor reaches the starting temperature and the catalyst

has been equilibrated to the reactor temperature, flow NO, and NH<sub>3</sub> test gases for 18 hours with a nominal H<sub>2</sub>O content of 5 volume percent.

(3) After 18 hours of exposure, flow the pretest oxygen blend as specified in paragraph (b)(1) of this section and allow the reactor to cool down to room temperature.

(4) Analyze the sample as described in § 1065.1121.

(5) Repeat the testing in paragraphs (b)(1) through (4) of this section by raising the reactor temperature in increments of 50 °C up to the temperature at which vanadium sublimation begins.

(6) Once sublimation has been detected, repeat the testing in paragraphs (b)(1) through (4) of this section by decreasing the reactor temperature in increments of 25 °C until the vanadium concentration falls below the sublimation threshold.

(7) Repeat the testing in paragraphs (b)(1) through (6) of this section with a nominal H<sub>2</sub>O concentration of 10 volume percent or the maximum water concentration expected at the standard.

(8) You may optionally test in a manner other than testing a single catalyst formulation in series across all test temperatures. For example, you may test additional samples at the same reactor temperature before moving on to the next temperature.

(c) The effective sublimation temperature for the tested catalyst is the lowest reactor temperature determined in paragraph (b) of this section below which vanadium emissions are less than the method detection limit.

#### § 1065.1119 Blank testing.

This section describes the process for analyzing blanks. Use blanks to determine the background effects and the potential for contamination from the sampling process.

(a) Take blanks from the same batch of alumina used for the capture bed.

(b) Media blanks are used to determine if there is any contamination in the sample media. Analyze at least one media blank for each reactor aging cycle or round of testing performed under § 1065.1117. If your sample media is taken from the same lot, you may analyze media blanks less frequently consistent with good engineering judgment.

(c) Field blanks are used to determine if there is any contamination from environmental exposure of the sample media. Analyze at least one field blank for each reactor aging cycle or round of testing performed under § 1065.1117. Field blanks must be contained in a sealed environment and accompany the reactor sampling system throughout the course of a test, including reactor disassembly, sample packaging, and storage. Use good engineering judgment to determine how frequently to generate field blanks. Keep the field blank sample close to the reactor during testing.

(d) Reactor blanks are used to determine if there is any contamination from the sampling system. Analyze at least one reactor blank for each reactor aging cycle or round of testing performed under § 1065.1117.

(1) Test reactor blanks with the reactor on and operated identically to that of a catalyst test in § 1065.1117 with the exception that when loading the reactor, only the alumina capture bed will be loaded (no catalyst sample is loaded for the reactor blank). We recommend acquiring reactor blanks with the reactor operating at average test temperature you used when acquiring your test samples under § 1065.1117.

(2) You must run at least three reactor blanks if the result from the initial blank analysis is above the detection limit of the method, with additional blank runs

based on the uncertainty of the reactor blank measurements, consistent with good engineering judgment.

#### § 1065.1121 Vanadium sample dissolution and analysis in alumina capture beds.

This section describes the process for dissolution of vanadium from the vanadium sublimation samples collect in § 1065.1117 and any blanks collected in § 1065.1119 as well as the analysis of the digestates to determine the mass of vanadium emitted and the associated sublimation temperature threshold based on the results of all the samples taken during the reactor aging cycle.

(a) Digest the samples using the following procedure, or an equivalent procedure:

(1) Place the recovered alumina, a portion of the ground quartz tube from the reactor, and the quartz wool in a Teflon pressure vessel with a mixture made from 1.5 mL of 16 N HNO<sub>3</sub>, 0.5 mL of 28 N HF, and 0.2 mL of 12 N HCl. Note that the amount of ground quartz tube from the reactor included in the digestion can influence the vanadium concentration of both the volatilized vanadium from the sample and the method detection limit. You must be consistent with the amount ground quartz tube included in the sample analysis for your testing. You must limit the amount of quartz tube to include only portions of the tube that would be likely to encounter volatilized vanadium.

(2) Program a microwave oven to heat the sample to 180 °C over 9 minutes, followed by a 10-minute hold at that temperature, and 1 hour of ventilation/cooling.

(3) After cooling, dilute the digests to 30 mL with high purity 18MΩ water prior to ICP-MS (or ICP-OES) analysis. Note that this digestion technique requires adequate safety measures when working with HF at high temperature and pressure. To avoid “carry-over” contamination, rigorously clean the vessels between samples as described in “Microwave digestion procedures for environmental matrixes” (Lough, G.C. *et al.*, *Analyst*. 1998, 123 (7), 103R–133R).

(b) Analyze the digestates for vanadium as follows:

(1) Perform the analysis using ICP-OES (or ICP-MS) using standard plasma conditions (1350 W forward power) and a desolvating microconcentric nebulizer, which will significantly reduce oxide- and chloride-based interferences.

(2) We recommend that you digest and analyze a minimum of three solid vanadium NIST Standard Reference Materials in duplicate with every batch of 25 vanadium alumina capture bed

samples that you analyze in this section, as described in “Emissions of metals associated with motor vehicle roadways” (Herner, J.D. *et al.*, *Environmental Science and Technology*. 2005, 39, 826–836). This will serve as a quality assurance check to help gauge the relative uncertainties in each measurement, specifically if the measurement errors are normally distributed and independent.

(3) Use the 3-sigma approach to determine the analytical method detection limits for vanadium and the 10-sigma approach if you determine the reporting limit. This process involves analyzing at least seven replicates of a blank using the analytical method described in paragraphs (a) and (b)(1) of this section, converting the responses into concentration units, and calculating the standard deviation. Determine the detection limit by multiplying the standard deviation by 3 and adding it to the average. Determine the reporting limit by multiplying the standard deviation by 10 and adding it to the average. Determine the following analytical method detection limits:

(i) Determine the ICP-MS (or ICP-OES) instrumental detection limit (ng/L) by measuring at least seven blank samples made up of the reagents from paragraph (a) of this section.

(ii) Determine the method detection limit (pg/m<sup>3</sup> of flow or pg/g of the total combined mass of the recovered alumina, a portion of the ground quartz tube from the reactor, and the quartz wool) by measuring at least seven reactor blank samples taken as described in § 1065.1119(d).

(iii) We recommend that your method detection limit determined under paragraph (b)(3)(ii) of this section is at or below 2 ppm (2 pg/m<sup>3</sup>). You must report your detection limits determined in this paragraph (b)(3) and reporting limits (if determined) with your test results.

(4) If you account for vanadium-loaded particles contaminating catalyst-coated monoliths as a result of physical abrasion as allowed in § 1065.1115(f), use the 3-sigma approach to determine the analytical method detection limits for titanium and the 10-sigma approach if you determine the reporting limit. This process involves analyzing at least seven replicates of a blank using the analytical method described in paragraphs (a) and (b)(1) of this section, converting the responses into concentration units, and calculating the standard deviation. Determine the detection limit by multiplying the standard deviation by 3 and subtracting it from the average. Determine the reporting limit by multiplying the

standard deviation by 10 and subtracting it from the average.

(i) Determine the ICP-MS (or ICP-OES) instrumental detection limit (ng/L) by measuring at least seven blank samples made up of the reagents from paragraph (a) of this section.

(ii) Determine the method detection limit (pg/m<sup>3</sup> of flow or pg/g of the total combined mass of the recovered alumina, a portion of the ground quartz tube from the reactor, and the quartz wool) by measuring at least seven reactor blank samples taken as described in § 1065.1119(d).

■ 246. Amend subpart L by adding a new center header “SMOKE OPACITY” after the newly added § 1065.1121 and adding §§ 1065.1123, 1065.1125, and 1065.1127 under the new center header to read as follows:

#### Smoke Opacity

##### § 1065.1123 General provisions for determining exhaust opacity.

The provisions of § 1065.1125 describe system specifications for

measuring percent opacity of exhaust for all types of engines. The provisions of § 1065.1127 describe how to use such a system to determine percent opacity of engine exhaust for applications other than locomotives. See 40 CFR 1033.525 for measurement procedures for locomotives.

##### § 1065.1125 Exhaust opacity measurement system.

Smokemeters measure exhaust opacity using full-flow open-path light extinction with a built-in light beam across the exhaust stack or plume. Prepare and install a smokemeter system as follows:

(a) Except as specified in paragraph (d) of this section, use a smokemeter capable of providing continuous measurement that meets the following specifications:

(1) Use an incandescent lamp with a color temperature between (2800 and 3250) K or a different light source with a spectral peak between (550 and 570) nm.

(2) Collimate the light beam to a nominal diameter of 3 centimeters and maximum divergence angle of 6 degrees.

(3) Include a photocell or photodiode as a detector. The detector must have a maximum spectral response between (550 and 570) nm, with less than 4 percent of that maximum response below 430 nm and above 680 nm. These specifications correspond to visual perception with the human eye.

(4) Use a collimating tube with an aperture that matches the diameter of the light beam. Restrict the detector to viewing within a 16 degree included angle.

(5) Optionally use an air curtain across the light source and detector window to minimize deposition of smoke particles, as long as it does not measurably affect the opacity of the sample.

(6) The diagram in the following figure illustrates the smokemeter configuration:

Figure 1 to paragraph (a) of § 1065.1125— Smokemeter Diagram.

Figure 1 to paragraph (a) of § 1065.1125— Smokemeter Diagram.

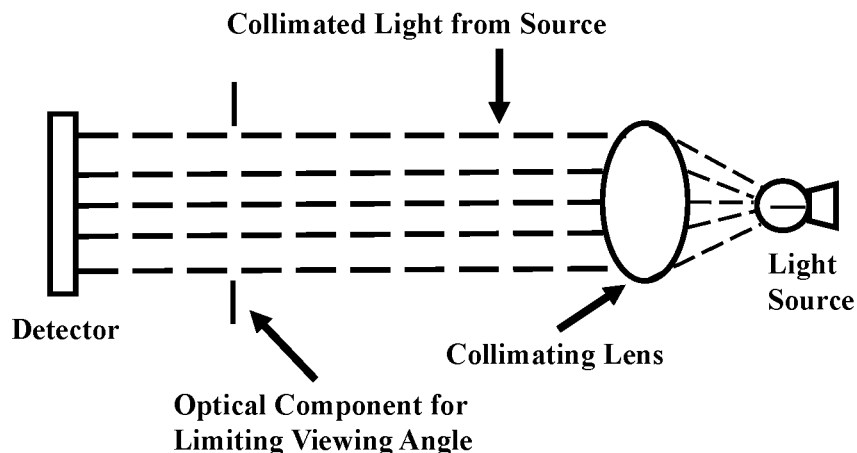

(b) Smokemeters for locomotive applications must have a full-scale response time of 0.5 seconds or less. Smokemeters for locomotive applications may attenuate signal responses with frequencies higher than 10 Hz with a separate low-pass electronic filter that has the following performance characteristics:

(1) *Three decibel point:* 10 Hz.

(2) *Insertion loss:* (0.0±0.5) dB.

(3) *Selectivity:* 12 dB down at 40 Hz minimum.

(4) *Attenuation:* 27 dB down at 40 Hz minimum.

(c) Configure exhaust systems as follows for measuring exhaust opacity:

(1) For locomotive applications:

(i) Optionally add a stack extension to the locomotive muffler.

(ii) For in-line measurements, the smokemeter is integral to the stack extension.

(iii) For end-of-line measurements, mount the smokemeter directly at the end of the stack extension or muffler.

(iv) For all testing, minimize distance from the optical centerline to the muffler outlet; in no case may it be more than 300 cm. The maximum allowable distance of unducted space upstream of the optical centerline is 50 cm, whether the unducted portion is upstream or downstream of the stack extensions.

(2) Meet the following specifications for all other applications:

(i) For in-line measurements, install the smokemeter in an exhaust pipe segment downstream of all engine components. This will typically be part of a laboratory configuration to route the exhaust to an analyzer. The exhaust pipe diameter must be constant within 3 exhaust pipe diameters before and after the smokemeter's optical centerline. The exhaust pipe diameter may not change by more than a 12-degree half-angle within 6 exhaust pipe diameters upstream of the smokemeter's optical centerline.

(ii) For end-of-line measurements with systems that vent exhaust to the ambient, add a stack extension and position the smokemeter such that its optical centerline is (2.5±0.625) cm

upstream of the stack extension's exit. Configure the exhaust stack and extension such that at least the last 60 cm is a straight pipe with a circular cross section with an approximate inside diameter as specified in the following table:

TABLE 1 TO PARAGRAPH (c)(2)(ii) OF § 1065.1125—APPROXIMATE EXHAUST PIPE DIAMETER BASED ON ENGINE POWER

Maximum rated horsepower	Approximate exhaust pipe diameter (mm)
kW<40 .....	38
40≤kW<75 .....	50
75≤kW<150 .....	76
150≤kW<225 .....	102
225≤kW<375 .....	127
kW≤ 375 .....	152

(iii) For both in-line and end-of-line measurements, install the smokemeter so its optical centerline is (3 to 10) meters further downstream than the point in the exhaust stream that is farthest downstream considering all the following components: Exhaust manifolds, turbocharger outlets, exhaust aftertreatment devices, and junction points for combining exhaust flow from multiple exhaust manifolds.

(3) Orient the light beam perpendicular to the direction of exhaust flow. Install the smokemeter so it does not influence exhaust flow distribution or the shape of the exhaust plume. Set up the smokemeter's optical path length as follows:

(i) For locomotive applications, the optical path length must be at least as wide as the exhaust plume.  
 (ii) For all other applications, the optical path length must be the same as the diameter of the exhaust flow. For noncircular exhaust configurations, set up the smokemeter such that the light beam's path length is across the longest axis with an optical path length equal to the hydraulic diameter of the exhaust flow.

(4) The smokemeter must not interfere with the engine's ability to meet the exhaust backpressure requirements in § 1065.130(h).

(5) For engines with multiple exhaust outlets, measure opacity using one of the following methods:

(i) Join the exhaust outlets together to form a single flow path and install the smokemeter (3 to 10) m downstream of the point where the exhaust streams converge or the last exhaust aftertreatment device, whichever is farthest downstream.

(ii) Install a smokemeter in each of the exhaust flow paths. Report all measured values. All measured values must comply with standards.

(6) The smokemeter may use purge air or a different method to prevent carbon or other exhaust deposits on the light source and detector. Such a method used with end-of-line measurements may not cause the smoke plume to change by more than 0.5 cm at the smokemeter. If such a method affects the smokemeter's optical path length, follow the smokemeter manufacturer's instructions to properly account for that effect.

(d) You may use smokemeters meeting alternative specifications as follows:

(1) You may use smokemeters that use other electronic or optical techniques if they employ substantially identical measurement principles and produce substantially equivalent results.

(2) You may ask us to approve the use of a smokemeter that relies on partial flow sampling. Follow the instrument manufacturer's installation, calibration, operation, and maintenance procedures if we approve your request. These procedures must include correcting for any change in the path length of the exhaust plume relative to the diameter of the engine's exhaust outlet.

**§ 1065.1127 Test procedure for determining percent opacity.**

The test procedure described in this section applies for everything other than locomotives. The test consists of a sequence of engine operating points on an engine dynamometer to measure exhaust opacity during specific engine operating modes to represent in-use operation. Measure opacity using the following procedure:

(a) Use the equipment and procedures specified in this part 1065.

(b) Calibrate the smokemeter as follows:

(1) Calibrate using neutral density filters with approximately 10, 20, and 40 percent opacity. Confirm that the opacity values for each of these reference filters are NIST-traceable within 185 days of testing, or within 370 days of testing if you consistently protect the reference filters from light exposure between tests.

(2) Before each test and optionally during engine idle modes, remove the smokemeter from the exhaust stream, if applicable, and calibrate as follows:

(i) *Zero.* Adjust the smokemeter to give a zero response when there is no detectable smoke.

(ii) *Linearity.* Insert each of the qualified reference filters in the light path perpendicular to the axis of the

light beam and adjust the smokemeter to give a result within 1 percentage point of the named value for each reference filter.

(c) Prepare the engine, dynamometer, and smokemeter for testing as follows:

(1) Set up the engine to run in a configuration that represents in-use operation.

(2) Determine the smokemeter's optical path length to the nearest mm.

(3) If the smokemeter uses purge air or another method to prevent deposits on the light source and detector, adjust the system according to the system manufacturer's instructions and activate the system before starting the engine.

(4) Program the dynamometer to operate in torque-control mode throughout testing. Determine the dynamometer load needed to meet the cycle requirements in paragraphs (d)(4)(ii) and (iv) of this section.

(5) You may program the dynamometer to apply motoring assist with negative flywheel torque, but only during the first 0.5 seconds of the acceleration events in paragraphs (d)(4)(i) and (ii) of this section. Negative flywheel torque may not exceed 13.6 N · m.

(d) Operate the engine and dynamometer over repeated test runs of the duty cycle illustrated in Figure 1 of this appendix. As noted in the figure, the test run includes an acceleration mode from points A through F in the figure, followed by a lugging mode from points I to J. Detailed specifications for testing apply as follows:

(1) Continuously record opacity, engine speed, engine torque, and operator demand over the course of the entire test at 10 Hz; however, you may interrupt measurements to recalibrate during each idle mode.

(2) Precondition the engine by operating it for 10 minutes at maximum mapped power.

(3) Operate the engine for (5.0 to 5.5) minutes at warm idle speed,  $f_{idle}$ , with load set to Curb Idle Transmission Torque.

(4) Operate the engine and dynamometer as follows during the acceleration mode:

(i) *First acceleration event—AB.* Partially increase and hold operator demand to stabilize engine speed briefly at  $(200 \pm 50)$  r/min above  $f_{idle}$ . The start of this acceleration is the start of the test ( $t = 0$  s).

(ii) *Second acceleration event—CD.* As soon as measured engine speed is within the range specified in paragraph (d)(4)(i) of this section, but not more than 3 seconds after the start of the test, rapidly set and hold operator demand at maximum. Operate the dynamometer

using a preselected load to accelerate engine speed to 85 percent of maximum test speed,  $f_{ntest}$ , in  $(5 \pm 1.5)$  seconds. The engine speed throughout the acceleration must be within  $\pm 100$  r/min of a target represented by a linear transition between the low and high engine speed targets.

(iii) *Transition—DEF.* As soon as measured engine speed reaches 85 percent of  $f_{ntest}$ , rapidly set and hold operator demand at minimum and simultaneously apply a load to decelerate to intermediate speed in  $(0.5$  to  $3.5)$  seconds. Use the same load identified for the acceleration event in paragraph (d)(4)(iv) of this section.

(iv) *Third acceleration event—FGH.* Rapidly set and hold operator demand at maximum when the engine is within  $\pm 50$  r/min of intermediate speed. Operate the dynamometer using a preselected load to accelerate engine speed to at least 95 percent of  $f_{ntest}$  in  $(10 \pm 2)$  seconds.

(5) Operate the engine and dynamometer as follows during the lugging mode:

(i) *Transition—HI.* When the engine reaches 95 percent of  $f_{ntest}$ , keep operator demand at maximum and immediately set dynamometer load to control the engine at maximum mapped power. Continue the transition segment for  $(50$  to  $60)$  seconds. For at least the last 10 seconds of the transition segment, hold engine speed within  $\pm 50$  r/min of  $f_{ntest}$  and power at or above 95 percent of maximum mapped power. Conclude the transition by increasing dynamometer load to reduce engine speed as specified

in paragraph (d)(4)(iii) of this section, keeping operator demand at maximum.

(ii) *Lugging—IJ.* Apply dynamometer loading as needed to decrease engine speed from 50 r/min below  $f_{ntest}$  to intermediate speed in  $(35 \pm 5)$  seconds. The engine speed must remain within  $\pm 100$  r/min of a target represented by a linear transition between the low and high engine speed targets.

(6) Return the dynamometer and engine controls to the idle position described in paragraph (d)(3) of this section within 60 seconds of completing the lugging mode.

(7) Repeat the procedures in paragraphs (d)(3) through (6) of this section as needed to complete three valid test runs. If you fail to meet the specifications during a test run, continue to follow the specified duty cycle before starting the next test run.

(8) Shut down the engine or remove the smokemeter from the exhaust stream to verify zero and linearity. Void the test if the smokemeter reports more than 2 percent opacity for the zero verification, or if the smokemeter's error for any of the linearity checks specified in paragraph (b)(2) of this section is more than 2 percent.

(e) Analyze and validate the test data as follows:

(1) Divide each test run into test segments. Each successive test segment starts when the preceding segment ends. Identify the test segments based on the following criteria:

(i) The idle mode specified in paragraph (d)(3) of this section for the first test run starts immediately after engine preconditioning is complete. The

idle mode for later test runs must start within 60 seconds after the end of the previous test run as specified in paragraph (d)(6) of this section. The idle mode ends when operator demand increases for the first acceleration event (Points A and B).

(ii) The first acceleration event in paragraph (d)(4)(i) of this section ends when operator demand is set to maximum for the second acceleration event (Point C).

(iii) The second acceleration event in paragraph (d)(4)(ii) of this section ends when the engine reaches 85 percent of maximum test speed,  $f_{ntest}$ , (Point D) and operator demand is set to minimum (Point E).

(iv) The transition period in paragraph (d)(4)(iii) of this section ends when operator demand is set to maximum (Point F).

(v) The third acceleration event in paragraph (d)(4)(iv) of this section ends when engine speed reaches 95 percent of  $f_{ntest}$  (Point H).

(vi) The transition period in paragraph (d)(5)(i) of this section ends when engine speed first decreases to a point more than 50 r/min below  $f_{ntest}$  (Point I).

(vii) The lugging mode in paragraph (d)(5)(ii) of this section ends when the engine reaches intermediate speed (Point J).

(2) Convert measured instantaneous values to standard opacity values,  $\kappa_{std}$ , based on the appropriate optical path length specified in Table 1 of § 1065.1125 using the following equation:

$$\kappa_{std} = 100 \cdot \left( 1 - \left( 1 - \frac{\kappa_{meas}}{100} \right)^{\frac{l_{std}}{l_{meas}}} \right)$$

Eq. 1065.1127-1

Where:

$\kappa_{std}$  = standard instantaneous percent opacity.

$\kappa_{meas}$  = measured instantaneous percent opacity.

$l_{std}$  = standard optical path length corresponding with engine power, in millimeters.

$l_{meas}$  = the smokemeter's optical path length, in millimeters.

Example for an engine <40 kW:

$\kappa_{meas} = 14.1\%$

$l_{std} = 38$  mm

$l_{meas} = 41$  mm

$$\kappa_{std} = 100 \cdot \left( 1 - \left( 1 - \frac{14.1}{100} \right)^{\frac{38}{41}} \right) = 13.1\%$$

(3) Select opacity results from corrected measurements collected across test segments as follows:

(i) Divide measurements from acceleration and lugging modes into

half-second intervals. Determine average opacity values during each half-second interval.

(ii) Identify the 15 highest half-second values during the acceleration mode of each test run.

(iii) Identify the five highest half-second values during the lugging mode of each test run.

(iv) Identify the three overall highest values from paragraphs (e)(3)(ii) and (iii) of this section for each test run.

(f) Determine percent opacity as follows:

(1) *Acceleration*. Determine the percent opacity for the acceleration mode by calculating the average of the 45 readings from paragraph (e)(3)(ii) of this section.

(2) *Lugging*. Determine the percent opacity for the lugging mode by calculating the average of the 15 readings from paragraph (e)(3)(iii) of this section.

(3) *Peak*. Determine the percent opacity for the peaks in either acceleration or lugging mode by calculating the average of the 9 readings from paragraph (e)(3)(iv) of this section.

(g) Submit the following information in addition to what is required by § 1065.695:

(1) Exhaust pipe diameter(s).

(2) Measured maximum exhaust system backpressure over the entire test.

(3) Most recent date for establishing that each of the reference filters from paragraph (b) of this section are NIST-traceable.

(4) Measured smokemeter zero and linearity values after testing.

(5) 10 Hz data from all valid test runs.

(h) The following figure illustrates the dynamometer controls and engine speeds for exhaust opacity testing:

**BILLING CODE 6560-50-P**

Figure 1 to paragraph (h) of § 1065.1127— Schematic of Smoke Opacity Duty Cycle

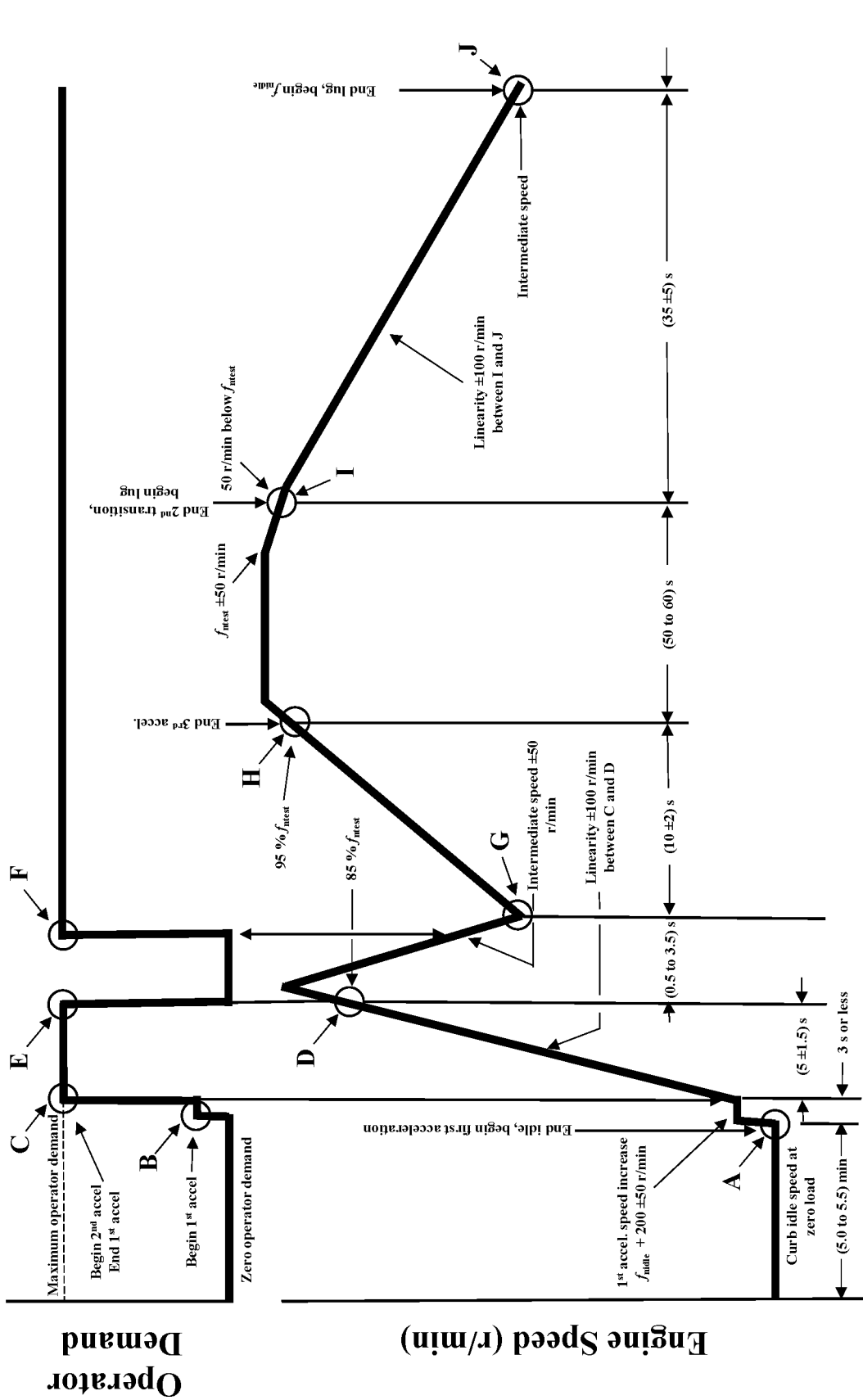

Time



BILLING CODE 6560-50-C

**PART 1066—VEHICLE-TESTING PROCEDURES**

■ 247. The authority citation for part 1066 continues to read as follows:

**Authority:** 42 U.S.C. 7401-7671q.

■ 248. Amend § 1066.110 by revising paragraphs (b)(2)(i) and (b)(2)(v) introductory text to read as follows:

**§ 1066.110 Equipment specifications for emission sampling systems.**

\* \* \* \* \*

(b) \* \* \*

(2) \* \* \*

(i) For PM background measurement, the following provisions apply in addition to the provisions in 40 CFR 1065.140(b):

\* \* \* \* \*

(v) If you choose to dilute the exhaust by using a remote mix tee, which dilutes the exhaust at the tailpipe, you may use the following provisions consistent with good engineering judgment, as long as they do not affect your ability to demonstrate compliance with the applicable standards in this chapter:

\* \* \* \* \*

■ 249. Amend § 1066.220 by revising paragraph (b) to read as follows:

**§ 1066.220 Linearity verification for chassis dynamometer systems.**

\* \* \* \* \*

(b) *Performance requirements.* If a measurement system does not meet the applicable linearity criteria in Table 1 of this section, correct the deficiency by recalibrating, servicing, or replacing components as needed. Repeat the linearity verification after correcting the deficiency to ensure that the measurement system meets the linearity

criteria. Before you may use a measurement system that does not meet linearity criteria, you must demonstrate to us that the deficiency does not adversely affect your ability to demonstrate compliance with the applicable standards in this chapter.

\* \* \* \* \*

■ 250. Amend § 1066.415 by revising paragraph (e)(2) to read as follows:

**§ 1066.415 Vehicle operation.**

\* \* \* \* \*

(e) \* \* \*

(2) If vehicles have features that preclude dynamometer testing, you may modify these features as necessary to allow testing, consistent with good engineering judgment, as long as it does not affect your ability to demonstrate that your vehicles comply with the applicable standards in this chapter. Send us written notification describing these changes along with supporting rationale.

\* \* \* \* \*

■ 251. Amend § 1066.420 by revising paragraph (b) to read as follows:

**§ 1066.420 Test preparation.**

\* \* \* \* \*

(b) Minimize the effect of nonmethane hydrocarbon contamination in the hydrocarbon sampling system as follows:

(1) For vehicles at or below 14,000 pounds GVWR with compression-ignition engines, account for contamination using one of the following methods:

(i) Introduce zero and span gas during analyzer calibration using one of the following methods, noting that the hydrocarbon analyzer flow rate and pressure during zero and span calibration (and background bag

reading) must be exactly the same as that used during testing to minimize measurement errors:

(A) Close off the hydrocarbon sampling system sample probe and introduce gases downstream of the probe making sure that you do not pressurize the system.

(B) Introduce zero and span gas directly at the hydrocarbon sampling system probe at a flow rate greater than 125% of the hydrocarbon analyzer flow rate allowing some gas to exit probe inlet.

(ii) Perform the contamination verification in paragraph (b)(2) of this section.

(2) For vehicles above 14,000 pounds GVWR with compression-ignition engines, verify the amount of nonmethane hydrocarbon contamination as described in 40 CFR 1065.520(f).

\* \* \* \* \*

■ 252. Amend § 1066.710 by revising the introductory text, removing Figure 1, and adding paragraph (f) to read as follows:

**§ 1066.710 Cold temperature testing procedures for measuring CO and NMHC emissions and determining fuel economy.**

This section describes procedures for measuring carbon monoxide (CO) and nonmethane hydrocarbon (NMHC) emissions and determining fuel economy on a cold day using the FTP test cycle (see § 1066.801).

\* \* \* \* \*

(f) The following figure illustrates the cold temperature testing sequence for measuring CO and NMHC emissions and determining fuel economy:

BILLING CODE 6560-50-P

Figure 1 to paragraph (f) of § 1066.710— Cold Temperature Testing Sequence for Measuring CO and NMHC Emissions and Determining Fuel Economy

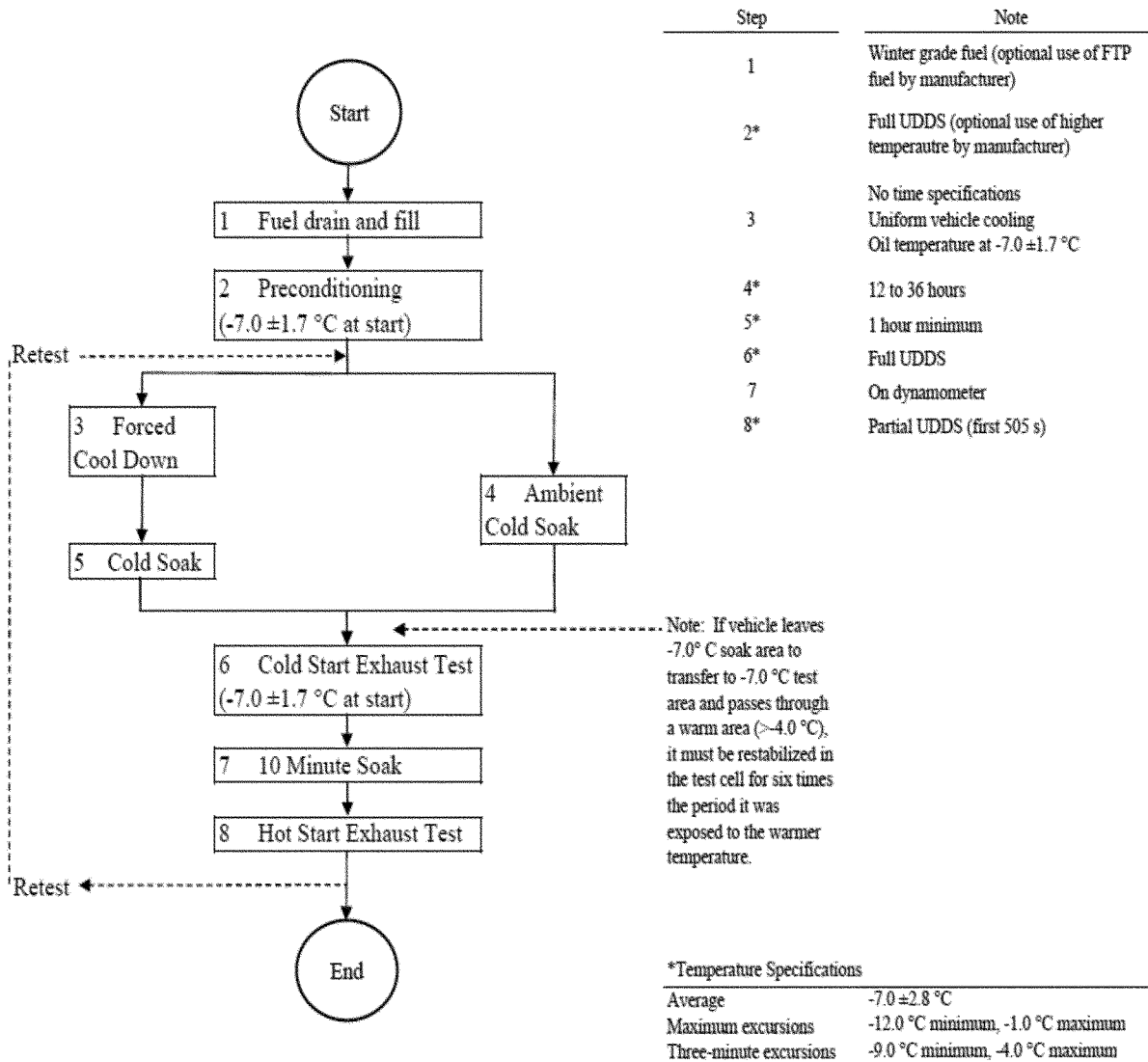

BILLING CODE 6560-50-C

■ 253. Amend § 1066.815 by revising paragraph (d)(1)(ii) to read as follows:

**§ 1066.815 Exhaust emission test procedures for FTP testing.**

\* \* \* \* \*

- (d) \* \* \*
- (1) \* \* \*

(ii) Simultaneously start any electronic integrating devices, continuous data recording, and batch sampling before attempting to start the engine. Initiate the sequence of points in the test cycle when the engine starts. Place the vehicle in gear 15 seconds after engine starting, which is 5 seconds before the first acceleration.

\* \* \* \* \*

■ 254. Amend § 1066.831 by revising paragraph (d) to read as follows:

**§ 1066.831 Exhaust emission test procedures for aggressive driving.**

\* \* \* \* \*

(d) For diesel-fueled vehicles, measure THC emissions on a continuous basis. For separate measurement of the city and highway test intervals as described in paragraph (c) of this section, perform separate calculations for each portion of the test cycle.

\* \* \* \* \*

■ 255. Amend § 1066.835 by revising paragraphs (f)(1), (2), and (3)(iii) to read as follows:

**§ 1066.835 Exhaust emission test procedure for SC03 emissions.**

\* \* \* \* \*

- (f) \* \* \*

(1) *Ambient temperature and humidity.* Measure and record ambient

temperature and humidity in the test cell at least once every 30 seconds during the sampling period. Alternatively, if you collect data of at least once every 12 seconds, you may use a moving average of up to 30 second intervals to measure and record ambient temperature and humidity. Control ambient temperature throughout the test sequence to  $(35.0 \pm 3.0) \text{ }^\circ\text{C}$ . Control ambient temperature during emission sampling to  $(33.6 \text{ to } 36.4) \text{ }^\circ\text{C}$  on average. Control ambient humidity during emission sampling as described in § 1066.420(d).

(2) *Conditions before testing.* Use good engineering judgment to demonstrate that you meet the specified temperature and humidity tolerances in paragraph (f)(1) of this section during the preconditioning cycle and during

the vehicle soak period in paragraph (c)(6) of this section.

(3) \* \* \*

(iii) Determine radiant energy intensity experienced by the vehicle as the average value between two measurements along the vehicle's centerline, one at the base of the windshield and the other at the bottom of the rear window (or equivalent location for vehicles without a rear window). This value must be (850 ±45) W/m2. Instruments for measuring radiant energy intensity must meet the following minimum specifications:

\* \* \* \* \*

■ 256. Amend § 1066.845 by revising paragraphs (c) and (f)(3) to read as follows:

§ 1066.845 AC17 air conditioning efficiency test procedure.

\* \* \* \* \*

(c) Ambient conditions. Measure and control ambient conditions as specified in § 1066.835(f), except that you must control ambient temperature during emission sampling to (22.0 to 28.0) °C throughout the test and (23.5 to 26.5) °C on average. These tolerances apply to the combined SC03 and HFET drive cycles during emission sampling. Note that you must set the same ambient temperature target for both the air conditioning on and off portions of emission sampling. Control ambient temperature during the preconditioning cycle and 30 minute soak to (25.0 ±5.0) °C. For these same modes with no emission sampling, target the specified

ambient humidity levels, but you do not need to meet the humidity tolerances. Note that solar heating is disabled for certain test intervals as described in this section.

\* \* \* \* \*

(f) \* \* \*

(3) Turn on solar heating within one minute after turning off the engine. Once the solar energy intensity reaches 805 W/m2, let the vehicle soak for (30 ±1) minutes. You may alternatively rely on prior measurements to start the soak period after a defined period of warming up to the specified solar heat load. Close the vehicle's windows at the start of the soak period; ensure that the windows are adequately closed where instrumentation and wiring pass through to the interior.

\* \* \* \* \*

■ 257. Amend § 1066.1001 by adding definitions for "Charge-depleting" and "Charge-sustaining" in alphabetical order and revising the definition for "Test interval" to read as follows:

§ 1066.1001 Definitions.

\* \* \* \* \*

Charge-depleting means relating to the test interval of a plug-in hybrid engine or powertrain in which the engine or powertrain consumes electric energy from the RESS that has been charged from an external power source until the RESS is depleted to the point that a test interval qualifies as charge-sustaining. The engine might consume fuel to produce power during a charge-depleting test interval.

Charge-sustaining means relating to the test interval of a plug-in hybrid engine or powertrain in which the engine or powertrain consumes fuel to produce power such that the battery's net-energy change meets the end-of-test criterion of SAE J1711 or SAE J2711, as applicable (incorporated by reference in § 1066.1010).

\* \* \* \* \*

Test interval means a period over which a vehicle's emission rates are determined separately. For many standards, compliance with the standard is based on a weighted average of the mass emissions from multiple test intervals. For example, the standard-setting part may specify a complete duty cycle as a cold-start test interval and a hot-start test interval. In cases where multiple test intervals occur over a duty cycle, the standard-setting part may specify additional calculations that weight and combine results to arrive at composite values for comparison against the applicable standards in this chapter.

\* \* \* \* \*

■ 258. Amend § 1066.1005 by revising paragraphs (b), (g), and (h) to read as follows:

§ 1066.1005 Symbols, abbreviations, acronyms, and units of measure.

\* \* \* \* \*

(b) Symbols for chemical species. This part uses the following symbols for chemical species and exhaust constituents:

TABLE 2 TO PARAGRAPH (b) OF § 1066.1005—SYMBOLS FOR CHEMICAL SPECIES AND EXHAUST CONSTITUENTS

Table with 2 columns: Symbol and Species. Lists chemical symbols like CH4, CH3OH, CH2O, etc., and their corresponding species names like methane, methanol, formaldehyde, etc.

TABLE 2 TO PARAGRAPH (b) OF § 1066.1005—SYMBOLS FOR CHEMICAL SPECIES AND EXHAUST CONSTITUENTS—Continued

Symbol	Species
THCE .....	total hydrocarbon equivalent.

\* \* \* \* \*

(g) *Constants.* (1) This part uses the following constants for the composition of dry air:

TABLE 7 TO PARAGRAPH (g)(1) OF § 1066.1005—CONSTANTS FOR THE COMPOSITION OF DRY AIR

Symbol	Quantity	mol/mol
X <sub>Ar</sub> air .....	amount of argon in dry air .....	0.00934
X <sub>CO2</sub> air .....	amount of carbon dioxide in dry air .....	0.000375
X <sub>N2</sub> air .....	amount of nitrogen in dry air .....	0.78084
X <sub>O2</sub> air .....	amount of oxygen in dry air .....	0.209445

(2) This part uses the following molar masses or effective molar masses of chemical species:

TABLE 8 TO PARAGRAPH (g)(2) OF § 1066.1005—MOLAR MASSES OR EFFECTIVE MOLAR MASSES OF CHEMICAL SPECIES

Symbol	Quantity	g/mol (10 <sup>-3</sup> ·kg·mol <sup>-1</sup> )
M <sub>air</sub> .....	molar mass of dry air <sup>1</sup> .....	28.96559
M <sub>H2O</sub> .....	molar mass of water .....	18.01528

<sup>1</sup> See paragraph (g)(1) of this section for the composition of dry air.

(3) This part uses the following molar gas constant for ideal gases:

TABLE 9 TO PARAGRAPH (g)(3) OF § 1066.1005—MOLAR GAS CONSTANT FOR IDEAL GASES

Symbol	Quantity	J/(mol·K) (m <sup>2</sup> ·kg·s <sup>-2</sup> ·mol <sup>-1</sup> ·K <sup>-1</sup> )
R .....	molar gas constant .....	8.314472

(h) *Prefixes.* This part uses the following prefixes to define a quantity:

TABLE 10 TO PARAGRAPH (h) OF § 1066.1005—PREFIXES TO DEFINE A QUANTITY

Symbol	Quantity	Value
n .....	nano .....	10 <sup>9</sup>
μ .....	micro .....	10 <sup>-6</sup>
m .....	milli .....	10 <sup>-3</sup>
c .....	centi .....	10 <sup>-2</sup>
k .....	kilo .....	10 <sup>3</sup>
M .....	mega .....	10 <sup>6</sup>

■ 259. Revise § 1066.1010 to read as follows:

**§ 1066.1010 Incorporation by reference.**

Certain material is incorporated by reference into this part with the approval of the Director of the Federal Register in accordance with 5 U.S.C. 552(a) and 1 CFR part 51. To enforce

any edition other than that specified in this section, the Environmental Protection Agency (EPA) must publish a document in the **Federal Register** and the material must be available to the public. All approved material is available for inspection at the EPA and at the National Archives and Records Administration (NARA). Contact EPA

at: U.S. EPA, Air and Radiation Docket and Information Center, 1301 Constitution Ave. NW, Room B102, EPA West Building, Washington, DC 20460, [www.epa.gov/dockets](http://www.epa.gov/dockets), (202) 202-1744. For information on the availability of this material at NARA, email: [fr.inspection@nara.gov](mailto:fr.inspection@nara.gov), or go to: [www.archives.gov/federal-register/cfr/](http://www.archives.gov/federal-register/cfr/)

*ibr-locations.html*. The material may be obtained from the following sources:

(a) National Institute of Standards and Technology (NIST), 100 Bureau Drive, Stop 1070, Gaithersburg, MD 20899–1070; (301) 975–6478; *www.nist.gov*.

(1) NIST Special Publication 811, 2008 Edition, Guide for the Use of the International System of Units (SI), Physics Laboratory, March 2008; IBR approved for §§ 1066.20(a); 1066.1005.

(2) [Reserved]

(b) SAE International, 400 Commonwealth Dr., Warrendale, PA 15096–0001; (877) 606–7323 (U.S. and Canada) or (724) 776–4970 (outside the U.S. and Canada); *www.sae.org*.

(1) SAE J1263, Road Load Measurement and Dynamometer Simulation Using Coastdown Techniques, revised March 2010; IBR approved for §§ 1066.301(b); 1066.305(a); 1066.310(b).

(2) SAE J1634, Battery Electric Vehicle Energy Consumption and Range Test Procedure, revised July 2017; IBR approved for § 1066.501(a).

(3) SAE J1711, Recommended Practice for Measuring the Exhaust Emissions and Fuel Economy of Hybrid-Electric Vehicles, Including Plug-In Hybrid Vehicles, revised June 2010; IBR approved for §§ 1066.501(a); 1066.1001.

(4) SAE J2263, Road Load Measurement Using Onboard Anemometry and Coastdown Techniques, revised May 2020; IBR approved for §§ 1066.301(b); 1066.305; 1066.310(b).

(5) SAE J2264, Chassis Dynamometer Simulation of Road Load Using Coastdown Techniques, revised January 2014; IBR approved for § 1066.315.

(6) SAE J2711, Recommended Practice for Measuring Fuel Economy and Emissions of Hybrid-Electric and Conventional Heavy-Duty Vehicles, revised May 2020; IBR approved for §§ 1066.501(a); 1066.1001.

(7) SAE J2951, Drive Quality Evaluation for Chassis Dynamometer Testing, revised January 2014; IBR approved for § 1066.425(j).

**PART 1068—GENERAL COMPLIANCE PROVISIONS FOR HIGHWAY, STATIONARY, AND NONROAD PROGRAMS**

■ 260. The authority citation for part 1068 continues to read as follows:

**Authority:** 42 U.S.C. 7401–7671q.

■ 261. Amend § 1068.1 by revising paragraphs (a)(2), (5), (6), (8), (9), and (13) and adding paragraph (a)(15) to read as follows:

**§ 1068.1 Does this part apply to me?**

(a) \* \* \*

(2) This part 1068 applies for heavy-duty motor vehicles and motor vehicle engines we regulate under 40 CFR parts 1036 and 1037. This includes trailers. This part 1068 applies to heavy-duty motor vehicles and motor vehicle engines certified under 40 CFR part 86 to the extent and in the manner specified in 40 CFR parts 85, 86, and 1036.

\* \* \* \* \*

(5) This part 1068 applies for locomotives that are subject to the provisions of 40 CFR part 1033.

(6) This part 1068 applies for land-based nonroad compression-ignition engines that are subject to the provisions of 40 CFR part 1039. This part 1068 applies for engines certified under 40 CFR part 89 to the extent and in the manner specified in 40 CFR part 1039.

\* \* \* \* \*

(8) This part 1068 applies for marine compression-ignition engines that are subject to the provisions of 40 CFR part 1042. This part 1068 applies for marine compression-ignition engines certified under 40 CFR part 94 to the extent and in the manner specified in 40 CFR part 1042.

(9) This part 1068 applies for marine spark-ignition engines that are subject to the provisions of 40 CFR part 1045. This part 1068 applies for marine spark-ignition engines certified under 40 CFR part 91 to the extent and in the manner specified in 40 CFR part 1045.

\* \* \* \* \*

(13) This part applies for small nonroad spark-ignition engines that are subject to the provisions of 40 CFR part 1054. This part 1068 applies for nonroad spark-ignition engines certified under 40 CFR part 90 to the extent and in the manner specified in 40 CFR part 1054.

\* \* \* \* \*

(15) This part 1068 applies to portable fuel containers we regulate under 40 CFR part 59 to the extent and in the manner specified in 40 CFR part 59, subpart F.

\* \* \* \* \*

■ 262. Revise § 1068.10 to read as follows:

**§ 1068.10 Practices for handling confidential business information.**

The provisions of this section apply both to any information you send us and to any information we collect from inspections, audits, or other site visits.

(a) When you submit information to us, if you claim any of that information as confidential, you may identify what you claim to be confidential by marking, circling, bracketing, stamping, or some

other method; however, we will not consider any claims of confidentiality over information we have determined to be not entitled to confidential treatment under § 1068.11 or other applicable provisions.

(b) If you send us information without claiming it is confidential, we may make it available to the public without further notice to you, as described in 40 CFR 2.301(j).

(c) For submissions that include information that may be entitled to confidential treatment, we may require that you send a “public” copy of the report that does not include the confidential information. We may require that you substantiate your claim to confidential treatment for any items not contained in the public version. We will release additional information from the complete version of such a submission only as allowed under 40 CFR 2.301(j) and as described in this subpart and the standard-setting part.

(d) We will safeguard your confidential business information (CBI) as described in 40 CFR 2.301(j). Also, we will treat certain information as confidential and will only disclose this information if it has been determined to be not entitled to confidential treatment as specified in § 1068.11(c). The following general provisions describe how we will process requests for making information publicly available:

(1) *Certification information.* We will treat information submitted in an application for certification as confidential until the introduction-into-commerce date you identify in your application for certification consistent with 40 CFR 2.301(a)(2)(ii)(B). If we issue the certificate after your specified date, for the purpose of this section the introduction-into-commerce date is the date we issue the certificate. After that date, we will treat information submitted in an application for certification as described in § 1068.11.

(2) *Preliminary and superseded information.* Preliminary and superseded versions of information you submit are covered by confidentiality determinations in the same manner as final documents. However, we will generally not disclose preliminary or superseded information unless we receive a request under 5 U.S.C. 552 that specifically asks for all versions of a document, including preliminary and superseded versions. We will consider a document preliminary if we have not reviewed it to verify its accuracy or if the reporting deadline has not yet passed. We will consider information superseded if you submit a new document or a revised application for

certification to replace the earlier version.

(3) *Authorizing CBI disclosure.* The provisions of this section do not prevent us from disclosing protected information if you specifically authorize it.

(4) *Relationship to the standard-setting part.* The standard-setting part may identify additional provisions related to confidentiality determinations. Note that the standard-setting part identifies information requirements that apply for each type of engine/equipment. If this section identifies information that is not required for a given engine, that does not create a requirement to submit the information.

(5) *Changes in law.* The confidentiality determinations in this section and in the standard-setting parts may be changed through the processes described in 40 CFR 2.301(j)(4).

■ 263. Add § 1068.11 to read as follows:

**§ 1068.11 Confidentiality determinations and related procedures.**

This section characterizes various categories of information for purposes of making confidentiality determinations, as follows:

(a) This paragraph (a) applies the definition of “Emission data” in 40 CFR 2.301(a) for information related to engines/equipment subject to this part. “Emission data” cannot be treated as confidential business information and shall be available to be disclosed to the public except as specified in § 1068.10(d)(1). The following categories of information qualify as emission data, except as specified in paragraph (c) of this section:

(1) Certification and compliance information, including information submitted in an application for a certificate of conformity that is used to assess compliance.

(2) Fleet value information, including information submitted for compliance with fleet average emission standards and emissions related ABT credit information, including the information used to generate credits.

(3) Source family information. For example, engine family information or test group information would identify the regulated emission source.

(4) Test information and results, including emission test results and other data from emission testing that are submitted in an application for a certificate of conformity, test results from in-use testing, production-line testing, and any other testing to demonstrate emissions. The information in this category includes all related information to characterize test results,

document the measurement procedure, and modeling inputs and outputs where the compliance demonstration is based on computer modeling.

(5) ABT credit information, including information submitted for current and future compliance demonstrations using credits under an ABT program.

(6) Production volume, including information submitted for compliance with fleet average emission standards, compliance with requirements to test production engines/equipment, or compliance through ABT programs.

(7) Defect and recall information, including all information submitted in relation to a defect or recall except the remedial steps you identify in § 1068.510(a)(2).

(8) Selective enforcement audit compliance information.

(b) The following categories of information are not eligible for confidential treatment, except as specified in § 1068.10(d)(1):

(1) Published information, including information that is made available in annual and quarterly filings submitted to the U.S. Securities and Exchanges Commission, on company websites, or otherwise made publicly available by the information submitter.

(2) Observable information available to the public after the introduction to commerce date.

(c) The following categories of information are subject to the process for confidentiality determinations in 40 CFR part 2 as described in 40 CFR 2.301(j)(5).

(1) Projected sales and production volumes.

(2) Production start and end dates.

(3) Detailed description of emission control operation and function.

(4) Design specifications related to aftertreatment devices.

(5) Description of auxiliary emission control devices (AECs).

(6) Plans for meeting regulatory requirements. For example, this applies for any projections of emission credits for the coming model year or determinations of the number of required repair facilities that are based on projected production volumes.

(7) The following information related to deterioration factors and other adjustment factors:

(i) Procedures to determine deterioration factors and other emission adjustment factors.

(ii) Any information used to justify those procedures.

(iii) Emission measurements you use to compare procedures or demonstrate that the procedures are appropriate.

(8) Financial information related to the following items:

(i) ABT credit transactions, including dollar amount, identity of parties, and contract information.

(ii) Meeting bond requirements, including aggregate U.S. asset holdings, financial details regarding specific assets, whether the manufacturer or importer obtains a bond, and copies of bond policies.

(9) Serial numbers or other information to identify specific engines or equipment selected for testing.

(10) Procedures that apply based on your request to test engines/equipment differently than we specify in the regulation. This applies for special and alternative test procedures. This also applies, for example, if we approve a broader or narrower zone of engine operation for not-to-exceed testing.

(11) Information related to testing vanadium catalysts in 40 CFR part 1065, subpart L.

(12) GPS data identifying the location for in-use emission measurements.

(13) Information related to possible defects that are subject to further investigation (not confirmed defects).

(d) If you submit information that is not addressed in paragraphs (a) through (c) of this section, you may claim the information as confidential. We may require you to provide us with information to substantiate your claims. If claimed, we may consider this substantiating information to be confidential to the same degree as the information for which you are requesting confidential treatment. We will make our determination based on your statements to us, the supporting information you send us, and any other available information. However, we may determine that your information is not subject to confidential treatment consistent with 40 CFR part 2 and 5 U.S.C. 552(b)(4).

(e) Applications for certification and submitted reports typically rely on software or templates to identify specific categories of information. If you submit information in a comment field designated for users to add general information, we will respond to requests for disclosing that information consistent with paragraphs (a) through (d) of this section.

■ 264. Amend § 1068.30 by adding a definition for “Critical emission-related component” in alphabetical order and revising the definition of “Designated Compliance Officer” to read as follows:

**§ 1068.30 Definitions.**

\* \* \* \* \*

*Critical emission-related component* means a component identified in appendix A of this part whose primary purpose is to reduce emissions or whose

failure would commonly increase emissions without significantly degrading engine/equipment performance.

\* \* \* \* \*

*Designated Compliance Officer* means one of the following:

(1) For motor vehicles regulated under 40 CFR part 86, subpart S: Director, Light-Duty Vehicle Center, U.S. Environmental Protection Agency, 2000 Traverwood Drive, Ann Arbor, MI 48105; [complianceinfo@epa.gov](mailto:complianceinfo@epa.gov); [www.epa.gov/ve-certification](http://www.epa.gov/ve-certification).

(2) For compression-ignition engines used in heavy-duty highway vehicles regulated under 40 CFR part 86, subpart A, and 40 CFR parts 1036 and 1037, and for nonroad and stationary compression-ignition engines or equipment regulated under 40 CFR parts 60, 1033, 1039, and 1042: Director, Diesel Engine Compliance Center, U.S. Environmental Protection Agency, 2000 Traverwood Drive, Ann Arbor, MI 48105; [complianceinfo@epa.gov](mailto:complianceinfo@epa.gov); [www.epa.gov/ve-certification](http://www.epa.gov/ve-certification).

(3) Director, Gasoline Engine Compliance Center, U.S. Environmental Protection Agency, 2000 Traverwood Drive, Ann Arbor, MI 48105; [complianceinfo@epa.gov](mailto:complianceinfo@epa.gov); [www.epa.gov/ve-certification](http://www.epa.gov/ve-certification), for all the following engines and vehicles:

(i) For spark-ignition engines used in heavy-duty highway vehicles regulated under 40 CFR part 86, subpart A, and 40 CFR parts 1036 and 1037,

(ii) For highway motorcycles regulated under 40 CFR part 86, subpart E.

(iii) For nonroad and stationary spark-ignition engines or equipment regulated under 40 CFR parts 60, 1045, 1048, 1051, 1054, and 1060.

■ 265. Add § 1068.50 to read as follows:

**§ 1068.50 Adjustable parameters.**

(a) The standard-setting part generally requires that production engines, pre-production engines, and in-use engines with adjustable parameters meet all the requirements of this part for any adjustment in the physically adjustable range. This section refers to engines, because most adjustable parameters are integral to the engine even in the case of equipment-based standards. This section also applies for equipment-based adjustable parameters. The provisions of this section apply starting with model year 2024.

(b) You must use good engineering judgment for all decisions related to adjustable parameters. We recommend that you ask for preliminary approval for decisions related to new technologies, substantially changed engine designs, or new methods for

limiting adjustability. Decisions related to adjustable parameters include the following:

(1) Determining which engine operating parameters qualify as adjustable parameters.

(2) Establishing the adequacy of the limits, stops, seals, or other means used to limit adjustment.

(3) Defining the physically adjustable ranges for each such parameter.

(c) For purposes of this section, “operating parameter” means any feature that can, by the nature of its design, be adjusted to affect engine/equipment performance, including engine components that are designed to be replaced. For example, while bolts used to assemble the engine are practically adjustable (can be loosened or tightened), they are not adjustable parameters because they are not operating parameters. See paragraph (h) of this section for special provisions related to elements of design involving consumption and replenishment. A nonconsumable operating parameter is considered an adjustable parameter as follows:

(1) An operating parameter is not an adjustable parameter if we determine it is not practically adjustable using available tools, as described in paragraph (d) of this section, or we determine that engine operation over the full range of adjustment does not affect emissions without also degrading engine performance to the extent that operators will be aware of the problem. Also, while spark plug gap and valve lash are practically adjustable operating parameters, they are not adjustable parameters because adjusting them does not affect emissions without also degrading engine performance.

(2) The following specific criteria apply for determining whether a parameter is practically adjustable because it is permanently sealed or otherwise inaccessible:

(i) Electronic components on circuit boards (such as onboard computers) are not practically adjustable if the board is encapsulated with a durable resin that adequately limits access to components on the board, consistent with paragraph (d)(1) of this section.

(ii) Threaded fasteners (such as screws) on mechanically controlled engines are considered not practically adjustable if simple tools cannot be used to adjust the parameter once the head is sheared off after adjustment at the factory, or if the fastener is recessed within a larger, permanent body and sealed with a durable plug, cap, or cover plate that adequately limits access to the fastener, consistent with paragraph (d)(1) of this section.

(iii) Bimetal springs on mechanically controlled engines are considered not practically adjustable if the plate covering the bimetal spring is riveted or welded in place or it is held in place with threaded fasteners meeting the specifications described in this paragraph (c)(2).

(d) The following provisions apply for determining whether operating parameters are “practically adjustable”:

(1) A mechanically controlled parameter is considered “not practically adjustable” if adjustments with ordinary tools take more than 15 minutes or involve service parts that cost more than \$30 for engines at or below 30 kW, or take more than 60 minutes or involve service parts that cost more than \$60 for engines between 30 kW and 560 kW. These costs are in 2020 dollars. Adjust these values for certification by comparing most recently available Consumer Price Index for All Urban Consumers (CPI-U) value published by the Bureau of Labor Statistics at [www.usinflationcalculator.com](http://www.usinflationcalculator.com). As used in this paragraph (d), the term “ordinary tools” includes hand tools, solvents, or other supplies that are reasonably available to the operator. Hand tools include screwdrivers, pliers, hammers, awls, wrenches, electric screwdrivers, electric drills, and any tools supplied by the manufacturer with the product. Any such items that are sold at hardware stores, automotive parts supply stores or on the Internet are considered available. The cost thresholds described in this paragraph (d)(1) do not include the cost of labor or the cost of any necessary tools or nonconsumable supplies; the time thresholds refer to the time required to access and adjust the parameter, excluding any time necessary to purchase parts, tools, or supplies or to perform testing. For engines at or above 560 kW, mechanically controlled parameters are considered “practically adjustable” if the parameter can be adjusted using any available tools. Determine the practically adjustable range of mechanically controlled parameters as described in paragraph (e) this section.

(2) Electronically controlled parameters are considered “practically adjustable” if they can be adjusted using any available tools (including devices that are used to alter computer code). Conversely, such parameters are not practically adjustable if you limit access to the electronic control units with password or encryption protection. You must have adequate protections in place to prevent distribution and use of passwords or encryption keys. We may exclude operating parameters (or narrow the adjustable range under paragraph (f)

of this section) where we determine that the operating parameters will not be subject to in-use adjustment or will be subject to a more limited in-use adjustment. Our approval may include conditions to ensure that the certified configuration includes adjustable ranges that reflect the expected range of in-use adjustment. This paragraph (d)(2) applies for engines with any degree of electronic control. Determine the practically adjustable range of electronically controlled parameters as described in paragraph (f) of this section.

(e) A physical limit or stop is adequate for defining the limits of the practically adjustable range if it has the following characteristics:

(1) In the case of a threaded adjustment, the threads are terminated, pinned, or crimped to prevent additional travel without such that the operator cannot bypass the physical limit or stop without causing damage for which the repairs would exceed the time or cost thresholds specified in paragraph (d)(1) of this section.

(2) Operators cannot exceed the travel or rotation limits using ordinary tools without causing damage for which the repairs would exceed the time or cost thresholds specified in paragraph (d)(1) of this section. For example, if a vehicle has a shim, bushing, or other device to limit flow rates, range of travel, or other parameters to prevent operating outside of a specified range of engine or vehicle speeds, you must take steps to prevent operators or mechanics from removing, replacing, or altering those parts to operate at a wider range of engine or vehicle speeds.

(f) Apply the following provisions to determine the practically adjustable range for electronically controlled parameters that can be adjusted by changing software or operating parameters (“reflashed”):

(1) If an engine family includes multiple algorithms that can be selected or are easily accessible, consider each of the available settings to be within the practically adjustable range.

(2) If you sell or offer to sell software or other products that could be used to reflash or otherwise modify the electronic control unit, consider all those settings to be within the practically adjustable range.

(3) If your engines/equipment have other electronic settings that can be modified or accessed as described in paragraph (d)(2) of this section, consider all those settings to be within the practically adjustable range. The following engine systems and features illustrate examples of the types of

electronic settings for which this paragraph (f)(3) applies:

(i) Air-fuel setpoints for closed-loop fuel systems.

(ii) Reductant flow systems.

(iii) Base maps for fuel injection or spark timing.

(iv) Exhaust gas recirculation maps.

(g) We will make determinations regarding in-use adjustments of adjustable parameters under this section for certifying engines as follows:

(1) Our determinations will depend on in-use maintenance practices conforming to the maintenance and service information you provide. For example, if your published maintenance instructions describe routine procedures for adjusting engines or if you or your dealers make specialized tools available to operators, we will conclude that such adjustments are likely to occur. Also, your maintenance and service information may not specify adjustable ranges that are broader than those that you specify in your application for certification.

(2) We may review manufacturer statements under this section for certifying engines for a later model year if we learn from observation of in-use engines or other information that a parameter was in fact practically adjustable or that the specified operating range was in fact not correct. We may require you to include a new adjustable parameter or to revise your specified operating range for an adjustable parameter.

(h) Except as provided in the standard-setting part and this paragraph (h), engines are not in the certified configuration if you produce them with adjustable parameters set outside the range specified in your application for certification. Similarly, engines are not in the certified configuration if you produce them with other operating parameters that do not conform to the certified configuration. The following provisions apply for adjustable parameters related to elements of design involving consumption and replenishment, such as DEF tank fill level and hybrid battery state of charge:

(1) We will determine the range of adjustability based on the likelihood of in-use operation at a given point in the physically adjustable range. We may determine that operation in certain subranges within the physically adjustable range is sufficiently unlikely that the subranges should be excluded from the allowable adjustable range for testing.

(2) Shipping new engines/equipment in a state or configuration requiring replenishment to be within the range of adjustability for a certified configuration

does not cause a violation of the prohibition in § 1068.101(a)(1).

(i) In your application for certification, include information related to adjustable parameters as described in the standard-setting part and state that you meet the specifications of this section and provide supporting documentation for that statement as follows:

(1) If your engine is designed with mechanically controlled adjustable parameters, state that they meet the specifications of this section for preventing in-use operation outside the intended physically adjustable range.

(2) If your engine is designed with electronically controlled operating parameters that you consider “not practically adjustable,” state that you have restricted access to the electronic controls as specified in this section to prevent in-use operation outside the practically adjustable range.

(j) We may inspect your engines at any time to determine whether they meet the specifications of this section. We may purchase engines for testing, or we may ask you to supply engines for such inspections. We will inspect using ordinary tools and time limits specified in paragraph (d)(1) of this section and any available devices that alter computer code as specified in paragraph (d)(2) of this section. The inspection will determine the following:

(1) If the adjustable parameter is limited to the physically adjustable range specified in the manufacturer’s certification application.

(2) If physical stops for mechanically controlled adjustable parameters can be bypassed using methods outlined in paragraph (d)(1) of this section.

(k) Where we determine that you failed to identify something that should be considered an adjustable parameter, we may require you to treat the parameter as defective under § 1068.501. If we determine you deliberately misrepresented the accessibility of the parameter or that you did not act in good faith, we may take action regarding your certificate as described in the standard-setting part (see, for example, 40 CFR 1054.255).

(l) Nothing in this section limits the tampering prohibition of § 1068.101(b)(1) or the defeat device prohibition of § 1068.101(b)(2).

■ 266. Amend § 1068.101 by revising paragraphs (a) introductory text and (b)(5) to read as follows:

**§ 1068.101 What general actions does this regulation prohibit?**

\* \* \* \* \*

(a) The following prohibitions and requirements apply to manufacturers of



new engines, manufacturers of equipment containing these engines, manufacturers of new equipment, and other persons as provided by § 1068.1(a), except as described in subparts C and D of this part:

\* \* \* \* \*

(b) \* \* \*

(5) *Importation.* You may not import an uncertified engine or piece of equipment if it is defined to be new in the standard-setting part with a model year for which emission standards applied. Anyone violating this paragraph (b)(5) is deemed to be a manufacturer in violation of paragraph (a)(1) of this section. We may assess a civil penalty up to \$44,539 for each engine or piece of equipment in violation. Note the following:

\* \* \* \* \*

■ 267. Amend § 1068.210 by revising paragraph (c) introductory text to read as follows:

**§ 1068.210 Exempting test engines/equipment.**

\* \* \* \* \*

(c) If you are a certificate holder, you may request an exemption for engines/equipment you intend to include in a test program.

\* \* \* \* \*

■ 268. Amend § 1068.220 by revising paragraph (b) to read as follows:

**§ 1068.220 Exempting display engines/equipment.**

\* \* \* \* \*

(b) Nonconforming display engines/equipment will be exempted if they are used for displays in the interest of a business or the general public. The exemption in this section does not apply to engines/equipment displayed for any purpose we determine is inappropriate for a display exemption.

\* \* \* \* \*

■ 269. Amend § 1068.240 by revising paragraphs (a)(1), (b)(3), and (c)(3)(ii) to read as follows:

**§ 1068.240 Exempting new replacement engines.**

\* \* \* \* \*

(a) \* \* \*

(1) Paragraphs (b) and (c) of this section describe different approaches for exempting new replacement engines where the engines are specially built to correspond to an engine model from an earlier model year that was subject to less stringent standards than those that apply for current production (or is no longer covered by a certificate of conformity). You must comply with the requirements of paragraph (b) of this section for any number of replacement engines you produce in excess of what

we allow under paragraph (c) of this section. You must designate engines you produce under this section as tracked engines under paragraph (b) of this section or untracked engines under paragraph (c) of this section by the deadline for the report specified in paragraph (c)(3) of this section.

\* \* \* \* \*

(b) \* \* \*

(3) An old engine block replaced by a new engine exempted under this paragraph (b) may be reintroduced into U.S. commerce as part of an engine that meets either the current standards for new engines, the provisions for new replacement engines in this section, or another valid exemption. Otherwise, you must destroy the old engine block (or confirm that it has been destroyed), or export the engine block without its emission label. Note that this paragraph (b)(3) does not require engine manufacturers to take possession of the engine being replaced. Owners may arrange to keep the old engine if they demonstrate that the engine block has been destroyed. An engine block is destroyed under this paragraph (b)(3) if it can never be restored to a running configuration.

\* \* \* \* \*

(c) \* \* \*

(3) \* \* \*

(ii) Count exempt engines as tracked under paragraph (b) of this section only if you meet all the requirements and conditions that apply under paragraph (b)(2) of this section by the due date for the annual report. In the annual report you must identify any replaced engines from the previous year whose final disposition is not resolved by the due date for the annual report. Continue to report those engines in later reports until the final disposition is resolved. If the final disposition of any replaced engine is not resolved for the fifth annual report following the production report, treat this as an untracked replacement in the fifth annual report for the preceding year.

\* \* \* \* \*

■ 270. Amend § 1068.261 by revising paragraphs (b), (c) introductory text, and (d) introductory text to read as follows:

**§ 1068.261 Delegated assembly and other provisions related to engines not yet in the certified configuration.**

\* \* \* \* \*

(b) If you manufacture engines and install them in equipment you or an affiliated company also produce, you must take steps to ensure that your facilities, procedures, and production records are set up to ensure that equipment and engines are assembled in

their proper certified configurations. For example, you may demonstrate compliance with the requirements of this section by maintaining a database showing how you pair aftertreatment components with the appropriate engines such that the final product is in its certified configuration.

(c) If you manufacture engines and ship them to an unaffiliated company for installation in equipment and you include the price of all aftertreatment components in the price of the engine (whether or not you ship the aftertreatment components directly to the equipment manufacturer), all the following conditions apply:

\* \* \* \* \*

(d) If you manufacture engines and ship them to an unaffiliated company for installation in equipment, but you do not include the price of all aftertreatment components in the price of the engine, you must meet all the conditions described in paragraphs (c)(1) through (9) of this section, with the following additional provisions:

\* \* \* \* \*

■ 271. Amend § 1068.301 by revising paragraph (b) to read as follows:

**§ 1068.301 General provisions for importing engines/equipment.**

\* \* \* \* \*

(b) In general, engines/equipment that you import must be covered by a certificate of conformity unless they were built before emission standards started to apply. This subpart describes the limited cases where we allow importation of exempt or excluded engines/equipment. If an engine has an exemption from exhaust emission standards, you may import the equipment under the same exemption. Imported engines/equipment that are exempt or excluded must have a label as described in the specific exemption or exclusion. If the regulation does not include specific labeling requirements, apply a label meeting the requirements of § 1068.45 that identifies your corporate name and describes the basis for the exemption or exclusion.

\* \* \* \* \*

■ 272. Amend § 1068.310 by revising the introductory text and paragraph (e)(4) to read as follows:

**§ 1068.310 Exclusions for imported engines/equipment.**

If you show us that your engines/equipment qualify under one of the paragraphs of this section, we will approve your request to import such excluded engines/equipment. You must have our approval before importing engines/equipment under paragraph (a) of this section. You may, but are not

required to request our approval to import the engines/equipment under paragraph (b) through (d) of this section. Qualifying engines/equipment are excluded as follows:

\* \* \* \* \*

(e) \* \* \*

(4) State: "THIS ENGINE IS EXEMPT FROM THE REQUIREMENTS OF [identify the part referenced in § 1068.1(a) that would otherwise apply], AS PROVIDED IN [identify the paragraph authorizing the exemption (for example, "40 CFR 1068.310(a)"]]. INSTALLING THIS ENGINE IN ANY DIFFERENT APPLICATION MAY BE A VIOLATION OF FEDERAL LAW SUBJECT TO CIVIL PENALTY."

■ 273. Amend § 1068.315 by revising paragraphs (a) and (h) and removing paragraph (i) to read as follows:

**§ 1068.315 Permanent exemptions for imported engines/equipment.**

\* \* \* \* \*

(a) *National security exemption.* You may import an engine or piece of equipment under the national security exemption in § 1068.225.

\* \* \* \* \*

(h) *Identical configuration exemption.* Unless specified otherwise in the standard-setting part, you may import nonconforming engines/equipment if they are identical in all material respects to certified engines/equipment produced by the same manufacturer, subject to the following provisions:

(1) You must meet all the following criteria:

(i) You have owned the engines/equipment for at least six months.

(ii) You agree not to sell, lease, donate, trade, or otherwise transfer ownership of the engines/equipment for at least five years. The only acceptable way to dispose of the engines/equipment during this five-year period is to destroy or export them.

(iii) You use data or evidence sufficient to show that the engines/equipment are in a configuration that is identical in all material respects to engines/equipment the original manufacturer has certified to meet emission standards that apply at the time the manufacturer finished assembling or modifying the engines/equipment in question. If you modify the engines/equipment to make them identical, you must completely follow the original manufacturer's written instructions.

(2) We will tell you in writing if we find the information insufficient to show that the engines/equipment are

eligible for the identical configuration exemption. We will then not consider your request further until you address our concerns.

■ 274. Amend § 1068.325 by revising the introductory text and paragraphs (a) through (c), (e), and (g) to read as follows:

**§ 1068.325 Temporary exemptions for imported engines/equipment.**

You may import engines/equipment under certain temporary exemptions, subject to the conditions in this section. We may ask U.S. Customs and Border Protection to require a specific bond amount to make sure you comply with the requirements of this subpart. You may not sell or lease one of these exempted engines/equipment while it is in the United States except as specified in this section or § 1068.201(i). You must eventually export the engine/equipment as we describe in this section unless it conforms to a certificate of conformity or it qualifies for one of the permanent exemptions in § 1068.315 or the standard-setting part.

(a) *Exemption for repairs or alterations.* You may temporarily import nonconforming engines/equipment solely for repair or alteration, subject to our advance approval as described in paragraph (j) of this section. You may operate the engine/equipment in the United States only as necessary to repair it, alter it, or ship it to or from the service location. Export the engine/equipment directly after servicing is complete, or confirm that it has been destroyed.

(b) *Testing exemption.* You may temporarily import nonconforming engines/equipment for testing if you follow the requirements of § 1068.210, subject to our advance approval as described in paragraph (j) of this section. You may operate the engines/equipment in the United States only as needed to perform tests. The testing exemption expires one year after you import the engine/equipment unless we approve an extension. The engine/equipment must be exported before the exemption expires. You may sell or lease the engines/equipment consistent with the provisions of § 1068.210.

(c) *Display exemption.* You may temporarily import nonconforming engines/equipment for display if you follow the requirements of § 1068.220, subject to our advance approval as described in paragraph (j) of this section. The display exemption expires one year after you import the engine/equipment, unless we approve your

request for an extension. The engine/equipment must be exported (or destroyed) by the time the exemption expires or directly after the display concludes, whichever comes first.

\* \* \* \* \*

(e) *Diplomatic or military exemption.* You may temporarily import nonconforming engines/equipment if you represent a foreign government in a diplomatic or military capacity. U.S. Customs and Border Protection may require that you show your written confirmation from the U.S. State Department that you qualify for the diplomatic or military exemption or a copy of your orders for military duty in the United States. We will rely on the State Department or your military orders to determine when your diplomatic or military status expires, at which time you must export your exempt engines/equipment.

\* \* \* \* \*

(g) *Exemption for partially complete engines.* The following provisions apply for importing partially complete engines and used engines that become new as a result of importation:

(1) You may import a partially complete engine by shipping it from one of your facilities to another under the provisions of § 1068.260(c) if you also apply a removable label meeting the requirements of § 1068.45 that identifies your corporate name and states that the engine is exempt under the provisions of § 1068.325(g).

(2) You may import an engine if another company already has a certificate of conformity and will be modifying the engine to be in its final certified configuration or a final exempt configuration if you meet the labeling and other requirements of § 1068.262. If you are importing a used engine that becomes new as a result of importation, you must meet all the requirements that apply to original engine manufacturers under § 1068.262. You may sell or lease the engines consistent with the provisions of § 1068.262.

\* \* \* \* \*

■ 275. Amend § 1068.450 by revising paragraph (e) to read as follows:

**§ 1068.450 What records must I send to EPA?**

\* \* \* \* \*

(e) We may post test results on publicly accessible databases and we will send copies of your reports to anyone from the public who asks for them, consistent with § 1068.11.

■ 276. Amend § 1068.601 by revising the introductory text and paragraph (b) to read as follows:

**§ 1068.601 Overview.**

The regulations of this chapter involve numerous provisions that may result in EPA making a decision or judgment that you may consider adverse to your interests. For example, our decisions might require you to pay penalties, or you might consider that our decisions will limit your business activities or put you at a competitive disadvantage. As specified in the regulations in this chapter, this might involve an opportunity for an informal hearing or a formal hearing that follows specific procedures and is directed by a Presiding Officer. The regulations in this chapter generally specify when we would hold a hearing. In limited circumstances, we may grant a request for a hearing related to adverse decisions regarding regulatory provisions for which we do not specifically describe the possibility of asking for a hearing.

\* \* \* \* \*

(b) For other issues where the regulation allows for a hearing in response to an adverse decision, you may request an informal hearing as described in § 1068.650. Sections 1068.610 through 1068.630 describe when and how to request an informal hearing under various circumstances.

\* \* \* \* \*

■ 277. Add § 1068.630 to read as follows:

**§ 1068.630 Request for hearing—allowable maintenance.**

(a) Any manufacturer may request an informal hearing as described in

§ 1068.650 in response to our decision to identify allowable maintenance associated with new technology as part of the certification process.

(b) You must send your hearing request in writing to the Designated Compliance Officer no later than 30 days after we publish our decision in the **Federal Register**. If the deadline passes, we may nevertheless grant you a hearing at our discretion.

(c) Your hearing request must include the information specified in § 1068.610(d).

(d) We will approve your request for an informal hearing if we find that your request raises a substantial factual issue in the decision we made that, if addressed differently, could alter the outcome of that decision.

■ 278. Redesignate appendix I to part 1068 as appendix A to part 1068 and amend newly redesignated appendix A by revising the introductory text to read as follows:

**Appendix A to Part 1068—Emission-Related Components**

This appendix specifies emission-related components that we refer to for describing such things as emission-related warranty or maintenance or requirements related to rebuilding engines. Note that inclusion of a component in Section III of this Appendix does not make it an emission-related component for engines/equipment that are not subject to evaporative emission standards.

\* \* \* \* \*

**Appendix II to Part 1068— [Redesignated as Appendix B to Part 1068]**

■ 279. Redesignate appendix II to part 1068 as appendix B to part 1068.

**Appendix III to Part 1068— [Redesignated as Appendix C to Part 1068]**

■ 280. Redesignate appendix III to part 1068 as appendix C to part 1068.

**PART 1090—REGULATION OF FUELS, FUEL ADDITIVES, AND REGULATED BLENDSTOCKS**

■ 281. The authority citation for part 1090 continues to read as follows:

**Authority:** 42 U.S.C. 7414, 7521, 7522–7525, 7541, 7542, 7543, 7545, 7547, 7550, and 7601.

■ 282. Revise § 1090.1550 to read as follows:

**§ 1090.1550 Requirements for gasoline dispensing nozzles used with motor vehicles.**

The following requirements apply for any nozzle installation used for dispensing gasoline into motor vehicles:

(a) Nozzles must meet the following hardware specifications:

(1) The outside diameter of the terminal end must not be greater than 21.3 mm.

(2) The terminal end must have a straight section of at least 63 mm.

(3) The retaining spring must terminate at least 76 mm from the terminal end.

(b) The dispensing flow rate must not exceed a maximum value of 10 gallons per minute. The flow rate may be controlled through any means in the pump/dispenser system, as long as it does not exceed the specified maximum value.

[FR Doc. 2022–04934 Filed 3–16–22; 4:15 pm]

**BILLING CODE 6560–50–P**