

DEPARTMENT OF TRANSPORTATION**National Highway Traffic Safety Administration****49 CFR Part 571**

[Docket No. NHTSA–2022–0013]

RIN 2127–AL83

Federal Motor Vehicle Safety Standards; Lamps, Reflective Devices, and Associated Equipment, Adaptive Driving Beam Headlamps

AGENCY: National Highway Traffic Safety Administration (NHTSA), Department of Transportation (DOT).

ACTION: Final rule.

SUMMARY: This document amends NHTSA’s lighting standard to permit the certification of adaptive driving beam (ADB) headlamps. ADB headlamps utilize technology that actively modifies a vehicle’s headlamp beams to provide more illumination while not glaring other vehicles. The requirements adopted today are intended to amend the lighting standard to permit this technology and establish performance requirements for these systems to ensure that they operate safely. ADB has the potential to reduce the risk of crashes by increasing visibility without increasing glare. The agency initiated this rulemaking in response to a petition for rulemaking from Toyota Motor North America, Inc.

DATES:

Effective date: The effective date of this final rule is February 22, 2022. The incorporation by reference of certain publications listed in the rule was approved by the Director of the Federal Register as of February 6, 2012.

Compliance date: The compliance date for the amendments in this final rule is February 22, 2022.

Petitions for reconsideration: Petitions for reconsideration of this final rule must be received not later than April 8, 2022.

ADDRESSES: Petitions for reconsideration of this final rule must refer to the docket and notice number set forth above and be submitted to the Administrator, National Highway Traffic Safety Administration, 1200 New Jersey Avenue SE, Washington, DC 20590. Note that all petitions received will be posted without change to www.regulations.gov, including any personal information provided.

Privacy Act: Please see the Privacy Act heading under Rulemaking Analyses and Notices.

FOR FURTHER INFORMATION CONTACT: Mr. Markus Price, NHTSA Office of Crash

Avoidance Standards. Telephone: 202–366–1810; Email: Markus.Price@dot.gov; or Mr. John Piazza, Office of Chief Counsel. Telephone: 202–366–2992; Email: John.Piazza@dot.gov. You may send mail to these officials at: National Highway Traffic Safety Administration, 1200 New Jersey Avenue SE, Washington, DC 20590.

SUPPLEMENTARY INFORMATION:**Table of Contents**

- I. Executive Summary
- II. Background and Safety Need
- III. NHTSA’s Statutory Authority
- IV. ADB Rulemaking Mandate in the Infrastructure, Investment and Jobs Act
- V. Summary of the NPRM
- VI. Overview of Comments
- VII. NHTSA Research and Testing
- VIII. Final Rule and Response to Comments
 - A. Summary of the Final Rule and Modifications to the NPRM
 - B. Interpretation of FMVSS No. 108 as Applied to ADB Systems
 - C. Track Testing Requirements and Procedures
 1. Practicability of Proposed Test Scenarios
 2. Test Fixtures vs. Stimulus Vehicles
 3. Justification for Testing on Curves and General Approach for Scenario Selection
 4. Maximum Illuminance Criteria (Glare Limits)
 5. ADB Adaptation Time
 6. Test Fixture Specifications
 7. Test Fixture Placement
 8. Test Scenarios
 - a. Scenario 1: Oncoming Straight
 - b. Scenario 2: Oncoming Small Left Curve
 - c. Scenario 3: Oncoming Medium Left Curve
 - d. Scenario 4: Oncoming Large Left Curve
 - e. Scenario 5: Oncoming Medium Right Curve
 - f. Scenario 6: Oncoming Large Right Curve
 - g. Scenario 7: Preceding Straight
 - h. Scenario 8: Preceding Medium Left Curve
 - i. Decision Not To Include Oncoming Short Right Curve Scenario
 9. Other Test Parameters and Conditions
 - a. Radius of Curvature
 - b. Test Vehicle Speed and Acceleration
 - c. Headlamp Aim
 - d. Road Surface
 - e. Ambient and Reflected Light
 - f. Superelevation
 - g. Lane Divisions
 - h. Hills
 10. Data Acquisition and Measurement
 - a. Photometers
 - b. Sampling Rate
 - c. Noise and Filtering
 - d. Allowance for Momentary Glare Exceedances
 - e. Vehicle Pitch
 11. Repeatability
 - D. Laboratory (Component-Level) Testing
 1. Need for Laboratory Testing
 2. Definitions of Areas of Reduced and Unreduced Intensity
 3. Requirements for Area of Reduced Intensity
 4. Requirements for Area of Unreduced Intensity

5. Transition Zone
6. Veiling Glare
- E. Minimum Activation Speed
- F. Operator Controls, Indicators, Malfunction Detection, and Operating Instructions
- G. Accommodation of Different Technologies
- H. Requirements for Semiautomatic Beam Switching Devices Other Than ADB and Applicability of Compliance Options
- I. Physical Test Requirements
- J. Other Requirements
- K. Information Reporting
- L. Aftermarket Compliance
- M. Exemption Petitions
- N. Compliance Date
- O. Regulatory Alternatives
- P. Overview of Benefits and Costs
- IX. Appendix to FMVSS No. 108 (Table of Contents)
- X. Rulemaking Analyses and Notices
 - Appendix A. Comparison of Oncoming Glare Limits to Table XIX Right-Side Photometric Maxima
 - Appendix B. Example of Laboratory Photometric Testing of Adaptive Driving Beam
 - Appendix C. ADB Performance With Motorcycle Test Fixture
 - Appendix D. List of Comments Cited in Preamble

I. Executive Summary

This final rule amends Federal Motor Vehicle Safety Standard (FMVSS or Standard) No. 108, “Lamps, reflective devices, and associated equipment,” to enable the certification of adaptive driving beam (ADB) headlighting systems on vehicles sold in the United States. NHTSA is issuing this final rule under the National Traffic and Motor Vehicle Safety Act (Safety Act), 49 U.S.C. Chapter 301, Motor Vehicle Safety (49 U.S.C. 30101 *et seq.*).

Glare, Visibility, and Adaptive Driving Beam Technology

Adaptive driving beam headlamps utilize technology that actively modifies the headlamp beams to provide more illumination while not glaring other vehicles. The requirements adopted today are intended to amend FMVSS No. 108 to permit this technology and ensure that it operates safely.

Vehicle headlamps must satisfy two different safety needs: Visibility and glare prevention. The primary function of headlamps is to provide forward visibility for drivers. At the same time, there is a risk that intense headlamp illumination may be directed towards oncoming or preceding vehicles. Such illumination, referred to as glare, can reduce the ability of other drivers to see and can cause discomfort. Headlighting has therefore traditionally entailed a tradeoff between long-distance visibility and glare prevention. This is reflected in Standard No. 108’s requirement that

headlighting systems have both upper and lower beams. The existing headlamp requirements regulate the beam pattern (photometry) of the upper and lower beams; they ensure sufficient visibility by specifying minimum amounts of light in certain areas on and around the road, and prevent glare by specifying maximum amounts of light in directions that correspond to where oncoming and preceding vehicles would be.

ADB systems are an advanced type of headlamp technology that optimizes beam patterns without driver action. Semiautomatic beam switching technology was first introduced on vehicles in the United States in the 1950s and has become increasingly popular in the last few decades. The semiautomatic beam switching technology currently available in the United States (commonly referred to as “auto hi-beam” or “high beam assist”) automatically switches between the lower and upper beams. This provides safety benefits because research has shown that most drivers underutilize the upper beams, and semiautomatic beam switching facilitates increased upper beam use in situations where drivers of other vehicles will not be glared.

ADB systems are an improvement over “auto hi-beam” technology currently available in the United States because they are capable of providing more illumination than a lower beam without increasing glare. When operating in automatic mode, instead of simply switching between the upper and lower beams, an ADB system is able to provide a dynamic, adaptive beam pattern that changes based on the presence of other vehicles or objects, providing less illumination to occupied areas of the road and more illumination to unoccupied areas of the road. ADB systems can therefore provide more illumination than existing lower beams without glaring other motorists (if operating correctly). ADB systems achieve this enhanced performance by utilizing advanced sensors, data processing software, and headlamp hardware.

ADB systems are available in foreign markets but are not currently offered on vehicles in the United States. This final rule amends FMVSS No. 108 to permit ADB systems on vehicles in the United States and ensure that they operate safely. ADB, like other headlamp technologies, implicates the twin safety needs of visibility and glare prevention. This final rule does three main things that, taken together, allow ADB systems and ensure that they meet these safety needs.

First, it amends FMVSS No. 108 to allow ADB systems. It amends, among other things, the existing headlamp requirements so that ADB technology is permitted.

Second, this final rule adopts requirements to ensure that ADB systems do not increase glare to other motorists beyond current lower beams. ADB systems are capable of providing a variable, adaptive beam in the presence of other vehicles that provides more illumination than the currently allowed lower beam. However, if ADB systems do not accurately detect other vehicles on the road and shade them accordingly, other motorists will be glared.¹ The rule addresses this safety need by including vehicle-level track-test requirements specifically tailored to evaluate whether an ADB system functions safely and limits glare for other motorists.

Third, it adopts component-level laboratory-tested requirements related to both glare and visibility, as well as a limited set of other system requirements, such as requirements for manual override and fail-safe operation.

In drafting this final rule, NHTSA considered two major regulatory alternatives. One was the Economic Commission for Europe (ECE) regulations that apply to ADB systems, including a vehicle-level test on public roads. However, the ECE road test is not appropriate for adoption as an FMVSS because it does not provide sufficiently objective performance criteria. We also considered a Society for Automotive Engineers (SAE) recommended practice, J3069 JUN2016, Surface Vehicle Recommended Practice; Adaptive Driving Beam, as well as the updated version of this practice (published in March 2021). The final rule follows SAE J3069 in many significant respects, but also differs from it in significant ways.

NHTSA published the notice of proposed rulemaking (NPRM) preceding this final rule on October 12, 2018 (83 FR 51766). Many industry comments to the NPRM urged closer harmonization with SAE J3069. These comments focused primarily on costs from disharmonization due to the resulting need for market-specific hardware and components. In response to the comments, NHTSA conducted additional vehicle-level testing to validate modifications to the proposal to harmonize more closely with SAE J3069 while still retaining sufficient realism. As a result, NHTSA has changed some

aspects of the proposal. The final rule more closely conforms to SAE J3069 in a number of respects but continues to deviate from it for reasons discussed in detail in this preamble.

Differences Between This Final Rule and the Proposal

The following discussion highlights the more noteworthy differences between the final rule and the NPRM. All changes from the proposal are discussed in the appropriate sections of this preamble.

Vehicle-Level Track Test To Evaluate Glare

Stimulus test fixtures instead of stimulus vehicles. The final rule specifies test fixtures instead of stimulus vehicles. This change will result in a less complex test that is more closely harmonized with SAE J3069, while still ensuring that ADB systems operate safely. While the test fixture specifications follow SAE J3069 with respect to the locations of the photometers and stimulus lamps, the final rule requires the use of more real-world representative lighting in the compliance test by specifying original equipment vehicle headlamps and taillamps.

More efficient test scenarios. The final rule simplifies the number and complexity of test scenarios. The final rule continues to differ from SAE J3069 by specifying test scenarios with actual curves because this is necessary to evaluate how an ADB system would perform in the real world. We have, however, modified many of the curved-path test scenarios. NHTSA believes that the final scenarios meet the need for motor vehicle safety by containing a broad range of realistic road geometries and vehicle interactions.

Data measurement and allowances. The final rule changes how NHTSA will measure and evaluate ADB system illuminance. This includes an added specification for a data filter and replacing the proposed International Roughness Index parameter with an explicit adjustment for vehicle pitch.

Component-Level Laboratory Photometric Testing

The final rule retains, in modified form, the proposed requirements for component-level laboratory testing.

Defining “adaptive driving beam” as a new beam type. The final rule defines a new beam type, “adaptive driving beam.” The final rule also provides manufacturers flexibility to determine when to provide an area of reduced or unreduced intensity (subject to several requirements or constraints, such as the

¹ NHTSA is sensitive to concerns about glare due to the numerous complaints from the public it has received and its own research (prompted, in part, by these complaints and a 2005 Congressional mandate to study the risks from glare).

track test that evaluates glare). This will enable systems to provide an area of reduced intensity not only to prevent glare to oncoming or preceding vehicles, but also in other situations in which reduced intensity would be beneficial.

Requirements for areas of reduced intensity. The final rule follows the NPRM and specifies the existing lower beam photometric test points (both minima and maxima). The minima are important because the final rule does not include any “false positive” tests to ensure that an ADB system does not mistakenly dim the beam in the absence of other vehicles, and the maxima are necessary to help ensure that other motorists are not subject to glare beyond that experienced with lower beams.

Requirements for areas of unreduced intensity. The final rule follows the NPRM and specifies the existing upper beam photometric test points (both minima and maxima). Requiring a minimum level of illumination is important to ensure a minimum level of visibility. The final rule does not adopt the higher ECE upper beam maxima.

Transition zone. The final rule allows for a 1-degree transition zone between an area of reduced intensity and an area of unreduced intensity. The lower and upper beam photometric test points will not apply within a transition zone (except for the upper beam maximum at H–V, which still applies). Manufacturers essentially will be free to determine the areas of reduced and unreduced intensity and, therefore, the boundaries of the transition zone.

Other System Requirements

The final rule retains many of the proposed system requirements. However, the minimum activation speed has been decreased from 25 mph to 20 mph to give greater flexibility to manufacturers wishing to provide for hysteresis in the system design. The final rule also exempts ADB systems from many of the vehicle headlamp aiming device requirements, which would add unnecessary costs to ADB systems.

Benefits and Costs

This final rule is not significant and so was not reviewed by OMB under E.O. 12866. NHTSA has determined that quantifying the benefits and costs is not practicable in this rulemaking because of limitations on the agency’s ability to accurately estimate the target population and the effectiveness of ADB. We have, however, identified the problem this rule is intended to address, considered whether existing regulations have contributed to the problem, qualitatively assessed the costs and

benefits, and considered alternatives. This final rule appropriately balances the needs for visibility and glare prevention, and adopts requirements that are both practicable and sufficient to assess whether an ADB system operates safely. This final rule does not require manufacturers to provide ADB systems, but only specifies the requirements the systems must meet if equipped on vehicles.

II. Background and Safety Need

On October 12, 2018, NHTSA published the NPRM (83 FR 51766) underlying this final rule. NHTSA is publishing this final rule to set forth the amendments to FMVSS No. 108 (49 CFR 571.108), summarize the comments received in response to the proposal, and provide the agency’s responses to those comments.

This section provides a brief introduction to the safety needs addressed in this rulemaking, ADB technology, the relevant industry and international standards for ADB systems, the petition for rulemaking that prompted the NPRM, and related exemption petitions and NTSB recommendations. For additional detailed background information (including an explanation of the headlamp photometric requirements and regulatory history and research efforts related to glare), the reader is referred to the NPRM.²

Safety Needs: Visibility and Glare Prevention

Vehicle headlamps primarily satisfy two safety needs: Visibility and glare prevention. Headlamps illuminate the area ahead of the vehicle and provide forward visibility.³ Headlamp illumination, however, has the potential to glare other motorists. Accordingly, headlighting systems have traditionally consisted of lower beams and upper beams. The lower beams (also referred to as passing beams or dipped beams) are designed to provide relatively high levels of light in the close-in forward visibility region, and to provide reduced light intensity in longer-distance regions, where oncoming or preceding vehicles would be glared. The lower beams are intended for use during lower-speed driving or when meeting or closely following another vehicle. Upper beams (also referred to as high beams, main beams, or driving beams) are designed to provide relatively high levels of illumination in both close-in and longer distance regions. They are

intended primarily for distance illumination and for use when not meeting or closely following another vehicle. (FMVSS No. 108 establishes maximum levels of intensity the upper beam may not exceed.)

Visibility and glare are both related to motor vehicle safety. Visibility has an obvious, intuitive relation to safety: The better drivers can see the road, the better they can react to road conditions and obstacles to avoid crashes. Although the qualitative connection to safety is intuitive, quantifying the effect of visibility on crash risk is difficult because of many confounding factors (for example, was a late-night crash caused by diminished visibility or driver fatigue?). Still, evidence suggests that diminished visibility likely increases the risk of crashes, particularly crashes at higher speeds involving pedestrians, animals, trains, and parked cars.⁴ The NPRM (in Appendix A) included an analysis estimating the target population that could benefit from the increased visibility provided by ADB systems.

Glare is related to safety because it can degrade important aspects of driving performance. Glare is a sensation caused by bright light in an observer’s field of view. Headlamp illumination can glare drivers of oncoming or preceding vehicles (via the rearview or side mirrors). Empirical evidence suggests that headlamp glare decreases visibility distance, increases reaction time, and reduces detection probability, among other things.⁵ It can

⁴ Nighttime Glare and Driving Performance, Report to Congress (2007), National Highway Traffic Safety Administration, Department of Transportation [hereinafter “2007 Report to Congress”], p. 6. A 2016 study by the Insurance Institute for Highway Safety noted that “[t]wenty-nine percent of all fatalities during 2014 occurred in the dark on unlit roads. Although factors such as alcohol impairment and fatigue contributed to many of these crashes, poor visibility likely also played a role.” Ian J. Reagan, Matthew L. Brumbelow & Michael J. Flannagan. 2016. The Effects of Rural, Proximity of Other Traffic, and Roadway Curvature on High Beam Headlamp Use Rates. Insurance Institute for Highway Safety, pp. 2–3 (citations omitted). See also Michael J. Flannagan & John M. Sullivan. 2011. Feasibility of New Approaches for the Regulation of Motor Vehicle Lighting Performance. Washington, DC: National Highway Traffic Safety Administration, p. 5 (NHTSA–2018–0090–0002) (“The conclusion of our analysis was that pedestrian crashes were by far the most prevalent type of crash that could in principle be addressed by headlighting.”).

⁵ 2007 Report to Congress, pp. iv, 11–14. See also, e.g., John D. Bullough *et al.* 2003. An Investigation of Headlamp Glare: Intensity, Spectrum and Size, DOT HS 809 672. Washington, DC: U.S. Department of Transportation, National Highway Traffic Safety Administration [hereinafter “Investigation of Headlamp Glare”], p. 1. (“It is almost always the case that headlamp glare reduces visual performance under driving conditions relative to the level of performance achievable without glare.”)

² See pp. 51768–51774.

³ They also make the vehicle more visible to other road users.

also cause discomfort. Despite this evidence, it remains difficult to quantify the effect of glare on crash risk. Unlike drug or alcohol use, there is usually no way to determine precisely the amount of glare that was present in a given crash. Nevertheless, some police crash reports mention glare as a potential cause, and it is reasonable to expect that glare can reduce visibility, and reductions in visibility caused by headlamp glare increase crash risk.⁶ Discomfort attributable to glare might also indirectly affect crash risk (for example, if a driver reacts to glare by changing their direction of gaze).⁷ In addition, discomfort caused by glare may induce some drivers, particularly older drivers, to avoid driving at night or simply increase their annoyance.⁸

The potential problems associated with glare are highlighted by the thousands of complaints NHTSA has received from the public on the issue, as well as congressional interest. The introduction of halogen headlamp technology in the late 1970s and high-intensity discharge and auxiliary headlamps in the 1990s was accompanied by a marked upswing in the number of glare complaints to NHTSA. In response to increased consumer complaints in the late 1990s, NHTSA published a Request for Comments in 2001 on issues related to glare from headlamps, fog lamps, driving lamps, and auxiliary headlamps.⁹ NHTSA received more than 5,000 comments, most of which concerned nighttime glare from front-mounted lamps.¹⁰ In 2005 Congress directed DOT to study the risks of glare.¹¹ NHTSA subsequently initiated a multipronged research program to examine the causes of, and possible solutions to, glare.¹²

Adaptive Driving Beam Technology

ADB systems are an advanced type of headlamp technology that optimizes beam patterns without driver action. Semiautomatic beam switching technology was first introduced on

vehicles in the United States in the 1950s and has become increasingly popular in the last few decades with the wider deployment of camera-based driver assistance technologies. The semiautomatic beam switching technology currently available on vehicles in the United States is commonly referred to as “auto hi-beam” or “high beam assist,” among other terms. This currently-available technology automatically switches between the lower and upper beams (while still allowing the driver to manually switch beams).¹³

Semiautomatic beam switching enhances safety because it facilitates increased use of the upper beams in situations where drivers of other vehicles will not be glared. Research has shown that most drivers under-utilize the upper beams,¹⁴ despite the fact that “driving with lower-beam headlamps can result in insufficient visibility for a number of driving situations,”¹⁵ particularly at higher speeds.¹⁶

ADB systems are an improvement over the “auto hi-beam” technology currently available in the United States because they are capable of providing more illumination than a lower beam without increasing glare. When operating in automatic mode, instead of simply switching between the upper and lower beams, the ADB system is able to provide a dynamic, adaptive beam pattern that changes based on the presence of other vehicles or objects, providing less illumination to occupied areas of the road and more illumination to unoccupied areas of the road.¹⁷ The

portions of the adaptive beam directed to areas of the roadway occupied by other vehicles are at or (for some systems deployed in Europe) even below levels of a lower beam.¹⁸ The portions of the adaptive beam directed at unoccupied areas of the road are typically equivalent to an upper beam. When the roadway ahead is fully occupied by oncoming or preceding vehicles, the adaptive beam is essentially a lower beam. When there are no oncoming or preceding vehicles, the adaptive beam is essentially an upper beam.¹⁹

So, for example, when an ADB-equipped vehicle (operating in automatic mode) travelling on an otherwise unoccupied roadway encounters an oncoming vehicle, it switches from an upper beam providing high light levels in both close-in and longer distance regions to an adaptive beam providing reduced intensity (similar to a lower beam) near the oncoming vehicle and unreduced intensity (similar to an upper beam) elsewhere. Because the system is able to provide unreduced intensity to unoccupied areas of the roadway, while at the same time providing reduced intensity to areas near other vehicles, it provides more illumination than a conventional lower beam would provide. ADB therefore has the potential to reduce the risk of crashes by increasing visibility without increasing glare. The adaptive beam is particularly useful for distance illumination of pedestrians, animals, and objects in or near the road when other vehicles are present and thus preclude use of the upper beam.

ADB systems achieve this enhanced performance by utilizing advanced sensors, data processing software, and headlamp hardware (such as shutters or LED arrays). Many current ADB systems utilize a camera with a typical field of view of approximately 25 degrees left and right to detect objects.²⁰ High-resolution ADB systems are capable of classifying objects and placing optimized levels of light on all objects in the driver’s view (such as

¹³ Under FMVSS No. 108 this technology is classified as a “semiautomatic beam switching device” because it provides either automatic or manual control of switching between the lower and upper beams at the option of the driver. See S4 (definition of “semiautomatic headlamp beam switching device”) and S9.4.

¹⁴ See, e.g., John D. Bullough, Nicholas P. Skinner, Yukio Akashi, & John Van Derlofske. 2008. Investigation of Safety-Based Advanced Forward-Lighting Concepts to Reduce Glare, DOT HS 811 033. Washington, DC: National Highway Traffic Safety Administration, p. 63. (finding that “abundant evidence suggests that most drivers use lower beams primarily, if not exclusively.”) See also, e.g., Mary Lynn Mefford, Michael J. Flannagan & Scott E. Bogard. 2006. Real-World Use of High-Beam Headlamps, UMTRI–2006–11. University of Michigan, Transportation Research Institute, p. 6 (finding that “high-beam headlamp use is low . . . consistent with previous studies that used different methods”).

¹⁵ Investigation of Safety-Based Advanced Forward-Lighting Concepts to Reduce Glare (DOT HS 811 033), p. 63.

¹⁶ Michael J. Flannagan & John M. Sullivan. 2011. Preliminary Assessment of The Potential Benefits of Adaptive Driving Beams, UMTRI–2011–37. University of Michigan, Transportation Research Institute, p. 2.

¹⁷ When operating in manual mode—which the driver may obtain at any time—the driver is able to switch between the lower and upper beams.

¹⁸ SAE J3069 JUN 2016, pp. 1–2.

¹⁹ There are, however, situations in which it may be appropriate to provide less than a full upper beam even in the absence of oncoming or preceding vehicles. For example, it may be optimal to direct less light at a retroreflective sign or wet roadway, in order to minimize glare to the driver of the ADB-equipped vehicle from reflected light. This is discussed in more detail in Section VIII.D.2.

²⁰ SAE comment (NHTSA–2018–0090–0167), p. 9 (“The forward camera vision on today’s vehicles only extends to approximately 25 degrees left and right[.]”). We assume this is the camera’s field of view for the illustrative examples in the discussions of the curve scenarios.

⁶ John D. Bullough *et al.* 2008. Nighttime Glare and Driving Performance: Research Findings, DOT HS 811 043. Washington, DC: U.S. Department of Transportation, National Highway Traffic Safety Administration, p. 1–4.

⁷ *Id.*, p. 33. *But see* Investigation of Headlamp Glare, p. 3 (“Very few studies have probed the interactions between discomfort and disability glare, or indeed any driving-performance related factors . . .”).

⁸ 2007 Report to Congress, p. iv.

⁹ 66 FR 49594 (Sept. 28, 2001).

¹⁰ 69 FR 54255 (Sept. 8, 2004).

¹¹ Safe, Accountable, Flexible, Efficient Transportation Equity Act: A Legacy for Users, Public Law 109–59, Sec. 2015 (2005).

¹² For more information, see the NPRM at p. 51771.

retroreflective signs or pedestrians). ADB systems typically use the existing headlamps that are modified either with a mechanical shade that blocks part of the beam, or (for light-emitting diode [LED] headlamps) extinguish individual LEDs. The ADB systems NHTSA tested required the driver to select the ADB mode using the headlighting system control. Once in ADB mode, the systems were designed to activate the adaptive beam at speeds between 20 mph and 40 mph and deactivate the adaptive beam (and provide a lower beam) from 15 mph to 25 mph.

European ADB Requirements

ADB was first permitted in Europe by amendments to ECE Regulation No. 48 in 2006.²¹ ECE regulations allow ADB systems under the umbrella of adaptive front lighting systems (AFS). There are a variety of requirements for AFS generally and adaptive lighting in particular. Unlike the FMVSS, which rely on manufacturer self-certification, ECE requirements for ADB systems utilize the type approval framework used throughout the ECE standards. Under the type approval framework, production samples of new model cars must be approved by regulators before

being offered for sale. This approval is based, in part, on testing whole vehicles on public roadways to verify performance. The ECE requirements specify that the adaptation of the main-beam not cause any discomfort, distraction or glare to the driver of the ADB-equipped vehicle (for example, glare to the driver cause by excessive illumination of retroreflective signs) or to oncoming and preceding vehicles. This is demonstrated through the technical service performing a test drive on various types of roads (e.g., urban, multi-lane roads, and country roads), at a variety of speeds, and in a variety of specified traffic conditions. The performance of the ADB system is evaluated based on the subjective observations of the type approval engineer during this test drive. The ECE road test is therefore not appropriate for adoption as an FMVSS because it does not provide objective performance criteria. However, the proposed track test scenarios were based, in part, on the ECE road-test scenarios.

SAE J3069

In June 2016, SAE International (SAE) published SAE J3069 JUN2016, Surface Vehicle Recommended Practice;

Adaptive Driving Beam (SAE J3069).²² The recommended practice, which is based, in part, on NHTSA's research (described in Section VII below), includes (among other requirements) a track test to evaluate ADB system performance in avoiding excessive glare to other vehicles. It specifies a straight test path with a single lane, on either side of which it specifies the placement of test fixtures simulating an opposing or preceding vehicle. See Figure 1. The test fixtures are fitted with lamps having a specified luminous intensity, color, and size intended to simulate the taillamps and headlamps on a typical car, truck, or motorcycle. Four different test fixtures are specified: An opposing (i.e., oncoming) car/truck; an opposing motorcycle; a preceding car/truck; and a preceding motorcycle. In addition to simulated vehicle lighting, the test fixtures are fitted with photometers²³ to measure the illumination from the ADB headlamps. Although the test does not specify any scenarios with a curved test path, the placement of the fixtures relative to the straight test path, along with a sudden appearance test, are intended to simulate curves.

Figure 1 – SAE test fixture positions

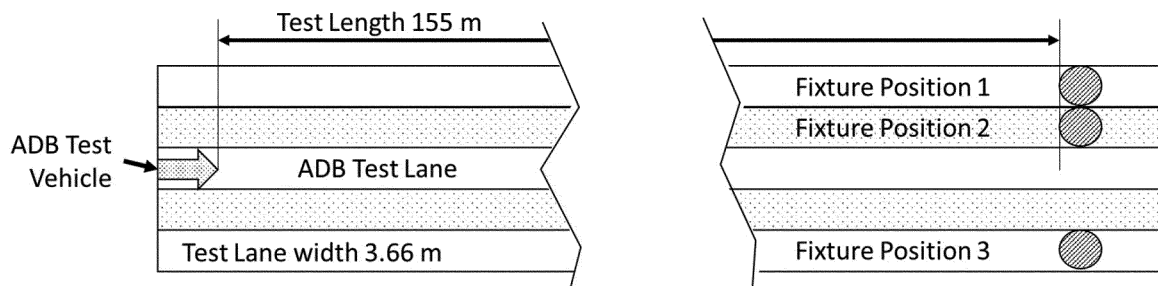

SAE J3069 sets out a total of 18 different test drive scenarios. The scenarios vary the test fixture, the placement of the fixture, and whether the lamps on the test fixture are illuminated for the entire test drive, or are instead suddenly illuminated when the ADB vehicle reaches a specified distance from the test fixture. During each of these test drives, the

illuminance²⁴ recorded at 30 meters (m), 60 m, 120 m, and 155 m must not exceed the maximum allowed illuminance specified for each distance. See Table 1. These illuminance maxima are based on and similar (but not identical) to the maximum illuminance limits developed in NHTSA's published research and proposed in the NPRM. If there is no recorded illuminance value

at any of these distances, interpolation is used to estimate the illuminance at that distance. For sudden appearance tests, the system is given a maximum of 2.5 seconds to react and adjust the beam to reduce illuminance to a level within the applicable maximum. If any recorded (or interpolated) illuminance value exceeds the applicable maximum illuminance, SAE J3069 provides for an

²¹ Uniform provisions concerning the approval of vehicles with regard to the installation of lighting and light-signalling devices (R48) and Regulation No. 123, Uniform provisions concerning the approval of adaptive front-lighting systems (AFS) for motor vehicles (R123) of the Economic Commission for Europe (ECE).

²² SAE has recently published a revised version of this recommended practice (SAE J3069 MAR2021). These limited revisions, where potentially relevant to this final rule, are identified and discussed in subsequent sections of this preamble.

²³ A photometer, or illuminance meter, is an instrument that measures light.

²⁴ Illuminance is the amount of light falling on a surface. The unit of measurement for illuminance is lux.

allowance: The same test drive scenario is run with the lower beam activated. The ADB system can still be deemed to have passed the test if any of the ADB exceedances do not exceed 125% of the measured (or interpolated) illuminance value(s) for the lower beam.

TABLE 1—SAE J3069 MAXIMUM ALLOWED ILLUMINANCE

Range from headlamp to photometer (m)	Maximum illuminance, oncoming (lux)	Maximum illuminance, preceding (lux)
30	1.8	18.9
60	0.7	8.9
120	0.3	4.0
155	0.3	4.0

In addition to the dynamic track test, SAE J3069 contains a number of other system requirements, such as a physical test (e.g., a corrosion test) and telltale requirements. It also requires the system to comply with a limited set of component-level laboratory-based photometry requirements. For example, for the portion of the adaptive beam that is directed at areas of the roadway unoccupied by other vehicles, the lower beam minimum values specified in the relevant SAE standard must be met.²⁵ Specific provisions of SAE J3069 are discussed in more detail in the responses to the comments.

Toyota Petition for Rulemaking, ADB Exemption Petitions, and NTSB Recommendation

While ADB systems have been available in Europe for a number of years, they have not yet been deployed in the United States, largely because of industry uncertainty about whether FMVSS No. 108 allows ADB systems.²⁶ Prior to the NPRM, NHTSA had not formally addressed whether the lighting standard allows ADB systems. Accordingly, in 2013, Toyota Motor North America, Inc. (Toyota) petitioned NHTSA for rulemaking to amend FMVSS No. 108 to give manufacturers the option of equipping vehicles with ADB systems.²⁷ In its petition, Toyota described how its system works,

²⁵ As explained in the NPRM, FMVSS No. 108 also contains laboratory-based photometric requirements. SAE J3069 refers not to these requirements, but to analogous requirements specified in other SAE standards.

²⁶ See, e.g., SAE J3069 (“However, in the United States it is unclear how ADB would be treated under the current Federal Motor Vehicle Safety Standard (FMVSS) 108.”).

²⁷ Letter from Tom Stricker, Toyota Motor North America, Inc. to NHTSA (Mar. 29, 2013). Toyota requested confidential treatment for portions of its submission. A redacted copy of the petition has been placed in the docket for this rulemaking.

identified potential safety benefits of the system, and discussed its view of how ADB should be treated under the agency’s regulations. NHTSA granted Toyota’s petition and the NPRM was NHTSA’s action on that grant.

After receiving Toyota’s petition, but prior to the NPRM, NHTSA received two exemption petitions (under 49 CFR part 555) for ADB-equipped vehicles. In 2016, Volkswagen Group of America (Volkswagen) submitted a petition for a temporary exemption from some of the requirements of FMVSS No. 108 to sell a limited number of ADB-equipped vehicles. NHTSA published a notice of receipt of this petition on September 11, 2017, and provided a 30-day comment period.²⁸ BMW of North America, LLC (BMW) subsequently submitted a similar petition, dated October 27, 2017. On March 22, 2018, NHTSA published a notice of receipt of the BMW petition and requested additional information from both petitioners.²⁹ Both Volkswagen and BMW subsequently submitted additional information to the docket. Prior to today, NHTSA has not made a decision on either petition; as we explain later in the preamble, NHTSA is denying the petitions in a separate notice published today.

Shortly before the NPRM was published in October 2018, the National Transportation Safety Board (NTSB) published a special investigation report that examined pedestrian crashes and related phenomena.³⁰ The report covered, among other things, vehicle headlighting system performance. The NTSB found that the FMVSS should not limit advanced vehicle lighting systems that have been shown to have safety benefits. It also found that vehicle headlighting systems require an evaluation that is more advanced than laboratory bench-testing. The report went on to recommend that NHTSA revise FMVSS No. 108 to allow adaptive headlight systems. This final rule responds to these NTSB recommendations.

III. NHTSA’s Statutory Authority

NHTSA is issuing this final rule under the Motor Vehicle Safety Act (Safety Act), 49 U.S.C. Chapter 301, Motor Vehicle Safety (49 U.S.C. 30101 *et seq.*). Under the Safety Act, the Secretary of Transportation is responsible for prescribing motor vehicle safety standards that are practicable, meet the need for motor

vehicle safety, and are stated in objective terms.³¹ “Motor vehicle safety” is defined in the Safety Act as “the performance of a motor vehicle or motor vehicle equipment in a way that protects the public against unreasonable risk of accidents occurring because of the design, construction, or performance of a motor vehicle, and against unreasonable risk of death or injury in an accident, and includes nonoperational safety of a motor vehicle.”³² “Motor vehicle safety standard” means a minimum performance standard for motor vehicles or motor vehicle equipment.³³ When prescribing such standards, the Secretary must consider all relevant, available motor vehicle safety information.³⁴ The Secretary must also consider whether a proposed standard is reasonable, practicable, and appropriate for the types of motor vehicles or motor vehicle equipment for which it is prescribed and the extent to which the standard will further the statutory purpose of reducing traffic accidents and associated deaths.³⁵ The responsibility for promulgation of Federal Motor Vehicle Safety Standards is delegated to NHTSA.³⁶ The agency carefully considered these statutory requirements in developing this final rule. We evaluate this rule with respect to these requirements in subsequent sections of this preamble.

IV. ADB Rulemaking Mandate in the Infrastructure, Investment and Jobs Act

Congress has recently passed, and the President has signed, the Infrastructure, Investment and Jobs Act (“IIJA”).³⁷ Section 24212 of IJA contains a mandate for a variety of headlamp rulemakings, including an ADB rulemaking. Specifically, IJA requires in paragraph (b) of § 24212 that “[n]ot later than 2 years after the date of enactment of this Act, the Secretary shall issue a final rule amending Standard 108” to, among other things, “allow for the use on vehicles of adaptive driving beam headlamp systems.” Paragraph (a) of § 24212 defines “adaptive driving beam headlamp” to mean a headlamp “that meets the performance requirements specified in SAE International Standard J3069, published on June 30, 2016.” Paragraph (c) of § 24212 states that “[n]othing in this section precludes the

³¹ 49 U.S.C. 30111(a).

³² 49 U.S.C. 30102(a)(9).

³³ 30102(a)(10).

³⁴ 30111(b)(1).

³⁵ 30111(b)(3)–(4).

³⁶ See 49 CFR 1.95.

³⁷ H.R. 3684 (117th Congress) (2021).

²⁸ 82 FR 42720 (Docket No. NHTSA–2017–0018).

²⁹ 83 FR 12650 (Docket No. NHTSA–2017–0018).

³⁰ National Transportation Safety Board. 2018. Pedestrian Safety. Special Investigation Report NTSB/SIR–18/03. Washington, DC.

Secretary from—. . . (2) revising Standard 108 to reflect an updated version of SAE International Standard J3069, as the Secretary determines to be—(A) appropriate; and (B) in accordance with section 30111 of [the Safety Act].” Today’s final rule satisfies both that ADB mandate and the core Safety Act requirement that FMVSSs, among other things, “meet the need for motor vehicle safety,”³⁸ which, as explained throughout this notice, would not be met by a standard that solely codified SAE J3069.

Paragraphs (a) and (b) of § 24212, taken together, instruct NHTSA to amend FMVSS No. 108 to allow ADB systems that at least meet the requirements of SAE J3069. Paragraph (b) instructs NHTSA to “amend[] Standard 108.” Standard 108 is an FMVSS, and FMVSSs are subject to the criteria in § 30111 of the Safety Act, which include, importantly, meeting the need for motor vehicle safety. The directive to “amend[] Standard 108” in paragraph (b) would conflict with the specification of SAE J3069 in paragraph (a) if SAE J3069 did not meet the need for safety and NHTSA were limited to allowing any systems that met that standard. We also do not believe § 24212 means that Congress determined that SAE J3069 satisfies § 30111, as the codified text does not express this conclusion nor is there such a finding elsewhere in the IJJA statute or legislative history. Therefore, reading paragraphs (a) and (b) as requiring NHTSA to amend FMVSS No. 108 so that ADB systems that meet SAE J3069 can also meet the requirements of the revised Standard 108 harmonizes the directive in paragraph (b) to “amend[] Standard 108” with the specification of SAE J3069 in paragraph (a). It also harmonizes with the Safety Act, as well as with the National Technology Transfer and Advancement Act,³⁹ which, while generally requiring the use of consensus standards, importantly reserves to an agency the ability to decline using a consensus standard that it determines does not meet the agency’s governing statutes.

As the Supreme Court has explained, statutes should be construed harmoniously, so that “when two statutes are capable of coexistence,” they should be construed as each having effect.⁴⁰ The interpretation taken in this

final rule achieves that goal. In contrast, an interpretation that would require NHTSA to amend the standard to permit any ADB system conforming to SAE J3069 would be an implicit repeal of the Safety Act in this instance—and there is a strong presumption against implied repeals.⁴¹ As the Supreme Court has repeatedly pointed out, “repeals by implication are not favored and will not be presumed unless the intention of the legislature to repeal is clear and manifest.”⁴² Due to this “relatively stringent standard,” implied repeals are “rare,”⁴³ and have generally been limited to situations “where provisions in two statutes are in irreconcilable conflict, or where the latter Act covers the whole subject of the earlier one and is clearly intended as a substitute.”⁴⁴ But “in either case, the intention of the legislature to repeal must be clear and manifest.”⁴⁵ Here, Congress has shown no such manifest intention in § 24212. In particular, as NHTSA had already published an NPRM tentatively determining that SAE J3069 does not meet the need for safety, the Agency expects that a Congressional override of

intention to the contrary, to regard each as effective.”) (quotations and citations omitted).

⁴¹ See Norman J. Singer & Shambie Singer, 2B Sutherland Statutory Construction § 51:2 (7th ed.) (“Courts assume that a legislature always has in mind previous statutes relating to the same subject when it enacts a new provision. In the absence of any express repeal or amendment, the new provision is presumed to accord with the legislative policy embodied in those prior statutes[.]”). See also, e.g., *U.S. v. City of New York*, 359 F.3d 83, 98 (2nd Cir. 2004) (“The courts are not at liberty to pick and choose among congressional enactments, and when two statutes are capable of co-existence, it is the duty of the courts, absent a clearly expressed congressional intention to the contrary, to regard each as effective.”) (citations and quotations omitted).

⁴² *Nat’l Ass’n of Home Builders v. Defenders of Wildlife*, 551 U.S. 644, 662 (2007) (quotations, alterations, and citations omitted). See also, e.g., *Branch v. Smith*, 538 U.S. 254, 273 (2003) (“We have repeatedly stated, however, that absent a clearly expressed congressional intention, repeals by implication are not favored[.]”) (citations and quotations omitted); *Athey v. U.S.*, 123 Fed. Cl. 42, 52 (2015) (“[T]he law is clear that repeals by implication are not favored absent clear congressional intent[.]”) (quotations and citations omitted).

⁴³ *J.E.M. AG Supply, Inc.*, 534 U.S. at 142.

⁴⁴ *Branch*, 538 U.S. at 273 (citations and quotations omitted). See also, e.g., *Carcieri v. Salazar*, 555 U.S. 379, 395 (2009) (same); *Nat’l Ass’n of Home Builders*, 551 U.S. at 662 (“We will not infer a statutory repeal unless the later statute expressly contradict[s] the original act or unless such a construction is absolutely necessary . . . in order that [the] words [of the later statute] shall have any meaning at all.”) (quotations and citations omitted, alterations in original); *J.E.M. AG Supply, Inc.*, 534 U.S. at 142–43 (“The only permissible justification for a repeal by implication is when the earlier and later statutes are irreconcilable.”).

⁴⁵ *Radzanower v. Touche Ross & Co.*, 426 U.S. 148, 154 (1976). See also *N.Y. Republican State Comm. v. SEC*, 927 F.3d 499, 507 (D.C. Cir.2019) (quoting *Radzanower*).

this tentative determination would have been far clearer, given NHTSA’s general authority and role in determining that adequate level of safety. Moreover, neither of the two categories of repeal by implication apply here because there is a way to harmonize § 24212 and the Safety Act, and § 24212 does not “cover the whole subject matter” of the Safety Act and is not clearly intended as a substitute. Therefore, we read paragraphs (a) and (b) to permit NHTSA to amend FMVSS No. 108 to impose requirements more stringent than SAE J3069 as long as those requirements are not inconsistent with SAE J3069.

Next, we do not believe the specific mention of § 30111 in paragraph (c), and the absence of such an explicit reference to § 30111 in paragraphs (a) or (b), should be read to suggest that Congress intended the § 30111 criteria to apply *only* to subsequent revisions of FMVSS No. 108 (*i.e.*, amendments to FMVSS No. 108 after NHTSA completes the ADB rulemaking mandated in paragraph (b)). The Agency acknowledges that, when Congress includes particular language in one section of a statute and omits it in another section of that statute, one canon of statutory construction (sometimes referred to as *expressio unius est exclusio alterius*) holds that Congress acts intentionally and purposely in the disparate inclusion or exclusion.⁴⁶ However, to begin with, this canon is not clearly applicable here because paragraph (b) directs the agency to “amend[]” “Standard 108.” Because an FMVSS is required to meet the § 30111 criteria, paragraph (b) implicitly references § 30111, including, among other things, the requirement that the standard meet the need for safety.

Moreover, to construe the reference to § 30111 in paragraph (c) and the omission of such an explicit reference in paragraph (b) as implying that the omission in (b) was intentional and evinced a Congressional intent that the Safety Act not apply to the ADB rulemaking would be to read paragraph (c) as implicitly repealing the Safety Act in this instance. Courts have recognized that it is especially inappropriate to apply the *expressio* canon when its application would result in an implied repeal, explaining “when one possible

⁴⁶ See, e.g., *Cheney Railroad Co., Inc. v. ICC*, 902 F.2d 66, 68 (D.C. Cir. 1990) (“[E]xplicit direction for something in one provision, and its absence in a parallel provision, implies an intent to negate it in the second context.”) (quotations and citations omitted). *But see, e.g., Carter v. Office of Workers’ Comp. Programs*, 751 F.2d 1398 (D.C. Cir. 1985) (“That maxim has force, however, only when there is no apparent reason for the inclusion of one disposition and the omission of a parallel disposition except the desire to achieve disparate results”).

³⁸ 49 U.S.C. 30111(a).

³⁹ Public Law 104–113, 110 Stat. 775 (1996). See Section X, Rulemaking Analyses and Notices.

⁴⁰ *J.E.M. AG Supply, Inc. v. Pioneer Hi-Bred Int’l, Inc.*, 534 U.S. 124, 143–144 (2001) (“[W]hen two statutes are capable of coexistence, it is the duty of the courts, absent a clearly expressed congressional

interpretation of a statutory provision has the potential to render another provision inert. . . . the canon's relevance and applicability must be assessed within the context of the entire statutory framework."⁴⁷ Accordingly, "the canon is a poor indicator of Congress' intent" when "countervailed by a broad grant of authority contained within the same statutory scheme."⁴⁸ A negative inference, therefore, should only be drawn if there is an "unambiguous suggest[ion that] Congress intended to strip" an agency of its countervailing "broad grant of authority."⁴⁹ As we have discussed above, such an intent is not present here. Further, it would not make sense to say that § 30111 applies to revisions to the 2016 version of SAE J3069 but not to the 2016 version itself. And it would be odd to view paragraph (c) as a limitation on agency authority when it expressly reserves agency authority. We therefore conclude that paragraph (c) should not be read to preclude NHTSA from issuing a final rule that imposes requirements beyond SAE J3069 if the agency concludes that SAE J3069 does not meet the need for safety under the Safety Act.

In addition, we are unaware of any instances in which Congress required NHTSA to issue or amend an FMVSS to enact or incorporate by reference a consensus standard without reference to the § 30111 criteria. The closest precedent of which we are aware is that the 1966 Safety Act directed NHTSA's predecessor agency to issue initial FMVSS "based on existing safety standards."⁵⁰ Those "existing standards" "were understood to be the [General Services Administration] standards then in effect for government

vehicles."⁵¹ However, the initial standards were not required to be identical to those "existing standards," only to be "based on" them; consistent with this, the initial FMVSS did not simply copy existing standards.⁵² Moreover, the 1966 Act went on to direct that, after issuing the initial FMVSS, the agency "shall issue new and revised Federal motor vehicle safety standards under this title" within two years from the enactment of the Act.⁵³ This shows, if anything, a general Congressional preference for providing NHTSA with at least some discretion over the content of the standards.

Today's final rule is therefore consistent with the § 24212 mandate. The rule amends FMVSS No. 108 to allow for the use of ADB systems. While NHTSA has modified the proposal to follow SAE J3069 more closely where warranted, the final rule includes some requirements (such as test scenarios) not included in SAE J3069. NHTSA has concluded that these deviations from SAE J3069 are—pursuant to the Safety Act—necessary for the final rule to meet the need for motor vehicle safety, because SAE J3069 does not adequately address the safety needs of visibility and glare prevention. The final rule, however, does not conflict with ADB systems that meet the performance requirements of SAE J3069 because a headlamp designed to comply with NHTSA's final rule can also be designed to conform with SAE J3069. The differences between the final rule and SAE J3069, as well as our test data on the performance of ADB systems tested to both the final rule and J3069 are described in detail throughout this preamble.

V. Summary of the NPRM

Proposed Requirements and Test Procedures

NHTSA tentatively concluded that because ADB technology has the potential to provide safety benefits in preventing collisions with pedestrians,

animals, and roadside objects—while not increasing glare—FMVSS No. 108 should be amended to permit it.

NHTSA further tentatively concluded that to ensure ADB systems operate safely, the standard should be amended to include additional requirements specific to ADB systems. The existing headlamp requirements (including the requirements for semiautomatic beam switching devices) have two features that make them ill-suited to evaluate ADB performance. First, they are component-level requirements that involve testing the performance of an individual headlamp in a laboratory; they do not evaluate the performance of the headlamp system on the vehicle as it is driven on the road, which is particularly important for ADB because it adapts to roadway conditions. Second, the preexisting semiautomatic beam switching device requirements are only related to which of two beams (upper or lower) are appropriate. They do not contemplate an adaptive beam that is capable of dynamically producing many different beam patterns in response to vehicles and other object in the road. For example, the sensitivity test for semiautomatic beam switching devices currently tests the ability of the device to switch between a lower and upper beam when exposed to a light source in a controlled laboratory setting.

These requirements would accordingly not evaluate the performance of an ADB system as it adapts the beam when driven on an actual road in the presence of other vehicles. In particular, because ADB systems use relatively new technology to dynamically change the beam to accommodate the presence of other vehicles, they have the potential—if not designed otherwise—to glare other motorists. This could create safety risks for those other motorists. We therefore proposed amending the standard to include vehicle-level track-tested requirements specifically tailored to evaluate whether an ADB system functions safely and limits glare for other motorists. We also proposed a set of component-level laboratory-tested requirements to ensure that ADB systems always provide adequate visibility; some of these requirements were also related to glare. Below, we briefly summarize the proposed requirements. For additional information and detail, the reader is referred to the NPRM.⁵⁴

⁴⁷ *Adirondack Med. Ctr. v. Sebelius*, 740 F.3d 692, 697 (D.C. Cir. 2014).

⁴⁸ *Id.*

⁴⁹ *Id.* at 697–698. See also *id.* at 697 ("The *expressio unius* canon is a feeble helper in an administrative setting, where Congress is presumed to have left to reasonable agency discretion questions that it has not directly resolved. . . . The dizzying array of other canons that could shift the analysis one way or another—e.g., . . . the presumption against implied repeals, militates against finding unambiguous congressional intent here") (quotations and citations omitted). See also, e.g., *Cheney Railroad Co., Inc.* at 69–69 (same); *U.S. v. City of New York*, 359 F.3d 83, 98 (2nd. Cir. 2004) ("[S]ince not every silence is pregnant, *expressio unius* is an uncertain guide to interpretation.") (quotations and citations omitted).

⁵⁰ National Traffic and Motor Vehicle Safety Act of 1966, Public Law 89–563, 103(h) (1966) ("The Secretary shall issue initial Federal motor vehicle safety standards based upon existing safety standards on or before January 31, 1967. On or before January 31, 1968, the Secretary shall issue new and revised Federal motor vehicle safety standards under this title.")

⁵¹ Jerry L. Mashaw & David L. Harfst, *From Command And Control To Collaboration And Deference: The Transformation Of Auto Safety Regulation*, 34 Yale J. on Reg. 167, 199 n. 106 (2017).

⁵² See, e.g., 32 FR 10812 (July 22, 1967) (NPRM for initial FMVSS 109) ("In drafting these proposed standards, the Bureau considered the comments received in response to the Advance Notice of Proposed Rule Making published in the **Federal Register** on February 3, 1967 (32 FR. 2417) and consultation with the National Motor Vehicle Safety Advisory Council and with representatives of the Federal Trade Commission, the General Services Administration, the National Bureau of Standards, and tire and auto industry associations, both domestic and foreign.")

⁵³ National Traffic and Motor Vehicle Safety Act of 1966, Public Law 89–563, 103(h) (1966).

⁵⁴ See pp. 51777–51789.

Vehicle-Level Track Test To Evaluate Glare

The centerpiece of the proposal was a vehicle-level track test to evaluate ADB performance in recognizing and limiting glaring for other vehicles. We proposed evaluating the performance of an ADB-equipped vehicle (test vehicle) in a variety of different types of interactions with either an oncoming or preceding vehicle (referred to as a “stimulus” vehicle because it stimulates a response from the ADB system). The stimulus vehicle would be equipped with sensors near the driver’s eyes (or rearview

mirrors) to measure the illuminance from the ADB headlamps. The illuminance falling on the stimulus vehicle would be measured and recorded throughout the test run.

To evaluate ADB performance, we proposed a set of maximum allowed illuminance values (glare limits). These are numeric illuminance values that would be the maximum illuminance the ADB system would be permitted to cast on the stimulus vehicle during the track test. See Table 2. We proposed sampling illuminance values throughout the proposed measurement ranges (also referred to in this document as

measurement distances). The proposed compliance criterion was that any recorded illuminance value greater than the applicable glare limit would be considered a test failure, except that values above the applicable glare limit lasting no longer than 0.1 second(s) or over a distance of no longer than 1 m would not be considered test failures. This adjustment was intended to allow for electric noise in the photometers (*i.e.*, any electrical signal whose source is not a result of changes in illuminance) as well as momentary changes in vehicle pitch.

TABLE 2—PROPOSED MAXIMUM ILLUMINANCE CRITERIA

Measurement distance (m)	Maximum illuminance oncoming direction (lux)	Maximum illuminance same direction (lux)
15.0 to 29.9	3.1	18.9
30.0 to 59.9	1.8	18.9
60.0 to 119.9	0.6	4.0
120.0 to 220	0.3	N/A

The proposal specified a broad set of potential stimulus vehicles. We proposed using any FMVSS-certified vehicle from the five model years preceding the model year of the test vehicle, subject to a specified height constraint that was intended to exclude unusually high- or low-riding vehicles.

We proposed a variety of scenarios to dynamically assess ADB system performance. We proposed three basic maneuvers for testing compliance: oncoming (where the test and stimulus vehicles approach each other traveling in opposite directions); same direction/same lane (where the stimulus vehicle precedes the test vehicle in the same lane); and same direction/passing with one vehicle (either the stimulus or test vehicle) traveling faster than and overtaking the other vehicle. We also proposed scenarios where the stimulus vehicle was stationary.

We proposed to test each type of maneuver at various test and stimulus vehicle speeds (from 0 to 70 mph) on both a straight test path and on left and right curves of varying radii: A “short” curve (with radii from 98 m to 116 m), a “medium” curve (223 m to 241 m), and a “large” curve (335 m to 396 m). The proposal also included a variety of related test procedures and conditions, such as adjusting for ambient light, the condition of the road surface, and the number of lanes. The proposed glare limits and test procedures were based on extensive agency research and testing.⁵⁵

Component-Level Laboratory Photometric Testing

The NPRM also proposed component-level laboratory-tested headlamp photometry requirements for the adaptive beams. We proposed to require that the part of the adaptive driving beam that is cast near other vehicles (the area of reduced intensity) must conform to the Table XIX lower beam photometry requirements (*i.e.*, maxima and minima). We similarly proposed that the part of the adaptive beam cast onto areas of the roadway not occupied by other vehicles (area of unreduced intensity) conform with the Table XVIII upper beam photometric maxima and minima.⁵⁶ These proposed requirements were intended to act as a complement to the track test in ensuring other motorists were not glared (the photometric maxima) and to ensure a minimum level of visibility (the photometric minima), an aspect not evaluated in the track test.

Other System Requirements

The standard has long specified a variety of requirements specifically for semiautomatic beam switching devices (in S9.4.1 and S14.9.3.11). The proposal extended some but not all of these requirements to ADB systems.

The proposal extended the existing requirements for manual override, fail-

safe operation (*i.e.*, a failure of the automatic control portion of the device must not result in loss of manual beam switching control), and an automatic dimming indicator.⁵⁷

The proposal did not extend the existing semiautomatic beam switching device requirements for lens accessibility or mounting height. It also did not extend any of the existing physical test requirements to ADB systems.⁵⁸ These include the sensitivity test mentioned above, as well as tests such as a corrosion test and a temperature test. We proposed not subjecting ADB systems to these requirements for two reasons. First, as noted above, those requirements date from the 1960s and, accordingly, many of them (such as the sensitivity test) do not usefully extend to modern ADB technologies. Second, we tentatively believed that market forces would ensure an ADB system’s switching device will operate robustly with respect to environmental conditions.

We also proposed additional requirements for ADB systems that are not currently required for semiautomatic beam switching devices. This included requirements related to fault detection and a requirement that the ADB system must produce a lower beam at speeds below 25 mph.

Regulatory Alternatives

The NPRM identified two main alternatives to the proposed

⁵⁶ While the NPRM used the terms “dimmed area” and “undimmed area,” this document and the final regulatory text use the terms “area of reduced intensity” and “area of unreduced intensity” to more closely follow the terminology in SAE J3069.

⁵⁷ S9.4.1.

⁵⁸ S14.9.3.11.

⁵⁵ See Section VII, NHTSA Research and Testing.

requirements and test procedures: the ECE ADB requirements and SAE J3069. As noted earlier, however, the ECE requirements are not sufficiently objective to be incorporated into an FMVSS. Accordingly, the main regulatory alternative we considered was SAE J3069.

The proposal followed SAE J3069 in many respects but deviated from it in several significant ways. These differences are briefly discussed below and summarized in Table 3. The proposal identified the deviations from SAE J3069 and provided a tentative justification for those deviations. The proposal sought comment on the relative merits of the proposal and SAE J3069 in all of these respects.

Vehicle-level track test to evaluate glare. Both the proposal and SAE J3069 specified a vehicle-level track test to

evaluate glare. The proposed glare limits were essentially identical to the glare limits in SAE J3069. The proposed track test, however, significantly differed from the SAE standard in four main ways: it utilized actual stimulus vehicles, not test fixtures; it proposed actual curves, not simulated curves; it included a large set of test scenarios, including scenarios with a moving stimulus vehicle, and complex vehicle maneuvers (e.g., passing scenarios); and, finally, it specified different data measurement and allowance procedures.

Component-level laboratory photometric testing. The proposal applied more of the current component-level photometric requirements to the ADB system to regulate both glare and visibility. With respect to glare, while we proposed to require that the area of

reduced intensity not exceed the current lower beam maxima, and the area of unreduced intensity not exceed the current upper beam maxima, SAE J3069 requires only the former. With respect to visibility, we proposed that the area of reduced intensity meet the lower beam minima and the area of unreduced intensity meet the upper beam minima; SAE J3069 only specifies the lower beam minima for the area of unreduced intensity.

Other system requirements. The proposed telltale and malfunction requirements were similar to the requirements in SAE J3069. The proposal mainly differed from SAE J3069 in specifying a minimum activation speed, and in not applying any physical test requirements to ADB systems.

TABLE 3—SUMMARY OF MAJOR DIFFERENCES BETWEEN THE NPRM AND SAE J3069

Test elements	NPRM	SAE J3069
<i>Vehicle-level track test to evaluate glare:</i>		
Stimulus	Broad range of stimulus vehicles	Test fixtures.
Test track geometry	Specifies actual curves of various sizes	Specifies a straight path and uses fixture placement to simulates curves.
Test scenarios	Specified scenarios with moving and stationary stimulus vehicles and a variety of road geometries.	Specified smaller set of less complex scenarios.
Data measurement and glare limit applicability.	Applies the glare limits throughout the measurement range specified for each scenario.	Applies the glare limits only at 30 m, 60 m, 120 m, and 155 m.
Compliance criteria	Sampling rate of at least 200 Hz	Sampling rate of at least 10 Hz.
	Specified allowance for momentary glare exceedances.	Allows measured illuminance to exceed an applicable glare limit if it does not exceed 125% of the lower beam illuminance under the same conditions.
<i>Component-level laboratory test:</i>		
Area of reduced intensity	Specified lower beam (Table XIX) minima and maxima.	Specifies lower beam maxima.
Area of unreduced intensity	Specified upper beam (Table XVIII) minima and maxima.	Specifies lower beam minima.
Minimum activation speed	25 mph	Not specified.

VI. Overview of Comments

NHTSA received 217 comments on the proposal. This included comments from 32 vehicle and equipment manufacturers, industry groups,⁵⁹ and test laboratories, as well as 5 comments from public interest groups. We also received comments from 19 owner/operators of drive-in movie theatres, including the United Drive-In Theatre Owners Association. The balance of the comments was from individual

members of the public. An index of comments cited in this preamble along with the comment identification numbers is provided in Appendix D.

All industry and public-interest commenters supported amending the standard to allow the introduction of ADB systems. A majority of the industry commenters and the Competitive Enterprise Institute (CEI) strongly supported closer harmonization with SAE J3069 (or with the ECE requirements).⁶⁰ These comments focused primarily on costs from disharmonization due to the resulting

need for market-specific hardware, components, and/or software. Several commenters argued that the increased costs associated with the proposal would increase consumer costs and hinder ADB adoption and the concomitant safety benefits. Several industry commenters and the Insurance Institute for Highway Safety (IIHS) stated that the proposal did not maximize overall benefits because it prioritized glare prevention over enhanced visibility, and opined that the final rule should place greater weight on the benefits associated with enhanced visibility.

Drive-in theatre owner/operators stressed the importance of the ADB system providing a means for manual headlamp control. Many indicated some level of support for the rule (assuming

⁵⁹Global Automakers and the Alliance of Automobile Manufacturers each commented during the comment period. After the comment period had ended, they merged to form the Alliance for Automotive Innovation. The Alliance for Automotive Innovation subsequently commented on this rulemaking. Comments from each of these three entities are summarized and identified by reference to the entity that submitted the comment.

⁶⁰SAE, on behalf of the SAE lighting systems group (which developed SAE J3069) submitted a detailed comment that touched on harmonization as well as a variety of other issues. A majority of industry commenters explicitly supported SAE's comments.

it provides for manual control). The majority of comments from individual members of the public supported the proposal, often on the grounds that it would likely reduce glare or increase safety. A number of these commenters noted the availability of this technology in Europe. Several individuals who opposed the proposal thought that it would increase glare.

With respect to specific aspects of the proposal, while most industry and public-interest groups supported a track test, many of these commenters argued that the specific track test in the proposal was impracticable and excessively burdensome, especially with respect to the number and complexity of test scenarios and the use of stimulus vehicles instead of fixtures. These commenters especially focused on the broad set of proposed stimulus vehicles. Some industry commenters also raised concerns with the objectivity and repeatability of the test procedure. Many industry commenters also opposed the use of a curved test path; they recommended that curved test paths be simulated with the placement of test fixtures relative to a straight test path. Many of these commenters also stated that the final rule should provide less stringent compliance criteria and provide a greater allowance for illuminance levels above the proposed glare limits (for example, by evaluating the ratio of ADB illuminance to lower beam illuminance or allowing additional time for an ADB system to react to the test stimulus). Industry commenters also raised issues about other aspects of the test procedures, such as data filtering and vehicle pitch.

The agency also received comments about the proposed component-level laboratory test requirements. A few industry commenters (including SAE) contended that component-level testing is unnecessary, while some industry members and public-interest groups supported aspects of the laboratory test requirements. Many industry commenters pointed out the need for a transition zone between areas of reduced and unreduced intensity. Multiple industry commenters and some public-interest commenters recommended not requiring the lower beam minima in areas of reduced intensity in order to realize the full glare-reducing potential of ADB technology. Several industry commenters also suggested specifying the lower beam minima, not the upper beam minima, in areas of unreduced intensity. Some industry and public-interest commenters supported increasing the maxima in an area of unreduced intensity to the higher level

allowed in Europe. Several industry commenters requested NHTSA clarify certain terms in the regulatory text.

We also received comments about other system requirements, including the minimum ADB activation speed, operator controls, telltales, and headlamp mounting requirements.

VII. NHTSA Research and Testing

Research Before the NPRM

Two NHTSA research studies formed the basis for the NPRM. (This research was necessary because, among other things, the current photometry requirements are laboratory-tested component-level requirements, not vehicle-level requirements tested on a track.) In 2012, the agency published a study (Feasibility Study)⁶¹ exploring the feasibility of new approaches to regulating vehicle lighting performance, including headlamp photometry. Among other things, the study presented vehicle-based headlamp photometry requirements derived from the current component-level photometry requirements in Tables XVIII (upper beam) and XIX (lower beam). This included vehicle-based photometry requirements to ensure that other vehicles are not glared. NHTSA then built on this effort by developing a vehicle-level track test to evaluate whether an ADB system conforms with the derived photometry requirements for glare prevention (2015 ADB Test Report).⁶² For more information on this research, the reader is referred to the NPRM⁶³ and the docketed research reports.

Research After the NPRM

After reviewing the comments on the NPRM, NHTSA explored opportunities to modify the proposal to resemble SAE J3069 more closely, while at the same time retaining a sufficient degree of realism the agency believes the SAE standard lacks. Most significantly, NHTSA explored using stationary test fixtures instead of dynamic stimulus vehicles. NHTSA developed and fabricated test fixtures that were similar to the fixtures specified in SAE J3069 but differed in some important respects

⁶¹ Michael J. Flannagan & John M. Sullivan. 2011. Feasibility of New Approaches for the Regulation of Motor Vehicle Lighting Performance. Washington, DC: National Highway Traffic Safety Administration (NHTSA–2018–0090–0002). See also 77 FR 40843 (July 11, 2012) (request for comments on the report).

⁶² Elizabeth Mazzae, G.H. Scott Baldwin, Adam Andrella, & Larry A. Smith. 2015. Adaptive Driving Beam Headlighting System Glare Assessment, DOT HS 812 174. Washington, DC: National Highway Traffic Safety Administration (NHTSA–2018–0090–0003).

⁶³ See NPRM, pp. 51773–51774.

(this is discussed below). NHTSA developed a modified version of the NPRM test procedure (including a simplified set of test scenarios) using the test fixtures. NHTSA then carried out a series of preliminary and full-scale vehicle tests to develop and validate those test procedures. Those test procedures are the same test procedures specified in this final rule. The research also documented testing details to support the laboratory test procedure manual that will be used by NHTSA's Office of Vehicle Safety Compliance (OVSC).⁶⁴

NHTSA used the following three vehicles in the test program.

- 2019 Ford Fusion equipped with FMVSS-certified halogen headlamps;
 - Selected because it was a high-sales vehicle with halogen headlamps compliant with FMVSS No. 108, and the vehicle was readily available at NHTSA's Vehicle Research and Testing Center (VRTC).
- 2016 Volvo XC90 equipped with FMVSS-certified LED headlamps;
 - Selected because it was equipped with LED headlamps rated "Acceptable" by IIHS, and the vehicle was readily available at NHTSA's VRTC.
- 2018 Lexus NX300 (European mass production model) equipped with ADB LED headlamps modified by the manufacturer to be consistent with a visually optically aligned right (VOR) beam pattern used in the United States.
 - Selected because it was equipped with an ADB system, modified to project lower and upper beam patterns compliant with FMVSS No. 108.

Preliminary Test Development and Validation

NHTSA created a test fixture to accommodate both the NHTSA and SAE test procedures. The test fixture positioned a vertical array of illuminance meter light sensors (*i.e.*, receptor heads) in specified positions and provided accurate positioning for the various NHTSA and SAE lamp configurations. The configurations included stimulus lamps specified in today's final rule: MY 2018 Ford F–150 headlamps and taillamps, MY 2018 Toyota Camry headlamps and taillamps, and a MY 2018 Harley Davidson motorcycle taillamp,⁶⁵ and the lamps

⁶⁴ The OVSC laboratory procedures are not part of the regulatory text. Published separately by OVSC, they are intended to provide laboratories contracted by NHTSA with additional guidelines for obtaining compliance test data.

⁶⁵ To represent a motorcycle headlamp, this testing used a 5.75 inch bullet headlamp kit from a 2018 Harley Davidson Roadster using an HB2 replaceable light source (part #68593–06). After this testing and before the publication of this final rule,

specified in SAE J3069 intended to simulate headlamps and taillamps. This single test fixture was able to accommodate needed light sensor configurations for both oncoming and same direction test scenarios.

As an important initial step as part of the research, NHTSA evaluated the stability of the measured illuminance values without a test vehicle present to determine the level of noise (if any) in the measurement system that was not dependent on the vehicle being tested. For each stimulus lamp condition, illuminance data were recorded for a period of 30 seconds in typical test conditions. The results indicated that both the analog and digital data, measured at frequency over time, demonstrated low standard deviations for each of the receptor heads for each of the ten test lamp conditions, suggesting very little system noise or fluctuation from ambient conditions. In fact, each lamp condition had at least two receptor heads that exhibited no variability (standard deviation = 0) in the digital data. Thus, the illuminance meter outputs appeared to be stable.

Testing of the three vehicle models with headlighting systems operating in lower beam mode showed that the measurement system and the headlamp types tested, halogen and LED, were compatible with the test equipment (*i.e.*, no abnormalities in measurements were observed based upon the type of headlighting system).

NHTSA performed tests to assess whether test scenarios could be executed with sufficiently steady vehicle dynamics such that, in lower beam mode, headlamp illumination measured during the dynamic test scenario would match that measured in the same location with the vehicle stationary. Measured illuminance and pitch data values were extracted for both dynamic and static test trials at specific scenario path points corresponding to an end of a glare limit distance range. This study found that dynamically-influenced variation was not a major contributor to variability in the test. Pitch was found to have a major influence on illuminance measurements; however, the sources of pitch variance were primarily static in nature (resulting from waviness in the track pavement) and not dynamic (acceleration, or dynamic oscillations).

Full-Scale Validation Testing

After successfully completing this preliminary evaluative testing, NHTSA proceeded to validate the final test

that part went out of production and has been replaced with part #68297-05B.

procedure by performing three sets of full-scale tests.

In the first set of tests, the ADB-equipped Lexus NX300 was subjected (in ADB mode) to the final rule test procedure as well as the SAE test procedure. We also evaluated ADB system performance using a full F-150 vehicle as a stimulus instead of a test fixture. In general, the ADB system installed on the tested vehicle responded similarly to the test fixture as it did to the full stimulus vehicle.

In the second set of tests, the agency subjected all three test vehicles with headlighting systems operating in lower beam mode to the NHTSA ADB test procedure. Measured illuminance values were evaluated with respect to the glare limit criteria. The lower beams of the Ford Fusion had passing results below the glare limits in all test scenarios, while the lower beams of the Lexus NX300 did not pass several of the test scenarios when illuminance values were compared to the glare limits. The Volvo lower beams performed well under the limits for the straight and left curve scenarios, but exceeded the limits finalized today for the right curves.

In the third set of validation tests, the agency conducted a series of tests using the 2016 Volvo XC90 with the lower beams activated to determine the repeatability of measured illuminance values and test outcomes for both the final rule and SAE test procedures. Testing involving multiple runs of each test scenario was conducted to permit different types of repeatability analyses, including same night (gauge); different night (test procedure); and different headlamp aiming technician (reproducibility). The repeated testing was performed to support an assessment of the repeatability of measured illuminance values and test outcomes for the final rule's ADB test procedure (as well as the SAE test procedure). A summary of the agency's repeatability analysis is presented in Section VIII.C.11. The full results of NHTSA's test procedure repeatability and reproducibility analyses are detailed in the repeatability report docketed with this final rule.⁶⁶ The test procedures reported in that document are the same as the procedures used in the first and second sets of validation tests described above. NHTSA is also docketing a full test report more fully describing the agency's testing.⁶⁷

⁶⁶ Mazzae, E.N., Baldwin, G.H.S., Satterfield, K., & Browning, D.A. 2021. Adaptive Driving Beam Headlamps Test Repeatability Assessment. Washington, DC: National Highway Traffic Safety Administration.

⁶⁷ Mazzae, E.N., Baldwin, G.H.S., Satterfield, K., Browning, D.A., & Andrella, A.T. 2021. Adaptive

VIII. Final Rule and Response to Comments

A. Summary of the Final Rule and Modifications to the NPRM

The major components of the final rule are summarized below, including the most significant differences between the final rule and the NPRM. Less significant changes are discussed in the appropriate sections of the preamble.

Vehicle-Level Track Test To Evaluate Glare

The final rule retains the track test but departs from the proposal in a few ways.

Stimulus test fixtures instead of stimulus vehicles. The final rule specifies the use of test fixtures instead of stimulus vehicles. This change will result in a less complex test more closely harmonized with SAE J3069, while still ensuring that ADB systems operate safely. While the test fixture specifications follow the SAE J3069 specifications with respect to the locations of the photometers and stimulus lamps, the final rule requires the use of more real-world representative lighting by specifying original equipment vehicle headlamps and taillamps.

More efficient test scenarios. The final rule substantially simplifies the number and complexity of test scenarios. Because the final rule specifies stimulus test fixtures and not stimulus vehicles, all scenarios involving a moving stimulus vehicle (*e.g.*, passing scenarios) were eliminated. While the final rule retains oncoming and preceding scenarios⁶⁸ with a curved test path, the agency modified the measurement distances and eliminated some scenarios entirely because they were deemed unnecessary. With respect to oncoming scenarios, the straight and large left curve scenarios are retained essentially as proposed, and the short-radius right curve scenario has been eliminated. The final rule retains scenarios with other proposed curves but truncates the distances at which ADB illuminance is evaluated. With respect to preceding glare scenarios, the final rule retains (with truncated measurement distances) the straight and medium left curve scenarios. These modifications, summarized in Table 4, respond to comments that expressed concern about the complexity of the proposed testing. NHTSA believes that

Driving Beam Headlighting Systems Rulemaking Support Testing. Washington, DC: National Highway Traffic Safety Administration.

⁶⁸ The final rule regulatory text uses the terms "same direction" and "opposite direction" to reflect that the final rule uses fixtures and not stimulus vehicles.

the finalized test scenarios meet the need for motor vehicle safety by containing a broad range of realistic road geometries—including curves—and vehicle interactions while addressing possible redundancies.

TABLE 4—SUMMARY OF MODIFICATIONS TO THE PROPOSED TRACK TEST SCENARIOS

NPRM test #	NPRM				Final test #	Final rule		
	Measurement distance (m)	Stimulus vehicle speed (mph)	Test vehicle speed (mph)	Radius (size-direction) ⁶⁹		Measurement distance (m)	Test vehicle speed (mph)	Radius (size-direction) ⁷⁰
<i>Oncoming (adjacent lane):</i>								
1	15–220	60–70	60–70	Straight	1	Dropped		
2	15–220	0	60–70	Straight		15–220	60–70	Straight
5a	15–220	25–30	25–30	Small—R		Dropped		
5b	15–220	25–30	25–30	Small—L		Dropped		
6a	15–220	0	25–30	Small—R	2	15–59.9	25–30	Small—L
6b	15–220	0	25–30	Small—L		Dropped		
7a	15–220	40–45	40–45	Med—R		Dropped		
7b	15–220	40–45	40–45	Med—L		Dropped		
8a	15–220	0	40–45	Med—R	5	15–50	40–45	Med—R
8b	15–220	0	40–45	Med—L	3	15–150	40–45	Med—L
11a	15–220	50–55	50–55	Large—R	Dropped			
11b	15–220	50–55	50–55	Large—L	Dropped			
N/A	N/A	N/A	N/A	N/A	6	15–70	50–55	Large—R
N/A	N/A	N/A	N/A	N/A	4	15–220	50–55	Large—L
<i>Same Direction Same Lane:</i>								
1	15–220	60–70	60–70	Straight	Dropped			
5a	15–220	25–30	25–30	Small—L	Dropped			
5b	15–220	25–30	25–30	Small—R	Dropped			
7a	15–220	40–45	40–45	Med—L	Dropped			
7b	15–220	40–45	40–45	Med—R	Dropped			
11a	15–220	50–55	50–55	Large—L	Dropped			
11b	15–220	50–55	50–55	Large—R	Dropped			
<i>Same Direction Adjacent Lane Fast ADB:</i>								
2	15–119.9	0	60–70	Straight	7	15–100	60–70	Straight
3	15–119.9	40–45	60–70	Straight	Dropped			
6a	15–119.9	0	25–30	Small—R	Dropped			
6b	15–119.9	0	25–30	Small—L	Dropped			
8a	15–119.9	0	40–45	Med—R	8	15–100	40–45	Med—L
8b	15–119.9	0	40–45	Med—L		Dropped		
9a	15–119.9	30–35	40–45	Med—R	Dropped			
9b	15–119.9	30–35	40–45	Med—L	Dropped			
13a	15–119.9	40–45	50–55	Large—R	Dropped			
13b	15–119.9	40–45	50–55	Large—L	Dropped			
<i>Same Direction Fast Stimulus:</i>								
4	30–119.9	60–70	40–45	Straight	Dropped			

Data measurement and allowances. The final rule makes some changes to how NHTSA will measure and evaluate ADB system illuminance. NHTSA has added a specification for a data filter. It has deleted the proposed International Roughness Index parameter and replaced it with an explicit adjustment for vehicle pitch. The proposed 0.1

⁶⁹Small = 98 m–116 m; Med = 223 m–241 m; Large = 335 m–396 m.

⁷⁰Small = 85 m–115 m; Med = 210 m–250 m; Large = 335 m–400 m.

second (or 1 m) allowance for momentary glare exceedances has been modified by deleting the distance component and more clearly specifying how this adjustment will be applied. The final rule also includes additional specifications for the photometer.

Component-Level Laboratory Photometric Testing

The final rule retains the proposed requirements for component-level laboratory testing but has modified them

to give manufacturers greater design flexibility.

Defining “adaptive driving beam” as a new beam type. The final rule defines a new beam type, an “adaptive driving beam,” as “a beam consisting of area(s) of reduced intensity, unreduced intensity, and transition zone(s).” We eliminated the proposed regulatory text that referred to an area of reduced intensity as being “designed to be directed towards oncoming or preceding vehicles” and to an area of unreduced

intensity as being directed “in other directions.” The final rule is intended to provide manufacturers flexibility to decide which portions of the roadway will receive an area of reduced or unreduced intensity, subject to several requirements or constraints (such as the track test that evaluates glare). This will enable systems to provide an area of reduced intensity not only to prevent glare to oncoming or preceding vehicles, but also in other situations in which reduced intensity would be beneficial (for example, towards retroreflective signs, or on a wet roadway).

Transition zone. In response to comments, the final rule also allows for a 1-degree transition zone between an area of reduced intensity and an area of unreduced intensity.

Requirements for areas of reduced intensity. The final rule retains the requirement that an area of reduced intensity not exceed the lower beam maxima in order to help ensure that other motorists are not subject to glare. It also continues to require that an area of reduced intensity meet the lower beam minima; NHTSA believes this requirement is important because neither the proposal nor the final rule include any “false positive” tests to ensure that an ADB system does not mistakenly dim the beam in the absence of any oncoming or preceding vehicles.

Requirements for areas of unreduced intensity. The final rule follows the NPRM and specifies the existing upper beam minima and maxima. In response to comments that suggested not specifying the upper beam minima in this area (in order to allow less illumination in situations in which it would be appropriate, such as towards a retroreflective sign), we have, as explained above, eliminated the proposed regulatory text that implied that an area of unreduced intensity should be directed towards areas of the roadway not occupied by other vehicles. This will allow manufacturers to design systems that provide an area of reduced intensity to areas of the road that are not occupied by other vehicles but for which it may be appropriate to provide less illumination than would be required by the upper beam minima.

As was proposed, the final rule does not adopt the higher ECE upper beam maxima. While NHTSA agrees with the commenters that higher intensity upper beams might lead to potential safety benefits in the form of increased visibility in the absence of other road users, the agency remains concerned about the associated potential safety disbenefits, due to increased glare, that might result from higher intensity upper beams, particularly in situations in

which an ADB system might not recognize and shade other vehicles.

Other System Requirements

ADB minimum activation speed. The final rule retains a minimum activation speed but this has been decreased from 25 mph to 20 mph to give greater flexibility to manufacturers wishing to provide for hysteresis in the system design.

Exemption from some horizontal aimability performance requirements. The final rule amends the headlamp horizontal aimability performance requirements to exempt ADB systems from many of the vehicle headlamp aiming device (VHAD) requirements. These requirements are not necessary for ADB systems and exempting ADB systems will lower costs and facilitate ADB deployment in the United States.

B. Interpretation of FMVSS No. 108 as Applied to ADB Systems

Prior to the publication of the NPRM, NHTSA had not directly addressed whether FMVSS No. 108 permits ADB systems. In the NPRM, we tentatively concluded that ADB systems are not currently permitted under the standard because they are part of the required headlamp system, and, as such, would not comply with at least some of the headlamp requirements.⁷¹ We included this tentative interpretation in the NPRM because some manufacturers had argued that ADB systems should be considered supplemental lighting.⁷²

In the NPRM we went on to also consider the status of ADB technology if we were, instead, to consider it supplemental equipment. We concluded that this still might not obviate the need for this rulemaking because it would be difficult for NHTSA to verify that the system did not impair the effectiveness of any of the required lighting. That is, whether an ADB system is functioning properly depends on whether it accurately detects oncoming and preceding vehicles in actual operation on the road, and there would be no way to test this under FMVSS No. 108 as the standard had existed prior to this final rule.

⁷¹ For a more detailed discussion, see NPRM, 83 FR 51774–51777.

⁷² FMVSS No. 108 specifies, for each class of vehicle, required and optional (if-equipped) lighting elements. The standard sets out various performance requirements for the required and optional lighting elements. The standard also allows vehicles to be equipped with lighting not otherwise regulated as required or optional equipment. This type of lighting equipment is referred to as “supplemental” or auxiliary lighting. Supplemental lighting is permitted if it does not impair the effectiveness of lighting equipment required by the standard. S6.2.1.

Comments

Several commenters (General Motors, LLC [GM], American Honda Motor Co., Inc. [Honda], Global Automakers [Global], Ford Motor Company [Ford], and the Alliance of Automobile Manufacturers [Alliance]) disagreed with NHTSA’s proposed interpretation, and contended that ADB systems should be considered supplemental lighting.

Agency Response

The interpretation set out in the NPRM (which concerned the version of the standard in effect prior to this final rule) is now moot because the final rule amends the standard to expressly allow and regulate ADB systems. For the same reason, ADB systems can no longer be considered (as suggested by the commenters) “supplemental” lighting because the rule amends the standard to expressly allow ADB systems, while at the same time subjecting them to a variety of requirements expressly intended for and unique to these systems.⁷³

C. Track Testing Requirements and Procedures

1. Practicability of Proposed Test Scenarios

The NPRM proposed a wide range of track test scenarios, including a large set of potential stimulus vehicles, varying road geometries (curves, straight paths), and varying vehicle speeds.⁷⁴ NHTSA tentatively concluded that the proposed ranges of stimulus vehicles and test scenarios were appropriate to ensure that an ADB system functions robustly

⁷³ The interpretation set out in the NPRM assumed that the adaptive beam would always be a “lower beam” under the version of the standard predating this final rule because a “lower beam” is defined in the standard as “a beam intended to illuminate the road and its environs . . . when meeting or closely following another vehicle.” This assumed that in the absence of other vehicles ADB systems would provide a full upper beam, and not an adaptive beam. However, some of the commenters pointed out that an adaptive beam (*i.e.*, less than a full upper beam) might also be provided in the absence of other vehicles (for example, in order to minimize glare to the driver from retroreflective signs). As we explain later in this preamble, the final rule allows for this type of beam design.

⁷⁴ The test matrix specifies ranges for the various test parameters. Other provisions in the final regulatory text also specify ranges of values at which various testing parameters may be set. The larger the range of values, the broader the parameters for which the vehicle must perform. Where a range of values is specified, the vehicle must be able to meet the requirements at all values within the range. In addition, the word “any,” used in connection with a range of values or set of items in the requirements, conditions, and procedures of an FMVSS means generally the totality of the items or values, any one of which may be selected by the agency for testing. See 49 CFR 571.4, Explanation of Usage.

and avoids glaring other drivers in a wide variety of real-world circumstances. The agency explained its concerns about a test procedure permitting an ADB system designed to accommodate only a narrow range of vehicles and explained that the proposed scenarios would require ADB systems to be able to negotiate a variety of real-world conditions. NHTSA tentatively concluded that the proposed testing was practicable but acknowledged that certain scenarios might be challenging for some ADB systems. The agency also explained its decision not to propose some common scenarios. For example, we explained that the proposal did not include testing ADB performance when approaching a vehicle at an intersection oriented perpendicular to the ADB vehicle's direction of travel because existing ADB systems would have a difficult time meeting the performance criteria in such scenarios and the magnitude and effect of glare in this situation would be relatively minimal (because the vehicle illuminated by the ADB system would be stopped or preparing for a stop).

Comments

The agency received a number of comments on the practicability of the proposed test scenarios. Many of the commenters, including many vehicle and equipment manufacturers and trade associations, agreed with the need for track testing, but most stated that the proposed testing was unnecessarily broad and impracticable. Intertek supported a more rigorous dynamic roadway test than specified in SAE J3069, but stated that the full set of proposed scenarios may not be necessary and estimated testing costs to be two-to-four times higher than testing to SAE J3069. Consumer Reports and IIHS also supported a vehicle-level track test but stated that the proposed track test was too broad. Many industry members (Honda, Global, GM, SAE, Competitive Enterprise Institute (CEI), Toyota, Alliance, Mobileye, OSRAM Sylvania Inc. (OSRAM), the Motor & Equipment Manufacturers Association (MEMA), Infineon Technologies Americas Corp. (Infineon), Valeo Lighting Systems (Valeo), and NAFA Fleet Management Association (NAFA)) supported the use of SAE J3069, which includes a more limited track test, and/or specifically supported a more limited track test than proposed. Commenters made a variety of arguments for why they believed the proposed track test was not practicable.

A number of commenters⁷⁵ stated that the proposed track test was not practicable because of the number and complexity of the proposed scenarios. For example, SAE stated that testing over 34 different maneuvers on various road geometries with multiple variations is excessive and not practicable. IIHS similarly commented that the number of scenarios could be reduced to a more manageable set without sacrificing the tests' ability to identify systems unable to adequately mitigate glare. IIHS estimated that testing every scenario with all four types of stimulus vehicle would require 272 tests, and that testing at different speeds would require even more tests. Toyota estimated that the proposal resulted in 10,000 possible test scenarios.

Several commenters claimed that the proposal would necessitate testing capabilities beyond those available at existing test facilities. The Alliance for Automotive Innovation (Auto Innovators) conducted a series of tests based on the proposed scenarios and commented that it found that the proposed scenarios were unnecessary and beyond the capabilities of many proving grounds. Volkswagen, the Alliance, Valeo, and Auto Innovators commented that the proposed test scenarios necessitated test tracks with characteristics (*e.g.*, specified radii of curvature, road surface conditions, test track length necessary for attaining specified speeds) that were not within the capabilities of existing proving grounds. SAE, Auto Innovators, OICA and the Society of Motor Manufacturers and Traders (SMMT) contended that the proposed track test would necessitate data measurement capabilities beyond those which are currently available at test facilities, with Auto Innovators arguing that the proposal would require up to 476 data elements. Auto Innovators also commented that the amount of time needed for data collection and processing was longer than expected, and it recommended that NHTSA develop software or other compliance tools to expedite data processing. To address these issues, Auto Innovators recommended (among other things) adopting fixed lighting stimuli, limiting the number of eligible stimulus vehicles, and limiting the number and complexity of test scenarios.

A few commenters suggested eliminating redundant scenarios and/or

⁷⁵ These were MEMA, IIHS, Toyota, Alliance, SAE, Auto Innovators, Honda, Global, Valeo, Volkswagen, the International Organization of Motor Vehicle Manufacturers (OICA), GM, Ford, and the Transportation Safety Equipment Institute (TSEI).

testing only the most stringent scenarios. Auto Innovators suggested that by adopting the most stringent test scenarios at the extremes of the testing range, the intermediate tests could be eliminated. For example, Auto Innovators suggested only specifying straight and small-radius curve scenarios because the small-radius curve was the most stringent test with 46 failures out of 127 valid test runs (36.2% failure rate), while the failure rates for the straight, mid, and large radius test scenarios were 26.6%, 26.7%, and 22.4%, respectively. IIHS stated that while the volume of proposed test scenarios might be justified if each scenario presented substantially different conditions for the ADB system, that is not the case with the proposal; an algorithm based on a camera sensor has limited ability to compute distance and vehicle type solely using another vehicle's headlamps or taillamps. For example, from the camera's perspective, a larger vehicle farther away will look the same as a smaller vehicle at a closer distance. As a result, ADB algorithms will be designed to the boundary cases of the range of scenarios NHTSA finalizes, which should allow the intermediate scenarios to be eliminated.

The Truck and Engine Manufacturers Association (EMA) commented that the NPRM did not consider the significant barriers and expense of the proposal on the heavy-duty market. EMA stated that the heavy-duty market presents unique challenges for ADB development because of the wide variation of potential vehicle configurations due to extensive customization and low volume.⁷⁶ EMA commented that these varied configurations determine the height and angle of the vehicle, and in the case of incomplete vehicles the angle of the chassis may change upon completion of the vehicle by a body-builder. EMA also commented that performing track-level testing on hundreds of vehicle configurations would be cost-prohibitive, and track-testing facilities are not readily accessible to manufacturers. EMA also commented that the NPRM did not include any data specific to heavy-duty vehicles and stated that such testing would be necessary before finalizing the rule. EMA stated it was unable to fully evaluate the proposal due to the immaturity of ADB technology for the heavy-duty market.

⁷⁶ EMA also commented about the impact of the driver's eye point and sensor positions in heavy-duty vehicles, but NHTSA was unsure of the meaning of this comment.

Global commented that NHTSA should justify the fact that the proposal was more stringent than the current semiautomatic beam switching device requirements (which are limited to a test of the “camera” device and do not test the overall system).

Agency Response

NHTSA agrees that the proposal included redundant scenarios and that the final rule can more closely follow SAE J3069 without sacrificing the robustness of the test. The final rule specifies stationary test fixtures outfitted with vehicle lamps instead of dynamic stimulus vehicles. The test fixture specifications are similar to those specified in SAE J3069, but differ by specifying original equipment vehicle lamps. Accordingly, the final rule eliminates all scenarios involving a moving stimulus vehicle.

NHTSA also modified the specified road geometries. The final rule retains scenarios with actual curves. However, considering lower beam and ADB system capabilities, NHTSA has narrowed down the curve scenarios by eliminating the short right-curve

scenario and truncating the measurement distances for all but the large left curve scenario. NHTSA similarly modified the measurement distance for the preceding scenarios. We believe that the final test scenarios are sufficient to determine whether an ADB system prevents glare to other motorists. The reasons for these modifications are discussed in more detail in Section VIII.C.8, Test Scenarios and Section VIII.O, Regulatory Alternatives.

The agency narrowed down the test scenarios by identifying aspects of performance that an acceptable ADB system should meet and choosing scenarios that would be the most challenging with respect to those aspects of performance. For example, the final rule includes a same-direction left curve scenario in order to test the ability of an ADB system to recognize dim red lamps at wide angles.

However, the agency’s testing showed that it was not possible to identify a radius of curvature (*e.g.*, shortest) that would necessarily present a “worst-case” for all aspects of an ADB system. For example, with the oncoming car/truck test fixture outfitted with the

Camry headlamps on a left curve, the shorter-radius curve was, in fact, more challenging for the ADB system used for testing as evidenced by the fact that it nearly exceeded the glare limit. See Figure 2.⁷⁷ However, when tested with the preceding motorcycle fixture in a left curve test scenario, the ADB system tested failed the test on a larger-radius curve but passed the test on a smaller-radius curve. See Figure 3. On the larger-radius curve, the system failed to recognize the motorcycle taillamp for the entirety of the test (the detectors are saturated at the end of the test, so it is not possible to interpret the results from 30 m–15 m). This suggests that a variety of test scenarios, including a range of different curves, are needed to test the variety of factors that contribute to a properly-performing ADB system. While in many instances, shorter-radius curves will be a worst-case scenario, the agency does not believe such curves will necessarily represent the worst-case for all ADB systems; complexities in the recognition system can create a far more complex set of test results. The final rule therefore retains curves with a range of radii of curvature.

Figure 2. ADB system with oncoming car/truck fixture on left curve, R85 m vs. R115 m

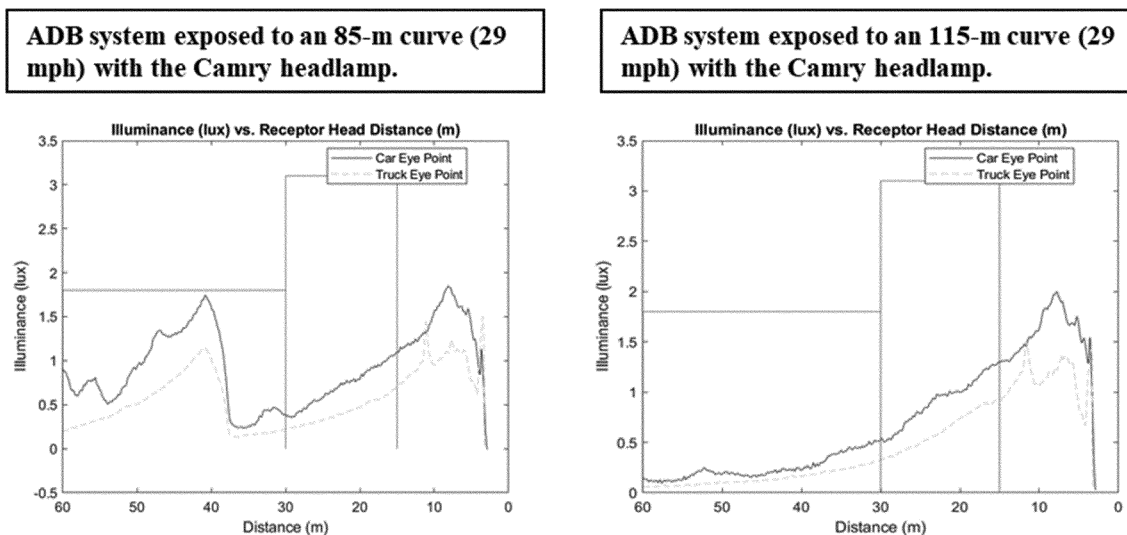

⁷⁷ The agency saw a similar result in its 2015 data. See Adaptive Driving Beam Headlighting System Glare Assessment, DOT HS 812 174, August

2015, NHTSA U.S. Department of Transportation, p.168 (Fig. 74). The vehicles tested as part of that research demonstrated a similar performance with

respect to curve radius and closing speed. The glare was higher for the moving stimulus vehicle as compared to a stationary one.

Figure 3. ADB system with preceding motorcycle fixture on left curve (R400 and R88)

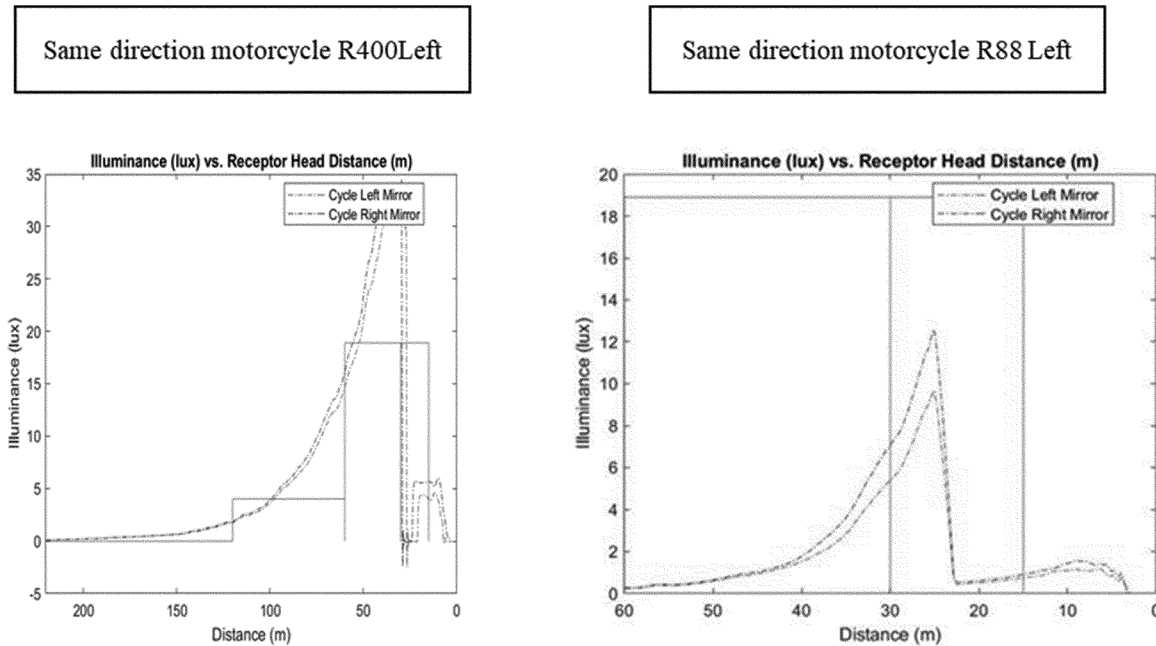

NHTSA implemented the finalized test scenarios using readily-available photometric measurement and processing equipment. Accordingly, the agency has concluded that it is within the capabilities of current testing facilities to test to the final requirements.

The agency is not persuaded by EMA's comments regarding heavy-duty vehicles. Because ADB systems are not required, heavy-duty vehicle manufacturers may take time to fully develop ADB technologies for use on these vehicles. Moreover, while the development of ADB systems for heavy-duty vehicles is less mature than for passenger cars, the agency does not believe these challenges to be insurmountable, or that meeting the requirements of this final rule is impracticable. There are a few reasons for this. First, the ability of the ADB system to dynamically track other vehicles is independent of the specific characteristics of the ADB-equipped vehicle, so the fact that the ADB system would be on a heavy-vehicle would not be consequential. Second, the test procedures specify that NHTSA will aim the headlamps on the test vehicle according to the manufacturer's instructions, which provides manufacturers with a means to mitigate the effects of chassis-specific features that might affect system performance by establishing chassis-specific aim

specifications. Third, the final rule's extensive modifications to the proposed track test, resulting in a streamlined set of test scenarios, should also help address concerns about heavy-vehicle testing.⁷⁸

Finally, while the requirements and test procedures in the final rule are an increase in stringency from the longstanding requirements for semiautomatic beam switching devices, this final rule is appropriate because ADB systems are capable of providing an enhanced beam that is brighter than the lower beam, which presents an increased risk for glare if the system is not designed appropriately.

2. Test Fixtures vs. Stimulus Vehicles

NHTSA identified two main alternatives to the proposed broad range of eligible stimulus vehicles that would be used to elicit an ADB system response. First, the agency considered specifying a small set of specifically-identified stimulus vehicles, but tentatively decided that a broad range of potential stimulus vehicles was necessary to ensure that an ADB system can recognize multiple headlamp/

⁷⁸ We also note that NHTSA was unable to perform testing on heavy-duty vehicles because it was not aware of any such vehicles that are ADB-equipped. In any case, for the reasons given above, we do not believe that it is necessary to test heavy-duty vehicles prior to adopting this rule.

tailamp configurations on vehicles of different sizes and shapes.

Second, NHTSA considered specifying test fixtures, including those specified in SAE J3069.⁷⁹ The NPRM noted SAE's rationale that fixtures represent a worst-case scenario because some cameras use movement to identify objects as vehicles. It also noted SAE's explanation that the fixture lamps would represent a "reasonable worst case for intensity and location and should promote test repeatability."⁸⁰ NHTSA also noted that test fixtures could be easier to use than actual vehicles.

However, the proposal identified several potential concerns with test fixtures. The major concern was the lack of realism, so that fixtures might not indicate whether the ADB system would recognize actual vehicles and instead could permit ADB systems to be tuned to detect fixtures. Another concern related to possible difficulties in tuning out non-vehicle objects. Also of concern was the possibility that the fixture characteristics might not represent a worst case.

The NPRM therefore proposed a large set of eligible stimulus vehicles. The agency tentatively concluded that it would be practicable for manufacturers to design ADB systems to recognize and

⁷⁹ See NPRM at p. 51782–51783.

⁸⁰ SAE J3069, p. 3.

shade any vehicle satisfying the proposed selection criteria. NHTSA noted that the lighting configurations an ADB system would have to recognize would not be unreasonably large, as front and rear lighting designs are limited by the requirements of FMVSS No. 108 and the realities of vehicle design. NHTSA also reasoned that there is a limited, and not exceptionally large, number of makes and models of new vehicles offered for sale in the United States every year (approximately 420), and that the set of eligible stimulus vehicles would be further limited by the proposed vehicle height constraint.

Comments

Vehicle and equipment manufacturers opposed the use of stimulus vehicles and commented that NHTSA should instead follow SAE J3069 and use test fixtures. These commenters identified a variety of specific concerns with stimulus vehicles.

Several commenters (Mobileye, EMA, Volkswagen, SMMT, Ford, Toyota, SAE, the Alliance, Global, and Honda) contended that the proposed stimulus vehicle specifications would result in an impracticably large set of potential vehicles. For example, SAE and the Alliance commented that the NPRM specified an unmanageable and exceptionally large number of potential stimulus vehicles, exacerbated by the fact that many vehicles have multiple headlamp and/or taillamp trim levels, and that the proposal does not account for motorcycles or heavy-duty vehicles. They estimated that this could result in a set of up to 1,000 eligible stimulus vehicles. The Alliance also contended that it would be impossible for a manufacturer to choose a worst-case scenario and guarantee that testing with the other thousands of vehicle choices would exhibit reproducible results for the multitude of requirements. MEMA, Volkswagen, and the Alliance commented that the proposal would cause manufacturers to incur costs from repeated testing as the stimulus vehicles need to be refreshed every year. Volkswagen also commented that obtaining stimulus vehicles would be especially burdensome for foreign original equipment manufacturers (OEMs) and test facilities.

Mobileye, SAE, Honda, and Ford commented that an FMVSS requiring a manufacturer certification to account for the various configurations and performance of thousands of vehicles in the market would be unreasonable and unprecedented, as opposed to other FMVSS which simulate real-world conditions with standardized test apparatus. As an example, SAE, Ford,

and Honda pointed to FMVSS No. 208, which uses a fixed barrier to simulate a stimulus vehicle crashing head on into the test vehicle within one specified range of speeds and does not require selecting actual vehicles from a large population available in the market to conduct this testing. Honda also pointed to FMVSS No. 214 (side impact) and FMVSS No. 301 (rear impact), and various New Car Assessment Program (NCAP) test procedures that standardize the device used to assess the crashworthiness of the test vehicle. SAE and Honda contended that this approach allows the test to be practicable and objective, and SAE suggested such an approach would be sufficiently realistic because, as the NPRM noted, the lighting configurations an ADB system would have to recognize are limited by the requirements of FMVSS No. 108 and realities of vehicle design.

Commenters also raised concerns related to vehicle production cycles. SAE and Ford commented that the cycle plans of any given vehicle design can last many years, with those designs solidified many months prior to production, making it impossible for manufacturers to account for other manufacturers' vehicles in any manageable timeframe. A manufacturer would not be aware of which vehicles may pose compliance challenges for its ADB system prior to these vehicles being sold to the public, especially considering the extremely conservative and challenging requirements associated with the NPRM. Honda made similar comments.

Mobileye commented that the proposal would lead OEMs to over-tune the ADB system in order to ensure compliance, resulting in non-optimal and overly sensitive system behavior and diminished safety benefits.

Several commenters (Global, Mobileye, Valeo, the Alliance, MEMA, and Volkswagen) raised concerns regarding the repeatability and/or reproducibility of compliance test results. SAE, the Alliance, SMMT, and Honda commented that the proposal was not objective.

A few commenters did support using stimulus vehicles. Consumer Reports supported a broad range of stimulus vehicles as reasonable to adequately ensure ADB systems detect, identify, and shade vehicles of different size, shape, and lighting configurations; however, it also urged that testing be practical and efficient. Intertek commented that a simple static test fixture may not be sufficient, and that using any make or model within defined physical constraints is preferable to

adding an appendix with a list of eligible test vehicles. AAA commented that no certified motor vehicle should be excluded from use as a stimulus vehicle, and that the proposed limitation to the past five model years together with the vehicle height constraints were practical and acceptable.

Several commenters, while not supporting the use of actual vehicles, commented that if NHTSA were to use actual vehicles, it should further limit the set of eligible stimulus vehicles. SL Corporation (SL) commented that detailed criteria for stimulus vehicles (such as light source, luminous intensity of the stimulus vehicle's headlamp and rear lamp), specified by vehicle type, is needed. Global commented about a need for consistency in any testing, further arguing that the rule could bookend the vehicle population's performance (*i.e.*, lowest/highest, narrowest/widest) to constrain the massive number of stimulus vehicles. Toyota suggested that NHTSA limit the number of stimulus vehicles to a practical and manageable list by only using the top three U.S. selling vehicle models for each of the vehicle types identified in Table XXI of the NPRM in the fifth model year prior to the model year of the certified vehicle. Honda stated that if NHTSA does not adopt test fixtures, it should test with a single stimulus vehicle chosen by the manufacturer. Valeo suggested specifying a standard stimulus vehicle. Mobileye suggested modifying SAE J3069 by defining the use of a standardized dummy stimulus vehicle with lamps representative of those approved by FMVSS No. 108 instead of the static fixtures specified in SAE J3069. Mobileye also recommended complementing the (modified) SAE test with a requirement for an additional test drive by a test engineer to ensure stable detection and reaction to vehicles of different makes and models in additional real-world scenarios not specified in the track test.

Agency Response

After evaluating the comments and considering the requirements of the Safety Act and the National Technology Transfer and Advancement Act (NTTAA),⁸¹ NHTSA has decided to specify test fixtures instead of stimulus vehicles. The NTTAA directs agencies to use voluntary consensus standards unless, among other things, doing so would be inconsistent with applicable

⁸¹ National Technology Transfer and Advancement Act of 1995, Public Law 104-113, 110 Stat. 775 (1996). See Section X, Rulemaking Analyses and Notices.

law. We believe the test fixtures specified in the final rule are consonant with both the Safety Act and the NTTAA.⁸² In particular, we believe the test fixtures both meet the need for safety and better align with SAE J3069 and other countries' standards.

Most importantly, we concluded that the test fixtures specified in the final rule meet the need for safety. There are two main reasons for this. First, in this case the need for safety requires us to balance visibility and glare prevention. As some commenters pointed out, a too-demanding track test to evaluate glare, including a large set of eligible stimulus vehicles, could lead manufacturers to tune the system to provide sub-optimal forward illumination. Second, we concluded that using real vehicles

would generally not challenge ADB systems any more robustly than properly-specified fixtures. In the NPRM we expressed the concern that insufficiently realistic test fixtures could lead to ADB systems with performance tuned to the fixtures, not to real vehicles, resulting in a test that does not sufficiently replicate real-world performance. To address this concern, NHTSA developed test fixtures fitted with original manufacturer replacement equipment vehicle headlamps and taillamps, instead of the lamps specified in SAE J3069 that are intended to simulate vehicle lighting. (See Section VIII.C.6 for a discussion of the final fixture specifications.) NHTSA then tested whether an ADB system performed differently with these

fixtures than with an actual vehicle. As explained below, this testing showed that the ADB system detected and responded to the finalized test fixtures in generally the same way it did to an actual vehicle.

NHTSA's recent research compared ADB performance when tested with the finalized stimulus fixtures versus a stationary stimulus (*i.e.*, actual) vehicle. For the most part, differences in performance were not observed. For example, in straight oncoming and preceding test scenarios, the ADB system recognized both the stimulus vehicle and test fixture before either stimulus entered the measurement range. See Figures 4 and 5.

Figure 4. ADB performance with stimulus vehicle vs. stimulus fixture (Opposing, Straight, 69 mph)

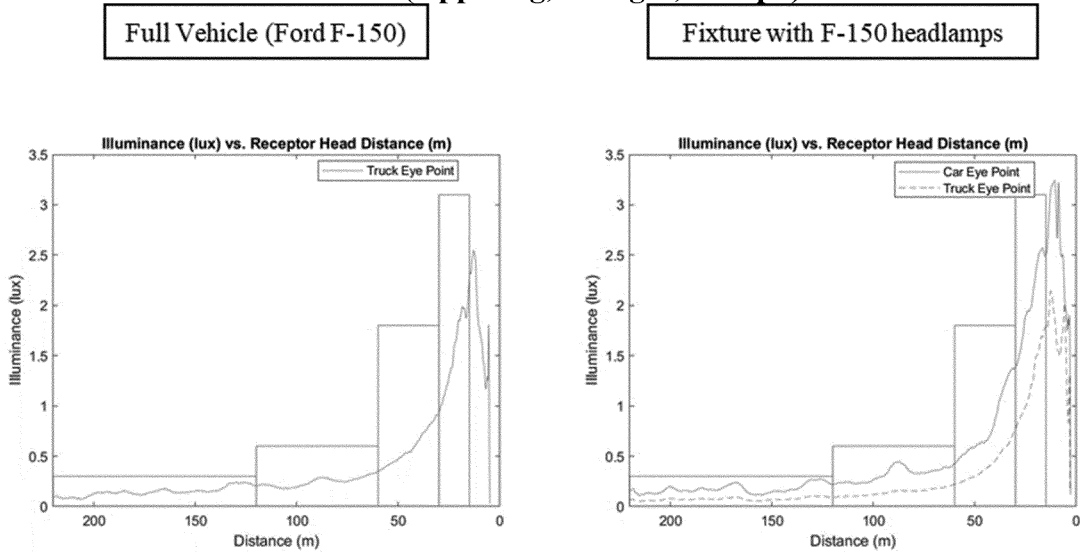

⁸² We also note that the final rule does not adopt Mobileye's suggestion to supplement the track test

with an evaluative drive by a test engineer, because

such a requirement would not satisfy the Safety Act requirement of objectivity.

**Figure 5. ADB performance with stimulus vehicle vs. stimulus fixture
(Preceding, straight, 69 mph)**

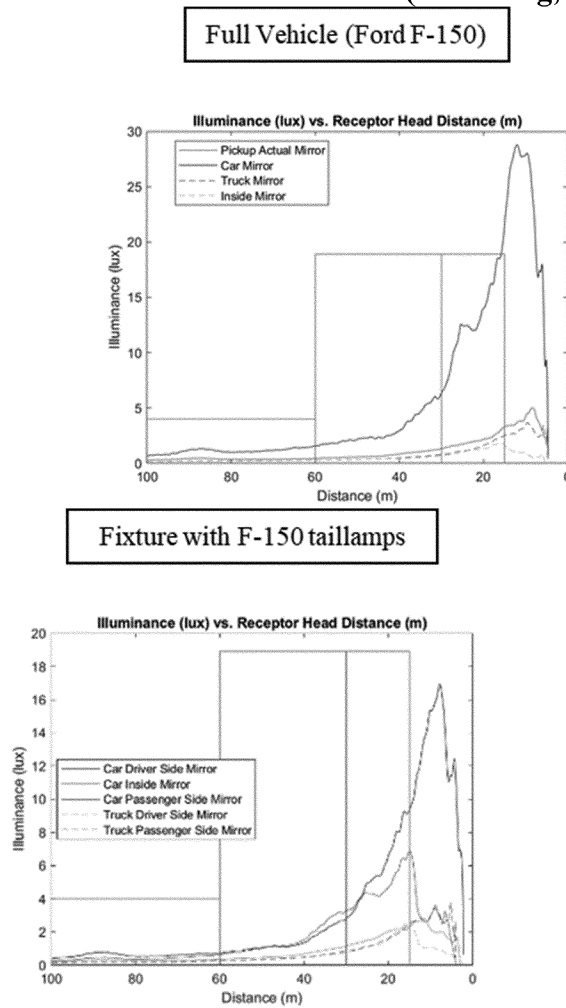

One exception to this was observed for the smallest-radius left curve (oncoming) at the highest speed. In this case, the ADB system performed better (recognized and adjusted sooner) when exposed to the test fixture. For the fixture, the test vehicle adjusted its light output at around 44 m and did not exceed the glare limits. For the real

vehicle, it reacted at 39 m, resulting in a glare exceedance. This suggests that this ADB system likely relies on light source detection rather than using supplemental systems such as radar or LIDAR to detect a vehicle structure. Although we did not systematically test this hypothesis, we suspect that the performance differences observed in

this case are caused by small differences in headlamp mounting heights between the fixture and the real vehicle. See Figure 6. The agency did not observe any situations in which the full vehicle was recognized, but the test fixture was not.

**Figure 6. ADB performance with actual vehicle vs fixture
(Oncoming, Left curve (R=85 m), 29 mph)**

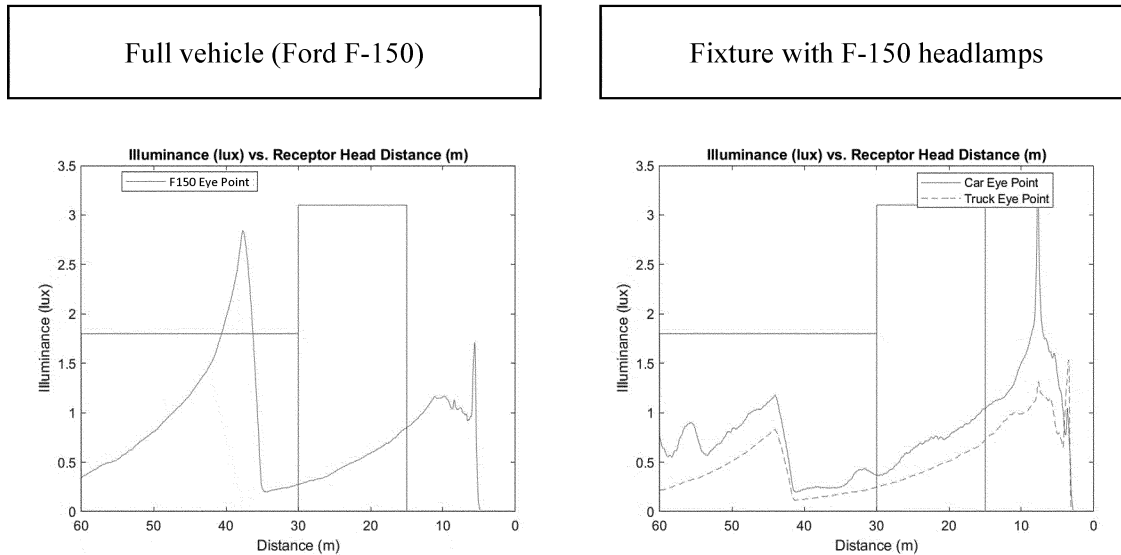

The test fixtures specified in the final rule more closely align with SAE J3069 and better harmonize with other countries' standards than the proposed broad range of eligible stimulus vehicles. This should help facilitate deployment of ADB systems in the United States because manufacturers are already familiar with SAE J3069 and because it harmonizes with the Canadian regulations, which permit ADB systems designed to meet either ECE R123 or SAE J3069. This approach also results in a more manageable set of test scenarios and stimulus vehicles to which manufacturers must certify,⁸³ which will also result in a less complex and costly test. Test fixtures will reduce the test burden by establishing a consistent stimulus for testing, reducing the cost of acquiring and maintaining the test stimulus, reducing the test time, and more closely harmonizing with SAE J3069. NHTSA's testing showed that fixtures simplified the coordination of each test run. A single test driver was required to drive the test vehicle as opposed to two drivers required for tests

⁸³ Specific to this rulemaking, NHTSA has concluded that using test fixtures better balances the safety needs of visibility and glare prevention, and is more practicable and appropriate, than using a broad range of potential stimulus vehicles. We are not implying that a large set of potential stimulus vehicles is necessarily impracticable for an FMVSS. We also note that we do not agree with the commenters who claimed that the proposal raised issues with respect to objectivity, repeatability, or reproducibility.

involving dynamic stimulus vehicles. Additionally, no start and stop coordination was needed between the two drivers. The use of fixtures also facilitates set-up for different scenarios.⁸⁴

3. Justification for Testing on Curves and General Approach for Scenario Selection

In addition to testing ADB performance in a straight-path scenario, the NPRM proposed testing ADB systems on curved-path scenarios (both left and right curves) with a variety of radii of curvature. The agency proposed testing on a "small" curve with radii of curvature from 98 m–116 m (320–380 ft); a "medium" curve with radii of curvature of 223 m–241 m (730–790 ft); and a large curve, 335 m–396 m (1100–1300 ft). The NPRM explained that the small curve was chosen because it corresponded (approximately) to the shortest radii of curvature appropriate for a vehicle traveling 25–35 mph, approximately the minimum speed for which we proposed to allow ADB activation. The medium curve corresponded to the shortest radii of curvature appropriate for the higher ADB minimum activation speeds of some of the ADB-equipped vehicles NHTSA tested. Finally, the large curve

⁸⁴ NHTSA developed a single test fixture that was capable of mounting both the motorcycle and the car/truck vehicle lamps; the various lamps could be switched between test runs of different scenarios.

was intended to correspond to a curve appropriate for vehicles traveling at higher speeds, to test ADB performance on curves at higher speeds. Values for speed and radius of curvature were selected to be consistent with the simplified curve formula.⁸⁵

The NPRM recognized that curves might present engineering challenges for ADB systems. For example, on a curve an oncoming vehicle enters the ADB system's field of view (FOV) from the edge; in a tight curve, an oncoming vehicle will enter the field of view at a closer distance than in a larger-radius curve. Performing adequately on large-radius curves at relatively high speeds consequently presents a slightly different engineering challenge than performance on tight curves at lower speeds.

Comments

Consumer Reports supported testing using curved path scenarios of various curvatures. Intertek supported a more rigorous dynamic roadway test than specified in SAE J3069 (which specifies straight test drive paths) because the SAE J3069 approach may not be sufficient to validate the performance of the ADB sensor over the range of situations that it will normally encounter.

⁸⁵ This is a standard formula used in road design that specifies the relationship between vehicle speed and the radius of curvature. See *infra* n.142 and accompanying text.

On the other hand, several commenters opposed or raised issues with testing on actual curves. SAE commented that NHTSA should follow SAE J3069 and simulate curves using a straight path and varying the placement of the test fixtures. SAE contended that curves are not necessary because continuous tracking of the angular location of the test fixture in straight scenarios is required, and that removing curves would greatly reduce the testing burden. SAE noted that it considered including curves in SAE J3069 but concluded that attempting to capture hundreds of potential road geometries would make the test excessively burdensome because ADB systems would function similarly over many of these geometries and including them all would provide no added value. SAE further determined that testing on a straight path with one lane to the right and more than one lane to the left of the ADB-equipped vehicle would capture the conditions necessary to determine whether an ADB system functions appropriately and ensures an adequate response to a wide variety of road geometries, while allowing the test method to be simple enough to be objective and repeatable. For example, SAE J3069 requires that in a straight-line encounter, an ADB system must continuously track the angular location of an opposing vehicle fixture as that angular position becomes increasingly further from the center of the camera's field of view with decreasing distance to the opposing vehicle. SAE commented that such an approach allows evaluation of vehicles encountered on curves to be captured without using actual curves.

SAE, ALNA, Toyota, and the Alliance stated that the proposal would require ADB systems to produce less glare than current FMVSS No. 108-compliant lower beams, and that this issue was particularly acute on curves. They argued that the proposed approach would reduce lower beam visibility and negatively impact safety. SAE provided analyses and graphs based on IHS data on lower beam performance on different road geometries, from straight roads to left and right curves of various radii. Stanley and Intertek also asserted that

the final rule should account for the fact that current lower beams would not comply with the glare limits on right curves.⁸⁶

Agency Response

The final rule does not adopt some commenters' recommendation to forgo actual curved-path scenarios, but it does reduce the measurement distances in many of the test scenarios for which curves are specified.

The agency is not persuaded that the SAE J3069 approach of simulating curves by varying fixture placement relative to a test vehicle's straight path adequately replicates curves. Two features of the SAE test are intended to replicate what the system would encounter in an actual curve. First, the fixtures are placed to the side of the test vehicle's path. Second, the sudden appearance scenario is intended to roughly replicate a curve in that the fixture's stimulus lamps become visible at a close distance, which would happen on a relatively tight curve. (The sudden appearance scenario is also intended to exercise the ability of the ADB system to react to real world situations such as another road user turning on their lights, turning onto the road, or cresting a hill at distances as close as 100 m.) This approach, however, does not accurately replicate real curves in at least two respects.

One is the trajectory of the fixture as it is tracked by the ADB system (see Figure 7). An approaching vehicle on an actual curve enters the ADB system's field of view from the edge, at a relatively far distance; moves towards the center of the field of view as the distance to the fixture closes; and then moves out towards the edge of the field of view at a close distance. The trajectory is different, however, when attempting to replicate a curve using a straight path and fixtures placed out to the side. There, the fixture is first detected by the ADB system near the center of the camera's field of view at a far distance, and then moves out

towards the edge of the field of view at closer distances.

For example, on an actual left curve with a radius of 230 m, the fixture enters the FOV at the edge (25L) at a relatively far distance (191 m) and moves towards the center of the FOV until around 35 m at which point it moves out towards the edge of the FOV again (see Figure 7). In comparison, in the SAE test run, at 155 meters (the start of the SAE test), Fixture 1 is near the center of the FOV at approximately 2.5 degrees left, and as the test vehicle approaches the fixture the fixture moves out to the edge of the field of view.

As another example, this time on a right curve with a radius of 230 m, the fixture enters the FOV at the right edge of the field of view (25R) at about 205 m and moves towards and then across the center of the FOV. In comparison, in the SAE test, at 155 meters (the start of the SAE test), Fixture 3 is near the center of the FOV (at about 3 degrees right), and as the test vehicle approaches the fixture the fixture trajectory moves out to the right edge of the field of view. The SAE test evaluates rather large angles to the right of the beam pattern, almost entirely to the right of where the NHTSA test method examines the beam pattern performance. The agency believes this to be unusual in reality, particularly for oncoming encounters.

Because the SAE test does not accurately replicate the fixture trajectory, it does not test how the system will need to actually function. For example, one way to "optimize" optical recognition is to focus on where an object is most likely to appear. The speed and accuracy of image recognition software can be increased without increasing computing power if systems are trained to look in smaller portions of an image for key elements, as opposed to looking at the entire image continuously. Including test scenarios with actual curves will discourage manufacturers from taking "shortcuts" and designing ADB systems that do not react until the stimulus vehicle enters narrow angles within the camera's FOV.

BILLING CODE 4910-59-P

⁸⁶ The commenters' data and arguments on these points are discussed in more detail in the sections below discussing each of the test scenarios in the final rule.

Figure 7. Comparison of fixture trajectories in SAE J3069 and final rule

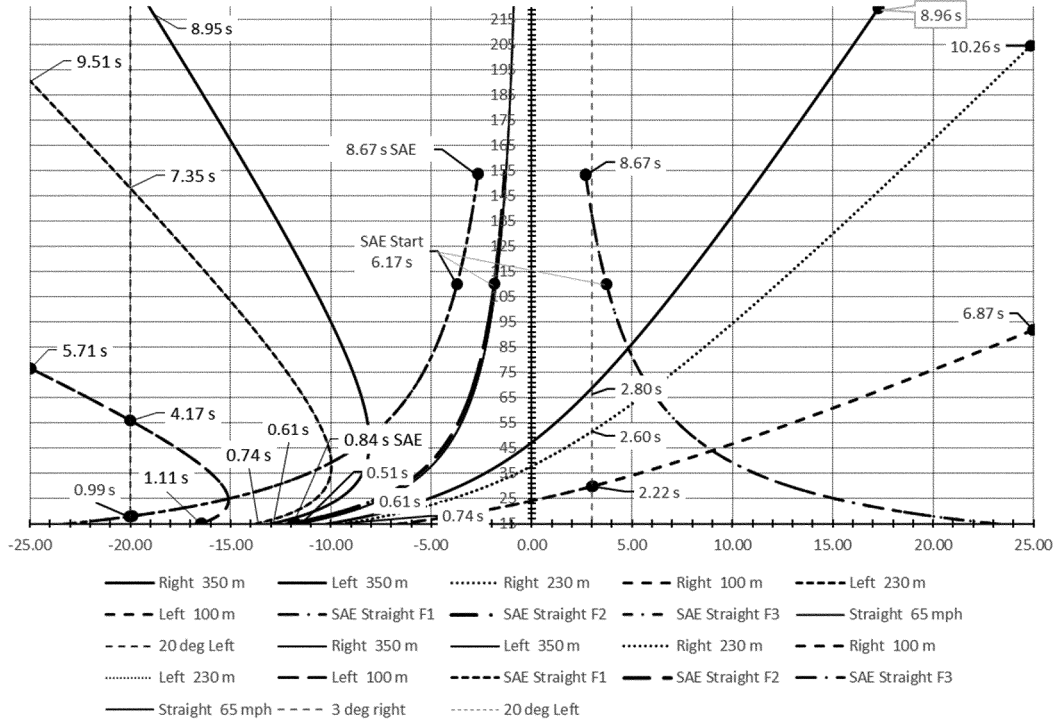

The y-axis is distance in m and the x-axis is in degrees

Second, the SAE approach does not accurately replicate real curves with respect to the speed at which the fixture traces its trajectory. On an actual curve, the fixture travels horizontally across the FOV relatively quickly at longer distances than on a simulated curve. For instance, a left curve requires the headlamp to start shading on the left side of the pattern, quickly move to the right; briefly hold the shade near the middle; and very quickly move the shade back to the far left. A simulated curve, on the other hand, simply necessitates that the system starts shading the middle of the pattern; hold nearly that same angle; and then quickly move the shade either left or right at closer distances. Including actual curved-path scenarios will discourage manufacturers from very accurately

following the straight path pattern but less accurately following the paths required for real-world curves; it should therefore result in better real-world performance than would the SAE J3069 fixture placements.

NHTSA's recent testing confirmed that the SAE scenarios do not accurately model how an ADB system will perform on an actual curve. For example, the agency tested ADB system performance on an 85 m left curve as well as the most closely analogous SAE scenario, with the fixture place in Fixture Position 1. (Fixture Position 1 is the closest analogue to this scenario because it is the leftmost fixture position in the SAE test.) See Figure 8. On the actual curve, the system did not recognize and adjust to the fixture until 45 m. On the most closely analogous SAE scenario (Fixture

Position 1), the system was able to continuously track the fixture from 150 m away. Even when the agency repeated the same SAE scenario at a much higher speed of 61 mph, the SAE test did not challenge the system's image recognition in an observable way. This shows that an ADB system's initial image recognition capability is not challenged by the SAE test as it is in a more realistic curve test, meaning that NHTSA is less confident that the SAE test would result in an equivalent level of safety as the actual-curve test that NHTSA is finalizing. The practical implications of this is that glare will not be sufficiently controlled by the SAE test compared to the actual-curve test adopted in this final rule.

Figure 8. Comparison of ADB performance on real and simulated curves

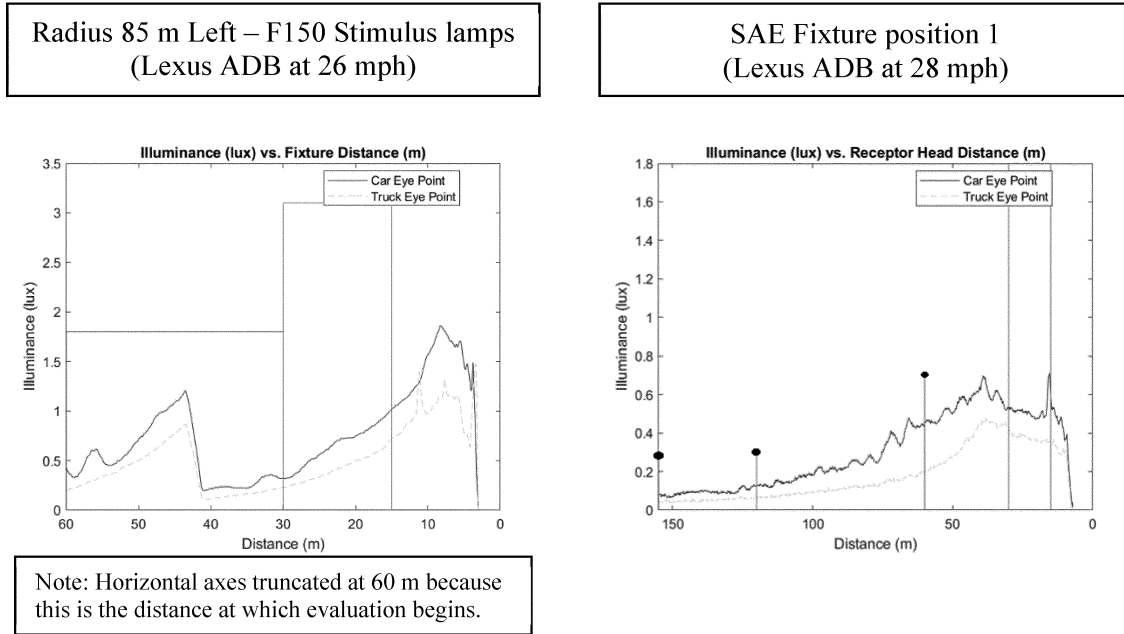

As another example, SAE J3069 does include a sudden appearance test (using the oncoming and preceding motorcycle fixtures) in which the fixture lamps are activated when the test vehicle is between 155 m and 100 m from the fixture. The agency found, however, that

this also does not realistically simulate a curve. See Figure 9. On an 85 m left curve at 26 mph, the ADB system recognized the final rule oncoming motorcycle fixture at 20 m. On the SAE sudden appearance scenario, in contrast, the ADB system performed

better, activating a shaded area at 70 m. Additional comparative data from the final rule scenarios and the SAE test scenarios are presented and discussed in Section VIII.C.8, Test Scenarios.

Figure 9. Real curve vs. SAE sudden appearance scenario

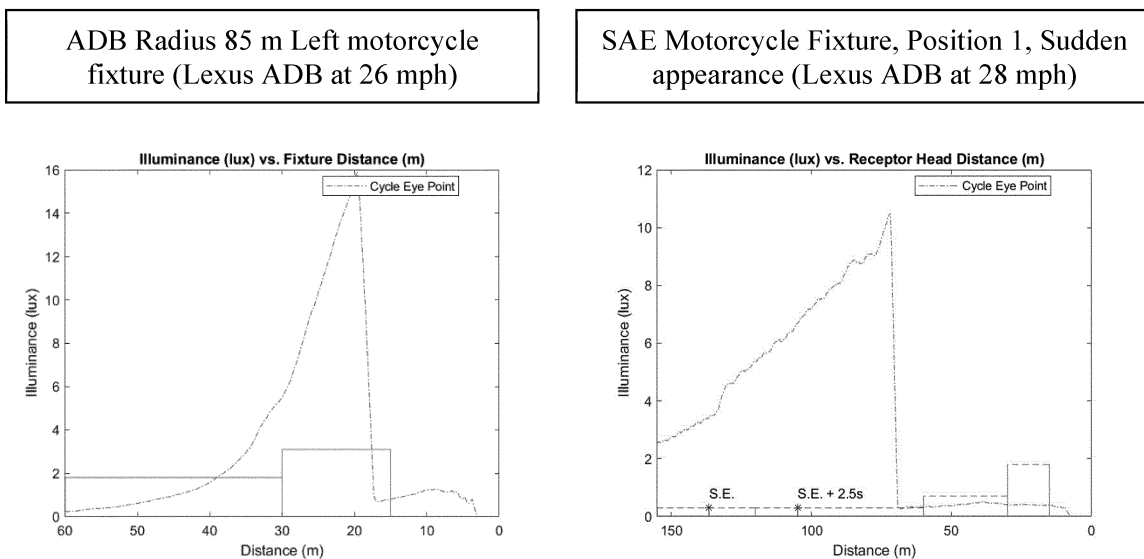

BILLING CODE 4910-59-C

NHTSA disagrees with SAE’s comment to the extent that it suggests that a final rule incorporating actual curves might not be objective or repeatable. The final rule sets out a

rational test procedure that yields a clear answer based upon readings obtained from measuring instruments and is capable of producing identical results when test conditions are exactly

duplicate.⁸⁷ The final rule specifies the specific scenarios NHTSA may test, including ranges and values for key

⁸⁷ See, e.g., *Chrysler Corp. v. Dept. of Transp.*, 472 F.2d 659, 676 (6th Cir. 1972).

testing parameters (*e.g.*, differing radii of curvature), and specific numeric limits for the maximum allowable illuminance at certain distances; there is thus no ambiguity with respect to the parameter values NHTSA may select in compliance testing. Moreover, NHTSA has conducted a repeatability analysis and has concluded that the finalized test scenarios and procedures are repeatable (see Section VIII.C.11, Repeatability).

NHTSA did, however, agree that some of the proposed curve scenarios were too stringent. With respect to oncoming glare scenarios, the final rule eliminates the short right curve scenario and reduces the distances at which glare on the medium and large right curves and the short and medium left curves is evaluated. With respect to preceding glare scenarios, the final rule includes a straight-path scenario and a medium left curve scenario. The specifications for the radii of curvature have also been slightly modified. These modifications and other choices are explained in more detail later in the preamble.

In general, NHTSA selected the final scenarios based on three criteria:

The scenario represents commonly-encountered roadway geometries and vehicle interactions. To ensure that ADB systems operate safely, the final scenarios should include at least the most common road geometries and vehicle interactions. Because the adaptive driving beam is intended for distance illumination at speeds at which the lower beam does not provide adequate illumination—typically above 20 mph—these geometries and interactions should be those common at these speeds.⁸⁸

A compliant lower beam could pass the scenario. We also generally chose scenarios such that a compliant lower beam would be able to pass the scenario. There were several reasons for this. First, this (in conjunction with the requirement that areas of reduced intensity meet the corresponding lower beam laboratory photometric requirements) ensures that an area of reduced intensity, up to and including a full lower beam, will meet the same level of safety (with respect to both visibility and glare prevention) as current lower beams certified to FMVSS No. 108. Second, this is consistent with the concept for the proposal: Extending the current laboratory-based lower beam photometric requirements (specifically, the photometric maxima regulating oncoming and preceding glare) for use in a vehicle-level test to evaluate the ability of an ADB system to minimize

glare (both oncoming and preceding).⁸⁹ Because the track test was intended as an extension of the current laboratory photometric requirements, the track test requirements should (generally) be such that a lower beam (or area of reduced intensity) that complies with the current laboratory photometric requirements will also comply with the track test requirements.

The scenario is generally within the capabilities of robustly-designed internationally-available ADB systems. As noted above, the field of view for current ADB systems is typically 25 degrees to the left and right of the camera, and, as explained below,⁹⁰ ADB adaptation time—the time it takes an ADB system to recognize a stimulus (once the stimulus is within the camera's field of view) and dim the beam to a level that falls within the applicable glare limit—is generally about 1 second. Therefore, NHTSA generally chose scenarios such that it would be possible for an ADB system with such field of view and response capabilities to pass the scenario. This is not to say that all current ADB systems would necessarily be able to pass all the final scenarios without any modifications. However, the agency intended to select scenarios that were generally within the reach of current technology (perhaps necessitating some additional improvements, adjustments, or optimizations, depending on the ADB technology), to facilitate timely deployment of ADB systems. NHTSA also recognized that these systems have been in use in foreign markets for several years with few, if any, apparent safety issues.⁹¹ We discuss and apply these criteria in more detail in Section VIII.C.8, Test Scenarios.

4. Maximum Illuminance Criteria (Glare Limits)

The NPRM included a set of photometric maxima to evaluate an ADB system's ability to minimize glare in the

track test (glare limits). Because the current photometric test points from which the proposed glare limits were derived are maxima, the agency proposed applying the derived glare limits as maxima, so that any measured exceedance of an applicable glare limit (except for momentary spikes) would be used to determine compliance. The NPRM also extended the standard's "design to conform" language to the proposed requirements, including the glare limits.⁹² The NPRM also summarized the basis for the glare limits (the full explanation for the derivation is given in the Feasibility Study).

The NPRM explained that the proposed glare limits deviate from SAE J3069 in a few respects. First, two of the glare limits differ slightly. At 60 m, SAE J3069 uses glare limits of 0.7 lux (oncoming) and 8.9 lux (preceding) compared to the proposed 0.6 lux and 4.0 lux. Second, SAE J3069 applies to a narrower range of distances (30 m–155 m) than the proposed glare limits (15 m–220 m). Third, SAE J3069 applies the glare limits only at the endpoints of the measurement ranges (*i.e.*, 155 m, 120 m, 60 m, and 30 m), while the NPRM applied the glare limits throughout the entire measurement range. The proposal explained the reasons for these deviations from SAE J3069.

Comments

A few commenters (AAA, Consumer Reports, and Zoxx) supported the glare limits as proposed. Intertek agreed that the baseline glare limit requirements should extend to the full distance ranges rather than only at the four individual distances specified in SAE J3069. Several commenters, however, contended that the glare limits were too stringent and suggested a variety of modifications.

⁹² As we explained in the NPRM, the proposal extended the standard's longstanding "design to conform" language to the proposed requirements because the concept of the rulemaking was to extend the current headlamp requirements to ADB systems. We therefore considered the continued appropriateness of "design to conform" to be outside the scope of this rulemaking. However, this extension in no way limits NHTSA's ability to revisit the issue of design to conform in the future. Furthermore, if NHTSA were to reconsider the design to conform language, it might not come to the same conclusion it did when it originally adopted that language. As we explained in the NPRM, NHTSA adopted the "design to conform" language when the standard was introduced in 1967 because it accepted industry's contemporaneous representation that vehicle lamps could not be manufactured to meet every single test point without a substantial cost penalty unjustified by safety. We further explained that, because lighting equipment design, technology, and manufacturing have evolved and advanced since the late 1960's, NHTSA might not come to the same conclusion were it to revisit this issue.

⁸⁹ See NPRM, pp. 51770, 51773.

⁹⁰ See Section VIII.C.5, ADB Adaptation Time.

⁹¹ The fact that the final rule does not include all the proposed scenarios does not mean that NHTSA has concluded that only a relatively small set of narrowly circumscribed scenarios is permissible in an FMVSS. In this case, NHTSA has concluded that adopting a smaller set of test scenarios appropriately addresses both the need for safety (including facilitating the timely deployment of ADB systems) and practicability. This also does not imply that FMVSS requirements must be tailored to the capabilities of currently existing systems. See, *e.g.*, *Chrysler Corp. v. Dept. of Transp.*, 472 F.2d 659, 673 (6th Cir. 1972) ("[T]he Agency is empowered to issue safety standards which require improvements in existing technology or which require the development of new technology, and it is not limited to issuing standards based solely on devices already fully developed.").

⁸⁸ See NPRM, pp. 51787–51788.

SAE, Global, Ford, Toyota, the Alliance, and Auto Innovators commented that the proposed glare limits were conservative and that using absolute measurements of discomfort glare (the aspect of glare that is painful or annoying, as opposed to the aspect of glare that limits the ability to see other objects) is unreasonable and not practicable. They recommended the final rule include reasonable allowances for an ADB system to momentarily exceed the glare limits, especially given the large number of proposed test scenarios. They also stated that the proposed glare limits are well below the illuminance provided by contemporary lower beams, including Insurance Institute for Highway Safety (IIHS) top-rated lower beams for MY 2017 vehicles, especially on curves. As noted earlier, SAE provided analyses and graphs based on IIHS data on lower beam performance on different road geometries, from straight roads to left and right curves of various radii.⁹³

For those reasons, SAE, the Alliance, and Toyota argued that NHTSA should evaluate the ratio of the ADB to lower beam illuminance. SAE noted that this procedure is specified in SAE J3069, which requires the measured illuminance to be no more than 25% above the measured lower beam illuminance. SAE further stated that NHTSA's 2015 ADB Test Report used a similar procedure, and that an UMTRI report found that 25% was an acceptable maximum limit above the lower beam.⁹⁴ Toyota commented that following SAE J3069 in this respect would facilitate ADB deployment across a wider range of vehicles.⁹⁵ Auto Innovators also argued for a similar 25% allowance (discussed below).

A few commenters expressed interest in the final rule accounting for glare dosage. Toyota commented that there is no clear evidence that exceeding the maximum illuminance for longer than 0.1 second leads to a safety hazard any greater than what occurs with existing headlighting systems on U.S. roads

⁹³ Auto Innovators also supplied an apparently somewhat similar analysis of IIHS data (on pp. 12–13 of its comment). However, the comment did not identify the geometry of the road (the orientation of the headlamps to the photometer) for the measurements, so the agency is unable to evaluate this submission. In any case, NHTSA addresses this issue using the IIHS data submitted by SAE and the agency's own testing of lower beams to the scenarios included in the final rule.

⁹⁴ DOT HS 808 209, Sept. 1994.

⁹⁵ SAE and other commenters also argued that comparing the ratio of the illuminance from the adaptive beam to the lower beam would also compensate for unaccounted for test variability such as dips and bumps in the road. This is discussed below in Section VIII.C.10.d, Allowance for Momentary Glare Exceedances.

today. Mobileye similarly commented that a distinction needs to be introduced between glaring that may cause discomfort to other drivers and glaring which may pose a safety risk. It asserted that, while the NPRM assumes that any glare exceedances for more than 0.1 seconds are not acceptable, drivers commonly use intentional, limited glaring as a signaling mechanism to other drivers. Accordingly, Mobileye suggested allowing glare exceedances longer than 0.1 seconds. AAA commented that the final rule should not permit glare exceedances lasting longer than 1 second because its research showed that glare from an oncoming vehicle lasting approximately 1 second was rated as highly distracting. Intertek believed that proposed 0.1 second allowance would account for the majority of the issues related to glare dosage, exposure, or perceptibility because any longer exceedance is detectable by the human eye. Auto Innovators also asserted that the final rule should account for glare dosage. (This is discussed further below.)

NHTSA received a few comments about the proposed measurement distances. Intertek commented that regulating glare for distances extending out to 220 m is unnecessary because the angular size and position of oncoming headlamps at distances greater than 155 m mitigate any harmful effects of glare. Intertek commented that testing out to 220 m creates additional complexity and testing costs. In contrast, AAA suggested regulating glare beyond 220 m. They noted that European specifications require camera recognition and reaction at distances of 400 meters (1,312 feet), and that intensity limits could be increased from the current maximum of 150,000 cd to the European maximum of 430,000 cd if ADB systems are effective at this distance. SAE commented that the proposed requirements for preceding glare are too stringent, given the detection distance (120 m vs. 100 for the ECE) and the minimum photometric requirements for rear lamps (2 cd vs. 4 cd for the ECE).

Valeo commented that the proposed maximum illuminance requirements would result in wildly varying light output, especially compared to the current ECE requirements, which result in a much more constant and consistent light intensity. Valeo also suggested that the final rule clarify that the requirements apply to the entire ADB system (both left-hand and right-hand headlamps).

Intertek suggested measuring luminance⁹⁶ from the ADB system headlamps rather than illuminance at the test fixture would provide several benefits, including: The data collected from the test would have a record which is very closely matched, and can be perceived and analyzed in much the same way as what an actual driver of the stimulus vehicle would have experienced; the recorded data can be viewed as a map of luminous intensity (candela) emitted from the test vehicle, which would be directly comparable to the existing photometry requirements, and can be plotted as a function of time or approach distance; over time, if this data is collected carefully and attention is paid to those scenarios in which the driver of the stimulus vehicle feels glared, a better quantitative baseline for and understanding of glare can be established.

Auto Innovators stated that NHTSA should adopt a modified version of the IIHS right-curve glare exposure criteria for all oncoming scenarios.⁹⁷ See Table 5. Auto Innovators contended that this would be appropriate because the IIHS glare limits are intended to provide consumers with a relative assessment of headlamp performance and it is possible for a vehicle to drastically exceed the glare criteria in the IIHS test and still comply with FMVSS No. 108; the IIHS protocol allows exceedances in the form of cumulative exposures as opposed to hard pass/fail limit at a single point in time, resulting in a series of demerits (based on the percentage over the limit) for which it is possible for a vehicle to achieve a “Good” rating while still offering small amounts of glare. Auto Innovators recommended adopting a similar method for establishing an allowable time exceedance for each test range.

TABLE 5—AUTO INNOVATORS’ MODIFIED MAXIMUM ILLUMINANCE CRITERIA BASED ON IIHS PROTOCOL

Distance (m)	Illuminance limit (lx)
30 to 59.9	6

⁹⁶ “Luminance” refers to the luminous intensity produced by a light source in a particular direction per solid angle, while, as noted earlier, “illuminance” refers to the amount of light falling on a surface. The unit of measurement for luminance is candela, while the unit of measurement for illuminance is lux. A measure of luminous intensity in candela can be converted to a lux equivalent (and vice versa), given a specified distance.

⁹⁷ Insurance Institute for Highway Safety. *Headlight Test and Rating Protocol, Version III* (July 2018); *Rationale and Supporting Work for Headlight Test and Rating Protocol*. (August 2015).

TABLE 5—AUTO INNOVATORS’ MODIFIED MAXIMUM ILLUMINANCE CRITERIA BASED ON IIHS PROTOCOL—Continued

Distance (m)	Illuminance limit (lx)
60 to 119.9	3.4 1
120 to 220	

Auto Innovators gave a few different arguments for adopting its proposed glare limits. First, it claimed that the IIHS glare limits better reflect modern headlighting systems. It noted that the proposed glare limits are based, in part, on headlamps typical of the 1997 model year, whereas the IIHS protocol is based on contemporary headlighting systems. Next, Auto Innovators contended that the IIHS protocol accounts for research indicating that the harmful effects of glare depend on both peak illuminance and overall dosage of glare exposure. Finally, Auto Innovators contended that the IIHS methodology accounts for glare effects due to incidence angle whereas the Feasibility Study does not. Auto Innovators recommended eliminating the 15–29.9 m measurement range (for both oncoming and preceding scenarios) because its test data showed not only that the least amount of failures occurred in this interval but that the exceedance durations for all failures in this range were 1.0 second or less.⁹⁸

In addition to recommending NHTSA adopt its suggested glare limits, Auto Innovators recommended that the final rule require passage of a percentage of averaged individual illuminance readings to achieve compliance instead of looking to the maximum recorded illuminance in each measurement range. Specifically, Auto Innovators appeared to suggest that NHTSA perform three test runs for each scenario and average the maximum illuminance in each measurement range recorded for each scenario. Then, it asks that NHTSA allow up to 15% of the averaged illuminance readings to exceed its recommended glare limits by up to 25%. Auto Innovators cited the same UMTRI and NHTSA reports referenced earlier, as well as three inconsequential petition grants as the basis for the 25% allowance.⁹⁹ Auto

⁹⁸ Auto Innovators also argues that glare exceedances at these short distances may be caused by swiveling of the headlamps. While this only applies to swiveling beam ADB systems, Auto Innovators believes that any safety standard should remain technology neutral.

⁹⁹ 85 FR 39678 (July 1, 2020) (grant of petition for inconsequential noncompliance for side marker lamp below photometric minima); 85 FR 39679 (July 1, 2020) (grant of petition for inconsequential

Innovators commented that the 15% allowance comes from the turn signal test requirements in S14.9.3 of FMVSS No. 108. It contended that this amount of performance variation is consistent with the challenges of outdoor dynamic testing where little previous experience exists, especially compared to the highly-controlled laboratory photometric testing that has previously been used. Auto Innovators commented that it would be difficult not to attribute failures of illuminance readings to variances that could appear in the novel and unique aspects of the test procedure, rather than to quality control issues, particularly where the time and complexity of the testing preclude conducting it on multiple ADB-equipped vehicles. It also asserted that this approach is consistent with the standard’s design to conform language. Mobileye similarly suggested specifying a pass/fail ratio for the measured illuminance values in each specified measurement interval.

Agency response

NHTSA agrees with the commenters that the proposed glare limits were overly stringent at some geometries and measurement distances in that a current, FMVSS No. 108-compliant lower beam would not have complied with some of these requirements. The agency has therefore modified the proposal by deleting the short right curve scenario and modifying measurement distances for other specified radii of curvature. NHTSA believes that these modifications reasonably ensure that a lower beam that complies with the current FMVSS No. 108 photometry requirements would be within the glare limits as applied in the specified measurement ranges in each of the final scenarios. This is discussed in further detail in Section VIII.C.8, Test Scenarios.¹⁰⁰

noncompliance for rear reflectors below minima); 55 FR 37601 (Sept. 12, 1990) (grant of petition for inconsequential noncompliance for taillamp exceeding maxima).

¹⁰⁰ NHTSA anticipates that ADB systems could provide better glare protection than current lower beams if dynamic vertical aim is incorporated into the systems. Current lower beams will produce glare on hills and undulating roads. Because of the nature of the adaptive beam’s area of unreduced intensity, it does not have the same sensitivity to aim as a lower beam with respect to seeing distance. For example, an ADB pattern could be aimed down more than a lower beam (preventing glare even when the vehicle pitches) while still providing appropriate seeing distance in directions where glare protection is not required. However, the agency decided not to require additional glare protection performance from ADB systems beyond that currently produced by lower beams (except on right curves) and anticipates aiming strategies might be incorporated into ADB systems in order to maintain reasonable compliance margins.

NHTSA disagrees with some commenters’ suggestions to follow SAE J3069 and only consider an ADB system as not complying with the glare limits if the measured ADB illuminance exceeds 25% of lower beam illuminance. The final rule differs from the proposal by eliminating overly stringent scenarios and providing additional adjustments to account for testing variability, including data filtering procedures and an adjustment for vehicle pitch, in addition to the proposed allowance for momentary glare exceedances. The agency believes that these modifications obviate the need for any further glare limit allowances. While more relaxed test requirements might facilitate ADB deployment, they would not ensure that ADB systems function properly. We believe that the final requirements and test procedures strike a reasonable balance between visibility and glare prevention.

Neither the UMTRI report nor the comments relating to the NHTSA research cited by the commenters are persuasive. The UMTRI report concerned the evaluation of inconsequentiality petitions, not the appropriate magnitude of the lower beam maxima, which is the relevant issue when considering the appropriate level for the glare limits.¹⁰¹ As explained in the NPRM, the proposed glare limits were based on FMVSS No. 108’s longstanding Table XIX photometric maxima. While the 2015 ADB Test Report did examine how close the observed ADB illuminance values were to the relevant glare limit, including an analysis of the effect on the results of increasing the glare limits by up to 25%,¹⁰² the analysis did not concern “just noticeable differences” or state or imply that exceedances of up to 125% of the relevant glare limit were inconsequential. Instead, the purpose of this analysis was to “see whether increasing the glare limit would have changed an exceeding result to a non-exceeding result.”¹⁰³ The 2015 ADB Test Report also examined the ratio of ADB illuminance to lower beam illuminance. This analysis was intended to evaluate ADB functionality, not as a means of evaluating ADB compliance. This was particularly useful because some of the lower beam headlighting systems tested in the 2015 study were not designed to meet the requirements

¹⁰¹ See DOT HS 808 209, Sept. 1994, p. 9 (concluding that “using 25% as a criterion for inconsequential noncompliance” is appropriate for lower-beam headlamps) (emphasis added).

¹⁰² 2015 ADB Test Report, p. 133.

¹⁰³ *Id.*

of FMVSS No.108. Using a ratio allowed for the comparison of basic ADB functionality against the lower beam regardless of the photometric standard to which the lower beam was designed.¹⁰⁴

Regarding the distances at which to regulate glare, regulating oncoming glare out to 220 m is appropriate. As the Feasibility Study explained, at greater distances a smaller glare limit is appropriate because, at greater distances, “the glare source will be seen by the oncoming driver at a smaller angle.”¹⁰⁵ NHTSA was able to test the final scenarios out to this distance (where applicable) and did not encounter any testing difficulties related to this distance. On the other hand, NHTSA did not develop testing scenarios for oncoming glare at distances greater than 220 m, and so is not prepared to test beyond that distance. The reasons for regulating oncoming glare out to 220 m are discussed in greater detail in Section VIII.D.4, *Requirements for area of un-reduced intensity*. NHTSA does agree with SAE that it is more appropriate to test preceding glare only out to 100 m, and not the proposed 120 m. The reasons for this are discussed in more detail in Section VIII.C.8.g, Scenario 7: Preceding Straight.

The agency disagrees with Valeo’s assertion that specifying the glare limits as a stepwise (discontinuous) function of distance will result in dramatic fluctuations in light output. The glare limits are photometric maxima, not design requirements, and there is no reason to think that manufacturers will design headlamps that suddenly increase or decrease in brightness for reasons unrelated to road conditions. Moreover, the laboratory requirements that reference the Table XIX photometric maximum intensity limits preclude manufacturers from producing areas of reduced intensity that vary as Valeo would suggest. In fact, the output limits specified in Table XIX require

lower beam intensities (which is what the agency requires the ADB systems to produce in the area of reduced intensity) well below those calculated by Valeo at the further distances of the measurement sub-range.

While the final rule could have specified the glare limits as a continuous function of distance, this would have been more complicated. In any case, the stepwise specification is less stringent than specifying glare limits as a continuous function of the closing distance between the test vehicle and the test fixture. The glare limits for each of the four specified ranges was derived from the shortest distance in the range, and then applied to all the (further) distances in the range. As the Feasibility Study explained, however, the glare limits are derived to decrease as distance increases.¹⁰⁶ Therefore, if the glare limits were specified as a continuous function of distance, they would decrease throughout the interval as distance increased. By specifying the glare limits as a stepwise function, the glare limits are higher at the further distances in the interval than they would have been if we specified them as a continuous function of distance. This has the benefit of simplicity. It also essentially gives manufacturers an additional margin for error than they would have had if we specified the limits as a continuous function of distance. The final rule has, however, incorporated Valeo’s suggestion to clarify that the requirements apply to the entire ADB system.

Intertek makes an interesting suggestion for quantifying perceived glare. However, based on the agency’s stated goals of minimizing the cost impact of the regulation and providing a pathway for introduction of ADB systems for use on U.S. roadways as quickly as possible, the final rule does not adopt Intertek’s suggestion. To do so would require additional research to inform the agency on how such changes

would affect the glare and photometry limits specified, as well as any costs associated with requiring the agency and the industry to switch from test methods designed around measuring illuminance at the test vehicle to measuring luminance. The agency simply has no data to support such a change at this time.

NHTSA understands Auto Innovators’ suggestion to adopt the IIHS glare limits as related to their general argument that the proposed glare limits and test scenarios were too stringent. As explained earlier, NHTSA agreed with this point to some extent and modified the measurement distances, test scenarios, and allowances accordingly. However, the agency does not adopt Auto Innovators’ glare limits for two reasons.

First, the glare limits suggested by Auto Innovators are three times the proposed limits, which are based on the current photometry requirements. The intent of this rulemaking is to permit ADB without increasing glare from levels currently on the road. NHTSA’s testing showed that Auto Innovators’ suggested limits do not represent glare produced by compliant lower beams under the controlled driving situations that are part of the ADB test, particularly for straight and left curve scenarios. For the left curve and straight path scenarios, testing of the Fusion and Volvo demonstrated that a considerable margin is achieved with the proposed glare limits.¹⁰⁷ See Table 6. These same types of margins are present throughout our lower beam testing. This confirms that these limits provide a boundary to protect the public from additional glare beyond what is currently experienced on the roads today. See also the discussions of lower beam performance on various scenarios in Section VIII.C.8, Test Scenarios. The commenter’s suggested limits would significantly increase that boundary and permit substantially higher glare on the roads.

TABLE 6—LOWER BEAM ILLUMINANCE MARGIN FOR PROPOSED GLARE LIMITS

Range (m)	Glare limit	Max illum.	Margin (%)
Volvo 210 m left curve at 42 mph			
150.0–120.0	0.3	0.051	83
119.9–60.0	0.6	0.158	74
59.9–30.0	1.8	0.788	56
29.9–15.0	3.1	2.118	32

¹⁰⁴ Although commenters did not suggest it, we also decided not to adopt an adjustment such that if ADB illuminance exceeds an applicable glare limit, the exceedance would be considered a noncompliance only if the ADB illuminance

exceeded the lower beam illuminance (*i.e.*, without a 25% cushion). The reasons for this are the same as the reasons for not adopting the commenters’ recommendations.

¹⁰⁵ Feasibility Study, p. 23.

¹⁰⁶ *Id.*

¹⁰⁷ The Fusion used had not been rated by IIHS. The Volvo was rated “acceptable” by IIHS.

TABLE 6—LOWER BEAM ILLUMINANCE MARGIN FOR PROPOSED GLARE LIMITS—Continued

Range (m)	Glare limit	Max illum.	Margin (%)
Fusion 400 m right curve at 54 mph			
70.0–60.0	0.6	0.415	31
59.9–30.0	1.8	0.933	48
29.9–15.0	3.1	1.394	55

Second, the agency believes the proposed oncoming glare limits (which are derived from the Table XIX left side photometric maxima) are most appropriate for any oncoming scenario—including right curves—because they were derived from limits designed specifically for oncoming traffic (which in the United States are typically to the left, except on right curves). Auto Innovators’ suggested limits may be appropriate for the right side of lower beams where the compromise between seeing distance and glare places greater value on seeing toward the right side. This is appropriate for a static beam pattern that limits glare in all horizontal directions no matter where the other road user is located. If one thinks of oncoming interactions as being oriented in terms of either straight, left curve, or right curve, two of these three (straight and left curve) have the other vehicle toward the left of the subject vehicle’s headlamps. So, for those two situations, it is better to allow more potential glare to the right side of the road (where other road users are less likely to be) in order to provide some seeing light in that direction. For the remaining right curve situation, the beam is still limited, but less so, and some glare is expected to account for better seeing distance toward the right for the other two situations. No such compromise needs to be applied for ADB. The ADB pattern creates a reduced illumination area to the left when the other vehicle is to the left and an unreduced area to the right. When the other vehicle is toward the right, the same protection can now be applied to those encounters as to the straight and left, without sacrificing seeing distance. As such, the agency is using the glare limits derived for the left side oncoming curve scenario for the right curve scenario.

The agency acknowledges the relationship between dosage (the product of illuminance and duration) and the disabling effects of glare. For glare control, the IIHS headlamp rating procedure uses a derivative of dosage (distance for which a limited illuminance is exceeded). However, the quantified crash risks associated with

exceeding these limits is not clear. Research the agency conducted in 2008 began to explore this relationship, noting that “specification of the integrated (summed) values throughout the segment would be more likely to provide control for glare recovery, but would involve headlamp light measurement procedures that are more complex than those currently used to determine if a headlamp meets the FMVSS 108 requirements.”¹⁰⁸ Until this final rule, the basic structure of the headlighting regulation (goniometer—photometry) did not provide a foundation for which glare dosage could be readily measured and regulated. As such, the agency has not focused its research in this area. While NHTSA agrees that a qualitative relationship exists, the agency has not established, and does not know of, a quantified relationship between glare dosage and crash risk.

Another limitation of IIHS’s method is that it considers all glare doses equal (except for distances between 5 m and 10 m). The impacts of glare, however, are also related to the angle between the glare source and the line of sight of the viewer. The glance pattern of drivers in nighttime glare situations is not well understood, as some drivers may be inclined to look toward the glare source effectively causing the angle between the line of sight and the glare source to be zero.¹⁰⁹ To the extent that a driver follows driver’s education recommendations and does not look at the glare source, glare doses in roadway interactions are not equally impactful at all distances, as the angle between the glare source and the line of sight is smaller at far distances. Such an effect is reflected in the current photometric tables and was, in fact, taken into account in the glare limits derivation in the Feasibility Study, in that the glare limits are smaller at greater distances.¹¹⁰ NHTSA therefore disagrees with Auto Innovators that the IIHS study accounts

¹⁰⁸ DOT HS 811 043 Nighttime Glare and Driving Performance: Research Findings, 2008.

¹⁰⁹ 2007 Report to Congress, pg. iv.

¹¹⁰ See Feasibility Study, p. 23.

for glare effects due to incidence angle.¹¹¹

NHTSA is therefore finalizing the glare limits as proposed. Future development of glare dosage as full vehicle dynamic testing for headlighting systems continues to mature is of interest to the agency.

With respect to Auto Innovators’ comments regarding specifying an allowance of 25% over the glare limits, we disagree with this for the reasons given above regarding the evaluation of the ratio of adaptive driving beam to lower beam illuminance. NHTSA also does not find the cited inconsequentiality petition grants to be persuasive because they did not concern headlamps, and, except for one of the petitions, did not concern glare. The agency was also not persuaded by the suggestions by Auto Innovators and Mobileye to adopt a pass/fail ratio or to average a number of test runs in order to mitigate test-related variability. Such procedures, while occasionally specified in an FMVSS, would be unusual. In any case, we do not believe this is necessary here for two reasons. First, we believe the final test procedure already has sufficient allowances for test-related variability (an allowance for momentary glare exceedances, a vehicle pitch adjustment, and the application of a low-pass filter with a cutoff frequency of 35 Hz).¹¹² Second, we conducted a repeatability analysis and found the final test procedure to be repeatable.¹¹³

5. ADB Adaptation Time

The NPRM included a 0.1 second or 1 m magnitude allowance for momentary glare exceedances. This was intended to account for variations in illumination due not to the ADB system but to uncontrolled or uncontrollable

¹¹¹ In addition, we note that the negative impacts of glare are not limited to disabling glare, but are also related to the annoyance and even painful experience of other roadway users. NHTSA’s 2008 research concluded that “the peak illuminance, rather than the dosage, was the primary factor associated with rated discomfort.” DOT HS 811 043 Nighttime Glare and Driving Performance: Research Findings, 2008.

¹¹² See Section VIII.C.10, Data Acquisition and Measurement.

¹¹³ See Section VIII.C.11, Repeatability.

testing variables. This differs from an allowance for an *adaptation time*, which would account for the operation of the ADB system—specifically, the time it takes an ADB system to recognize a stimulus (once the stimulus is within the camera’s field of view) and respond by dimming the beam, switching from an area of unreduced intensity to an area of reduced intensity. SAE J3069 specifies a 2.5 second maximum ADB adaptation time during the sudden appearance test drive. (The NPRM did not include a “sudden appearance” scenario because the system’s ability to respond quickly is exercised by the shorter-radii curve scenarios.) The NPRM did not propose a time limit within which an ADB system would be required to respond to a stimulus, but sought comment on whether one should be included in the regulation.

Comments

Some commenters interpreted the 0.1 second allowance for momentary glare exceedances as an adaptation time allowance.¹¹⁴ Mobileye, Ford, Honda, Volkswagen, and Auto Innovators contended that 0.1 second is not technically feasible and the final rule should specify a duration greater than 0.1 second because ADB systems need time to recognize the stimulus and modify the beam. Mobileye and Ford stated that without this, ADB systems would behave erratically, and Mobileye stated that it would result in many more false positives, leading to reduced visibility. Honda asserted that an insufficient time allowance would disincentivize the deployment of systems that operate over a wide range of conditions, and might especially be an issue on curves with a radius of 320–380 ft, on which an opposing vehicle will enter the ADB vehicle’s field of view suddenly at a close distance. Honda suggested an allowance for an adaptation time sufficient to ensure that ADB systems have an appropriate amount of time to react to the sudden appearance of other vehicles or when environmental lighting changes dynamically when driving.

Mobileye, Ford, Volkswagen, and Auto Innovators specifically supported the 2.5 second “reaction time” specified in SAE J3069. Ford commented that 2.5 seconds is reasonable based on its extensive experience with auto beam switching systems similar to ADB systems available internationally. Mobileye also noted that ECE R48

defines the minimal distance below which glaring is not allowed. Auto Innovators commented that its test data showed that a majority of exceedances were less than 2.0 seconds, with only a few exceedances over 2.5 seconds (limited to scenarios in which the stimulus vehicle was difficult to detect, such as the stationary motorcycle). Mobileye, Volkswagen, and Auto Innovators commented that 2.5 seconds would still be an improvement over human-driver reaction time.

In contrast, AAA asserted that 2.5 seconds is inordinately long, and that the reaction time should be decreased to approximately 1 second, based on its research which showed that glare from an oncoming vehicle lasting approximately 1 second was rated as highly distracting.

Agency Response

Although the final rule does not specify an allowable “adaptation time,” the agency does agree that the final rule should generally take into account how long it takes a typical, well-designed ADB system to respond. Typical ADB adaptation times are a little over 1 second. An ADB test report published by SAE in 2016 reported a reaction time of about 1.1 seconds.¹¹⁵ NHTSA’s testing showed comparable times, ranging from .56 seconds to 1.22 seconds when suddenly exposed to a stimulus.¹¹⁶ These reported adaptation times are much less than the 2.5 seconds specified in SAE J3069.

In addition, at the speeds the track tests are conducted, the test vehicles will cover a significant amount of the measurement distance within an adaptation time of 2.5 seconds (nearly 28 m at 25 mph, or 55 m at 50 mph). For example, the SAE sudden appearance scenarios specify that the fixture lamp be suddenly exposed when the test vehicle is between 155 m and 100 m from the fixture. At 55 mph (24.6 m/s) the test vehicle will have traveled 61.5 m in 2.5 s. If the fixture lamps were activated at 100 m, this means that the test vehicle would be about 40 m from the fixture by the time the 2.5 second allowance had elapsed. This would mean that only one illuminance value (at 30 m) would be evaluated by the SAE test. Similarly, in a real-world vehicle interaction, with two vehicles approaching each at 70 mph (31.3 m/s) each, if the ABD system takes 2.5 s to

react, the two vehicles will have traveled 157 m before the ADB system reacts.

After consideration of the studies and data discussed above, NHTSA believes that an ADB adaptation time of 2.5 seconds is exceedingly long. The final rule does not specify an adaptation time, however, because the final scenario parameters have generally been specified so that glare is not regulated until the fixture has been within the field of view of a typical ADB system (25 degrees to each side) long enough for the system to react (for example, in the small left curve scenario the fixture is within the camera’s field of view for approximately 1.24 s before the fixture enters the measurement distance range for that scenario). There are some exceptions to this. For some of the smaller-radii curve scenarios, the final rule begins regulating glare at a distance at which a typical ADB system might not have had time to react. Even here, however, there is not a need for an adaptation time because a typical ADB system would not exceed the glare limits even at these distances. At these further distances, because there will be a relatively wide angle between the test vehicle headlamps and the test fixture, the upper beam illuminance at those angles (and distances) is not likely to exceed the applicable glare limit. There is also no apparent safety need for directing high illuminance at such wide angles. These points are covered in more detail in the sections below for the various test scenarios.

6. Test Fixture Specifications

The NPRM identified test fixtures, including those specified in SAE J3069, as a regulatory alternative. The NPRM explained that SAE J3069 specifies four test fixtures: An opposing car/truck fixture; an opposing motorcycle fixture; a preceding car/truck fixture; and a preceding motorcycle fixture. The NPRM explained that the SAE fixtures are fitted with lights intended to simulate actual vehicle lamps; the lamps are intended to represent reasonable worst-case for intensity and location and promote repeatability. For headlamp representations, the SAE standard specifies a lamp projecting 300 cd of white light in a specified manner and angle instead of actual headlamps. In addition to being intended to represent a reasonable worst-case condition, the SAE J3069 rationale also states a “concern that if the actual lower beam headlamps were used on the opposing vehicle test fixture the large gradients present in typical lower beam patterns would cause unnecessary test

¹¹⁴ The proposed allowance for momentary glare exceedances (intended to account for uncontrolled test-related variability) is discussed in Section VIII.C.10.d.

¹¹⁵ Assessment of Adaptive Driving Beam Photometric Performance (SAE 2016–01–1408), p. 3. This included the time it took for an experimenter to turn on the stimulus vehicle headlamps at a predetermined distance, so the actual system response time was shorter than this.

¹¹⁶ 2015 ADB Test Report, p. 92.

variability.”¹¹⁷ For the taillamp representations, SAE J3069 specifies lamps emitting no more than 7 cd of red light in a specified manner and angle. The fixtures are fitted with photometers positioned near where a driver’s eyes or the rearview/side mirrors would be located to measure illumination from the ADB test vehicle headlamps.¹¹⁸ The lamp and photometer locations are based on “median location values provided by [the University of Michigan Transportation Research Institute].”¹¹⁹

The NPRM identified and sought comment on potential issues with the SAE J3069 fixture specifications, particularly whether using simulated lamps instead of actual vehicle lamps was sufficiently realistic. We stated that test fixtures may encourage an ADB system designed to ensure identification of test fixtures rather than actual vehicles, which might not adequately ensure that the system performs satisfactorily when faced with a wide range of real-world vehicles and, particularly, real-world vehicle lighting. We stated that we were not confident that the lamps specified in SAE J3069 represented a worst-case scenario. As one example of this, we noted that the minimum intensity allowed for a taillamp is 2.0 cd at H–V and as low as 0.3 cd at an angle of 20 degrees. These values are considerably lower than the 7.0 cd lamp specified in SAE J3069. We therefore sought comment on the extent to which narrowly-defined lamps can be used to establish performance requirements that reasonably ensure an ADB system will recognize and adapt appropriately to the wide range of lighting configurations permitted under FMVSS No. 108. We also noted, with respect to the concern raised in SAE J3069 that using actual lower beam headlamps on the opposing vehicle fixtures would lead to test variability, that in the real world an ADB system must be able to identify headlamps from many different types and models of vehicles; if an ADB system was so sensitive to actual headlamp gradients that those gradients affected ADB system performance, the variability would be attributable to the ADB system, not the test.

Comments

The agency received several comments relating to test fixture specifications. While many manufacturers urged NHTSA to adopt

SAE J3069,¹²⁰ some commenters identified potential concerns with the SAE J3069 fixtures. Mobileye commented that the major drawback of SAE J3069 is the use of synthetic stimulus light sources, which presents a challenge because in actual driving scenarios, the system is trained to ignore the types of synthetic light sources specified in SAE J3069 because they are more likely to be lights from houses, driveways, or other non-vehicle sources. Mobileye pointed out that vehicle headlamps differ from the SAE fixtures in shape, power source (DC), and having a distinct non-uniform light dispersion pattern. Mobileye suggested that placing lamps on static fixtures will force an ADB system to react to light sources even when it positively recognizes them as not being part of a vehicle. Mobileye recommended that the fixture closely resemble a “uniform” or “standard” vehicle with lamps representative of those approved by FMVSS No. 108 instead of the static fixtures specified in SAE J3069, so as not to force the ADB system to downgrade its real-life performance to comply with a synthetic test.¹²¹ Intertek commented that it is possible for image recognition software to be adjusted to specifically identify and respond to the SAE J3069 test fixture and test track without necessarily ensuring adequate real-world performance.

We also received comments on the proposed stimulus vehicle lighting that are equally relevant to test fixture lighting. Bosch recommended that, to ensure system robustness, NHTSA specify stimulus vehicles with a wide variety of light source technologies and consider utilizing a reference publication such as the Ward’s Automotive Yearbook to stay current with rapidly evolving headlamp technology. Honda noted that the NPRM did not specify which headlamp beams should be activated on the stimulus vehicle and suggested that the final rule clarify that this is the lower beam. Auto Innovators raised the possibility of a situation where the regulation specifies a specific vehicle or vehicle component, but the item is later determined to be noncompliant or subject to manufacturer in-cycle design changes or modifications. Auto Innovators suggested that this potential for non-compliance presents an unforeseeable uncertainty to the compliance process, because such changes will not always be known at the time a manufacturer of the

ADB vehicle conducts self-certification testing or to a third-party conducting compliance testing for the agency.

Agency Response

The final rule specifies test fixtures conforming to SAE J3069 with respect to the types of fixtures and photometer placement. The final rule departs from SAE J3069 by specifying vehicle lamps from high-selling vehicles instead of lamps intended to simulate vehicle lighting.

The final rule specifies the same four types of fixtures specified in SAE J3069: An oncoming car/truck fixture; a preceding car/truck fixture; an oncoming motorcycle fixture; and a preceding motorcycle fixture. The final rule follows the SAE specifications for the locations of the stimulus lighting. SAE based these locations on data regarding the typical mounting locations of vehicle lighting. NHTSA agrees that these locations are appropriate, and within the FMVSS No. 108 mounting location requirements.

The rule also follows SAE J3069 for the locations of the illuminance meters. SAE based these locations on data regarding typical driver’s eye heights and mounting locations for the rearview/side mirrors. The illuminance meter locations specified in the final rule are the same as in the proposal, with one exception. In its recent revisions to SAE J3069, SAE revised the specifications for the placement of the illuminance meters (corresponding to two side-view mirrors) on the preceding motorcycle fixture. The revision notes that the figure depicted in the prior version of the practice showed the mirrors to be 0.2 m from the centerline of the rear position lamp, which is not consistent with the FMVSS No. 111 required minimum. FMVSS No. 111 requires that each motorcycle have a mirror “mounted so that the horizontal center of the reflective surface is at least 279 mm outward of the longitudinal centerline of the motorcycle.”¹²² The revised version of SAE J3069 shows the motorcycle mirror separation to be 0.4 m, which is consistent with the FMVSS No. 111 required minimum. The specification in the final rule adopts this revised specification.

We did, however, agree with Mobileye that—as we also tentatively concluded in the NPRM—the simulated lamps specified in SAE J3069 would not be sufficiently realistic. We therefore agreed with Mobileye’s and Auto Innovators’ suggestions to use standardized vehicle lamps on the fixtures. The final rule therefore departs

¹¹⁷ SAE J3069, p. 4.

¹¹⁸ SAE J3069 5.5.2 and Figures 1 and 2 (opposing vehicle fixture); 5.5.3 and Figures 3 and 4 (preceding vehicle fixture).

¹¹⁹ SAE J3069, p. 3.

¹²⁰ See Section VIII.O, Regulatory Alternatives.

¹²¹ Auto Innovators also suggested using standardized headlamps and taillamps in lieu of the proposed broad range of actual stimulus vehicles.

¹²² S10.1.

from SAE J3069 and specifies actual vehicle lamps for the fixtures. The reasons for this choice are explained in more detail below. The final rule specifies headlamp assemblies from a 2018 Ford F-150 (halogen) and a 2018 Toyota Camry (LED). For motorcycles, the final rule specifies a 5.75 inch headlamp assembly from a 2018 Harley Davidson Sportster using an HB2 replaceable light source.¹²³ The rule specifies right and left taillamp assemblies from a 2018 Ford F-150 incandescent rear combination lamp and right and left tail lamp assemblies from a 2018 Toyota Camry combination lamp. For motorcycles, the final rule specifies a layback LED taillamp assembly from a 2018 Harley Davidson Roadster.

There were several reasons for specifying actual vehicle lamps. NHTSA agrees with the concerns Mobileye identified regarding the use of synthetic fixture lighting and with Intertek that specifying synthetic lighting could result in vehicle manufacturers programming systems to recognize unrealistic fixtures, thus decoupling compliance test performance from actual performance.¹²⁴ The agency's intent was to specify a variety of light source technologies that are common in the market in order to assess how an ADB system performs with respect to light systems it will encounter while in actual use on the roads. This will discourage manufacturers from designing specifically to fixture lamps lacking characteristics typical of actual automotive lamps (e.g., non-uniform illuminance, variations in shape). Using actual vehicle lamps also reduces the cost of manufacture of the test fixture (since the highly specialized SAE fixture lighting is much more expensive). The agency agrees with Bosch that it is important that the lamps on the fixtures continue to be representative of vehicle lamps in use. To that end, NHTSA envisions future technical rulemakings to amend the lamps specified in the regulatory text.

The agency also does not believe that the synthetic light sources specified in

SAE J3069 represent a worst-case scenario. As NHTSA explained in the NPRM, the minimum taillamp intensities allowed by FMVSS No. 108 (2.0 cd at H-V and as low as 0.3 cd at 20 degrees) are considerably lower than the 7.0 cd lamp specified in SAE J3069. NHTSA also does not agree with SAE that specifying actual vehicle headlamps would result in excessive variability, but continues to believe, as stated in the NPRM, that gradients in typical headlamp beam patterns would likely only affect the repeatability of the test if the reaction by the ADB system changes based on this difference. If this is the case, the ADB system will have this issue in actual use (especially since the specified headlamps are from high-selling vehicles and therefore common on the road), and this should not be considered variability attributable to the test, but a failing of the ADB system. In any case, NHTSA's testing showed that the tested ADB system was generally able to recognize the fixtures fitted with these lamps. Comparative test data for the SAE fixtures and the final rule fixtures is presented in the discussions for each scenario (see Section VIII.C.8).

The final rule also clarifies various aspects of the test procedures related to the fixture lamps. It clarifies that the stimulus headlamps will have the lower beam activated and aimed per the SAE Recommended Practice J599 *Lighting Inspection Code* (J599) procedures, as applicable. The final rule also specifies how to power the fixture lamps. SAE J3069 does not specify how to power the test-fixture lighting; this could leave open the possibility of powering the fixture in ways that are dissimilar to how actual automotive head and taillamps are powered, and potentially lead to ambiguities in how performance is measured. Accordingly, the final rule specifies that the lamps will have been energized for at least 5 minutes before each test scenario trial is performed.

The agency considered Mobileye's comment that the fixture should resemble a "standard" vehicle but decided not to adopt this. Using a fixture incorporating vehicle elements (e.g., hood, grill) raises issues of which elements to specify and how to specify them. NHTSA did consider implementing a portion of a vehicle in the fixtures, such as a partial front or rear section of a vehicle that would include the original equipment lamps as mounted in the production vehicle. Including a portion of the actual vehicle body would provide a more real-world stimulus with the added detail of some elements of vehicle shape and light reflections on the body surfaces. However, while this option was not

examined in NHTSA's research, our research did not demonstrate any significant difference in ADB response between actual stimulus vehicles and the test fixtures we are specifying, suggesting that adding detail elements to the fixture is not necessary.¹²⁵

With respect to Auto Innovators' comment regarding the possibility of a noncompliance of actual vehicle components used as a stimulus in a compliance test, NHTSA recognizes this possibility, but anticipates that the laboratory test procedures will provide for confirming that the vehicle lamps used on the test fixture comply with the applicable FMVSS No. 108 photometry requirements.

7. Test Fixture Placement

The proposal specified stimulus vehicles in the adjacent left lane to evaluate oncoming glare. To evaluate preceding glare, it essentially specified the stimulus vehicle either in the same lane as the test vehicle or in the adjacent left lane.

The final rule, while specifying test fixtures, generally follows the NPRM approach. The test fixture will be placed in the adjacent left lane (from the perspective of the test vehicle) to evaluate both oncoming glare and preceding glare, essentially the same placement as proposed.¹²⁶ See Figure 10 (Figures 27–28 in the regulatory text). This corresponds to Fixture Position 2 in SAE J3069. The final rule does not specify fixtures situated similarly to SAE Positions 1 and 3. In the SAE test method, fixtures placed in those locations are primarily intended to simulate curves; the final rule includes curved-path scenarios, so simulating curves with strategic fixture placement is not necessary. The final rule also specifies that the projection of the fixture lamp's optical axis onto the road surface should be tangent to the road edge at the location of the photometer, and that the fixture be centered in the lane.

¹²³ This is different than the motorcycle headlamp used in NHTSA recent testing. For that testing, NHTSA used a 5.75 inch bullet headlamp kit from a 2018 Harley Davidson Roadster using an HB2 replaceable light source (part #68593-06). After that testing and before the publication of this final rule, that part went out of production and has been replaced with part #68297-05B.

¹²⁴ SAE J3069 MAR2021 added a note requiring that any pulse width modulation or similar frequency control be sufficiently above the commercial power grid frequency and updated the conical angle specification. Even with these changes, NHTSA still believes that the finalized vehicle lighting is more appropriate.

¹²⁵ SAE J3069 MAR2021 allows the fixture to be "constructed in a manner that represents the intended vehicle type to avoid false readings that the stimulus fixture is not a vehicle" (sections 5.5.2.1 and 5.5.3.1). As noted in the text, we considered but did not examine this alternative. However, we believe, based on the results of our testing (see Section VIII.C.2, Test Fixtures vs. Stimulus Vehicles), that specifying actual vehicle lamps makes the fixtures sufficiently realistic so that the ADB system will recognize the fixture as a vehicle.

¹²⁶ The test vehicle will be driven within the right adjacent lane and will not change lanes.

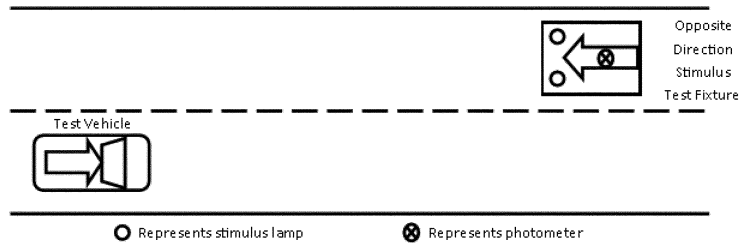
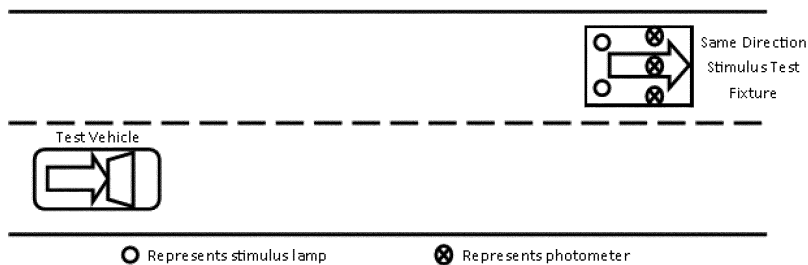
Figure 10. Final Rule Test Fixture Placement**Opposite Direction Test Scenario****Same Direction Test Scenario****BILLING CODE 4910-59-P**

NHTSA acknowledges that it is common in real-world driving for preceding vehicles to be located in the same lane or in the adjacent right lane. However, the agency believes that simply testing with the preceding fixture in the left adjacent lane will not result in a loss of information about ADB system performance. The purpose of the testing is to evaluate whether the ADB system is working in an integrated fashion; this can be done on either side. While real-world situations with a stimulus to the right side are common, it is reasonable to expect that if a system functions on the left it will also function on the right. Further, the final rule also has tests that include curves to the right, where the detection system is exercised (limited to oncoming and limited distances) on the right side of the field of view.

8. Test Scenarios¹²⁷**a. Scenario 1: Oncoming Straight**

The NPRM proposed testing for oncoming glare in a straight-path test

¹²⁷ The test scenario numbering used in the preamble and in the final rule regulatory text (at Table XXII) differs somewhat from the test scenario number in the ADB test report and repeatability assessment docketed with this final rule.

scenario at speeds from 60 mph to 70 mph at measurement distances of 15 m to 220 m.

Comments

ALNA, Toyota, SAE, and the Alliance commented that the proposed glare limits are at or well below those regularly occurring today from lower beams, including, the commenters appeared to suggest, in a straight-path scenario. SAE and the Alliance stated that the glare limits are not reasonable if lower beams, including IIHS “Good”-rated lower beams, would fail to comply. SAE provided a graphical analysis (based on IIHS data) of lower beam illuminance on a straight road (from 0 m to 125 m) for nine MY 2017 IIHS Top Safety Picks, all with FMVSS 108-compliant IIHS-rated “Good” headlamps. The graph shows that almost all those headlamps complied with the proposed glare limits at all proposed measurement distances.

Agency Response

NHTSA is finalizing the proposed specifications for this scenario, including the proposal to evaluate illuminance from 15 m to 220 m. The rule thus evaluates glare across a broader range of distances than SAE

J3069, which evaluates glare at 30 m, 60 m, 120 m, and 155 m, respectively. The reasons for choosing this range are discussed in the NPRM (83 FR at 51778–51781) and elsewhere in this preamble.

The available data indicate that current lower beams can comply with the glare limits in this scenario. The IIHS data submitted by SAE show that the lower beams for the 9 vehicles for which data was provided were generally within the glare limits on a straight road for all the distances for which the final rule regulates glare. NHTSA’s testing also shows that current lower beams would pass this scenario. NHTSA tested the lower beams of a MY 2019 Ford Fusion and MY 2016 Volvo XC90 in this scenario. The measured illuminance of the lower beams was found to be within the glare limits by a considerable margin at all distances. See Figure 11 and Figure 12.¹²⁸

¹²⁸ The illuminance measured from the higher-mounted photometer representing the truck driver eye point, is, as expected, lower than that measured from the lower-mounted photometer intended to represent a passenger car driver’s eye point. For that reason, some of the test data included in this preamble may not report the illuminance values measured from the higher-mounted illuminance meter.

Figure 11 – Ford Fusion Lower Beams
(Straight Scenario)

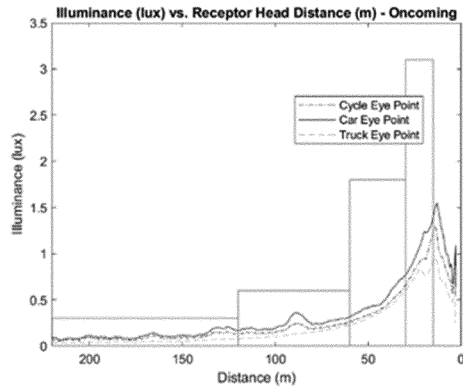
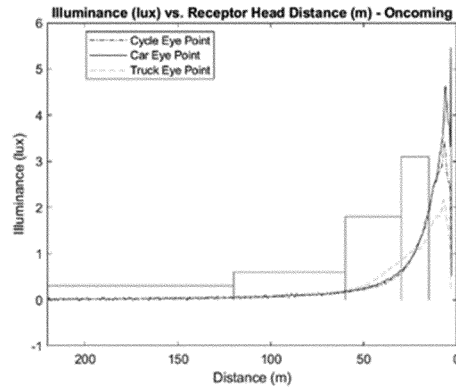

Figure 12 – Volvo XC90 Lower Beams
(Straight Scenario)



NHTSA's analysis and testing also indicate that current ADB systems can reasonably be expected to comply with this scenario. As Figure 7 makes clear, the fixture is within the ADB camera's field of view at the beginning of the measurement range, at less than 5 degrees left of the center of the field of view. (As noted earlier, the field of view of current ADB systems extends to about 25 degrees left and right.) Accordingly, the ADB system should have sufficient time to detect and react to the fixture stimulus lamps and adjust the beam.

The agency's ADB test data confirms this. For example, the ADB system we tested was within the glare limits at all distances when tested with the oncoming car/truck fixture. See Figure 13. Additionally, NHTSA's 2015 testing showed that an older ADB system was able to pass this scenario even when tested with stimulus vehicles, both moving and stationary.¹²⁹

¹²⁹ 2015 ADB Test Report at p. 103 (Table 23) (results for Audi show adaptive beam within the glare limits at all distances on the straight scenario, with both a static and dynamic stimulus vehicle).

The ADB system also passed the SAE scenario that is the closest analog to this scenario (with the car/truck test fixture in Position 2), and NHTSA did not see a significant difference between performance on the NHTSA and SAE test protocols here.¹³⁰ See Figure 13.

Audi indicated that the shaded area of the adaptive beam complied with the FMVSS No. 108 lower beam requirements.

¹³⁰ Agency testing showed some anomalies when testing with the motorcycle fixtures (both the final rule fixture and the SAE fixture). For that reason, the results of that testing are discussed separately. See Appendix C.

Figure 13: Lexus ADB, Straight Scenario (69 mph)
Camry Headlamps And SAE Fixture Position 2

Comparison of Responses - SAE Fixture 2 vs. NHTSA Straight
(Oncoming, Cars Only)

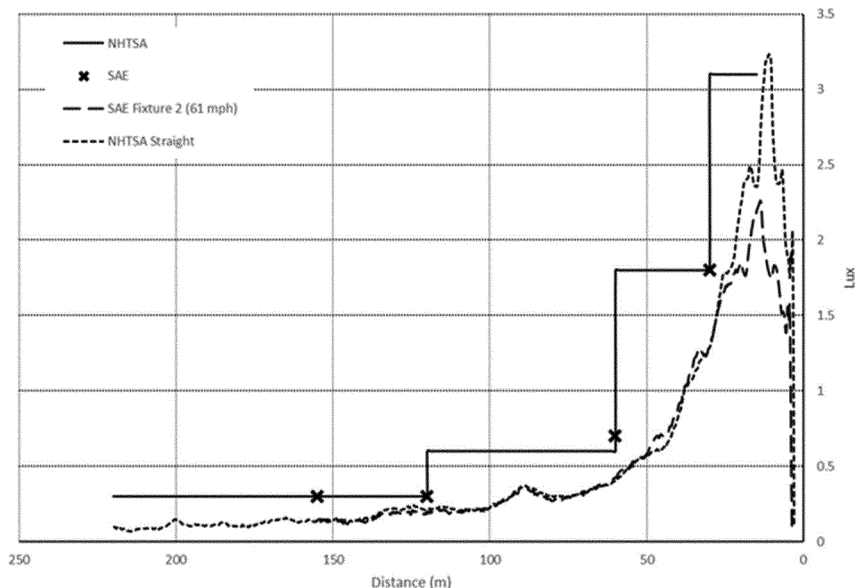

b. Scenario 2: Oncoming Small Left Curve

The NPRM provided for testing oncoming glare on left curves with radii of 98 m to 116 m, at speeds from 20 mph to 30 mph, for the full range of 15 m to 220 m.

Comments

In addition to general comments from several manufacturers that the proposal would require ADB systems to produce less glare than current FMVSS No. 108-compliant lower beams, particularly on curves, SAE provided a graphical analysis of IIHS data of illuminance from nine “Good”-rated lower beams from 0 m to 125 m on a 150 m left curve. The data show that almost all the lower beams were within the glare limits in this entire range, except that one vehicle occasionally exceeded the glare limits between 15 m and 60 m, one vehicle exceeded the glare limits at 15 m, and a couple of vehicles exceeded the glare limits between about 60 m and 90 m.

The Alliance, SAE, OICA, and SMMT commented that current ADB systems would not comply with this scenario because it would necessitate a camera field of view wider than provided on current ADB systems. The Alliance stated that the camera visibility needed to detect a stimulus vehicle on this curve is almost 45 degrees (with a median) and 40 degrees (without a

median). Both the Alliance and SAE contended that, should this scenario be retained, camera visibility would have to be extended, which would increase costs, potentially diminish performance in the more critical central portion of the visibility zone, and create disharmonization, limiting the availability of ADB systems in the United States. SAE also stated that upper beams at greater than 15 degrees left or right are not as bright as lower beams straight ahead, and at an angle of 40 degrees the light toward a stimulus vehicle driver is low. SAE stated that this is supported by the fact that millions of semiautomatic beam systems on the roads today are equipped with the same or similar forward vision cameras and detection algorithms as ADB systems and have not resulted in glare complaints. This suggests, SAE asserted, that wide angle visibility (*i.e.*, beyond 25 degrees) is unnecessary and precludes any need to test on curves of these radii.

Honda commented that the proposed 0.1 s or 1 m allowance for momentary spikes does not allow enough time for an ADB system to respond to sudden changes in stimulus lighting, and that this especially might be an issue on curves with a radius of 98 m–116 m, on which an opposing vehicle will enter the ADB system’s field of view suddenly at a close distance.

Agency Response

The final rule retains this scenario but modifies the distances at which illuminance from the ADB system is evaluated: The measurement range now begins at 59.9 m¹³¹ instead of the proposed 220 m. The reasons for this are explained below.

First, the available data indicate that current, FMVSS 108-compliant lower beams might not comply with the glare limits at distances greater than 60 m but would generally comply at closer distances. The IIHS data submitted by SAE show that almost all the tested lower beams were almost fully within the glare limits in the modified distance range (15 m–59.9 m), while some of the lower beams exceeded the glare limits for distances greater than 60 m. NHTSA’s testing also shows that current lower beams would pass this modified scenario. NHTSA tested two vehicles with lower beams activated on an 85 m left curve, and both vehicles performed well with considerable margins. See Figure 14.

¹³¹ In the regulatory text this is specified as “less than 60 m.” Other distance specifications are stated similarly. The preamble discussion simplifies this for ease of exposition.

Figure 14. Lower beam performance on 85 m Left curve

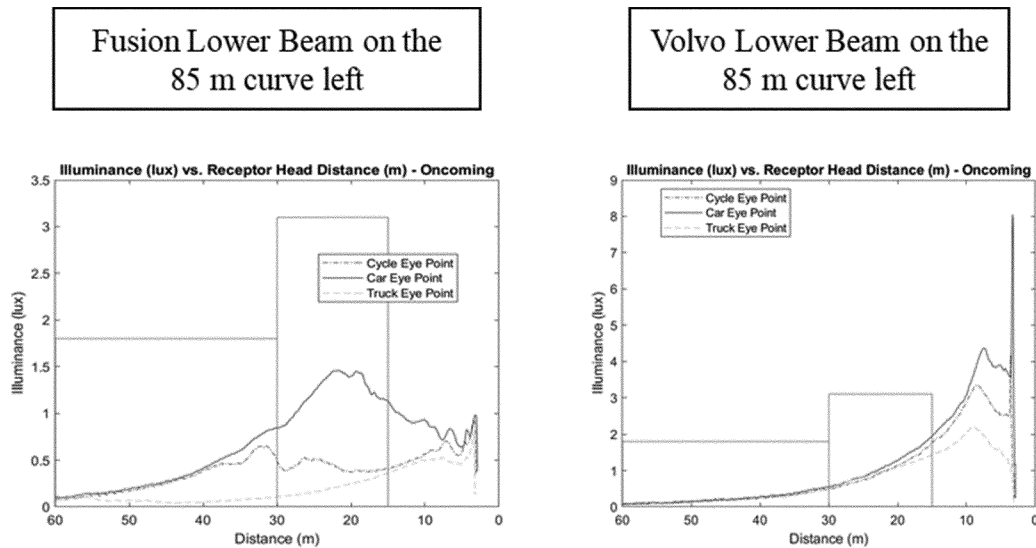

Next, NHTSA believes that this modified specification is within the capabilities of most current ADB systems. On a curve with a 100 m radius, at the highest vehicle speed specified for this scenario (30 mph), the fixture will enter the camera's field of view (25 degrees) at 77 m (see Figure 7). At the distance at which the final rule begins evaluating the system's illuminance (59.9 m), the fixture is therefore well within the camera's field of view (at about 21 degrees). The fixture is not only within the camera's FOV, but has been within the FOV for 1.24 s, which is a sufficient time for an ADB system to react. NHTSA acknowledges that for shorter radii in the specified range, the time elapsed between the fixture entering the system's field of view and the test vehicle reaching the beginning of the evaluation range (59.9 m), may not

provide sufficient time for an ADB system to react and switch from an area of unreduced intensity (*i.e.*, upper beam) to an area of reduced intensity. For example, on a curve with an 85 m radius at 30 mph, the fixture will enter the camera's field of view at 63 m. At 59.9 m, the fixture will have been within the system's FOV for 0.13 s. The agency does not, however, expect this to result in a noncompliance because at that distance the headlamps are at a large enough angle to the photometer that the upper beam should be within the glare limits. (Agency testing generally showed that the upper beam was within the glare limits at angles greater than 20 degrees. There are no upper beam photometry requirements at angles wider than 12 degrees. At 12 degrees, Table XVIII specifies (depending on the type of upper beam)

a minimum of, at most, 1,500 cd (at horizontal) and 1,000 cd (at 2.5D).

NHTSA's ADB test data bear this out. When NHTSA tested an ADB system at 29 mph on a curve at the upper bound of the range (115 m), the ADB system detected and reacted to the fixture prior to the measurement range. See Figure 15. On the other hand, when testing the ADB system on a curve at the lower bound of the radius range (85 m), the system did not react to the fixture and dim the beam until 41 m—which is after the specified beginning of the measurement range (59.9 m). See Figure 16. However, the illuminance (the upper beam) at these large angles was below the applicable glare limit, and the system was able to react and adapt the beam before the geometry was such that the narrower angle of the upper beam would exceed the glare limit.

Figure 15 - Lexus ADB 29 mph on the 115-m curve Left (Camry HL)

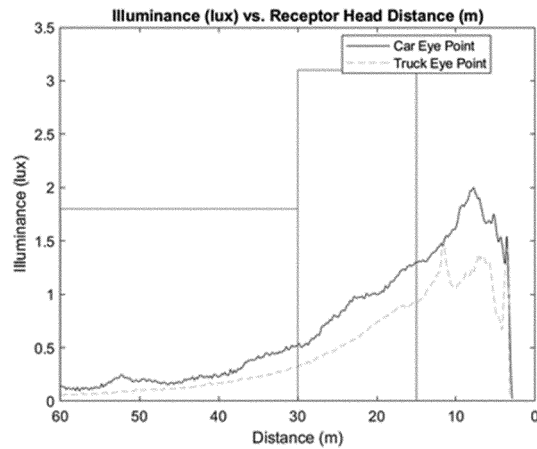
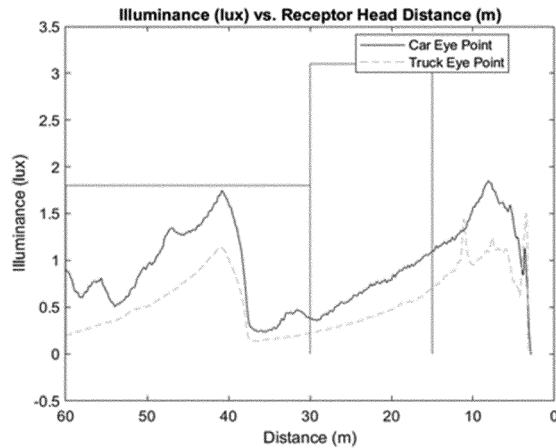

Figure 16 - Lexus run on the 85 m curve left.



NHTSA also tested the SAE scenario that is the closest analog to this scenario (with the oncoming fixtures in Position 1) and observed no glare limit exceedances. See Figure 17. However,

the illuminance was, for closer distances, significantly lower than the illuminance measured during the corresponding final rule scenario. This is because, as the test vehicle

approaches the SAE fixture, the fixture moves more and more off-angle from the test vehicle as the distance closes, resulting in lower-than-expected illuminance.

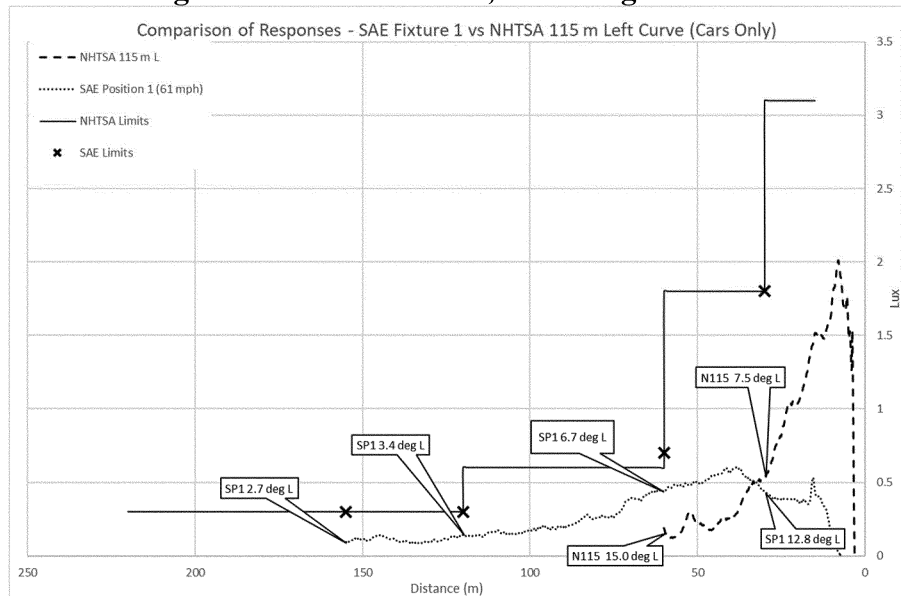
Figure 17. SAE Fixture 1, oncoming car

Note: Illuminance as measured from photometer corresponding to the passenger car driver's eye point.

NHTSA notes that this scenario, as modified, does not evaluate illuminance from 60 m to 220 m, so it would not test whether the ADB system switched from an upper beam to an adaptive beam in this range. In the NPRM the agency tentatively concluded that it was important to regulate illuminance in the full range of 15 m–220 m. However, as explained above, NHTSA decided the full range is unnecessary because an upper beam projected at angles larger than 20 degrees is not glaring at distances beyond those at which we are evaluating illuminance in this scenario.

c. Scenario 3: Oncoming Medium Left Curve

NHTSA proposed testing for oncoming glare on left curves with radii of 223 m to 241 m, at speeds of 40–45 mph, for the full range of 15–220 m.

Comments

NHTSA received one comment specifically related to this scenario. SAE provided a graphical analysis of IIHS illuminance data (out to 125 m) for nine lower beams on a 250 m left curve showing that all the lower beams were within the glare limits, except for two headlamps that had some exceedances between 60 m and 110 m. As noted earlier, some commenters argued more generally that the proposed glare limits were so stringent that even currently-compliant lower beams would exceed them.

Agency Response

The final rule modifies the measurement range, which now begins at 150 m instead of the proposed 220 m. The rationale for this is analogous to the rationale for limiting the measurement distances for the small left curve.

First, the available data indicate that compliant lower beams would generally comply with these requirements. As explained earlier, this (in conjunction with the requirement that areas of reduced intensity meet the corresponding lower beam laboratory photometric requirements) means that an area of reduced intensity, up to and including a full lower beam, will meet the same level of safety (with respect to both visibility and glare prevention) as current lower beams certified to FMVSS No. 108. The IIHS data submitted by SAE shows that almost all the tested lower beams complied with the glare limits for the distances for which data was reported. NHTSA's testing also shows that current lower beams would pass this modified scenario; both lower beams NHTSA tested had illuminance values within the glare limits by a considerable margin. See Figure 18.

Figure 18. NHTSA Lower beam data

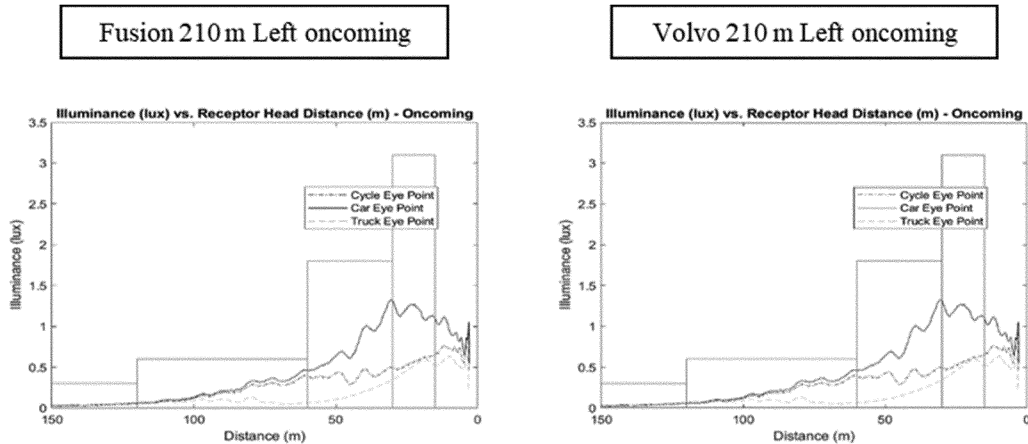

Next, NHTSA’s analysis also indicates that the modified specifications are within the field-of-view and adaptation time capabilities of most current ADB systems. For example, on a 230 m curve at 45 mph, over two seconds elapse between the fixture entering the field-of-view and the vehicle reaching the measurement range (150 m), providing the ADB system sufficient time to react and adapt the beams. As with the small left curve, however, for shorter radii in the specified range, the time elapsed between the fixture entering the ADB system’s field of view and the vehicle reaching the beginning of the measurement range may not provide

sufficient time for the ADB system to adapt and switch from an area of unreduced intensity to an area of reduced intensity. For example, on a 210 m curve, only .57 seconds elapse. However, as with the small left curve, at those distances the headlamps are at a large enough angle to the photometers that the upper beam should be within the applicable glare limit.

Again, NHTSA’s ADB test data bears this out. NHTSA tested an ADB system on a 210 m left curve at 44 mph. See Figure 19. The measured illuminance values were within the glare limits except for two exceedances lasting less than 0.1 s (which would not be

considered a noncompliance because they are within the allowance for momentary glare exceedances). The ADB system reacted to the fixture at 120 m. Prior to that (*i.e.*, from 150 m to 121.9 m), the ADB system was projecting an upper beam, but the upper beam was within the glare limits.

In comparison, when testing the most analogous SAE test scenario (with the fixture in Position 1) there were no glare limit exceedances, and, at closer distances, the SAE test scenario resulted in lower illuminance values than were measured on the actual left curve.

Figure 19. Lexus ADB 210 Left (Camry Headlamps)

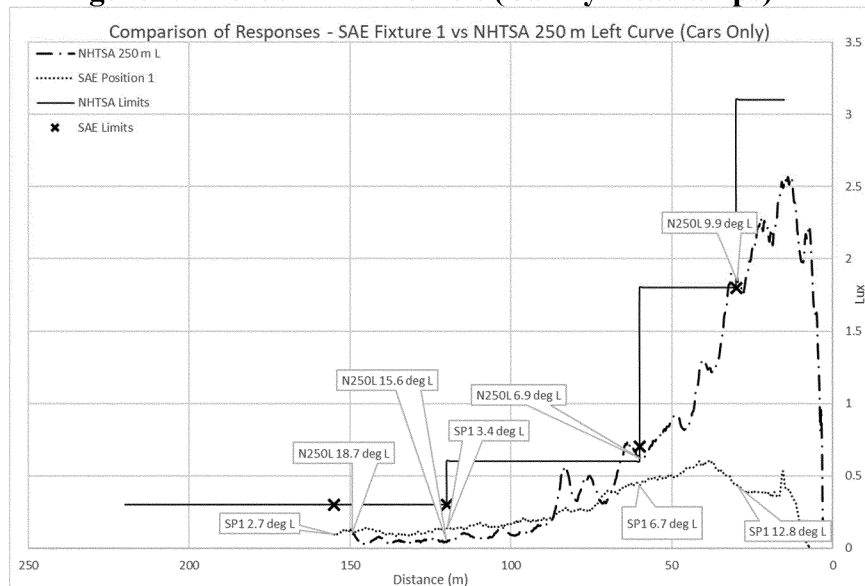

In addition, as noted earlier for the small left curve scenario, although the final rule reduces the start of the measurement distance in this scenario from 220 m to 150 m, this should not present a risk that oncoming vehicles will experience glare outside of 150 m for the reasons discussed earlier.

d. Scenario 4: Oncoming Large Left Curve

The NPRM specified testing for oncoming glare on left curves with radii of 335–396 m, at speeds of 50–55 mph, from 15 m to 220 m.

Comments

NHTSA did not receive any comments that related specifically to this curve. Commenters argued more generally that currently-compliant lower

beams would not always comply with the glare limits, especially on curves, and that there might not be sufficient time for the ADB system to react to the stimulus lighting.

Agency Response

The final rule adopts this scenario essentially as proposed (the largest-specified radius of curvature has been rounded up). Both a lower beam and an ADB system can reasonably be expected to comply with the glare limits throughout this range.

The available data indicate that current FMVSS No. 108-compliant lower beams can comply with the glare limits in the full measurement range. The IIHS data submitted by SAE did not include a left curve with a radius this

large. However, the IIHS data did include lower beam performance on a 250 m radius left curve and a straight road. As explained in the preceding section for the medium left curve scenario, all the IIHS-tested headlamps were essentially within the glare limits at all distances for which data was reported (out to about 125 m) on both the 250 m left curve and the straight road. Because the curve in this scenario is essentially between a 250 m left curve and a straight road, it is reasonable to extrapolate that the lower beams tested by IIHS would also have complied on left curves with radii greater than 250 m. NHTSA’s test data confirms this. Both the Fusion and the Volvo lower beams were within the glare limits on this curve. See Figure 20.

Figure 20. NHTSA-tested lower beams on large left curve scenario

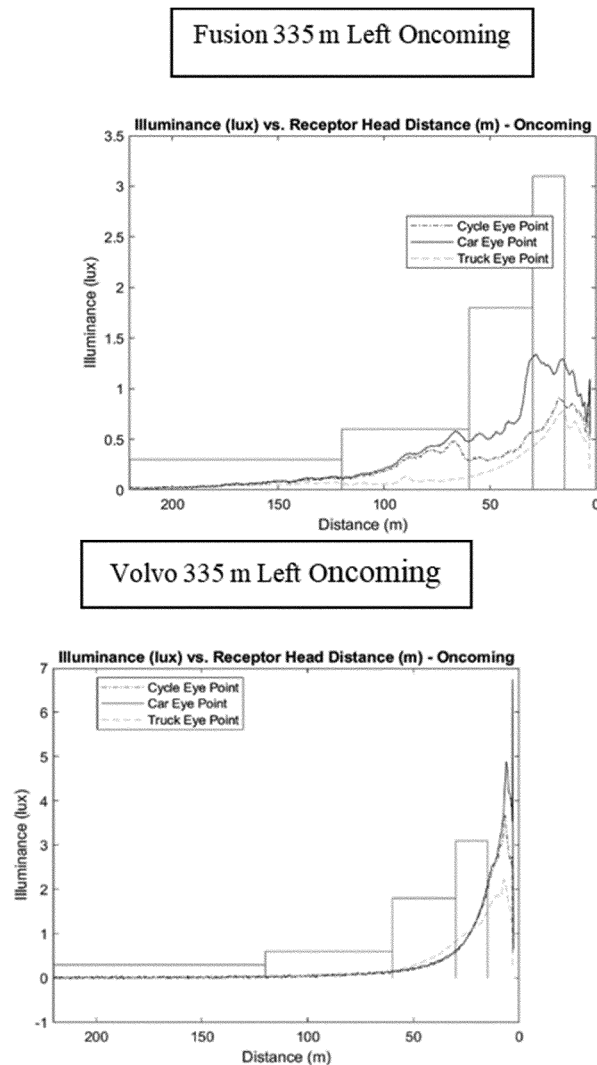

These specifications are also within the capabilities of current ADB systems. On a curve with a 335 m radius at the highest speed specified for this scenario (55 mph), the fixture will enter the camera’s field of view (25 degrees) at 283 m (see Figure 7). At the distance at which we will begin evaluating the system’s illuminance (220 m), the fixture is therefore well within the camera’s field of view (at about 20

degrees), and has been within the FOV for 1.27 s, which is sufficient time for an ADB system to react.

NHTSA’s testing confirmed this. The ADB system tested was generally able to respond and shade the fixture in this scenario. See Figure 21. The system reacted at 185 m and performed well from a recognition standpoint. The area of reduced intensity exceeded the limits in the 60–120 m range as well as the 30–

60 m range. Because these exceedances last longer than 0.1 s. and occur while the vehicle pitch is less than 0.3 degrees from the average pitch throughout the run, these exceedances would be considered possible noncompliances. However, these failures are relatively marginal, and the beam pattern could be modified to fully comply with this scenario.

Figure 21. Lexus 335 m Left

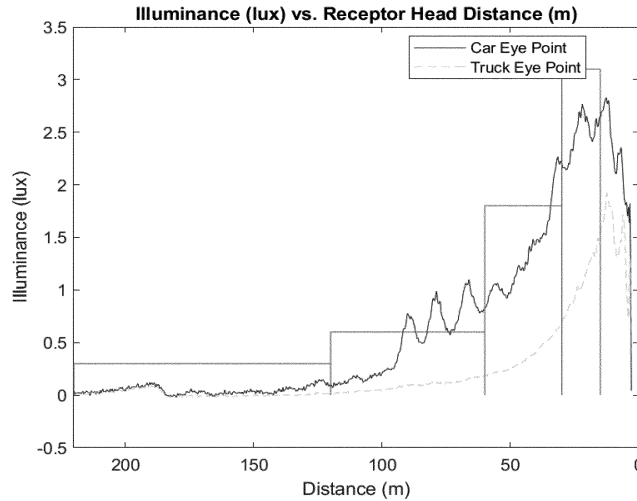

As with the other oncoming left curve scenarios, the closest SAE test analogue is with an oncoming fixture in Position 1. Again, NHTSA’s testing showed that, compared to NHTSA’s test, the SAE test

resulted in much lower illuminance at close distances than on an actual curve. See Figure 22. Thus, data indicate again that the two test methods can yield different results, and that the actual

curve test is preferable because it would be more evaluative of real-world performance.

Figure 22. SAE test vs. large oncoming curve scenario

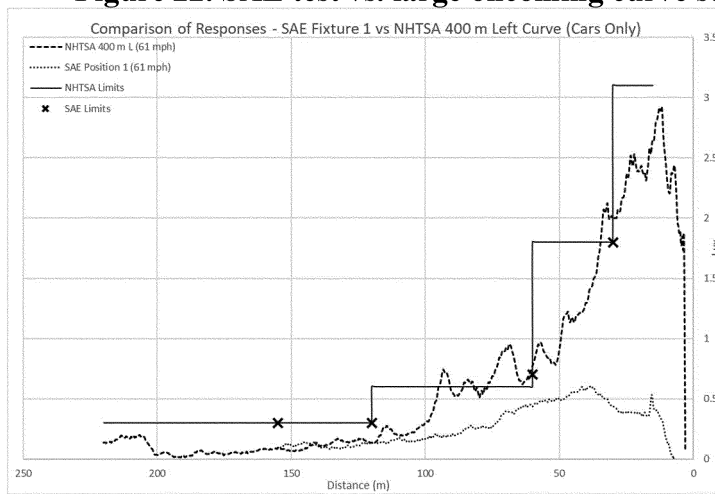

BILLING CODE 4910-59-P

e. Scenario 5: Oncoming Medium Right Curve

The NPRM proposed regulating glare on right curves with a radius of 223 m

to 241 m, at speeds of 40–45 mph, from 15 m to 220 m.

Comments

SAE provided a graphical analysis of illuminance data for nine IHS “Good”-rated lower beams on a 250 m radius right curve from 0 m to 125 m and

stated that it demonstrated none of those lower beams would meet the proposed glare limits. Other commenters argued more generally that current lower beams would exceed the proposed glare limits, especially on curves. Intertek commented that NHTSA should limit the range for right-hand curves to account for lower beam patterns at 3 degrees right. Stanley ran simulations for a 232 m radius right curve and commented that the proposed glare limits appeared to be inconsistent with the current photometric requirement for lower beams at several points (especially from 1R to 3R). It asked that the agency reconsider the proposed glare limits and make them consistent with the current regulatory requirements for lower beams.

Agency Response

The final rule retains this scenario but revises the measurement range to begin at 50 m instead of the proposed 220 m.

NHTSA agrees with the commenters that current compliant lower beams—especially ones that perform well on the IIHS test—would likely not comply with the glare limits from 51 m–220 m. The IIHS data submitted by SAE show that almost all the lower beams tested by IIHS exceeded the glare limits at distances of 60 meters and greater on a 250 m right curve. NHTSA also examined IIHS lower beam data for a 2020 Toyota Camry with “Good”-rated LED lower beams.¹³² IIHS measured that vehicle on a 250-m radius curve to have a 5-lux line at 79.5 m¹³³ (70 m is the minimum without receiving demerits), which would exceed the applicable glare limit at that distance (0.6 lux).

After considering the comments, NHTSA has determined that these results should have been generally expected based on a comparison of the oncoming glare limits and the longstanding Table XIX lower beam photometry requirements that regulate lower beam design. The oncoming glare limits were derived from the Table XIX left-side maxima (700 cd at 1U, 1.5 L to

L and 1,000 cd at 0.5 U, 1.5L to L).¹³⁴ On a right curve, however, the fixture enters the lower beam pattern from the right side and traces a trajectory across the beam pattern from right to left (See Figure 7). The Table XIX right-side maxima (1,400 cd at 1.5U, 1R to R and 2,700 cd at 0.5U, 1R to 3R) are higher than the left-side maxima. In addition, unlike on the left side, the right-side photometry is not limited at 0.5U extending indefinitely horizontally. The left-side photometry is limited by the line 0.5U, 1.5L–L. The right-side photometry is limited by 0.5U, 1R–3R. While right-side photometry is ultimately limited at 1.5U, 1R–R, this line provides considerably more flexibility to provide light down the right side. Consequently, the Table XIX right-side maxima, on which current lower beams are based, permit intensities that exceed the oncoming glare limits, which were derived from the left-side maxima. Indeed, data show that current compliant lower beams exceed the derived glare limits on the right side at distances greater than 50 m. More specifically, based on the IIHS data presented by SAE, exceedances at about 3R and greater (corresponding to measurement distances of greater than about 50 m) are found, and many fewer glare limits exceedances to the left of 3 degrees right. Accordingly, the final rule revises this scenario so that the measurement range does not start until 50 m.

The agency notes that even with this modification, the glare limits in this final rule are still (as Stanley suggested) more stringent than currently allowed by the Table XIX right-side maxima from 1R to 3R.¹³⁵ However, this level of stringency is reasonable and provides a manageable design range. The lower beam photometry was designed to provide a generic beam to prevent glare regardless of the actual road and traffic conditions; it was not customized to provide glare protection to oncoming vehicles on a right curve. Because most situations in which an oncoming vehicle can be glared will occur with the oncoming vehicle to the left, the

existing Table XIX lower beam photometry requirements require shading the left side and permit more light on the right side. However, the adaptive driving beam is not, and need not be, an all-purpose beam like a conventional lower beam. It is clear in the photometry tables that the appropriate glare limits for oncoming situations are the left-side maxima in Table XIX, on which the oncoming glare limits are based. These limits should, to the extent possible, apply to oncoming glare, including from the right-side. In any case, the agency believes that current lower beams would generally comply with the glare limits as applied in this scenario with the revised measurement distance range.

Indeed, both IIHS and NHTSA lower beam test data demonstrate that compliant lower beams, including high-rated IIHS beams, would generally be within the glare limits in this revised scenario. The IIHS data submitted by SAE shows that for distances between 15 m and 60 m, most of the lower beams were within the glare limits. Vehicles 1 and 7 seem to take the most advantage of the flexibilities provided toward the right side beyond 3 degrees in performing well in the IIHS right-curve test, and the lower beams on both vehicles were below the glare limits within 50 m. This demonstrates that a vehicle can both perform well on the IIHS right-curve distance rating and stay within the glare limits in this final rule’s revised scenario.

NHTSA’s testing also showed that current lower beams can pass this revised scenario. NHTSA tested two lower beams on a 210 m right curve, and both were within the glare limits at all distances within the specified measurement range. See Figure 23. The agency also saw similar results in our 2015 testing, which (among other things) evaluated lower beam illuminance on a 231 m right curve, and found that the lower beams exceeded the glare limits at 60 meters and greater, and was within the glare limits from 15 m to 60 m.¹³⁶

¹³² See www.iihs.org/ratings/vehicle/toyota/camry-4-door-sedan/2020#headlights (last accessed Dec. 18, 2020).

¹³³ Corresponding to approximately 0.3D, 7R.

¹³⁴ Feasibility Study, p. 23.

¹³⁵ In Appendix A, we provide additional data and discussion on this.

¹³⁶ 2015 ADB Test Report, p. 193 (Fig. 85, Mercedes Trial 82 [lower beam]); p. 63 (Mercedes test vehicle modified by manufacturer to produce a FMVSS No. 108 compliant beam pattern).

Figure 23.

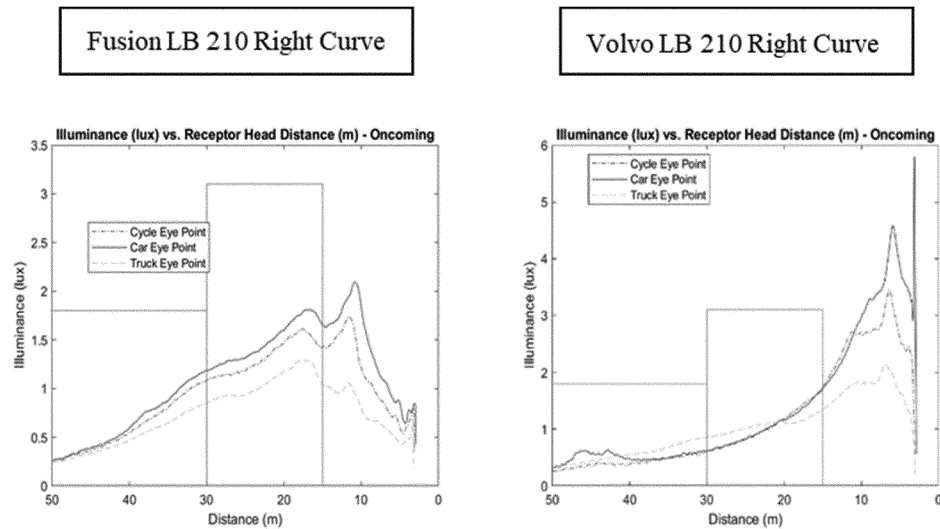

NHTSA notes that these data from contemporary lower beams differ somewhat from data on 1990s-era lower beams presented in the Feasibility Study. Specifically, Figure 9 in the Feasibility Study, which displayed a lower beam pattern typical of MY 1997 vehicles, seems to indicate that lower beams would likely be within the oncoming glare limits on the right side of the beam pattern illustrated in Figure 9. However, as Auto Innovators pointed out in its comment, lower beam design has changed since 1997. NHTSA believes it is reasonable to assume that at least some manufacturers are supplying more light at or just above the horizon for horizontal angles greater than 3 degrees right (without violating the 1,400 cd maximum) than in the past in order to perform well on the IIHS tests.¹³⁷ Lower beams that are designed

to perform well on the IIHS test may thus be more likely to fail the glare limits in the ADB track test, even if the system is projecting an area of reduced intensity onto the fixture. This is compounded by the effect of vehicle pitch: With higher intensity light at larger vertical angles of the beam pattern, slight changes in pitch can push the higher intensity portion of the lower beam upwards and cause the oncoming glare limit to be exceeded. Further, at angles beyond 3 degrees right, the glare limits begin to veer dramatically from the flexibilities provided in the current Table XIX requirements (specifically, the right-side maxima). Accordingly, the oncoming glare limits, in conjunction with the revised measurement distances, are consistent with the angular limits of the current lower beam photometry. The track test continues the longstanding flexibilities for lower beam design on the right side beyond 3 degrees.

The modified specifications for this scenario are also within the capabilities of typical ADB systems. Because illuminance is evaluated starting at 50 m from the fixture, there is more than enough time for an ADB system to detect and react to the fixture (more than 7 seconds on a 230 m radius curve).

The agency's ADB test data bear this out. When testing an ADB system on a 210-meter radius right curve, the illuminance was within the glare limits except for some limited exceedances, which can readily be addressed by minor changes in the design of the area of reduced intensity. See Figure 24. Similarly, the 2015 testing with actual stimulus vehicles showed that even an older ADB system was able to pass a right curve (231 m) oncoming scenario at 15 m to 50 m.¹³⁸

¹³⁷ Comment from Alliance for Automotive Innovation (July 31, 2020) (NHTSA-2018-0090-0219), p. 11 (Fig. 5, Low-Beam Headlight Intensity Pattern from IIHS Headlight Rating).

¹³⁸ 2015 ADB Test Report, p. 193 (Fig. 85, Mercedes Trial 83 [ADB]); p. 63 (Mercedes test vehicle modified by manufacturer to produce a FMVSS No. 108 compliant beam pattern).

Figure 24. Lexus ADB 210 Right

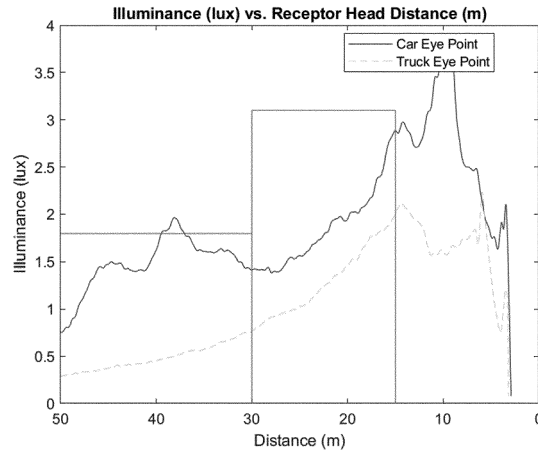

The ADB system NHTSA tested had more exceedances when tested to the most closely analogous SAE J3069 scenario (with the test fixture in

Position 3) compared to NHTSA’s test. See Figure 25. This is because at the measurement distances in this scenario, Fixture Position 3 is in the bright (right-

side) portion of the beam pattern, while the fixture in NHTSA’s test scenario is in the less-bright portion of the beam pattern (center-right to center-left).

Figure 25. SAE test fixture Position 3 (car)

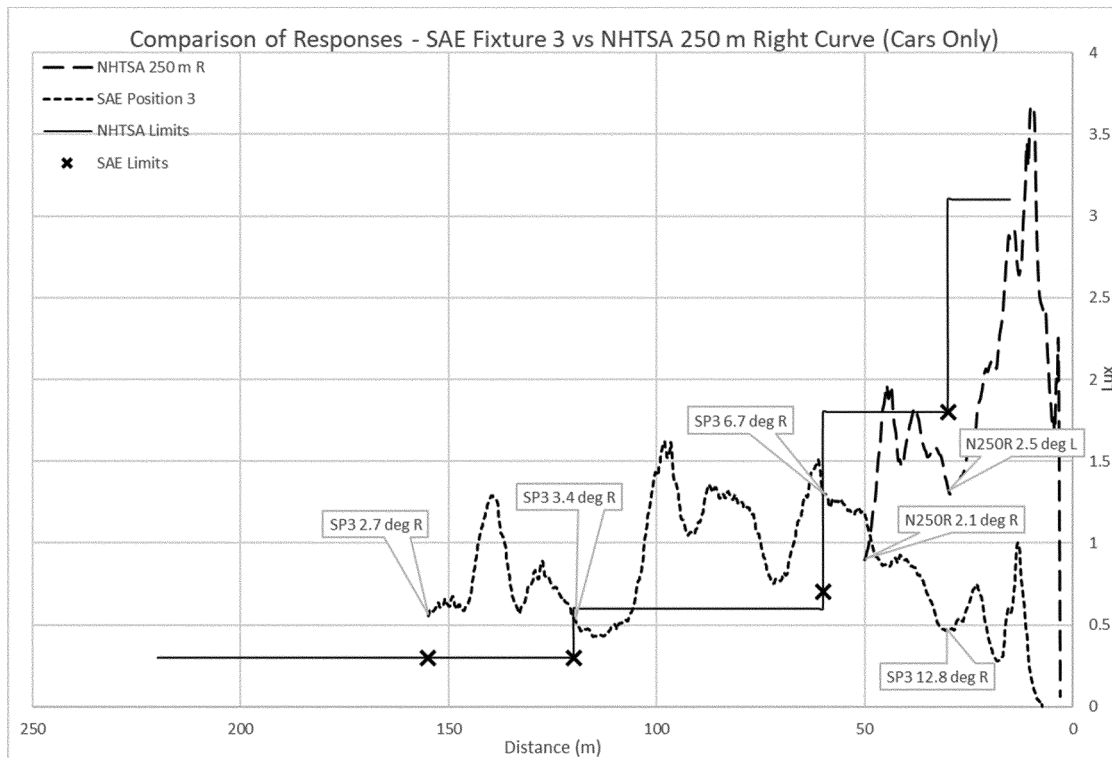

NHTSA notes that this scenario does not evaluate the illuminance from the ADB system from 50 m–220 m, so it would not test whether the ADB system switched from an upper beam to an adaptive beam in this range. NHTSA believes this is acceptable because the left curve scenarios generally test the ability of the ADB system to react and

it is reasonable to expect similar reactions on the left and right side. The right curve test simply confirms the right side is performing similarly by applying the oncoming glare limits to narrow angles on the right side and providing greater flexibility at broader angles on the right side of the vehicle.

f. Scenario 6: Oncoming Large Right Curve

The NPRM proposed regulating glare on right curves with a radius of 335 m to 396 m at 50–55 mph from distances of 15 m to 220 m.

Comments

As explained above regarding the medium right curve scenario, Stanley ran simulations for right curves with a radius of 366 m and commented that the oncoming glare limits were effectively more stringent than the current Table XIX photometry on the right side of the beam pattern. In addition, as noted earlier, commenters argued more generally that the proposed glare limits were so stringent that compliant lower beams would exceed them, and that there might not be sufficient time for the ADB system to react to the stimulus lighting.

Agency Response

This final rule modifies the proposal, similar to the modifications for the medium right curve, in response to comments that current compliant lower beams might not comply with the NPRM's glare limits at all the proposed

measurement distances. As explained earlier, this (in conjunction with the requirement that areas of reduced intensity meet the corresponding lower beam laboratory photometric requirements) means that an area of reduced intensity, up to and including a full lower beam, will meet the same level of safety (with respect to both visibility and glare prevention) as current lower beams certified to FMVSS No. 108. As NHTSA agrees with Stanley and other commenters that the proposed scenario permitted less glare than presently required of a lower beam on the right side of the beam pattern, NHTSA has narrowed this angle not to go beyond 3 degrees right, to provide flexibility at larger angles. The final rule therefore specifies testing on a right curve with a radius of 335–400 m at distances of 15 m to 70 m, at the proposed speeds of 50–55 mph.

NHTSA believes that a lower beam that is FMVSS No. 108-compliant and

performs well on the IIHS test would generally be able to comply with the glare limits in this scenario. The reasons for this are analogous to the reasons given earlier for revising the measurement distance in the medium right curve scenario. None of the IIHS data submitted by SAE was for a right curve of this diameter. NHTSA tested two lower beams on this scenario. See Figure 26. The Fusion lower beam was within the glare limits at all specified distances, while the Volvo lower beam exceeded the glare limits at distances from 60 m–70 m. This is likely because, as explained earlier, the Table XIX photometry requirements and the IIHS test have prompted some manufacturers to provide greater light on the right side. NHTSA believes such systems can comply with the requirements with minor modifications. This is also consistent with what Stanley points out in its comment.

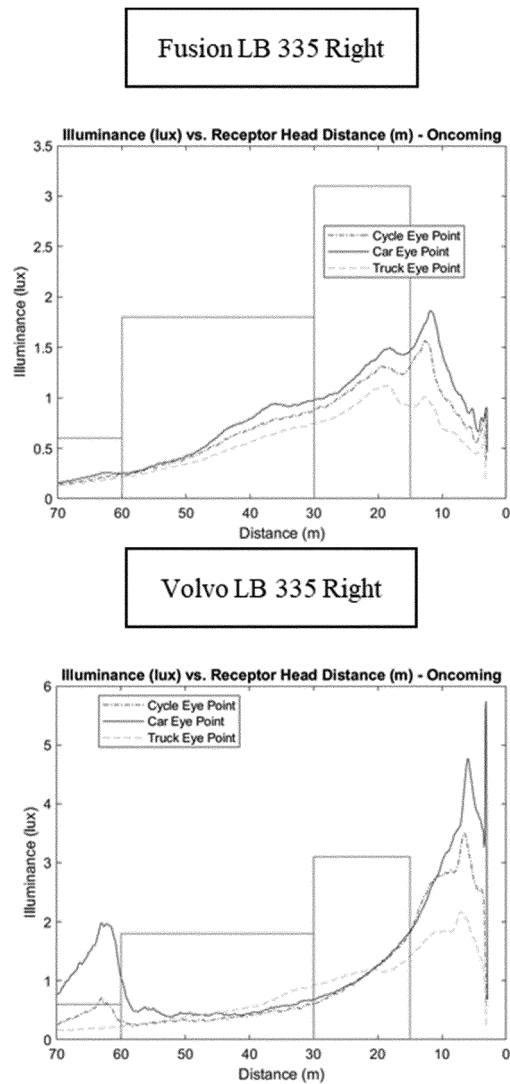
Figure 26. Lower beams on

The agency also believes that the finalized requirements are within the capabilities of existing ADB systems, for reasons analogous to those provided for the medium right curve scenario above. The ADB NHTSA system tested was within the glare limits in this scenario except at distances greater than 60 m.

See Figure 27. This is similar to the results for the Volvo lower beam and, we believe, can be addressed with minor system modifications. Agency test data also confirm that the most closely analogous SAE test scenario (Fixture Position 3) does not accurately replicate an actual right curve; the

measured illuminance on this scenario was significantly higher than in the analogous SAE scenario. Thus, the data indicate again that the two test methods can yield different results, and that the actual curve test is preferable because it would be more evaluative of real-world performance.

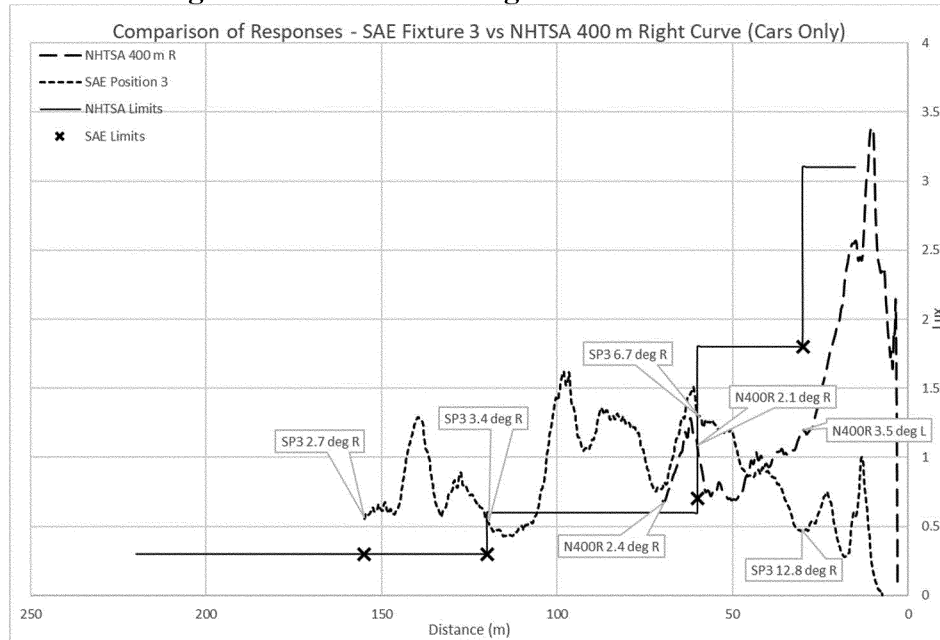
Figure 27. Lexus ADB Right 335 & SAE Fixture Position 3

g. Scenario 7: Preceding Straight

The NPRM proposed testing for preceding glare in a variety of vehicle maneuvers, on both straight and curved roadway. It proposed scenarios in which a stimulus vehicle preceded the test vehicle in the same lane and in which the test vehicle overtakes the stimulus vehicle, and vice versa. We proposed evaluating glare out to 119.9 m.

Comments

SAE commented, with respect to NHTSA's statement in the NPRM that the ECE ADB regulations require ADB cameras to be capable of sensing vehicles out to 400 m, that this only applies to opposing vehicles (headlamps), not preceding vehicles (rear lamps). For preceding vehicles (*i.e.*, tail/rear position lamps), the ECE requirement is greater than 100 m. SAE also noted that ECE minimum photometric requirements for a rear position lamp is 4 cd versus the 2 cd

minimum under FMVSS No. 108 for a taillamp. Thus, SAE stated, the ECE requires a shorter detection distance (100 m in the ECE versus 120 m in the NPRM) for a lamp whose absolute minimum intensity is two times that required by FMVSS No. 108.

Auto Innovators found that there were very few test failures in this scenario (5 failures out of 109 valid test runs in its testing) and therefore suggested eliminating it because it would provide no additional benefit.

Agency Response

The final rule scales back the proposal with respect to evaluating preceding glare. The final rule does not include any passing or same-lane scenarios because it utilizes stationary fixtures. The final rule provides only for testing preceding glare with the fixture in the left adjacent lane, on both a straight path (this "preceding straight" test

scenario) and on a left curve path (Scenario 8).

The final rule also shortens the measurement distance to 100 m. As SAE suggested in its comment, the detection distance for ADB systems differs for oncoming versus preceding traffic. It is much more difficult for an ADB system to detect taillamps than headlamps, and the difficulty increases with greater forward distances. This is mainly due, as SAE notes, to the fact that headlamps are much brighter than taillamps. The NPRM stated that it is reasonable to expect ADB systems to detect oncoming vehicles at 220 m but did not mean to imply that this also applies to preceding vehicles. The final rule harmonizes with the ECE requirements in this respect.

Agency test data indicate that current lower beams can comply with this revised scenario. NHTSA tested two vehicle lower beams, both of which performed well, with considerable margin. See Figures 28 and 29 below.

Figure 28: Fusion 61 mph:

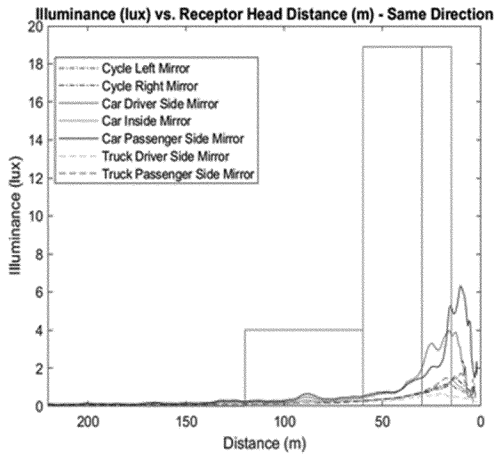
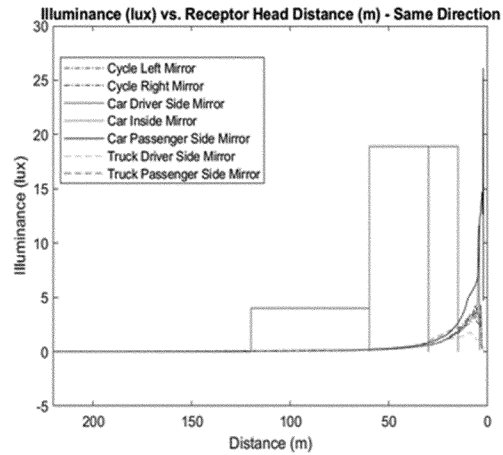

Figure 29: Volvo 65 mph



NHTSA’s analysis also indicates that ADB systems can reasonably be expected to comply with this scenario. As explained earlier for the oncoming straight scenario, the preceding vehicle fixture—which is in the same location as it is for the oncoming straight scenario—is always within the ADB

system’s field of view, so that an ADB system will have more than sufficient time to react to and shade the fixture. NHTSA’s test data bear this out. The Lexus ADB system performed well with considerable margins in this scenario with all fixtures (passenger car, truck, motorcycle). See Figure 30. On the SAE

test run with the preceding fixtures in Position 2 (the closest analog to this final rule scenario), the ADB system passed with the car/truck fixtures, although the margins were lower. See Figure 31.

Figure 30: Lexus straight run at 69 mph, Same Direction

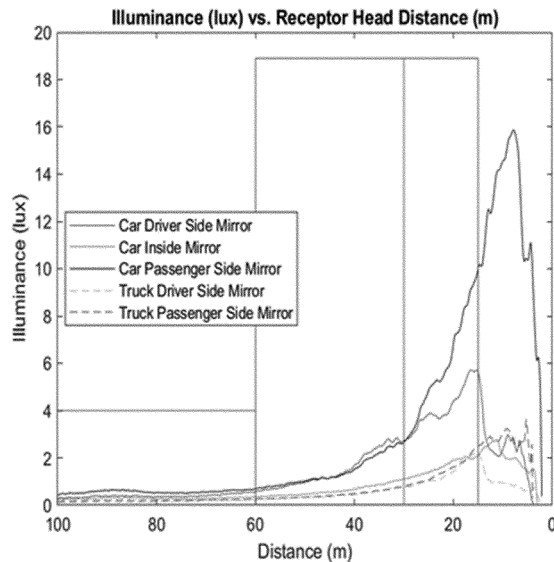
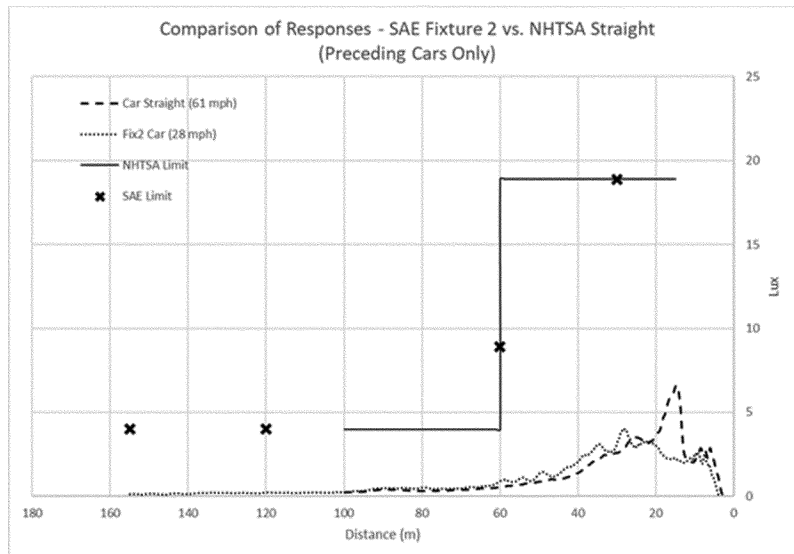

Figure 31 – SAE test scenarios



h. Scenario 8: Preceding Medium Left Curve

The NPRM included scenarios for testing preceding glare on short, medium, and large right and left curves, in same-lane and passing scenarios. It proposed evaluating glare from 15 m or 30 m (depending on the scenario) out to 119.9 m. The agency did not receive any comments specifically on the preceding curve scenarios.

The final rule retains only one preceding curve scenario of those proposed. This scenario evaluates preceding glare on a medium left curve

(with a radius from 210 m to 250 m) from 15 m to 100 m with the fixture in the left adjacent lane.

After considering the comments questioning the number and complexity of the proposed test scenarios, NHTSA considered including only a preceding vehicle straight path scenario, hypothesizing that it, in addition to the full set of oncoming scenarios, would adequately probe ADB system performance. NHTSA's testing, however, showed that ADB systems encountered some difficulties preventing glare to preceding vehicles

on curves. The 2015 ADB Test Report concluded that left curve same-direction maneuver scenarios in which the stimulus vehicle was stationary were associated with high measured illuminance values.¹³⁹ NHTSA's recent testing showed that the ADB system, while performing adequately on oncoming left curve and preceding straight scenarios, had trouble with a preceding left curve scenario for short and medium curves, but handled the large curve well. See Figure 32.

¹³⁹ 2015 ADB Test Report, p. 173. See also pp. 114–123.

Figure 32. Preceding glare on left curves

Lexus ADB – Preceding, 85 m left curve at 26 mph

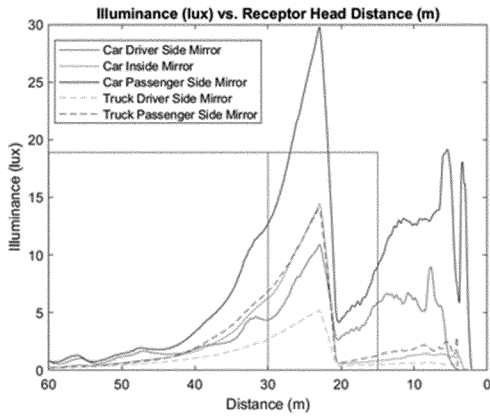

Lexus ADB – Preceding, 210 m left curve at 41 mph:

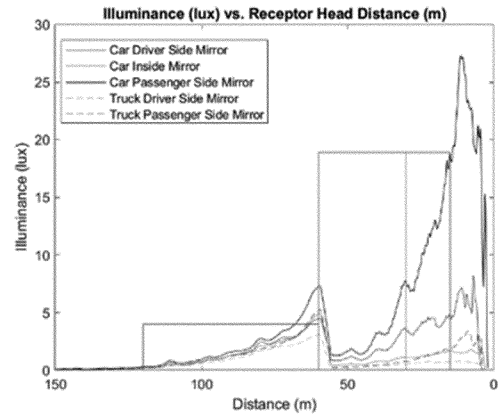

Lexus ADB – Preceding 250 m left curve at 44 mph.

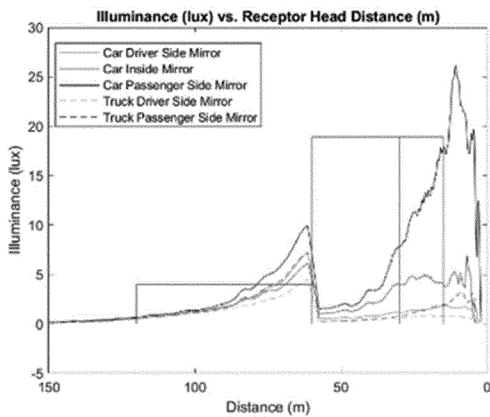

Lexus ADB – Preceding 400 m left curve at 51 mph.

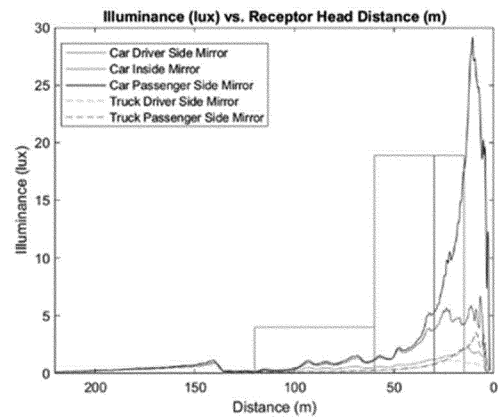
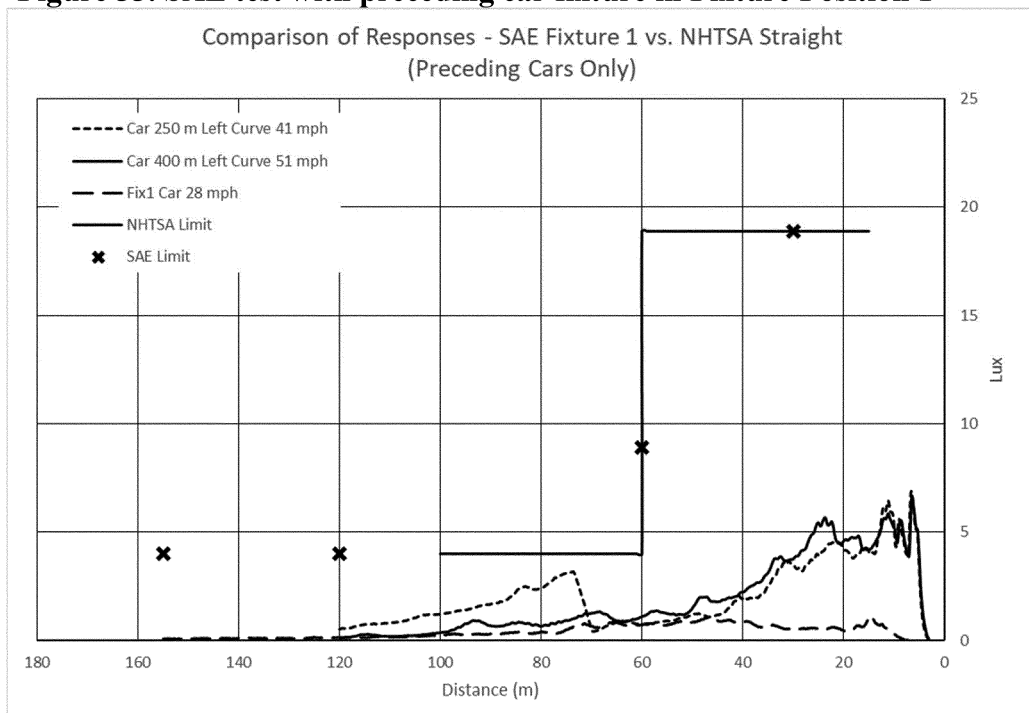

Figure 33. SAE test with preceding car fixture in Fixture Position 1**BILLING CODE 4910-59-C**

Accordingly, the final rule retains a preceding left curve scenario to help ensure that ADB systems respond appropriately when encountering preceding vehicles on curved roadways. NHTSA decided that one curve test would suffice and has opted for the medium curve. The ADB system we tested performed well on the large curve, and the short curvature would be a difficult test for the manufacturers to meet. The final rule does not add a right curve scenario for preceding vehicles because the 2015 study showed that ADB systems generally performed well on same-direction right curve maneuvers.¹⁴⁰ Further, because the final rule truncates the measurement distances on right curves, preceding tests for right curves would not test the system in any significant ways that are not already covered by the other scenarios.¹⁴¹

The results from the SAE test fixture position most analogous to this final rule scenario (with the SAE fixture in Position 1) show that the ADB system passed the test with the car/truck fixture

¹⁴⁰ 2015 ADB Test Report, p. 173.

¹⁴¹ For example, the Lexus has a late reaction (at 70 m) on the preceding medium left curve. If the recognition system is essentially symmetrical (*i.e.*, the same for a right curve), the same late recognition (70 m) on a preceding right curve would not result in a failure, because the measurement distance for a right curve is truncated to 50 m (Scenario 5). As is the case for the left curve, the Lexus was under the right curve limits at distances less than 50 m.

with wide margins. See Figure 33. Again, this contrasts with the results from the final rule test scenario and suggests that the SAE test does not sufficiently replicate a preceding situation on an actual curve.

i. Decision Not To Include Oncoming Short Right Curve Scenario

The NPRM proposed evaluating illuminance on right curves with a radius of 98 m to 116 m at distances of 15 m to 220 m.

Comments

SAE and Stanley commented—parallel to their arguments for the medium right curve—that contemporary lower beams would likely not comply with this scenario. SAE provided a graph of illuminance data for IIHS “Good”-rated lower beams from about 0 m to 125 m on a 150 m radius right curve. SAE stated that these data show that many of those lower beams would not comply with the proposed glare limits at distances greater than 30 m. Other commenters stated more generally that the proposed glare limits were so stringent that even currently-compliant lower beams would exceed them. Similarly, Stanley ran simulations for a right curve with a radius of 107 m and asserted that the glare limits were more stringent than the right-side intensities currently permitted by the standard.

As noted above under the small left curve scenario, several commenters stated that curves of this size would

require a camera field of view beyond the capabilities of existing systems, and/or would not allow a sufficient time for an ADB system to detect and react to the stimulus.

SAE also commented that upper beams at greater than 15 degrees left or right are not as bright as lower beams straight ahead, and at an angle of 40 degrees the light toward a stimulus vehicle driver is low, further suggesting that requiring a camera field of view beyond 25 degrees is unnecessary.

Agency Response

The final rule does not include a short right curve scenario because NHTSA was persuaded by the comments.

The reasons for this decision are similar to the reasons for modifying the measurement distances for the medium and large right curve scenarios. As explained earlier, NHTSA concluded that contemporary lower beams—especially beams that score well on the IIHS test—would likely not comply with the oncoming glare limits at distances corresponding to horizontal angles greater than 3 degrees—that is, on a 100 m right curve, distances greater than 30 m (the distance at which the fixture would cross 3 degrees). This is consistent with the IIHS data submitted by SAE, which shows that none of the lower beams tested were within the oncoming glare limits between 60 and approximately 120 m, and most of the lower beams tested were not within the oncoming glare limits from 30 m to 60

m. (From 15 m to 30 m, almost all the lower beams tested by IIHS were within the glare limits.) As such, the agency has confidence that including a small radius right curve scenario would have no positive impact on safety relative to that provided by current lower beams in this situation.

Because, as explained above, the final rule specifies right curve scenarios only for measurement distances corresponding to horizontal angles to the left of 3R, this would leave only about 15 m of track length (and 1 second of test time) for this scenario. NHTSA concluded it was not useful to include such a short-duration scenario in the final rule.

9. Other Test Parameters and Conditions

a. Radius of Curvature

NHTSA proposed testing using a curved path scenario (both left and right curves) with a variety of radii of curvature. The NPRM proposed testing on a “small” curve with radii of curvature from 98 m—116 m (320–380 ft); a “medium” curve with radii of curvature of 223 m—241 m (730–790 ft); and a “large” curve, 335 m—396 m (1100–1300 ft). The NPRM proposed that the curve on which testing is conducted be of a constant radius within the range listed in the test matrix.

Comments

Manufacturers requested clarification or modification of the specifications and procedures related to the radius of curvature.

The Alliance, Ford, and Toyota commented on measuring the radius of curvature. Ford requested clarification on how to measure the radius of curvature and all three commenters

recommended following the IIHS protocol and measuring the radius of curvature from the center of the test vehicle’s travel lane.

Toyota suggested the final rule not specify a constant radius because it is not practical and is rarely the case in real-world situations.

Honda, Toyota, and Auto Innovators requested clarification of the direction of curvature (left or right).

OICA, SAE, SMMT, and Auto Innovators commented that the proposed road geometries do not exist at the proving grounds of many vehicle manufacturers. Auto Innovators commented that its testing contractor found that modifications to curvature radii were necessary to accommodate performance of the specified test scenarios at its facility, and that only the short-radius curve was within the NPRM specification.

Agency Response

NHTSA has made a variety of changes in the final rule in response to these comments. With respect to measuring the radius of curvature, the final rule adopts regulatory text to specify that the curve is of a constant radius, as measured to the centerline of the path on which the test vehicle travels, within the range specified in the test matrix. In its latest testing, NHTSA used an inertial navigation system to follow a pre-programmed path for the centerline of the vehicle to follow. This was executed using a steering controller that followed the predefined path.

When conducting its compliance testing, the agency may choose any radius within the range listed in the test matrix. The constant-radius specification is intended to indicate that the agency does not intend to test on compound curves (*i.e.*, a curve with a

non-constant radius of curvature). Considering that the manufacturer must certify that the vehicle will perform throughout the range of radii of curvature specified in the test matrix, NHTSA does not expect dramatic differences in results if the radius is not perfectly constant but contains minor variations throughout the run. The final rule also retains ranges for the radii of curvature, as opposed to a single radius of curvature with a relatively narrow tolerance. NHTSA believes the system should be able to function over at least these range of radii because they are representative of real-world roadway geometry.

NHTSA agrees with Honda and Toyota about clearly specifying the direction of curvature and has done so in the regulatory text.

With respect to the comment that the specified curves are not available at testing facilities, NHTSA was able to test on the curves specified in the final rule at the Transportation Research Center (TRC) Vehicle Dynamics Area (VDA). This test facility is publicly available to manufacturers.

The final rule slightly modifies the specifications for the radii of curvature for all curves. NHTSA converted the center of the proposed range units from feet to meters and rounded the meter units.

b. Test Vehicle Speed and Acceleration

The NPRM proposed, for each test scenario, a range of test vehicle speeds that NHTSA could select. The values proposed for speed, radius of curvature, and superelevation were consistent with a standard formula used in road design specifying the relationship between these parameters. The formula, referred to as the simplified curve formula, is

$$0.01e + f = \frac{V^2}{15R},$$

where f is the coefficient of friction, V is the vehicle speed, R is the radius of curvature, and e is superelevation.¹⁴² The speeds ranged from a high of 70 mph for the straight scenario to 25 mph for the short-radius curve scenarios.

The NPRM proposed that for each test run, a speed conforming to the ADB test matrix would be selected and that the test vehicle would achieve this speed \pm 0.45 m/s (1 mph) prior to reaching the

data measurement distance and maintain this speed with “no sudden acceleration or braking.”

Comments

SAE, Toyota, and Honda recommended that, to simplify the test and reduce variability, the final rule specify a specific vehicle speed and tolerance for each scenario. Auto Innovators recommended that the maximum test speed be reduced from 70 mph to 55 mph because camera detection does not depend on vehicle speed; the majority of fatal nighttime crashes on curves occur at speeds of 55

mph or less; and certain vehicles (such as large trucks) would have difficulty reaching the specified test speeds given the lengths of courses available at test facilities. Toyota suggested providing a more specific specification for acceleration.

Agency Response

The final rule retains the speed ranges and tolerances proposed for each scenario. The range of speeds reflects the real world (where different drivers may take the same curve at different speeds) and provides testing flexibility.

¹⁴² See *A Policy on Geometric Design of Highways and Streets*. American Association of State Highway and Transportation Officials. Washington, DC (2011) (AASHTO Green Book), pp. 3–19 to 3–20.

The speeds set out in the final rule are generally higher than specified in SAE J3069, which states that “[t]he speed of the vehicle for the full length of the 155 m test shall be above the ADB activation threshold of the vehicle as specified by the manufacturer.”¹⁴³ NHTSA believes that testing at speeds only marginally higher than the activation speed would not be representative of real-world driving, especially on the types of roads and situations (e.g., outdriving lower beam) in which ADB is most useful. The ADB systems NHTSA tested had activation speeds ranging from 19 to 43 mph.¹⁴⁴ Safety concerns regarding glare, like many safety concerns, are also magnified at higher speeds.

NHTSA disagrees with the suggestion that test speed does not impact ADB system performance, as the higher the test speed, the quicker the system must identify and shade the fixture. The proposal did not specify test speeds greater than 55 mph on curves; speeds above this were only proposed for straight-path scenarios. Regarding the concern that vehicles such as large trucks may have difficulty attaining test speeds in the distances available at track test facilities, the final rule specifies test fixtures and not stimulus vehicles, which should facilitate testing at the higher speeds. Further, the agency was able to achieve the maximum test speed of 70 mph on two different sections of the TRC facility for the straight scenario, using a class 8 truck tractor in the loaded and unloaded condition on the skid pad and the vehicle dynamics area (this is the surface that was used for all of the research testing). While complete lamp testing was not conducted using the class 8 truck tractor, the pitch and speed parameters were recorded along the path to demonstrate that a valid test was possible. Given the superiority of full-vehicle testing of ADB, the difficulties that a few vehicles may have in executing the test procedure do not appear insurmountable for heavy vehicles.

Regarding Toyota’s comment on the acceleration criteria, the proposal did address acceleration beyond the specification that “no sudden acceleration or braking shall occur” in that it also specified a tolerance of ± 0.45 m/s (1 mph) for the nominal test speed. This tolerance is smaller than that used in the IIHS test procedure (3 km/h (.83 m/s)). In NHTSA’s testing, the test driver was able to consistently maintain the speed within this tolerance. In addition, the final rule includes a vehicle pitch allowance that

constrains acceleration in that if acceleration causes changes in vehicle pitch exceeding 0.3 degrees compared to the average pitch, then the measured illuminance at those points will not be considered in determining compliance.

c. Headlamp Aim

The proposed test procedures specified several aspects of test vehicle preparation. This included that the headlamps would be aimed and the ADB system adjusted according to the manufacturer’s instructions.

FMVSS No. 108 requires that when a headlamp is installed on a motor vehicle, it must be aimable.¹⁴⁵ The standard specifies compliance options for the aiming system. The principal options are vehicle headlamp aiming devices (VHAD) and visual/optical aiming devices (VOA).¹⁴⁶

A VHAD is an item of equipment installed on the vehicle and headlamp which is used for aiming the headlamp mechanically, such as with a bubble vial on the headlamp housing which has a closely specified geometric relationship to the headlamp beam’s vertical location. A similar mechanical reference marking system is used for correct horizontal aim, essentially aligning the optical axis of the headlamp housing or reflector to the vehicle’s longitudinal axis.

VOA involves either projecting the beam onto a vertical surface and then adjusting the headlamp to an appropriate position as determined by an observer (visual aim), or projecting the beam into an optical device that is placed in front of the headlamp and then adjusting the headlamp until the beam conforms to the appropriate parameters (optical aim). VOA is used on most, if not all, vehicles currently sold in the U.S. The standard requires a relatively sharp horizontal cutoff in the lower beam pattern in order to aim the headlamps vertically. The standard does not permit horizontal aiming on VOA headlamps unless the headlamp is equipped with a horizontal VHAD.

Comments

IIHS expressed concern that the NPRM allowed vehicle manufacturers to provide headlamp re-aiming procedures and ADB adjustments prior to testing, because for the systems to be effective in real-world driving, they need to function without adjustment when the consumer purchases the vehicle. IIHS

¹⁴⁵ S10.18.

¹⁴⁶ The standard specifies a third compliance option (mechanical aim), which involves an externally-applied mechanical device. This method is no longer in use and is not at issue in this rulemaking.

explained that its headlighting system evaluations are conducted without changing the factory aim of the headlamps. They found that there is often a wide range of aim values between manufacturers, between some vehicles of the same make and model, and even between the left and right headlamp of the same vehicle, indicating that ADB effectiveness will be reduced if there is no incentive in the regulation for precise aiming at the factory. IIHS noted that this is even more important for ADB than for traditional headlighting systems since both the headlamps and the camera system require accurate alignment. IIHS further stated that just as NHTSA would not allow manufacturers to modify an air bag deployment algorithm prior to conducting FMVSS No. 208 compliance crash tests, the agency should not allow the ADB system to be modified to a condition that may not exist on any other production vehicle. IIHS provided data on factory aim variation for seven new vehicle models with VOR headlamps showing that most had aim values that would have a substantial effect on the measured visibility distances in the IIHS evaluation. IIHS stated that this indicates that conducting headlamp evaluations or compliance testing with re-aimed lamps is likely to reduce the real-world relevance of the tests.

Conversely, several commenters (Valeo, the Alliance, Volkswagen, SAE, Koito, Global, Honda, Auto Innovators, and Ford) requested that the final rule allow for horizontal aim adjustment on VOA ADB headlamps without equipping them with a horizontal VHAD (as the standard currently requires). The commenters highlighted the importance of horizontal aiming for ADB systems and requested that the final rule allow horizontal aim adjustment on VOA headlamps used in conjunction with an ADB system. They stated that in order to maximize the visibility benefits of ADB, the area of reduced intensity must be minimized, which can only be accomplished using both horizontal and vertical aiming. They commented that horizontal adjustment of the beam is critical in placing the area of reduced intensity accurately over the oncoming or preceding vehicles. If a horizontal aim access allowance were not incorporated into the final rule, automakers would be required to compensate for the expected horizontal vehicle variation into the size of the area of reduced intensity, resulting in greatly increasing this area, and lessening the additional light.

The commenters noted that the standard prohibits horizontal aim on a

¹⁴³ 5.5.6.1.

¹⁴⁴ 2015 ADB Test Report, p. 20.

VOA headlamp unless a VHAD is provided, and stated that VHADs are unreliable, ineffective, lack the accuracy necessary for use with ADB systems, and are essentially obsolete. SAE suggested that NHTSA modify the current regulatory text in S10.18 and S14.2.5 to allow headlamps with adaptive driving beams to be adjusted according to the manufacturer's instructions.¹⁴⁷ Auto Innovators commented that the method to horizontally aim ADB headlamps varies depending on the specific execution of the ADB system. Each involves an ADB-specific aim calibration mode to be activated either by a dealer or consumer when the vehicle is parked. This mode illuminates a horizontal aim feature utilizing one or more of the ADB-illuminated elements which have a sufficient vertical gradient that can be used for horizontal aim, just as one does today with vertical aim. The dealer or consumer would use this vertical gradient to properly calibrate the horizontal aim following instructions specified in the service manual or owner's manual.

Several of these commenters pointed out that the ECE and Canadian requirements provide for horizontal aim with VOA headlamps and that effectively requiring horizontal VHADs would drive hardware disharmonization. Ford pointed out that SAE J3069 recognized the necessity of horizontal aiming for ADB systems, and that Canada, in adopting SAE J3069, specifically permitted horizontal aim.

ALNA suggested applying tolerances for aiming the headlamps.

Agency Response

The final rule follows the proposal and specifies that the headlamps will be aimed and the ADB system adjusted according to the manufacturer's instructions. In addition, the final rule provides that the test vehicle will be loaded within ± 5 kg of the total vehicle weight during track testing prior to aiming the ADB headlamps. This is intended to indicate that NHTSA will not change the loading of the vehicle by more than 5 kg compared to what it is when the headlamps are aimed. This means that NHTSA will not aim the headlamps when the vehicle is at a lower weight compared to when the vehicle is fully instrumented and

¹⁴⁷ Ford noted that NHTSA has opined that horizontal aiming is permitted with VOA headlamps provided it is disabled or made inaccessible for consumers, but contended that this does not address the potential need for re-adjustment should the ADB system need to be aimed after sale to the consumer (for example, upon headlamp replacement due to vehicle damage).

occupied by a test driver (which changes the pitch of the vehicle, and thus, the aim of the headlamps).

NHTSA disagrees with IIHS and believes that manufacturers should be permitted to specify aiming procedures prior to the compliance tests. IIHS's suggestion is essentially that on-vehicle aim should be regulated. Even if this approach may have merit, it is outside the scope of this rulemaking, which extends the current requirements to ADB systems. The proposed specification is also consistent with the required laboratory testing, which involves aiming the headlamp prior to testing. Conventional laboratory testing of headlamps has long permitted aiming them prior to testing. This contributes to the repeatability of the test and sets a consistent standard to which headlamps must perform. This is important because the laboratory photometric requirements are the basis for the current track-based test procedure limits; if we were to consider practical limits that included variations in aim introduced through the distribution chain, the limits that are finalized might not be appropriate. In addition, as IIHS notes, ADB systems rely on accurate alignment of the headlamps and camera systems. Aiming the headlamps prior to the compliance test limits aim variation and isolates ADB performance. This approach ensures that the ADB compliance test will be performed with a headlighting beam pattern that, as manufactured, at least meets a minimum level of performance. The end customer or dealer can then aim the headlamps to align the system appropriately.

The agency agrees that successful implementation of ADB using current technology requires the regulation to provide flexibility to permit headlamps to be aimed horizontally once installed on the vehicle to align the vehicle, camera, and headlamps. As explained below, while NHTSA agrees with the commenters that ADB systems should be exempt from several of the current requirements for horizontal VHADs, NHTSA does not agree that ADB-equipped VOA headlamps should be completely exempt from all the VHAD requirements.

FMVSS No. 108 does not permit VOA headlamps to be visually aimed with respect to horizontal aim. NHTSA explained the reason for this in the 1997 final rule that permitted VOA aim headlamps.¹⁴⁸ Because the lower beam of a headlamp designed to conform to Standard No. 108 does not have any visual cues for achieving correct horizontal aim when aimed visually or

¹⁴⁸ 62 FR 10710 (Mar. 10, 1997).

optically, and because it is not possible to add such visual features without damaging the beam pattern, horizontal aim should be either fixed and nonadjustable, or have a horizontal VHAD. The agency also noted that the negotiated rulemaking committee involved in that 1997 negotiated rulemaking "considered features for horizontal visual/optical aiming but none were deemed sufficiently developed and designed to be usable."¹⁴⁹ Accordingly, that final rule did not permit any horizontal movement of VOA headlamps, with the lamp essentially being correctly aimed as installed, unless the headlamp was equipped with a horizontal VHAD. The horizontal VHAD was included as a compliance option (and required to be set to zero) as a means for manufacturers to meet European requirements for both a horizontal and vertical aim adjustment. For these reasons, in 1999 NHTSA denied a petition for rulemaking to allow VOA headlamps to have a horizontal adjuster system that does not have the required 2.5-degree horizontal adjustment range or a VHAD indicator.¹⁵⁰

Although VHADs are not widely (if ever) used, NHTSA is not persuaded that a VHAD for horizontal aiming would not be feasible for ADB-equipped headlamps. The commenters did not present any information to show VHADs are necessarily incompatible with the aiming accuracy necessary for ADB systems. While VHAD devices used prior to the allowance of visual optical aiming in the U.S. may have been inaccurate, these limitations are not driven by the requirements placed on VHADs by the FMVSS.¹⁵¹ The minimum requirements in FMVSS No. 108 for horizontal VHADs provide a floor below which accuracy cannot drop, but do not limit aiming accuracy.

For example, the requirements in S10.18.8.1.2 that the VHAD include references and scales relative to the longitudinal axis of the vehicle, including a "0" mark and an equal number of graduations from the "0" mark, limit neither precision nor accuracy. The horizontal VHAD need only be accurate enough to set at 0 in order to perform basic photometry testing in the lab. Other measurement cues (including more precise methods) may be used to more accurately aim the headlamps on the vehicle for the purposes of ADB functionality. The

¹⁴⁹ *Id.*, p. 10715.

¹⁵⁰ 66 FR 42985 (Aug. 16, 2001) (denial of rulemaking petition from Federal-Mogul Lighting Products).

¹⁵¹ See S10.18.8.

regulation does not restrict this but allows the flexibility to customize such methods to accommodate any unique features present in any beam.

Even if NHTSA were to agree with the commenters that VHADs were not optimal for ADB systems, the agency does not currently have, and the commenters did not provide, a workable alternative. For example, SAE's suggested amendments to S10.18 and S14.2.5 simply stated that "if the headlamp is equipped with ADB, and has horizontal aim, it shall be adjusted according to the manufacturer's instructions." If the commenters sought allowance of horizontal VOA aim for ADB systems, they did not provide information on how this would work in practice. Unlike the lower beam pattern in Europe, where the lower beam pattern has a vertical cutoff component and uses VOA for horizontal aim, the U.S. lower beam pattern has no such required cutoff or other cues—meaning horizontal VOA in FMVSS No. 108 is not currently feasible.¹⁵² If the beam pattern were to include cues that could be used to visually aim the headlamps horizontally, such a procedure could be workable. Such procedures, however, have not been developed for the United States market for visual/optical horizontal aim of the headlamps, and they would need to include, among other things, a cut-off requirement analogous to the current requirements for the horizontal cutoff for the lower beam.¹⁵³ In addition, such requirements would limit the flexibility of beam pattern design currently permitted by the standard. This could limit the potential for innovative safety solutions generally afforded by this final rule. On the other hand, if the commenters referred to non-VOA methods, they were not presented to the agency.

NHTSA agrees, however, that several of the requirements for horizontal VHADs (in S10.18.8.1.2.1–4) are not necessary for ADB systems. S10.18.8.1.2.1 requires that each graduation must represent a change in the horizontal position of the mechanical axis not greater than 0.38° (2 in at 25 ft) to provide for variations in aim at least 0.76° (4 in at 25 ft) to the left and right of the longitudinal axis of the vehicle, and must have an accuracy relative to the zero mark of less than 0.1°. As the commenters alluded to, this minimum accuracy of graduation is

likely not adequate for aligning the camera and headlamps. NHTSA expects that a more accurate method will be utilized to align the lamps and the camera and does not expect this alignment procedure to be manually conducted by non-expert vehicle owners. Similarly, S10.18.8.1.2.2–3 pertain to the readability of those graduations. S10.18.8.1.2.4 specifies minimum horizontal indicator and aiming ranges. Those limits are not relevant to ADB aim because they are intended to align the lamp with the vehicle, whereas ADB systems require the alignment of the lamp with the camera. NHTSA expects that this alignment range will be determined by each manufacturer appropriate for their camera installation and body tolerances. Consequently, the final rule exempts ADB systems from these requirements.

With respect to harmonization, the agency recognizes that VHADs add some additional cost, but the option to use a horizontal VHAD was actually intended to facilitate harmonization by giving manufacturers a way to meet both the ECE requirements (which require both a horizontal and vertical aim adjustment) and the U.S. requirements (which require only vertical aimability). A VOA headlamp intended for sale in both the European and U.S. markets would likely have a vertical aiming screw and a horizontal VHAD, while one intended for use only in the U.S. market need only provide for vertical adjustment.¹⁵⁴ In practice, manufacturers wishing to sell essentially the same headlamp design in both markets, but not utilize a horizontal VHAD, would typically design a lamp with both a vertical and horizontal aiming screw, and lock out (or make inaccessible) the horizontal screw in the U.S.-market version.

d. Road Surface

The NPRM proposed several specifications related to the quality of the test track surface, including that the tests would be conducted on a dry, uniform, solid-paved surface; that the road surface have an International Roughness Index (IRI) measurement of less than 1.5 m/km; and that the test course surface be composed of concrete or asphalt. The proposal also included an allowance for momentary glare exceedances that might be related to, among other things, imperfections in the road surface. SAE J3069 specifies an identical IRI value and that the test course surface be uniform, straight, flat and represent a typical road surface.

Comments

Intertek commented that the IRI is not simple to measure quantitatively and that requiring a road surface quality of 1.5 m/km will impose unnecessary restrictions on the test track. The commenter recommend instead using the SAE J3069 value of 3 m/km.¹⁵⁵ Auto Innovators commented that, for its testing, longitudinal lane IRI measurements were within the NPRM specification, averaging near 0.475 m/km, but that atypical IRI measurements across transverse lanes (east/west) are unknown and may impact testing on curves.

ALNA commented that test ground conditions and variations should be reflected in the requirements and suggested applying tolerances in order to reflect variations such as ground unevenness. Toyota commented that the NPRM did not sufficiently define the test track conditions and that failure to do so would affect compliance test results.

Agency Response

The final rule deletes the IRI specification. The purpose of the IRI specification was to limit angular changes between the vehicle and the illuminance meters throughout the test run. This was anticipated to provide a boundary limit for which a vehicle manufacturer could certify performance of its vehicle. In other words, the ADB system was not expected to perform to the limits specified in the NPRM on a bumpy or wavy road. However, during NHTSA's most recent testing, it was found that a more direct approach—pitch adjustment—could be used to limit this orientation. IRI values are a general measurement of road roughness, but, in the context of the track test in this rule, are essentially a proxy for vehicle pitch: A test conducted on a test track surface with a low IRI will generally have less pitch variation than a test conducted on a surface with a high IRI. Directly measuring vehicle pitch eliminates the need for the IRI parameter.

NHTSA believes that directly accounting for vehicle pitch addresses Auto Innovators' concern that the transverse IRI may influence test results (by influencing vehicle pitch, which in turn influences test results) on curve scenarios. The area of the test facility that NHTSA used for its most recent

¹⁵² The ECE horizontal aim test procedure is in R112 Annex 9. This procedure is not suitable for headlamps in the U.S. because it relies on features in the beam pattern, such as the kink, that are not required to be present in a lower beam pattern by FMVSS No. 108.

¹⁵³ See S10.18.9.1.

¹⁵⁴ 66 FR 42985, 42986 (Aug. 16, 2001).

¹⁵⁵ SAE J3069 JUN2016 states, in section 7.1, that it is recommended that the road have an IRI of less than 1.5 m/km, while the text accompanying Figure 5 states that the IRI should be less than 3. SAE J3069 MAR2021 corrects the text in Figure 5 to state 1.5.

testing had an IRI of 1.46 m/km in the EW direction and an IRI of 1.61 m/km in the NS direction. In conducting its testing, however, NHTSA nested the straight, right, and left curves of each radius on the TRC VDA large-area test facility. As such, those IRI measurements are not direct measurements of the longitudinal or transverse paths taken during ADB testing. While the final rule limits the number of scenarios, it retains 6 different curved-path scenarios, including various radii for right and left curves. These paths may have slight, but potentially meaningful, differences in longitudinal IRI. While this longitudinal test surface roughness measurement is possible along each path, requiring a new IRI measurement any time the path is altered would be unnecessarily burdensome, considering it is possible to instead directly measure vehicle pitch. Additionally, the IRI can change over time, especially considering large temperature changes; it is possible that a path that in one season is under 1.5 m/km will exceed that value in a different season. Replacing the IRI parameter with a procedure for directly measuring and limiting the pitch variation of the test vehicle eliminates these concerns.

With respect to the comments by ALNA and Toyota, the commenters did not identify specific additional ways to specify the test conditions. For the reasons given here and elsewhere in the preamble, NHTSA believes the final rule sufficiently accounts for test surface conditions to control for the major sources of testing variability—including vehicle pitch—related to the test track.

e. Ambient and Reflected Light

The NPRM proposed to control for ambient and reflected light, which can interfere with test results, in a few ways.¹⁵⁶ Ambient illumination recorded by the photometers must be at or below 0.2 lux; testing must be conducted on dry pavement, and with no precipitation; the test road must be free of retroreflective material; and the pavement must not be bright white (to avoid intense reflections). Notwithstanding such controls, some degree of ambient light is unavoidable. Accordingly, in testing for compliance the agency proposed to zero-calibrate the photometers. SAE J3069 similarly

¹⁵⁶ Ambient light refers to light emitted from a source other than the ADB system. This may include moonlight, light pollution from nearby buildings, or light coming from the test fixture itself. Reflected light refers to light from the ADB vehicle's headlamps reflected off the road or other surfaces (including rain or fog droplets) onto the photometric receptors.

specifies that the test track does not contain retroreflective material and that testing be conducted during clear weather on dry pavement.

Comments

Intertek tentatively agreed with NHTSA's assessment of the impact of stray and ambient light on the test. Some commenters, however, stated that the proposal did not sufficiently control for ambient light. The Alliance and Volkswagen commented that ambient light can change throughout the data collection (*e.g.*, due to clouds, the moon) during a test, which could introduce uncontrolled variability and difficulty in repeatability and reproducibility of test results. ALNA suggested applying tolerances for variations in test course surface conditions including ground reflectivity.

Volkswagen commented that the presence of reflectors in the environment could cause test results to vary and that the NPRM did not address environmental conditions such as fog, dust, or pollution which exist in real-world testing and can introduce variability that will present challenges for repeatability and reproducibility. Mobileye commented that the track test requirements should specify that fog and dust should not be present when performing testing. TSEI recommended the agency clarify how ambient conditions should be treated.

Agency Response

The final rule adopts the proposed test procedures, but modifies the photometer zero-adjustment procedure to reflect the fact that the test uses fixtures, not stimulus vehicles. The meters will continue to be zero-calibrated for each scenario tested.

With respect to the comment about ambient light changing throughout the test, NHTSA found that the ambient light did not change significantly during a test session. Further, NHTSA's testing method accounted for ambient conditions by measuring ambient illuminance either immediately before or after each test trial and subtracting that value from the recorded test data. The repeatability analysis, which included testing on different nights, showed that the night on which testing occurred did not appear to be a significant source of variation. The commenters did not recommend any alternative methods to account for ambient or reflected light. SAE J3069 does not specify how ambient conditions or reflected lighting are to be treated aside from requiring that “[n]o other vehicle lighting devices shall be

activated or any retro-reflective material present and care should be taken to avoid other sources of light, reflected or otherwise.”¹⁵⁷ Although the final rule does not specify a baffle, the regulatory text does not prohibit it if it provides more accurate results for a particular location. The agency did not study adding baffles in a systematic way because testing did not show stray light to be a significant contributor to variability.

With respect to reflectivity, as noted above, the proposal (and final rule) specifies that the test road be free of retroreflective material and that the pavement may not be bright white. With respect to tolerances, although the agency does not expect reflectivity to affect the illuminance measurements, the allowance for momentary exceedances would be applied to spikes in illuminance caused by any such factors. NHTSA is not aware of any standardized way of accounting for dust or fog, and the commenters did not identify any such method. In any case, the same test conducted on different nights did not lead to much variation in results. Certainly, if ambient environmental conditions were such that there was an unusual concentration of particulates—or any other unusual conditions that would be likely to affect test results—NHTSA would not attempt to conduct compliance testing. In addition, NHTSA's testing showed that the ambient light did not appear to fluctuate dramatically in the relatively short times it took to perform a test run. And, as noted above, the recorded test data was adjusted by subtracting the ambient illuminance. The agency therefore believes that test outcomes will generally not be affected by changes in ambient light.

f. Superelevation

Superelevation refers to the degree of banking of a road. The NPRM specified that the test track have a superelevation of 0% to 2%. We explained that it was desirable to minimize the degree of banking because photometry design as well as the existing and derived glare limits are based on flat surfaces.

Comments

Auto Innovators commented that it found that modifications to the specified superelevation were necessary to accommodate the track lengths at its test facility.

Agency Response

The VDA test pad, on which NHTSA's most recent testing was conducted, has

¹⁵⁷ 5.5.2.1 and 5.5.3.1.

a slope of 1% in the direction between the two loops. That means that the largest superelevation that we tested was less than 1%. The superelevation would be 1% had we tested across the width of the pad and 0% had we tested along the length of the pad. All the recent NHTSA tests were conducted somewhere between these two extremes. Accordingly, every test scenario traversed had a superelevation of less than 1% (based on the TRC site plan).¹⁵⁸

We recognize that superelevation could, conceivably, influence test results.¹⁵⁹ Depending on the details of the curve/fixture location, a large superelevation can either increase or decrease the likelihood that the measured illuminance will exceed the relevant glare limit. Superelevation effectively rotates the beam pattern around the centerline of the vehicle. If the rotation causes the pattern to rotate down with respect to the sensor location, it is less likely that the measured illuminance will exceed the glare limit; if, on the other hand, the rotation causes the pattern to rotate up with respect to the sensor location, the measured illuminance is more likely to exceed the glare limit. More specifically, on a left curve a positive superelevation will always make it less likely that the glare limit will be exceeded because the fixture is always on the left side of the beam pattern and the superelevation causes a rotation of the beam pattern counterclockwise. For the portions of a right curve at which the photometric receptors are to the left of the beam pattern, a positive superelevation will increase the likelihood that the measured illuminance will exceed the glare limit because the beam pattern is rotated clockwise for a positive superelevation on a right curve. Finally, for straight-path test scenarios, a large positive superelevation will always be more stringent because the “crown” in the road rotates the beam pattern clockwise and the fixture is always to the left.

We do not expect superelevation to have a meaningful impact on the test results, especially compared to the effect of vehicle pitch, which can materially impact test results. For this reason, we concluded that it was not necessary to include an adjustment for superelevation.

¹⁵⁸ See TRC site plan at www.trcpg.com/wp-content/uploads/2016/10/Vehicle-Dynamics-Area.pdf last accessed on February 16, 2021.

¹⁵⁹ In addition, the wider the specified range of superelevation, the more stringent the test, because the vehicle must perform over a larger range of superelevation angles.

g. Lane Divisions

The NPRM specified that the test track lanes may have a median of up to 6.1 m (20 ft) wide and should not have any barrier taller than 0.3 m (12 in.) less than the mounting height of the stimulus vehicle’s headlamps. SAE J3069 does not specify any lane divisions or medians but does specify that the test track area be free from obstructions and retroreflective markings.

Comments

Mobileye commented that roads with narrow curves do not typically have such wide medians, and this will place the stimulus vehicle at a very wide angle to the host vehicle. Intertek questioned the need to consider medians or barriers and suggested that the median be limited to a standard lane divider. SL Corporation commented that a traffic barrier is not necessary and may make it difficult for ADB systems to accurately detect oncoming traffic, recommending that final rule provide a more detailed specification if retained. SAE questioned the inclusion of a 20-ft median for a 320-ft curve because medians of that size are typically found only on higher speed interstate roads which do not contain curves of that sharpness.

Agency Response

NHTSA agrees with commenters that a median or barrier is not useful for testing. These features are not included in the final rule.

h. Hills

The NPRM did not propose testing on sloped (dipped or hilly) roads, explaining that even headlighting systems with compliant lower beam photometry can glare oncoming or preceding vehicles on sloped roads because the hill geometry may place that vehicle in the brighter portion of the lower beam pattern. NHTSA’s testing was consistent with this, showing ADB headlighting systems and FMVSS-compliant lower beams glared oncoming and preceding vehicles on roads with dips.¹⁶⁰ NHTSA tentatively concluded that to require this performance of ADB systems would be neither practical nor consistent with the approach of this rulemaking (extending the existing lower beam glare requirements to ADB systems).

Comments

AAA asserted that the track test should include scenarios with undulating roadways and hills but

¹⁶⁰ 2015 ADB Test Report, pp. 102, 108, 114.

seemed to suggest that this might be limited to ADB systems with higher-intensity upper beams (*i.e.*, at the ECE maximum). AAA commented that ADB technology has the ability to avoid glaring other drivers in these situations, and that including this in the test will create pressure to more quickly and successfully address this.

Agency Response

The final rule does not include testing on dips or hills for several reasons. First, this approach would be more stringent than current requirements. Current lower beams create glare for other drivers on hills. The general approach of this rulemaking was to extend the current headlamp requirements to ADB systems, not to increase the stringency of existing requirements for ADB systems. Second, NHTSA’s testing indicated that current ADB systems did not perform well on hill scenarios. Although including such scenarios in the track test could help speed the development of ADB systems with these advanced capabilities, it would likely make the systems more costly and slow deployment. Finally, NHTSA has not developed test procedures for such scenarios. This would take additional time and resources and would require developing a complex test track that would be specific to ADB testing. However, while it is outside the scope of the current rulemaking to test ADB systems to ensure that they produce less glare than current headlamps, NHTSA intends to monitor this issue and will consider future action if warranted.

10. Data Acquisition and Measurement

a. Photometers

The proposed regulatory text specified that the photometer must be capable of a minimum measurement unit of 0.01 lux.

Comments

Intertek suggested specifying that the photometric receiver have a cosine response and be spectrally matched to the photonic response of the human eye. It also suggested an accuracy limit of $\pm 5\%$ nominal over the full range of illuminance from 0.01 lux to the upper limit (about 100 lux).

Agency Response

NHTSA’s testing utilized a Minolta T10A illuminance meter. The manufacturer’s specifications indicated that it has a spectral response within 6% of the (CIE) human eye photopic vision $V(\lambda)$ and a cosine correction characteristic within 3%. The photometers used in agency research

were capable of measuring light within 3% of the ideal cosine response. NHTSA agrees with Intertek's suggestion and has modified the regulatory text to include photometer specifications drawn from S14.2.5.7.3 and to specify a cosine response within 3%.

The agency also notes that the IIHS headlamp testing procedures¹⁶¹ used baffles on the photometry equipment at 25 degrees to ensure that the light captured was more directly attributable to the test vehicle light source, and not to stray lighting that may be captured by the photometer. This 25-degree angle is roughly equivalent to the angles of incidence of light received from the light source when the test vehicle is approaching the stimulus through a curve on the roadway surface and equates to the angles at which ADB systems are typically scanning for targets to shade. NHTSA finds the IIHS test method specifications closely match our intent and has adopted similar language to include a 25-degree angle of incidence.

b. Sampling Rate

The NPRM proposed to sample illuminance at a rate of at least 200 Hz. SAE J3069 specifies a sampling rate of 10 Hz, and IIHS test methods sample illuminance at 200 Hz.

Comments

Volkswagen commented that sampling at 200 Hz would lead to a more complex selection of measuring equipment and analysis for each experiment and supported the SAE J3069 specification. Global requested that NHTSA explain the appropriateness of this minimum sampling rate and whether a maximum sampling rate should be specified.

Intertek commented that 200 Hz is near or exceeding the capability of most high-grade light meters and recommended reducing the sampling rate to 100 Hz in order to resolve illuminance in the ranges necessary for this test. Intertek also stated that reducing the sampling time to 100 Hz is supported by the allowance of momentary exceedances up to 0.1 seconds in duration (100 Hz would include 10 measurements within that 0.1 seconds) and suggested determining acceptance based on a time-averaged sampling rate at 10 Hz to account for very fast variances in the illuminance level as well as the human eye response.

Agency Response

After considering the comments, the final rule adopts a sampling rate of at least 100 Hz. NHTSA is balancing the need for precise data collection with the cost and availability of equipment. NHTSA agrees that 200 Hz is faster than the minimum needed to verify compliance, particularly considering the 0.1 second allowance, but the SAE sampling rate of 10 Hz simply provides too little data to ensure that ADB performance is within the specified glare limits. While a 200 Hz sampling rate matches that used by NHTSA in both its most recent research and in the research reported in the 2015 ADB Test Report (as well as that used by IIHS), and did not present any issues, NHTSA agrees with Intertek that a sampling rate as low as 100 Hz would provide adequate data collection to detect exceedances lasting near the 0.1 s allowance. As described by Intertek, a 100 Hz data collection method collects 10 readings within 0.1 s. This is adequate to judge a short exceedance, and an extra 10 readings provided by a 200 Hz rate would not substantially change that ability. A sampling rate of 10 Hz however would collect only a single reading over 0.1 s, making it difficult to judge the actual time a short exceedance lasts. The agency considered adding a maximum sampling rate but does not believe doing so is necessary because the final rule specifies an allowance for momentary glare exceedances (up to 0.1 s) as well as a low-pass filter with a cutoff frequency of 35 Hz.

NHTSA is not incorporating time-averaged sampling due to concerns that the delay associated with time-averaging would make it difficult to properly synchronize illuminance and distance. This is particularly important at higher vehicle speeds. Time-averaging (depending on the parameters) could also collect illuminance levels from one location over time and report that data at a moment while the vehicle is closer to the fixture. This would have the result of shifting illuminance levels down because all tests are arranged such that the vehicle approaches the fixture, and never moves away from it.

c. Noise and Filtering

The NPRM did not specify any filters other than the 0.1 s or 1m spike allowance, and the proposal did not explore this issue although it sought comment on it. The IIHS test procedure does specify that photometric sensor signals be filtered through a low-pass filter with a cutoff frequency of 35 Hz. This allows for accurate measurement of

all existing types of headlamp light sources, including pulse width modulated systems like LEDs. IIHS test methods sample illuminance at 200 Hz, and any ambient offset for the measurements is based on the minimum ambient illumination from 1–5 seconds after the test vehicle has passed the measurement location.

Comments

Global requested that the agency clarify which standards OEMs will be permitted to use when removing test data noise from measured data, and suggested incorporating any such standards in the final rule or the formal compliance test procedure (NHTSA understands this to refer to the laboratory test procedure, which is not part of the regulatory text but is published separately by the Office of Vehicle Safety Compliance). Intertek suggested that to ensure that all the energy is accounted for, the minimum data acquisition rate should be 100 Hz, and the data should be subject to averaging or boxcar smoothing to reduce the effective sampling rate to a frequency of 10 Hz. Intertek alternatively suggested an integrating photometer with a period of 100 ms. The final product would then be the filtered illuminance (with PWM, pitch, and other sources of noise averaged out) reported with a frequency of 10 Hz (or another frequency such as 25 or 33 Hz based on the human eye response), or if boxcar averaging, it could be reported at 100 Hz (with the understanding that each measurement carries 10 Hz of averaging).

Agency Response

In response to Global's request, the final rule specifies that NHTSA will use a low-pass filter with a 35 Hz cutoff frequency.¹⁶²

The low pass filter essentially reduces high-frequency noise by adjusting each data point by comparing it to the average of the neighboring data. Any individual points that are higher than the immediately adjacent points are reduced, and any points lower than the immediately adjacent points are increased. As long as the general data trends in the underlying signal are true (low frequency—allowed to pass), then the signal will not be distorted by smoothing. This filter is suitable for the types of measurements collected as it

¹⁶² As NHTSA has pointed out in the past, the FMVSS specify the procedures NHTSA will use in compliance testing. While manufacturers must exercise reasonable care in certifying that their products meet applicable standards, they are not required to follow the compliance test procedures set forth in a standard.

¹⁶¹ See *supra* note 93.

results in the most complete response to noise without detrimental effects on the data. Because the noise effects are assumed to be evenly distributed with a standard deviation (d), the noise remaining in the measurements will be approximately d over the square root of the smooth width (m) of 35 samples at the 100 Hz we are collecting data. At the finalized low-pass filter rate, that reduces the noise to less than 0.03 of the standard deviation of the noise in the lux. Filtering will not eliminate the measurement noise and will result in a slight reduction of the peak lux values measured during the track test. The agency does not expect this to affect test results, however, both because the reduction in the peak value is limited by the higher sampling rate (100 Hz versus 10 Hz for SAE) and because even at the broad width of the smoothing filter, the filter only smooths values over roughly a third of the “sudden spike” timing, allowing for differentiation of a spike from a non-compliance.

The box-car averaging has the advantage of filtering out both signal and test condition noise. Such data treatment is useful for smoothing rapidly changing signal data, such as that type of data that may result from vibratory effects as the test vehicle moves across the track test bed. It is essentially equivalent to using a low pass filter, as specified in the IIHS test procedure. The final rule is therefore consistent with Intertek’s comments.

d. Allowance for Momentary Glare Exceedances

The NPRM proposed an allowance for momentary glare exceedances (or “spikes”) of not greater than 0.1 second in duration or spanning 1 m of vehicle travel. This was intended to account for variations in illumination due to uncontrolled testing variables, such as minor imperfections in the road surface.¹⁶³ Minor imperfections in the road surface can cause glare exceedances by affecting vehicle pitch.

Comments

Some commenters believed the proposed allowance was insufficient. Toyota stated that the requirements to minimize glare go beyond the levels currently specified in the standard and beyond what is needed to meet a safety need and that, given the strict allowance

¹⁶³ This is different from an allowance for an adaptation time (referred to as “reaction time” in SAE J3069) which we understand as referring to another possible reason for a testing allowance: To account for the operation of the ADB system itself, because, as the discussion in SAE J3069 points out, “ADB cannot react instantaneously.” This is discussed in Section VIII.C.5 above.

for momentary glare, additional test parameters would need to be defined; for example, the vehicle pitch can vary (due to the condition of the road, suspension, tires, and the vehicle’s acceleration), potentially affecting the compliance result. Similarly, SAE and Volkswagen commented that a 0.1 second allowance is insufficient, would frequently be exceeded even by compliant lower beams (for example, due to momentary changes in vehicle pitch), and it would be unreasonable to expect an ADB system to comply with the glare limits in the numerous proposed test scenarios with only that allowance. Auto Innovators proposed that NHTSA increase this allowance to 2.5 seconds, based on the human response time to the sudden appearance of an opposing or preceding vehicle. ALNA agreed that it is appropriate to apply tolerances in order to cover on-road application and reflect variations in test ground conditions.

SAE, Global, Ford, and the Alliance stated that in order to account for otherwise uncontrolled-for test variability, NHTSA should follow SAE J3069 such that the glare limits may be exceeded if the ADB illuminance does not exceed 125% of the lower beam illuminance from the vehicle measured under the same conditions. SAE, Global and Ford commented that this better represents real-world conditions and compensates for environmental factors such as dips and bumps in the road, reflectivity of lane markers, ambient light, and vehicle pitch.

Global commented that the term “spike” is not defined and recommended that it be defined relative to accommodating the natural behavior of certain headlamp light sources to have a “spike” of light intensity during the sequence of use.

Global also pointed out that in the proposed regulatory text (“no longer than 1 meter”) “that” should be replaced with “than.”

Auto Innovators commented that the distance exceedance limit should be eliminated because specifying both a time and distance specification is duplicative, and timing is more relevant to real-world driving.

Agency Response

The final rule retains the 0.1 second component of the momentary glare exceedance allowance and adds (as discussed in the next section) an allowance for vehicle pitch.

The momentary glare exceedance allowance accounts for testing-related variability caused by noise and uncontrolled test factors (such as

uncontrolled ambient illuminance).¹⁶⁴ NHTSA believes that 2.5 seconds is an inordinately long time for a “momentary” exceedance, for the reasons discussed earlier.¹⁶⁵ The agency also declines to follow SAE J3069 and allow ADB illuminance to exceed lower beam illuminance by up to 25%. The reasons for this are discussed in Section VIII.C.4, Maximum Illuminance Criteria (Glare Limits). NHTSA agrees with Global that there was a typographic error in the proposed S14.9.3.12.8.1 (now at S14.9.3.12.2), which has been corrected in the final rule. The agency also agrees that even at the slowest test speed of 25 mph the limiting factor is time, not distance, and has removed 1 m from the text as it serves no practical purpose.

NHTSA is removing the term “spike” and replacing it with a clearer description of the adjustment: The agency will not consider, in determining compliance, “single illuminance values or consecutive illuminance values occurring over a span of no more than 0.1 seconds that exceed the applicable maximum illuminance[.]” The momentary glare exceedance duration may end in at least two ways. First, the illuminance value can drop below the applicable glare limit. Second, the glare limit itself might change (*i.e.*, increase). This could happen if the exceedance is experienced just before the glare limit changes. In either case, if the glare limit is not exceeded for more than 0.1 s, the exceedance will not be considered a noncompliance.

e. Vehicle Pitch

Pitch refers to rotation of a vehicle about its transverse axis appearing as an opposing vertical motion of the front and rear ends of a vehicle. When a vehicle’s pitch increases, the vehicle’s front end, and therefore the angle of its headlamps, will raise in an upward direction away from the road surface. Conversely, when pitch decreases, the vehicle’s front end will lower, and the headlamps light will be cast downward towards the road surface.

The amount of glare perceived by other roadway users may be more pronounced when the headlamp is pitched upward. Common causes of changes in vehicle pitch angle include vehicle loading condition or weight

¹⁶⁴ NHTSA, in its testing, did not observe any test-related variable other than pitch that led to a glare exceedance. While some limited glare exceedances lasting less than 0.1 seconds were not caused by pitch, these appeared to result from marginal performance from the ADB system. The 0.1 second allowance means that such exceedances would not be considered a noncompliance.

¹⁶⁵ See Section VIII.C.5, ADB Adaptation Time.

distribution, tire inflation that deviates from specifications, irregularities or pitting in the road surface, vehicle suspension characteristics, and vehicle acceleration. As mentioned above, the NPRM did not propose any adjustments to correct directly for or take vehicle pitch into account as part of the compliance track testing, although it specifically sought comment on this.

In the IIHS test method, pitch effects are corrected by measuring road surface pitch changes through a self-leveling horizontal rotary laser system every 5 m along the test track surface. The pitch angles at each measured position are measured, and photometers placed at different heights provide the illuminance data for each measurement location. Once this illuminance data is collected, a pitch correction factor is calculated that is used to offset any exceedance of glare limits based on the roadway conditions.

Comments

As noted in the section above on allowances for momentary glare exceedances, several commenters noted the potential effect of vehicle pitch on test results. For this reason, Ford recommended NHTSA adopt the IIHS pitch correction protocol. Ford commented that pitch correction is essential to produce results that are

independent of differences in vehicle suspensions and are repeatable at different test tracks and different locations on the test tracks themselves. Ford noted that dynamic testing makes illuminance more difficult to measure because throughout the driving event, the vehicle pitch changes and effects from instrumentation inaccuracies increase proportionately. On the other hand, Intertek claimed that pitch correction would not be necessary unless there is a sustained change in pitch longer than 0.1 seconds.

Agency Response

After analyzing the comments and its own testing NHTSA has modified the proposal by adding in an explicit allowance for pitch variation: The agency will not consider any illuminance measurements recorded while the vehicle pitch exceeds the average pitch recorded throughout the entire measurement distance range specified for that scenario by more than 0.3 degrees.

Although the NPRM did not propose any adjustments to directly take vehicle pitch into account, the NPRM requested comment on this issue. Further, the proposed test procedures controlled for the following factors that could affect pitch:

- Vehicle loading and suspension—the headlamps will be aimed when the vehicle is loaded as it will be during testing, and the gas tank (if the vehicle is equipped with one) is maintained at least three-quarters full. The tires will be within 1 psi of recommended cold pressure.

- Road surface—the road surface must have an IRI measurement of less than 1.5 m/km.

- Vehicle acceleration—the vehicle speed must be maintained within 1 mph of the target test speed throughout the test run.

In addition to these procedures, as explained above, the proposal also contained an allowance for momentary glare exceedances that was intended to account for variations in illumination due to uncontrolled testing variables, including minor imperfections in the road surface that can cause glare exceedances by affecting vehicle pitch.

Despite these specifications, NHTSA's test data revealed two situations in which vehicle pitch still impacted measured illuminance and were not accounted for in the provisions listed above.

First, NHTSA repeatedly observed small cyclical pitch changes related to road surface undulations, which affected illuminance measurements. For one example, see Figure 34.

Figure 34. Fusion's lower beam 250 m left at 41 mph

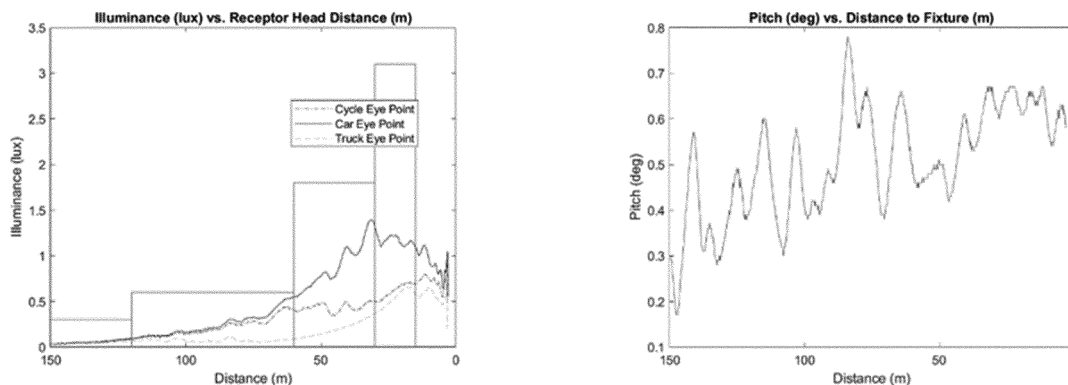

Here, where the maximum pitch occurs (at about 85 m), there is a peak in the illuminance reading. The highest illuminance value (at about 31 m) also coincides with a positive spike in pitch. (In these instances, the pitch did not exceed the average pitch by more than 0.3 degrees, so if this were a compliance test, these values would still be considered when assessing compliance; in any case, in this instance, all

illuminance values are still within the glare limits).

To better understand the sources of the pitch oscillations identified in testing, NHTSA collected pitch information both when the test vehicle was moving, and when it was stationary at the same (or as close as possible) location on the test surface. See Table 7. The pitch measurements were similar, indicating that dynamic contributors were generally small. Accordingly,

although the testing did not show any instances where pavement-related vehicle pitching led to a glare exceedance that would be excused through the final pitch variation allowance, the agency recognizes the possibility for this to occur and has thus accounted for pitch in the regulatory text.

TABLE 7—VEHICLE PITCH IN STATIC AND DYNAMIC STATES

Distance	Pitch (deg.)
Speed: 41 mph:	
148.982	0.3
119.254	0.46
59.605	0.51
29.926	0.64
15.145	0.65
Speed: 0 mph (static):	
149.058	0.17
119.274	0.51

TABLE 7—VEHICLE PITCH IN STATIC AND DYNAMIC STATES—Continued

Distance	Pitch (deg.)
59.650	0.46
29.939	0.63
15.152	0.63

Second, NHTSA observed pitch changes related to acceleration. For example, NHTSA tested the lower beams on the Fusion at 69 mph in a

straight-path scenario. See Figure 35. When the vehicle reached the beginning of the illuminance measurement range (220 m) it had not yet attained the target speed, so it was still accelerating and pitching upward, resulting in an “exceedance” of the applicable glare limit. The pitch of 1.1 degrees during the exceedance was greater than 0.3 degrees over the average pitch of 0.68 degrees. This shows that pitch in excess of the proposed allowance could lead to an exceedance of the glare limits.¹⁶⁶

Figure 35. Example of application of vehicle pitch allowance

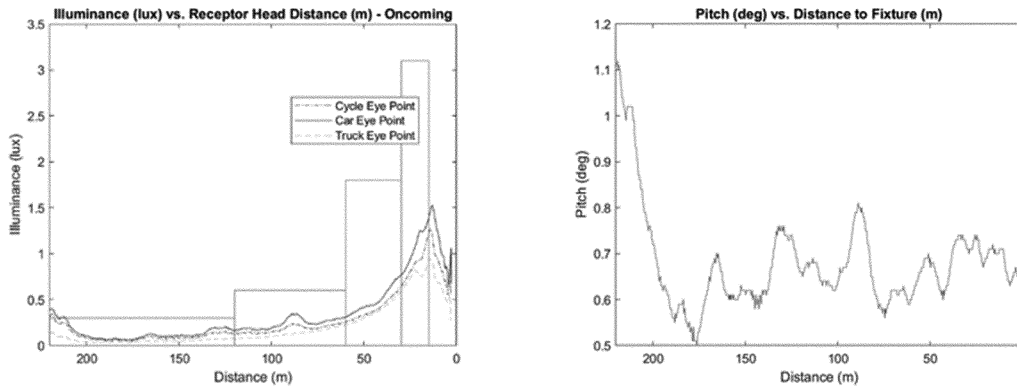

Based on these instances of vehicle pitch fluctuations impacting measured illuminance (due to either the road surface or acceleration), the final rule includes an allowance for vehicle pitch variation. NHTSA’s testing demonstrated that it is generally possible to maintain pitch within less than 0.3 degrees of the average pitch recorded throughout the entire measurement distance. We believe that no allowance for pitch, or a higher pitch variation allowance (e.g., “by no more than 0.4 degrees)—resulting in a more stringent test—could lead manufacturers to design headlamps providing sub-optimal visibility (because manufacturers might aim the headlamps down to minimize the possible effects of pitch during a compliance test).

We believe this adjustment methodology is preferable to the IIHS pitch correction procedure for the purposes of this rule. The IIHS test procedure relies on interpolation, which introduces inaccuracy (without knowing the linearity of the beam pattern). The final rule methodology does not interpolate but instead measures pitch directly. By controlling pitch to 0.3

degrees or less and regulating performance only within that range, we are directly measuring the aspect of performance that matters to safety. The IIHS procedure also requires that the vehicle path be mapped with respect to pitch prior to running the test. The final rule procedure does not require this, which simplifies the test procedure.

11. Repeatability

The NPRM included an analysis of the repeatability of the test data from the 2015 ADB Test report.¹⁶⁷ That test data was based on the proposed test procedures, which utilized dynamic stimulus vehicles.

Comments

NHTSA received a variety of comments on the repeatability of the proposed test. One commenter, Intertek, agreed with NHTSA’s repeatability analysis. Other commenters expressed concerns that the proposed test procedures were not repeatable based upon the complexity of the proposed test procedures and a variety of test conditions that might affect repeatability. Commenters identified

several factors they argued would adversely affect repeatability.¹⁶⁸

Auto Innovators, MEMA, the Alliance, TSEI, and Volkswagen commented that the proposed track testing was overly complicated and expressed concerns that it would not lead to repeatable results.

SAE commented generally that test results (both for tests conducted on the same track and for tests conducted on different tracks) would be sensitive to the environment because lighting measurements are affected by small changes in conditions. Other commenters echoed this and identified unspecified test conditions that they argued could introduce uncontrolled variability, causing acceptable levels of repeatability and reproducibility of the test scenarios to be extremely challenging to achieve, particularly given the stringency of the requirements. The Alliance and Volkswagen commented that, although the NPRM requires the photometers to be zero-calibrated to the ambient light, the ambient light can change throughout the data collection, introducing uncontrollable variability. Volkswagen

¹⁶⁶ Because the target speed had not yet been attained, had this been a compliance test, the measured illuminance value would not be having been considered in determining compliance. We also note that this glare exceedance lasted for more

than 0.1 second, so it would not have been addressed with the momentary glare allowance.

¹⁶⁷ NPRM, pp. 51789–51798.

¹⁶⁸ A number of comments about repeatability were related to the proposal to use stimulus vehicles. Because the final rule does not use stimulus vehicles, we need not address those comments as the issue is moot.

also stated that the presence of reflectors in the environment may also cause variances by redirecting part of the test vehicle lights into the photometers. Volkswagen also commented that the NPRM only specified that there be no precipitation and a dry road surface, but other environmental conditions such as fog, dust, or pollution could affect results. TSEI identified variation in road materials and reflectivity, weather conditions, and road surface as other factors. Toyota identified the test vehicle’s suspension, tires, and acceleration/deceleration during the test as affecting repeatability; it stated that it is unclear whether any test track meets the ideal conditions specified in the proposal, and, if so, whether such a test track can be reasonably accessible to conduct compliance testing.

Auto Innovators commented that to evaluate testing variability, one member company repeated a test series using a vehicle tested by FTTA and cited in the NPRM. The full test series was repeated under the same conditions using comparable measurement equipment. The commenter stated that, despite careful attention to test setup and test conditions, the results varied from those obtained by FTTA to the extent that the variation altered the compliance status of the vehicle.

Agency Response

The final rule substantially reduces the complexity of the test, especially by using test fixtures instead of stimulus vehicles and streamlining the test scenarios. Further, while it is true that lighting measurements can be sensitive to small changes in conditions, NHTSA’s testing has shown that measurement of headlamp illuminance using the whole vehicle, rather than a component-level test, can be accomplished in a repeatable manner.¹⁶⁹ NHTSA has identified, and the test parameters and conditions specified in the final rule control for, the major sources of test-related variability, including vehicle pitch. This final rule also includes a data filter, which will smooth out the measured illuminance data, in addition to the proposed allowance for momentary glare exceedances, which should address any otherwise uncontrolled ambient illumination, among other things.

NHTSA conducted a series of tests to determine the level of variability in the track test finalized today, as well as the SAE J3069 test method.¹⁷⁰ To do this, NHTSA analyzed data from testing using the original-equipment lower beams on a FMVSS-certified 2016 Volvo XC90. Multiple runs of each test scenario were conducted to permit different types of repeatability analyses,

including: Same night (gauge); different night (test procedure); and different headlamp aiming technician (reproducibility). Data from these test trials were analyzed for each measurement distance sub-range (interval), calculating the mean, standard deviation, 95% confidence interval, and 95% prediction interval.¹⁷¹ Sample results of Test Number 1 (straight—oncoming) for the sub-range of 120 m to 220 m are shown below in Tables 8 through 10. (Throughout this section, “Test Number” refers to the scenario test numbers as reported in the repeatability report. Please see Table 1 (NHTSA Test Matrix) in that report. The test scenarios in the repeatability report are the same as the test scenarios specified in Table XXII of this final rule, but the numbering of the test scenarios differs.) Data similar to this (*i.e.*, 10 test repetitions, 10 separate test days, and 3 headlamp aiming technicians) were collected for every final rule scenario. Testing with the lower beam headlamps activated (the test vehicle was not ADB-equipped) allowed the agency to isolate variability to factors related to the test and to be certain that ADB performance itself did not contribute to variability. Oncoming and same direction data were collected during the same run, using receptor heads (*i.e.*, light sensors) placed in the appropriate positions.

TABLE 8—NHTSA TEST NO. 1, 220 M–120 M, GAUGE (MEASUREMENT SYSTEM) REPEATABILITY

Descriptive statistic	Repetition (all in one night)	Car eye point (lux)	Cycle eye point (lux)	Truck eye point (lux)	Difference between pitch maximum (sub-range) and pitch average (entire measurement distance) (degrees)
	1	0.0688	0.0751	0.0652	0.0900
	2	0.0666	0.0802	0.0602	0.1600
	3	0.0751	0.0724	0.0618	0.1400
	4	0.0665	0.0764	0.0560	0.1000
	5	0.0686	0.0675	0.0561	0.1100
	6	0.0711	0.0722	0.0599	0.1000
	7	0.0709	0.0730	0.0542	0.1100
	8	0.0830	0.0763	0.0590	0.1000
	9	0.0693	0.0822	0.0574	0.0900
	10	0.0736	0.0822	0.0625	0.1400
Mean		0.0714	0.0758	0.0592
StdDev (S)		0.0049	0.0048	0.0034
Min		0.0665	0.0675	0.0542
Max		0.0830	0.0822	0.0652
95% C.I. Margin of Error (+/-)		0.0035	0.0034	0.0024
95% C.I. Upper Limit		0.0749	0.0791	0.0617
95% C.I. Lower Limit		0.0678	0.0724	0.0568
95% Prediction Interval Margin of Error (+/-)		0.0117	0.0113	0.0080

¹⁶⁹ 2105 ADB Test Report, p. 172.

¹⁷⁰ See Mazzae, E.N., Baldwin, G.H.S., Satterfield, K., & Browning, D.A. 2021. Adaptive Driving Beam Headlamps Test Repeatability Assessment. Washington, DC: National Highway Traffic Safety Administration. The discussion here is a summary

of that report, which has been placed in the docket for this rulemaking.

¹⁷¹ NHTSA has used similar analyses before to assess the reliability and repeatability of test methods developed for FMVSS. As an example, refer to the test report “Repeatability,

Reproducibility, and Sameness of Quiet Vehicle Test Data” supporting the development of FMVSS No. 141, Minimum sound level for hybrid and electric vehicles. See Docket number NHTSA–2016–0125–0006 at www.regulations.gov.

TABLE 8—NHTSA TEST NO. 1, 220 M–120 M, GAUGE (MEASUREMENT SYSTEM) REPEATABILITY—Continued

Descriptive statistic	Repetition (all in one night)	Car eye point (lux)	Cycle eye point (lux)	Truck eye point (lux)	Difference between pitch maximum (sub-range) and pitch average (entire measurement distance) (degrees)
95% P.I. Upper Limit		0.0831	0.0870	0.0673	
95% P.I. Lower Limit		0.0596	0.0645	0.0512	

TABLE 9—NHTSA TEST NO. 1, 220 M–120 M, TEST PROCEDURE REPEATABILITY

Descriptive statistic	Repetition (one per night)	Car eye point (lux)	Cycle eye point (lux)	Truck eye point (lux)	Difference between pitch maximum (sub-range) and pitch average (entire test number range) (degrees)
	1	0.0839	0.0905	0.0774	0.1048
	2	0.0847	0.0805	0.0564	0.1072
	3	0.0796	0.0857	0.0662	0.1030
	4	0.0713	0.0772	0.0522	0.1313
	5	0.0745	0.0865	0.0634	0.1061
	6	0.0777	0.0865	0.0614	0.1260
	7	0.0717	0.0745	0.0554	0.1226
	8	0.0794	0.0718	0.0559	0.1271
	9	0.0817	0.0884	0.0679	0.1210
	10	0.0815	0.0686	0.0581	0.0990
Mean		0.0786	0.0810	0.0614	
StdDev (S)		0.0048	0.0076	0.0076	
Min		0.0713	0.0686	0.0522	
Max		0.0847	0.0905	0.0774	
95% C.I. Margin of Error (+/-)		0.0034	0.0055	0.0054	
95% C.I. Upper Limit		0.0820	0.0865	0.0668	
95% C.I. Lower Limit		0.0752	0.0755	0.0560	
95% Prediction Interval Margin of Error (+/-)		0.0113	0.0181	0.0179	
95% P.I. Upper Limit		0.0899	0.0991	0.0794	
95% P.I. Lower Limit		0.0673	0.0629	0.0435	

TABLE 10—NHTSA TEST NO. 1, 220 M–120 M, REPRODUCIBILITY

Descriptive statistic	Aimer	Repetition	Car eye point (lux)	Cycle eye point (lux)	Truck eye point (lux)	Difference between pitch maximum (sub-range) and pitch average (entire test number range) (degrees)
	A	1	0.0545	0.0599	0.0578	0.1323
	B	1	0.0673	0.0672	0.0581	0.1522
	B	2	0.0658	0.0662	0.0556	0.0977
	C	1	0.0632	0.0631	0.0545	0.0983
	C	2	0.0676	0.0663	0.0540	0.1549
Mean			0.0637	0.0645	0.0560	
StdDev (S)			0.0054	0.0030	0.0019	

The standard deviation is a measurement of the variation within the data set. The 95th percentile confidence

interval is the estimate of the upper and lower illuminance values in which there is a 95% probability that the true mean

falls within this interval. The confidence interval is calculated using the equation

$$CI_{95\%} = \bar{x} \pm t_{0.975, n-1} S \sqrt{\frac{1}{n}}$$

Where the margin of error is calculated using *t* as the upper critical value for the *t* distribution with *n*-1 degrees of freedom, *S* as the standard deviation, *n* as sample size. The

confidence interval is then calculated by summing the mean (\bar{x}) and the margin of error. The 95th percentile prediction interval is the estimate of the interval of which there is a 95% probability that

future measurements will be within. The prediction interval is calculated using the equation:

$$PI_{95\%} = \bar{x} \pm t_{0.975, n-1} S \sqrt{1 + \left(\frac{1}{n}\right)}$$

Where the margin of error is calculated using *t* as the upper critical value for the *t* distribution with *n*-1 degrees of freedom, *S* as the standard deviation, and *n* as the sample size. The prediction interval is then calculated by summing the mean (\bar{x}) and the margin of error.

Note that $CI_{95\%}$ and $PI_{95\%}$ are dependent on the number of values collected ($t_{0.975}$ is large for small sample sizes and decreases as more data are collected). That is to say, the more data collected for a distribution, the more confident we can be of where the true mean is located and where future measurement values will fall. While a standard deviation can be calculated for a very small sample size, CI and PI will be large for small samples, even if the population standard deviation is small. Taken together, the standard deviation and the prediction interval can be used

to quantify the repeatability of the test procedure. The smaller the standard deviations and the tighter the prediction interval, the smaller the range of values we will expect future values to be within, indicating a tighter precision of measurement system.

The magnitude of the prediction intervals can be used to determine how a vehicle with a similar headlighting system and beam pattern is likely to perform with respect to the glare limits. The prediction interval indicates the range within which a similar vehicle's measured illuminance value is 95% likely to fall (5% chance of not falling within the range). If the upper end value of the prediction interval is less than the glare limit for a measurement distance sub-range, then a similar vehicle's measured value is at least 95% likely to be less than the glare limit when tested by NHTSA.¹⁷² Because the repeatability

of the measurement system and test procedure produced small standard deviations, the variability of the illuminance values should not differ substantially, even if the maximum illuminance value for other headlighting systems is higher. This assumption holds true provided the headlamp beam pattern under test demonstrates similar gradients in and around the measurement locations.

Table 11 below pools the standard deviation for the oncoming straight and left curve scenarios (Test Number 1,3,4,7—each of these tests provide similar means), and the same direction straight and left curve scenarios (Test Number 2,5), and lists the standard deviation observed for the oncoming right medium curve (Test Number 6) and oncoming-right large curve (Test Number 8) for each measurement distance sub-range.

TABLE 11—TEST PROCEDURE: STANDARD DEVIATION RESULTS

NHTSA	Oncoming NHTSA test numbers 1, 3, 4, 7 (lux)	Same direction NHTSA test numbers 2, 5 (lux)	Oncoming right NHTSA test number 6 (lux)	Oncoming right NHTSA test number 8 (lux)
Measurement Distance Sub-Range:	All standard deviations were at or below:			
220 m–120 m	0.0076
150 m–120 m	0.0068
119.9 m–60 m	0.0156
100 m–60 m	0.0153
70 m–60 m	0.5996
59.9 m–30 m	0.0599	0.0494	0.5921
50 m–30 m	0.9648
29.9 m–15 m	0.0713	0.1324	0.0651	0.0602

TABLE 12—PREDICTION INTERVAL MARGIN OF ERROR VALUES OF THE TEST PROCEDURE [NHTSA Test]

Measurement distance sub-range	Glare limit (lux)	Test number 1	Test number 2	Test number 3	Test number 4	Test number 5	Test number 6	Test number 7	Test number 8
95th Percentile Prediction Interval Car Eye Point/Passenger Side Mirror (Values in lux)									
220 m–120 m	0.3	0.0113 (3.8%)	0.0128 (4.3%)
150 m–120 m	0.3	0.0145 (4.8%)
119.9 m–60 m	0.6	0.0357 (6.0%)	0.0238 (4.0%)	0.0171 (2.9%)
70 m–60 m	0.6	1.4225 (237%)*
50 m–30 m	1.8	2.2890 (127%)*
59.9 m–30 m	1.8	0.0741 (4.1%)	0.0690 (3.8%)	0.0933 (5.2%)	0.0812 (4.5%)	1.4047 (78%)*
29.9 m–15 m	3.1	0.1436 (4.6%)	0.1672 (5.4%)	0.1693 (5.5%)	0.1534 (4.9%)	0.1637 (5.3%)	0.1427 (4.6%)
100 m–60 m	4.0	0.0331 (0.8%)	0.0189 (0.5%)

¹⁷² For example, if this analysis produces a 95% prediction interval of 0.180 lux and the limit is 1.8,

a system with a true performance of 1.62 or less will have a 95% or greater probability of receiving a

passing score if the agency were to do a compliance test, using a single run.

TABLE 12—PREDICTION INTERVAL MARGIN OF ERROR VALUES OF THE TEST PROCEDURE—Continued
[NHTSA Test]

Measurement distance sub-range	Glare limit (lux)	Test number 1	Test number 2	Test number 3	Test number 4	Test number 5	Test number 6	Test number 7	Test number 8
59.9 m–30 m	18.9	0.0963 (0.5%)	0.1121 (0.6%)
29.9 m–15 m	18.9	0.2348 (1.2%)	0.3141 (1.7%)

The prediction intervals shown in Table 12 are small compared to the limits that are finalized for each measurement distance sub-range. For instance, we found that within the sub-range of 120 m to 220 m Test Number 1 resulted in a prediction interval of 0.0113 lux as compared to the limit of 0.3 lux. This interval represents 3.8% of the limit.

Both measurement system (gauge) repeatability results and full test repeatability results revealed NHTSA test scenarios involving right curves (Test Numbers 6 and 8) to be less repeatable than the other test scenarios (marked with * in the table). Unsurprisingly, these two scenarios showed a pattern of higher standard deviations with respect to the other NHTSA test scenarios. SAE Test Drive 3, in which the test fixture was located to the right of the test vehicle also showed a pattern of higher standard deviations as compared to the other scenarios. As is the case with many U.S. vehicle lower beam headlamps, the 2016 Volvo XC90 lamps produced beam patterns with a higher right-side horizontal cutoff. The variability of measurements recorded on the right side of the vehicle (right curve scenarios) is attributable to the cutoff at

the right portion of the headlamp pattern of this vehicle projecting near the location of the lower-mounted light sensors. The lower beam headlamps tested in this repeatability study exceeded the glare limits for these two-measurement distance sub-ranges as well. An ADB pattern designed to meet the requirements finalized today will need to provide a greater angular distance between the cutoff and the light sensors to meet the minimum glare requirements as described earlier in the right curve discussion. With such a design, the agency anticipates that similar repeatability will be obtained for right curves as was demonstrated for the other scenarios.

Breaking down the 8 NHTSA test scenarios by measurement distance sub-range and measurement points (light sensor locations) gives a total of 99 data points. The finalized test method found the same pass/fail results for 97 of the 99 data points in every one of the 10 test procedure repetitions. For the vehicle’s lower beam headlamps under test, 94 of those data points, without fail, were under the glare limit criteria and 3 of the data points consistently exceeded the glare limits. The vehicle consistently failed to meet the glare criteria for Test Number 6 (medium right curve) at the

car eye point for the sub-range 50 m–30 m. It also consistently failed to meet the glare criterion for Test Number 8 (Large Right Curve) at the Car Eye and Cycle Eye point for the sub-range 70 m–60 m. The 2 data points with inconsistent results (sometimes the test reported that the vehicle met the criteria and other times it reported a failure) were also found on these two right curve tests. Test Number 6 had mixed results at the cycle eye point for the sub-range 50 m–30 m and Test Number 8 had mixed results at the car eye point for the sub-range 59.9 m–30 m. As discussed above, we do not expect any mixed results for an ADB beam pattern designed to meet the track test finalized today.

NHTSA also conducted testing to examine the possibility of variability introduced by different technicians visually aiming the headlamps. This reproducibility analysis examined the effects of three different technicians performing headlamp aiming prior to running a test set. This analysis found only small differences in illuminance measurements between datasets associated with different headlamp aiming operators. The pooled standard deviations for each orientation are shown in Table 13 below.

TABLE 13—REPRODUCIBILITY: STANDARD DEVIATION RESULTS

	Oncoming NHTSA test numbers 1, 3, 4, 6, 7, 8 (lux)	Same direction NHTSA test numbers 2, 5 (lux)
Measurement Distance Sub-Range:	All standard deviations were below:	
220 m–120 m	0.0055
150 m–120 m	0.0069
119.9 m–60 m	0.0123
100 m–60 m	N/A	0.0153
70 m–60 m	0.0122
59.9 m–30 m	0.0366	0.0521
50 m–30 m	0.0355
29.9 m–15 m	0.0933	0.1264

NHTSA also assessed the repeatability of the SAE J3069 test (Table 14). We

found that the SAE test resulted in

similar variability of both measured illuminance and test outcomes.

TABLE 14—TEST PROCEDURE: STANDARD DEVIATION RESULTS

NHTSA	Oncoming NHTSA test numbers 1, 3, 4, 7 (lux)	Same direction NHTSA test numbers 2, 5 (lux)	Oncoming right NHTSA test number 6 (lux)	Oncoming right NHTSA test number 8 (lux)
Measurement Distance Sub-Range:	All standard deviations were at or below:			
220 m–120 m	0.0076
150 m–120 m	0.0068
119.9 m–60 m	0.0156
100 m–60 m	0.0153
70 m–60 m	0.5996
59.9 m–30 m	0.0599	0.0494	0.5921
50 m–30 m	0.9648
29.9 m–15 m	0.0713	0.1324	0.0651	0.0602
SAE	Oncoming SAE test drives 1, 2 (lux)	Preceding SAE test drives 10, 11, 12 (lux)	Oncoming SAE test drive 3 (lux)	Preceding SAE test drive 12 (lux)
Measurement Distance:	All standard deviations were at or below:			
155	0.0141	0.0228	0.1234	0.1436
120	0.0132	0.0231	0.1489	0.1909
60	0.0219	0.0226	0.2464	0.3020
30	0.0380	0.0341	0.0413	0.3503

D. Laboratory (Component-Level) Testing

1. Need for Laboratory Testing

The NPRM proposed that an ADB system would also be subject to the existing component-level laboratory-based upper and lower beam photometry requirements. With respect to the adaptive beam, the NPRM proposed that an area of reduced intensity meet the applicable Table XIX lower beam photometry requirements (maxima and minima), and that an area of unreduced intensity meet the applicable Table XVIII upper beam photometry requirements. The NPRM proposed that when the ADB system is producing a lower beam, that beam be subject to all the Table XIX lower beam requirements, and when producing an upper beam, the beam be subject to all the Table XVIII upper beam photometric requirements. The NPRM proposed to require that the system provide only a lower beam when the vehicle is travelling less than 25 mph (unless overridden by the driver).¹⁷³

This differed from SAE J3069 in some respects. SAE J3069 only specifies that the lower beam maxima are not exceeded within the area of reduced intensity, and that the lower beam minima be met in the area of unreduced intensity. (These provisions reference the relevant SAE photometric standards; the proposal instead appropriately

referenced the upper and lower beam photometric requirements in Tables XVIII and XIX of the standard.)

Comments

Some commenters supported the inclusion of at least some laboratory testing requirements. AAA and Intertek supported applying the existing upper beam photometric requirements to the upper beam, Consumer Reports supported requiring that the part of the adaptive beam that is cast near other vehicles not exceed the current lower beam maxima, and the part of the adaptive beam that is cast onto unoccupied roadway not exceed the current upper beam maxima. Consumer Reports also supported applying the lower beam minima to areas of reduced intensity and the upper beam minima to areas of unreduced intensity. Zoox supported applying the existing laboratory requirements to the upper and lower beams.

In contrast, both SAE and Global disagreed that photometric component testing is necessary in addition to vehicle testing. SAE explained that, when SAE J3069 was published, component level testing was included as an additional metric to aid in lamp manufacturers' process controls and also because it is a familiar compliance method. The SAE J3069 rationale accordingly explained that, if vehicle-level testing of ADB systems were to be included in FMVSS No. 108, "any need for laboratory photometric requirements may be reconsidered for removal." SAE

therefore requested that the final rule not include component testing.

Agency Response

The final rule retains the laboratory testing requirements because the full-vehicle track test alone may not be sufficient to ensure that an ADB system provides adequate visibility and does not glare other vehicles, as discussed further below. Accordingly, the final rule applies the existing laboratory testing requirements to any beam an ADB system may provide (a lower beam, an upper beam, or an adaptive driving beam). (The different types of beams classified in the final rule are discussed in Section VIII.D.2.)

The full vehicle track test and the laboratory-based component test are complementary. The full vehicle dynamic track test only evaluates glare; it does not evaluate visibility. The final requirements include laboratory testing requirements that ensure that the ADB system always provides the driver with a minimum level of visibility.

The laboratory testing requirements generally assure adequate visibility by specifying minimum levels of light at certain locations (test points) that roughly correspond to different locations on the road. As explained in Section VIII.D.2, we have modified the proposal to give manufacturers greater flexibility in determining which areas of the roadway receive an area of reduced intensity or an area of unreduced intensity. For the former, the appropriate minimum visibility is the applicable lower beam minima; for the

¹⁷³ For a general explanation of the laboratory photometry requirements, see the NPRM at p. 51770.

latter, the appropriate minimum visibility is the applicable upper beam minima. Similarly, the lower beam minima indicate the appropriate minimum visibility for the lower beam, and the upper beam minima for the upper beam.

Laboratory testing will complement the track test to minimize glare to other vehicles. The laboratory testing requirements minimize glare by specifying photometric maxima at certain test points. The track test evaluates whether an ADB system glares a test fixture in specific scenarios. While the final track test requirements encompass many common scenarios (e.g., a single oncoming vehicle in the adjacent lane), they do not test every conceivable scenario. Laboratory testing will therefore help serve as a backstop to the track test. Moreover, the track test evaluates glare out to 220 meters. Extremely bright upper beams (for example, an ECE-approved upper beam that exceeds the current FMVSS No. 108 75,000 cd upper beam maximum) could create glare further than this distance. The laboratory testing requirements will therefore also ensure that upper beams are not exceedingly bright. (Indeed, if the current upper beam maxima did not apply to the upper beam of an ADB system, upper beam maximum intensity would effectively be unregulated). Accordingly, the final rule specifies that the lower beam and an area of reduced intensity must not exceed any applicable Table XIX (lower beam) maxima, and the upper beam and areas of unreduced intensity must not exceed any applicable Table XVIII (upper beam) maxima.

2. Definitions of Areas of Reduced and Unreduced Intensity

The NPRM proposed (in S9.4.1.6.6–.7) that “when the system is producing a lower beam with an area of reduced light intensity designed to be directed towards oncoming or preceding vehicles, and an area of unreduced intensity in other directions,” the system must meet the Table XIX (lower beam) photometric requirements within the area of reduced intensity and the Table XVIII (upper beam) photometric requirements in the within the area of unreduced intensity. The proposed rule did not otherwise define the areas of reduced and unreduced intensity.

Comments

Several commenters suggested clarifications to the definitions or references to the areas of reduced and unreduced intensity. ALNA, Zoox, and Valeo commented that the definitions of the area of reduced intensity and/or area

or unreduced intensity were unclear. Mercedes suggested expanding the definition of the area of reduced intensity to include portions of the roadway other than those occupied by other vehicles because sophisticated ADB systems are capable of dimming areas of the beam pattern directed towards retroreflective signs or wet road surfaces in order to minimize glare to the driver. Stanley requested confirmation that the area of reduced intensity corresponds to the windshield area of an oncoming vehicle and the area of unreduced intensity refers to the area outside of the area of reduced intensity. Ford suggested edits to clarify the regulatory text setting out the dimmed and undimmed area requirements. It suggested that instead of referring to the lower beam, the regulatory text refer to the “adaptive driving beam,” and suggested rearranging the regulatory text. Valeo similarly commented that classifying the adaptive beam as a lower beam is misleading because it is actually a modified driving or upper beam and suggested including a definition of “adaptive driving beam.” Intertek suggested requiring that the system emit a base lower beam, which is only augmented by adding light to the portions of the beam in which a preceding or oncoming vehicle is not detected, to the limit that when there are no preceding or coming vehicles detected the emitted beam is a compliant upper beam. This would, it contended, ensure that the augmented lower beam is always compliant to the applicable lower beam photometry requirements. Zoox commented that the NPRM appeared to assume that the adaptive beam is a defined, static beam pattern that is generated based on camera recognition of oncoming or preceding traffic. It stated that the laboratory test requirements should be technology neutral with respect to the manner and method of controlling and producing an adaptive beam.

Some commenters requested that the agency establish more specific laboratory test requirements. Zoox commented that the proposed laboratory test requirements were not clear on how to determine which portion of an adaptive beam is to be checked against the lower beam or upper beam minima and maxima. For example, a system may progressively dim an LED array across the headlamp width as vehicle distance closes for oncoming traffic. The ADB pattern may also differ for oncoming versus preceding traffic. Zoox requested clarification of which test points would apply and how they would be

evaluated. SL and Intertek commented that specific test requirements need to be established because it would be impracticable to test the hundreds of possible adaptive beam patterns.

Agency Response

The final rule does not adopt the proposed regulatory text that referred to an area of reduced intensity as being “designed to be directed towards oncoming or preceding vehicles,” and to the area of unreduced intensity as being directed “in other directions.” The proposed text implied that an area of reduced intensity must be directed towards oncoming or preceding vehicles and that an area of unreduced intensity must be directed towards unoccupied portions of the roadway. The final rule defines a new beam type, an “adaptive driving beam,” and adopts the definition of this in SAE J3069 MAR2021 as “a long-range light beam for forward visibility, which automatically modifies portions of the projected light to reduce glare to traffic participants on an ongoing, dynamic basis.” It requires that areas of reduced intensity conform to the Table XIX test points, areas of unreduced intensity conform to the Table XVIII test points and allows for a 1-degree transition zone between areas of reduced and unreduced intensity.

The final rule is intended to give manufacturers the flexibility to design systems that provide an area of reduced intensity not only to prevent glare to oncoming or preceding vehicles, but also in other situations in which a dimmed beam would be beneficial (such as towards retroreflective signs). Creating a new “adaptive driving beam” classification, distinct from the existing lower and upper beam definitions, accomplished this.¹⁷⁴ The intent behind these changes is to essentially, as Intertek suggested, provide that the system emit a lower beam, which is only augmented by adding light to the portions of the beam in which a preceding or oncoming vehicle is not detected, to the limit that when there are no preceding or coming vehicles¹⁷⁵ the emitted beam is an upper beam.

¹⁷⁴ This is also related to comments that recommended not specifying the upper beam minima in the area of unreduced intensity. The final rule retains the specification of the upper beam minima in the area of unreduced intensity, but now gives manufacturers the flexibility to use an area of reduced intensity on roadway not occupied by oncoming or preceding vehicles. This is discussed in more detail in Section VIII.D.4.

¹⁷⁵ Or other situations, such as the presence of retroreflective signs, in which it would be appropriate or optimal to provide less than a full upper beam.

Manufacturers will therefore have the flexibility to design the system to produce areas of reduced intensity and areas of unreduced intensity as they see fit, subject to several requirements or constraints:

- The adaptive driving beams must consist only of area(s) of reduced intensity, area(s) of unreduced intensity, and transition zone(s).
- When the ADB system is operating in manual mode, the system must provide only an upper beam or a lower beam. This was implicit in the proposed regulatory text but is made explicit in the final rule.
- When the ADB system is operating in automatic mode, the system must provide an adaptive driving beam. The adaptive driving beam is subject to several requirements, including the following:
 - The adaptive driving beam must be designed to conform to the track test requirements.
 - For speeds below 20 mph, the system must provide only lower beams (unless manually overridden).
 - In an area of reduced intensity, the adaptive driving beam must be designed to conform to the Table XIX (lower beam) photometry requirements.
 - In an area of unreduced intensity, the adaptive driving beam must be designed to conform to the Table XVIII (upper beam) photometry requirements.
 - A 1-degree transition zone is permitted between any areas of reduced and unreduced intensity.

These requirements are discussed in more detail in the following sections (except for the track test requirements, which were discussed in Section VIII.C).

In conducting its compliance testing, NHTSA will request information from the manufacturer on how to power and control the headlamp.¹⁷⁶ The lower and upper beams will be aimed prior to testing, and the aim will remain unchanged during testing. Testing of the lower and upper beams will be the same as it is currently. To test the adaptive driving beam, NHTSA will activate the headlamp in the goniometer according to the manufacturer's instructions to produce an adaptive driving beam pattern that is consistent with an ADB pattern that would appear in the real world with areas of reduced intensity, unreduced intensity, and/or transition zone(s). The ADB pattern generated will result in light directed toward all the test points in Tables XVIII and XIX. The issue then becomes which fixed test

point falls within an area of reduced intensity, an area of unreduced intensity, or a transition zone. NHTSA will have manufacturers identify the portion(s) of the adaptive beam which are areas of reduced intensity and which are areas of unreduced intensity. The areas of reduced intensity must conform to the requirements for the test points in Table XIX, and the area of unreduced intensity must conform to the requirements for the test points in Table XVIII. Procedures for determining the transition for lower beams (similar to how the cutoff is determined, *i.e.*, a scan) can be used to determine whether the transition zone exceeds 1 degree. Appendix B provides an example of how this would work in practice.

Although NHTSA will rely on manufacturers to inform it on how to produce the beam—to some extent determining the precise contours of the beam—this will still adequately ensure both visibility and glare prevention. The adaptive driving beam may only consist of areas of reduced intensity conforming to Table XIX, areas of unreduced intensity conforming to Table XVIII, and/or transition zones between such areas. With respect to visibility, the beam must meet either the lower beam minima or the upper beam minima (other than in a transition zone). The driver will at a minimum always have the visibility provided by a traditional lower beam regardless of the size of the dimmed portion, up to and including a situation where the entire beam is an area of reduced intensity (*i.e.*, a lower beam).

This approach should also help ensure adequate glare minimization. First and most important, the system must be designed to conform to the track test requirements, which evaluate the adaptive driving beam in specific scenarios. Second, the laboratory testing requirements will ensure that any areas of reduced intensity (up to and including a pattern equivalent to a full lower beam) do not exceed the Table XIX (lower beam) maxima, and any areas of unreduced intensity (up to and including a pattern equivalent to a full upper beam), do not exceed the Table XVIII (upper beam) maxima.¹⁷⁷

These modifications should address the concerns raised by commenters about which Table XVIII or XIX test points apply to various portions of the adaptive beam. The agency agreed with many of Ford's suggested revisions to

the proposed regulatory text and is incorporating many of the suggestions into the final rule. The agency does not believe that this presents too many cases to test or for a manufacturer to certify. While it is true that an ADB system will be capable of generating many different adaptive driving beam patterns, it is reasonable to require that each beam pattern comply with the applicable test points. As with all the FMVSSs, these requirements would not require vehicle manufacturers to test every single case, or to test at all; they may certify their vehicles using other means. Manufacturers must use due care to ensure, however, that the system is designed to conform with the FMVSS requirements when tested by NHTSA when we use the test procedure specified in the FMVSS.

With respect to Zoox's comment regarding technological neutrality, the agency intends the requirements to be technology-neutral, and compatible with ADB systems that use bulbs and shutters, or LED arrays, as well as any sensing technology. The requirements do not assume that an adaptive beam is a static beam pattern. (As explained above, the ADB pattern is dynamic; the laboratory testing will evaluate snapshots of the dynamic ADB pattern while the dynamic aspects of ADB are tested using the track test). Although the areas of reduced and unreduced intensity will be subject to the longstanding lower and upper beam laboratory photometric requirements, manufacturers will still have the flexibility to design systems that provide a wide array of different beam patterns to accommodate not only other cars on the road, but also retroreflective signs among other things, and bicyclist and pedestrians.

3. Requirements for Area of Reduced Intensity

The NPRM applied the Table XIX lower beam photometric requirements, both minima and maxima, to areas of reduced intensity. This differed from SAE J3069, which specifies only the lower beam maxima in this area.

Comments

While Consumer Reports appeared to support requiring the lower beam minima in this area, and Intertek supported requiring both the lower beam maxima and minima, several commenters contended that if a laboratory test was required for the area of reduced intensity, it should specify the lower beam maxima (perhaps with some adjustments) but not the lower beam minima. (Some commenters argued that the maxima above 10

¹⁷⁶ This will include, as requested by Auto Innovators, calibration of any sensors required for ADB system performance in the laboratory prior to testing.

¹⁷⁷ We would expect manufacturers to design systems that avoid glare even in scenarios not included in the track test. A system that did not appropriately shade other vehicles, if not a non-compliance, could potentially be a safety-related defect.

degrees should not apply. This is discussed in Section VIII.D.6.)

Volkswagen, SAE, SL, GM, Koito, Mercedes, the Alliance, IIHS, AAA, Zoox, and Valeo commented that specifying the lower beam minima would limit the ability of ADB systems to reduce glare below current lower beam levels. The Alliance further commented that it would restrict hardware design, entail separate development programs for different markets, and add significant cost. IIHS commented that requiring the lower beam minima would effectively create a lower beam “cutoff” within the area of reduced intensity and mean that drivers of other vehicles below the horizontal axis of the ADB headlamps could experience excessive glare. IIHS and AAA stated that current lower beams produce high levels of glare in common situations such as cresting hills, driving on bumpy roads, or the higher headlamp mounting height of pickups and many SUVs, and that ADB systems have the ability to reduce glare below these levels if the lower beam minima are not specified.

Zoox suggested that market forces would ensure sufficient visibility because, in order to avoid customer complaints of lack of illumination, manufacturers are unlikely to provide ADB illumination below the current lower beam minima. SL commented that the NPRM disregarded the upper area of the cut-off line in this region.

Agency Response

The final rule adopts the proposed requirements for an area of reduced intensity, including that it meet the Table XIX minima. NHTSA believes requiring an area of reduced intensity to meet the lower beam minima is justified because the rule does not include any “false positive” tests, *i.e.*, tests to ensure that an ADB system does not mistakenly dim the beam in the absence of any oncoming or preceding vehicles. The sensitivity of the system is largely left to the manufacturer to design, provided it responds to the stimulus test fixtures in the track test and passes the photometry tests. If a manufacturer produces a very sensitive system that shades for things that are not actually other vehicles, a beam pattern that provides less visibility than a current lower beam would be less safe than the current standard. Requiring the lower beam minima be met in the area of reduced intensity ensures that the driver will always have a minimum amount of light providing adequate visibility.

NHTSA does recognize that it would likely be possible to revise the current lower-beam minima, as applied to ADB

systems, to allow for reductions in intensity below the currently-required limits without risking safety. However, NHTSA does not have data, and no data were supplied, that would allow it to establish the minimum size and roadway scenario for an area of reduced intensity with less light below the cutoff. Without such data, NHTSA does not have a clear basis on which to revise or remove the current lower beam minima.

As some commenters pointed out, requiring the dimmed portion of the ADB beam to meet the lower-beam minima means that an ADB system might not be able to reduce glare below current levels in some situations. This would likely occur in situations, as AAA alludes to, on undulating roadways and hills where the ADB vehicle crests a hill and there is an oncoming or preceding vehicle in front of it, in which case the lower beam minima might coincide with that vehicle. In light of the concerns noted above, NHTSA believes that accepting some level of glare in such situations—which is already present with current lower beams—is a reasonable trade-off to ensure adequate visibility for the driver. This will result in disharmonization with the ECE regulations, which permit the area of reduced intensity to project intensities below the lower beam minima. However, this is justified for the reasons given above. Specifying the lower beam minima will result in a situation that is unchanged from present, in terms of both safety, costs, and disharmonization.

NHTSA recognizes that market forces are more likely to ensure adequate visibility than mitigate glare, thereby potentially obviating the need to specify any minima. As noted in the NPRM, “a vehicle manufacturer’s incentive, absent regulation, might be to provide forward illumination at the expense of glare prevention because the benefits of forward illumination are enjoyed by the vehicle owner.” The agency believes such an argument has merit, and closely considered the matter. As more experience is gained with these systems the agency may consider modifying or eliminating this requirement. For now, however, given the importance of visibility, the agency will err on the side of caution and apply the lower beam minima to the dimmed portion of the beam.

Potential issues of glare due to headlamp mounting height on pickups and SUVs can be addressed with the on-vehicle aim of the headlamps, much as

it is currently addressed.¹⁷⁸

Manufacturers might also be able to further minimize glare if they use on-vehicle dynamic aiming. In the past, NHTSA has explained that for headlamp systems capable of dynamically re-aiming the headlamps (for example, based on the steering angle), the laboratory photometry requirements “must be met in the nominal position of the lower beam headlamp (*i.e.*, considering the location of the axis of reference to coincide with the longitudinal axis of the vehicle).”¹⁷⁹ This means, for example, that an ADB system that dynamically re-aimed the headlamps downward when cresting a hill with an oncoming vehicle (which, in line with AAA’s comments, is the prime concern motivating the request to not apply the lower beam minima) could effectively shift down the dimmed area so as not to glare the oncoming vehicle.

Although the final rule does not disregard the cut-off as suggested by SL, the final rule modified the right curve scenarios to consider the fact that the Table XIX (lower beam) photometry requirements permit greater illuminance on the right side than on the left side.

4. Requirements for Area of Unreduced Intensity

The NPRM applied the current Table XVIII upper beam photometric requirements (both the minima and the maxima) to the area of unreduced intensity. This differed from SAE J3069, which specifies the lower beam minima and does not specify any maxima.

Comments

Several commenters (GM, SL, ALNA, Koito, SAE, TSE, Auto Innovators, and Texas Instruments) asserted that NHTSA should specify the lower beam minima instead of the upper beam minima. SAE commented that SAE J3069 intentionally replaced the upper beam minima with lower beam minima to assure a performance comparable to the wider lower beam versus the narrower upper beam. SAE also stated that specifying the lower beam minima would harmonize with ADB systems already in use in other regions. Texas Instruments commented that while it might be appropriate to require mechanical shutter and low-resolution ADB systems to meet the lower beam minima, the proposal would negatively impact many of the potential safety

¹⁷⁸ See SAE J599 Lighting Inspection Code.

¹⁷⁹ Letter from NHTSA to Kiminori Hyodo, Koito Manufacturing Co., Ltd. (Feb. 10, 2006). See also 68 FR 7101 (Feb. 12, 2003) (discussing application of laboratory photometry requirements to adaptive frontal-lighting systems).

improvements enabled by high-resolution ABD systems, such as luminous intensity optimization on retroreflective street signs and differentially illuminating the face and body of a pedestrian. TSEI similarly commented that specifying the lower beam minima would provide a greater degree of design freedom, and also claimed that requiring the system to meet the upper beam minima in the area of unreduced intensity (in combination with the requirements for the area of reduced intensity) would create potentially insurmountable technical challenges because ADB systems require a transition zone between the area of reduced intensity and the area of unreduced intensity.

A few commenters (SAE, GM, and Koito) supported the proposal to specify the existing upper beam maxima in the area of unreduced intensity.¹⁸⁰ However, several commenters urged NHTSA to either not specify any maxima or, alternatively, to adopt the higher maximum allowed by the ECE. These commenters contended that adopting the higher maximum would lead to greater safety benefits than the proposed specification. Global commented that there are no safety reasons to specify the upper beam maxima in the absence of other road users. The Alliance commented that the safety benefits of ADB would be limited by not allowing ADB systems to exceed the current upper beam maxima, and recommended that, if NHTSA decides to specify a maximum, it should harmonize with the ECE maximum of 430,000 cd (215,000 per headlamp). It contended that, while glare is a concern, it is difficult to determine glare as a direct cause to crashes or fatalities, referring to past agency reports finding that evidence linking headlamp glare and crash risk is difficult to obtain, and noting that the percentage of accidents that could be at least partly related to headlamp glare is no more than 1%. Notwithstanding the many consumer complaints regarding glare noted by the agency, the Alliance stated that it was not aware of any agency action to investigate issues related to headlamp glare. On the other hand, the Alliance pointed out that in 2012, 70% of pedestrian fatalities occurred at night, and by 2016 this had increased to 75%. The Alliance also referred to the NPRM discussion that referenced a study from the Insurance Institute for Highway Safety finding that pedestrian deaths in

dark conditions increased 56% from 2009 to 2016. Volkswagen supported the Alliance's comments and cited studies it said showed headlamp intensities exceeding the current FMVSS No. 108 upper beam maximum (last updated in 1978) would significantly increase visibility and therefore safety. Mercedes also encouraged NHTSA to adopt the ECE maximum because it could increase forward visibility by 40% compared to the FMVSS No. 108 maximum.

IIHS commented that, for properly-functioning ADB systems, an upper beam maximum was either not necessary or that the higher ECE maximum should apply. IIHS stated that the proposal would prevent ADB systems from realizing their full visibility-enhancing potential. They stated that if NHTSA is concerned that there are scenarios where ADB systems may not properly detect and shadow other vehicles, it would be preferable to include these in the set of dynamic tests rather than limit ADB output to the same level as manually-controlled upper beams. AAA commented that European specifications require camera recognition and reaction at distances of 400 meters (1,312 feet), and that if ADB systems are effective at this distance, the intensity limits could be increased to the ECE maximum. It suggested that additional criteria for raising the upper beam maximum should include proven ability to quickly adapt to changes in vehicle elevation, as result from driving on undulating roadways and hills.

Agency Response

The final rule follows the NPRM and specifies the existing upper beam minima, not the lower beam minima. Because ADB systems can detect other vehicles, the areas of the beam directed where other vehicles are not present should be an upper beam. Because the track test evaluates the ability of the ADB system to appropriately recognize and shade other vehicles, requiring the upper beam minima should not result in glare to other motorists.

However, NHTSA agrees with the comments about the possible safety-enhancing effects of allowing manufacturers to shade areas of the roadway in addition to those occupied by other vehicles (e.g., retroreflective signs). The final rule therefore gives manufacturers the flexibility to design an ADB system that provides an area of reduced intensity to any area of the roadway, not just areas occupied by other vehicles (see Section VIII.D.2). This essentially gives manufacturers the flexibility to meet the lower beam minima instead of the upper beam minima for any part of the roadway it

chooses, and more closely harmonizes with SAE J3069. Because we have modified the proposal to allow manufacturers the flexibility to provide an area of reduced intensity on parts of the roadway that are not occupied by other vehicles, they will have the ability to innovate and optimize luminous intensity for objects such as retroreflective signs and other roadway users. We also believe this will, in conjunction with the transition zone allowance, address the transition zone issue (see Section VIII.D.5). With respect to SAE's comment about the preferability of a wider lower beam, nothing in the final rule prevents this wider beam pattern in an area of unreduced intensity. The lower beam pattern extends to test points at 20L and 20R, whereas the upper beam test points only extend to 12L and 12R.

The final rule follows the NPRM in specifying the existing Table XVIII upper beam maximum for the area of unreduced intensity. NHTSA has decided not to adopt the higher ECE upper beam maximum. Table XVIII specifies a maximum at H-V of 75,000 cd per headlamp, or 150,000 cd for a headlighting system. The purpose of this maximum is to control glare that would occur if the upper beam is improperly activated (*i.e.*, when other vehicles are within 500 ft)¹⁸¹ and to control glare to vehicles that are more than 500 ft away, which is the distance outside of which most States permit upper beam use.¹⁸²

While NHTSA agrees with the commenters that brighter upper beams would lead to safety benefits in the form of increased visibility in the absence of other road users, NHTSA remains concerned about potential glare from brighter upper beams in situations in which an ADB system might not recognize and shade other vehicles. The final rule includes a track test that evaluates an ADB system's ability to recognize and shade other vehicles in a

¹⁸¹ 43 FR 32416, 32417 (July 27, 1978) (final rule increasing upper beam headlamp intensity to 75,000 cd).

¹⁸² 61 FR 54981, 54982 (Oct. 23, 1996) (denial of rulemaking petition to increase the upper beam maximum intensity to 140,000 cd). *See also* NPRM, p. 51779 n.75. Table XVIII also specifies an upper beam maximum at 4D-V. This regulates foreground light that affects a driver's ability to see objects far down the road. High levels of foreground illumination tend to draw a driver's attention away from the distant road scene to the foreground because the foreground light appears brighter than the road scene further away. In addition, high foreground intensities reduce the ability to see dimly illuminated objects further down the road. *See* 62 FR 31008, 31010 (June 6, 1997) (denial of petition for reconsideration). The magnitude of this maximum is based on the H-V maximum. Because we are not adjusting the H-V maximum we do not need to consider the 4D-V maximum.

¹⁸⁰ SAE appears to suggest this approach if NHTSA does not adopt a transition zone. As we discuss in Section VIII.D.5, the final rule adopts a transition zone.

variety of scenarios. The NPRM proposed an even greater variety of scenarios that the agency could test, but many commenters argued that the proposed testing was onerous and impracticable. Pursuant to these comments, the final rule significantly streamlines the scenarios that NHTSA may test. While the final rule includes a sufficient variety of track test scenarios to reasonably ensure that an ADB system does not glare other motorists, the track test does not include—nor could NHTSA feasibly test—every scenario that an ADB system might encounter in the real world. Maintaining the current upper beam maximum as a backstop to the dynamic tests will help assure that if an ADB system fails to properly detect and dim lighting towards another vehicle (whether due to topography, sudden appearance, or any other situation that leads the ADB system to fail to recognize and shade another vehicle), the system will not produce glare beyond what a current FMVSS 108-compliant upper beam would.

If the final rule were to adopt the higher ECE maximum, an expansion of the track test scenarios might be warranted to ensure that these brighter beam patterns do not glare other motorists. There are at least two ways the agency might consider expanding the track test scenarios. First, testing the ADB system for glare beyond the 220 m proposed and included in this final rule. As explained in the NPRM, testing out to 220 m is appropriate because at this distance, the glare from an upper beam at the current implied system maximum of 150,000 cd would be 3.1 lux, which is equivalent to the glare cutoff implied by many State upper beam-use laws.¹⁸³ Adopting the ECE system maximum of 430,000 cd could justify testing out to 372 m (the distance at which 430,000 cd equals 3.1 lx.). This is consistent with AAA's suggestion that the upper beam maximum could be increased if NHTSA dynamically tested headlamp illuminance at ranges of up to 400 meters. Second, NHTSA might consider additional test scenarios related to other concerns that might be associated with brighter beam patterns. For example, as AAA suggested, expanding the track test scenarios might be appropriate to ensure that the brighter upper beam does not glare other road users, for example, by testing the ability of the system to quickly adapt to changes in vehicle elevation.

NHTSA, however, is not currently prepared to expand the track test scenarios in this way. In order to extend

the distances at which we evaluate glare in the track test, the agency would likely want to consider, among other things, the appropriate glare limits at those distances and whether the existing test procedures would need to be modified to accommodate greater testing distances (for example, the availability of test tracks with those distances).¹⁸⁴ Further research might also include the development of additional test scenarios appropriate for higher-intensity headlamps.¹⁸⁵ In short, NHTSA is not currently prepared to make any further changes to the proposal related to a brighter upper beam. The goal of this rulemaking is to extend the existing photometry requirements to enable the safe introduction of ADB systems, and to expeditiously finalize this rule to enable deployment of ADB systems.

Because NHTSA is not prepared to extend the test requirements to ensure that ADB systems with a higher maximum intensity would operate safely, increasing the photometric maximum, without also adding such additional test requirements, would result in a situation where glare past 220 m was not regulated. Some commenters stated that there is insufficient data to conclude that the disbenefits from glare at these distances outweigh the benefits from greater visibility and pointed to the increase in pedestrian fatalities. NHTSA agrees that evidence linking headlamp glare and crash risk is difficult to obtain, that there are benefits to increased visibility, and that there has been an increase in pedestrian fatalities. However, we note that NHTSA has previously declined to increase the upper beam maximum beyond 150,000 cd to the ECE maximum because of a lack of data on whether any improvements would outweigh any associated disbenefits associated with potential increases in glare.¹⁸⁶ We are

¹⁸⁴ The research on which the track test requirements are based developed those requirements and test procedures only for testing glare—commensurate with the current FMVSS No. 108-compliant upper beams—out to 220 m, not at the greater distances that would be necessary with ECE-approved upper beams.

¹⁸⁵ NHTSA's earlier research did include some testing related to ADB performance on hills. However, such scenarios were not proposed because of relatively poor ADB system performance in those trials. See 2105 ADB Test Report at p. 102.

¹⁸⁶ Most recently, in 2009 NHTSA denied a petition for rulemaking from The Groupe de Travail "Bruxelles 1952" and SAE to amend FMVSS No. 108 to, among other things, increase the upper beam maximum to 140,000 cd. 74 FR 42639 (Aug. 24, 2009). NHTSA declined to increase the maximum because of a lack of data to allay the concern that the benefits due to increased visibility might be outweighed by the disbenefits from increased glare. Similarly, when NHTSA increased the (implied) system-level upper beam maximum from 75,000 to 150,000 in 1978, it referred to contemporaneous

research on the issue, and the comments did not identify any such research. Accordingly, we have no reason to revise our previous conclusions that the current upper beam maximum appropriately balances the benefits of visibility and the disbenefits of glare. In short, NHTSA is presently unable to conclude that more than doubling the maximum permitted intensity from 75,000 cd to 215,000 cd (per headlamp) would provide a significant enough advantage to warrant risking the potential negative externalities of glare.¹⁸⁷ Nevertheless, ADB systems will still provide increased visibility outside of the area of reduced intensity, as well as increase upper beam use, which will help prevent crashes.

5. Transition Zone

The NPRM applied the Table XIX lower beam photometric requirements to areas of reduced intensity and the Table XVIII upper beam photometric requirements to areas of unreduced intensity. The NPRM did not provide for a transition zone between areas of reduced and unreduced intensity.

Comments

Many commenters (SAE, ALNA, the Alliance, Global, Valeo, Honda, SL, Stanley, Koito, Mercedes, Volkswagen, Toyota, and TSEI) pointed out that the proposed photometric requirements could not be met without allowing for a transition zone between the areas of reduced and unreduced luminous intensity. Mercedes, Volkswagen, Toyota, Auto Innovators, and TSEI specifically agreed with SAE's comments on this issue.

SAE commented that a transition zone can only be minimized, not eliminated, and because the transition between reduced and unreduced areas does not comply with either upper or lower beam photometry it must be eliminated in the photometric testing. Without a transition zone, an ADB system would

research "demonstrating that an increase in photometrics to a maximum of 150,000 cp will enhance seeing ability without any significant increase in glare from properly aimed headlights, but that photometric output exceeding 150,000 cp results in only a marginal increase in visibility with an increase in glare." 43 FR 32416 (July 27, 1978). See also 61 FR 54981 (Oct. 23, 1996) (denial of rulemaking petition to increase upper beam system-level maximum to 140,000 cd) (citing the 1978 rulemaking notice and stating that "the agency has done no similar research work on upper beam headlamps since then nor is it aware of other safety research in this area").

¹⁸⁷ While we agree with the Alliance that adopting the ECE maximum would enhance harmonization, we still believe that there is a headlamp harmonization window. See 61 FR 54981.

¹⁸³ See NPRM n. 75 and accompanying text.

be expected to modify its illumination from very low light levels to above 40,000 cd over a zero angle, which is physically impossible. SAE gave an example of an area of reduced intensity around the upper beam minimum at 1U, 3L, with the edge of the area of reduced intensity to the left of 3L, and the area of unreduced intensity at 3L. SAE pointed out that in this example, the upper beam minimum of 5,000 cd and lower beam maximum of 700 cd (at 1.5 U, 1.5 L to L) are impossible to coincidentally satisfy, even with the 0.25 degree re-aim allowance in FMVSS No. 108, because the transition from the unreduced intensity to the reduced intensity is much larger than 0.25 degrees. To illustrate this, SAE provided a horizontal scan through an ADB headlamp beam pattern showing a transition zone of greater than 1 degree for the minimum at (1U, 3L) to be met. SAE noted that similar issues will occur in other parts of the beam pattern. Toyota similarly commented that the absence of a transition zone leads to a distinctive vertical line between the area of reduced intensity and the area of unreduced intensity. It has been Toyota's experience that a sharp cutoff distracts drivers and leads to customer complaints that the sharp cutoff reduces visibility over bumps, dips, and twisty roads. Toyota also noted that ADB systems it sells in other markets include a transition zone and it has received positive consumer feedback.

There were a variety of comments related to how the agency might account for a transition zone in the final rule. SAE suggested that the transition zone be "disregarded." SAE recommended several different alternative modifications to the proposal if final rule were not to disregard the transition zone. These included specifying only the lower beam maximum values in the area of reduced intensity, and not minimum values; excluding the boundaries of 10U to 90U from the lower beam maxima requirements; specifying the lower beam minima instead of the upper beam minima in the area of unreduced intensity; and modifying the regulatory text by adding "fully" before the text describing the area of reduced intensity. SAE also recommended reorganizing the regulatory text of S9.4.1.6.6–7.¹⁸⁸ Some of SAE's suggestions were echoed by other commenters. Global suggested that the final rule should allow for a mid-beam independent of the lower or upper beam. SL suggested that the

manufacturer be permitted to set the boundary area or that the final rule should specify light intensity criteria for the transition zone.

Agency Response

NHTSA agrees with commenters that the final rule should allow for a transition zone between areas of reduced and unreduced intensity. The final rule allows for a 1-degree transition zone between an area of reduced intensity and an area of unreduced intensity, within which the Table XVIII and XIX requirements will not apply, except that the maximum at H–V in Table XVIII as specified in Table II for the specific headlamp unit and aiming method may not be exceeded at any point in a transition zone. Manufacturers essentially will be free to determine the areas of reduced and unreduced intensity and, therefore, the boundaries of the transition zone. In addition, the vehicle will still need to pass the track test.

In considering how to account for a transition zone NHTSA consulted photometric requirements specified in other technical standards and comparable foreign regulations. Because SAE J3069 does not explicitly define or identify a transition zone,¹⁸⁹ the agency researched references to aiming tolerances in other SAE-recommended practices for headlamps. J2838 Full Adaptive Forward Lighting Systems specifies aiming procedures for adaptive lighting systems. Section 6.5 includes provisions for adjusting vertical and horizontal aim, including expected aiming tolerances, and provides for a $+/- 0.5$ degree (or 1 full degree) vertical tolerance to transition between the lower beam zones and the upper beam zones. The J2838 procedures, though not specifically for a transition zone, suggest that a similar 1 degree transition between areas of reduced and unreduced intensity in an adaptive driving beam pattern would be appropriate.

This is consistent with the ECE requirements for adaptive front lighting systems. NHTSA could not find reference to a direct specification of a transition zone in either ECE R.48 or R.123. Section 6.22.6.3 of R.48 does, however, specify a $+/- 0.5$ degree tolerance for the cutoff of a lower beam.

¹⁸⁹ SAE J3069 MAR2021 added a definition for the transition zone ("The area in the ADB where the unreduced intensity transitions to the non-glare zone"). It states that the prior version assumed the existence of a transition zone and that this definition was added for clarity. The transition zone allowed in this final rule is similar in concept, but is more specific in order to provide a more objective test procedure for the purposes of compliance testing.

Similarly, Section 6.3.5 of R.123 specifies a $+/- 0.5$ degree vertical and $+/- 1$ degree horizontal tolerance for aiming of systems prior to testing to ensure photometric requirements are met for ADB systems. Annex 8 of R.123 cites the same cutoff and aiming provisions cited in SAE J2838 mentioned above.

A 1 degree transition should resolve the concerns of and be consistent with the information presented by the commenters. SAE raised the example of an adaptive driving beam pattern with an area of reduced intensity with vertical cutoffs around 3L and 6L.¹⁹⁰ As SAE pointed out, there is an upper beam minimum of 5,000 cd at 1U 3L and a lower beam maximum of 700 cd from 1U–1.5 L to L. As SAE also correctly pointed out, it would be impossible for an adaptive driving beam with an area of reduced intensity with a vertical cutoff around 3L to simultaneously satisfy both the upper beam minimum and the lower beam maximum without a transition zone. A 1 degree transition zone resolves this issue and gives the system room to gradually modify the intensity. The data presented by SAE¹⁹¹ shows that a real-world ADB system could comply with the final requirements: The upper beam minimum at 1U 3L would fall within the transition zone, and the area of reduced intensity would comply with the lower beam maximum. SAE's example also indicates that 1 degree is sufficient for a cutoff between an area of unreduced intensity and an area of reduced intensity because it shows that it takes the beam less than 1 degree to transition from intensities characteristic of an upper beam (e.g., 5,000 cd) to intensities characteristic of a lower beam (e.g., 700 cd). In addition to the transition zone, the existing provision (in S14.2.5.5) for a 0.25 degree re-aim in any direction at any test point would also apply. NHTSA believes that this specification for a transition zone, together with allowing manufacturers the flexibility to project an area of reduced intensity on areas of the roadway other than oncoming and preceding vehicles, also resolves the other concerns raised by the commenters.

6. Veiling Glare

The NPRM extended the Table XIX lower beam photometric requirements to areas of reduced intensity. These include a maximum of 125 cd in the region of 10U to 90U and 90L to 90R.

¹⁹⁰ SAE comment (NHTSA–2018–0090–0167), p. 6 (Fig. 2).

¹⁹¹ *Id.*

¹⁸⁸ SAE stated that these recommendations are also intended to address the veiling glare issue. See Section VIII.D.6, Veiling Glare.

The purpose of these test points controlling veiling glare is to limit back-scatter in environmental conditions such as fog, mist, and snow.

Comments

Some commenters opposed applying the veiling glare limits to the area of reduced intensity. ALNA commented that these maxima are not necessary because the increased safety provided by an ADB system justifies less strict self-glare (back-scatter) requirements. SAE commented that if the final rule did not include a transition zone, the area from 10U to 90 U should be excluded from photometric testing because light from areas of unreduced intensity can fall into the area of reduced intensity, exceeding the veiling glare requirement in the 10U to 90U zone. GM commented similarly.

Agency Response

The concerns the commenters expressed about the veiling glare limits are addressed by two of the modifications to the proposal. First, as explained in the preceding section, in response to the comments the final rule added a transition zone between areas of reduced and unreduced intensity. Second, the final rule modifies the proposal to give manufacturers the flexibility, in designing the adaptive beam, to illuminate portions of the roadway other than those occupied by oncoming or preceding vehicles with either an area of reduced intensity or area of unreduced intensity. An adaptive beam may therefore provide an area of unreduced intensity that covers the entirety of the 10U to 90U region, for which the Table XVIII upper beam requirements do not contain any test points. NHTSA believes that these modifications resolve the commenters' concerns about veiling glare exceedances.¹⁹²

E. Minimum Activation Speed

The NPRM proposed that an ADB system must produce a lower beam below 25 mph, explaining that since the primary purpose of ADB is to provide additional light at relatively higher speeds, it may be likely that the potential disbenefits from glare outweigh the potential benefits from additional illumination at lower speeds.

¹⁹² SAE J3069 MAR2021 excludes the boundaries of 10U to 90U and 90L to 90R from the requirement in that practice that the non-glare zone (area of reduced intensity) meet the lower beam maximum values specified in SAE J1383. The modifications to the proposal are consistent with this.

Comments

One commenter, Consumer Reports, supported requiring the lower beam as a default any time the vehicle is traveling at a speed below 25 mph in order to limit glare in circumstances where upper beams are not intended for use.

Other commenters, however, disagreed with the proposal. Toyota, Honda, and Ford stated that there should be no speed restriction on ADB activation. SAE, Koito, Valeo, Zoox, and Volkswagen asserted that ADB operation should not be restricted to 25 mph and above. Texas Instruments and Harley Davidson commented that ADB activation below 25 mph should be allowed in certain circumstances. The commenters made a variety of arguments in support of these positions.

Some commenters suggested that the benefits of allowing ADB at lower speeds outweighed any potential glare disbenefits. SAE stated that the potential disbenefits from glare would be mitigated as ADB systems become more advanced and able to recognize and respond appropriately in low speed-environments. Honda commented that there is a safety need for visibility at lower speeds and calculated that, based on 2011 to 2016 GES data for pedestrian accidents, approximately 40% of nighttime accidents occur when the vehicle speed is estimated to be under 25 mph (when the vehicle speed can be estimated). Toyota commented that there are not any data that show a safety need to regulate the activation speed.

SAE commented that there is no single driving speed where the benefits of ADB disappear to the point where automatic deactivation should be required. They stated that changes in the driving environment are not necessarily correlated with vehicle speed and it is the changes in driving environment where the driver most benefits from an adaptive driving beam. (Honda had a similar comment.) SAE asserted that sudden deprivation of light based only on a specific speed threshold presents potential safety risks and is contrary to the purpose of ADB. Toyota stated that there was customer demand for ADB to be operable in urban areas and in residential areas where visibility can be extremely low and the speed limit is typically 25 mph, and believed it can provide safety benefits, especially because there is a higher probability for drivers to interact with pedestrians or cyclists in these areas. Honda commented that ADB should provide active forward illumination under

certain environmental lighting conditions to address safety needs.

Valeo, Toyota, and Ford suggested that there should be no speed limitation because FMVSS No. 108 contains no such speed restriction for semiautomatic beam switching devices. SAE, Valeo, and Ford similarly stated that FMVSS No. 108 does not contain a speed threshold for manual switching between lower and upper beams. SAE commented that a deactivation threshold speed of 25 mph may also encourage drivers to exceed this speed where it is the posted limit or when road conditions warrant lower speeds in order to maintain activation of the adaptive driving beam. SAE also commented that if drivers want to override ADB operation they can do so manually.

Zoox recommended that the agency consider reducing the minimum speed to 20 mph so ADB use would be available for lower-speed city use, especially to see pedestrians and cyclists on the roadway shoulder. Texas Instruments commented that high-resolution ADB systems can change this perceived disbenefit/benefit relationship, and that NHTSA should exempt high-resolution systems to allow innovative uses of hazard marking applications in urban settings.

Harley Davidson commented that activation of the adaptive beam below 25 mph should be allowed on motorcycles because they lean during cornering and use the upper beam for more than just additional light down the road. They claim that the beam pattern projected from a leaning motorcycle differs significantly from the beam pattern of a four-wheel vehicle, and that this is particularly pronounced during low-speed maneuvering where the vehicle dynamics required to maneuver through a 90-degree intersection often results in a more severe lean of the vehicle than required during higher speed turns with a larger turn radius. They claimed that when traffic conditions allow, motorcycle riders use the upper beam during these low-speed maneuvers to take advantage of the enhanced illumination in the direction the rider is looking. Harley Davidson further contended that motorcycle cornering lighting systems have been developed to enhance the lower beam illumination during vehicle leaning, and that ADB systems are potentially an enhancement to current systems, which are can operate at all speeds.

Agency Response

After considering the comments, NHTSA has decided to retain a minimum activation speed, but has

lowered it to 20 mph to give greater flexibility to manufacturers wishing to provide a hysteresis in the system design. (Hysteresis is the difference in the activation or deactivation speed of the system based on whether the vehicle is increasing or decreasing speed.)

NHTSA believes that lower beams generally provide adequate visibility at speeds below 25 mph, given typical driver reaction time and vehicle stopping distances. This is consistent with the information that Toyota provided in its petition for rulemaking, which indicated that lower beams provide sufficient illumination up to about 30 mph (or about 160 ft).¹⁹³ This is also consistent with many of the ADB systems NHTSA tested, which had activation speeds between 20 mph and 40 mph and deactivation speeds from 15 mph to 25 mph.¹⁹⁴ A more recent model NHTSA tested (a MY 2018 Lexus NX built for the European market) had three ADB modes, and the lowest activation speed was 9 mph (with a deactivation speed of 7.5 mph).

A 20 mph activation speed is also supported by research on glare and driving performance. In 2008 NHTSA published a summary of this research and found that in areas with high ambient light levels such as city downtown areas, lower-beam headlamps provide sufficient visibility because driving speeds are lower in urban areas (*i.e.*, under 30–40 mph) and because ambient light levels (from street lighting or other sources) are usually higher; the study also noted that lower beam intensities might even be able to be reduced in these areas to reduce glare to other drivers without strongly affecting forward visibility.¹⁹⁵ This is also consistent with NHTSA's data on nighttime crashes involving pedestrians and cyclists.

Even if increased illumination at speeds under 20 mph were to result in incremental benefits,¹⁹⁶ omitting a minimum activation speed could require expanding the dynamic track test scenarios to evaluate ADB performance in the types of

environments (*e.g.*, urban) and situations (*e.g.*, intersections) associated with these lower speeds. This is particularly important because the early ADB systems tested were not able to pass low-speed scenarios such as intersection scenarios.¹⁹⁷ While it is likely true that the capabilities of ADB systems have advanced since then—including but not limited to the development of high-resolution systems—that does not obviate the need for testing. However, the agency has not yet proposed or fully developed the appropriate test scenarios to evaluate ADB performance in these types of environments and speeds. To do so, NHTSA would have to consider a number of factors, such as the relevant scenarios for testing. Because such test scenarios have yet to be developed, the agency is currently unable to test whether ADB systems would create glare in those situations. Development of such test scenarios would take additional time and resources. In the interests of facilitating ADB deployment—especially in situations (*i.e.*, at speeds over 20 mph) at which it will provide the most benefit—NHTSA believes it is expedient to finalize a rule with a minimum activation speed instead of developing such additional test scenarios.

Because NHTSA is not extending the testing scenarios to include typical low speed/urban environment scenarios, allowing ADB activation at these lower speeds would allow glare in these situations to be essentially unregulated. A few commenters suggested that the likely benefits from enhanced visibility in these situations outweighed the potential disbenefits from glare, or that ADB systems would be able to mitigate any potential disbenefits from glare at lower speeds. However, in light of the studies indicating that lower beams generally provide adequate visibility at speeds under 25 mph and NHTSA's testing showing that ADB systems may not yet reliably adapt to lower-speed scenarios, the agency is not yet confident that any possible incremental benefits to increased illumination (above present lower beam levels) below 20 mph would be likely to offset the possible disbenefits due to glare.¹⁹⁸

¹⁹⁷ See 2015 ADB Test Report, p. 172 (“All of the ADB systems produced considerably more glare in intersection scenarios than was seen with lower beam mode.”).

¹⁹⁸ While there are no speed limitations in the current requirements for semiautomatic beam switching devices (which date to the 1960s), we believe that a minimum speed is justified for ADB systems for the reasons given above. Such a requirement may or may not also be appropriate for conventional semiautomatic beam switching devices, but such a requirement is out of the scope

If a driver desires additional illumination at speeds under 20 mph, the driver can manually switch to the upper beam mode. This balances the concerns of glare and visibility better than (as suggested in the comments) allowing activation of the adaptive beam below 20 mph and relying on the driver to manually override the ADB and activate the lower beam if that would be more appropriate (and the ADB system does not automatically switch). This is both because such situations will be relatively infrequent and because glare is a negative externality¹⁹⁹—that is, the driver has more incentive to switch to upper beam mode to obtain more visibility in the relatively rare situations in which it is needed at lower speeds than to override the adaptive beam and switch to lower beam mode to avoid glaring others. Commenters did not provide data supporting their contention that specifying a minimum activation speed will encourage drivers to exceed the minimum activation speed in order to maintain ADB operation; drivers that recognize they lack adequate visibility can switch to upper beam mode. The agency expects this to be more likely than a driver increasing speed when they feel that the headlamps are not providing enough visibility.

NHTSA has decided not to allow a lower activation speed for motorcycles. Riders are provided a manual switch that activates the upper beam in situations where the rider recognizes the need for additional lighting. As such, the factors to consider for motorcycles are the same as those for other motor vehicles discussed above.

F. Operator Controls, Indicators, Malfunction Detection, and Operating Instructions

The NPRM included a variety of system requirements for ADB systems that were either extensions of existing requirements for semiautomatic beam switching devices or new requirements that would apply only to ADB systems. These included requirements for controls, telltales, and malfunction detection. Manufacturers would be free to devise supplemental telltales as long

of this rulemaking, which is focused on ADB systems. However, we also note that ADB systems differ from conventional semiautomatic beam switching devices because ADB systems provide more illumination than a lower beam. We similarly note that the fact that there are no current speed limitations on manual upper beam use is not relevant, because ADB is automatic, not manual.

¹⁹⁹ A negative externality occurs when one party's actions impose uncompensated costs on another party. Glare is a negative externality because motorists exposed to glare are uncompensated for the disability or discomfort they experience.

¹⁹³ Toyota rulemaking petition, Appendix C. Consumer Reports, in its comment, estimated a longer lower beam seeing distance (300 ft) but still supported the proposed minimum activation speed.

¹⁹⁴ 2015 ADB Test Report, p. 91.

¹⁹⁵ DOT HS 811 043 (2008) at I–9 (citing and discussing research).

¹⁹⁶ See *id.*, p. I–9 (“Modifications to low beam patterns have been suggested and demonstrated to provide incremental benefits in terms of visibility, but light levels comparable to those from typical high beam headlamps appear to be desirable in terms of forward lighting, particularly for faster driving speeds. Yet these same light levels would almost certainly be undesirable by drivers facing them in nighttime driving situations.”).

as they did not impair the required elements.

The NPRM proposed extending existing semiautomatic beam switching device requirements for manual override, fail-safe operation,²⁰⁰ and an automatic referred dimming indicator to apply both to conventional semiautomatic beam switching devices (classified in the proposed regulatory text as “Option 1” systems) and adaptive driving beam systems (to as “Option 2” systems). With respect to the manual override requirements, the proposal extended the current requirement that a semiautomatic beam switching device include a convenient means for the driver to switch beams. With respect to the automatic dimming indicator requirement, the proposal followed the approach taken in SAE J3069.²⁰¹ The NPRM proposed requiring a telltale informing the driver when the ADB system is activated.²⁰² The agency tentatively decided against following the approach of ECE Regulation 48, which requires the upper beam telltale be used to indicate ADB activation, because the NPRM did not classify the adaptive driving beam as an upper beam. The NPRM also did not propose requiring a telltale indicating an enabled ADB system is projecting an adaptive driving beam because providing the driver with a visual indication of the type of beam an ADB system is providing is not necessary for safe driving and could distract the driver. For similar reasons, the NPRM also proposed revising the existing upper beam indicator requirement in S9.5 to state that the upper beam indicator need not activate when the ADB system is activated.

NHTSA also proposed adopting additional requirements with no analogs in the current semiautomatic beam switching device requirements. The NPRM proposed that the ADB system must be capable of detecting system malfunctions (including but not limited to sensor obstruction); notify the driver of a fault or malfunction; and disable the system until the fault is corrected. Most of these are also specified in SAE J3069.

NHTSA also identified and sought comment on a requirement in Table I–a that might affect design choices for the

headlamp and/or ADB controls. This requirement states the “wiring harness or connector assembly of each headlighting system must be designed so that only those light sources intended for meeting lower beam photometrics are energized when the beam selector switch is in the lower beam position, and that only those light sources intended for meeting upper beam photometrics are energized when the beam selector switch is in the upper beam position, except for certain systems listed in Table II.” This could mean that the headlamp and ADB controls could not be designed so the ADB system is activated when the beam selector switch is in the lower beam position, because the adaptive driving beam might utilize upper beam light sources, which would violate Table I-a because upper beam light sources would be activated when the beam selector switch is in the lower beam position.

Comments

NHTSA received several comments on the manual override requirements. The United Drive-In Theatre Owners Association and a number of drive-in theatre owner/operators asked that ADB systems be required to provide manual deactivation. Many of these commenters expressed concern that ADB systems could interfere with the enjoyment of drive-in movies. Consumer Reports also recommended applying the manual override requirement to ADB systems. One commenter (Victor Hunt) suggested requiring a warning to the driver when the ADB system has been manually overridden. Ford and Zoox suggested modifying the manual override regulatory text. Both commenters noted that under the current standard, when only lower beams and upper beams are provided, switching to “the opposite beam” is clear since there are only two options. However, when ADB is additionally provided it becomes less clear, because ADB essentially introduces a third beam. To address this, Ford recommended deleting the reference to the “opposite” beam in S9.4.1.2. Zoox recommended that this requirement apply only to systems certified to S9.4.1.5. The proposed fail-safe requirements (which mirrored the current regulatory text) required simply that a failure of the automatic control portion of the device must not result in the loss of manual operation of both upper and lower beams. Consumer Reports supported applying the existing requirements to ADB systems. Global and Subaru recommended that the system should fail-safe to the upper beam mode, while Zoox suggested

requiring the system to default to a lower beam until the fault is corrected.

Global and AAA commented on the wiring harness requirement. Global stated that this might adversely affect design choices because it could mean that the ADB system may not be activated when the beam selector switch is in the lower beam position. To address this, Global recommended adding an exception for ADB systems to Table I–a. Global alternatively recommended that there could be three operational modes that a driver could choose: Lower beam, upper beam, and adaptive driving beam. AAA recommended amending Table I–a to account for distributed control modules and recommended amending the regulatory text so that the current language applies to distinct light sources, which by design operate independently, and adding additional language that the requirement is not applicable to headlamp beam systems that are controlled at the headlamp component level.

Ford supported not requiring the upper beam indicator to be activated when the ADB system is activated because Ford believed it would be distracting for driver, is unnecessary because ADB is designed not to glare, and harmonizes with SAE and Canada. Consumer Reports agreed with extending the existing automatic dimming indicator requirements to ADB systems and agreed that an indicator for the type of beam ADB is providing or the upper beam indicator should not be required. AAA also supported the proposed requirements for telltale indicators and supported the focus on reducing driver distraction and encouraged that additional indicators be designed so as not to contribute to driver distraction.

Consumer Reports agreed with the additional operational requirements in FMVSS No. 108 for ADB systems to detect system malfunctions (including sensor obstruction), notify the driver of a fault or malfunction, and automatically disable the system until any detected fault is corrected. Subaru recommended that S9.4.1.6.2 be amended to clarify that the ADB disablement requirement is only applicable for non-mechanical failures because, if a mechanical portion of the ADB system fails, the fault will not be able to be corrected because the mechanism will be unable to function mechanically.

Zoox suggested edits to the regulatory text, commenting that S9.4.1.3, S9.4.1.6.1 and S9.4.1.6.2 are very similar and may be duplicative. It recommended that a system certified to

²⁰⁰ The regulatory text in FMVSS No. 108 has long used the unhyphenated “fail safe.” To maintain continuity, this final rule maintains that spelling in the regulatory text.

²⁰¹ SAE J3069 S6.8 and discussion at p. 2.

²⁰² We note that the automatic dimming indicator (indicating that the semiautomatic beam switching device is controlling the headlamps automatically) is different than the upper beam indicator (indicating that the upper beams are activated).

S9.4.1.5 must meet S9.4.1.3 for fail-safe operation, while a system certified to S9.4.1.6 must meet S9.4.1.6.1 and .2 for fail-safe operation. Further, instead of using “shall work in manual mode” in S9.4.1.6.2, Zoox suggested the following alternatives to accommodate both human and AI drivers: “if a manual mode is provided, the lighting system shall work in manual mode. . .” or “the lighting system shall permit control of the beam(s) by the driver until the fault is corrected.”

Brent Peterson commented that upper beam light often creates detrimental back scatter under certain weather conditions (e.g., fog or rain) and that the driver may not know how to respond.

Agency Response

NHTSA agrees that a manual override is necessary and, as proposed, is extending the manual override requirements to ADB systems.

The final rule does not require a specific warning when the driver chooses to switch the beam from the one provided by the ADB system. Because switching from the beam provided is an action initiated by the driver, a warning seems unnecessary because the driver would presumably know the action was initialized and the required automatic dimming indicator would indicate that the ADB system is no longer active. The final rule does not prohibit such a warning, provided the warning does not interfere with the functionality of the upper beam indicator.

NHTSA agrees with Ford and Zoox’s suggested changes to the manual override requirements. The regulatory text incorporates Ford’s recommended language (“The device must include a means convenient to the driver for switching the beam from the one provided.”) The agency believes this language provides sufficient flexibility for switch design while ensuring that the driver is provided control over beam switching for situations where the ADB system does not provide what the driver needs for visibility and glare prevention. NHTSA is also similarly amending the definition of “semiautomatic beam switching device” to reflect the fact that the final rule adopts “adaptive driving beam” as a third type of beam, and have amended that definition to clarify that when a semiautomatic beam switching device—whether or not an ADB system (i.e., certified to either Option 1 or Option 2)—is in manual mode, the driver may obtain either the lower beam or upper beam.²⁰³

²⁰³ The term “manual” in this definition, as well as in S9.4.1.2 and S9.4.1.3, has a general meaning that encompasses both hand-operated and foot-

The final rule does not adopt the commenters’ suggested changes to the fail-safe requirements but gives the manufacturer the flexibility to determine whether the ADB system defaults to the lower or upper beam in the event of an ADB system failure. Requiring an ADB system to default to an upper beam would not ensure that other roadway users are not glared; if, however, the ADB system were required to default to the lower beam, visibility could be diminished. Because the appropriate beam depends on a variety of situation-specific factors (e.g., presence of other roadway users, the speed of the ADB vehicle, overall visibility)—reflected in the conflicting comments on what the appropriate fail-safe should be—NHTSA is giving manufacturers the flexibility to determine the appropriate system response.

NHTSA has adopted Global’s suggestion and added to Table I—a an exception for ADB systems. The simultaneous activation of a full lower beam and a full upper beam will continue to be prohibited for ADB systems²⁰⁴ (except momentarily in certain situations and except for certain systems listed in Table II²⁰⁵). The final rule does not adopt AAA’s suggestion to account for distributed control modules because the current language is sufficiently clear to apply to both traditional wiring as well as serial communication between the vehicle and the headlamps. For example, with respect to powering the headlamp, S14.2.5.4 specifies that headlamps are tested at 12.8 V–DC as measured at the terminals of the lamp. This provision applies whether the terminals of the lamp are also the terminals of the light sources or the headlamp distributes this power to the appropriate light sources (whether integral beam headlamp sources or replaceable light sources). In essence, the wiring harness or connector

operated controls. See S9.4 (“Each vehicle must have a means of switching between lower and upper beams designed and located so that it may be operated conveniently by a simple movement of the driver’s hand or foot.”).

²⁰⁴ For an ADB system in manual mode, for which the only beams permitted are lower and upper beams, simultaneous activation of lower and upper beams (subject to some limited exceptions) is prohibited by the current language in S9.4, which requires that “except as provided by S6.1.5.2, the lower and upper beams must not be energized simultaneously except momentarily for temporary signaling purposes or during switching between beams.” However, to make this clear, we have added a cross-reference to S9.4 in S4 in the ADB requirements. For an ADB system in automatic mode, we have also clarified that the system may only switch between lower, upper, and adaptive driving beams and may not simultaneously activate any of those beams.

²⁰⁵ See S6.1.5.2, S9.4, Table I–a, and Table II.

assembly requirements listed in Table I–a and Table I–c are the same whether they apply to the basic vehicle wiring harness, or to the internal wiring within the headlamp as instructed by the ADB system through a serial line.

The final rule adopts the proposed telltale and malfunction provisions. With respect to the telltale requirements, we have clarified the proposal by requiring that the driver be provided with a visible warning that an ADB system malfunction exists. With respect to the malfunction provisions, the final rule does not adopt Subaru’s suggested changes to the malfunction requirements. If the ADB system is not able to operate safely in automatic mode due to a malfunction, the automatic mode should be deactivated, regardless of whether the malfunction is mechanical. We have modified the proposed regulatory text to make clear that the system is not required to be deactivated if the malfunction does not prevent the system from operating in automatic mode safely and in conformance with the requirements applicable to such systems. The proposal would have required that, in the event of a malfunction, the ADB system must be “disabled.” However, in order to be less design restrictive, the final regulatory text simply requires that the headlighting system must operate in manual mode in the event of such a malfunction.

In response to Zoox’s comment regarding editorial changes to S9.4.1.3, S9.4.1.6.1, and S9.4.1.6.2, the agency does not believe these provisions are duplicative. The longstanding requirements for semiautomatic beam switching devices at S9.4.1.3 requires that a failure of the automatic control portion of the device must not result in the loss of manual operation and control of both upper and lower beams; neither S9.4.1.6.1 nor S9.4.1.6.2 clearly requires this. The final rule also does not adopt Zoox’s suggested edits regarding fully autonomous vehicles. The appropriate fail-safe requirements in the event that a fully automatic (with no manual controls) ADB system fails raises a variety of issues that are outside the scope of this rulemaking.

NHTSA agrees that upper beams may cause backscatter under certain weather conditions but does not believe this merits regulatory requirements for dealing with backscatter. The agency encourages manufacturers to provide, as part of the required operating instructions, information or instructions to the vehicle operator explaining the conditions in which an upper beam or an adaptive beam may or may not be optimal or appropriate.

G. Accommodation of Different Technologies

In the NPRM, we explained that our intent was to ensure that ADB systems operate robustly, while not unduly restricting manufacturer design flexibility.

Comments

NHTSA received a variety of comments regarding the appropriateness of the requirements for high-resolution ADB systems. Infineon commented that the final rule must allow for innovation (e.g., high-resolution systems). Texas Instruments also highlighted the existence of high-resolution pixelated ADB systems that make it possible to design more flexible and precise beam patterns. It commented that the final rule should exempt high-resolution ADB systems from the requirement that the upper beam minima be met in areas of unreduced intensity and suggested allowing variable light levels between the lower beam minima and the upper beam maxima. It also asserted that the final rule should exempt high-resolution systems from the 25-mph minimum activation speed requirement to avoid blocking innovative uses of high-resolution lighting in urban settings. Texas Instruments also commented that the proposal did not consider advanced functions other than ADB (such as symbol generation) and requested that NHTSA consider including guidance in the regulations on how such systems could be deployed, possibly by considering them supplemental lighting. Volkswagen requested that NHTSA reconsider its past interpretation of the lower beam headlamp requirements as applied to LEDs (namely, that an integral beam headlamp that uses multiple LEDs would be compliant as long as the LEDs were designed to operate or fail as though they are wired in series) to accommodate high-definition ADB systems.

Zoox commented that the final rule should permit highly-automated vehicles, those without manual controls for human drivers, to certify to the ADB requirements. Zoox also suggested deleting or modifying (by replacing “must” with “may”) the operating instructions requirement in S9.4.1.1 to accommodate highly automated vehicles.

Honda stated that manufacturers may employ multiple methods to produce an ADB beam, such as an enhanced lower beam, an enhanced upper beam, or a separate mid beam (essentially a partial upper beam in addition to a lower beam). Honda requested clarification on how NHTSA would interpret such ADB

variations, and how this may impact technology innovation in this area. Honda also stated that opportunities exist to provide lighting patterns that are physically directed above lower beam levels and below higher beam levels. The goal of such a mid-beam lighting pattern would be to further balance the needs of visibility and glare prevention and expand potential ADB operation speeds and environments. They noted that since such a mid-beam would not solely be able to comply with the existing lower beam requirements, this mid beam would still require the lower beam to be activated. Honda requested clarification on how NHTSA would interpret the standard with respect to this.

Agency response

NHTSA believes the final rule is generally technology neutral, and accommodates high-resolution technologies, provided they meet the rule’s performance criteria. The agency disagrees with Texas Instruments’ comment that the final rule should exempt high-resolution systems from certain requirements because the final rule is intended to be performance-based and technology neutral.

However, as explained earlier, we have modified the proposal in response to the comments to provide more flexibility in beam design. The final rule does not limit the number or shape of areas of reduced or unreduced intensity, and permits localized dimming of the beam within the photometric limits of the region of the beam in which it is located (e.g., an area of reduced intensity may vary in intensity based on the surrounding environment provided that intensity stays within the corresponding maximum and minimum limits for the lower beam applicable to the direction of light). The final rule also provides for a transition zone. While the rule specifies the upper beam minima in the area of unreduced intensity, the definitions of the areas of reduced and unreduced intensity have been revised to give manufacturers more flexibility in beam design.²⁰⁶ The minimum activation speed has also been lowered to provide more flexibility to manufacturers.²⁰⁷

We are not revising the rule in response to the comments by Texas Instruments and Zoox regarding advanced functions such as on-road symbols and highly autonomous vehicles because those issues are

outside the scope of this rulemaking. Volkswagen’s comment regarding NHTSA’s interpretation of the requirements with respect to LED failures applies to LED headlamps generally, not just ADB systems, and is also outside the scope of this rulemaking.

With respect to Honda’s comments, the final rule has two sets of requirements for an adaptive driving beam: The laboratory requirements and the track test requirements. Any “mid-beam” patterns would be tested according to these requirements and test procedures. For example, if Honda wishes to provide greater intensities than 1,400 at the 1.5 U line as required for a lower beam, but less than the 5,000 cd that is required at the upper beam test point 1U, 3R, the requirements finalized today would prohibit this (unless if it were within a transition zone, which may not exceed 1.0 degree in either the horizontal or vertical direction). As explained previously, this assures drivers that both glare protection and visibility of an ADB lighting system will be equivalent to that of an upper and lower beam. The reduced and unreduced intensity areas only need to meet the lower and upper beam requirements, not the levels of intensity provided by actual upper and lower beams installed on the vehicle. In the example above, if that point is an area of unreduced intensity, 5,000 cd is all that is required at 1U, 3R, even though many upper beams produce more than 30,000 cd in that area. In this way, aspects of a middle beam are permitted. For instance, if the upper beam installed on the vehicle produces high levels of reflected light from a sign in the 1U, 3R region, but a shaded area meeting the lower beam requirements are more limiting than desired because, the upper beam may be reduced to as little as 5,000 cd. The agency believes this provides flexibility to customize a headlighting system to achieve the performance described by Honda.

Accordingly, the final rule does not adopt Honda’s suggested edits of the NPRM’s regulatory text. Nor does the rule adopt its suggestion that the lower beam (or area of reduced intensity) need only comply with the maximum photometric requirements of Table XIX²⁰⁸; as explained earlier in this document (Section VIII.D, Laboratory (Component-Level) Testing), the final rule retains the Table XIX requirements (both minima and maxima) for areas of

²⁰⁶ See Section VIII.D, Laboratory (Component-Level) Testing.

²⁰⁷ See Section VIII.E, Minimum Activation Speed.

²⁰⁸ Honda’s comment referred to “Table XVIII”, but since these are the upper beam requirements, and Honda’s edit concerned the lower beam, we assume Honda meant to refer to Table XIX, which contains the lower beam photometric requirements.

reduced intensity (and does not alter the lower beam requirements). However, the final rule does modify the regulatory text to clarify which photometry requirements apply to areas of reduced and unreduced intensities—for example, for an area of reduced intensity, the Table XIX test points that correspond (with respect to angular location) to that area of reduced intensity apply.

H. Requirements for Semiautomatic Beam Switching Devices Other Than ADB and Applicability of Compliance Options

The proposal retained the existing semiautomatic beam switching requirements for standard systems (*i.e.*, beam switching devices that switch only between an upper beam and a single lower beam), explaining that these requirements have been in the standard for several decades, and while they might be updated, the focus of the rulemaking was on amending the standard to allow the adoption of ADB systems. The proposal classified these requirements as compliance Option 1, and the requirements for ADB systems as compliance Option 2.

Comments

Valeo commented that ADB is essentially an advanced type of semiautomatic headlamp beam switching device and suggested that it could be certified to the existing requirements for these devices (classified under Option 1 in the proposal), without any of the proposed restrictions and vehicle level testing. Conversely, Global commented that a standard semiautomatic beam switching feature should be permitted to certify to the new ADB requirements (Option 2).

Bosch and Volkswagen requested that NHTSA update the semiautomatic beam switching device requirements for conventional automatic “hi-beam” systems (Option 1) to harmonize with SAE J656 (FEB 2010). Bosch commented that the current semiautomatic beam switching requirements (in S9.4.1 and 14.9.3.11 of the standard) are based on a 1969 SAE standard (SAE J565), and beam switching technology has evolved considerably since then. Bosch urged NHTSA to issue a supplemental notice of proposed rulemaking or a separate rulemaking proceeding to update the requirements to account for such advancements, including the use of camera-based systems and advanced light sources. Volkswagen pointed out that SAE J565 allows for a system without sensitivity adjustment, which modern camera-based systems no longer use, and modernized the luminous

intensity minimum and maximum value requirements.

Agency Response

The NPRM did not discuss, and, other than Valeo’s comment, the commenters did not raise, the issue of whether an ADB system could be certified to the first option. NHTSA agrees that an ADB system is a type of semiautomatic beam switching device, but not necessarily that ADB systems were allowed by the standard prior to today’s amendments. As explained in the NPRM, NHTSA’s understanding has been that most, if not all, ADB systems would not have complied with at least some of the requirements that apply to semiautomatic beam switching devices. Among other things, most ADB systems would not comply with the semiautomatic beam switching device requirements that existed prior to today’s rule (and are now classified as compliance Option 1) because they would not always comply with the existing photometry requirements. Accordingly, NHTSA expects that ADB systems will be certified to Option 2 and not Option 1.

The NPRM also did not address whether standard semiautomatic beam switching systems could be certified to Option 2. The proposed regulatory text (along with the preamble) implied that semiautomatic headlamp beam switching devices other than ADB systems could only be certified to Option 1 and that ADB systems could only be certified to Option 2. In light of the fact that the proposal did not squarely raise this issue, and the fact that this approach maintains the status quo with respect to conventional semiautomatic beam switching devices, the final rule retains the proposed labels for the two compliance options. The final regulatory text provides that standard semiautomatic beam switching systems may only be certified to Option 1.

As Bosch suggested in its comment, updating the Option 1 semiautomatic beam switching requirements to account for advances in technology is outside the scope of this rulemaking. NHTSA will consider this idea as a suggestion for future rulemaking.

I. Physical Test Requirements

The NPRM explained that FMVSS No. 108 sets forth a variety of performance requirements for semiautomatic beam switching devices (in S14.9.3.11), including a series of physical tests (*e.g.*, vibration requirements). The NPRM did not propose to subject the switch controlling the ADB system to any physical test requirements, explaining

that the existing physical test requirements date from the 1960s and do not appear to extend usefully to modern ADB technologies. The NPRM also did not propose any new physical test requirements, based upon a tentative belief that market forces would ensure an ADB system’s switching device will operate robustly. The proposal explained, however, that other FMVSS No. 108 headlamp requirements would apply to ADB systems, including the physical test requirements in S14.6 (*e.g.*, an abrasion test and a chemical resistance test).

Comments

Global concurred that new physical test requirements were unnecessary. Intertek agreed that ADB systems should be subject to all existing physical test requirements for current headlamps.

Agency Response

The final rule follows the proposal and does not contain any physical tests specific to ADB systems. ADB systems will be subject to the physical test requirements applicable to all headlamp systems.

J. Other Requirements

Comments

A few commenters mentioned unique challenges presented by the requirements for vertical headlamp arrangement for vehicles with high-mounted headlamps. The Alliance and Ford commented that glare increases as vehicle mounting heights increase and stated that this may result in light trucks, utility and crossover vehicles not meeting NHTSA’s glare requirements. They asserted that this fact could either exclude a significant portion of the new vehicle population from utilizing ADB technology or increase vehicle cost and complexity by necessitating additional hardware and components. To address this, they requested making the vertical beam arrangement requirement in S6.1.3.5.1 optional. Toyota similarly stated that vehicles with headlamps mounted higher than the height from which glare limits were derived (0.62 m) would have difficulty meeting the proposed glare limits and could prevent introduction of ADB on a significant number of trucks and SUVs. Toyota stated that the 0.62 m height is based on the typical height of a passenger vehicle, which is not representative of the current vehicle fleet. Toyota stated that the shift in the fleet mix from the time this limit was derived makes it difficult for OEMs to meet the requirements at nominal or zero aim for these high-volume vehicles. Toyota suggested that

the design would have to aim the lower beams downward on higher-mounted headlamps in order to meet the glare limits for ADB, thereby deteriorating the lower beam visibility provided to the driver. Toyota claimed that this would reduce the safety benefits of ADB by either sacrificing optimal lower beam performance or limiting the introduction of ADB on a significant number of vehicles.

Related to this, Subaru commented specifically on the proposed requirements for headlamp arrangement,²⁰⁹ stating that it seemed to imply that a vehicle without parking lamps might somehow be permitted by the rule. They requested that NHTSA clarify this provision and asked whether it would simply mean a vehicle must illuminate the outermost lamps when the ADB system is active.

Agency Response

With respect to the comments about vehicles with high-mounted headlamps, this issue is also present with respect to the lower beams on those vehicles. As such, those vehicles already tend to have their headlamps aimed downward, to avoid glaring oncoming or preceding vehicles. While manufacturers might feel the need to aim the headlamps somewhat lower to accommodate an adaptive driving beam, that would be likely to have the greatest impact on areas of reduced intensity, not areas of unreduced intensity (due to the characteristics of lower beam and upper beam patterns), and would not likely have an outsized impact on visibility.

Additionally, as suggested by the Alliance and Ford, manufacturers might wish to alter the vertical arrangement of the headlamps and/or light sources. However, the commenters who commented about high-mounted headlamps appeared to overlook that the proposed rule permitted (in S9.4.1.6.8) the adaptive driving beam to be provided by any combination of headlamps. In light of the comments, the final rule retains the proposed provision (now codified at S9.4.1.6.5) but modifies and clarifies the regulatory text to reflect that the adaptive driving

²⁰⁹ See S9.4.1.6.8 in the proposed regulatory text. (“When the ADB system is activated, the lower beam may be provided by any combination of headlamps or light sources, provided there is a parking lamp. If parking lamps meeting the requirements of this standard are not installed, the ADB system may be provided using any combination of headlamps but must include the outermost installed headlamps to show the overall width of the vehicle.”) The NPRM considered the adaptive driving beam to be a lower beam. As explained earlier, under the final rule the adaptive driving beam is defined as a new beam type and is accordingly not considered a lower beam.

beam is now considered a new beam type and not a lower beam as was initially proposed.

Regarding Subaru’s comment, the proposed S9.4.1.6.8 was not intended to imply that parking lamp requirements were being eliminated. The standard requires parking lamps on all passenger cars, and MPVs, trucks, and buses less than 2032 mm in overall width. Today’s final rule does not alter this requirement. On vehicles for which parking lamps are not required, the final rule requires that the adaptive driving beam may be provided using any combination of headlamps but must include the outermost installed headlamps to show the overall width of the vehicle.

The final rule amends 10.14.1, 10.15.1 and 10.16.1 to require that a headlamp system provide not more than two adaptive driving beams; this parallels the same requirement for upper beams and lower beams. The final rule does not amend 10.13.1 because ADB does not appear feasible for sealed beam systems.

K. Information Reporting

The NPRM did not propose any reporting requirements related to ADB system performance in the field.

Comment

Consumer Reports commented that NHTSA should require manufacturers to submit detailed and timely information regarding the performance of ADB systems and the consumer experience with them as they are introduced. They suggested that this information be made available in aggregate form publicly, at a minimum, and include crash reduction estimates, near-miss statistics that are reasonably related to lighting, and consumer satisfaction data, including documentation of the technology’s impact on glare experienced by other drivers.

Agency Response

NHTSA is not adopting the information collection requirement suggested by Consumer Reports. If, after ADB systems have been deployed, the agency sees a need to obtain detailed information on the performance of ADB systems, it will address the matter at that time.

L. Aftermarket Compliance

Motor vehicle manufacturers are required to certify that their vehicles comply with all applicable FMVSS, including FMVSS No. 108.²¹⁰ FMVSS No. 108 also applies to replacement

equipment (*i.e.*, equipment sold on the aftermarket to replace original equipment installed on the vehicle).²¹¹ Replacement equipment must be designed to conform to meet any applicable requirements and include all functions of the lamp it is designed to replace or be capable of replacing.²¹² Each replacement lamp designed or recommended for particular vehicle models must be designed so that it does not take the vehicle out of compliance with the standard when the device is installed on the vehicle.²¹³ A manufacturer of replacement equipment is responsible for certifying that equipment.²¹⁴

The NPRM stated that it may be the case that only the manufacturer of the original equipment and/or vehicle would be able to make a good-faith certification of ADB replacement equipment because requirements are vehicle-level, not equipment level, and sought comment on this.

Comments

TSEI requested clarification of whether the rule permits aftermarket ADB systems and stated that the benefits of ADB systems would be the same for aftermarket systems as for original equipment. Intertek supported allowing aftermarket parts, and believed that it is entirely feasible in aftermarket certification to rent or purchase the vehicle for which the ADB headlamp or switch is designed in order to conduct vehicle-level testing, and that while technical challenges could make aftermarket systems/parts cost-prohibitive, that will be driven by market demand.

Agency Response

The final rule permits certification of aftermarket ADB systems and parts. There would seem to be essentially two categories of aftermarket ADB systems. The first is an aftermarket ADB system replacing an original-equipment system; the second is an aftermarket ADB system replacing a non-ADB headlamp. In either case, the aftermarket ADB headlamp would be a “replacement” headlamp subject to FMVSS No. 108 because it would be “replacing like equipment on vehicles to which the standard applies.”²¹⁵ As such, the

²¹¹ S3.3 (the standard applies to “[l]amps, reflective devices, and associated equipment for replacement of like equipment on vehicles to which this standard applies.”).

²¹² S6.7.1.1.

²¹³ S6.7.1.2.

²¹⁴ 49 U.S.C. 30115; Letter from NHTSA to George Van Straten, Van Straten Heated Tail Light Co., Inc. (Aug. 11, 1989).

²¹⁵ S3.3.

²¹⁰ 49 U.S.C. 30115.

aftermarket manufacturer will need to certify the headlamp to FMVSS No. 108; that is, the headlamp “must be designed so that it does not take the vehicle out of compliance with the standard when the individual device is installed on the vehicle.” This would include the ADB requirements, as well as any other applicable requirements. Accordingly, an aftermarket manufacturer could certify and sell ADB headlamps, if the product complies and the manufacturer was able to make a good-faith certification.²¹⁶

As noted in the NPRM, it might be difficult as a practical matter for aftermarket manufacturers to make the necessary certification. For example, if an aftermarket supplier wanted to develop an ADB system for a vehicle not originally equipped with ADB, it would need to certify that the aftermarket ADB system was designed to conform with this final rule and that it would not otherwise take the vehicle out of compliance with any other standards. Because the final rule requires specific switching conditions, the aftermarket system may need to replace the interior lighting control systems to allow for control of the ADB system. On the other hand, the final rule significantly simplifies the test procedures the agency will use to determine compliance, which could ease the certification of aftermarket systems.

M. Exemption Petitions

In 2016, Volkswagen submitted a petition for a temporary exemption (under 49 CFR part 555) from some of the requirements of FMVSS No. 108 to sell up to 2,500 exempted vehicles equipped with ADB systems during each of the 12-month periods covered by the requested exemption. NHTSA published a notice of receipt of this petition on September 11, 2017 and provided a 30-day comment period.²¹⁷ BMW of North America, LLC (BMW) submitted a similar petition, dated October 27, 2017. On March 22, 2018, NHTSA published a notice of receipt of the BMW petition and requested additional information from both petitioners.²¹⁸ Both Volkswagen and BMW subsequently submitted additional information to the docket.

²¹⁶ See also 70 FR 65972, 65974 (Nov. 1, 2005) (Notice of Interpretation) (“To the extent the vehicle manufacturer could have certified the vehicle using the replacement lamp, instead of the lamp it actually used, we believe the replacement lamp should be viewed as being designed to conform to FMVSS No. 108.”)

²¹⁷ 82 FR 42720 (Docket No. NHTSA–2017–0018).

²¹⁸ 83 FR 12650 (Docket No. NHTSA–2017–0018).

Prior to today, NHTSA had not made a decision on either petition.

Comments

The Alliance, Volkswagen, and Auto Innovators requested NHTSA grant these petitions to facilitate gathering of usage and performance data.

Agency Response

NHTSA believes that the publication of this final rule obviates the need for the requested exemptions. NHTSA is today publishing a separate notice of decision denying the petitions (Docket No. NHTSA–2017–0018).

N. Compliance Date

This final rule is effective on the date of publication in the **Federal Register**. The Alliance requested that the final rule be effective on publication. This final rule permits the certification of vehicles equipped with ADB systems if a manufacturer chooses to equip a vehicle with such a system. NHTSA believes there is good cause to permit ADB systems meeting FMVSS No. 108 quickly as possible because the systems produce increased illumination without increasing glare, and have the potential to offer significant safety benefits in avoiding collisions with pedestrians, cyclists, and roadside objects. Good cause exists for these amendments to be made effective immediately pursuant to 49 U.S.C. 30111(d), which allows an FMVSS to become effective sooner than 180 days after publication of the standard if an earlier effective date is in the public interest.

O. Regulatory Alternatives

In developing the final rule, NHTSA considered the ECE ADB requirements and SAE J3069. As explained earlier, the ECE requirements are not sufficiently objective to be incorporated into an FMVSS. Accordingly, the main regulatory alternative NHTSA considered was SAE J3069.

The proposal deviated from SAE J3069 in several ways; the NPRM explained this in detail. In general, we explained that there were two major differences.

First, the proposed vehicle-level track test was more realistic and complex than the SAE J3069 track test. SAE J3069 specifies testing using a straight-path scenario (and simulating curves with fixture placement), and instead of using oncoming or preceding stimulus vehicles, uses stationary test fixtures positioned at specified locations adjacent to the test track. The proposed test permitted NHTSA to test using scenarios having curved paths (with various radii of curvature) using a broad

range of FMVSS-certified vehicles as oncoming or preceding vehicles.

Second, the proposal specified additional component-level photometric requirements to regulate both glare and visibility that were not included in the SAE document. We proposed to require that an area of reduced intensity be designed to conform to the Table XIX lower beam photometry requirements (both maxima and minima). This differed from SAE J3069, which only specified the lower beam maxima for the area of reduced intensity. We similarly proposed that an area of unreduced intensity conform with the Table XVIII upper beam photometric maxima and minima. SAE J3069 required only that the lower beam minima be met in this area.

NHTSA tentatively concluded that the differences between the proposal and SAE J3069 were needed to ensure the ADB systems meet the dual safety needs of glare prevention and visibility.

Comments

Many commenters asserted that NHTSA should adopt either SAE J3069 or the ECE requirements. Concerns about the proposal not harmonizing with either the SAE or ECE requirements were mainly focused on the broad acceptance of existing systems in the world market and the additional costs associated with development of systems that would comply with the proposal. No data were presented to quantify any additional development or system costs to comply with the proposed rule.

As noted at various points earlier in this document, a few commenters did support a variety of specific departures from SAE J3069. More generally, Intertek agreed that the SAE J3069 approach may not be sufficient to validate ADB performance over the full range of typical real-world situations; it supported a more rigorous track test than specified in SAE J3069, but also believed that the full set of proposed test scenarios might not be necessary.

Many commenters, however, strongly supported harmonization with SAE J3069 and/or the ECE requirements in order to align with requirements or approaches in other markets. Honda, Global, GM, SAE, CEI, Toyota, the Alliance, Mobileye, and OSRAM specifically supported SAE J3069. MEMA, Infineo, Valeo, and NAFA supported either SAE J3069 or the ECE requirements. Ford, Volkswagen, SMMT, Mobileye, OICA, NAFA, and Hella supported global harmonization generally, and Seastrunk and Montgomery supported harmonizing with the ECE requirements. Mobileye

supported making relatively minor changes to SAE J3069 (such as more realistic lamps). Commenters made a variety of arguments related to this.

A number of commenters (Global, MEMA, EMA, Intertek, CEI, Volkswagen, SAE, Mobileye, the Alliance, Hella, OSRAM, SMMT, Ford, and OICA) commented or supported the comments of others that the proposed departures from the SAE and ECE standards would lead to additional costs, both because the different requirements would require different hardware, components, and/or software and because the proposed testing was more complex. Global also commented that the lower costs would come with no diminution in performance and an increase in visibility. SAE commented that SAE J3069 was designed to harmonize with the ECE requirements in order to allow common headlamps, controllers, and sensors across markets; any aspects not harmonized could be accommodated in headlamp aim or software calibration differences to avoid hardware differences. OSRAM, SMMT, Volkswagen, Ford, MEMA, and OICA agreed with or echoed SAE’s comment. Hella commented that the NPRM will demand completely different headlamp systems and additionally different forward sensor designs compared to those already in use. This means, that additional development is needed to establish an ADB system in the US when compared to the rest of the world. EMA added that its members have been developing ADB systems based on the ECE requirements and have no experience with the proposed requirements; moreover, heavy-duty vehicles are often engaged in cross-border operation that makes harmonized requirements even more appropriate. Intertek estimated that that the proposed track testing could cost as much as two to four times more than testing to the SAE standard, which itself is around

three times costlier than current headlamp testing.

Several commenters (MEMA, the Alliance, Ford, Volkswagen, OICA, Hella, GM, SAE, CEI, and SMMT) stated that the proposal would disharmonize with Canada. MEMA noted that the Canadian regulations accept either ECE R123 or SAE J3069, and stated that the proposal was inconsistent with a Memorandum of Understanding between the U.S. and Canada regarding regulatory cooperation.²¹⁹ The Alliance commented that while there have been longstanding differences with headlighting requirements between the U.S. and Europe, differences between the U.S. and Canada have been minimal. Ford commented that harmonization makes sense given the close integration of the two markets.

Infineon, EMA, Volkswagen, the Alliance, CEI, and NAFA commented that the increased costs associated with the proposal would increase the cost to consumers, hindering ADB adoption and the accompanying safety benefits. CEI also contended that reduced consumer demand for ADB systems could also reduce manufacturer investment in lighting system research and development. NAFA highlighted the potential impact on adoption by vehicle fleets for which cost is important.

Global, Volkswagen, and the Alliance suggested that the disharmonized aspects of the proposal would not lead to safety benefits or could decrease safety benefits. For example, Volkswagen stated that, compared to the proposal, SAE J3069 would lead to ADB systems providing better visibility. Volkswagen also stated that there is no evidence that the ECE requirements are leading to excessive glare, and that it has developed numerous ADB systems for other markets and tested to the SAE standard, and has not received any complaints from customers or regulatory authorities about glare. A few

commenters (GM, Toyota, MEMA, Global, Volkswagen) also stated that J3069 would provide a more objective, practicable, and/or repeatable test procedure.

Agency Response

NHTSA agrees with the commenters that harmonization is an important goal. Moreover, the National Technology Transfer and Advancement Act directs Federal agencies to use voluntary consensus standards in lieu of government-unique standards.²²⁰ This directive, however, is not absolute. The NTTAA goes on to provide that an agency may decline to use existing consensus standards if it determines that such standards are inconsistent with applicable law or otherwise impractical.²²¹ “Impractical” includes circumstances in which the use of consensus standards would fail to serve the agency’s regulatory needs; be inconsistent with a provision of law; or be less useful than the use of another standard.²²²

In light of these requirements, as well as the requirements of 49 U.S.C. 30111, and in response to the comments, NHTSA has modified the proposal to more closely follow SAE J3069 where warranted, but to deviate from that standard where necessary. The most important of these changes were specifying stationary stimulus test fixtures instead of dynamic stimulus vehicles and substantially simplifying the number and complexity of the test scenarios. However, there are several aspects of the final rule for which NHTSA ultimately concluded that deviation from SAE J3069 is warranted because J3069 did not adequately address glare or visibility. The major differences are summarized in Table 12. The preceding sections of this document discuss in detail the ways in which the final rule follows and differs from SAE J3069, and explains why we believe these departures are justified.

TABLE 15—SUMMARY OF MAJOR DIFFERENCES BETWEEN THE FINAL RULE AND SAE J3069

Test elements	Final rule	SAE J3069
<i>Track test:</i>		
Glare limit applicability	Applies the glare limits throughout the measurement range specified for each scenario.	Applies the glare limits only at 30 m, 60 m, 120 m, and 155 m.
Fixture lighting	Specifies actual vehicle lamp.	Specifies lamp assemblies intended to simulate vehicle lamps.
Test track geometry	Specifies actual curves of various sizes	Specifies a straight path and uses fixture placement to simulate curves.

²¹⁹ The comment cited the Memorandum of Understanding Between the Treasury Board of Canada Secretariat and OIRA Regarding the Canada-United States Regulatory Cooperation Council, June 4, 2018.

²²⁰ National Technology Transfer and Advancement Act of 1995, Public Law 104–113, 12(d)(1), 110 Stat. 775 (1996).

²²¹ *Id.* at § 12(d)(3).

²²² Office of Management and Budget, Circular No. A–119, ¶ 5(c)(ii), Federal Participation in the Development and Use of Voluntary Consensus Standards and in Conformity Assessment Activities (Jan. 26, 2016).

TABLE 15—SUMMARY OF MAJOR DIFFERENCES BETWEEN THE FINAL RULE AND SAE J3069—Continued

Test elements	Final rule	SAE J3069
Compliance criteria	Specifies allowances for momentary glare and vehicle pitch fluctuations.	Allows measured illuminance to exceed an applicable glare limit if it does not exceed 125% of the lower beam illuminance under the same conditions.
Specifications related to smoothness of road surface.	Specifies vehicle pitch allowance	Recommends the test track have an International Roughness Index of less than 1.5 m/km.
<i>Laboratory Test:</i>		
Area of reduced intensity	Specifies lower beam (Table XIX) minima and maxima.	Specifies lower beam maxima.
Area of unreduced intensity	Specifies upper beam (Table XVIII) minima and maxima.	Specifies lower beam minima.
<i>Physical tests</i>	Not specified	Specifies various physical tests.
Minimum activation speed	20 mph	Not specified.

NHTSA recognizes that the final rule is more demanding than SAE J3069 in several respects, and further recognizes that this will result in some additional costs to develop and test these systems. The agency believes these additional costs are justified because the departures from the SAE test methods are warranted to properly address either glare or visibility concerns. NHTSA is not persuaded that the test procedures represent a significant cost burden over testing ADB systems per the SAE J3069 test. Much of the development work the industry has conducted on ADB systems for use in markets that permit certification to the UNECE or SAE standards would directly apply to the performance tests finalized today. As explained throughout this document, NHTSA has adopted parameters similar to either the SAE standard or the UNECE standard where appropriate.

For these same reasons, the agency believes that the resulting disharmonization will not hinder ADB deployment. Similarly, NHTSA concludes that the disharmonization with Canada is justified, and is not inconsistent with the Memorandum of Understanding, which provides, among other things, that the countries' respective regulations continue to apply, and that closer alignment of regulations would be consistent with their respective national laws and policies.

NHTSA also concludes the final rule is practicable. As explained in previous sections in the preamble, ADB systems performed the same on many of the final rule scenarios and the most closely analogous SAE scenarios. As also explained above, there are likely certain test scenarios (for example, right direction curves) with which some current ADB systems may not comply; however, in these instances NHTSA believes that manufacturers should be able to modify existing systems to meet the requirements.

NHTSA has also concluded that the final rule is objective and repeatable. The final rule sets out a rational test procedure that yields a clear answer based upon readings obtained from measuring instruments and is capable of producing identical results when test conditions are exactly duplicated.²²³ Further, the final rule establishes the specific scenarios the agency may test, including ranges and values for key testing parameters, and specific numeric limits for the maximum allowable illuminance at certain distances. NHTSA believes that the final rule specifies the test parameters that contribute to most of the test-related variability, and that there is no ambiguity with respect to the parameter values (e.g., differing radii of curvature) NHTSA may select in compliance testing. To further evaluate the repeatability of the track test, NHTSA conducted a repeatability analysis, which shows that the test is repeatable (see Section VIII.C.11, Repeatability).

P. Overview of Benefits and Costs

The NPRM considered the qualitative costs and benefits of the proposal compared to both the current baseline in which ADB systems are not deployed as well as the primary regulatory alternative (SAE J3069).²²⁴ Based on this qualitative analysis, NHTSA tentatively concluded that ADB systems should be permitted (because the proposal would lead to higher net benefits compared to the status quo in which ADB systems are not deployed) and that the proposed requirements and test procedures would

lead to higher net benefits than SAE J3069.²²⁵

Comments

With regard to allowing the introduction of ADB systems, as noted earlier, all the industry and public-interest commenters supported amending the standard to allow the introduction of ADB technology. Many of the drive-in theatre owner/operators indicated some level of support for the rule (assuming it provides for manual control). The majority of comments from individual members of the public supported the proposal, frequently on the grounds that it would likely reduce glare or increase safety. Some individual commenters, and some owner/operators of drive-in movie theatres, opposed the proposal and/or expressed concern that the introduction of ADB systems could lead to increased glare.

With respect to the proposed requirements and test procedures, most industry commenters stated that the proposed requirements were too stringent, and did not meet the need for safety because they overemphasized glare prevention at the expense of visibility.²²⁶ Several commenters (Mobileye, the Alliance, IIHS, Auto Innovators, Toyota, Volkswagen) contended that the proposal did not maximize overall benefits because it prioritized glare prevention over enhanced visibility and stated that the final rule should instead place greater weight on the benefits from enhanced visibility. For example, Mobileye commented that the proposal would not allow OEMs to tune an ADB system to

²²⁵ For additional information, see the NPRM, pp. 51799–51801.

²²⁶ There were numerous comments as to why specific aspects of the proposal were too stringent (for example, testing on small right curves). These specific comments are addressed in the preceding sections of the preamble. This section deals with more general comments about the overall stringency of the requirements and the relative benefits of visibility and glare prevention.

²²³ See *Chrysler Corp. v. Dept. of Transp.*, 472 F.2d 659, 676 (6th Cir. 1972) (construing “objective”).

²²⁴ NHTSA has not quantified the costs and benefits of the proposal for the reasons discussed in the NPRM and below in Section X, Rulemaking Analyses and Notices (in connection with the discussion of Executive Order 12866).

provide optimal visibility to drivers. Mobileye contended that the result would be that the benefit of providing a driver with higher visibility will be diminished with negligible gain in preventing glare. IIHS also argued that, in terms of safety, the glare problem appears relatively small (glare was cited in only 1% of non-daylight crashes in the National Motor Vehicle Crash Causation Survey). Auto Innovators similarly commented that NHTSA's own research indicates that it is difficult to determine glare as a direct cause of crashes or fatalities.²²⁷ Auto Innovators noted that NHTSA's own research has shown that while glare was a contributing factor in only about 0.3% of nighttime fatal crashes²²⁸ over 70% of pedestrian fatalities occur at night.²²⁹ Auto Innovators also pointed to IIHS research finding that between 2009 and 2016, pedestrian deaths in dark conditions increased 56%²³⁰ and a report from the Government Accountability Office finding that the number of pedestrians killed annually in motor vehicle crashes increased 43% between 2008 and 2018 and recommending NHTSA take additional actions to address pedestrian safety.²³¹ Toyota also asserted that glare is predominantly an issue of inconvenience and discomfort, and that the proposal was not justified by data showing that glare is a safety concern that requires such stringency.

Similarly, many commenters contended that the proposal, particularly the track test, was costly, burdensome, and impracticable. See Section VIII.C.1, Practicability of Proposed Test Scenarios. Honda also stated more generally that the proposed dynamic track test procedure did not strike the appropriate balance between effectiveness and practicality. On the other hand, AAA recommended that the

requirements be technology-forcing with respect to improvements in both glare prevention and visibility, and not simply adhere to established minimums because absent such requirements such improvement may not be made.

A few commenters commented that the final rule would better balance visibility and glare if it exempted ADB systems from some or all the laboratory photometric requirements. In this context, IIHS specifically asserted that the Table XIX lower beam requirements should not apply to ADB, the Alliance suggested that none of the laboratory requirements should apply to ADB, and Volkswagen stated that the upper beam maximum should not apply.

Mobileye and the Alliance argued that the proposal's emphasis on glare was also unnecessary because market forces would sufficiently incentivize glare prevention. Mobileye explained that OEMs are more likely to hear from owners of ADB-equipped vehicles about problems with glare than with visibility. The Alliance commented that manufacturers are concerned with customer safety and satisfaction; for example, automatic high beam systems are evaluated from both driver and other motorist perspectives via intracompany test drive scenarios, some of which include the presence of simulated "other motorists." The Alliance asserted that the deployment of ADB systems will result in a decrease in the volume of glare complaints received by NHTSA.

As noted in the regulatory alternatives section, many commenters recommended adopting SAE J3069. Some commenters (Global, Volkswagen, the Alliance) suggested that the disharmonized aspects of the proposal would not lead to safety benefits or could decrease safety benefits. Commenters also claimed that the proposal would be more costly than SAE J3069 and/or the ECE requirements because the disharmonization would result in additional development and component costs.

Agency Response

With respect to the costs and benefits of the final rule compared to the current baseline in which ADB systems are not deployed, NHTSA has concluded that because the rulemaking expands the set of consumer choices (compared to the status quo), it is an enabling regulation. NHTSA also concludes that, because it expects positive benefits and cost savings,²³² this final rule will lead to

higher net benefits compared to the status quo in which ADB systems are not deployed.

With respect to the costs and benefits of the proposal compared to SAE J3069, in the NPRM NHTSA tentatively concluded that although the proposal was likely more costly than SAE J3069 (due to higher compliance testing and equipment costs), these higher costs were likely outweighed by the higher safety-related benefits (and lower glare disbenefits). We therefore tentatively concluded that the likely net benefits of the proposal were greater than if we adopted SAE J3069 in every respect. As we explain below, however, after considering the comments NHTSA has concluded that more closely following SAE J3069 in certain respects would lead to higher net benefits than the proposal through lower costs (testing and equipment) and higher benefits (visibility) without meaningfully increasing disbenefits (glare). We believe the final rule appropriately balances benefits and costs and that the net benefits of the final rule are greater than if we adopted SAE J3069 in every respect.

As an initial matter, NHTSA agrees with the commenters that it is difficult to precisely determine the risk from glare; that pedestrian fatalities are on the rise; and therefore that improved visibility could help to address this trend. Nevertheless, in the absence of empirical evidence to the contrary, the agency still believes that glare poses a non-trivial safety risk that justifies some departures from the SAE standard.

NHTSA agrees with the commenters that the proposed track test to evaluate glare was too stringent in a couple of ways. First, the proposed track test somewhat overemphasized glare at the expense of visibility. This includes that lower beams that currently comply with FMVSS No. 108 may not have complied with some of the proposed scenarios. NHTSA also recognizes that the proposed requirements may have led manufacturers to tune ADB systems to be overly conservative in order to have acceptable compliance margins, potentially diminishing the visibility benefits that ADB can provide. Second, the agency agrees that the proposed track test procedure included redundant scenarios, and that the final rule can more closely follow SAE J3069 without sacrificing the evaluative power of the test.

The modifications we have made to the proposal address those issues regarding stringency. The most important of the modifications are the reduced number of test scenarios and the specification of stationary test

²²⁷ Comment from Alliance for Automotive Innovation (NHTSA-2018-0090-0219), p. 8 (citing Nighttime Glare and Driving Performance, Report to Congress, National Highway Traffic Safety Administration, Department of Transportation (2007)).

²²⁸ *Id.* (citing National Highway Traffic Safety Administration. 2014. Traffic Safety Facts 2012 Data: Pedestrians, DOT HS 811 888. Washington, DC: National Highway Traffic Safety Administration.)

²²⁹ *Id.* (citing National Highway Traffic Safety Administration. 2018 (Revised). Traffic Safety Facts 2016 Data: Pedestrians, DOT HS 812 493. Washington, DC: National Highway Traffic Safety Administration.)

²³⁰ *Id.* (citing www.iihs.org/iihs/sr/statusreport/article/53/3/1).

²³¹ *Id.*, pp. 8-9 (citing Government Accountability Office. (2020, April). NHTSA Needs to Decide Whether to Include Pedestrian Safety Tests in Its New Car Assessment Program. (Publication No. GAO-20-419) (retrieved from www.gao.gov/assets/710/706348.pdf)).

²³² As we explained in the NPRM, the estimated cost savings of an enabling regulation include the full opportunity costs of the previously foregone activities (*i.e.*, the sum of consumer and producer surplus, minus any fixed costs). NPRM at p. 51800.

fixtures instead of dynamic stimulus vehicles to follow SAE J3069 more closely and reduce the complexity of testing. However, the final track test procedure continues to depart from SAE J3069 in a few ways, especially in that it retains the use of curved test path scenarios and uses fixtures fitted with actual vehicle lamps. The agency believes that the final test scenarios are efficient yet sufficient to determine whether an ADB system prevents glare to other motorists, and that the final rule strikes an appropriate balance between visibility and glare prevention, and between safety and practicability. The reasons for the agency's specific choices are explained earlier in the preamble.

NHTSA believes the final rule is neither cost-prohibitive nor impracticable compared to the alternatives. As explained in Section VIII.O (Regulatory Alternatives), design and development costs will not significantly differ from those that would have been incurred by compliance with the SAE or ECE standards. On the other hand, with respect to AAA's comment that the final rule be technology-forcing, NHTSA believes the final rule is somewhat technology forcing with respect to glare: While the requirements are generally within the capabilities of current ADB system, there are some respects in which tested ADB performance fell short (for example, appropriately responding to the motorcycle fixture). ADB systems may therefore need to be improved or modified to certify to some aspects of the requirements. With respect to visibility, the final rule does depart from SAE J3069 in requiring the lower beam minima in an area of reduced intensity and the upper beam minima in an area of unreduced intensity.

With respect to the comments about market incentives to mitigate glare, NHTSA does not doubt that OEMs are attentive to owner concerns but believes that vehicle owners are less likely to notify OEMs about issues with glaring other motorists. Manufacturers pointed to the lack of warranty claims or vehicle owner complaints about glare issues (and Volkswagen noted that it has not received any owner complaints about ADB systems causing glare). Of course, this could indicate that there are no glare issues, but it also could indicate that glare issues go unreported. In any case, the fact that glare is largely an externality would seem to make glare mitigation less likely to be incentivized by market signals.

NHTSA also believes that the final component-level laboratory testing requirements strike an appropriate

balance between visibility and glare. In particular, the agency believes (and the comments did not convince us otherwise) that specifying the lower beam photometric minima for areas of reduced intensity and the upper beam minima in areas of unreduced intensity are important for guaranteeing a minimum level of visibility. Conversely, as discussed earlier in the preamble, it is important to specify the current upper beam maximum for areas of unreduced intensity.

IX. Appendix to FMVSS No. 108 (Table of Contents)

When NHTSA re-wrote FMVSS No. 108 (the final rule for which was published in 2007), it added an appendix that contained a table of contents for the standard.²³³ The Office of the Federal Register no longer allows appendices to sections, and § 571.108 is the only section in Part 571 to have a table of contents. Because the appendix may be a useful aid to users of the standard, rather than simply deleting the appendix NHTSA is moving it to the end of subpart B of Part 571.

X. Rulemaking Analyses and Notices

Executive Order 12866, Executive Order 13563, and DOT Regulatory Policies and Procedures

We have considered the potential impact of this final rule under Executive Order 12866, Executive Order 13563, and DOT Order 2100.6A. This final rule is not significant and so was not reviewed by OMB under E.O. 12866 and is not of special note to the Department under DOT Order 2100.6A. Pursuant to E.O. 12866 and the Department's policies, we have identified the problem this rule addresses, assessed the benefits and costs, and considered alternatives. These analyses have been provided in preceding sections of the preamble; benefits and costs are summarized in Section VIII.P. As explained below, NHTSA has determined that quantifying the benefits and costs is not practicable for this rulemaking.

Quantifying the benefits of the rule—the decrease in deaths and injuries due to the greater visibility made possible by ADB—is difficult because of a variety of data limitations related to accurately estimating the target population and the effectiveness of ADB systems (as well as the potential penetration rate of ADB systems). For example, headlamp state (on-off, upper-lower beam) is not reflected in the data for many pedestrian crashes. Nevertheless, in the NPRM we

attempted to broadly estimate the magnitude of the target population.²³⁴

Quantification of costs is similarly not practicable. The only currently-available ADB systems are in foreign markets such as Europe. We believe, as explained in the discussion of regulatory alternatives and elsewhere in the preamble, that an ECE-approved ADB system (modified to have FMVSS 108-compliant photometry) would, with some further modifications, be able to comply with the rule's requirements (see the discussion of regulatory alternatives). For the reasons explained in detail in the preamble, we believe that the final requirements are generally within the capabilities of existing ADB systems, although some adjustments might be necessary. We also note that this final rule does not require manufacturers to equip their vehicles with ADB systems. The requirements of this final rule specify minimum performance requirements for the lighting systems that only apply if manufacturers choose to equip vehicles with ADB systems.

Although NHTSA has concluded that quantification of costs and benefits is not practicable, we have qualitatively assessed the benefits and costs of the final rule. As we explain in Section VIII.P, Overview of Benefits and Costs, we believe the final rule appropriately balances benefits and costs and that the net benefits of the final rule are greater compared to both the status quo in which ADB systems are not deployed and if we adopted SAE J3069 in every respect.

Executive Order 13609: Promoting International Regulatory Cooperation

The policy statement in section 1 of Executive Order 13609 provides that the regulatory approaches taken by foreign governments may differ from those taken by the United States to address similar issues, and that in some cases the differences between them might not be necessary and might impair the ability of American businesses to export and compete internationally. It further recognizes that in meeting shared challenges involving health, safety, and other issues, international regulatory cooperation can identify approaches that are at least as protective as those that are or would be adopted in the absence of such cooperation and can reduce, eliminate, or prevent

²³³ 72 FR 68234 (Dec. 4, 2007). This was an administrative rewrite; it did not impose any new substantive requirements on manufacturers.

²³⁴ See Appendix A in the NPRM. Toyota's rulemaking petition also includes a target population analysis using a different methodology. Letter from Tom Stricker, Toyota Motor North America, Inc. to NHTSA, Appendix D (Mar. 29, 2013).

unnecessary differences in regulatory requirements.

This rule is different than comparable foreign regulations. For the reasons described in this preamble, these differences are justified because they have the potential to enhance safety.

Executive Order 13132 (Federalism)

NHTSA has examined this rule pursuant to Executive Order 13132 (64 FR 43255; Aug. 10, 1999) and concluded that no additional consultation with States, local governments, or their representatives is mandated beyond the rulemaking process. The agency has concluded that the rule does not have sufficient federalism implications to warrant consultation with State and local officials or the preparation of a federalism summary impact statement. The rule does not have “substantial direct effects on the States, on the relationship between the national government and the States, or on the distribution of power and responsibilities among the various levels of government.”

NHTSA rules can have preemptive effect in two ways. First, the National Traffic and Motor Vehicle Safety Act contains an express preemption provision: When a motor vehicle safety standard is in effect under this chapter, a State or a political subdivision of a State may prescribe or continue in effect a standard applicable to the same aspect of performance of a motor vehicle or motor vehicle equipment only if the standard is identical to the standard prescribed under this chapter. 49 U.S.C. 30103(b)(1). It is this statutory command by Congress that preempts any non-identical State legislative and administrative law address the same aspect of performance.

The express preemption provision described above is subject to a savings clause under which “[c]ompliance with a motor vehicle safety standard prescribed under this chapter does not exempt a person from liability at common law.” 49 U.S.C. 30103(e). Pursuant to this provision, State common law tort causes of action against motor vehicle manufacturers that might otherwise be preempted by the express preemption provision are generally preserved. However, the Supreme Court has recognized the possibility, in some instances, of implied preemption of State common law tort causes of action by virtue of NHTSA’s rules—even if not expressly preempted.

This second way that NHTSA rules can preempt is dependent upon the existence of an actual conflict between an FMVSS and the higher standard that

would effectively be imposed on motor vehicle manufacturers if someone obtained a State common law tort judgment against the manufacturer— notwithstanding the manufacturer’s compliance with the NHTSA standard. Because most NHTSA standards established by an FMVSS are minimum standards, a State common law tort cause of action that seeks to impose a higher standard on motor vehicle manufacturers will generally not be preempted. However, if and when such a conflict does exist—for example, when the standard at issue is both a minimum and a maximum standard—the State common law tort cause of action is impliedly preempted. See *Geier v. American Honda Motor Co.*, 529 U.S. 861 (2000).

Pursuant to Executive Order 13132, NHTSA has considered whether this rule could or should preempt State common law causes of action. The agency’s ability to announce its conclusion regarding the preemptive effect of one of its rules reduces the likelihood that preemption will be an issue in any subsequent tort litigation.

To this end, the agency has examined the nature (*e.g.*, the language and structure of the regulatory text) and objectives of this rule and does not foresee any potential State requirements that might conflict with it. We note that many or most States have laws that regulate lower and upper beam use. These laws require that a motorist use a lower beam within a certain distance of an oncoming or preceding vehicle. We do not believe that there is a conflict between the rule and these laws. A vehicle equipped with a compliant and properly functioning ADB system should not glare other vehicles. Moreover, the rule requires an ADB-equipped vehicle to provide the driver with a means of manually overriding the automatically provided beam. Therefore, if, for any reason the driver determines that the automatically provided beam is not appropriate, the driver can manually switch to the appropriate beam (*e.g.*, lower beam). NHTSA does not intend this rule to preempt State tort law that would effectively impose a higher standard on motor vehicle manufacturers than that established by this rule. Establishment of a higher standard by means of State tort law would not conflict with the standards in this final rule. Without any conflict, there could not be any implied preemption of a State common law tort cause of action.

National Environmental Policy Act

The National Environmental Policy Act of 1969 (NEPA) (42 U.S.C. 4321–

4347) requires Federal agencies to analyze the environmental impacts of proposed major Federal actions significantly affecting the quality of the human environment, as well as the impacts of alternatives to the proposed action.²³⁵ When a Federal agency prepares an environmental assessment, the Council on Environmental Quality (CEQ) NEPA implementing regulations (40 CFR parts 1500–1508) require it to (1) “[b]riefly provide sufficient evidence and analysis for determining whether to prepare an environmental impact statement or a finding of no significant impact” and (2) “[b]riefly discuss the purpose and need for the proposed action, alternatives . . . , and the environmental impacts of the proposed action and alternatives, and include a listing of agencies and persons consulted.” 40 CFR 1501.5(c). This section serves as the Final Environmental Assessment (Final EA).

Purpose and Need

This notice sets forth the purpose of and need for this action. As explained earlier in this preamble, ADB technology improves safety by providing a variable, enhanced lower beam pattern that is sculpted to traffic on the road, rather than just one static lower beam pattern, thereby providing more illumination without glare to other motorists. In addition, ADB technology will likely lead to increased upper beam use, thereby improving driver visibility distance at higher speeds. In the NPRM, NHTSA concluded that FMVSS No. 108 does not currently permit ADB technology.

Alternatives

NHTSA considered a range of regulatory alternatives for the proposed action. Under a “no action alternative,” NHTSA would not issue a final rule amending FMVSS No. 108, and ADB technology would continue to be prohibited. NHTSA has also considered the ECE requirements and SAE J3069, which are described above in this preamble. In the final rule, NHTSA incorporates elements from these standards, but departs from them in significant ways, which are also described above.

Environmental Impacts of the Proposed Action and Alternatives

This final rule is anticipated to result in increased upper beam use as well as greater illumination provided by the adaptive driving beams (in patterns designed to prevent glare to other motorists). As a result, the primary

²³⁵ 42 U.S.C. 4332(2)(C).

environmental impacts anticipated to result from this rulemaking are associated with light pollution, including the potential disruption of wildlife adjacent to roadways. The National Park Service (NPS) defines “light pollution” as the introduction of artificial light, either directly or indirectly, into the natural environment.²³⁶ Forms of light pollution include sky glow (the bright halo over urban areas at nighttime), light trespass (unintended artificial lighting on areas that would otherwise be dark), glare (light shining horizontally), and over illumination (excess artificial lighting for a specific activity).²³⁷ Light pollution caused by artificial light can have various effects on flora and fauna, including disrupting seasonal variations and circadian rhythms, disorientation and behavioral disruption, sleep disorders, and hormonal imbalances.²³⁸

Although this rule is anticipated to result in increased levels of illumination caused by automobiles at nighttime, NHTSA does not believe these levels would contribute appreciably to light pollution in the United States. First, the rule requires that the part of an ADB beam that is cast near other vehicles not exceed the current lower beam maxima and the part of an ADB beam that is cast onto unoccupied roadway not exceed the current upper beam maxima. Although overall levels of illumination are expected to increase from current levels due to increased upper beam use and the sculpting of the adaptive driving beams to traffic on the road, total potential brightness would not be permitted to exceed the potential maxima that already exists on motor vehicles today. These maxima not only reduce the potential for glare to other drivers but also limit the potential impact of light pollution.

Second, we note that ADB systems remain optional. Because of the added costs associated with the technology, NHTSA does not anticipate that manufacturers would make these systems standard equipment in all their vehicle models at this time. Thus, only a percentage of the on-road fleet will feature ADB systems, while new vehicles without the systems are anticipated to continue to have levels of illumination at current rates.

Third, while ADB systems generally would increase horizontal illumination, they likely would not contribute to

ambient light pollution to the same degree as other forms of illumination, such as streetlights and building illumination, where light is intentionally scattered to cover large areas or wasted due to inefficient design, likely contributing more to the nighttime halo effect in populated areas. According to NPS, the primary cause of light pollution is outdoor lights that emit light upwards or sideways (but with an upwards angle).²³⁹ As the light escapes upward, it scatters throughout the atmosphere and brightens the night sky. Lighting that is directed downward, however, contributes significantly less to light pollution. Lower beams generally direct light away from oncoming traffic and downward in order to illuminate the road and the environs close ahead of the vehicle while minimizing glare to other road users. As a result, any increases in lower beam illumination are not anticipated to contribute meaningfully to light pollution. As discussed further in the next paragraph, increases in upper beam illumination would be anticipated largely in less populated areas, where oncoming traffic is less frequent and small sources of artificial light (such as motor vehicles) likely would not change ambient light levels at nighttime to a meaningful degree.

Fourth, NHTSA believes that the areas that would see the greatest relative increase in nighttime illumination are predominantly rural and unlikely to experience widespread impacts. The rule requires ADB systems to produce a lower beam at speeds below 20 mph. These slower speeds are anticipated primarily in crowded, urban environments where the current impacts of light pollution are likely the greatest. As a result, such urban environments should not experience changes in light levels produced from motor vehicles as a result of this rule. In moderately crowded, urban environments, nighttime vehicles may travel above 20 mph, thereby engaging the ADB system. However, in those cases, upper beam use would likely be low, as the high level of other road users would cause the ADB system to rely on lower beams for visibility in order to reduce glare for other drivers. These areas may experience small increases in light pollution as the upper beams occasionally engage, as well as increased illumination associated with the adaptive driving beam. In rural areas, where traffic levels are lower and driving speeds may be higher, the use of

ADB systems is anticipated to result in increased upper beam use. However, the low traffic levels would result in only moderate additional light output, and the low quantity of artificial light sources in general would mean that light pollution levels overall would be anticipated to remain low.

The final rule is anticipated to improve visibility without glare to other drivers. In addition to the potential safety benefits associated with reduced crashes, this rule could result in fewer instances of collisions involving animals on roadways. Upper beams are used primarily for distance illumination when not meeting or closely following another vehicle. Increased upper beam use in poorly lit environments, such as rural roadways, may allow drivers increased time to identify roadway hazards (such as animals) and to stop, slow down, or avoid a collision.

In addition, the impact of added artificial light on wildlife located near roadways would depend on where and how long the additional illumination occurs, whether wildlife is present within a distance to detect the light, and the sensitivity of wildlife to the illumination level of the added light. Wildlife species located near active roadways have likely acclimated to the light produced by passing vehicles, including light associated with upper beams (which would be the same under the proposal in terms of brightness, directionality, and shape as under current regulations). Any additional disruption caused by increased use of upper beams is not feasible to quantify due to the extensive number of variables associated with ADB use and wildlife.

NHTSA is unable to comparatively evaluate the potential light pollution impacts of the rule compared to the other regulatory alternatives (ECE requirements and SAE J3069). For example, the rule requires that the area of unreduced intensity meet the upper beam minima and the area of reduced intensity meet the lower beam minima. The SAE standard only requires that the area of unreduced intensity meet the lower beam minima. However, NHTSA also proposes that the area of unreduced intensity may not exceed the upper beam maxima, whereas the SAE standard does not specify any maxima for the undimmed portion. Thus, while the final rule establishes requirements for minimum levels of light, it also limits the maximum level of light in the area of unreduced intensity; both differ from the SAE standard. This combined with the wide variations still permitted under the final rule and the SAE standard make it difficult to compare them with any level of certainty.

²³⁶ National Park Service, Light Pollution. <https://www.nps.gov/subjects/nightskies/lightpollution.htm> (last accessed Sept. 26, 2018).

²³⁷ Chepesiuk, R. 2009. Missing the Dark: Health Effects of Light Pollution. *Environmental Health Perspectives*, 117(1), A20–A27.

²³⁸ *Id.*

²³⁹ NPS, Light Pollution Sources. <https://www.nps.gov/subjects/nightskies/sources.htm> (last accessed Sept. 26, 2018).

However, to the degree to which ABD systems would function similarly under each of those standards, the environmental impacts would be anticipated to be similar.

Agencies and Persons Consulted

This preamble describes the various materials, persons, and agencies consulted in the development of the proposal.

Finding of No Significant Impact

I have reviewed this EA. Based on the EA, I conclude that any of the impacts anticipated to result from the alternatives under consideration will not have a significant effect on the human environment and that a “finding of no significant impact” is appropriate. This statement constitutes the agency’s “finding of no significant impact,” and an environmental impact statement will not be prepared. 40 CFR 1501.6(a).

Executive Order 12988 (Civil Justice Reform)

With respect to the review of the promulgation of a new regulation, section 3(b) of Executive Order 12988, “Civil Justice Reform” (61 FR 4729, February 7, 1996) requires that Executive agencies make every reasonable effort to ensure that the regulation: (1) Clearly specifies the preemptive effect; (2) clearly specifies the effect on existing Federal law or regulation; (3) provides a clear legal standard for affected conduct, while promoting simplification and burden reduction; (4) clearly specifies the retroactive effect, if any; (5) adequately defines key terms; and (6) addresses other important issues affecting clarity and general draftsmanship under any guidelines issued by the Attorney General. This document is consistent with that requirement.

Pursuant to this Order, NHTSA notes as follows. The issue of preemption is discussed above in connection with E.O. 13132. NHTSA notes further that there is no requirement that individuals submit a petition for reconsideration or pursue other administrative proceeding before they may file suit in court.

Regulatory Flexibility Act

Pursuant to the Regulatory Flexibility Act (5 U.S.C. 601 *et seq.*, as amended by the Small Business Regulatory Enforcement Fairness Act (SBREFA) of 1996), whenever an agency is required to publish an NPRM or final rule, it must prepare and make available for public comment a regulatory flexibility analysis (RFA) that describes the effect of the rule on small entities (*i.e.*, small businesses, small organizations, and

small governmental jurisdictions). The Small Business Administration’s regulations at 13 CFR part 121 define a small business, in part, as a business entity “which operates primarily within the United States.” (13 CFR 121.105(a)). No regulatory flexibility analysis is required if the head of an agency certifies that the rule will not have a significant economic impact on a substantial number of small entities. The SBREFA amended the Regulatory Flexibility Act to require Federal agencies to provide a statement of the factual basis for certifying that a rule will not have a significant economic impact on a substantial number of small entities.

NHTSA has considered the effects of this final rule under the Regulatory Flexibility Act. According to 13 CFR 121.201, the Small Business Administration’s size standards regulations used to define small business concerns, manufacturers of the vehicles covered by this final rule would fall under North American Industry Classification System (NAICS) No. 336111, *Automobile Manufacturing*, which has a size standard of 1,500 employees or fewer.

NHTSA estimates that there are six small light vehicle manufacturers in the U.S. We estimate that there are eight headlamp manufacturers that could be impacted by this rule. I certify that this rule will not have a significant economic impact on a substantial number of small entities. Most of the affected entities are not small businesses. The rule will not establish a mandatory requirement on regulated persons.

National Technology Transfer and Advancement Act and 1 CFR Part 51

Under the National Technology Transfer and Advancement Act of 1995 (NTTAA),²⁴⁰ “all Federal agencies and departments shall use technical standards that are developed or adopted by voluntary consensus standards bodies, using such technical standards as a means to carry out policy objectives or activities determined by the agencies and departments.”²⁴¹ However, if the use of such technical standards would be “inconsistent with applicable law or otherwise impractical, a Federal agency or department may elect to use technical standards that are not developed or adopted by voluntary consensus standards bodies[.]”²⁴² Voluntary

²⁴⁰ National Technology Transfer and Advancement Act of 1995, Public Law 104–113, 110 Stat. 775 (1996).

²⁴¹ *Id.* at § 12(d)(1).

²⁴² *Id.* at § 12(d)(3).

consensus standards are technical standards (*e.g.*, materials specifications, test methods, sampling procedures, and business practices) that are developed or adopted by voluntary consensus standards bodies such as SAE. The NTTAA directs the agency to provide Congress, through OMB, explanations when the agency decides not to use available and applicable voluntary consensus standards. Circular A–119 directs that evaluating whether to use a voluntary consensus standard should be done on a case-by-case basis.²⁴³ An agency should consider, where applicable, factors such as the nature of the agency’s statutory mandate and the consistency of the standard with that mandate.²⁴⁴

SAE has published a voluntary consensus standard (SAE J3069 JUN2016) for ADB systems.²⁴⁵ The Competitive Enterprise Institute (CEI), in its comments, specifically referenced the NTTAA, arguing that the NPRM unnecessarily departed from SAE J3069.

NHTSA has modified the proposal to more closely follow SAE J3069 where warranted, but to deviate from that standard where necessary. The most important of these changes were specifying stationary test fixtures instead of dynamic stimulus vehicles and substantially simplifying the number and complexity of the test scenarios. However, there are several aspects of the final rule for which NHTSA ultimately concluded that deviation from SAE J3069 is warranted because SAE J3069 did not adequately address glare or visibility. The major differences are summarized in Section VIII.O, Regulatory Alternatives. The preceding sections of this document discuss in detail the ways in which the final rule follows and differs from SAE J3069, and explain why we believe these departures are justified.

The CIE 1931 Chromaticity Diagram was previously approved for incorporation by reference in the section where it appears as of February 6, 2012.

Paperwork Reduction Act

Under the Paperwork Reduction Act of 1995 (PRA) (44 U.S.C. 3501, *et seq.*), Federal agencies must obtain approval from the Office of Management and Budget (OMB) for each collection of information they conduct, sponsor, or require through regulations. This

²⁴³ Office of Management and Budget, Circular No. A–119, ¶ 5(a)(i), Federal Participation in the Development and Use of Voluntary Consensus Standards and in Conformity Assessment Activities (Jan. 26, 2016).

²⁴⁴ *Id.*

²⁴⁵ SAE has recently published a revised version, SAE J3069 MAR2021.

rulemaking modifies two existing information collection requirements. First, this rulemaking modifies the requirements for manufacturers to provide instructions for operating semiautomatic headlamp switching devices. Prior to this final rule, the standard required manufacturers to provide instructions on how to operate the device correctly, including: How to turn the automatic control on and off; how to adjust the sensitivity control; and any other specific instructions applicable to the device. This rule modifies the requirement by excluding ADB systems from the requirement to provide instructions on how to adjust the sensitivity control if they are not equipped with a sensitivity control. The rule also modifies the requirements regarding providing instructions for vehicle headlamp aiming devices (VHAD). Prior to this rule, the standard required manufacturers to provide instructions advising that the headlighting system is properly aimed if the appropriate vertical plane (as defined by the vehicle manufacturer) is perpendicular to both the longitudinal axis of the vehicle, and a horizontal plane when the vehicle is on a horizontal surface, and the VHAD is set at “0” vertical and “0” horizontal. The final rule changes the standard to require manufacturers to provide instructions advising the vehicle owner what to do if the headlighting system requires aiming using the VHAD.

NHTSA is separately publishing a notice requesting comment on NHTSA’s intention to request approval for a modification to its previously approved information collection request titled “Consolidated Vehicle Owner’s Manual Requirements for Motor Vehicles and

Motor Vehicle Equipment.” The document (Docket Number: NHTSA–2021–0059) will provide details about the burden associated with the information collection and will provide a 60-day comment period.

Unfunded Mandates Reform Act

The Unfunded Mandates Reform Act of 1995 (Pub. L. 104–4) (UMRA) requires agencies to prepare a written assessment of the costs, benefits, and other effects of proposed or final rules that include a Federal mandate likely to result in the expenditures by States, local or tribal governments, in the aggregate, or by the private sector, of more than \$100 million annually (adjusted annually for inflation with base year of 1995). Adjusting this amount by the implicit gross domestic product price deflator for 2016 results in \$148 million ($111.416/75.324 = 1.48$). The assessment may be included in conjunction with other assessments, as it is here.

This rule is not likely to result in expenditures by State, local or tribal governments of more than \$148 million annually.

UMRA requires the agency to select the “least costly, most cost-effective or least burdensome alternative that achieves the objectives of the rule.” As discussed above, the agency considered alternatives to the final rule and has concluded that the requirements are the most cost-effective alternatives that achieve the objectives of the rule.

Regulation Identifier Number (RIN) 2127–AL83

The Department of Transportation assigns a regulation identifier number (RIN) to each regulatory action listed in the Unified Agenda of Federal

Regulations. The Regulatory Information Service Center publishes the Unified Agenda in April and October of each year. You may use the RIN contained in the heading at the beginning of this document to find this action in the Unified Agenda.

Privacy Act

Anyone is able to search the electronic form of all documents received into any of our dockets by the name of the individual submitting the document (or signing it, if submitted on behalf of an association, business, labor union, etc.). You may review DOT’s complete Privacy Act Statement in the **Federal Register** published on April 11, 2000, (Volume 65, Number 70; Pages 19477–78) or you may visit www.dot.gov/privacy.html.

Appendices to the Preamble

Appendix A. Comparison of Oncoming Glare Limits to Table XIX Right-Side Photometric Maxima

To analyze the dynamic track test procedure requirements in the narrow right-side region of the beam from 1R to 3R and compare it to the current Table XIX requirements (particularly .5 U, 1R–3R, which has a minimum of 500 cd and a maximum of 2,700 cd), the agency calculated the horizontal angle for each headlamp (right and left) at each extreme of each right curve. See Figure A.1. These calculations assume a headlamp mounting height of 0.4 m below the oncoming photometer height (1.1 m above ground), or a headlamp height of 0.7 m above the ground. Additionally, they assume a headlamp separation distance of 1.1 m and a lane width of 3.66 m.

BILLING CODE 4910–59–P

Figure A.1. Horizontal angle for each headlamp (right and left) at each extreme of each right curve

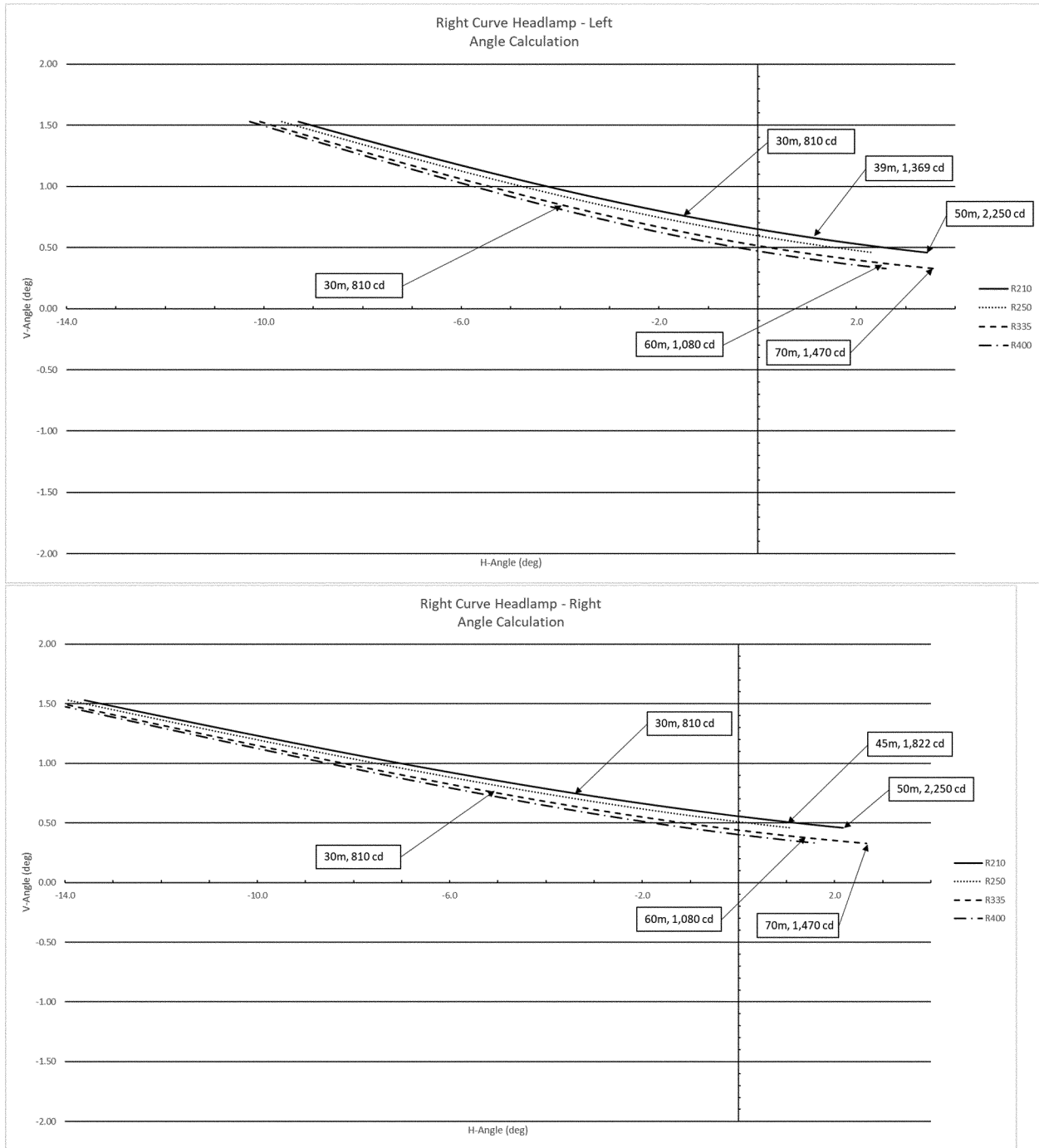

Left Headlamp											
Positive Horizontal Angle are Right											
Distance	Max illuminance	R210		R250		R335		R400		cd per Lamp	
		V (UP)	H	V (UP)	H	V (UP)	H	V (UP)	H		
15	3.1	1.53	-9.31	1.53	-9.64	1.53	-10.08	1.53	-10.29	349	
29	3.1	0.79	-1.89	0.79	-2.53	0.79	-2.53	0.79	-3.78	1304	
30	1.8	0.76	-1.56	0.76	-2.22	0.76	-2.22	0.76	-3.51	810	
50	1.8	0.46	3.43	0.46	2.34					2250	
59	1.8					0.39	2.17	0.39	1.35	3133	
60	0.6					0.38	2.31	0.38	1.47	1080	
70	0.6					0.33	3.57	0.33	2.59	1470	

Right Headlamp											
Positive Horizontal Angle are Right											
Distance	Max illuminance	R210		R250		R335		R400		Intensity per lamp	
		V (UP)	H	V (UP)	H	V (UP)	H	V (UP)	H		
15	3.1	1.53	-13.60	1.53	-13.93	1.53	-14.38	1.53	-14.60	349	
29	3.1	0.79	-4.07	0.79	-4.71	0.79	-4.71	0.79	-5.96	1304	
30	1.8	0.76	-3.67	0.76	-4.32	0.76	-4.32	0.76	-5.62	810	
50	1.8	0.46	2.17	0.46	1.08					2250	
59	1.8					0.39	1.10	0.39	0.28	3133	
60	0.6					0.38	1.25	0.38	0.42	1080	
70	0.6					0.33	2.67	0.33	1.69	1470	

For the medium radius, right curve, the most stringent angle toward the right side of the beam pattern will occur on the 210 m curve at 2.17 (right lamp) and 3.42 (left lamp) degrees right and 0.46U (close to 0.5U). As Stanley pointed out, this is very close to the 0.5U, 1R-3R line, for which Table XIX specifies a minimum of 500 cd and a maximum of 2,700 cd. The per lamp maximum of 2,250 cd implied by the applicable oncoming glare limit (1.8 lux) is slightly more stringent than 2,700 cd.

For the large radius right curve, the most stringent angle toward the right side of the beam pattern will occur on the 335 m curve at 2.67 (right lamp) and 3.57 (left lamp) degrees right and 0.33U (below the 0.5U line). This angle (which is dependent on the mounting height of the lamps) is below the 0.5U, 1R-3R line. The implied maximum of 1,470 per lamp is more stringent than 2,700 cd.

Appendix B. Example of Laboratory Photometric Testing of Adaptive Driving Beam

As explained in the preamble, in conducting its compliance testing, NHTSA will request information from the manufacturer on how to power and control the headlamps. To test the adaptive driving beam, we will activate a headlamp in the goniometer according to the manufacturer's instructions to produce an adaptive driving beam pattern that is consistent with an ADB pattern that would appear in the real-world with areas of reduced intensity, unreduced intensity, and/or transition zone(s). Specific patterns will conform to any real-world scenario determined by NHTSA. The ADB pattern generated will result in light directed toward all the test points in Tables XVIII and XIX. The issue then becomes which fixed test point falls within an area of reduced intensity, an area of unreduced intensity, or a transition zone. NHTSA will have manufacturers identify the

portion(s) of the adaptive beam are areas of reduced intensity and which are areas of unreduced intensity. The areas of reduced intensity must conform to the requirements for the test points in Table XIX that correspond to that area of reduced intensity. The area of unreduced intensity must conform to the requirements for the test points in Table XVIII that correspond to that area of unreduced intensity. Procedures for determining the transition for lower beams (similar to how the cutoff is determined, *i.e.*, a scan) can be used to determine whether the transition zone exceeds 1 degree.

For example, NHTSA could request from the manufacturer information on powering the headlamp and controlling it such that an area of reduced intensity area is centered horizontally around 0.5U 1.2R. A hypothetical isocandela pattern is provided in Table B.1. produced by the headlamp (simplified to a resolution of 0.1 degree for ease of visualization).

2.7	550	559	578	597	596	596	596	596	596	596	596	596
2.6	580	584	604	624	624	624	624	624	624	624	624	624
2.5	605	610	631	652	652	652	652	652	651	651	651	651
2.4	628	635	657	679	679	679	679	679	679	679	679	679
2.3	655	661	684	707	707	707	707	707	707	707	707	707
2.2	680	686	710	734	734	734	734	734	734	734	734	734
2.1	705	712	737	762	762	762	762	762	762	762	762	762
2.0	735	737	764	790	790	790	790	790	790	790	790	789
1.9	760	763	790	817	817	817	817	817	817	817	817	817
1.8	785	788	817	845	845	845	845	845	845	845	845	845
1.7	810	814	843	872	872	872	872	872	872	872	872	872
1.6	835	839	870	900	900	900	900	900	900	900	900	900
1.5	838	840	870	900	1027	1027	1027	1027	1027	1027	1027	1027
1.4	838	840	870	900	900	914	929	943	957	971	986	986
1.3	790	792	820	848	856	869	881	894	906	919	931	931
1.2	740	745	771	796	813	823	834	845	855	866	877	877
1.1	696	696	720	744	769	778	787	796	804	813	822	822
1.0	655	659	681	703	725	732	739	746	754	761	768	768
0.9	620	621	641	661	681	687	692	697	703	708	713	713
0.8	581	583	601	619	638	641	645	648	652	655	659	659
0.7	540	545	561	577	594	596	597	599	601	603	604	604
0.6	503	506	521	535	550	550	550	550	550	550	550	550
0.5	930	930	965	1000	550	550	550	550	550	550	550	550
0.4	582	582	600	2600	2600	2600	2600	2600	2600	2600	2600	2600
0.3	2611	2611	2725	4504	4783	5061	5340	5644	5419	5194	4969	4969
0.2	3788	3788	4851	6408	6965	7523	8080	8689	8239	7789	7339	7339
0.1	5887	5887	6976	8312	9148	9984	10820	11733	11058	10383	9708	9708
0.0	7987	7987	9101	10216	11331	12445	13560	14778	13878	12978	12078	12078

		Horizontal Angle										
		1.7	1.8	1.9	2.0	2.1	2.2	2.3	2.4	2.5	2.6	
Vertical Angle	3.5	375	375	1681	2987	4293	5599	6905	8211	9517	10823	10823
	3.4	403	402	1793	3184	4575	5966	7357	8748	10139	11530	11530
	3.3	430	430	1906	3382	4858	6334	7809	9285	10761	12237	12237
	3.2	458	458	2019	3579	5140	6701	8262	9822	11383	12944	12944
	3.1	485	485	2131	3777	5422	7068	8714	10359	12005	13651	13651
	3.0	513	513	2244	3974	5705	7435	9166	10896	12627	14357	14357
	2.9	541	541	2356	4172	5987	7802	9618	11433	13249	15064	15064
	2.8	568	568	2469	4369	6269	8170	10070	11970	13871	15771	15771
	2.7	596	596	2581	4566	6552	8537	10522	12507	14493	16478	16478
	2.6	624	624	2694	4764	6834	8904	10974	13044	15114	17185	17185
	2.5	651	651	2806	4961	7116	9271	11426	13581	15736	17891	17891
	2.4	679	679	2919	5159	7399	9638	11878	14118	16358	18598	18598
	2.3	707	707	3031	5356	7681	10006	12331	14655	16980	19305	19305
	2.2	734	734	3144	5554	7963	10373	12783	15192	17602	20012	20012
	2.1	762	762	3256	5751	8246	10740	13235	15729	18224	20719	20719
	2.0	789	789	3369	5948	8528	11107	13687	16266	18846	21425	21425
1.9	817	817	3481	6146	8810	11475	14139	16803	19468	22132	22132	
1.8	845	845	3594	6343	9093	11842	14591	17340	20090	22839	22839	
1.7	872	872	3707	6541	9375	12209	15043	17877	20712	23546	23546	
1.6	900	900	3819	6738	9657	12576	15495	18414	21333	24252	24252	
1.5	1027	1027	4020	7013	10006	12999	15992	18984	21977	24970	24970	
1.4	1000	1014	4097	7179	10261	13343	16426	19508	22590	25673	25673	

1.3	944	956	4133	7310	10486	13663	16840	20016	23193	26370
1.2	888	898	4169	7440	10712	13983	17254	20525	23796	27067
1.1	831	840	4206	7571	10937	14302	17668	21033	24399	27764
1.0	775	782	4173	7564	10955	14346	17737	21127	24518	27909
0.9	719	724	4140	7557	10973	14389	17805	21221	24638	28054
0.8	663	666	4283	7899	11516	15132	18749	22365	25982	29598
0.7	606	608	4425	8242	12059	15876	19692	23509	27326	31143
0.6	550	550	4567	8584	12602	16619	20636	24653	28671	32688
0.5	550	550	4761	8972	13183	17394	21606	25817	30028	34239
0.4	2600	2600	6777	10954	15132	19309	23486	27663	31841	36018
0.3	4744	4519	8677	12835	16993	21151	25309	29466	33624	37782
0.2	6889	6439	10577	14716	18854	22993	27131	31270	35408	39547
0.1	9033	8358	12477	16596	20716	24835	28954	33073	37192	41311
0.0	11178	10278	14302	18327	22352	26377	30401	34426	38451	42475

		Horizontal Angle			
		2.7	2.8	2.9	3.0
Vertical Angle	3.5	12129	11998	11867	11735
	3.4	12921	12780	12638	12496
	3.3	13713	13561	13409	13257
	3.2	14504	14342	14180	14018
	3.1	15296	15124	14952	14779
	3.0	16088	15905	15723	15540
	2.9	16880	16687	16494	16301
	2.8	17671	17468	17265	17063
	2.7	18463	18250	18037	17824
	2.6	19255	19031	18808	18585
	2.5	20046	19813	19579	19346
	2.4	20838	20594	20350	20107
	2.3	21630	21376	21122	20868
	2.2	22421	22157	21893	21629
	2.1	23213	22939	22664	22390
	2.0	24005	23720	23435	23151
	1.9	24796	24502	24207	23912
	1.8	25588	25283	24978	24673
	1.7	26380	26065	25749	25434
	1.6	27172	26846	26520	26195
1.5	27963	27627	27292	26956	
1.4	28755	28409	28063	27717	
1.3	29547	29190	28834	28478	
1.2	30338	29972	29605	29239	
1.1	31130	30753	30377	30000	
1.0	31300	30867	30433	31000	
0.9	31470	30980	30490	30000	
0.8	33215	32727	32238	31750	
0.7	34960	34473	33987	33500	
0.6	36705	36220	35735	35250	
0.5	38450	37967	37483	37000	
0.4	40195	39713	39232	38750	
0.3	41940	41460	40980	40500	

	0.2	43685	43207	42728	42250
	0.1	45430	44953	44477	44000
	0.0	46500	46000	45500	45000

In this area of reduced intensity, NHTSA would check to ensure that the applicable Table XIX minima and maxima are met. For this area of the beam pattern, we would check the following lines within the lower beam requirements.

- 1.5U 1R to 3R Min 200 cd
- 1.5U 1R to R Max 1,400 cd
- 0.5U 1R to 3R Max 2,700 cd

NHTSA would scan along 1.5 U to determine at what location the 1.5 U line begins to fail the lower beam photometric requirements. This establishes the beginning of the transition zone. In the hypothetical case shown above, the lower beam meets these requirements at 1.2R [1,027] (where we asked for an area of reduced intensity) and continues to comply at 1.3R [1,027] continuing right until 1.5U, 1.9R [4,020] where it fails the Maximum 1,400 cd limit. So, for this case the transition zone begins at 1.9 R. Similarly, the 0.5 U line complies with the lower beam at 1.2 R [550 cd]. The 0.5 U line continues to comply until, again, 1.9R. Considering this, the transition zone begins at 1.9R and can continue for no more than 1 degree, or through the location of 2.9R. As such, upper beam points extending past this location must be met. As such, the beam pattern must meet the upper beam test point 1U, 3R which requires a minimum

of 5,000 cd for a UB2 lamp. In this case, the value is 31,000 and therefore compliant with the area of unreduced intensity tested at that location.

Additionally, the upper beam point H, 3R minimum of 15,000 must be met along with all the upper beam points at 6R, 9R, 12R and all points left of V. A 0.25 degree re-aim is permitted in S14.2.5.5.

Considering the left edge of the area of reduced intensity, we would scan along the 1.5 U and 0.5 U right side lines and discover that the transition zone begins at 0.4 degrees R (traveling to the left). As such, the transition zone is permitted to extend 1 degree to the left from the left edge, or through 0.5 degrees L. The ADB pattern is not required to produce a compliant upper beam at the test point location of H-V as that may still be within the transition zone. If, however, an ADB beam pattern is produced with the left edge of the transition zone beginning at an angle greater than 1 degree R, the upper beam H-V point must be met for the area of unreduced intensity.

This example also demonstrates how, although no photometry requirements apply to the transition zone, the photometry in the transition zone is not unconstrained. In this example, the edge of the area of reduced intensity is at 1.8R. That means that it must be at least

200 cd but not more than 1400 cd. At the 3R point it must be at least 5,000 cd. The transition zone will be between these two points. With respect to potential concerns, illuminance above 1,400 cd is not the concern, some exceedance is expected as the light transitions. It might be a concern if the intensity drops below 200 cd, however, this is very unlikely. As the commenters point out, it is difficult physically, and not preferred by drivers to have such extreme cutoffs. There is no reason for a manufacturer to allow the intensity to drop below 200 cd through the transition zone.

Appendix C. ADB Performance With Motorcycle Test Fixture

Our testing showed consistently poor performance when the ADB system was tested against the motorcycle fixture and lamps we are finalizing.²⁴⁶ See Table C.1. The agency is concerned that if ADB systems do not adequately react to motorcycles in the real world that any safety benefits provided by ADB introduction could be negated by additional glare related risk to motorcyclists. Many of the failures listed below are not attributable to headlamp beam pattern design but are fundamental failures of the ADB system to react to the motorcycle lamps installed on the test fixture.

TABLE C.1—ADB PERFORMANCE WITH FINAL RULE MOTORCYCLE FIXTURE

			15.0–29.9	30.0–59.9	60.0–119.9	120.0–220.0
Oncoming	Straight	61	PASS	PASS	PASS	FAIL.
Same Direction	Straight	61	PASS	PASS	PASS.	
Oncoming	85-L	26	FAIL	FAIL.		
Oncoming	210-L	41	PASS	FAIL	FAIL	PASS.
Same Direction	210-L	41	FAIL	FAIL	FAIL.	
Oncoming	210-R	41	PASS	FAIL.		
Oncoming	335-L	51	PASS	PASS	FAIL	FAIL.
Oncoming	335-R	51	PASS	FAIL	FAIL.	

The plots below (Figure C.1) are representative of the types of failures we observed when testing. That is, the ADB

system was often late in reacting to the test fixture.

²⁴⁶ As mentioned earlier, in its recent revisions to SAE J3069, SAE revised the specifications for the placement of the illuminance meters (corresponding to two side-view mirrors) on the same direction motorcycle fixture so that they are

now 0.4 m from the centerline of the rear position lamp as opposed to 0.2 m. This change would not be expected to meaningfully impact our test results because the vehicle we tested did not produce a particularly narrow reduced area as a result of

recognizing a motorcycle as compared to a passenger car. As such, a 200 mm horizontal difference would have no meaningful impact on the applicability of the research.

Figure C.1. ADB performance with final rule motorcycle fixture

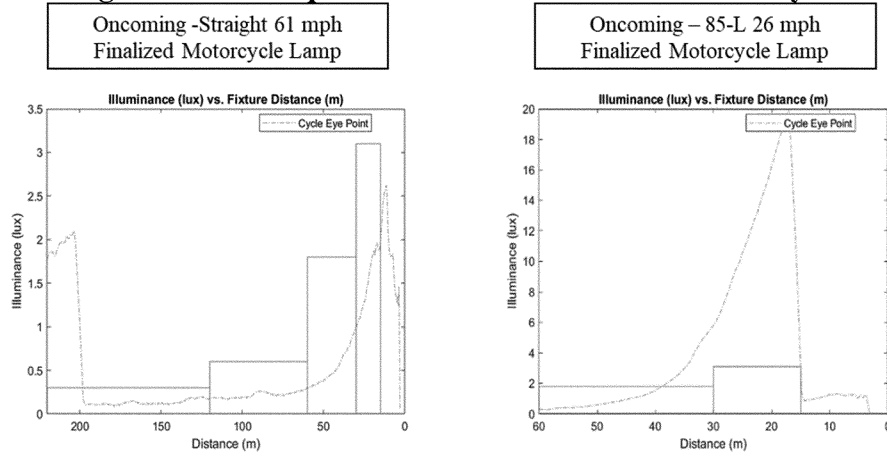

While we are confident in the realism of the finalized test procedure, we did consider potential sources of variation within the test to see if the safety need and practicality of the test could be better optimized. As part of this

investigation, we considered the lamps that are installed on the fixture and compared the ADB systems performance using the lamps specified in SAE J3069. See Table C.2 and Figure C.1. The motorcycle lamps we have chosen are

not the source of the system’s lack of performance as similar failures were observed when using the SAE specified lamps.

TABLE C.2—ADB PERFORMANCE WITH SAE J3069 MOTORCYCLE FIXTURE

			15.0–29.9	30.0–59.9	60.0–119.9	120.0–220.0
Oncoming	Straight	61	PASS	PASS	FAIL	FAIL.
Same Direction	Straight	61	PASS	PASS	PASS.	
Oncoming	85-L	26	FAIL	FAIL.		
Oncoming	210-L	41	PASS	PASS	FAIL	PASS.
Same Direction	210-L	41	FAIL	FAIL	FAIL.	
Oncoming	210-R	41	PASS	PASS.		
Oncoming	335-L	51	PASS	PASS	FAIL	FAIL.
Oncoming	335-R	51	PASS	PASS	FAIL.	

Figure C.2. ADB performance with SAE J3069 motorcycle fixture

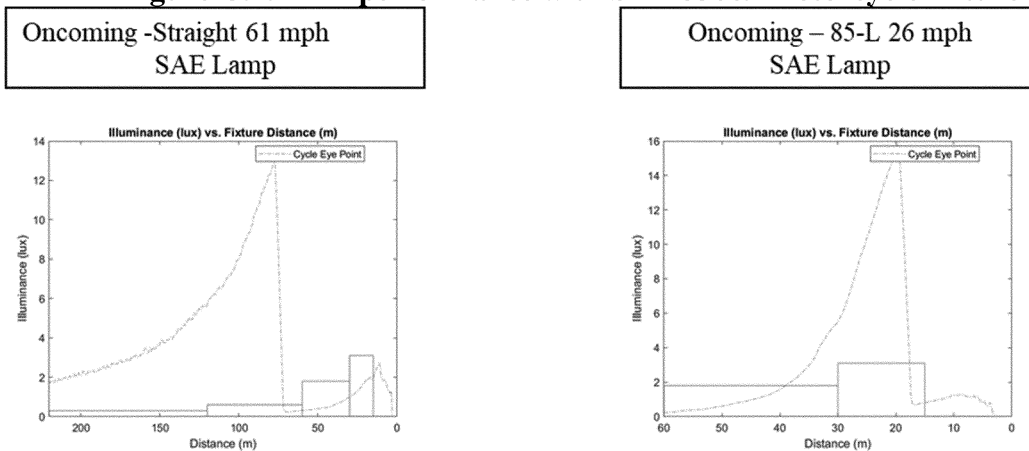

We also considered if the fixture itself was a contributing factor in the system’s lack of performance when encountering motorcycles. This does not seem to be the case based on the 2015 research, which exposed those ADB systems, installed to a complete three-wheel motorcycle. Some of those vehicles also demonstrated a lack of ability to react to

the motorcycle stimulus. That research observed that “Motorcycle scenario values . . . show, on average, the Audi headlighting system produced substantially higher glare in the 30 to 120 m range, up to approximately 9 times greater than that seen for lower beam mode (quotient values ranging from 6.13 to 9.69) and “preceding

motorcycle scenarios appeared to challenge ADB’s ability to maintain glare within derived lower beam limit values. In both the stationary and moving preceding motorcycle scenarios, ADB mode for all four test vehicles showed illuminance levels exceeding lower beam levels and exceeding lower

beam glare limit values in at least one distance range.”²⁴⁷

Although, as discussed previously, we do not believe that the SAE test adequately replicates the real world, we

also considered how well the vehicle we tested performed on the SAE J3069 test.

Overall, it performed better against the SAE J3069 test than the finalized test,

however it did have dramatic failures on that test well. Figure C.3 depicts a sample of these failures.

BILLING CODE 4910-59-C

Figure C.3. Examples of ADB failures when tested against the SAE J3069 motorcycle fixtures

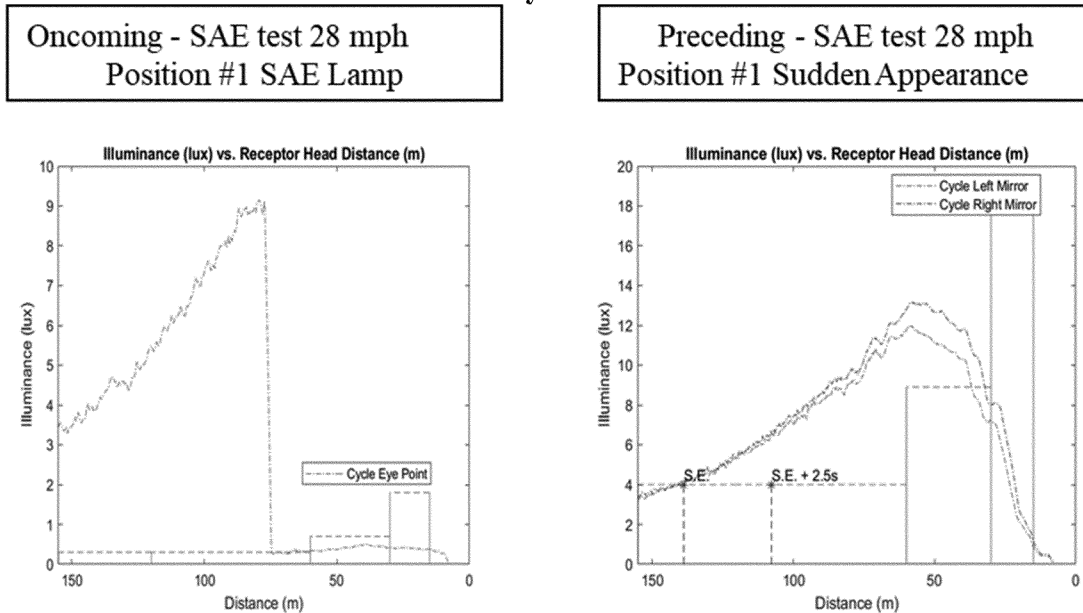

In conclusion, the agency has determined that ADB systems must protect motorcyclist against increases in glare in the same way as other motor vehicle drivers. We have considered the ability of ADB systems to achieve the

finalized level of performance but are unwilling to degrade overall safety. As such, we are finalizing today’s rule to include a fixture with a specified motorcycle headlamp and a taillamp and testing ADB systems using the same

real-world geometries for the motorcycle fixture as for the car and truck fixture.

Appendix D. List of Comments Cited in Preamble

Commenter	Comment ID
AAA	NHTSA-2018-0090-0158.
Alliance for Automotive Innovation	NHTSA-2018-0090-0219.
Alliance of Automobile Manufacturers	NHTSA-2018-0090-0138.
Association of Global Automakers	NHTSA-2018-0090-0182.
Automotive Lighting North America	NHTSA-2018-0090-0068.
Competitive Enterprise Institute	NHTSA-2018-0090-0145.
Consumer Reports	NHTSA-2018-0090-0191.
Ford Motor Company	NHTSA-2018-0090-0162.
General Motors	NHTSA-2018-0090-0181.
GTB—The International Automotive Lighting and Light Signalling Expert Group	NHTSA-2018-0090-0070.
Harley-Davidson Motor Company	NHTSA-2018-0090-0148.
HELLA GmbH & Co. KGaA	NHTSA-2018-0090-0085.
Honda (American Honda Motor Company)	NHTSA-2018-0090-0179.
Insurance Institute for Highway Safety	NHTSA-2018-0090-0149.
International Organization of Motor Vehicle Manufacturers	NHTSA-2018-0090-0089.
Intertek	NHTSA-2018-0090-0143.
Koito Manufacturing Company	NHTSA-2018-0090-0173.
League of American Bicyclists	NHTSA-2018-0090-0157.
Mercedes-Benz USA	NHTSA-2018-0090-0147.
Mobileye, An Intel company	NHTSA-2018-0090-0140.
Montgomery, Bryan	NHTSA-2018-0090-0069.
Motor & Equipment Manufacturers Association	NHTSA-2018-0090-0175.
NAFA Fleet Management Association	NHTSA-2018-0090-0067.
North American Lighting	NHTSA-2018-0090-0163.
Osram Sylvania	NHTSA-2018-0090-0177.
Peterson, Brent	NHTSA-2018-0090-0030.
Robert Bosch	NHTSA-2018-0090-0159.

²⁴⁷ 2015 ADB Test Report, pp. 109, 114.

Commenter	Comment ID
SAE International	NHTSA-2018-0090-0167.
Seastrunk, Jay	NHTSA-2018-0090-0200.
SL Corporation	NHTSA-2018-0090-0183.
Society of Motor Manufacturers and Traders	NHTSA-2018-0090-0156.
Stanley Electric Company	NHTSA-2018-0090-0189.
Subaru	NHTSA-2018-0090-0217.
Texas Instruments	NHTSA-2018-0090-0161.
Toyota Motor North America	NHTSA-2018-0090-0172.
Transportation Safety Equipment Institute	NHTSA-2018-0090-0193.
Truck and Engine Manufacturers Association	NHTSA-2018-0090-0165.
United Drive-In Theatre Owners Association	NHTSA-2018-0090-0153.
Valeo Lighting Systems	NHTSA-2018-0090-0142.
Victor Hunt	NHTSA-2018-0090-0028.
Volkswagen Group of America	NHTSA-2018-0090-0154.
Zoox	NHTSA-2018-0090-0178.

List of Subjects in 49 CFR Part 571

Imports, Motor vehicle safety, Motor vehicles, and Tires.

In consideration of the foregoing, NHTSA amends 49 CFR part 571 as set forth below.

PART 571—FEDERAL MOTOR VEHICLE SAFETY STANDARDS

■ 1. The authority citation for part 571 of title 49 continues to read as follows:

Authority: 49 U.S.C. 322, 30111, 30115, 30117, 30166; delegation of authority at 49 CFR 1.95.

- 2. Amend § 571.108 by:
 - a. Adding, in alphabetical order, definitions of “Adaptive driving beam,” “Headlighting system midpoint” and “Transition zone” to paragraph S4;
 - b. Revising the definition of “Semiautomatic headlamp beam switching device” in paragraph S4;
 - c. Revising paragraphs S9.4.1, S9.4.1.1, S9.4.1.2, S9.4.1.3, S9.4.1.4, and S9.4.1.5;
 - d. Adding paragraphs S9.4.1.5.1 through S9.4.1.5.3 in numerical order;
 - e. Revising paragraph S9.4.1.6;
 - f. Adding paragraphs S9.4.1.6.1 through S9.4.1.6.5 in numerical order;
 - g. Removing S9.4.1.7;
 - h. Revising the introductory text of paragraph S9.5;
 - i. Revising paragraphs S10.14.1, S10.15.1, S10.16.1, S10.18.8.1.2, and S10.18.8.2.1;
 - j. Adding paragraphs S14.9.3.12 through S14.9.3.12.6.3;
 - k. Revising the entries for “Lower Beam Headlamps” and “Upper Beam Headlamps” in table I-a and table I-c;
 - l. Adding tables XXI and XXII, and figures 23 through 30 in numerical order; and
 - m. Removing the appendix to the section.

The revisions and additions read as follows:

§ 571.108 Standard No. 108; Lamps, reflective devices, and associated equipment.

* * * * *

S4 Definitions

Adaptive driving beam means a long-range light beam for forward visibility, which automatically modifies portions of the projected light to reduce glare to traffic participants on an ongoing, dynamic basis.

* * * * *

Headlighting system midpoint means the intersection of a horizontal plane through the test vehicle’s headlamp light sources, a vertical plane through the test vehicle’s headlamp light sources and a vertical plane through the test vehicle’s centerline.

* * * * *

Semiautomatic headlamp beam switching device is one which provides either automatic or manual control of beam switching at the option of the driver. When the control is automatic the headlamp beams switch automatically. When the control is manual, the driver may obtain either the lower beam or the upper beam manually regardless of the conditions ahead of the vehicle.

* * * * *

Transition zone means the portion of an adaptive driving beam that occurs between an area of reduced intensity and an area of unreduced intensity.

* * * * *

S9.4.1 *Semiautomatic headlamp beam switching devices.* As an alternative to S9.4, a vehicle may also be equipped with a semiautomatic means of switching beams that complies with 9.4.1.1 through S9.4.1.4 and either 9.4.1.5 (Option 1) or 9.4.1.6 (Option 2).

S9.4.1.1 *Operating instructions.* Each semiautomatic headlamp switching device must include operating instructions to permit a driver to operate the device correctly,

including: How to turn the automatic control on and off; how to adjust the sensitivity control (for Option 1 and if provided for Option 2); and any other specific instructions applicable to the device.

S9.4.1.2 *Manual override.* The device must include a means convenient to the driver for switching the beam from the one provided.

S9.4.1.3 *Fail safe operation.* A failure of the automatic control portion of the device must not result in the loss of manual operation and control of the upper and lower beams.

S9.4.1.4 *Automatic dimming indicator.* There must be a convenient means of informing the driver when the device is controlling the headlamps automatically. For headlighting systems certified to Option 1, the device shall not affect the function of the upper beam indicator light.

S9.4.1.5—*Option 1 (Semiautomatic headlamp beam switching devices other than Adaptive Driving Beam systems).*

S9.4.1.5.1 *Lens accessibility.* The device lens must be accessible for cleaning while the device is installed on a vehicle.

S9.4.1.5.2 *Mounting height.* The center of the device lens must be mounted no less than 24 inches above the road surface.

S9.4.1.5.3 *Physical tests.* Each semiautomatic headlamp beam switching device must be designed to conform to all applicable performance requirements of S14.9.3.11.

S9.4.1.6—*Option 2 (Adaptive Driving Beam systems).*

S9.4.1.6.1 The system must be capable of detecting system malfunctions (including but not limited to sensor obstruction).

S9.4.1.6.2 If the system detects a malfunction that prevents the system from operating in automatic mode safely and in conformance with these requirements, the headlighting system must operate in manual mode until the

malfunction is corrected and must provide the driver with a visible warning that the malfunction exists.

S9.4.1.6.3 When operating in manual mode, the system must provide only switching between lower and upper beams as provided in S9.4.

S9.4.1.6.4 When operating in automatic mode, the system must only switch between lower, upper, and adaptive driving beams. The adaptive driving beams must be designed to conform to the requirements of this section.

S9.4.1.6.4.1 The adaptive driving beams must consist only of area(s) of reduced intensity, area(s) of unreduced intensity, and transition zone(s).

S9.4.1.6.4.2 The adaptive driving beams must be designed to conform to the photometry requirements of Table XXI when tested according to S14.9.3.12, and, for replaceable bulb headlighting systems, when using any replaceable light source designated for use in the system.

S9.4.1.6.4.3 In an area of reduced intensity, the adaptive driving beams must be designed to conform to the photometric intensity requirements of Table XIX as specified in Table II for the specific headlamp unit and aiming method, when tested according to the procedure of S14.2.5, and, for replaceable bulb headlighting systems, when using any replaceable light source designated for use in the system.

S9.4.1.6.4.4 In an area of unreduced intensity, the adaptive driving beams must be designed to conform to the photometric intensity requirements of Table XVIII as specified in Table II for the specific headlamp unit and aiming method, when tested according to the procedure of S14.2.5, and, for replaceable bulb headlighting systems, when using any replaceable light source designated for use in the system.

S9.4.1.6.4.5 A transition zone not to exceed 1.0 degree in either the horizontal or vertical direction is permitted between an area of reduced intensity and an area of unreduced intensity. The Table XVIII and Table XIX photometric intensity requirements do not apply in a transition zone, except that the maximum at H-V in Table XVIII as specified in Table II for the specific headlamp unit and aiming method may not be exceeded at any point in a transition zone.

S9.4.1.6.4.6 For vehicle speeds below 32 kph (20 mph), the system must provide only lower beams (unless manually overridden according to S9.4.1.2).

S9.4.1.6.4.7 The adaptive driving beams must not be energized

simultaneously with the lower or upper beams except as provided in Table II.

S9.4.1.6.5 The adaptive driving beams may be provided by any combination of headlamps or light sources, provided parking lamps are installed. If parking lamps meeting the requirements of this standard are not required according to Table I and are not installed, the adaptive driving beams may be provided using any combination of headlamps but must include the outermost installed headlamps to show the overall width of the vehicle.

* * * * *

S9.5 *Upper beam headlamp indicator.* Each vehicle must have a means for indicating to the driver when the upper beams of the headlighting system are activated. The upper beam headlamp indicator is not required to be activated when an Adaptive Driving Beam system is operating in automatic mode.

* * * * *

S10.14.1 *Installation.* An integral beam headlighting system must consist of the correct number of designated headlamp units as specified for the applicable system in Table II-c. The units must have their upper and lower beams activated as specified in Table II-c, and their adaptive driving beams (if so equipped) activated as specified in S9.4.1.6.5. A system must provide in total not more than two upper beams, two lower beams, and, optionally, two adaptive driving beams.

* * * * *

S10.15.1 *Installation.* A replaceable bulb headlighting system must consist of either two or four headlamps as specified for the applicable system in Table II-d. The headlamps must have their upper and lower beams activated as specified in Table II-d, and their adaptive driving beams (if so equipped) activated as specified in S9.4.1.6.5. A system must provide in total not more than two upper beams, two lower beams, and, optionally, two adaptive driving beams, and must incorporate not more than two replaceable light sources in each headlamp.

* * * * *

S10.16.1 *Installation.* A combination headlighting system must consist of the correct number of designated headlamp units as specified for the applicable system in Table II-b. The units must have their upper and lower beams activated as specified in Table II-b, and their adaptive driving beams (if so equipped) activated as specified in S9.4.1.6.5. A system must provide in total not more than two upper beams, two lower beams, and, optionally, two

adaptive driving beams. When installed on a motor vehicle, the headlamps (or parts thereof) that provide the lower beam must be of the same type and provide a symmetrical effective projected luminous lens area when illuminated.

* * * * *

S10.18.8.1.2 *Horizontal aim.* The VHAD must include references and scales relative to the longitudinal axis of the vehicle necessary to assure correct horizontal aim for photometry and aiming purposes. A "0" mark must be used to indicate alignment of the headlamps relative to the longitudinal axis of the vehicle. In addition, an equal number of graduations from the "0" position representing equal angular changes in the axis relative to the vehicle axis must be provided. If the horizontal VHAD is part of an adaptive driving beam system, S10.18.8.1.2.1 through S10.18.8.1.2.4 are not required.

* * * * *

S10.18.8.2.1 Instructions must be provided either on a label permanently affixed to the vehicle adjacent to the VHAD, or in the operator's manual, advising the vehicle owner what to do if the headlighting system requires aiming using the VHAD.

* * * * *

S14.9.3.12 *Test for compliance with adaptive driving beam photometry requirements.*

S14.9.3.12.1 *Test scenarios.*

S14.9.3.12.1.1 Any of the scenarios specified in Table XXII and Figures 27, 28, 29, and 30 may be tested. Where a range of values is specified, the vehicle shall be able to meet the requirements at all values within the range.

S14.9.3.12.1.2 Any speed that conforms to the speeds specified for that test scenario will be selected for the test vehicle. The vehicle will achieve and maintain this speed ± 0.45 m/s (1 mph) prior to reaching, and then throughout, the measurement distance range specified for that scenario. Once the test speed is achieved and maintained, no sudden steering inputs, acceleration, braking, or anything that causes a change in vehicle pitch that affects the results of the test shall occur.

S14.9.3.12.1.3 For test scenarios involving curves, any radius within the allowable range specified for that test scenario may be selected. The curve shall nominally consist of a constant radius path and be referenced to the headlighting system midpoint. The actual path of the test vehicle shall not deviate from the nominal path by more than ± 0.5 m throughout the measurement distance range.

S14.9.3.12.1.4 The test vehicle shall be driven within the lane and will not change lanes.

S14.9.3.12.1.5 The measurement distance is the linear distance measured from the headlighting system midpoint to the most forward point of the relevant photometric receptor head mounted on the test fixture.

S14.9.3.12.1.6 The illuminance values for each photometer, the instantaneous pitch of the test vehicle, and the measurement distance shall be recorded and synchronized throughout the measurement distance range specified for that scenario.

S14.9.3.12.2 *Compliance criteria.* The maximum calculated illuminance for each measurement distance interval specified in Table XXI that is applicable to the scenario being tested, as determined according to S14.9.3.12.2.1, shall not exceed the applicable maximum illuminance listed in Table XXI.

S14.9.3.12.2.1 The maximum calculated illuminance for each measurement distance interval specified in Table XXI that is applicable to the scenario being tested will be the highest illuminance recorded in that distance interval, excluding any illuminance value(s) that meet any of the following conditions:

(a) A single illuminance value exceeding the applicable maximum illuminance in Table XXI (*i.e.*, the illuminance value is not immediately preceded or followed by an illuminance value exceeding the applicable maximum illuminance); or

(b) consecutive illuminance values occurring over a span of no more than 0.1 seconds exceeding the applicable maximum illuminance in Table XXI; or

(c) any illuminance values collected while the vehicle pitch exceeds the average pitch recorded throughout the entire measurement distance range specified for that scenario in Table XXII by more than 0.3 degrees.

S14.9.3.12.3 *Stimulus test fixtures.* Testing shall be conducted using the stimulus test fixtures specified in this section and Figures 23 through 26.

S14.9.3.12.3.1 *Headlamps.* The headlamps specified in Fig. 23 (Opposite Direction Car/Truck) shall be a right- and left-hand 2018 Ford F-150 Halogen headlamp (part # KL3Z13008C KL3Z13008D) using any replaceable light source designated for use in the system and, separately, a right- and left-hand 2018 Toyota Camry LED headlamp (part # 8111006C40/8115006C40). The headlamps specified in Fig. 25 (Opposite Direction Motorcycle) shall be a 5.75-inch round headlamp kit from a 2018 Harley Davidson Sportster (part

#68297-05B) using an HB2 replaceable light source. Each headlamp shall energize the lower beam only, powered at 12.8 volts DC \pm 500 mV when measured at the lamp terminals, and shall have been energized for a minimum of 5 minutes before each test trial. The measurement locations specified in Figures 23 and 25 shall be measured to the optical axis marking of the headlamps.

S14.9.3.12.3.2 *Taillamps.* The taillamps specified in Fig. 24 (Same Direction Car/Truck) shall be a right and left-hand 2018 Ford F-150 incandescent rear combination lamp (part # JL3Z13405H/JL3Z13404H) and, separately, a right and left-hand 2018 Toyota Camry rear combination lamp (part # 81550-06730/81560-06730). The taillamps specified in Fig. 26 (Same Direction Motorcycle) shall be a 2018 Harley Davidson Roadster layback LED taillamp assembly (part #67800355). The taillamps shall be powered at 12.8 volts DC \pm 500 mV when measured at the lamp terminals and shall have been energized for a minimum of 5 minutes before each test trial. The measurement locations specified in Figures 24 and 26 shall be measured to the center of the taillamp.

S14.9.3.12.3.3 *Photometers.* Photometers must be capable of a minimum measurement unit of 0.01 lux. The color response of the photometer must be corrected to that of the 1931 CIE Standard Observer (2-degree) Photopic Response Curve, as shown in the CIE 1931 Chromaticity Diagram (incorporated by reference, see § 571.5), with a cosine correction characteristic within 3%. The photometer lenses on the test fixture shall be clean and free from dirt and debris, and the photometers will be zero-calibrated for each test to account for ambient light. The illuminance values from the photometers shall be collected at a rate of at least 100 Hz and a maximum 25-degree angle of incidence.

S14.9.3.12.3.4 The projection of the fixture lamp's optical axis onto the road surface shall be parallel to a tangent of the road edge at the location of the photometer.

S14.9.3.12.3.5 The test fixture shall be centered in the lane.

S14.9.3.12.4 *Test vehicle preparation.*

S14.9.3.12.4.1 Tires on the test vehicle shall be inflated to the manufacturer's recommended cold inflation pressure \pm 7 kPa (1 psi). If more than one recommendation is provided, the tires are inflated to the cold inflation pressure \pm 7 kPa (1 psi) that corresponds to the lowest loaded condition listed.

S14.9.3.12.4.2 Before initiating testing, if the test vehicle is equipped with a fuel tank it shall be filled to approximately 100% of capacity with the appropriate fuel and maintained to at least 75% capacity throughout the testing.

S14.9.3.12.4.3 Headlamps on the test vehicle shall be aimed according to the vehicle manufacturer's instructions. The test vehicle shall be loaded within \pm 5 kg of the total vehicle weight during track testing prior to aiming the adaptive driving beam headlamps.

S14.9.3.12.4.4 The adaptive driving beam system shall be adjusted according to the manufacturer's instructions.

S14.9.3.12.4.5 To the extent practicable, adaptive driving beam system sensors and the windshield on the test vehicle (if an adaptive driving beam system sensor is behind the windshield) shall be clean and free of dirt and debris.

S14.9.3.12.4.6 The headlamp lenses of the test vehicle shall be clean and free from dirt and debris.

S14.9.3.12.4.7 The adaptive driving beam system shall be activated according to the manufacturer's instructions and all other independently controlled lamps, such as fog lamps, shall be turned off.

S14.9.3.12.5 *Test road*

S14.9.3.12.5.1 The test road shall have a longitudinal grade (slope) that does not exceed 2%.

S14.9.3.12.5.2 The lane width shall be any width from 3.05 m (10 ft) to 3.66 m (12 ft).

S14.9.3.12.5.3 The lanes shall be adjacent to one another.

S14.9.3.12.5.4 The tests are conducted on a uniform, solid-paved surface.

S14.9.3.12.5.5 The test road surface may be concrete or asphalt and shall not be bright white.

S14.9.3.12.5.6 The test road surface may have pavement markings but shall be free of retroreflective material or elements that affect the outcome of the test.

S14.9.3.12.6 *Other test parameters and conditions*

S14.9.3.12.6.1 Testing shall be conducted on dry pavement and with no precipitation.

S14.9.3.12.6.2 Testing shall be conducted when the ambient illumination at the test road as recorded by the photometers is at or below 0.2 lux.

S14.9.3.12.6.3 Photometer data signals shall be passed through a low-pass filter with a cutoff frequency of 35 Hz.

* * * * *

TABLE I-a—REQUIRED LAMPS AND REFLECTIVE DEVICES

Lighting device	Number and color	Mounting location	Mounting height	Device activation
All Passenger Cars, Multipurpose Passenger Vehicles (MPV), Trucks, and Buses				
Lower Beam Headlamps	White, of a headlighting system listed in Table II.	On the front, at the same height, symmetrically about the vertical centerline, as far apart as practicable.	Not less than 55.9 cm nor more than 137.2 cm.	The wiring harness or connector assembly of each headlighting system must be designed so that only those light sources intended for meeting lower beam photometrics are energized when the beam selector switch is in the lower beam position, and that only those light sources intended for meeting upper beam photometrics are energized when the beam selector switch is in the upper beam position, except for certain systems listed in Table II and semi-automatic headlamp beam switching devices certified to S9.4.1.6. Steady burning, except that may be flashed for signaling purposes or (for semiautomatic headlamp beam switching devices certified to S9.4.1.6) vary in intensity for adaptive driving beam functionality.
Upper Beam Headlamps	White, of a headlighting system listed in Table II.	On the front, at the same height, symmetrically about the vertical centerline, as far apart as practicable.	Not less than 22 inches (55.9 cm) nor more than 54 inches (137.2 cm).	
*	*	*	*	*

* * * * *

TABLE I—C—REQUIRED LAMPS AND REFLECTIVE DEVICES

Lighting device	Number and color	Mounting location	Mounting height	Device activation
All Motorcycles				
Lower Beam Headlamps	White, of a headlighting system listed in S10.17.	On the front, at the same height, symmetrically about the vertical centerline, as far apart as practicable. See additional requirements in S10.17.1.1, S10.17.1.2, and S10.17.1.3.	Not less than 22 inches (55.9 cm) nor more than 54 inches (137.2 cm).	The wiring harness or connector assembly of each headlighting system must be designed so that only those light sources intended for meeting lower beam photometrics are energized when the beam selector switch is in the lower beam position, and that only those light sources intended for meeting upper beam photometrics are energized when the beam selector switch is in the upper beam position, except for certain systems listed in Table II and semi-automatic headlamp beam switching devices certified to S9.4.1.6. Steady burning, except that may be flashed for signaling purposes or (for semiautomatic headlamp beam switching devices certified to S9.4.1.6) vary in intensity for adaptive driving beam functionality. The upper beam or the lower beam, but not both, may be wired to modulate from a higher intensity to a lower intensity in accordance with S10.17.5.
Upper Beam Headlamps	White, of a headlighting system listed in S10.17.	On the front, at the same height, symmetrically about the vertical centerline, as far apart as practicable. See additional requirements in S10.17.1.1, S10.17.1.2, and S10.17.1.3.	Not less than 55.9 cm nor more than 137.2 cm.	
*	*	*	*	*

* * * * *

TABLE XXI—ADAPTIVE DRIVING BEAM PHOTOMETRY REQUIREMENTS (1)

Measurement distance interval (m)	Maximum illuminance Opposite direction (lux)	Maximum illuminance same direction (lux)
Greater than or equal to 15.0 and less than 30.0	3.1	18.9
Greater than or equal to 30.0 and less than 60.0	1.8	18.9
Greater than or equal to 60.0 and less than 120.0	0.6	4.0
Greater than or equal to 120.0 and less than or equal to 220	0.3	N/A

(1) For purposes of determining conformance with these specifications, an observed value or a calculated value shall be rounded to the nearest 0.1 lux, in accordance with the rounding method of ASTM Practice E29 Using Significant Digits in Test Data to Determine Conformance with Specifications.

* * * * *

TABLE XXII—ADAPTIVE DRIVING BEAM SYSTEM TEST MATRIX

Scenario No.	Test vehicle speed (kph)	Orientation	Radius of curve (m.)	Curve direction	Superelevation (%)	Measurement distance range (m)
1	96.6–112.7 [60–70 mph]	Opposite Direction	Straight	N/A	0–2	Greater than or equal to 15 and less than or equal to 220.
2	40.2–48.3 [25–30 mph]	Opposite Direction	85–115	Left	0–2	Greater than or equal to 15 and less than 60.
3	64.4–72.4 [40–45 mph]	Opposite Direction	210–250	Left	0–2	Greater than or equal to 15 and less than or equal to 150.
4	80.5–88.5 [50–55 mph]	Opposite Direction	335–400	Left	0–2	Greater than or equal to 15 and less than or equal to 220.
5	64.4–72.4 [40–45 mph]	Opposite Direction	210–250	Right	0–2	Greater than or equal to 15 and less than or equal to 50.
6	80.5–88.5 [50–55 mph]	Opposite Direction	335–400	Right	0–2	Greater than or equal to 15 and less than or equal to 70.
7	96.6–112.7 [60–70 mph]	Same Direction	Straight	N/A	0–2	Greater than or equal to 15 and less than or equal to 100.
8	64.4–72.4 [40–45 mph]	Same Direction	210–250	Left	0–2	Greater than or equal to 15 and less than or equal to 100.

* * * * *

BILLING CODE 4910–59–P

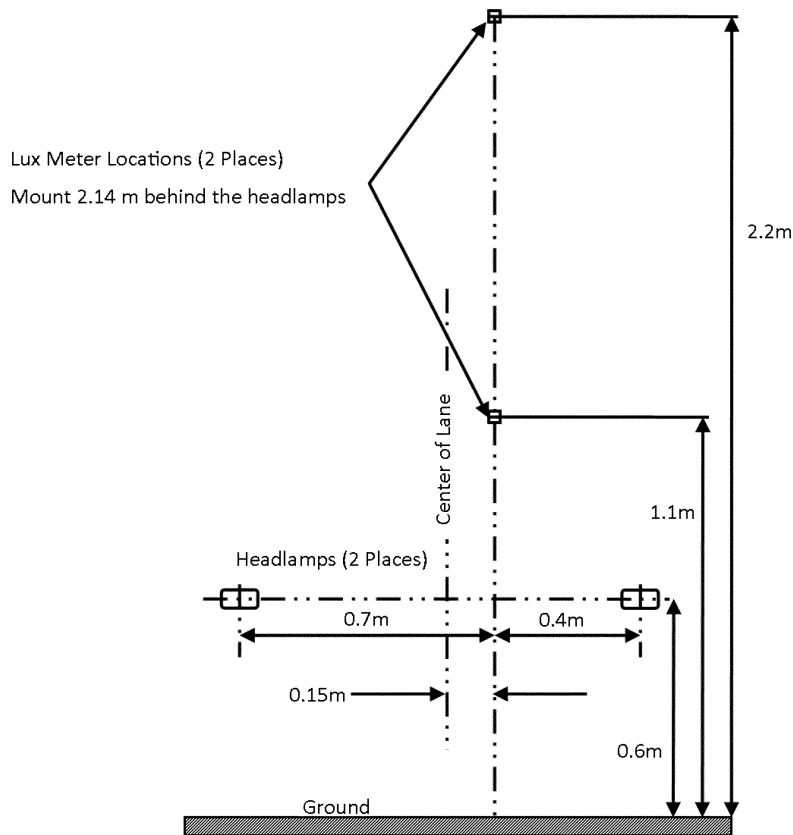

Car / Truck opposite direction stimulus test fixture dimensions

Figure 23

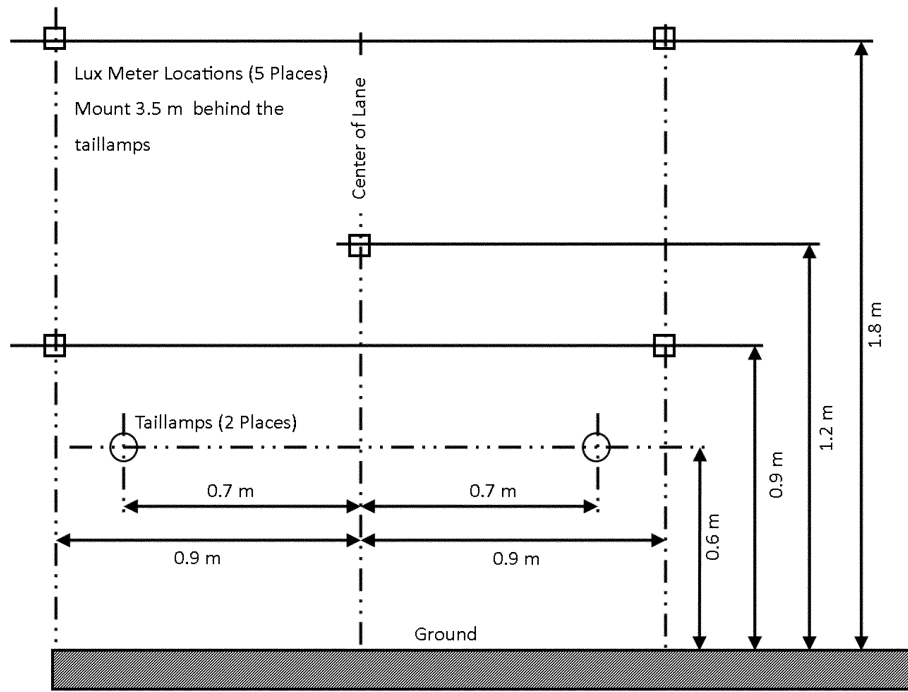

Car / Truck same direction stimulus fixture dimensions

Figure 24

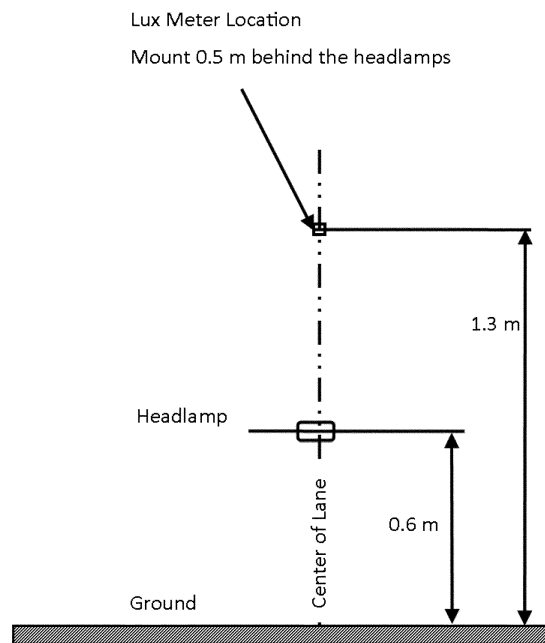

Motorcycle opposite direction stimulus test fixture dimensions

Figure 25

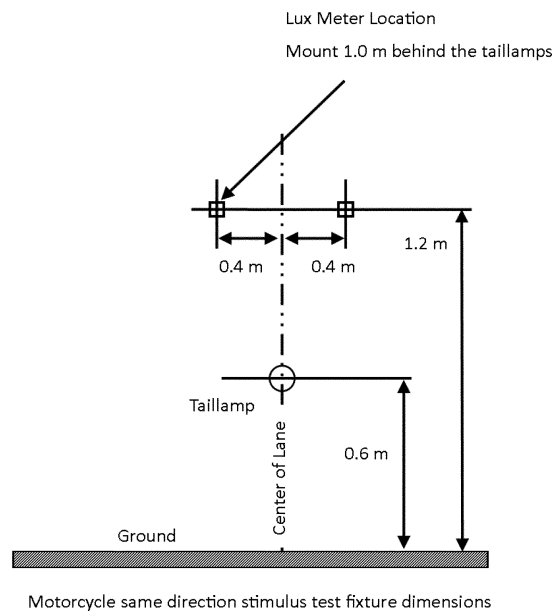
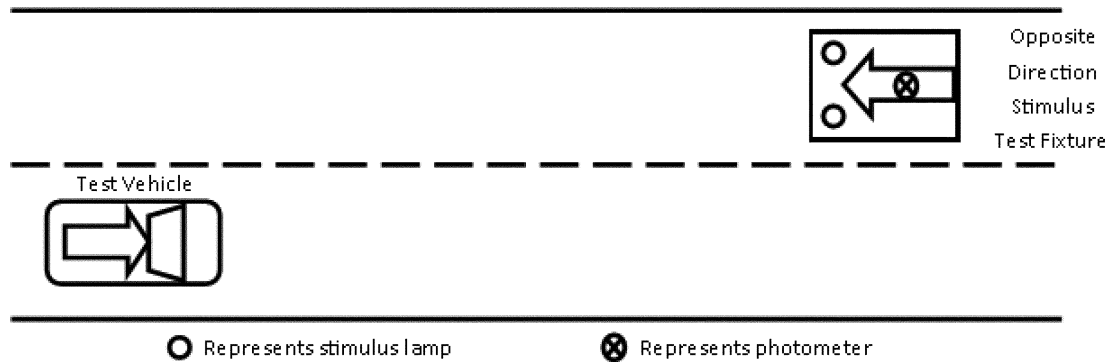
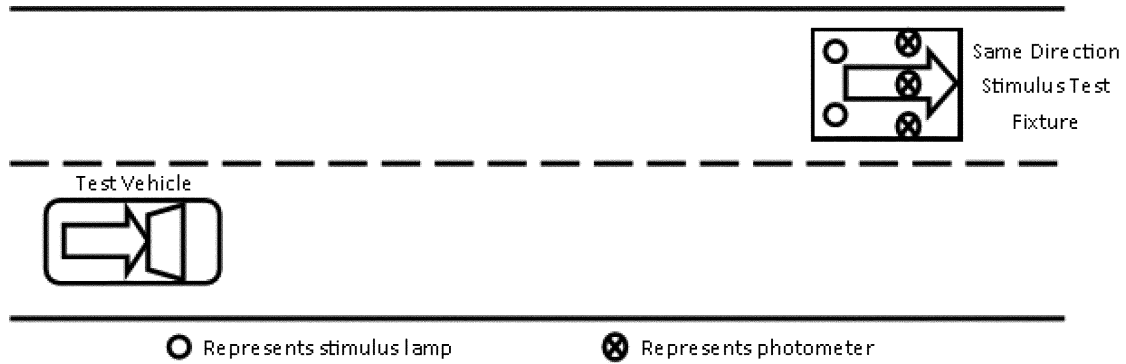

Figure 26



Not to scale. For illustrative purposes only.

Figure 27 Opposite Direction Test Scenarios



Not to scale. For illustrative purposes only.

Figure 28 Same Direction Test Scenarios

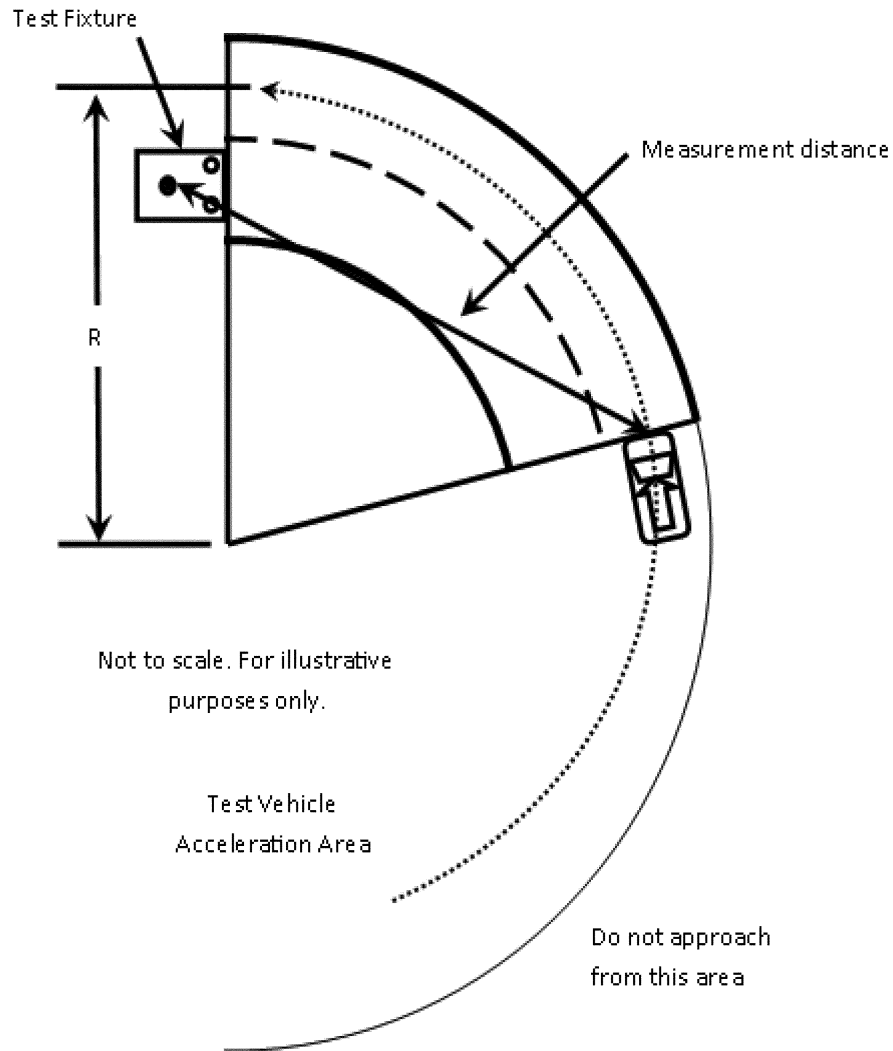

Not to scale. For illustrative purposes only.

Do not approach from this area

Figure 29 Left Curve Test Scenarios

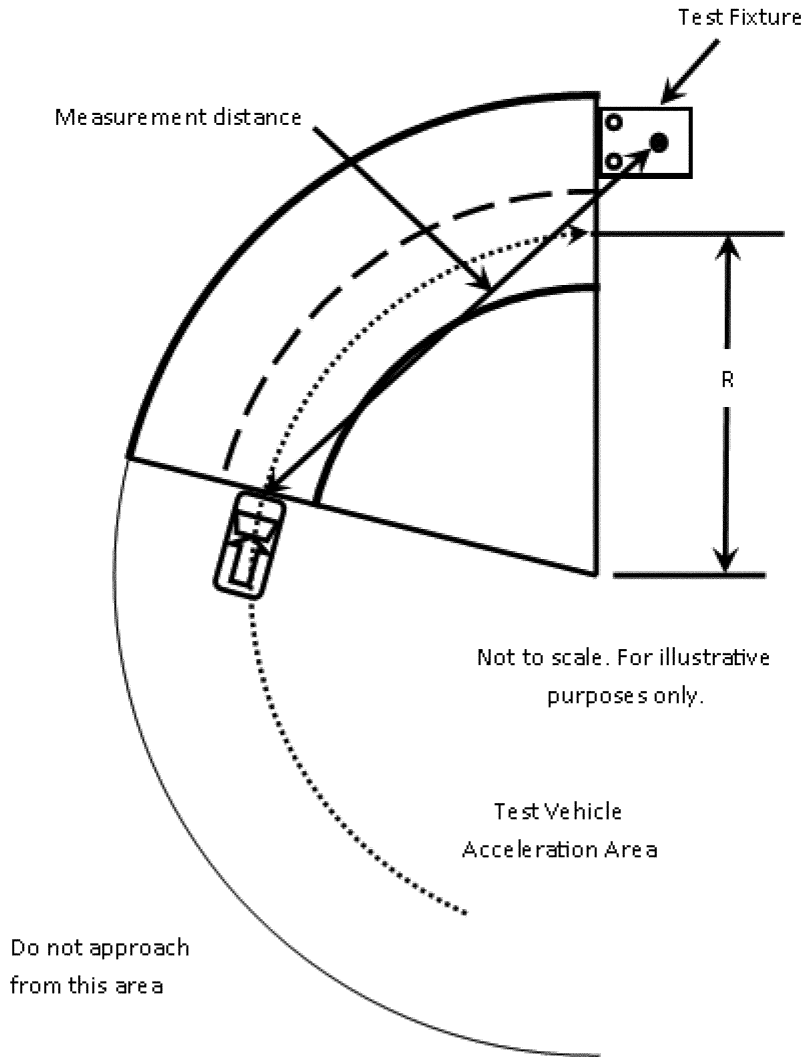

Figure 30 Right Curve Test Scenarios

BILLING CODE 4910-59-C

* * * * *

■ 3. Amend Subpart B by adding Appendix A to § 571.108 to read as follows:

Appendix A to Subpart B to § 571.108 Table of Contents.

571.108 Standard No. 108; Lamps, reflective devices, and associated equipment.

S1 Scope.

S2 Purpose.

S3 Application.

S4 Definitions.

S5 References to SAE publications.

S6 Vehicle requirements.

S6.1 Required lamps, reflective devices, and associated equipment by vehicle type.

S6.1.1 Quantity.

S6.1.1.1 Conspicuity systems.

S6.1.1.2 High-mounted stop lamps.

S6.1.1.3 Truck tractor rear turn signal lamps.

S6.1.1.4 Daytime running lamps.

S6.1.2 Color.

S6.1.3 Mounting location.

S6.1.3.3 License plate lamp.

S6.1.3.4 High-mounted stop lamps.

S6.1.3.4.1 Interior mounting.

S6.1.3.4.2 Accessibility.

S6.1.3.5 Headlamp beam mounting.

S6.1.3.5.1 Vertical headlamp arrangement.

S6.1.3.5.2 Horizontal headlamp arrangement.

S6.1.3.6 Auxiliary lamps mounted near identification lamps.

S6.1.4 Mounting height.

S6.1.4.1 High-mounted stop lamps.

S6.1.5 Activation.

S6.1.5.1 Hazard warning signal.

S6.1.5.2 Simultaneous beam activation.

S6.2 Impairment.

S6.2.3 Headlamp obstructions.

S6.3 Equipment combinations.

S6.4 Lens area, visibility and school bus signal lamp aiming.

- S6.4.1 *Effective projected luminous lens area requirements.*
- S6.4.2 *Visibility.*
- S6.4.3 *Visibility options.*
- S6.4.3(a) *Lens area option.*
- S6.4.3(b) *Luminous intensity option.*
- S6.4.4 *Legacy visibility alternative.*
- S6.4.5 *School bus signal lamp aiming.*
- S6.5 *Marking.*
- S6.5.1 *DOT marking.*
- S6.5.2 *DRL marking.*
- S6.5.3 *Headlamp markings.*
- S6.5.3.1 *Trademark.*
- S6.5.3.2 *Voltage and trade number.*
- S6.5.3.3 *Sealed beam headlamp markings.*
- S6.5.3.4 *Replaceable bulb headlamp markings.*
- S6.5.3.5 *Additional headlamp markings.*
- S6.6 *Associated equipment.*
- S6.6.3 *License plate holder.*
- S6.7 *Replacement equipment.*
- S6.7.1 *General.*
- S6.7.2 *Version of this standard.*
- S7 *Signal lamp requirements.*
- S7.1 *Turn signal lamps.*
- S7.1.1 *Front turn signal lamps.*
- S7.1.1.1 *Number.*
- S7.1.1.2 *Color of light.*
- S7.1.1.3 *Mounting location.*
- S7.1.1.4 *Mounting height.*
- S7.1.1.5 *Activation.*
- S7.1.1.6 *Effective projected luminous lens area.*
- S7.1.1.7 *Visibility.*
- S7.1.1.8 *Indicator.*
- S7.1.1.9 *Markings.*
- S7.1.1.10 *Spacing to other lamps.*
- S7.1.1.10.2 *Spacing measurement for non-reflector lamps.*
- S7.1.1.10.3 *Spacing measurement for lamps with reflectors.*
- S7.1.1.10.4 *Spacing based photometric multipliers.*
- S7.1.1.11 *Multiple compartment lamps and multiple lamps.*
- S7.1.1.11.4 *Lamps installed on vehicles 2032 mm or more in overall width.*
- S7.1.1.12 *Ratio to parking lamps and clearance lamps.*
- S7.1.1.13 *Photometry.*
- S7.1.1.14 *Physical tests.*
- S7.1.2 *Rear turn signal lamps.*
- S7.1.2.1 *Number.*
- S7.1.2.2 *Color of light.*
- S7.1.2.3 *Mounting location.*
- S7.1.2.4 *Mounting height.*
- S7.1.2.5 *Activation.*
- S7.1.2.6 *Effective projected luminous lens area.*
- S7.1.2.7 *Visibility.*
- S7.1.2.8 *Indicator.*
- S7.1.2.9 *Markings.*
- S7.1.2.10 *Spacing to other lamps.*
- S7.1.2.11 *Multiple compartments and multiple lamps.*
- S7.1.2.11.4 *Lamps installed on vehicles 2032 mm or more in overall width.*
- S7.1.2.12 *Ratio to taillamps and clearance lamps.*
- S7.1.2.13 *Photometry.*
- S7.1.2.14 *Physical tests.*
- S7.1.3 *Combined lamp bulb indexing.*
- S7.2 *Taillamps.*
- S7.2.1 *Number.*
- S7.2.2 *Color of light.*
- S7.2.3 *Mounting location.*
- S7.2.4 *Mounting height.*
- S7.2.5 *Activation.*
- S7.2.6 *Effective projected luminous lens area.*
- S7.2.7 *Visibility.*
- S7.2.8 *Indicator.*
- S7.2.9 *Markings.*
- S7.2.10 *Spacing to other lamps.*
- S7.2.11 *Multiple compartments and multiple lamps.*
- S7.2.11.4 *Taillamps installed on vehicles 2032 mm or more in overall width.*
- S7.2.12 *Ratio.*
- S7.2.13 *Photometry.*
- S7.2.14 *Physical tests.*
- S7.3 *Stop lamps.*
- S7.3.1 *Number.*
- S7.3.2 *Color of light.*
- S7.3.3 *Mounting location.*
- S7.3.4 *Mounting height.*
- S7.3.5 *Activation.*
- S7.3.6 *Effective projected luminous lens area.*
- S7.3.7 *Visibility.*
- S7.3.8 *Indicator.*
- S7.3.9 *Markings.*
- S7.3.10 *Spacing to other lamps.*
- S7.3.11 *Multiple compartments and multiple lamps.*
- S7.3.11.4 *Lamps installed on vehicles 2032 mm or more in overall width.*
- S7.3.12 *Ratio to taillamps.*
- S7.3.13 *Photometry.*
- S7.3.14 *Physical tests.*
- S7.3.15 *Combined lamp bulb indexing.*
- S7.4 *Side marker lamps.*
- S7.4.1 *Number.*
- S7.4.2 *Color of light.*
- S7.4.3 *Mounting location.*
- S7.4.4 *Mounting height.*
- S7.4.5 *Activation.*
- S7.4.6 *Effective projected luminous lens area.*
- S7.4.7 *Visibility.*
- S7.4.8 *Indicator.*
- S7.4.9 *Markings.*
- S7.4.10 *Spacing to other lamps.*
- S7.4.11 *Multiple compartments and multiple lamps.*
- S7.4.12 *Ratio.*
- S7.4.13 *Photometry.*
- S7.4.13.2 *Inboard photometry.*
- S7.4.14 *Physical tests.*
- S7.5 *Clearance and identification lamps.*
- S7.5.1 *Number.*
- S7.5.2 *Color of light.*
- S7.5.3 *Mounting location.*
- S7.5.4 *Mounting height.*
- S7.5.5 *Activation.*
- S7.5.6 *Effective projected luminous lens area.*
- S7.5.7 *Visibility.*
- S7.5.8 *Indicator.*
- S7.5.9 *Markings.*
- S7.5.10 *Spacing to other lamps.*
- S7.5.11 *Multiple compartments and multiple lamps.*
- S7.5.12 *Ratio.*
- S7.5.12.1 *Clearance lamps.*
- S7.5.12.2 *Identification lamps.*
- S7.5.13 *Photometry.*
- S7.5.14 *Physical tests.*
- S7.6 *Backup lamps.*
- S7.6.1 *Number.*
- S7.6.2 *Color of light.*
- S7.6.3 *Mounting location.*
- S7.6.4 *Mounting height.*
- S7.6.5 *Activation.*
- S7.6.6 *Effective projected luminous lens area.*
- S7.6.7 *Visibility.*
- S7.6.8 *Indicator.*
- S7.6.9 *Markings.*
- S7.6.10 *Spacing to other lamps.*
- S7.6.11 *Multiple compartments and multiple lamps.*
- S7.6.12 *Ratio.*
- S7.6.13 *Photometry.*
- S7.6.14 *Physical tests.*
- S7.7 *License plate lamps.*
- S7.7.1 *Number.*
- S7.7.2 *Color of light.*
- S7.7.3 *Mounting location.*
- S7.7.4 *Mounting height.*
- S7.7.5 *Activation.*
- S7.7.6 *Effective projected luminous lens area.*
- S7.7.7 *Visibility.*
- S7.7.8 *Indicator.*
- S7.7.9 *Markings.*
- S7.7.10 *Spacing to other lamps.*
- S7.7.11 *Multiple compartments and multiple lamps.*
- S7.7.12 *Ratio.*
- S7.7.13 *Photometry.*
- S7.7.14 *Physical tests.*
- S7.7.15 *Installation.*
- S7.7.15.4 *Incident light from single lamp.*
- S7.7.15.5 *Incident light from multiple lamps.*
- S7.8 *Parking lamps.*
- S7.8.1 *Number.*
- S7.8.2 *Color of light.*
- S7.8.3 *Mounting location.*
- S7.8.4 *Mounting height.*
- S7.8.5 *Activation.*
- S7.8.6 *Effective projected luminous lens area.*
- S7.8.7 *Visibility.*
- S7.8.8 *Indicator.*
- S7.8.9 *Markings.*
- S7.8.10 *Spacing to other lamps.*
- S7.8.11 *Multiple compartments and multiple lamps.*
- S7.8.12 *Ratio.*
- S7.8.13 *Photometry.*
- S7.8.14 *Physical tests.*
- S7.9 *High-mounted stop lamps.*
- S7.9.1 *Number.*
- S7.9.2 *Color of light.*
- S7.9.3 *Mounting location.*
- S7.9.4 *Mounting height.*
- S7.9.5 *Activation.*
- S7.9.6 *Effective projected luminous lens area.*
- S7.9.7 *Visibility.*
- S7.9.8 *Indicator.*
- S7.9.9 *Markings.*
- S7.9.10 *Spacing to other lamps.*
- S7.9.11 *Multiple compartments and multiple lamps.*
- S7.9.12 *Ratio.*
- S7.9.13 *Photometry.*
- S7.9.14 *Physical tests.*
- S7.10 *Daytime running lamps (DRLs).*
- S7.10.1 *Number.*
- S7.10.2 *Color of light.*
- S7.10.3 *Mounting location.*
- S7.10.4 *Mounting height.*
- S7.10.5 *Activation.*
- S7.10.6 *Effective projected luminous lens area.*

- S7.10.7 Visibility.
- S7.10.8 Indicator.
- S7.10.9 Markings.
- S7.10.10 Spacing to other lamps.
- S7.10.10.1 Spacing to turn signal lamps.
- S7.10.11 Multiple compartments and multiple lamps.
- S7.10.12 Ratio.
- S7.10.13 Photometry.
- S7.10.14 Physical tests.
- S7.11 School bus signal lamps.
- S7.11.1 Number.
- S7.11.2 Color of light.
- S7.11.3 Mounting location.
- S7.11.4 Mounting height.
- S7.11.5 Activation.
- S7.11.6 Effective projected luminous lens area.
- S7.11.7 Visibility.
- S7.11.8 Indicator.
- S7.11.9 Markings.
- S7.11.10 Spacing to other lamps.
- S7.11.11 Multiple compartments and multiple lamps.
- S7.11.12 Ratio.
- S7.11.13 Photometry.
- S7.11.14 Physical tests.
- S8 Reflective device requirements.
- S8.1 Reflex reflectors.
- S8.1.1 Number.
- S8.1.2 Color.
- S8.1.3 Mounting location.
- S8.1.4 Mounting height.
- S8.1.5 Activation.
- S8.1.6 Effective projected luminous lens area.
- S8.1.7 Visibility.
- S8.1.8 Indicator.
- S8.1.9 Markings.
- S8.1.10 Spacing to other lamps or reflective devices.
- S8.1.11 Photometry.
- S8.1.12 Physical tests.
- S8.1.13 Alternative side reflex reflector material.
- S8.2 Conspicuity systems.
- S8.2.1 Retroreflective sheeting.
- S8.2.1.2 Retroreflective sheeting material.
- S8.2.1.3 Certification marking.
- S8.2.1.4 Application pattern.
- S8.2.1.4.1 Alternating red and white materials.
- S8.2.1.5 Application location.
- S8.2.1.6 Application spacing.
- S8.2.1.7 Photometry.
- S8.2.2 Conspicuity reflex reflectors.
- S8.2.2.1 Certification marking.
- S8.2.2.2 Application pattern.
- S8.2.2.2.1 Alternating red and white materials.
- S8.2.2.2.2 White material.
- S8.2.2.3 Photometry.
- S8.2.3 Conspicuity system installation on trailers.
- S8.2.3.1 Trailer rear.
- S8.2.3.1.1 Element 1—alternating red and white materials.
- S8.2.3.1.2 Element 2—white.
- S8.2.3.1.3 Element 3—alternating red and white materials.
- S8.2.3.2 Trailer side-alternating red and white materials.
- S8.2.4 Conspicuity system installation on truck tractors.
- S8.2.4.1 Element 1—alternating red and white materials.
- S8.2.4.2 Element 2—white.
- S9 Associated equipment requirements.
- S9.1 Turn signal operating unit.
- S9.1.2 Physical tests.
- S9.2 Turn signal flasher.
- S9.2.2 Physical tests.
- S9.3 Turn signal pilot indicator.
- S9.3.4 Indicator size and color.
- S9.3.6 Turn signal lamp failure.
- S9.4 Headlamp beam switching device.
- S9.4.1 Semi-automatic headlamp beam switching device.
- S9.4.1.1 Operating instructions.
- S9.4.1.2 Manual override.
- S9.4.1.3 Fail safe operation.
- S9.4.1.4 Automatic dimming indicator.
- S9.4.1.5 Option 1 (Semiautomatic Headlamp Beam Switching Devices other than Adaptive Driving Beam Systems).
- S9.4.1.5.1 Lens accessibility.
- S9.4.1.5.2 Mounting height.
- S9.4.1.5.3 Physical tests.
- S9.4.1.6 Option 2 (Adaptive Driving Beam systems).
- S9.4.1.7 Physical tests.
- S9.5 Upper beam headlamp indicator.
- S9.5.1 Indicator size and location.
- S9.6 Vehicular hazard warning signal operating unit.
- S9.6.2 Operating unit switch.
- S9.6.3 Physical tests.
- S9.7 Vehicular hazard warning signal flasher.
- S9.7.2 Physical tests.
- S9.8 Vehicular hazard warning signal pilot indicator.
- S9.8.4 Indicator size and color.
- S10 Headlighting system requirements.
- S10.1 Vehicle headlighting systems.
- S10.2 [Reserved].
- S10.3 Number.
- S10.4 Color of light.
- S10.5 Mounting location.
- S10.6 Mounting height.
- S10.7 Activation.
- S10.8 Effective projected luminous lens area.
- S10.9 Visibility.
- S10.10 Indicator.
- S10.11 Markings.
- S10.12 Spacing to other lamps.
- S10.13 Sealed beam headlighting systems.
- S10.13.1 Installation.
- S10.13.2 Simultaneous aim.
- S10.13.3 Photometry.
- S10.13.4 Physical tests.
- S10.14 Integral beam headlighting systems.
- S10.14.1 Installation.
- S10.14.2 Aimability.
- S10.14.3 Simultaneous aim.
- S10.14.4 Markings.
- S10.14.5 Additional light sources.
- S10.14.6 Photometry.
- S10.14.7 Physical tests.
- S10.15 Replaceable bulb headlighting systems.
- S10.15.1 Installation.
- S10.15.2 Aiming restrictions.
- S10.15.3 Replacement lens reflector units.
- S10.15.4 Markings.
- S10.15.5 Additional light sources.
- S10.15.6 Photometry.
- S10.15.7 Physical tests.
- S10.16 Combination headlighting systems.
- S10.16.1 Installation.
- S10.16.2 Photometry.
- S10.16.3 Physical tests.
- S10.17 Motorcycle headlighting systems.
- S10.17.1 Installation.
- S10.17.1.1 Single headlamp.
- S10.17.1.2 Two headlamps with both beams.
- S10.17.1.3 Two headlamps, upper beam and lower beam.
- S10.17.2 Motorcycle replaceable bulb headlamp marking.
- S10.17.3 Photometry.
- S10.17.4 Physical tests.
- S10.17.5 Motorcycle headlamp modulation system.
- S10.17.5.1 Modulation.
- S10.17.5.2 Replacement modulators.
- S10.17.5.2.1 Replacement performance.
- S10.17.5.2.2 Replacement instructions.
- S10.18 Headlamp aimability performance requirements (except motorcycles).
- S10.18.1 Headlamp mounting and aiming.
- S10.18.2 Headlamp aiming systems.
- S10.18.3 Aim adjustment interaction.
- S10.18.4 Horizontal adjustment-visually aimed headlamp.
- S10.18.5 Optical axis marking.
- S10.18.5.1 Optical axis marking-vehicle.
- S10.18.5.2 Optical axis marking-lamp.
- S10.18.5.3 Optical axis marking-visual/optical aim headlamp.
- S10.18.6 Moveable reflectors.
- S10.18.7 External aiming.
- S10.18.7.1 Headlamp aiming device locating plates.
- S10.18.7.2 Nonadjustable headlamp aiming device locating plates.
- S10.18.8 On-vehicle aiming.
- S10.18.8.1 Aim.
- S10.18.8.1.1 Vertical aim.
- S10.18.8.1.2 Horizontal aim.
- S10.18.8.2 Aiming instructions.
- S10.18.8.3 Permanent calibration.
- S10.18.8.4 Replacement units.
- S10.18.8.5 Physical tests.
- S10.18.9 Visual/optical aiming.
- S10.18.9.1 Vertical aim, lower beam.
- S10.18.9.1.1 Vertical position of the cutoff.
- S10.18.9.1.2 Vertical gradient.
- S10.18.9.1.3 Horizontal position of the cutoff.
- S10.18.9.1.4 Maximum inclination of the cutoff.
- S10.18.9.1.5 Measuring the cutoff parameter.
- S10.18.9.2 Horizontal aim, lower beam.
- S10.18.9.3 Vertical aim, upper beam.
- S10.18.9.4 Horizontal aim, upper beam.
- S10.18.9.5 Photometry.
- S10.18.9.6 Visual/optical aiming identification marking.
- S11 Replaceable light source requirements.
- S11.1 Markings.
- S11.2 Ballast markings.
- S11.3 Gas discharge laboratory life.
- S11.4 Physical tests.
- S12 Headlamp concealment device requirements.
- S12.7 Certification election.
- S13 Replaceable headlamp lens requirements.
- S14 Physical and photometry test procedures and performance requirements.
- S14.1 General test procedures and performance requirements.
- S14.1.2 Plastic optical materials.

- S14.1.4 Samples.
- S14.1.5 Laboratory facilities.
- S14.2 Photometric test procedures.
- S14.2.1 Photometry measurements for all lamps except license lamps, headlamps, and DRLs.
- S14.2.1.1 Mounting.
- S14.2.1.2 School bus signal lamp aiming.
- S14.2.1.3 Measurement distance.
- S14.2.1.4 Location of test points.
- S14.2.1.5 Multiple compartment and multiple lamp photometry of turn signal lamps, stop lamps, and taillamps.
- S14.2.1.6 Bulbs.
- S14.2.2 License plate lamp photometry.
- S14.2.2.1 Illumination surface.
- S14.2.2.2 Test stations.
- S14.2.3 Reflex reflector and retroreflective sheeting photometry.
- S14.2.3.1 Mounting.
- S14.2.3.2 Illumination source.
- S14.2.3.3 Measurement distance.
- S14.2.3.4 Test setup.
- S14.2.3.5 Photodetector.
- S14.2.3.6 Photometry surface.
- S14.2.3.7 Procedure.
- S14.2.3.8 Measurements.
- S14.2.3.8.1 Reflex reflectors.
- S14.2.3.8.2 Retroreflective sheeting.
- S14.2.3.8.3 Reflex reflector photometry measurement adjustments.
- S14.2.4 Daytime running lamp (DRL) photometry measurements.
- S14.2.5 Headlamp photometry measurements.
- S14.2.5.1 Mounting.
- S14.2.5.3 Measurement distance.
- S14.2.5.4 Seasoning and test voltage.
- S14.2.5.5 Aiming.
- S14.2.5.5.1 Mechanically aimable headlamps using an external aimer.
- S14.2.5.5.2 Mechanically aimable headlamps equipped with a VHAD.
- S14.2.5.5.3 Visually aimable lower beam headlamps-vertical aim.
- S14.2.5.5.4 Visually aimable lower beam headlamps-horizontal aim.
- S14.2.5.5.5 Visually aimable upper beam headlamps-vertical aim.
- S14.2.5.5.6 Visually aimable upper beam headlamps-horizontal aim.
- S14.2.5.5.7 Simultaneous aim Type F sealed beam headlamps and beam contributor integral beam headlamps.
- S14.2.5.5.8 Motorcycle headlamp-upper beam headlamps designed to comply with Table XX.
- S14.2.5.5.9 Motorcycle headlamp-lower beam headlamps designed to comply with Table XX.
- S14.2.5.6 Positioner.
- S14.2.5.7 Photometer.
- S14.2.5.7.2 Sensor.
- S14.2.5.8 Location of test points.
- S14.2.5.9 Beam contributor photometry measurements.
- S14.2.5.10 Moveable reflector aimed headlamp photometry measurements.
- S14.3 Motorcycle headlamp out of focus test procedure and performance requirements.
- S14.3.1 Procedure.
- S14.3.2 Performance requirements.
- S14.4 General test procedures and performance requirements.
- S14.4.1 Color test.
- S14.4.1.1 Samples.
- S14.4.1.2 General procedure.
- S14.4.1.3 Visual method.
- S14.4.1.3.1 Visual method procedure.
- S14.4.1.3.2 Visual method performance requirements.
- S14.4.1.3.2.1 Red.
- S14.4.1.3.2.2 Yellow (Amber).
- S14.4.1.3.2.3 White.
- S14.4.1.4 Tristimulus method.
- S14.4.1.4.1 Tristimulus method procedure.
- S14.4.1.4.2 Tristimulus method performance requirements.
- S14.4.1.4.2.1 Red.
- S14.4.1.4.2.2 Yellow (Amber).
- S14.4.1.4.2.3 White (achromatic).
- S14.4.1.4.2.4 Green.
- S14.4.1.4.2.5 Restricted Blue.
- S14.4.1.4.2.6 Signal Blue.
- S14.4.2 Plastic optical materials tests.
- S14.4.2.1 Samples.
- S14.4.2.2 Outdoor exposure test.
- S14.4.2.2.3 Procedure.
- S14.4.2.2.4 Performance requirements.
- S14.4.2.3 Heat test.
- S14.4.2.3.1 Procedure.
- S14.4.2.3.2 Performance requirements.
- S14.5 Signal lamp and reflective device physical test procedures and performance requirements.
- S14.5.1 Vibration test.
- S14.5.1.1 Procedure.
- S14.5.1.2 Performance requirements.
- S14.5.2 Moisture test.
- S14.5.2.1 Procedure.
- S14.5.2.2 Performance requirements.
- S14.5.3 Dust test.
- S14.5.3.1 Samples.
- S14.5.3.2 Procedure.
- S14.5.3.3 Performance requirements.
- S14.5.4 Corrosion test.
- S14.5.4.1 Procedure.
- S14.5.4.2 Performance requirements.
- S14.6 Headlamp physical test procedures and performance requirements.
- S14.6.1 Abrasion test.
- S14.6.1.1 Procedure.
- S14.6.1.1.1 Abrading pad.
- S14.6.1.1.2 Abrading pad alignment.
- S14.6.1.1.3 Abrasion test procedure.
- S14.6.1.2 Performance requirements.
- S14.6.2 Chemical resistance test.
- S14.6.2.1 Procedure.
- S14.6.2.1.1 Test fluids.
- S14.6.2.1.2 Fluid application.
- S14.6.2.1.3 Test duration.
- S14.6.2.2 Performance requirements.
- S14.6.3 Corrosion test.
- S14.6.3.1 Procedure.
- S14.6.3.2 Performance requirements.
- S14.6.4 Corrosion-connector test.
- S14.6.4.1 Procedure.
- S14.6.4.2 Performance requirements.
- S14.6.5 Dust test.
- S14.6.5.1 Procedure.
- S14.6.5.2 Performance requirements.
- S14.6.6 Temperature cycle test and internal heat test.
- S14.6.6.1 Samples.
- S14.6.6.2 General procedure.
- S14.6.6.3 Temperature cycle test.
- S14.6.6.3.1 Procedure.
- S14.6.6.3.2 Performance requirements.
- S14.6.6.4 Internal heat test.
- S14.6.6.4.1 Procedure.
- S14.6.6.4.2 Performance requirements.
- S14.6.7 Humidity test.
- S14.6.7.1 Procedure.
- S14.6.7.2 Performance requirements.
- S14.6.8 Vibration test.
- S14.6.8.1 Samples.
- S14.6.8.2 Procedure.
- S14.6.8.3 Performance requirements.
- S14.6.9 Sealing test.
- S14.6.9.1 Procedure.
- S14.6.9.2 Performance requirements.
- S14.6.10 Chemical resistance test of reflectors of replaceable lens headlamps.
- S14.6.10.1 Procedure.
- S14.6.10.1.1 Test fluids.
- S14.6.10.1.2 Fluid application.
- S14.6.10.1.3 Test duration.
- S14.6.10.2 Performance requirements.
- S14.6.11 Corrosion resistance test of reflectors of replaceable lens headlamps.
- S14.6.11.1 Procedure.
- S14.6.11.2 Performance requirements.
- S14.6.12 Inward force test.
- S14.6.12.1 Procedure.
- S14.6.12.2 Performance requirements.
- S14.6.13 Torque deflection test.
- S14.6.13.1 Procedure.
- S14.6.13.2 Performance requirements.
- S14.6.14 Retaining ring test.
- S14.6.14.1 Procedure.
- S14.6.14.2 Performance requirements.
- S14.6.15 Headlamp connector test.
- S14.6.15.1 Procedure.
- S14.6.15.2 Performance requirements.
- S14.6.16 Headlamp wattage test.
- S14.6.16.1 Procedure.
- S14.6.16.2 Performance requirements.
- S14.6.17 Aiming adjustment test-laboratory.
- S14.6.17.1 Procedure.
- S14.6.17.2 Performance requirements.
- S14.6.18 Aiming adjustment test-on vehicle.
- S14.6.18.1 Procedure.
- S14.6.18.2 Performance requirements.
- S14.7 Replaceable light source physical test procedures and performance requirements.
- S14.7.1 Deflection test for replaceable light sources.
- S14.7.1.1 Procedure.
- S14.7.1.2 Performance requirements.
- S14.7.2 Pressure test for replaceable light sources.
- S14.7.2.1 Procedure.
- S14.7.2.2 Performance requirements.
- S14.7.3 Replaceable light source power and flux measurement procedure.
- S14.7.3.1 Seasoning.
- S14.7.3.1.1 Resistive filament source.
- S14.7.3.1.2 Discharge source.
- S14.7.3.2 Test voltage.
- S14.7.3.3 Luminous flux measurement.
- S14.7.3.3.1 Resistive filament light source setup.
- S14.7.3.3.3.2 Discharge light source setup.
- S14.8 Vehicle headlamp aiming devices (VHAD) physical test procedures and performance requirements.
- S14.8.1 Samples.
- S14.8.2 Scale graduation test.
- S14.8.2.1 Procedure.
- S14.8.2.2 Performance requirements.
- S14.8.3 Cold scale graduation test.
- S14.8.3.1 Procedure.
- S14.8.3.2 Performance requirements.
- S14.8.4 Hot scale graduation test.
- S14.8.4.1 Procedure.
- S14.8.4.2 Performance requirements.

- S14.8.5 *Thermal cycle test.*
- S14.8.5.1 *Procedure.*
- S14.8.5.2 *Performance requirements.*
- S14.8.6 *Corrosion test.*
- S14.8.6.1 *Procedure.*
- S14.8.6.2 *Performance requirements.*
- S14.8.7 *Photometry test.*
- S14.8.7.1 *Procedure.*
- S14.8.7.2 *Performance requirements.*
- S14.9 *Associated equipment physical test procedures and performance requirements.*
- S14.9.1 *Turn signal operating unit durability test.*
- S14.9.1.1 *Power supply specifications.*
- S14.9.1.2 *Procedure.*
- S14.9.1.3 *Performance requirements.*
- S14.9.2 *Vehicle hazard warning signal operating unit durability test.*
- S14.9.2.1 *Procedure.*
- S14.9.2.2 *Performance requirements.*
- S14.9.3 *Turn signal flasher and vehicular hazard warning flasher tests.*
- S14.9.3.1 *Standard test circuit.*
- S14.9.3.1.1 *Test circuit setup.*
- S14.9.3.2 *Power supply specifications.*
- S14.9.3.2.1 *Starting time, voltage drop, and flash rate and percent current "on" time tests.*
- S14.9.3.2.2 *Durability tests.*
- S14.9.3.3 *Turn signal flasher starting time test.*
- S14.9.3.3.1 *Samples.*
- S14.9.3.3.2 *Procedure.*
- S14.9.3.3.3 *Performance requirements.*
- S14.9.3.4 *Turn signal flasher voltage drop test.*
- S14.9.3.4.1 *Samples.*
- S14.9.3.4.2 *Procedure.*
- S14.9.3.4.3 *Performance requirements.*
- S14.9.3.5 *Turn signal flasher flash rate and percent current "on" time test.*
- S14.9.3.5.1 *Samples.*
- S14.9.3.5.2 *Procedure.*
- S14.9.3.5.3 *Performance requirements.*
- S14.9.3.6 *Turn signal flasher durability test.*
- S14.9.3.6.1 *Samples.*
- S14.9.3.6.2 *Procedure.*
- S14.9.3.6.3 *Performance requirements.*
- S14.9.3.7 *Vehicle hazard warning signal flasher starting time test.*
- S14.9.3.7.1 *Samples.*
- S14.9.3.7.2 *Procedure.*
- S14.9.3.7.3 *Performance requirements.*
- S14.9.3.8 *Vehicle hazard warning signal flasher voltage drop test.*
- S14.9.3.8.1 *Samples.*
- S14.9.3.8.2 *Procedure.*
- S14.9.3.8.3 *Performance requirements.*
- S14.9.3.9 *Vehicle hazard warning signal flasher flash rate and percent "on" time test.*
- S14.9.3.9.1 *Samples.*
- S14.9.3.9.2 *Procedure.*
- S14.9.3.9.3 *Performance requirements.*
- S14.9.3.10 *Vehicle hazard warning signal flasher durability test.*
- S14.9.3.10.1 *Samples.*
- S14.9.3.10.2 *Procedure.*
- S14.9.3.10.3 *Performance requirements.*
- S14.9.3.11 *Semiautomatic headlamp beam switching device tests.*
- S14.9.3.11.1 *Test conditions.*
- S14.9.3.11.2 *Sensitivity test.*
- S14.9.3.11.2.1 *Samples.*
- S14.9.3.11.2.2 *Procedure.*
- S14.9.3.11.2.3 *Performance requirements.*
- S14.9.3.11.2.3.1 *Operating limits.*
- S14.9.3.11.3 *Voltage regulation test.*
- S14.9.3.11.3.1 *Procedure.*
- S14.9.3.11.3.2 *Performance requirements.*
- S14.9.3.11.4 *Manual override test.*
- S14.9.3.11.4.1 *Procedure.*
- S14.9.3.11.4.2 *Performance requirements.*
- S14.9.3.11.5 *Warmup test.*
- S14.9.3.11.5.1 *Procedure.*
- S14.9.3.11.5.2 *Performance requirements.*
- S14.9.3.11.6 *Temperature test.*
- S14.9.3.11.6.1 *Procedure.*
- S14.9.3.11.6.2 *Performance requirements.*
- S14.9.3.11.7 *Dust test.*
- S14.9.3.11.7.1 *Procedure.*
- S14.9.3.11.7.2 *Performance requirements.*
- S14.9.3.11.8 *Corrosion test.*
- S14.9.3.11.8.1 *Procedure.*
- S14.9.3.11.8.2 *Performance requirements.*
- S14.9.3.11.9 *Vibration test.*
- S14.9.3.11.9.1 *Procedure.*
- S14.9.3.11.9.2 *Performance requirements.*
- S14.9.3.11.10 *Sunlight test.*
- S14.9.3.11.10.1 *Procedure.*
- S14.9.3.11.10.2 *Performance requirements.*
- S14.9.3.11.11 *Durability test.*
- S14.9.3.11.11.1 *Procedure.*
- S14.9.3.11.11.2 *Performance requirements.*
- S14.9.3.11.12 *Return to upper beam test.*
- S14.9.3.11.12.1 *Procedure.*
- S14.9.3.11.12.2 *Performance requirements.*
- S14.9.3.12 *Test for compliance with adaptive driving beam photometry requirements.*
- S14.9.3.12.1 *Test Scenarios.*
- S14.9.3.12.2 *Compliance Criteria.*
- S14.9.3.12.3 *Stimulus test fixtures.*
- S14.9.3.12.4 *Test vehicle preparation.*
- S14.9.3.12.5 *Test road.*
- S14.9.3.12.6 *Other test parameters and conditions.*
- Table I-a *Required lamps and reflective devices All passenger cars, multipurpose passenger vehicles (MPV), trucks, and buses*
- Table I-b *Required lamps and reflective devices All trailers*
- Table I-c *Required lamps and reflective devices All motorcycles*
- Table II-a *Headlighting systems Sealed beams*
- Table II-b *Headlighting systems Combination*
- Table II-c *Headlighting systems Integral beams*
- Table II-d *Headlighting systems Replaceable bulb*
- Table III *Marking requirements location*
- Table IV-a *Effective projected luminous lens area requirements*
- Table IV-b *Effective projected luminous lens area requirements*
- Table IV-c *Effective projected luminous lens area requirements*
- Table V-a *Visibility requirements of installed lighting devices*
- Table V-b *Visibility requirements of installed lighting devices Lens area visibility option*
- Table V-c *Visibility requirements of installed lighting devices Luminous intensity visibility option*
- Table V-d *Visibility requirements of installed lighting devices (Legacy visibility alternative)*
- Table VI-a *Front turn signal lamp photometry requirements*
- Table VI-b *Front turn signal lamp photometry requirements*
- Table VII *Rear turn signal lamp photometry requirements*
- Table VIII *Taillamp photometry requirements*
- Table IX *Stop lamp photometry requirements*
- Table X *Side marker lamp photometry requirements*
- Table XI *Clearance and identification lamps photometry requirements*
- Table XII *Backup lamp photometry requirements*
- Table XIII-a *Motorcycle turn signal lamp alternative photometry requirements*
- Table XIII-b *Motor driven cycle stop lamp alternative photometry requirements*
- Table XIV *Parking lamp photometry requirements*
- Table XV *High-mounted stop lamp photometry requirements*
- Table XVI-a *Reflex reflector photometry requirements*
- Table XVI-b *Additional photometry requirements for conspicuity reflex reflectors*
- Table XVI-c *Retroreflective sheeting photometry requirements*
- Table XVII *School bus signal lamp photometry requirements*
- Table XVIII *Headlamp upper beam photometry requirements*
- Table XIX-a *Headlamp lower beam photometry requirements*
- Table XIX-b *Headlamp lower beam photometry requirements*
- Table XIX-c *Headlamp lower beam photometry requirements*
- Table XX *Motorcycle and motor driven cycle headlamp photometry requirements*
- Table XXI *Adaptive Driving Beam Photometry Requirements*
- Table XXII *Adaptive Driving Beam Test Matrix*
- Figure 1 *Chromaticity diagram*
- Figure 2 *Flasher performance chart*
- Figure 3 *Replaceable bulb headlamp aim pads*
- Figure 4 *Headlamp connector test setup*
- Figure 5 *Headlamp abrasion test fixture*
- Figure 6 *Thermal cycle test profile*
- Figure 7 *Dirt/Ambient test setup*
- Figure 8 *Replaceable light source deflection test setup*
- Figure 9 *Environmental test profile*
- Figure 10 *Replaceable light source pressure test setup*
- Figure 11 *Trailer conspicuity treatment examples*
- Figure 12-1 *Trailer conspicuity detail I*
- Figure 12-2 *Trailer conspicuity detail II*
- Figure 13 *Tractor conspicuity treatment examples*
- Figure 14 *92 x 150 Headlamp aim deflection test setup*
- Figure 15 *Types G and H headlamp aim deflection test setup*
- Figure 16 *Types A and E headlamp aim deflection test setup*
- Figure 17 *Type B headlamp aim deflection test setup*
- Figure 18 *Types C and D headlamp aim deflection test setup*

Figure 19 *License plate lamp target locations*
Figure 20 *License plate lamp measurement of incident light angle*
Figure 21 *Vibration test machine*
Figure 22 *Flasher standard test circuit*
Figure 23 *Car/Truck opposite direction stimulus test fixture dimensions*

Figure 24 *Car/Truck same direction stimulus test fixture dimensions*
Figure 25 *Motorcycle opposite direction stimulus test fixture dimensions*
Figure 26 *Motorcycle same direction stimulus test fixture dimensions*
Figure 27 *Opposite direction test scenarios*
Figure 28 *Same direction test scenarios*
Figure 29 *Left Curve Test Scenarios*

Figure 30 *Right Curve Test Scenarios*
* * * * *

Issued under authority delegated in 49 CFR 1.95, 501.4, and 501.5.

Steven S. Cliff,

Deputy Administrator.

[FR Doc. 2022-02451 Filed 2-18-22; 8:45 am]

BILLING CODE 4910-59-P