

CONSUMER PRODUCT SAFETY COMMISSION

16 CFR Parts 1112 and 1262

[Docket No. CPSC–2021–0037]

Safety Standard for Magnets

AGENCY: Consumer Product Safety Commission.

ACTION: Notice of proposed rulemaking.

SUMMARY: The U.S. Consumer Product Safety Commission (Commission or CPSC) has determined preliminarily that there is an unreasonable risk of injury and death, particularly to children and teens, associated with ingestion of one or more high-powered magnets. To address this risk, the Commission proposes a rule, under the Consumer Product Safety Act, to apply to consumer products that are designed, marketed, or intended to be used for entertainment, jewelry (including children’s jewelry), mental stimulation, stress relief, or a combination of these purposes, and that contain one or more loose or separable magnets. Toys that are subject to CPSC’s mandatory toy standard are exempt from the proposed rule. Each loose or separable magnet in a product that is subject to the proposed rule and that fits entirely within CPSC’s small parts cylinder would be required to have a flux index of less than 50 kG² mm². The Commission requests comments about all aspects of this notice, including the risk of injury, the proposed scope and requirements, alternatives to the proposed rule, and the economic impacts of the proposed rule and alternatives.

DATES: Submit comments by March 28, 2022.

ADDRESSES: Submit written comments, identified by Docket No. CPSC–2021–0037, using the methods described below. CPSC encourages you to submit comments electronically, rather than in hard copy.

Electronic Submissions: Submit electronic comments to the Federal eRulemaking Portal at: <https://www.regulations.gov>. Follow the instructions for submitting comments. CPSC does not accept comments submitted by electronic mail (email), except through <https://www.regulations.gov>, and as described below. CPSC encourages you to submit electronic comments by using the Federal eRulemaking Portal, as described above.

Mail/Hand Delivery/Courier Written Submissions: Submit comments by mail/hand delivery/courier to: Division of the Secretariat, Consumer Product

Safety Commission 4330 East-West Highway, Bethesda, MD 20814; telephone: (301) 504–7479.

Alternatively, as a temporary option during the COVID–19 pandemic, you can email such submissions to: cpsc-os@cpsc.gov.

Instructions: All submissions must include the agency name and docket number for this notice. CPSC may post all comments without change, including any personal identifiers, contact information, or other personal information provided, to: <https://www.regulations.gov>. Do not submit electronically: Confidential business information, trade secret information, or other sensitive or protected information that you do not want to be available to the public. If you wish to submit such information, please submit it according to the instructions for mail/hand delivery/courier written submissions.

Docket: To read background documents or comments regarding this proposed rulemaking, go to: <http://www.regulations.gov>, insert docket number CPSC–2021–0037 in the “Search” box, and follow the prompts.

FOR FURTHER INFORMATION CONTACT: Michelle Guice, Compliance Officer, U.S. Consumer Product Safety Commission, 4330 East-West Highway, Bethesda, MD 20814; telephone (301) 504–7723; email: MGuice@cpsc.gov.

SUPPLEMENTARY INFORMATION:

I. Background

A. Overview of the Proposed Rule

The Commission issues this notice of proposed rulemaking (NPR) under sections 7 and 9 of the Consumer Product Safety Act (CPSA; 15 U.S.C. 2051–2089).¹ Through this rulemaking, the Commission seeks to create a safety standard to address the unreasonable risk of injury and death associated with ingestion of loose or separable high-powered magnets. Incident data indicate that certain consumer products containing such magnets are ingested by children and teens. When ingested, these powerful magnets can interact internally with one another, or a ferromagnetic object (*i.e.*, material attracted to magnets), through body tissue, leading to acute and long-term adverse health consequences or death.

The proposed rule applies to consumer products that are designed, marketed, or intended to be used for entertainment, jewelry (including children’s jewelry), mental stimulation, stress relief, or a combination of these purposes, and that contain one or more

loose or separable magnets. Toys that are subject to CPSC’s mandatory toy standard in 16 CFR part 1250 are exempt from the proposed rule, because that standard already includes requirements to address the magnet ingestion hazard in children’s toys (*i.e.*, products designed, manufactured, or marketed as playthings for children under 14 years old). In this notice, products that are subject to the proposed rule are referred to as “subject magnet products.”

The proposed rule seeks to address the risk of injury or death associated with magnet ingestions, by requiring loose or separable magnets in subject magnet products to be either too large to swallow, or weak enough to reduce the risk of internal interaction injuries when swallowed. Under the proposed rule, each loose or separable magnet in a subject magnet product that fits entirely within CPSC’s small parts cylinder must have a flux index of less than 50 kG² mm². CPSC’s small parts cylinder is described and illustrated in 16 CFR 1501.4, which is intended to prevent children from ingesting of small objects. The proposed rule specifies the method for determining the flux index of a magnet, and this preamble discusses the basis for the flux index limit in the proposed rule. The term “hazardous magnet” refers to a magnet that fits entirely within the small parts cylinder and that has a flux index of 50 kG² mm² or more.

The information discussed in this preamble is derived from CPSC staff’s briefing package for the NPR, which is available on CPSC’s website at: <https://www.cpsc.gov/s3fs-public/Proposed-Rule-Safety-Standard-for-Magnets.pdf?VersionId=2Xizl5izY1OvQRVazWpkqdJHXg5vzRY>. This preamble provides key information to explain and support the rule; however, for a more comprehensive and detailed discussion, see the NPR briefing package.

B. History of CPSC Work on the Magnet Ingestion Hazard

CPSC has taken several actions to address the magnet ingestion hazard, including issuing mandatory standards, working with voluntary standards organizations, initiating recalls and compliance actions, engaging in staff assessments of the hazard and potential ways to address it, and creating information campaigns.

1. Mandatory Standards

On August 14, 2008, Congress enacted section 106 of the Consumer Product Safety Improvement Act (CPSIA; Pub. L. 110–314, 122 Stat. 3016 (Aug. 14, 2008)), codified at 15 U.S.C. 2056b.

¹ The Commission voted 4–0 to approve this notice and commence rulemaking.

Section 106 of the CPSIA provides that, beginning 180 days after its enactment, ASTM F963–07, *Consumer Safety Specification for Toy Safety*, is considered a consumer product safety standard issued by the Commission under section 9 of the CPSA.² 15 U.S.C. 2056b(a). Section 106 further provides for updates to the mandatory standard when ASTM F963 is revised or to improve safety. *Id.* 2056b(b)(2), (c), (d), (g). Section 106 specifically refers to “internal harm or injury hazards caused by the ingestion or inhalation of magnets in children’s products,” among other hazards, in its directive to review and assess ASTM F963. *Id.* 2056b(b)(1)(A).

Consistent with the mandate in section 106 of the CPSIA, the Commission adopted 16 CFR part 1250, *Safety Standard Mandating ASTM F963 for Toys* (toy standard), which currently incorporates by reference ASTM F963–17, the most recent revision to the standard.³ 82 FR 57119 (Dec. 4, 2017). ASTM F963–17 applies to “toys,” which are objects “designed, manufactured, or marketed as a plaything for children under 14 years of age.” The standard includes requirements to address the hazard associated with ingestion of loose, as-received magnets that are small enough to fit in the small parts cylinder and have a flux index of 50 kG² mm² or more. Section V. Relevant Existing Standards, below, further describes the requirements in ASTM F963–17.

In 2012, the Commission initiated rulemaking to address the magnet ingestion hazard for products that do not fall under 16 CFR part 1250. The rule focused on magnet sets, which were involved in internal interaction injuries in children and teens, when ingested. 77 FR 53781 (Sep. 4, 2012) (notice of proposed rulemaking); 79 FR 59962

² Section 106 excluded from this mandate the following provisions in ASTM F963–07: Section 4.2 and Annex 4 (which address flammability), and “any provision that restates or incorporates an existing mandatory standard or ban promulgated by the Commission or by statute or any provision that restates or incorporates a regulation promulgated by the Food and Drug Administration or any statute administered by the Food and Drug Administration.”

³ Part 1250 excepts from the mandatory standard, section 4.2 and Annex 5 (which address flammability) of ASTM F963–17, as well as “any provision of ASTM F963 that restates or incorporates an existing mandatory standard or ban promulgated by the Commission or by statute or any provision that restates or incorporates a regulation promulgated by the Food and Drug Administration or any statute administered by the Food and Drug Administration.” 16 CFR 1250.2(b). In addition, part 1250 replaces section 8.20.1.5(5) of ASTM F963 regarding floor and tabletop toys that move, where a sound is caused as a result of the movement imparted on the toy. *Id.* 1250.2(c).

(Oct. 3, 2014) (final rule). The rule defined “magnet sets” as “any aggregation of separable magnetic objects that is a consumer product intended, marketed or commonly used as a manipulative or construction item for entertainment, such as puzzle working, sculpture building, mental stimulation, or stress relief.” The rule required each magnet in a magnet set, and each individual magnetic object intended or marketed for use with or as a magnet set, that fit completely within CPSC’s small parts cylinder, to have a flux index of 50 kG² mm² or less. The final rule was published in October 2014, and it took effect on April 1, 2015. On November 22, 2016, the U.S. Court of Appeals for the Tenth Circuit overturned the rule on magnet sets, vacating and remanding the rule to the Commission. *Zen Magnets, LLC v. Consumer Prod. Safety Comm’n.*, 841 F.3d 1141 (10th Cir. 2016).⁴

2. Voluntary Standards Work

CPSC staff has actively participated in the development and revision of voluntary standards intended to address the magnet ingestion hazard. Since the development of ASTM F963 in 2007, CPSC staff has worked with ASTM to address hazardous magnets in children’s toys, including working on multiple revisions to that standard. In addition, staff has participated actively in the ASTM Subcommittee F15.77 on Magnets, which published a voluntary standard on magnet sets in March 2021—ASTM F3458–21, *Standard Specification for Marketing, Packaging, and Labeling Adult Magnet Sets Containing Small, Loose, Powerful Magnets (with a Flux Index $\geq 50 \text{ kG}^2 \text{ mm}^2$)*.

3. Recalls and Compliance Actions⁵

CPSC’s Office of Compliance has investigated and recalled numerous magnet products involving the magnet ingestion hazard. From January 1, 2010 through August 17, 2021, CPSC conducted 18 such recalls, involving 23 firms/retailers, and totaling approximately 13,832,899 recalled units, including craft kits, desk toys, magnet sets, pencil cases, games, bicycle helmets, and maps, among others. Of

⁴ The court decision had legal effect immediately upon its filing on November 22, 2016. However, in accordance with the court’s decision, the Commission removed the mandatory standard for magnets sets (16 CFR part 1240) from the Code of Federal Regulations on March 7, 2017. 82 FR 12716 (Mar. 7, 2017).

⁵ Tab G of the NPR briefing package provides details about the recall dates, hazards, approximate number of units affected, number of reported incidents and injuries, and links to the recall press releases.

these 18 recalls, 5 involved products that would not be subject to the proposed rule; specifically, 4 involved children’s toys that are subject to the mandatory toy standard, and 1 involved trivets sold with cookware sets. Although these 5 recalls did not apply to products that would be subject to the rule, they also illustrate the magnet ingestion hazard. In addition to recalls, CPSC has addressed the products that present a magnet ingestion hazard through manufacturers’ voluntary cessation of sales.

4. Staff Assessment

In addition to staff’s assessments of the magnet ingestion hazard for previous rulemakings and compliance efforts, staff also assessed the hazard and potential ways to address it in response to a petition for rulemaking. On August 17, 2017, CPSC received a petition requesting that the Commission initiate rulemaking to address the hazard associated with magnet sets when “ingested, aspirated, or otherwise inserted into” the body.⁶ On April 22, 2020, the petitioner withdrew the petition. Nevertheless, staff provided the Commission with an informational briefing package on June 30, 2020, discussing the hazard and staff’s work in response to the petition.⁷ In the informational briefing package, staff recommended that CPSC continue to consider performance requirements for magnets, to address the ingestion hazard to children and teens.

5. Information Campaigns

In addition to raising awareness of the magnet ingestion hazard through publicized recalls, CPSC has drawn attention to the hazard through safety alerts and public safety bulletins. CPSC maintains a “Magnets Information Center” website,⁸ which provides an informational video, a description of the hazard, steps to take when magnets are swallowed, and links to recalls, relevant CPSC materials, applicable regulations, and informational posters. CPSC also issued a safety alert about the magnet ingestion hazard, which describes the hazard and steps to take when magnets are swallowed. In addition to CPSC’s information campaigns, health

⁶ The Commission published a **Federal Register** notice on October 6, 2017, seeking comments on the petition. 82 FR 46740.

⁷ The informational briefing package, “Staff Briefing Package In Response to Petition CP 17–1, Requesting Rulemaking Regarding Magnet Sets,” is available at: <https://www.cpsc.gov/s3fs-public/Informational%20Briefing%20Package%20Regarding%20Magnet%20Sets.pdf>.

⁸ Available at: <https://www.cpsc.gov/Safety-Education/Safety-Education-Centers/Magnets>.

organizations and other consumer advocacy groups have made numerous public outreach efforts to warn consumers about the magnet ingestion hazard.⁹

C. How Other Countries Have Addressed the Magnet Ingestion Hazard

Like CPSC, other countries have recognized the internal interaction hazard associated with magnet ingestions. Several of these countries have issued mandatory requirements to address the hazard. To understand how other countries have addressed magnet ingestions, staff reviewed the mandatory requirements for Canada, Australia, New Zealand, and the European Commission.

Canada's Requirements Regarding Magnet Ingestion. Since 2006, Health Canada has issued several advisories to warn Canadians of the dangers associated with ingesting magnets.¹⁰ In addition, some manufacturers took steps to keep these products from children (e.g., through package warnings, instructions on safe use, and guidance to retailers on safe sales practices). Despite these efforts, children continued to access and use magnets, and ingestion incidents continued. Consequently, Canada adopted mandatory standards for toys and non-toys, to address the magnet ingestion hazard.

Canada's regulation for toys, SOR/2018-138, includes requirements for magnetic toys intended for children under 14 years old.¹¹ The standard requires each magnet toy, and each magnetic component in a toy, that can fit entirely within a small parts cylinder, to have a flux index below a specified limit, which is equivalent to 50 kG² mm². The standard includes toys with only one magnet, to account for attraction to ferromagnetic objects. The

⁹ Examples include the American Academy of Pediatrics (<https://services.aap.org/en/search/?k=magnets>); the North American Society for Pediatric Gastroenterology, Hepatology and Nutrition (<https://www.naspghan.org/content/72/en/Foreign-Body-Ingestion>); Consumer Reports (<https://www.consumerreports.org/product-safety/magnets-marketed-as-toys-could-be-dangerous-to-kids/>); Consumer Federation of America (<https://consumerfed.org/testimonial/cfa-comments-cpsc-notice-proposed-rulemaking-safety-standard-magnet-sets/>); and Kids In Danger (<https://kidsindanger.org/2011/11/cpsc-warns-about-high-powered-magnets/>).

¹⁰ For example, see: <https://healthycanadians.gc.ca/recall-alert-rappel-avis/hc-sc/2013/31619a-eng.php>; <https://www.canada.ca/en/health-canada/services/consumer-product-safety/advisories-warnings-recalls/letters-notices-information-industry/information-manufacturers-importers-distributors-retailers-products-containing-small-powerful-magnets.html>.

¹¹ See <https://laws-lois.justice.gc.ca/eng/regulations/SOR-2011-17/page-3.html#h-1109670>.

requirements are consistent with ASTM F963.

Canada has also specified¹² that its general requirements, under the Canada Consumer Product Safety Act (CCPSA), prohibit the manufacture, import, advertising, and sale of products that contain small, powerful magnets, regardless of the intended user age. The general provision in the CCPSA prohibits the manufacture, import, advertisement, and sale of any consumer product that "is a danger to human health or safety." Sections 7(a), 8(a).¹³ Canada specifically highlighted products intended for entertainment that consist of numerous small, powerful magnets.

Australia's Requirements Regarding Magnet Ingestion. Australia has also issued mandatory requirements for both children's toys, and non-children's products, to address the magnet ingestion hazard. For toys intended for children up to, and including, 36 months, Australia requires compliance with Australia New Zealand Standard AS/NZS ISO 8124.1, which aligns with the magnet requirements in ASTM F963.¹⁴

In addition, in November 2012, Australia adopted a permanent ban of consumer goods containing 2 or more separable or loose magnetic objects, where at least 2 of the magnetic objects each separately fit entirely within a small parts cylinder (specified in AS/NZS ISO 8124.1) and each have a flux index greater than 50 kG² mm² (using methods described in AS/NZS ISO 8124.1). The ban applies to magnetic objects marketed or supplied for use as a toy, game, puzzle, construction or modelling kit, or jewelry to be worn in or around the mouth or nose. This includes adult desk toys, educational toys or games, and toys, games, and puzzles for mental stimulation or stress relief.¹⁵

New Zealand's Requirements Regarding Magnet Ingestion. As indicated above, New Zealand also uses AS/NZS ISO 8124.1, which aligns with the magnet requirements in ASTM

¹² See <https://www.canada.ca/en/health-canada/services/consumer-product-safety/advisories-warnings-recalls/letters-notices-information-industry/information-manufacturers-importers-distributors-retailers-products-containing-small-powerful-magnets.html>.

¹³ See <https://laws-lois.justice.gc.ca/eng/acts/c-1.68/page-1.html>.

¹⁴ See <https://www.legislation.gov.au/Details/F2008C00607>.

¹⁵ See <https://www.legislation.gov.au/Details/F2012L02171>; <https://www.productsafety.gov.au/bans/small-high-powered-magnets>.

F963, to address the magnet ingestion hazard in children's toys.¹⁶

In addition, in January 2013, New Zealand issued a temporary ban¹⁷ on the sale of certain high-powered magnets, which it extended indefinitely in July 2014.¹⁸ The ban applies to magnetic objects for personal, domestic, or household use that are supplied, offered, or advertised as a toy, game, puzzle, novelty, construction or modelling kit, or jewelry that may be worn in or around the mouth or nose. This includes adult desk toys, educational toys and games, and toys, games, and puzzles for mental stimulation or stress relief. The ban does not apply to hardware magnets, magnets used for teaching purposes by schools and universities, or magnets intended to become part of another product. The ban applies to the specified products if they contain 2 or more separable or loose magnetic objects, at least 2 of the magnetic objects each separately fit entirely within a small parts cylinder (specified in AS/NZS ISO 8124.1), and at least 2 of those magnets have a flux index greater than 50 kG² mm² (using methods described in AS/NZS ISO 8124.1).

The European Commission's Requirements Regarding Magnet Ingestion. The European Commission requires children's toys to comply with EN 71-1, *Safety of Toys*, discussed further in section V. Relevant Existing Standards, below. The requirements in EN 71-1 relating to magnet ingestion are essentially the same as the requirements in ASTM F963-17. There is no safety standard regarding magnet ingestions for products other than children's toys. However, member states generally apply EN 71-1 when assessing the risk posed by products that are not marketed as children's toys, but are intended for children, including magnet sets intended for adults because they are often bought for and used by children.

II. Statutory Authority

Subject magnet products are "consumer products" that the Commission has authority to regulate

¹⁶ See <https://www.standards.govt.nz/shop/asnz-iso-8124-12019/>.

¹⁷ See <https://www.beehive.govt.nz/release/ban-sale-high-powered-magnet-sets#:~:text=Consumer%20Affairs%20Minister%20Simon%20Bridges,stores%20and%20over%20the%20internet>.

¹⁸ Unsafe Goods (Small High Powered Magnets) Indefinite Prohibition Notice 2014, available at: <https://gazette.govt.nz/notice/id/2014-go4501>; see also, <https://productsafety.tradingstandards.govt.nz/for-business/regulated-products/small-high-powered-magnets-unsafe-goods-notice/>; <https://productsafety.tradingstandards.govt.nz/for-consumers/safety-with-specific-products/high-powered-magnets/>.

under the CPSA. *See* 15 U.S.C. 2052(a)(5). Section 7 of the CPSA authorizes the Commission to issue a mandatory consumer product safety standard that consists of performance requirements or requirements that the product be marked with, or accompanied by, warnings or instructions. *Id.* 2056(a). Any requirement in the standard must be “reasonably necessary to prevent or reduce an unreasonable risk of injury” associated with the product. *Id.* Section 7 requires the Commission to issue such a standard in accordance with section 9 of the CPSA. *Id.*

Section 9 of the CPSA specifies the procedure the Commission must follow to issue a consumer product safety standard under section 7. *Id.* 2058. Under section 9, the Commission may initiate rulemaking by issuing an advance notice of proposed rulemaking (ANPR) or NPR. *Id.* 2058(a). When issuing an NPR, the Commission must comply with section 553 of Administrative Procedure Act (5 U.S.C. 551–559), which requires the Commission to provide notice of a rule and the opportunity to submit written comments on it. 5 U.S.C. 553; 15 U.S.C. 2058(d)(2). In addition, the Commission must provide interested parties with an opportunity to make oral presentations of data, views, or arguments. *Id.* 2058(d)(2).

Under section 9 of the CPSA, an NPR must include the text of the proposed rule, any alternatives the Commission proposes, and a preliminary regulatory analysis. *Id.* 2058(c). The preliminary regulatory analysis must include:

- A preliminary description of the potential benefits and costs of the rule, including benefits and costs that cannot be quantified, and the analysis must identify who is likely to receive the benefits and bear the costs;
- a discussion of the reasons any standard or portion of a standard submitted to the Commission in response to an ANPR was not published by the Commission as the proposed rule or part of the proposed rule;
- a discussion of the reasons for the Commission’s preliminary determination that efforts submitted to the Commission in response to an ANPR to develop or modify a voluntary standard would not be likely, within a reasonable period of time, to result in a voluntary standard that would eliminate or adequately reduce the risk of injury addressed by the proposed rule; and
- a description of alternatives to the proposed rule that the Commission considered and a brief explanation of the reasons the alternatives were not chosen.

Id.

In addition, to issue a final rule, the Commission must make certain findings and include them in the rule. *Id.* 2058(f)(1), (f)(3). Under section 9(f)(1) of the CPSA, before promulgating a consumer product safety rule, the Commission must consider, and make appropriate findings to be included in the rule, concerning the following issues:

- The degree and nature of the risk of injury the rule is designed to eliminate or reduce;
- the approximate number of consumer products subject to the rule;
- the need of the public for the products subject to the rule and the probable effect the rule will have on the cost, availability, and utility of such products; and
- the means to achieve the objective of the rule while minimizing adverse effects on competition, manufacturing, and commercial practices.

Id. 2058(f)(1). Under section 9(f)(3) of the CPSA, the Commission may not issue a consumer product safety rule unless it makes the following findings and includes them in the rule:

- That the rule, including the effective date, is reasonably necessary to eliminate or reduce an unreasonable risk of injury associated with the product;
- that issuing the rule is in the public interest;
- if a voluntary standard addressing the risk of injury has been adopted and implemented, that either compliance with the voluntary standard is not likely to result in the elimination or adequate reduction of the risk of injury, or there is unlikely to be substantial compliance with the voluntary standard;
- that the benefits expected from the rule bear a reasonable relationship to its costs; and
- that the rule imposes the least burdensome requirement that prevents or adequately reduces the risk of injury.

Id. 2058(f)(3). At the NPR stage, the Commission is making these findings on a preliminary basis to allow the public to comment on them.

III. The Product and Market

A. Description of the Product

The proposed rule applies to “subject magnet products,” which are consumer products that are designed, marketed, or intended to be used for entertainment, jewelry (including children’s jewelry), mental stimulation, stress relief, or a combination of these purposes, and that contain one or more loose or separable magnets (subject magnet products). Toys that are subject to 16 CFR part 1250,

Safety Standard Mandating ASTM F963 for Toys, are exempt from this proposed rule.

Subject magnet products include a wide variety of consumer products. Magnets in subject magnet products typically are small, powerful, magnetic balls, cubes, cylinders, and other shapes that can be used to create jewelry (such as necklaces, bracelets, and simulated piercings), and can be aggregated to make sculptures, for use as desk toys, and as other building sets. One common example of a subject magnet product is magnet sets intended for users 14 years and older. Consistent with the Commission’s 2014 rule, magnet sets are aggregations of separable magnetic objects that are marketed or commonly used as a manipulative or construction items for entertainment, such as puzzle working, sculpture building, mental stimulation, or stress relief. Magnet sets often contain hundreds to thousands of loose, small, high-powered magnets. Another example of a subject magnet product is jewelry with separable magnets, such as jewelry-making sets and faux magnetic piercings/studs. Additional examples include products commonly referred to as “executive toys,” “desk toys,” and “rock magnets” (rock-shaped magnets), intended for amusement of users 14 years and older.

Subject magnet products are available in a variety of shapes (*e.g.*, balls, cubes, cylinders), sizes (*e.g.*, 2.5 mm, 3 mm, 5 mm), and number of magnets (*e.g.*, 1 to thousands). Subject magnet products often consist of numerous identical magnets, although some products include non-identical magnets, such as two or more different shapes. Subject magnet products commonly include magnets between 3 mm and 6 mm in size, and consist of several hundred magnets. One example of a common subject magnet product that staff identified is magnet sets containing approximately 200 magnetic spheres with 5 mm diameters.

Magnets in subject magnet products have a variety of compositions, such as alloys of neodymium, iron, boron (NIB); ferrite/hematite; aluminum, nickel, cobalt (AlNiCo); and samarium and cobalt (SmCo). NIB and SmCo magnets are often referred to as “rare earth” magnets because neodymium and samarium are “rare earth” elements found on the periodic table. Most subject magnet products that staff identified were made from NIB. NIB is typically used in smaller magnets used for magnet sets and magnetic jewelry sets, and ferrite/hematite is typically used in larger magnets, such as rock-shaped magnet toys. The magnetized cores of subject magnet products are

coated with a variety of metals and other materials to make them more attractive to consumers and to protect the brittle magnetic alloy materials from breaking, chipping, and corroding.

Staff found that 5 mm diameter NIB magnets (the most common size identified in magnet ingestion incidents) typically have strong magnetic properties, ranging between 300 and 400 kG² mm², and ferrite rock magnets measured upwards of 700 kG² mm². Staff also identified products close to the proposed limit of 50 kG² mm², ranging from approximately 30 kG² mm² to 70 kG² mm². Some subject magnet products advertise having flux indexes lower than 50 kG² mm², which is more common for smaller magnets (e.g., 2.5 mm magnets).

Some subject magnet products are “children’s products.” The definition of “children’s products,” and the requirements applicable to them, are described in section XII. Testing, Certification, and Notice of Requirements, below. To summarize, a “children’s product” is a consumer product that is “designed or intended primarily for children 12 years of age or younger.” 15 U.S.C. 2052(a)(2). Most subject magnet products are not children’s products because the proposed rule exempts from the standard products that fall under the mandatory toy standard, which applies to playthings intended for users under 14 years old. However, some subject magnet products are children’s products because, although they are intended for users 12 years old and younger, they do not fall under the toy standard because they are not playthings. One example of a subject magnet product that could be a children’s product and not a toy is children’s jewelry.

B. The Market

Magnet products intended for the purposes covered in the proposed rule largely entered the market in 2008, with significant sales beginning in 2009. Of the various products covered by the proposed rule, magnet sets have been particularly concerning to CPSC, given their popularity, uses for amusement and jewelry, their involvement in ingestion incidents, and the large number of loose, small, high-powered magnets in the sets. For this reason, CPSC’s previous efforts to address the magnet ingestion hazard largely have focused on magnet sets. Accordingly, much of the information staff has about the market for subject magnet products

focuses on magnet sets,¹⁹ which are the largest category of identified products involved in magnet ingestions.

From 2009 through mid-2012, most magnet set sellers were retailers with physical stores, such as bookstores, gift shops, and other outlets. In contrast, nearly all current marketers (firms or individuals) of magnet sets sell through internet sites, rather than physical stores. Some of these internet sites are operated by importers, but most sellers (in terms of distinct firms or individuals, if not unit sales) sell through their stores operated on the sites of other internet retailer platforms.

In 2018, CPSC contracted with Industrial Economics, Incorporated (IEC) to examine the market for magnet sets. IEC found a total of 69 sellers of magnet sets on internet platforms in late 2018. IEC also identified 10 manufacturers and 2 retailers.²⁰ CPSC staff had previously identified at least 121 sellers of magnet sets on internet retailer platforms. However, IEC found that most sellers CPSC had previously identified were no longer selling relevant magnet set products, indicating a high turnover rate for magnet set products and sellers. In 2020, CPSC staff reviewed the status of previously identified sellers of magnet sets on leading internet marketplaces and found further evidence of the high turnover rates for these platforms. Only 9 of the 69 sellers IEC identified in late 2018 were still selling magnet sets; the remainder either no longer offered magnet sets, or no longer operated on the platforms. In addition, CPSC staff identified 29 new sellers that had not been identified in late 2018.

In both 2018 and 2020, staff found that many magnet-set sellers were located domestically, or in China or Hong Kong. In 2018, approximately 57 percent of magnet set sellers on one internet platform fulfilled orders domestically, whereas, in 2020, this declined to 25 percent. In 2018, approximately 25 percent of magnet set sellers on another internet platform were domestic, whereas, in 2020, this increased to 87 percent. Non-domestic sellers were primarily in China and Hong Kong. In addition to internet retailers based in the United States, consumers can also purchase a wide variety of magnet sets using online retailers based in China. Magnet sets purchased from foreign internet retailers may be shipped to consumers directly

¹⁹ Staff’s analysis for the 2014 rule and 2020 informational briefing package focused on magnet sets.

²⁰ IEC classified manufacturers as firms producing and selling their own magnet set products, and retailers as firms that typically sell magnets from multiple manufacturers.

from China, or from warehouse facilities located domestically.

Retail prices of subject magnet products are about \$20 per unit, on average. Magnet sets comprised of spheres or cubes with smaller dimensions (2.5 mm to 3 mm) typically retail at lower prices.

As indicated above, CPSC staff primarily has information about magnet sets, however, additional products are also subject to the proposed rule. CPSC staff is aware of magnets marketed online as jewelry, jewelry-making sets, and faux studs/piercings, as well as entertainment products, such as “desk toys” and “executive toys.” CPSC requests comments about unit sales and other market information about subject magnet products, particularly for products other than magnet sets.

IV. Risk of Injury

CPSC staff analyzed reported fatalities, reported nonfatal incidents and injuries, and calculated national estimates of injuries treated in U.S. hospital emergency departments (EDs) that were associated with ingestion of subject magnet products. Staff also assessed the health outcomes associated with these incidents, as well as various characteristics of the incidents.

A. Incident Data²¹

To evaluate magnet ingestion incidents, staff reviewed reports in the National Electronic Injury Surveillance System²² (NEISS), which includes reports of injuries treated in U.S. EDs, and reports in the Consumer Product Safety Risk Management System²³ (CPSRMS). The data presented here represent the minimum number of incidents during the periods described.

1. National Estimates of ED-Treated Injuries

To evaluate magnet ingestion incidents in NEISS, staff started by identifying magnet ingestion cases in the NEISS database with treatment dates

²¹ For more details about incident data, see Tab B and Tab C of the NPR briefing package.

²² Data from NEISS are based on a nationally representative probability sample of about 100 hospitals in the United States and its territories. NEISS data can be accessed from the CPSC website under the “Access NEISS” link at: <https://www.cpsc.gov/Research--Statistics/NEISS-Injury-Data>.

²³ CPSRMS is the epidemiological database that houses all anecdotal reports of incidents CPSC receives, “external cause”-based death certificates purchased by CPSC, all in-depth investigations of these anecdotal reports, as well as investigations of select NEISS injuries. Examples of documents in CPSRMS include: Hotline reports, internet reports, news reports, medical examiner reports, death certificates, retailer/manufacturer reports, and documents sent by state/local authorities, among others.

from January 1, 2010 through December 31, 2020. Staff then excluded from this data set incidents that staff could not determine involved magnets (e.g., “acc swallowed dog toy vs magnet”); incidents that did not involve ingestion, or where it was uncertain whether ingestion occurred (e.g., “possible ingestion,” “may have ingested”); and incidents that provided ambiguous information about whether the item ingested was a magnet (e.g., the report refers to a magnet and ingestion, but it is not clear that the magnet was the object ingested). This may have resulted in underestimating the number of incidents.

From the remaining data set, staff categorized incidents by magnet type. Based on the products identified in NEISS reports, or the description of the products, staff organized cases into the following categories: Magnet sets, magnet toys, jewelry, science kits, home/kitchen, ASTM F963 magnet toys, and unidentified. The criteria staff used to categorize incidents into these groups are as follows:

- *Magnet Sets*: Magnets from sets of loose, as-received magnets that are marketed or commonly used as a manipulative or construction item for entertainment, such as puzzle working, sculpture building, mental stimulation, or stress relief. These items met at least one of the following criteria: Referred to as a magnet set or identified as a magnet set through product name. This category excludes building sets with plastic and/or ferromagnetic components, unless otherwise identified as a magnet set. This category also excludes products reasonably identified as belonging to another product type described below (e.g., a magnetic clasp from a necklace).
- *Magnet Toys*: Magnets from products referred to as toys or games. This category includes products for which the manufacturer-intended user of the toy was 14 years or older, or was

unknown, and it excludes cases that positively identified toys subject to ASTM F963 (i.e., excludes products confirmed to have been designed, manufactured, or marketed as playthings for children under 14 years of age).

- *Jewelry*: Magnets described as jewelry (i.e., magnets that are jewelry, or that were being used as or like jewelry) and not definitively identified as a magnet set. Most of these cases involve magnetic devices described as a bracelet, necklace, or piercing jewelry.

- *Science Kits*: Magnets from products identified as a science kit or magnetic/electrical experimental set.

- *Home/Kitchen*: Magnets from products such as non-toy magnet decorations, shower curtains, hardware, and kitchen products. Many of these incidents refer to the magnets as “kitchen magnets.”

- *ASTM F963 Magnet Toys*: Magnets from toys subject to ASTM F963 (i.e., products designed, manufactured, or marketed as playthings for children under 14 years old). Reports for these incidents included brand names or other information sufficient for staff to identify the involved products as toys subject to ASTM F963. Most of these cases involved the magnetic tip of a children’s magnetic stylus toy.

- *Unidentified*: Unidentified magnet product type.

As the descriptions above indicate, “magnet toys” and “ASTM F963 magnet toys” refer to two different types of products. “Magnet toys,” as used throughout this preamble, refers to products described as toys, but that did not include indications that the product was marketed for users under 14 years old. In contrast, “ASTM F963 magnet toys” refers to products that staff identified as toys marketed for children under 14 years old; as such, these products are subject to ASTM F963, and they do not fall under the scope of the proposed rule.

With respect to the science kit category, staff identified only one case that involved a product described as a science kit. There was insufficient information about the product to determine whether it was a children’s toy subject to ASTM F963, an educational product, or a subject magnet product. Because of this lack of information, and the possibility that it was a children’s toy or educational product, staff considered this case outside the scope of the proposed rule.

Staff considered the following categories to be subject magnet products: Magnet sets, magnet toys, and jewelry; these are referred to collectively as “amusement/jewelry.” These categories include incidents in which the report identified a subject magnet product as being ingested, or the incident report provided information about the product, such as characteristics or use patterns, that were sufficient for staff to reasonably conclude that the product fell in a certain product type category. Staff considered cases in the following categories to be outside the scope of the proposed rule: Science kits, home/kitchen, and ASTM F963 magnet toys; these are referred to collectively as “exclusions.” Incidents in the unidentified category did not provide sufficient information to identify the magnet product category, however, they did indicate that a magnet was ingested, and the product had characteristics and use patterns that could be consistent with subject magnet products. Section IV.A.5. *Uncertainties in Incident Data*, below, explains several reasons why staff concludes that a substantial portion of unidentified product type incidents involved subject magnet products.

Table 1 provides the number of cases in each product type category, and the combined categories reported by NEISS participating hospitals.

TABLE 1—COUNT OF MAGNET INGESTION CASES TREATED IN NEISS HOSPITAL EDS, BY MAGNET CATEGORY, 2010–2020

Original magnet category	N (original)	Combined magnet category	N (combined)
Magnet Set	58	Amusement/Jewelry	221
Jewelry	53
Magnet Toy	110
Unidentified	793	Unidentified	793
Science Kit	1	Exclusions	58
F963 magnet toy	11
Home/Kitchen	46
Total	1,072	1,072

Source: NEISS, CPSC.

As Table 1 indicates, of the incidents for which staff could identify a product type category, most incidents involved magnet toys, followed by magnet sets, and jewelry. For 74 percent of incidents, staff could not identify the product type category.

Using the information from the sample of NEISS participating hospitals, staff derived estimates of the number of magnet ingestions treated in U.S. hospitals nationally from 2010 through 2020. For staff to generate national estimates using NEISS data, all of the following reporting criteria must be met: The coefficient of variation (CV) cannot exceed 0.33, there must be at least 20

sample cases, and there must be at least 1,200 estimated injuries. Because of the large portion of NEISS incidents in the unidentified product type category, to meet these criteria, it was necessary to combine the amusement/jewelry and unidentified categories to generate national estimates, and it was not possible to generate national estimates for individual product categories. Thus, the national estimates provided in the rest of this section include incidents in both the amusement/jewelry and unidentified categories of NEISS data. Although the national estimates include magnet ingestion cases in the

unidentified product type category, there are several reasons why staff concludes that most magnet ingestion incidents in the unidentified product type category involved subject magnet products, including incident data about known product types, trend data, and recall data. Section IV.A.5.

Uncertainties in Incident Data, below, discusses, in detail, the reasons staff concludes that most unidentified product type incidents involved subject magnet products.

Table 2 provides the estimated number of ED-treated magnet ingestions for the combined categories.

TABLE 2—ESTIMATED NUMBER OF MAGNET INGESTIONS TREATED IN U.S. HOSPITAL EDs, BY MAGNET CATEGORY, 2010–2020

Magnet category	Estimate	CV	N
Amusement/Jewelry	4,400	0.17	221
Unidentified	18,100	0.14	793
Exclusions	1,300	0.20	58
Total	23,700	0.21	1,072

Source: NEISS, CPSC. Estimates rounded to the nearest 100. Summations of estimates may not add to the total estimates, due to rounding.

Table 3 provides the national estimates of ED-treated magnet ingestions, by year.

TABLE 3—ESTIMATED NUMBER OF MAGNET INGESTIONS TREATED IN U.S. HOSPITAL EDs, BY YEAR

Year	Estimate	CV	N
2010	1,900	0.18	91
2011	2,500	0.18	101
2012	2,700	0.26	115
2013	2,000	0.21	88
2014	**	**	62
2015	1,200	0.24	61
2016	1,400	0.24	77
2017	2,900	0.25	112
2018	2,400	0.18	120
2019	1,800	0.22	91
2020	2,200	0.21	96
Total	22,500	0.14	1,014

** This estimate does not meet NEISS reporting criteria.

Source: NEISS, CPSC. Estimates rounded to the nearest 100. Summations of estimates may not add to the total estimates, due to rounding.

There were significantly fewer ED-treated magnet ingestions in 2015 than in any of the following years: 2010, 2011, 2012, 2017, and 2018. Likewise, there were significantly fewer ED-treated magnet ingestions in 2016 than

in any of the following years: 2011, 2017, and 2018. Overall, 2014 through 2016 had the lowest number of estimated ED-treated magnet ingestions. Table 4 compares these middle 3 years (*i.e.*, 2014–2016) with the earliest 4

years (*i.e.*, 2010–2013), and the most recent 4 years (*i.e.*, 2017–2020). Because these periods are not of equivalent duration, staff estimated annual averages to support fair comparisons.

TABLE 4—ESTIMATED NUMBER OF MAGNET INGESTIONS TREATED IN U.S. HOSPITAL EDs, BY PERIOD

Period	Annual average estimate	CV	N (not an average)	Years in period
2010–2013	2,300	0.16	395	4
2014–2016	1,300	0.20	200	3

TABLE 4—ESTIMATED NUMBER OF MAGNET INGESTIONS TREATED IN U.S. HOSPITAL EDs, BY PERIOD—Continued

Period	Annual average estimate	CV	N (not an average)	Years in period
2017–2020	2,300	0.15	419	4
2010–2020	2,000	0.14	1,014	11

Source: NEISS, CPSC. Estimates are rounded to the nearest 100. Summations of estimates may not add to the total estimates, due to rounding.

Table 5 provides estimated ED-treated magnet ingestions, by age group.

TABLE 5—ESTIMATED NUMBER OF MAGNET INGESTIONS TREATED IN U.S. HOSPITAL EDs, BY AGE GROUP, 2010–2020

Age group	Estimate	CV	N
Under 2 years	2,700	0.19	120
2 years	2,300	0.27	89
3–4 years	4,700	0.16	196
5–7 years	4,300	0.14	207
8–10 years	3,900	0.19	179
11–13 years	3,400	0.17	182
14 or More years	**	**	41
Total	22,500	0.14	1,014

** This estimate does not meet NEISS reporting criteria.

Source: NEISS, CPSC. Estimates are rounded to the nearest 100. Summations of estimates may not add to the total estimates, due to rounding.

Table 6 provides the estimated number of ED-treated magnet ingestions, by sex.

TABLE 6—ESTIMATED NUMBER OF MAGNET INGESTIONS TREATED IN U.S. HOSPITAL EDs, BY SEX, 2010–2020

Sex	Estimate	CV	N
Female	9,100	0.15	421
Male	13,300	0.14	593
Total	22,500	0.14	1,014

Source: NEISS, CPSC. Estimates are rounded to the nearest 100.

Table 7 provides the estimated number of ED-treated magnet ingestions, by sex and age group. Staff used 8 years old to delineate older and younger children because, as discussed in section V. Relevant Existing Standards, several voluntary standards provide less stringent requirements for magnet products intended for users 8 years and older.

TABLE 7—ESTIMATED NUMBER OF MAGNET INGESTIONS TREATED IN U.S. HOSPITAL EDs, BY SEX AND AGE GROUP, 2010–2020

Sex	Age group		Total
	Under 8 years	8 or more years	
Female	5,600	3,500	9,100
Male	8,400	4,900	13,300
Total	14,000	8,500	22,500

Source: NEISS, CPSC. Estimates are rounded to the nearest 100. Summations of estimates may not add to the total estimates, due to rounding.

Table 8 provides the estimated number of ED-treated magnet ingestions, by disposition.

TABLE 8—ESTIMATED NUMBER OF MAGNET INGESTIONS TREATED IN U.S. HOSPITAL EDs, BY DISPOSITION, 2010–2020

Disposition	Estimate	CV	N
Hospitalized/Transferred	4,200	0.19	264
Treated and Released	18,000	0.14	735
Other*	**	**	15
Total	22,500	0.14	1,014

* Dispositions in the “other” category include cases in which the victim was “held for observation (includes admitted for observation)” and “left without being seen/left against medical advice.”

** This estimate does not meet reporting criteria.

Source: NEISS, CPSC. Estimates are rounded to the nearest 100. Summations of estimates may not add to the total estimates, due to rounding.

As Table 8 indicates, approximately 80 percent of estimated ED-treated magnet ingestions are treated and released, and approximately 19 percent are hospitalized or treated and transferred to another hospital. Some portion of cases that report the victim being treated and released may have resulted in later hospitalization because magnet ingestion patients are often sent home initially to monitor for natural passage, and the NEISS data typically capture only one part of the treatment process—the ED visit—and do not typically provide information about treatment after the initial ED visit.

2. Reported Incidents

CPSC staff also reviewed CPSRMS data for magnet ingestion incidents. CPSRMS reports commonly contain more information about the incident, product, and victims than NEISS reports because CPSRMS reports may provide photos and websites with detailed narratives and medical documents, whereas, NEISS reports contain only brief narratives from the ED visit. However, CPSRMS data do not provide a complete count of all incidents that occurred during a period, and unlike NEISS data, CPSRMS cannot be used for statistical estimates or to draw conclusions about trends. Rather, CPSRMS data provide a minimum number of incidents that occurred during a period and provide details about incidents.

CPSC staff identified 284 magnet ingestion incidents in CPSRMS that were reported to have occurred between January 1, 2010 and December 31, 2020. Data collection is ongoing for CPSRMS, and is considered incomplete for 2019 and after, so CPSC may receive additional reports for those years in the future. Staff categorized these cases similarly to the NEISS incidents, however, there are some minor differences in the criteria because

CPSRMS reports typically contained more product-specific information than NEISS reports. Based on the products identified in the CPSRMS reports or the descriptions of the products, staff organized cases into the following categories: Magnet sets, magnet toys, jewelry, science kits, home/kitchen, ASTM F963 magnet toys, and unidentified. The criteria staff used to categorize incidents into these groups are as follows:

- Magnet Sets: Magnets from sets of loose, as-received magnets that are marketed or commonly used as a manipulative or construction item for entertainment, such as puzzle working, sculpture building, mental stimulation, or stress relief. These items met at least one of the following criteria:
 - Referred to as a magnet set;
 - identified as a magnet set through product name;
 - included photos identifying the product; or
 - other available information provided reasonable certainty that the product was a magnet set (e.g., products described identically to known magnet sets, such as desk toys consisting of 216 loose, magnetic balls).

Brand was indicated for most of these incidents. Incidents were excluded from this grouping if a medical professional identified the product as a magnet set, but the investigator and victim indicated that they were unable to identify the product as a magnet set.

- Magnet Toys: Magnets from products referred to as toys or games. This category includes products for which the manufacturer-intended user of the toy was 14 years or older, or was unknown, and excludes cases that positively identified toys subject to ASTM F963 (i.e., excludes products confirmed to have been designed, manufactured, or marketed as playthings for children under 14 years of age).

- Jewelry: Magnets described as jewelry and not definitively identified as a magnet set. Most of these cases involve magnets described as a bracelet, necklace, or piercing jewelry.

- Science Kits: Magnets from products identified as a science kit or magnetic/electrical experimental set. (No reported incidents fit in this category.)

- Home/Kitchen: Magnets from products such as non-toy magnet decorations, shower curtains, hardware, and kitchen products.

- ASTM F963 Magnet Toys: Magnets from toys subject to ASTM F963 (i.e., products designed, manufactured, or marketed as playthings for children under 14 years old). Reports for these incidents included brand names or other information sufficient for staff to identify the products involved as toys subject to ASTM F963. Most of these cases involved magnetic building sets with magnets encased in plastic.

- Unidentified: Unidentified magnet product type.

Like NEISS product type categories, “magnet toys” and “ASTM F963 magnet toys” refer to two different types of products. Staff categorized as “magnet toys” products described as toys, which did not have evidence of having been marketed for users under 14 years old. In contrast, “ASTM F963 magnet toys” are toys staff identified as marketed for children under 14 years old, making them subject to ASTM F963, and outside the scope of the proposed rule.

Consistent with the NEISS data analysis, staff considered the following categories to be subject magnet products: Magnet sets, magnet toys, and jewelry; these are referred to collectively as “amusement/jewelry.” These categories include incidents in which the report identified a subject magnet product as being ingested, or the incident report provided information about the product, such as

characteristics or use patterns, which were sufficient for staff to reasonably conclude that the product fell in a certain product type category. Staff considered incidents in the following categories to be outside the scope of the proposed rule: Science kits, home/kitchen, and ASTM F963 magnet toys; these are referred to collectively as

“exclusions.” Incidents in the unidentified category did not provide sufficient information to identify the magnet product category, however, they did indicate that a magnet was ingested, and the product had characteristics and use patterns that could be consistent with subject magnet products. As with the NEISS cases, staff concludes that a

substantial proportion of the unidentified category involved subject magnet products (see section IV.A.5. *Uncertainties in Incident Data*, below).

Table 9 provides the number of reported magnet ingestions in each category.

TABLE 9—REPORTED MAGNET INGESTIONS, BY MAGNET CATEGORY, 2010–2020

Magnet category	Incidents	Proportion (%)	Scope	Incidents	Proportion (%)
Magnet Set	134	47.2	Amusement/Jewelry	214	75.4
Magnet toy	49	17.3			
Jewelry	31	10.9			
Unidentified	43	15.1	Unidentified	43	15.1
Science Kit	0	0			
F963 Magnet Toy	21	7.4			
Home/Kitchen	6	2.1			
Total	284	100.0%	Total	284	100.0%

Note: CPSRMS reporting for 2019–2020 is ongoing.

As Table 9 shows, of the incidents for which staff could identify a product type category, most involved magnet sets, followed by magnet toys, and jewelry. Fewer cases involved products that are not subject magnet products (*i.e.*, science kits, ASTM F963 magnet toys, and home/kitchen). Compared to NEISS data, far fewer incidents involved unidentified product types.

To further analyze CPSRMS data, staff combined the following categories—magnet sets, magnet toys, jewelry, and

unidentified. Staff included the unidentified product type category in this analysis because, as noted for NEISS data, there are several reasons that staff concludes that most magnet ingestion incidents in the unidentified product type category involved subject magnet products, including incident data about known product types, trend data, and recall data. Section IV.A.5. *Uncertainties in Incident Data*, below, discusses, in detail, the reasons staff concludes that most unidentified

product type incidents involved subject magnet products. Thus, the data provided in the rest of this section includes incidents in both the amusement/jewelry and unidentified categories of CPSRMS data.

Figure 1 shows the reported CPSRMS magnet ingestion incidents, by year of incident and product type category.

BILLING CODE 6355-01-P

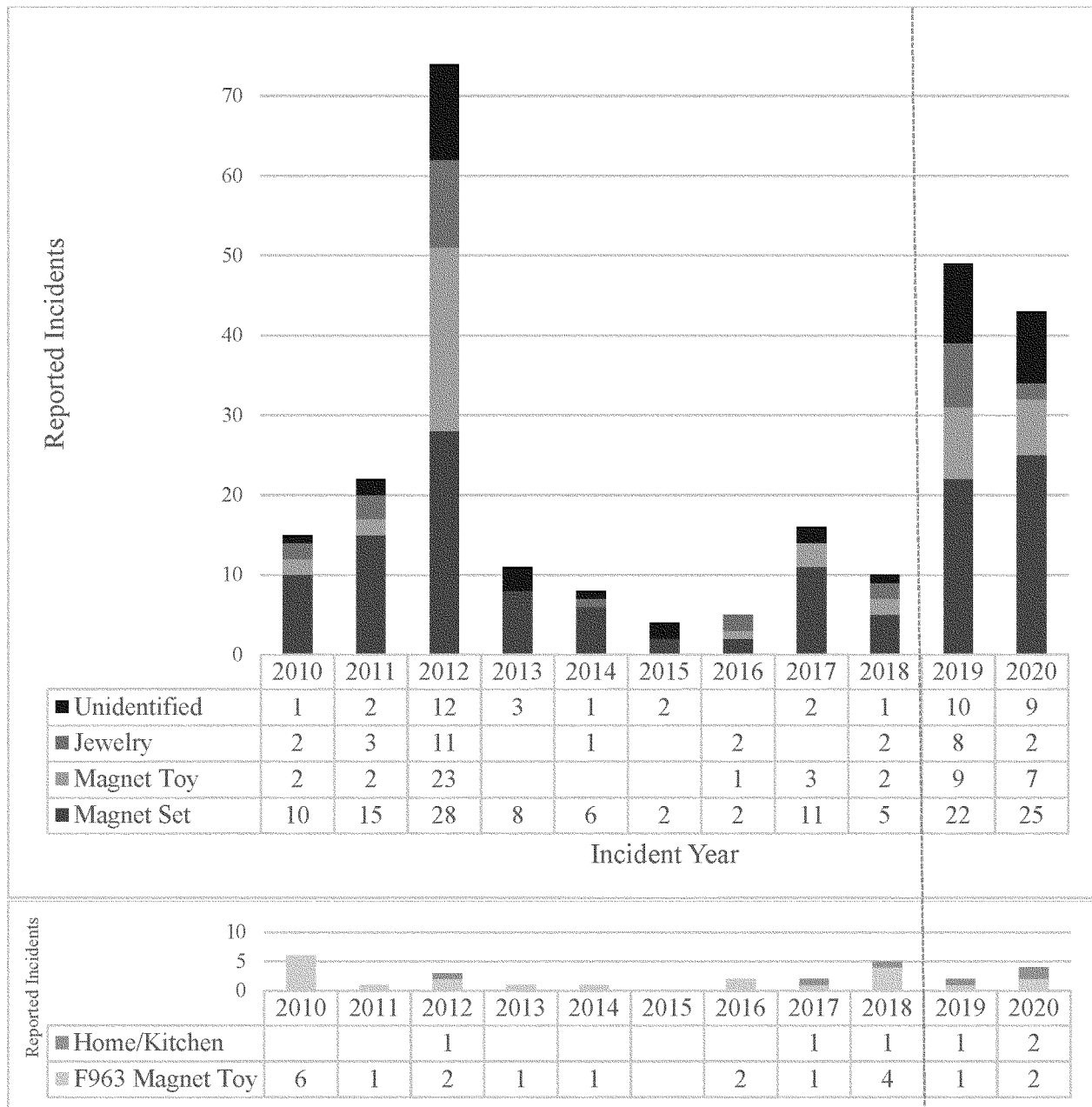

Note: CPSRMS reporting for 2019-2020 is ongoing.

Figure 1: Histogram of Reported Magnet Ingestion Incidents, by Incident Year and Magnet Category, 2010-2020

Although CPSRMS data cannot be used to draw statistical conclusions, this data suggests that magnet ingestion incidents increased in 2012, 2019, and

2020, and were lowest in 2015 and 2016, consistent with the results seen in the NEISS data.

Figure 2 shows reported magnet ingestions, by victim age and product type category.

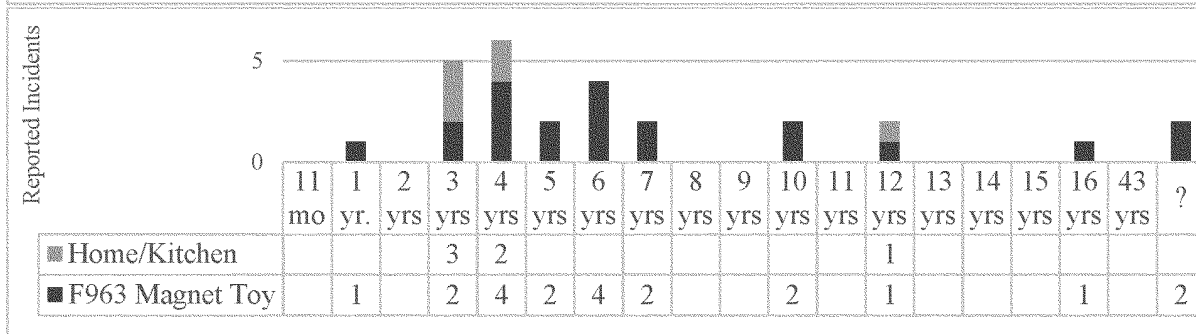
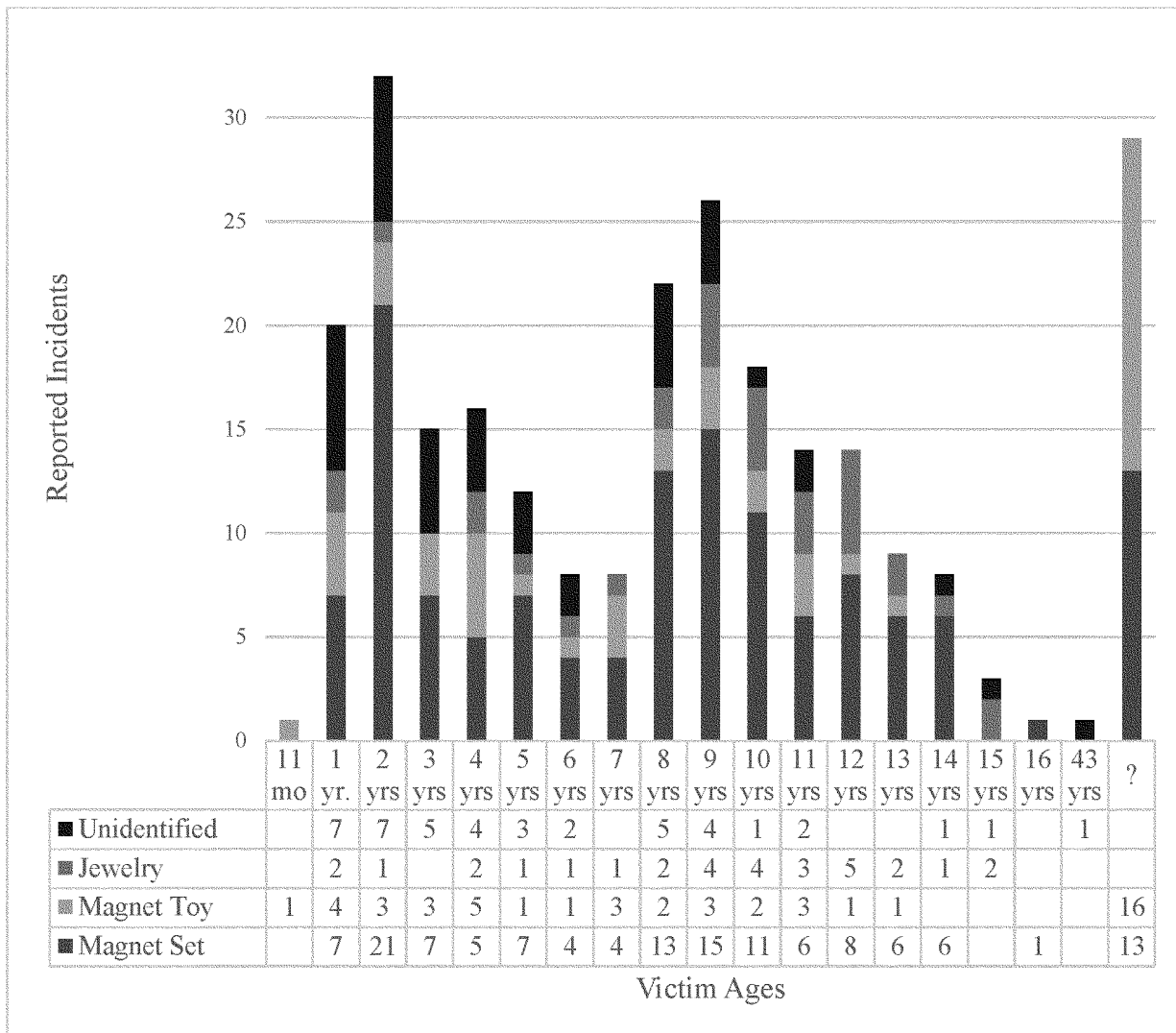

Note: CPSRMS reporting for 2019-2020 is ongoing. Incidents for which the victim’s age is unknown are indicated under “?” and are not graphed. For one victim in the “15 yrs” category, the report included conflicting information, and the victim may have been 16 years old.

Figure 2: Histogram of Reported Magnet Ingestion Incidents, by Victim Age and Magnet Category, 2010-2020

Again, although CPSRMS data cannot be used to draw statistical conclusions, the data suggest that children and teens of all ages ingest magnets, and similar

to the NEISS data, most magnet ingestions involve children 5 years or older, with almost half of the ingestions involving children 8 years or older.

Table 10 provides the disposition of reported magnet ingestion cases, by product type category.

TABLE 10—REPORTED MAGNET INGESTION INCIDENTS, BY DISPOSITION AND MAGNET CATEGORY, 2010–2020

Magnet category	Disposition			
	Death	Hospitalization	Other	Total
Magnet Sets		88	46	134
Magnet Toys		36	13	49
Jewelry		21	10	31
Unidentified	24 3	27	13	43
ASTM F963 Magnet Toys		10	11	21
Home/Kitchen		5	1	6
Total	3	187	94	284

Note: CPSRMS reporting for 2019–2020 is ongoing.

As Table 10 indicates, of the 284 ingestions reported to have occurred between January 1, 2010 and December 31, 2020, the vast majority resulted in hospitalization, and three resulted in death. The remaining “other” dispositions include all remaining reported incidents that did not report either hospitalization or death.

In analyzing CPSRMS magnet ingestion incidents, CPSC staff identified at least 124 cases that resulted in some form of surgery, including laparoscopy, laparotomy, appendectomy, cecostomy, enterotomy, colostomy, cecectomy, gastrotomy, jejunostomy, resection, and transplant. Numerous additional cases resulted in less-invasive procedures than surgery, such as endoscopies and colonoscopies, and could have resulted in surgery if the magnets had not been retrieved soon after ingestion. In 108 cases, the reports specifically described the magnets internally attracting through bodily tissue, and for other cases, there was insufficient information to determine if the surgeries were a result of the magnetic properties.

3. Fatalities

The CPSRMS data above indicate that staff identified three fatal magnet ingestion incidents that were reported to have occurred during the period staff used for incident data analysis—January 1, 2010 and December 31, 2020. However, in total, CPSC is aware of seven deaths involving the ingestion of hazardous magnets between November 24, 2005 and January 5, 2021.²⁵ Five of these deaths occurred in the United

States. In 2005, a 20-month-old child’s death involved ingestion of magnets from a children’s toy building set with plastic-encased magnets; the product was later recalled. In 2013, a 19-month-old child’s death involved multicolored, 5 mm diameter, spherical magnets from an unidentified product. In 2018, a 2-year-old child’s death involved multicolored, 3–5 mm diameter, spherical magnets, with indications that the product likely was a magnet set. In 2020, a 43-year-old man’s death involved magnets from an unknown product. In 2021, a 15-month-old-child’s death involved a magnet set of an unknown brand. In addition, CPSC is aware of two deaths in other countries that involved ingestion of hazardous 5 mm diameter, spherical NIB magnets. In Australia in 2011, an 18-month-old child’s death involved a product that included indications that it may have been a magnet set; and in Poland in 2014, an 8-year-old child’s death involved a product that appeared likely to be a magnet set. One of these seven incidents involved a children’s amusement product; one explicitly identified the product as a magnet set; and another four incidents described the products as having characteristics consistent with magnet sets.

4. Incident Data Surrounding the Vacated Magnet Sets Rule

In looking at annual magnet ingestion incidents, staff noted a considerable change in magnet ingestion rates before, during, and after the Commission’s vacated rule on magnet sets. As discussed above, the Commission issued

a final rule in October 2014 that applied to magnet sets, which are a subset of the subject magnet products addressed in this proposed rule. The magnet sets rule aimed to address the magnet ingestion hazard and consisted of size and strength limits consistent with the requirements in this proposed rule. The magnet sets rule took effect in April 2015 and remained in effect until it was vacated by the U.S. Court of Appeals for the Tenth Circuit Court in November 2016. CPSC’s assessment of incident data, as well as other researchers’ assessments of NEISS data, and national poison center data, indicate that magnet ingestion cases significantly declined during the years in which the magnet sets rule was announced and in effect, compared to the periods before and after the rule.

As Table 3,²⁶ above, shows, the number of estimated ED-treated magnet ingestion incidents was significantly lower in 2015—when the magnet sets rule was in effect—than in the years before the rule was announced (specifically, 2010, 2011, 2012) and the years after the rule was vacated (specifically, 2017 and 2018). Similarly, the number of estimated ED-treated magnet ingestion incidents was significantly lower in 2016—when the rule was in effect—than before the rule was announced (specifically, 2011) and the years after the rule was vacated (specifically, 2017 and 2018).²⁷

²⁴ As discussed below, staff identified a total of 7 deaths resulting from magnet ingestions between November 24, 2005 and January 5, 2021. The 3 deaths reflected here include only the fatalities that occurred in the United States between January 1, 2010 and December 31, 2020.

²⁵ The additional deaths are not included in Table 10 because they occurred outside the timeframe of staff’s data analysis or outside the United States.

²⁶ Table 3 provides national estimates of magnet ingestions per year for incidents categorized as amusement/jewelry and unidentified product types.

²⁷ Statistically significant differences are not reported for the year 2014, because the corresponding estimate does not meet reporting criteria.

To assess these trends further, staff grouped years in relation to the vacated magnet sets rule, using the following periods: 2010 through 2013 (prior to the announcement of the rule), 2014 through 2016 (when the final rule was announced and in effect²⁸), and 2017 through 2020 (after the rule was vacated). Table 4, above, shows the estimated number of magnet ingestions treated in U.S. hospital EDs during these periods, using annual estimates for each period to account for the periods including different numbers of years

(i.e., 2014–2016 covers 3 years, whereas, 2010–2013 and 2017–2020 cover 4-year periods). For 2010–2013 and 2017–2020, there were an estimated 2,300 ED-treated magnet ingestion incidents per year; for 2014–2016, there were an estimated 1,300 ED-treated magnet ingestion incidents per year. Thus, during the period when the rule was announced and in effect (2014–2016), there were appreciably fewer magnet ingestions compared with the earlier and more recent periods, and there were

nearly equivalent rates during the periods both before and after the rule.

Although CPSRMS data cannot be used to draw statistical conclusions, the data also suggest a similar decline in incidents for the period when the magnet sets rule was announced and in effect. Table 11 shows CPSRMS-reported magnet ingestions, by period, using incidents categorized as amusement/jewelry and unidentified product types, consistent with the NEISS analysis, above.

TABLE 11—NUMBER OF CPSRMS-REPORTED MAGNET INGESTIONS, BY PERIOD

Period	Percent of total	N	Years in period
2010–2013	47.5	122	4
2014–2016	6.6	17	3
2017–2020	45.9	118	4
2010–2020	100	257	11

Source: CPSRMS. Percentages are rounded to the nearest tenth. CPSRMS reporting for the years 2019–2020 is ongoing and counts for those years may increase as reporting continues.

Consistent with NEISS trends shown in Table 3, Table 11 shows that CPSRMS data also reflect an appreciable decline in magnet ingestion incidents during the period when the magnet sets rule was announced and in effect (2014–2016), compared with earlier and more recent periods, and nearly equivalent incident rates during the periods both before and after the rule.

Other researchers analyzing NEISS data made similar findings. One study²⁹ reviewed magnet ingestions for children under 18 years old using NEISS data from 2009 through 2019, focusing on three periods: 2009 through 2012 (before the Commission rule on magnet sets); 2013³⁰ through 2016 (magnet sets rule announced and in effect); and 2017 through 2019 (after the rule was vacated). In 2009–2012, there was an

aggregate mean ED-visit rate of 3.58³¹ per 100,000 people; in 2013–2016, this decreased to 2.83³² per 100,000 people;³³ and in 2017–2019, this increased to 5.16³⁴ per 100,000 people.³⁵ Like CPSC’s analysis, this illustrates an appreciable decline in magnet ingestions during the period the magnet sets rule was announced and in effect, with an even greater increase in incidents after the rule than before it.

Another study³⁶ found similar results when looking at suspected magnet ingestion (SMI) cases involving children under 18 years old using NEISS data. That study found that there were an estimated 23,756³⁷ total SMI cases between 2009 and 2019, of which an estimated 3,709³⁸ cases involved small/round magnets and 6,100³⁹ involved multiple magnets. The average annual

increase in total cases was 6.1 percent for 2009 to 2019,⁴⁰ and there was a statistically significant increase in small/round magnet ingestions⁴¹ and multiple magnet ingestions⁴² between 2009 and 2019. When stratified by period, there were 6,391⁴³ estimated total magnet ingestion cases during 2013–2016,⁴⁴ or 1,598⁴⁵ estimated cases per year. In contrast, there were an estimated 8,478⁴⁶ cases from 2017–2019, or 2,826⁴⁷ per year. This represents a 32 percent increase⁴⁸ in total magnet ingestions after 2016. There was also a statistically significant increase in the number of estimated small/round⁴⁹ and multiple magnet⁵⁰ ingestions across these two periods, with 164⁵¹ small/round and 350⁵² multiple magnet ingestions from 2013 through 2016, compared to 541⁵³ small/

²⁸ Staff grouped 2014, 2015, and 2016 together for this analysis because these are the years firms were likely to comply with the size and strength limits in the magnet sets rule. Because the standard took effect in April 2015 and remained in effect until November 2016, firms were required to comply with the standard for nearly all of 2015 and 2016. Although the rule was not in effect in 2014, the proposed rule was published in 2012, and the final rule was published, with essentially the same requirements, in October 2014. Once an NPR is published, firms have notice to prepare for the requirements that may be finalized, and once a final rule is published, firms often take steps to comply with the rule even before it takes effect. Accordingly, it is reasonable to conclude that firms took steps to comply with the magnet sets standard in 2014.

²⁹ Flaherty, M.R., Buchmiller, T., Vangel, M., Lee, L.K. Pediatric Magnet Ingestions After Federal Rule Changes, 2009–2019. *JAMA*. Nov. 24, 2020. 324(20): 2102–2104. doi:10.1001/jama.2020.19153, available

at: <https://www.ncbi.nlm.nih.gov/pmc/articles/PMC7686864/>.

³⁰ For CPSC’s analysis, staff considered 2014 to be the year the rule was announced because that is the year the final rule was published. In contrast, this study considered 2013 to be the year the rule was announced, likely because that is the first full year after the rule was initially announced in an NPR in September 2012.

³¹ 95% confidence interval (CI), 2.20–4.96.

³² 95% CI, 1.60–4.06.

³³ Slope change, 0.87 (95% CI, 0.71–1.03) ED visits per 100,000 annually.

³⁴ 95% CI, 3.22–7.11.

³⁵ Slope change, –0.58 (95% CI, –0.68 to –0.47) per 100,000 persons annually.

³⁶ Reeves, P.T., Rudolph, B., Nylund, C.M. Magnet Ingestions in Children Presenting to Emergency Departments in the United States 2009–2019: A Problem in Flux. *Journal of Pediatric Gastroenterology and Nutrition*. Dec. 2020. 71(6):699–703, 10.1097/MPG.0000000000002955,

available through: <https://pubmed.ncbi.nlm.nih.gov/32969961/>.

³⁷ CI, 15,878–30,635.

³⁸ CI, 2,342–5,076.

³⁹ CI, 3,889–8,311.

⁴⁰ P = 0.01.

⁴¹ P <0.001.

⁴² P = 0.02.

⁴³ CI, 4,181–8,601.

⁴⁴ Like the previous study, these researchers considered 2013 to be part of the period during which magnet sets were likely to be off the market.

⁴⁵ CI, 1,045–2,150.

⁴⁶ CI, 5,472–11,485.

⁴⁷ CI, 1,824–3,828.

⁴⁸ P <0.001.

⁴⁹ P <0.01.

⁵⁰ P <0.001.

⁵¹ CI, 66–263.

⁵² CI, 200–500.

⁵³ CI, 261–822.

round and 797⁵⁴ multiple magnet ingestion cases from 2017 through 2019.

Researchers⁵⁵ analyzing national poison center data also found an increase in magnet ingestions in recent years, particularly since the magnet sets rule was vacated. This study looked at magnet foreign body injuries in pediatric patients in the National Poison Data System (NPDS). For 2012–2017, there were 281 magnet exposure calls per year, compared to 1,249 calls per year for 2018–2019, representing a 444 percent increase. Considering cases dating back to 2008 (5,738 total), the cases from 2018 and 2019, alone, account for 39 percent of the magnet cases. Although these periods do not directly align with the magnet sets rule, they further illustrate the general increase in magnet ingestion incidents in recent years, particularly after the magnet sets rule was vacated.

These analyses raise relevant considerations for this proposed rule. For one, the marked decline in incidents during the period when the magnet sets rule was announced and in effect suggests that a large portion of magnet ingestion incidents involve magnet sets. Because that rule applied only to magnet sets, the fact that incidents significantly declined during the pendency of that rule indicates that magnet sets were involved in most of the incidents. This is useful information, given the lack of details regarding product types involved in many magnet ingestion incidents. In addition, these analyses indicate the current need to address the magnet ingestion hazard. Magnet ingestion incidents have significantly increased in recent years, showing a heightened need to address the hazard. Finally, these analyses suggest that a mandatory standard is necessary to effectively reduce the risk of injuries and death associated with magnet ingestions. Before, during, and after the magnet sets rule, CPSC and other groups have worked to raise awareness of the magnet ingestion hazard, and CPSC has taken steps to address the hazard through information campaigns, recalls, and voluntary standards work. However, the only appreciable decline in magnet ingestion incidents occurred during the period when the mandatory standard for magnet sets was announced and in effect.

⁵⁴ CI, 442–1152.

⁵⁵ Middelberg, L.K., Funk, A.R., Hays, H.L., McKenzie, L.B., Rudolph, B., Spiller, H.A. Magnet Injuries in Children: An Analysis of the National Poison Data System From 2008–2019. *The Journal of Pediatrics*. May 1, 2021. Volume 232, P251–256.E2, available at: doi: <https://doi.org/10.1016/j.jpeds.2021.01.052>.

5. Uncertainties in Incident Data

As explained above, magnet ingestion incident reports often include limited information for staff to identify the type of product involved in the magnet ingestion. Caregivers and medical providers may know that a magnet was ingested, but may not know from what type of product the magnet came. This differs from many consumer products that are readily identifiable when involved in an incident and report. NEISS data, in particular, tend to provide limited information with which to identify the product involved in magnet ingestions. This may be because NEISS data are collected through hospital EDs. At hospital EDs, medical professionals may not know what product was the source of the magnet ingestion, and are focused on information needed to treat the victim (e.g., that a magnet was ingested), rather than the specific product involved in the incident (e.g., that the magnet came from a magnet set). Because CPSRMS data usually come from manufacturers and consumers, these data often contain more information to identify the product.

As Table 1, above, shows, of the 1,072 magnet ingestion incidents identified in NEISS, 74 percent (793 incidents) did not provide sufficient information for staff to identify the type of product involved. As Table 9, above, shows, of the 284 magnet ingestion incidents identified in CPSRMS, 15 percent (43 incidents) did not provide sufficient information for staff to identify the type of product involved. However, staff does have some information about the incidents in the unidentified product type category—specifically, these incidents involved ingestion of one or more magnets, and included product characteristics and use patterns that could be consistent with subject magnet products.

To account for the lack of product identification in many magnet ingestion incidents, staff analyzed magnet ingestion incident data in several ways. For one, staff provided information about all magnet ingestion cases. Aggregated information for all of the in-scope, out-of-scope, and unidentified product categories indicates that magnet ingestions, in general, are an issue, and have increased in recent years. This indicates the propensity for children and teens to ingest magnets, and it demonstrates the increasing risk of injury and death as magnet ingestion cases increase.

Staff also categorized incidents into specific product groups, based on information that was available in

incident reports. For incidents that provided information to help identify the product type, the data revealed that six categories of products were involved in magnet ingestions—magnet sets, jewelry, magnet toys, science kits, ASTM F963 magnet toys, and home/kitchen magnets. For some of the incidents in these categories, there was specific information about the product—such as brand names—that allowed staff to determine the product involved in the incident. For other incidents in these categories, the product was referred to as a specific type (e.g., magnet sets, desk toy, science kit, kitchen magnet, bracelet).⁵⁶ These categories provide information about the products involved in magnet ingestions, and the relative frequency of their involvement, to help determine which products the proposed rule should address.

Staff also aggregated these categories into in-scope and out-of-scope groupings. Staff combined incidents from the magnets sets, magnet toys, and jewelry categories as “amusement/jewelry” and combined incidents from the home/kitchen, ASTM F963 magnet toys, and science kit categories as “exclusions.” Grouping several product type categories together allowed staff to generate national estimates of ED-treated magnet ingestions, to provide an idea of the number of ingestions nationally, and the relative involvement of in-scope and out-of-scope products, which helps identify the magnitude of the risk and the potential benefits of the rule to reduce that risk.

In addition, staff combined the amusement/jewelry and unidentified categories to conduct more detailed analyses. Because the proposed rule applies to amusement and jewelry products, the amusement/jewelry category of incidents is informative.

⁵⁶ Staff categorized incidents based on all of the information available in the reports, including descriptions, names, and uses of the product. However, for some of the incidents in which the report provided a product type, but not a specific product brand/name, it is possible that the product was actually from another category. For example, the jewelry category includes cases in which the report indicates that the magnets were described as jewelry at the time of the incident, such as magnetic earrings. It is possible that the magnets in such cases were actually from a non-jewelry product. Similarly, products categorized as magnet toys could actually be another product type; for example, a product described as an “executive desk toy,” which did not meet the parameters for the magnet set category, and did not indicate marketing to children under 14 years old, was included in the magnet toy group, although it is possible that the product actually was a magnet set or other product type, and the report lacked information to indicate this. However, even if incidents in these categories were miscategorized, they likely would still fall within the scope of the proposed rule because they meet the description of an in-scope product.

Staff also included in these analyses, incidents in the unidentified product type category because there are several factors that indicate that many of the incidents in the unidentified product type category likely fall within the scope of the proposed rule. The following is a discussion of these factors.

First, the incident data discussed in this preamble supports the conclusion that many of the magnet ingestion incidents in the unidentified product type category actually involved subject magnet products. Of the NEISS magnet ingestion incidents for which staff could identify a product category, the primary products involved were magnet sets, magnet toys, and jewelry; far fewer incidents involved ASTM F963 magnet toys, home/kitchen magnets, or science kits (see Table 1, above). The same was true for CPSRMS incidents (see Table 9, above), for which far fewer incidents were in the “unidentified” category. Given this consistency across data sets, it is reasonable to conclude that the relative involvement of magnet product types in magnet ingestions applied to the incidents that lacked product identification as well.

Second, magnet ingestion rates before, during, and after the vacated rule on magnet sets suggest that a significant portion of magnet ingestion cases involve magnet sets. As discussed above, CPSC’s assessment of incident data, as well as other researchers’ assessments of NEISS data, and national poison center data, indicate that magnet ingestion cases significantly declined during the years the magnet sets rule was announced and in effect, compared to the periods before and after the rule. Magnet sets were the only products subject to that rule. As such, the significant decline in incidents during that rule, and the significant increase in incidents after that rule was vacated, strongly suggest that many magnet ingestion incidents involve magnet sets. Thus, it is reasonable to assume that many of the incidents in the unidentified product category involved magnet sets. Moreover, the definition of “magnet sets” in the vacated rule was largely equivalent to the description of amusement products in the present proposed rule (*i.e.*, magnet sets and magnet toys), suggesting that many magnet ingestion incidents, including those with unidentified product types, involve amusement products.

Third, incident data and recalls regarding magnets in children’s toys further support the conclusion that magnet ingestions categorized as “unidentified” products are largely subject magnet products. As discussed

above, ASTM F963 magnet toys make up only a small portion of magnet ingestion incidents where the product can be identified. It is reasonable to assume that this holds true for unidentified products in magnet ingestions, as well. Recall information further supports this conclusion. Recalls of children’s toys involving the magnet ingestion hazard have declined substantially since the toy standard took effect. As explained above, ASTM F963 was announced as the mandatory standard for toys in 2008, and it took effect in 2009. From 2006 through 2009, CPSC issued more than a dozen recalls of children’s toys, due to the ingestion hazard associated with loose or separable, small, powerful magnets.⁵⁷ In contrast, from January 2010 through August 2021—a period approximately three times as long—there were a total of 18 recalls related to the magnet ingestion hazard, only four of which involved children’s toys. Of those four recalls, only two involved confirmed violations of the magnet provisions in the toy standard. Recalls provide some indication of the products involved in magnet ingestions because products are recalled when they present a hazard. Thus, this marked decline in recalls of children’s toys for magnet ingestion hazards suggests that children’s toys largely comply with the toy standard and are not involved in hazardous incidents.

Taken together, these factors support the conclusion that most magnet ingestion incidents, including those in the unidentified product type category, involved products that fall within the magnet sets, magnet toys, and jewelry categories, and not the science kit, home/kitchen, or ASTM F963 magnet toys categories. For these reasons, staff included magnet ingestion incidents in the unidentified product type category in many of its analyses; to exclude such incidents likely would vastly underrepresent ingestions of subject magnet products.

*B. Details Concerning Health Outcomes*⁵⁸

Magnets are unique among ingested foreign bodies because of their intrinsic

ability to attract to one another or to ferromagnetic objects. Assuming the same elemental composition, a magnet with large physical dimensions and mass can exhibit stronger attractive forces than a magnet with small physical dimensions and mass. Similarly, magnets coupled together can exhibit greater attractive strengths than individual magnets. One mechanism of injury following magnet ingestion involves separate magnets in adjacent tissue walls (*e.g.*, from distinct loops of bowel) attracting to each other and trapping tissue between the magnets. The mechanism of injury is the same for a single hazardous magnet and a ferromagnetic object that might interact internally. As such, individual magnets pose the same health risk.

Health threats posed by magnet ingestion include pressure necrosis, volvulus, bowel obstruction, bleeding, fistulae, ischemia, inflammation, perforation, peritonitis, sepsis, ileus, ulceration, aspiration, and death, among others. The normal functions of the gastrointestinal (GI) tract, including peristalsis, are not likely to dislodge magnets that are attracted to each other through component tissues.

The time between magnet ingestion and injury varies and depends on several factors, such as the number of ingested magnets; awareness of the magnet ingestion by caregivers; awareness that magnet ingestion is hazardous; whether multiple ingested magnets interact with each other inside of the body through tissue structures; and the configuration of coupled magnets, relative to involved tissue structures. Incident reports describe injuries from internal magnet interaction through tissue taking anywhere from days to months to progress to a stage at which caregivers seek medical attention. There have been several efforts to develop medical devices using magnets to deliberately compress and necrose⁵⁹ target tissue and create healthy anastomoses (openings/passages) that connect or reconnect distinct channels in the body. In these controlled cases, tissue necrosis typically took multiple days to weeks.⁶⁰

Informational%20Briefing%20Package%20Regarding%20Magnet%20Sets.pdf. Even though the previous analyses focused on magnet sets, the internal magnet interaction hazard is the same for the subject magnet products covered in this proposed rule.

⁵⁹ Necrosis is a process of cell death.

⁶⁰ These efforts are still in early stages, but may ultimately provide some examples of the time it takes for tissue necrosis to occur from magnetic compression. Although not pathological examples, the length of time required for successful

⁵⁷ https://www.cpsc.gov/s3fs-public/pdfs/recall/lawsuits/abc/163--2017-10-26%20Final%20Decision%20and%20Order.pdf?Tme8u5jRF2.29_B.i4Ix7pPwb_whKng2.

⁵⁸ For more details about injuries and health outcomes, see Tab A of the NPR briefing package. In addition, health outcomes associated with magnet ingestions are discussed in the Final Rule briefing package for the 2014 rule on magnet sets, available at: https://www.cpsc.gov/s3fs-public/pdfs/foia_SafetyStandardforMagnetSets-FinalRule.pdf, and the 2020 informational briefing package, available at: <https://www.cpsc.gov/s3fs-public/>

Ambiguous symptomatology following magnet ingestion that results in an internal interaction injury may complicate the timely delivery of medical care. Symptoms related to magnet ingestion may appear flu-like and include vomiting, fever, and abdominal pain, among others. Symptoms following magnet ingestion have been mistaken for a virus, ear infection, and bronchitis, among others. Medical professionals who know of the magnet ingestion may be able to minimize or avoid injury by promptly removing the magnets.

Internal Magnet Interaction Injuries. As indicated above, one of the health threats presented by magnet ingestion is internal magnet interaction leading to pressure necrosis injuries that occur in the alimentary canal. Necrosis is a process of cell death, secondary to injury, which undermines cell membrane integrity and involves intricate cell signaling responses. In the case of internal magnet interactions, the injury leading to necrosis is the pressure on the involved biological tissues that exceeds local capillary pressure and leads to ischemia.

Volvulus is another internal interaction hazard associated with magnet ingestion. Volvulus is an obstructive twisting of the GI tract. Volvulus is often accompanied by abdominal pain, distended abdomen, vomiting, constipation, and bloody stools. If left untreated, volvulus may lead to bowel ischemia, perforation, peritonitis, and death. Volvulus following magnet ingestion has been linked to fatal outcomes. In the United States, CPSC is aware of one death of a 20-month-old child who ingested magnets from a toy construction set, which caused volvulus, and one death of a 2-year-old child who ingested multiple magnets, resulting in small intestine ischemia secondary to volvulus. In addition, CPSC is aware of one death of an 8-year-old child in Poland, due to small intestine ischemia secondary to volvulus, after the victim ingested magnets that resulted in necrosis, toxemia (blood poisoning), hypovolemic shock, and eventually cardiopulmonary failure.

Like outcomes related to volvulus, small bowel ischemia can lead to local tissue necrosis, perforation, and subsequent peritonitis. Small intestine ischemia was implicated in the death of a 19-month-old child following

ingestion of multiple magnets. Bowel obstruction, often a consequence of volvulus, is associated with abdominal cramps, vomiting, constipation, and distention. With respect to the relationships among local capillary and intraluminal pressures and magnet ingestions, subsequent outcomes include possible blockage of local blood and nutrient supply; progressive pressure necrosis of the involved tissues; and local inflammation, ulceration, and tissue death, with putative outcomes such as perforation (hole) or fistula in the GI tract. If left untreated, or otherwise unnoticed, such events can progress into infection, sepsis, and death. The obstruction from the trapped tissue can elicit vomiting, and the local mucosa irritation may stimulate diarrhea. Advancing pressure necrosis of the involved tissues can lead to necrosis and subsequent leakage of the bowel contents into the peritoneal cavity.

Another example of the potential health outcomes associated with magnet ingestion is a case in which an asymptomatic 4-year-old child sustained several fistulae in the intestines that required surgical repair after ingesting magnets. Fistulae are abnormal passages between channels in the body that are associated with increased mortality. Fistulae may enable the leakage of gut contents into adjacent tissue structures or abdominal cavities, which can lead to infection, inflammation, perforation, sepsis, and possibly death. Fistulae may also bypass portions of the GI tract, thus undermining normal GI function.

Another potential health outcome of magnet ingestions is ulcerations. For example, one case involved a 28-month-old child who experienced stomach ulcerations after ingesting 10 magnets and receiving treatment with medication after the endoscopic removal and natural passage of the magnets. Untreated ulcers may require surgical intervention if they progress to perforation, and a perforated bowel may lead to leakage from the GI tract. Several magnet ingestion incident reports highlight the threat of perforation with possible outcomes such as peritonitis. Peritonitis is an inflammation of the peritoneum, a membrane lining of the abdominal cavity, which may be associated with leakage from the GI tract that can lead to sepsis. Sepsis is the body's response to severe infection, and it is associated with elevated rates of morbidity and mortality that can be mitigated with prompt treatment. Treatment of abdominal sepsis may require repair of a leaky GI tract.

Another potential health risk from ingested magnets is an aspiration threat. For example, in one reported case, a 3-year-old child ingested multiple magnets, two of which were found attracting to each other on opposing surfaces of the pharyngoepiglottic fold in the throat, presenting an immediate aspiration threat given the proximity to the airway. Aspiration of magnets has also been reported elsewhere in medical literature. Foreign body aspiration presents a risk of airway obstruction, ventilatory difficulty, choking, hypoxic-ischemic brain injury, pulmonary hemorrhage, and death, among other health outcomes.

Other Health Outcomes and Injuries.

In addition to internal interaction hazards, ingested magnets present additional health risks. Ingested magnets that are not attracting to each other through tissue walls may cause harm, such as irritation of the GI mucosa in the form of erythematous, mucosal inflammation, and minor tears. Ingested magnets embedded in the bowel may be associated with multiple days of hospitalization. A foreign body lodged in the GI tract can also cause mucosal wall deterioration, migration, and perforation. Comorbidities, such as eosinophilic esophagitis, gastroesophageal reflux disease, GI anomalies, and neuromuscular disorders can exacerbate the potential outcomes. The wall of the esophagus is susceptible to edema and weakening that increase the risk of bleeding and perforation in the presence of foreign bodies. Foreign body irritation of the GI tract may also prompt local mucosal irritation that can stimulate diarrhea.

Medical Care for Magnet Ingestions. Several approaches to medical care are available when assessing and treating magnet ingestions, however, many of these approaches pose health risks, themselves. Medical providers routinely use medical imaging during treatment of magnet ingestions. Current imaging diagnostic capabilities may be able to identify ingested foreign bodies, but they do not allow for the definitive identification of magnets in the body. The usefulness of metal detectors to locate ingested metallic objects, including magnets, has decreased as the size of ingested magnets decreases. This presents challenges when a caregiver and medical professional do not know the victim ingested a magnet.

When ingested magnets are identified, x-ray radiography, fluoroscopy, computed tomography (CT) scans, or ultrasound⁶¹ can be used to monitor the

⁶¹ These imaging tools present some health risks themselves. The ionizing radiation associated with

anastomoses in preclinical medical device development settings ranged from multiple days to weeks, as evaluated by necropsy and passage of the magnet after anastomosis formation. In a human trial, magnets passed naturally multiple weeks after placement to create healthy anastomoses.

ingested magnets. If the magnets' passage through the GI tract is arrested or symptoms manifest, then endoscopic or surgical intervention may be necessary. Bowel cleanout or bowel preparation procedures that use laxatives,⁶² such as polyethylene glycol, may be used to try to flush ingested magnets out of the GI tract, or to prepare patients for endoscopy or other medical procedures.

Endoscopy may be used to retrieve ingested magnets from the stomach, duodenum, esophagus, pylorus and cecum (via colonoscopy), or other areas. Endoscopy may also be used to treat bowel obstruction secondary to magnet ingestion. Endoscopy is associated with a risk of bleeding from mucosal shearing or tearing that is elevated in the presence of anemia. There is also risk of adverse cardiopulmonary events (*e.g.*, oxygen desaturation, aspiration, respiratory arrest, shock, myocardial infarction) as a result of sedation and anesthesia; perforation from procedure instruments; infection from contaminated equipment, or from a perturbed endogenous source; and procedural risks largely associated with comorbidities (*e.g.*, cardiac disease, diabetes).

Colonoscopy is a common endoscopic procedure performed via the anus and shares many of the same risks as endoscopy. Laryngoscopy—a medical procedure to evaluate the upper aerodigestive tract—is used to investigate suspected magnets lodged in the throat. Associated risks of laryngoscopy include esophageal perforation, airway compromise, bleeding, dysphagia, and fever, among others. Nasal endoscopy may be useful to treat magnets embedded in the nose. Nasal endoscopy is associated with risks of mucosal irritation, minor hemorrhage, and overt hemorrhage.

Surgical interventions may be necessary to treat magnet ingestions when less invasive procedures, such as

x-ray radiography has the potential to damage DNA and may contribute to the development of cancer later in life. The risks from CT scans are similar. Prolonged fluoroscopy, which is often used during surgery or medical procedures such as endoscopy, may contribute to the development of cataracts, skin reddening, or hair loss. Ultrasound is relatively safe, but it may heat tissue or produce pockets of gas in body fluids or tissues.

⁶² Bowel cleanout is not often associated with risk in the pediatric population; dehydration is the most common adverse event that occurs. However, in certain instances, bowel cleanout laxatives may be delivered via nasogastric tube; there are rare reports of life-threatening aspiration of laxative solutions delivered via nasogastric tubes, especially in older populations with certain comorbidities.

endoscopy or bowel cleanout, are clinically inappropriate or unsuccessful. In one example, in which a 5-year-old child ingested magnets, endoscopy failed to retrieve all of the magnets, and the remaining magnets were recovered via laparotomy with appendectomy. Abdominal surgeries, such as laparotomy (abdominal incision) and laparoscopy (fiber-optic visualization of the viscera via abdominal incision), that involve abdominal incisions and manipulation of abdominal organs are associated with the risk of adhesions that can cause pain, bowel obstructions that may require additional surgical intervention, female infertility, and bowel injury. For example, 6 months after a 2-year-old child underwent enterotomy and gastrostomy to remove 26 magnets from her jejunum and stomach, the child developed bowel adhesions that caused obstructions and required treatment with surgical adhesiolysis to cut the adhesions. Possible complications associated with laparotomy include pneumonia, cardiac complications, surgical site infection, wound dehiscence (rupture), urinary tract infection, respiratory tract infection, venous thromboembolism, kidney failure, heart and GI tract complications, septicemia, and death. Emergency laparotomies may be more prone to complications than elective laparotomies. For example, a 6-year-old child who ingested 20 magnets underwent a 20-day hospital stay to treat surgical wound infections following exploratory laparotomy with small bowel resection and appendectomy to retrieve the magnets.

Appendectomy may also result from magnet ingestions, and is commonly achieved via laparotomy or laparoscopy. Pain, wound infections, and intra-abdominal abscesses are possible following both laparoscopic and open appendectomies. Laparotomy may be accompanied by incisions of the stomach (gastrotomy) or intestines (enterotomy) to retrieve ingested magnets. Complications from surgical enterotomies, or incisions into the intestine, may be similar to those of inadvertent enterotomies, which can occur during anastomosis procedures and include leakage, intra-abdominal abscesses, and death.

Surgical resection of the bowel may be performed to remove necrotic portions of the bowel, secondary to magnet ingestion. Small bowel resection is associated with risks of infection, fistulae, peritonitis, abscess, sepsis, and

wound dehiscence secondary to leaky anastomoses. There is also the possibility of impairment to the intrinsic nutrient absorption functions of the bowel, depending on the resection location. End-to-end surgical anastomoses used to restore bowel continuity following resection are associated with the risk of leakage, intra-abdominal abscess, and death.

Complications associated with surgery to treat magnet ingestion have also included pancreatitis and additional hospitalization, additional surgery to treat incisional hernia, and the need for a lifelong feeding tube, among others. Endotracheal general anesthesia may be required for surgical treatments of magnet ingestion. Possible complications associated with general anesthesia include nausea, vomiting, sore throat, dental damage, myocardial ischemia or infarction, heart failure, cardiac arrest, arrhythmia, atelectasis (lung collapse), aspiration, bronchospasm, neurological effects, and renal effects, among others.

In addition to the medical procedures necessary to treat magnet ingestions, and the risks associated with those procedures, ingested magnets present unique challenges for medical professionals. For example, technical precision is reduced, and technical difficulty increases when ingested magnets attract to the metallic instruments used to retrieve them. In one example case, ingested magnets in the throat of a 3-year-old child suddenly attracted to the optic graspers inserted to retrieve the foreign bodies.

C. Incident Characteristics⁶³

Staff conducted a detailed analysis of incident data to identify hazard patterns and characteristics associated with magnet ingestion incidents, and staff also considered developmental and behavioral factors relevant to the hazard. These considerations helped inform the scope of products that need to be addressed in the proposed rule and the types of requirements that would be effective at reducing the magnet ingestion hazard.

1. Victim Age

Table 12 provides the ages of victims involved in magnet ingestion incidents, from both the NEISS and CPSRMS data sets. The table includes incidents in the

⁶³ For additional information about hazard patterns and incident characteristics, see Tab C of the NPR briefing package.

magnet sets, magnet toys, and jewelry categories, as well as incidents in the unidentified product type category.⁶⁴

categories, as well as incidents in the unidentified product type category.⁶⁴

TABLE 12—MAGNET INGESTION INCIDENTS, BY AGE

Victim age	NEISS (#)	NEISS (%)	CPSRMS (#)	CPSRMS (%)
<2 yrs	120	11.8	21	8.2
2 yrs	89	8.8	32	12.5
3 yrs thru 4 yrs	196	19.3	31	12.1
5 yrs thru 7 yrs	207	20.4	28	10.9
8 yrs thru 10 yrs	179	17.7	66	25.7
11 yrs thru 13 yrs	182	18	37	14.4
14 yrs thru 16 yrs	30	3	12	4.7
>16 yrs	11	1.1	1	0.4
Unknown	0	0	29	11.3
Totals	1,014	257

Source: NEISS, CPSRMS. Percentages are rounded to the nearest tenth.

The youngest victim for which an age was reported was 6 months old; the oldest age reported was 54 years old. Approximately 20 percent of the NEISS incidents and CPSRMS incidents involved victims under 3 years old. This is consistent with developmental and behavioral factors—typically, foreign body ingestions peak for children between 6 months and 3 years old, and 2-year-old children generally are mobile and unlikely to be supervised directly at all times. Children of these ages are commonly cited in reports involving ingestion of inedible objects, given their likelihood of orally exploring their environment and their limited ability to comprehend hazards. For these and other reasons, toys with small parts must have a choking hazard warning for children under 3 years old.⁶⁵

As Table 12 indicates, approximately 60 percent of NEISS incidents and 56 percent of CPSRMS incidents involved victims 5 years old and older. This age group is important because one option CPSC and voluntary standards groups have considered to address the magnet ingestion hazard is child-resistant (CR) packaging, which is packaging that is designed or constructed to be significantly difficult for children under 5 years old to open.⁶⁶ Because the majority of incidents involve victims who would not be protected by CR packaging, these data suggest that CR packaging would be unlikely to adequately reduce the magnet ingestion hazard.

Table 12 also shows that approximately 40 percent of NEISS

incidents and 45 percent of CPSRMS incidents involved victims 8 years old and older. This is noteworthy because several voluntary standards exempt magnet products intended for users 8 years and older from size and strength requirements, instead requiring only warnings on such products. These standards seemingly assume that users 8 years old and older are less likely to ingest magnets or are able to understand and heed warnings about the magnet ingestion hazard better than younger children. However, the frequency of incidents involving users 8 years and older suggests that this is not the case.

As indicated above, Table 12 includes incidents in the magnet sets, magnet toys, jewelry, and unidentified product categories, indicating that these incidents did not involve products that are intended for children under 14 years old.⁶⁷ Despite this, most magnet ingestion incidents involved children under 14 years old, indicating that subject magnet products appeal to and are accessible to children and teens. This demonstrates that a standard for children’s toys, alone, is not sufficient to address the magnet ingestion hazard. Subject magnet products appeal to children and teens for various reasons. Magnets, particularly smooth magnets, have tactile appeal for fidgeting, stress relief, and other amusement. Some magnets capture attention because they are shiny, colorful, or both. They make soft snapping/clicking sounds when manipulated, which children and teens may find appealing. The magnets have properties of novelty, which arouse

curiosity; incongruity, which tends to surprise and amuse; and complexity, which tends to challenge and maintain interest. Their strong magnetic properties cause them to behave in unexpected ways, with pieces suddenly snapping together, and moving apart. Such behavior is likely to seem magical to younger children, and evoke a degree of awe and amusement among older children and teens.

2. Use Patterns

In reviewing incident data, staff identified the following patterns in how the magnets were being used at the time of ingestion:

- **Playing**—These cases involved ingestion of magnets while users were playing, fidgeting, orally exploring the magnets (e.g., testing the attraction through teeth or on braces), or performing a combination of these actions. If playing involved use of the product as jewelry, the case was categorized as jewelry, rather than playing. This category excludes cases involving intentional ingestion.
- **Jewelry**—These cases involved magnets victims were using as jewelry at the time of the incident, such as bracelets, necklaces, and simulated piercings (e.g., magnets used around the tongue, lip, and cheek to look like piercings).
- **Intentionally ate**—In these cases, victims reportedly swallowed magnets on purpose (e.g., curiosity, mistaking the magnets as edible).
- **Other**—These cases involved identified actions that did not fit the

⁶⁴ As explained above, several factors indicate that many of the incidents in the unidentified product type category likely involved subject magnet products, and these incidents indicate the age of children and teens involved in magnet ingestion incidents, generally. The table excludes

out-of-scope products (i.e., home/kitchen and ASTM F963 magnet toys).

⁶⁵ 16 CFR part 1501.

⁶⁶ See 16 CFR part 1700, issued under the Poison Prevention Packaging Act of 1970, 15 U.S.C. 1471–1477.

⁶⁷ As discussed above, incidents in the unidentified product category likely involve subject magnet products, and not ASTM F963 magnet toys.

categories above (e.g., transporting magnets orally, magnets thrown into a victim’s mouth when not playing, and magnets placed in a victim’s drink).

- Unknown—In these cases, it was unclear what led to the magnet ingestion.

Table 13 provides the use patterns involved in magnet ingestion incidents,

from both the NEISS and CPSRMS data sets. The table includes incidents in the magnet sets, magnet toys, and jewelry categories, as well as incidents in the unidentified product type category.⁶⁸

TABLE 13—MAGNET INGESTION INCIDENTS, BY USE PATTERN

Use category	NEISS (#)	NEISS (%)	CPSRMS (#)	CPSRMS (%)
Playing	143	14.1	61	23.7
Jewelry	31	3.1	43	16.7
Intentionally Ate	19	1.9	21	8.2
Other	10	1	4	1.6
Unknown	811	80	128	49.8
Totals	1,014	257

Source: NEISS, CPSRMS. The percentages are rounded to the nearest tenth.

As Table 13 shows, in both data sets, for incidents in which the use pattern could be identified, magnets were commonly used as playthings at the time of ingestion, followed by magnets used as jewelry. This supports the need to address amusement and jewelry products in the proposed rule. In

addition, these data indicate that the use pattern is unknown for many magnet ingestions, suggesting that victims are too young to report the use pattern and ingest magnets while outside caregiver supervision.

Figure 3⁶⁹ shows the use patterns during magnet ingestion incidents, by victim age, for the NEISS data set.

Figure 4⁷⁰ shows the use patterns during magnet ingestion incidents, by victim age, for the CPSRMS data set. Both figures include incidents in the magnet sets, magnet toys, and jewelry categories, as well as incidents in the unidentified product type category.⁷¹

BILLING CODE 6355-01-P

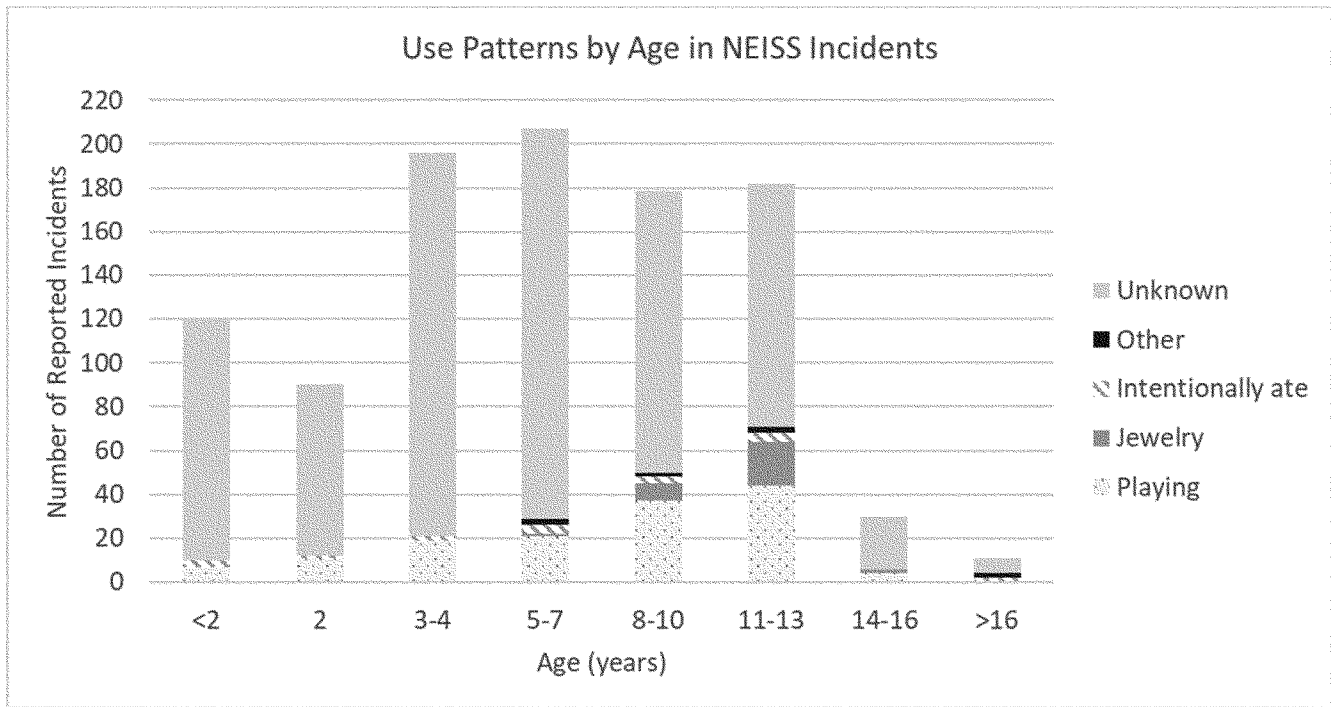

Figure 3: Magnet ingestion incidents, by use pattern and victim age, for NEISS incidents.

⁶⁸ As explained above, several factors indicate that many of the incidents in the unidentified product type category likely involved subject magnet products, and these incidents indicate the use patterns involved in magnet ingestion incidents, generally. The table excludes out-of-scope products (i.e., home/kitchen and ASTM F963 magnet toys).

⁶⁹ To see Figure 3 in color, see Figure 2 in Tab C of the NPR briefing package.

⁷⁰ To see Figure 4 in color, see Figure 3 in Tab C of the NPR briefing package.

⁷¹ As explained above, several factors indicate that many of the incidents in the unidentified product type category likely involved subject

magnet products, and these incidents indicate the use patterns and ages involved in magnet ingestion incidents, generally. The table excludes out-of-scope products (i.e., home/kitchen and ASTM F963 magnet toys).

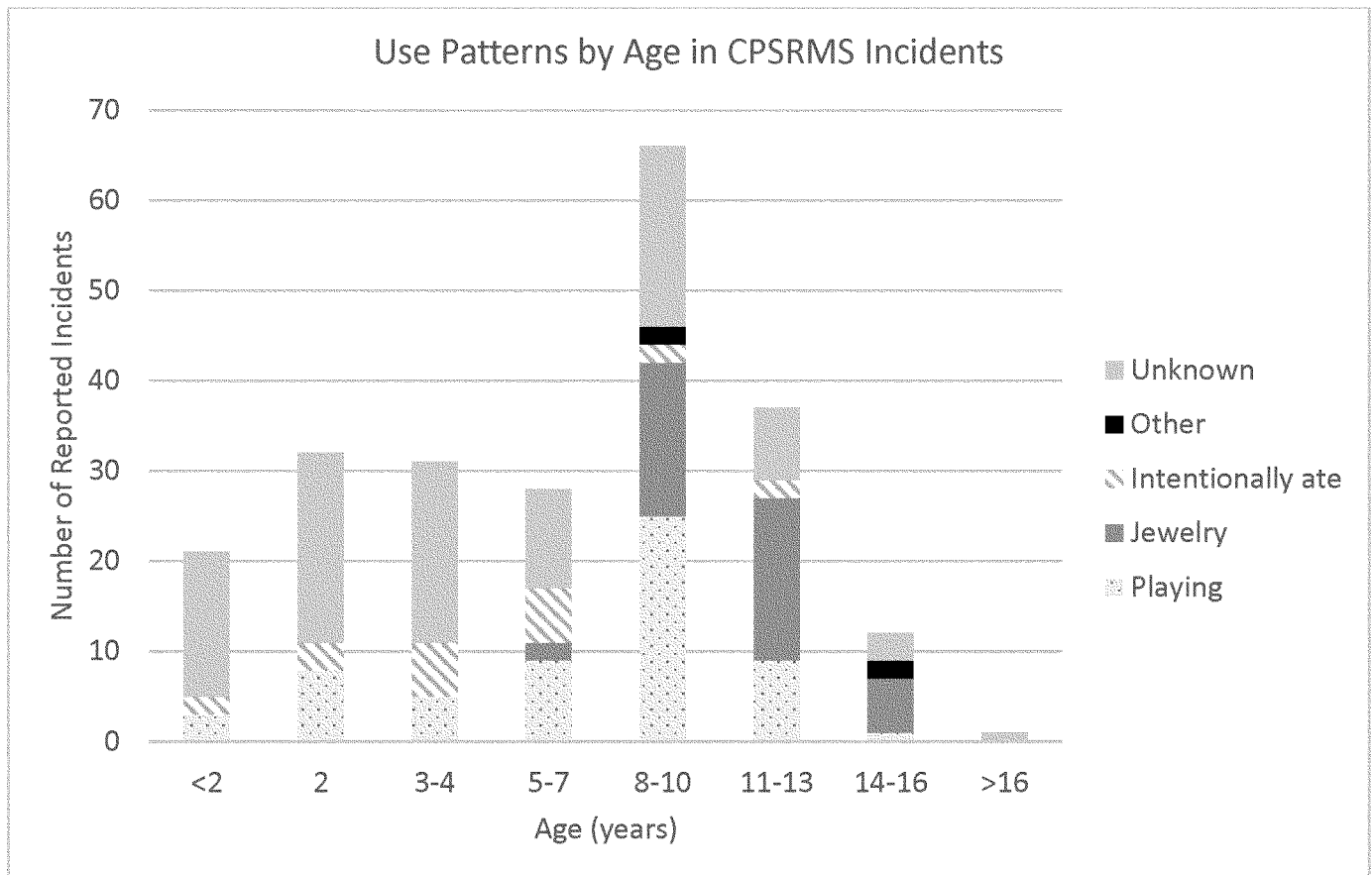

Figure 4: Magnet ingestion incidents, by use pattern and age, for CPSRMS incidents.

BILLING CODE 6355-01-C

As Figures 3 and 4 show, for incidents in which the use pattern was identified, the majority of victims accidentally ingested the magnets. A common example of these accidental ingestions is children using the magnets in or around their mouths when the magnets unexpectedly rolled to the back of their throats and were ingested, in some cases by swallow reflex. This is consistent with normal child development, including exploration and the likelihood that children will be drawn to magnets aesthetically, and to their invisible attraction and repulsion properties. Consistent with developmental factors, younger children, particularly those under 8 years old, were more likely than older children to be involved in reports of intentional magnet ingestion (only 4 reports of intentional ingestion involved children 8 years old and older). The frequency of accidental ingestions suggests that safety messaging may have limited effectiveness in addressing magnet ingestions, because children and caregivers are unlikely to anticipate and appreciate the likelihood of accidental ingestion of magnets.

Victims 8 years old and older were more likely than younger ages to swallow magnets while simulating piercings. It is foreseeable for this age group to use magnets as jewelry in or around their mouths, because experimentation and peer influence are common determinants of behavior for this age group. Older children and teens often value acceptance by peers more than obeying parental guidelines, and social influences and peer pressure can drive adolescent behavior more strongly than their own independent thought processes. The subject magnet products offer a seemingly safe and reversible way to try out lip, tongue, cheek, and nose piercings. If these children see their peers performing this activity, they may feel compelled to act similarly, even if they are aware of the risks. Furthermore, older children and early adolescents are at a developmental stage in which they test limits and bend rules.

3. Post-Ingestion Response

Staff also assessed incident data for information about how victims and caregivers behaved after a magnet ingestion event, including whether

caregivers became aware of the ingestion, and the time between ingestion and treatment. Staff found that the invasiveness of medical interventions was often associated with the length of delay between the ingestion event and correct medical treatment. At least 56 of the 257 CPSRMS incidents (22 percent) involved a delay of several days between ingestion and correct treatment, with some delays spanning months. At least 16 additional incidents (6 percent) involved a delay of 1 day.

One common cause of delays was caregivers being unaware of the ingestion, resulting in delayed hospital visits and subsequent misdiagnoses. In many cases, particularly those involving children under 8 years old, caregivers were not aware that magnets were ingested. These cases often involved ingestions that were not witnessed by caregivers, and where the children were unable or unwilling to communicate what happened.

Another common cause of delays was caregivers misunderstanding the hazard, such as expecting the magnets to pass naturally. Whether ingested magnets

will pass naturally depends on several factors, including the number of magnets ingested, whether the magnets interact through tissue, and whether the interaction is strong enough to resist natural bodily forces. Similarly, delays in care often result when caregivers and children fail to make the connection between the magnet ingestion and symptoms, because there is frequently a time delay between magnet ingestion and symptoms, and because preliminary symptoms typically are similar to common illnesses. Many cases detail victims receiving treatment only after experiencing significant discomfort, at

which point substantial internal damage had occurred. For example, one report indicates that in 2017, a 3-year-old child was found playing with an older sibling's magnet set, but stated that she had not swallowed any magnets. Days after the incident, the child became ill and was misdiagnosed with a stomach virus. Eventually, x-rays were taken, revealing three magnets in her small intestine. The victim lost a portion of her digestive tract and was hospitalized for approximately 2 weeks to recover after the surgery.

4. Sources of Access

Staff also examined incident data to determine how and from whom victims acquired magnets they ingested. Because most NEISS reports (97 percent) did not include sufficient information to determine the source of access, staff focused on CPSRMS incidents.

Table 14 shows the source of access for the 257 CPSRMS magnet ingestion incidents. The table includes incidents in the magnet sets, magnet toys, and jewelry categories, as well as incidents in the unidentified product type category.⁷²

TABLE 14—MAGNET INGESTION INCIDENTS, BY SOURCE OF ACCESS, FOR CPSRMS DATA

Sources of access	CPSRMS (#)	CPSRMS (%)	Description
Family Owned	59	23%	Magnets belonged to the victim's family. Includes cases of siblings finding magnets and bringing them home.
Friend/Classmate/School/Neighbor	41	16	Magnets belonged to friends, classmates, or neighbors, or the victim found them at daycare or school.
Purchased for Victim	26	10.1	Magnets purchased for the victim.
Purchased by Victim	5	1.9	Magnets purchased by the victim.
Found Outside	4	1.6	Victim found the magnets outside, such as on a playground. Excludes cases of siblings finding magnets and bringing them home.
Unknown	122	47.5	Unclear where the magnet was acquired, by whom, or for whom. Includes cases of magnets found in the home but where the product owner was unknown.
Totals	257	

Percentages are rounded to the nearest tenth.

As Table 14 shows, of the 135 cases with a known source of access, most cases involved magnets that belonged to family members of the victim (44 percent), followed by magnets that victims acquired from friends, classmates, daycares, or schools (30 percent), and magnets purchased for the victim (19 percent). A small number of incidents involved magnets purchased by the victim (4 percent), or that the victim found outside (3 percent).

Victims under 8 years old typically gained access to magnets that belonged to family members, such as siblings, parents, and relatives. Magnets from family members were usually found on floors, in or on furniture, in bags, and affixed to surfaces (*e.g.*, refrigerators, wallboards); and in some cases, family members intentionally shared the magnets with victims. In contrast, victims 8 years old and older typically obtained magnets from friends, classmates, or at school, or the magnets were purchased for them. Most cases involved children and teens acquiring

loose magnets, as opposed to accessing the full set or product at the time of ingestion.

Staff also reviewed incident reports for information about product warnings and age labels on the ingested products, to determine if such warnings were present and considered by the victims and caregivers.⁷³ Of the 57 cases that reported whether there were product warnings, at least 45 (79 percent) involved products with a magnet ingestion warning. Similarly, of the 60 cases that reported whether there were age labels on the product, at least 49 (82 percent) involved products with a warning to keep the product away from children. At least 44 cases involved products with both magnet ingestion warnings and warnings to keep the product away from children. Recent magnet ingestion incidents, in 2021, which are not included in the above analysis, also indicate that there are numerous incidents in which involved magnet sets had clear and repeated warnings about the magnet ingestion

hazard and warnings to keep the product away from children.

Staff further assessed incident data to determine the age of victims in incidents where the ingested magnets were purchased for or by the victims. Of the 133 cases with a known source of access and known victim age, about 23 percent involved magnets purchased for or by victims under 14 years old, including 9 cases in which the magnets were purchased for victims under 8 years old. Despite the ages of these victims, these cases involved products that were not marketed for children under 14 years old, and were not subject to the toy standard. For example, in one case, a parent purchased a magnet set for a 9-year-old child, despite there being clear and repeated warnings about the magnet ingestion hazard and warnings to keep the product away from children. In another case, a caregiver gave the same product to a 5-year-old child, believing the product to be harmless, and believing that swallowed magnets would pass naturally. The

⁷² As explained above, several factors indicate that many of the incidents in the unidentified product type category likely involved subject magnet products, and these incidents indicate

sources of access in magnet ingestion incidents, generally. The table excludes out-of-scope products (*i.e.*, home/kitchen and ASTM F963 magnet toys).

⁷³ In most cases, there was insufficient information to determine if the involved products had warnings, age labels, or both.

child swallowed the magnets, and required surgery, including an appendectomy, because the magnets attracted internally through tissue.

Based on technical analysis and examination of incident reports, online and on-package marketing, and consumer reviews for subject magnet products, staff identified the following factors that likely contribute to children accessing magnet products that are intended for older users: Caregivers and victims underestimate the potential severity of the hazard; social pressures from children, other family members, and friends; consumers see subject magnet products or similar products marketed to children; consumers see other children handling subject magnet products or similar products without incident; consumers read product reviews about other children handling subject magnet products or similar products without incident; and caregivers underestimate the likelihood that children or teens would ingest a magnet.

This information has implications for the types of requirements that are likely to effectively reduce the magnet ingestion hazard. For one, it indicates that requirements that rely on caregiver intervention, such as safety messaging and packaging requirements, are unlikely to adequately address the hazard. As the data suggest, caregivers cannot easily manage children's and teen's access to magnet products, since children and teens often access them outside the home. There are additional reasons why these requirements are unlikely to adequately address the hazard. As these data suggest, many incidents involve children and teens accessing ingested magnets without their packaging, making safety messaging and packaging ineffective. In addition, many incidents involve products that included safety messaging and age recommendations that consumers did not follow. Similarly, these data suggest that the toy standard, alone, cannot adequately address the magnet ingestion hazard because children and teens purchase, receive, and access magnets from products that are not intended for their ages.

V. Relevant Existing Standards⁷⁴

CPSC identified six existing safety standards that address the magnet ingestion hazard. Each of these standards applies to certain products, and none of the standards apply to all subject magnet products. Four of the

standards are domestic voluntary standards:

- ASTM F963–17, *Standard Consumer Safety Specification for Toy Safety*;
- ASTM F2923–20, *Standard Specification for Consumer Product Safety for Children's Jewelry*;
- ASTM F2999–19, *Standard Consumer Safety Specification for Adult Jewelry*; and
- ASTM F3458–21, *Standard Specification for Marketing, Packaging, and Labeling Adult Magnet Sets Containing Small, Loose, Powerful Magnets (with a Flux Index $\geq 50 \text{ kG}^2 \text{ mm}^2$)*.

In addition, two are international safety standards:

- EN 71–1: 2014, *Safety of Toys; Part 1: Mechanical and Physical Properties*; and
- ISO 8124–1: 2018, *Safety of Toys — Part 1: Safety Aspects Related to Mechanical and Physical Properties*.

This section describes these standards and provides CPSC staff's assessment of their adequacy to address injuries and deaths associated with magnet ingestions. Several of the standards include requirements that do not relate to magnets, however, this analysis focuses on those provisions that are relevant to the magnet ingestion hazard.

A. ASTM F963–17

ASTM F963 was originally approved in 1986, and has been revised numerous times since then. In 2007, ASTM updated the standard to include requirements to address the magnet ingestion hazard in children's toys. In subsequent revisions, ASTM added further requirements for toys containing magnets. As explained above, in 2008, section 106 of the CPSIA made ASTM F963 a mandatory consumer product safety standard; in accordance with that mandate, the Commission adopted 16 CFR part 1250, which currently incorporates by reference ASTM F963–17, which is the most recent version of the standard. ASTM approved ASTM F963–17 on May 1, 2017 and published it in August 2017. CPSC staff participates in the ASTM F15.22 subcommittee that is responsible for this standard.

1. Scope

ASTM F963–17 applies to “toys,” which the standard defines as objects designed, manufactured, or marketed as playthings for children under 14 years old. As such, the standard does not apply to products that are intended for users 14 years or older, or products that would not be considered playthings. When ASTM adopted the provisions

regarding magnets, it explained that the purpose of the requirements was to address magnet ingestion incidents resulting in serious injury or death by identifying magnets and magnetic components that can be readily swallowed (section A9.4).

2. Performance Requirements for Magnets

The standard specifies that toys may not contain a loose as-received “hazardous magnet” or a loose as-received “hazardous magnetic component.” In addition, toys may not liberate a “hazardous magnet” or “hazardous magnetic component” after specified use-and-abuse testing, which consists of soaking under water, cycling attachment and detachment, drop testing, torque testing, tension testing, impact testing, and compression testing. The standard excepts from the requirements “magnetic/electrical experimental sets” intended for children 8 years and older—such products need only comply with warning requirements, discussed below.

The standard defines a “hazardous magnet” as a magnet that is a small object (*i.e.*, fits entirely within a small parts cylinder specified in the standard) and has a flux index of $50 \text{ kG}^2 \text{ mm}^2$ or more (as measured in accordance with the method specified in the standard). Thus, a magnet must be both small and strong, according to the criteria in the standard, to be “hazardous.” A “hazardous magnetic component” is any part of a toy that is a small object and contains an attached or imbedded magnet with a flux index of $50 \text{ kG}^2 \text{ mm}^2$ or more.

ASTM F963–17 describes the small parts cylinder in section 4.6 and illustrates it in Figure 3; to be a small object, the magnet must fit entirely within the cylinder. The small parts cylinder depicted in ASTM F963–17 is the same as the small parts cylinder in CPSC's regulations, at 16 CFR 1501.4. Sections 8.25.1 through 8.25.3 describe the test methodology to measure the maximum absolute flux of a magnet and to calculate the flux index. A flux index is a calculated value of magnetic density and size. The flux index of a magnet is calculated by multiplying the square of the magnet's maximum surface flux density (in KGauss (kG)) by its cross-sectional area (in mm^2).

3. Warning Requirements

ASTM F963–17 does not include specific labeling requirements for toys containing loose as-received hazardous magnets or hazardous magnetic components, except for “magnetic/electrical experimental sets” intended

⁷⁴ For additional information about relevant existing standards, see Tab C and Tab D of the NPR briefing package.

for children 8 years and older, which are exempt from the performance requirements and need only meet labeling requirements. The standard defines a “magnetic/electrical experimental set” as a “toy containing one or more magnets intended for carrying out educational experiments that involve both magnetism and electricity.” Section A12.4 in the standard explains that this definition is intended to cover only products that combine magnetism and electricity. The packaging and instructions for magnetic/electrical experimental sets intended for children 8 years and older must be labeled with a warning that addresses the magnet ingestion hazard.

4. Assessment of Adequacy

CPSC staff does not consider ASTM F963–17 capable of adequately reducing the risk of injury and death associated with magnet ingestions because of the scope of products it covers.

The size and strength requirements in ASTM F963–17 are consistent with the requirements proposed in this rule for subject magnet products. Section VI, Description of and Basis for the Proposed Rule, below, discusses these size and strength requirements and their ability to address the hazard. Staff considers the size and strength requirements adequate to address the hazard. However, ASTM F963–17 only applies to products designed, manufactured, or marketed as playthings for children under 14 years old; it does not apply to products intended for older users or products that would not be considered playthings. Accordingly, staff does not believe that compliance with the standard is likely to adequately reduce the magnet ingestion hazard.⁷⁵

As the incident data indicate, children and teens commonly access and ingest magnets from products intended for older users. Both NEISS and CPSRMS data indicate that the most common products identified in magnet ingestions were magnet sets and magnet toys, which are products that are intended for users 14 years or older, or where the intended user age was unknown, but there were no indications that the product was intended for users under 14 years. Despite the involvement of products intended for users 14 years and older, the vast majority of magnet

ingestion incidents involved children under 14 years old. For example, among CPSRMS incidents for which the victim’s age was known, the most common ages that ingested magnet sets were 2, 8, 9, and 10 years old.

The sources from which children access ingested magnets further illustrates the need to address magnets in products intended for older users. For example, according to CPSRMS data, children and teens commonly access ingested magnets that belong to other family members, in the home, from friends, or loose in the environment, suggesting their access is not limited to toys intended for them.

In addition, ASTM F963–17 does not apply to products that are not intended to be playthings. Both NEISS and CPSRMS data indicate that many products involved in magnet ingestion incidents are described as jewelry, and that children of various ages ingest magnet jewelry (e.g., accidentally ingesting magnets while simulating lip, tongue, and cheek piercings). Because ASTM F963–17 only applies to playthings, it does not apply to jewelry, regardless of the intended user age.

As such, ASTM F963–17, alone, is not sufficient to address the magnet ingestion hazard, because it does not impose any requirements on products intended for users 14 years or older or jewelry, which are known to be involved in many magnet ingestion incidents.

B. ASTM F2923–20

ASTM first issued ASTM F2923 in 2011. The current version of the standard is ASTM F2923–20, which was approved on February 1, 2020, and published in March 2020.

1. Scope

ASTM F2923–20 applies to “children’s jewelry,” which is jewelry designed or intended primarily for use by children 12 years old or younger. The standard defines “jewelry” as a product that is primarily designed and intended as an ornament worn by a person. The standard does not apply to toy jewelry or products intended for a child when playing. The standard includes requirements that are intended to address ingestion, inhalation, and attachment hazards associated with children’s jewelry that contains a hazardous magnet or hazardous magnetic component. The standard defines a “hazardous magnet” and “hazardous magnetic component” by referencing the definition in ASTM F963, except that the standard exempts chains that are longer than 6 inches

from the definition of “hazardous magnetic component.”

2. Performance Requirements for Magnets

ASTM F2923–20 prohibits children’s jewelry from having an as-received hazardous magnet or hazardous magnetic component. The standard excepts from this requirement children’s jewelry intended for children 8 years and older consisting of earrings, brooches, necklaces, or bracelets—such products need only comply with warning requirements, discussed below. In addition, the standard prohibits children’s jewelry from liberating a hazardous magnet or hazardous magnetic component after the use-and-abuse testing specified in ASTM F963.

3. Warning Requirements

ASTM F2923–20 does not include specific labeling requirements for children’s jewelry containing hazardous magnets or hazardous magnetic components, except for children’s jewelry intended for children 8 years and older that consists of earrings, brooches, necklaces, or bracelets. These products are exempt from the performance requirements and need to include a warning that addresses the magnet ingestion hazard. Instructions that accompany the product must also include these warnings.

4. Assessment of Adequacy

CPSC staff does not consider ASTM F2923–20 capable of adequately reducing the risk of injury and death associated with magnet ingestions. Although staff considers the size and strength requirements in the standard adequate to address the magnet ingestion hazard, the standard excepts certain children’s jewelry from these performance requirements, and the scope of products covered by the rule makes the standard insufficient to address the magnet ingestions, generally.

The first issue with the standard is that it excludes from the size and strength requirements for magnets children’s jewelry that is intended for children 8 years and older that consists of earrings, brooches, necklaces, and bracelets. Applying only warning requirements to these products is not adequate to reduce the magnet ingestion hazard. As the incident data indicate, almost half of magnet ingestion incidents involve children 8 years and older, and children and teens, particularly in this age group, commonly used magnets as jewelry at the time of ingestion. Warning requirements, alone, are not adequate to

⁷⁵ Based on incident data, staff believes that the exception in ASTM F963–17 for magnetic/electrical experimental sets intended for children 8 years and older is likely not problematic for adequately addressing the magnet ingestion hazard. Staff identified only one magnet ingestion incident that involved a “science kit,” which potentially could be a magnetic/electrical experimental set.

address these incidents. As the discussion of ASTM F3458–21, below, covers in detail, caregivers and children commonly do not heed warnings, and children and teens commonly access magnets that are separated from their packaging, where warnings are provided.

The second issue with the standard is that it applies only to jewelry that is designed or intended primarily for use by children 12 years old or younger. As such, it does not impose requirements on magnet sets or magnet toys intended for users 14 years and older, which are the most common product types identified in magnet ingestion incidents. The standard also does not apply to jewelry intended for users over 12 years old. Although incident data do not indicate the intended user age of jewelry products involved in ingestions, the data indicate that children and teens of various ages ingested magnets intended for users 14 years and older when using the magnets as jewelry, making it is reasonable to conclude that jewelry intended for users over 12 years old poses an ingestion hazard for children and teens.

For these reasons, ASTM F2923–20, on its own, is not sufficient to address the magnet ingestion hazard because it does not impose requirements on magnet sets, magnet toys, or certain jewelry, which are shown to be involved in many magnet ingestion incidents.

C. ASTM F2999–19

ASTM first issued ASTM F2999 in 2013; the current version of the standard is ASTM F2999–19, which ASTM approved on November 1, 2019, and published in November 2019.

1. Scope

ASTM F2999–19 establishes requirements and test methods for certain hazards associated with adult jewelry, including magnets. The standard defines “adult jewelry” as jewelry designed or intended primarily for use by consumers over 12 years old. It defines “jewelry” as a product primarily designed and intended as an ornament worn by a person, and provides several examples, such as bracelets, necklaces, earrings, and jewelry craft kits where the final assembled product meets the definition of “jewelry.” The standard defines a “hazardous magnet” as “a magnet with a flux index >50 as measured by the method described in Consumer Safety Specification F963 and which is swallowable or a small object.”

2. Performance Requirements for Magnets

ASTM F2999–19 does not include any performance requirements for adult jewelry that contains magnets; it specifies only labeling requirements, discussed below.

3. Labeling Requirements

ASTM F2999–19 states that “adult jewelry that contains hazardous magnets as received should include a warnings statement which contains the following text or substantial equivalent text which clearly conveys the same warning.” Thus, rather than the mandatory language ASTM standards typically use (*i.e.*, shall), the standard merely recommends (*i.e.*, should) that warnings regarding hazardous magnets be provided with adult jewelry. The warning statement provided in the standard warns of the internal interaction hazard if magnets are swallowed or inhaled, and recommends seeking immediate medical attention.

4. Assessment of Adequacy

CPSC staff does not consider ASTM F2999–19 capable of adequately reducing the risk of injury and death associated with magnet ingestions. For one, the standard does not include any requirements for adult jewelry containing magnets—rather, it suggests complying with the magnet provisions. As incident data indicate, many magnet ingestion incidents involve products used as jewelry, and children and teens accessing products intended for older users. This demonstrates the need for a mandatory requirement for adult jewelry.

In addition, the only provisions in the standard that address magnet ingestions are warnings. As the discussion of ASTM F3458–21, below, covers in detail, warning requirements, alone, are not adequate to address the magnet ingestion hazard because caregivers and children commonly do not heed warnings, and children and teens commonly access magnets that are separated from their packaging, where warnings are provided.

The scope of the standard also makes it insufficient to adequately address the magnet ingestion hazard. Because it applies only to jewelry designed or intended primarily for use by consumers over 12 years old, the standard does not impose requirements on magnet sets or magnet toys intended for users 14 years and older, which are the most common products identified in magnet ingestion incidents. It also does not impose requirements on jewelry intended for users 12 years old and

younger. Although the incident data do not indicate the intended user age of jewelry involved in magnet ingestions, because many incidents involve children 12 years old and younger, it is reasonable to conclude that jewelry intended for such users pose the magnet ingestion hazard for children and teens.

Another potential issue with ASTM F2999–19 is that it defines a hazardous magnet, for purposes of determining whether the warning provisions apply, as having a flux index greater than 50 kG² mm². In contrast, ASTM F963–17, ASTM F2923–20, and this proposed rule, define a hazardous magnet as having a flux index greater than or equal to 50 kG² mm², thereby, addressing magnets with a flux index of precisely 50 kG² mm². This makes ASTM F2999–19 inconsistent with the toy standard, which has been in effect for many years and has been effective at addressing the magnet ingestion hazard for toys.

For these reasons, ASTM F2999–19, alone, is not sufficient to address the magnet ingestion hazard because it does not impose performance requirements on magnet sets, magnet toys, or certain jewelry, which are involved in many magnet ingestion incidents.

D. ASTM F3458–21

In 2019, ASTM Subcommittee F15.77 on Magnets began work to develop a standard for magnet sets intended for users 14 years and older. On February 15, 2021, ASTM approved ASTM F3458–21, and published the standard in March 2021. ASTM F3458–21 consists of marketing, packaging, labeling, and instructional requirements for magnet sets intended for users 14 years and older.

Since March 2019, CPSC staff has participated actively in Subcommittee F15.77 on Magnets. During the development of ASTM F3458–21, CPSC staff raised several concerns to the subcommittee about the developing standard, including the reliance on marketing, packaging, labeling, and warnings requirements, rather than performance requirements to limit the size and strength of magnets. The assessment of the standard, below, and Tab C of the NPR briefing package, detail these concerns; Tab C also includes a letter CPSC staff sent the subcommittee, expressing these concerns. Based on these issues, CPSC considered the standard inadequate to address the magnet ingestion hazard and voted against the final version of the standard that was ultimately adopted.

In May 2021, after ASTM F3458–21 was adopted, Subcommittee F15.77 on Magnets voted to form a task group to

consider revising the standard to include performance requirements for magnet sets intended for users 14 years and older. CPSC staff will continue to work with the subcommittee, however, whether the standard will be revised, and what requirements may be added to it, are, as yet, undetermined.

1. Scope

ASTM F3458–21 aims to minimize the hazards to children and teens associated with ingesting small, powerful magnets in magnet sets that are intended for users 14 years and older. The standard defines a “magnet set” as “an aggregation of separable magnetic objects that are marketed or commonly used as a manipulative or construction item for puzzle working, sculpture building, mental stimulation, education, or stress relief.” It also defines a “small, powerful magnet” as an “individual magnet of a magnet set that is a small object” and has a flux index of 50 kG² mm² or more. The criteria for identifying a small object and the flux index are the same as in ASTM F963–17.

2. Performance Requirements for Magnets

The standard does not include size and strength limits for magnet sets themselves. The standard includes performance criteria in the form of test methods to determine if a product is a “small, powerful magnet,” and test methods for assessing label permanence; however, the standard does not include performance requirements preventing small, powerful magnets from being used in magnet sets. Instead, ASTM F3458–21 includes requirements for instructional literature, sales/marketing, labeling, and packaging, discussed below. These requirements seek to inform and encourage consumers to keep magnets away from children.

3. Instructional Literature Requirements

ASTM F3458–21 requires magnet sets intended for users 14 years and older to come with instructions that address assembly, maintenance, cleaning, storage, and use. The instructions must include warnings (as specified below), the manufacturer’s suggested strategy for counting and storing magnets, a description of typical hazard patterns (e.g., young children finding loose magnets), an illustration of the hazard, a description of typical symptoms associated with magnet ingestion, and statements regarding medical attention when magnets are ingested.

4. Sales/Marketing Requirements

The standard prohibits manufacturers from knowingly marketing or selling magnet sets intended for users 14 years and older to children under 14 years old, and requires them to “undertake reasonable efforts” (with examples) to ensure the product is not marketed or displayed as a children’s toy. For online sales, manufacturers must “undertake reasonable efforts” (with examples) to ensure that online sellers do not sell magnet sets intended for users 14 years and older to children under 14 years. When selling directly to consumers online, manufacturers must include warnings (as specified below) and instructional literature about the hazard pattern.

5. Labeling Requirements

ASTM F3458–21 requires magnet sets intended for users 14 years and older to bear warnings on the retail packaging and “permanent storage container,” which the standard defines as a container designed to hold the magnet set when it is not in use. At a minimum, the warnings must address the hazard associated with magnet ingestions, direct users to keep the product away from children, and provide information about medical attention. The standard includes an example warning label, and specifies design and style requirements for the warning label. In addition, the standard requires the label to be permanent and provides a test method for assessing label permanence.

6. Packaging Requirements

The standard requires magnet sets intended for users 14 years and older to be sold with or in a permanent storage container. The permanent storage container must include a way to verify that all the magnets have been returned to the container. In addition, the standard requires the permanent storage container to be re-closeable and include one of the following means of restricting the ability to open the container: (1) The container requires two consecutive actions, the first of which must be maintained while the second is carried out, or requires two separate and independent simultaneous actions to fully release, withstanding specified testing; (2) the container requires one action that requires at least 15 lbf to open or requires at least 4 inches lbf of torque to open, withstanding specified testing; or (3) the container meets the performance requirements in 16 CFR 1700.15 and the testing requirements of 16 CFR 1700.20 (which are poison preventing packaging standards, adopted under the Poison Prevention

Packaging Act⁷⁶ and specify packaging that is significantly difficult for children under 5 years old to open within a reasonable time).

7. Assessment of Adequacy

CPSC staff does not consider ASTM F3458–21 capable of adequately reducing the risk of injury and death associated with magnet ingestions. For one, the limited scope of products subject to the standard is inadequate to address the hazard. The standard only applies to magnet sets intended for users 14 years and older. As such, it imposes no requirements on other products intended for users 14 years and older, or on jewelry (both children’s and adult), which are shown to be involved in magnet ingestion incidents.

In addition, the types of requirements in the standard make it inadequate to address the magnet ingestion hazard. For a detailed discussion of the weaknesses of warnings, instructional, sales/marketing, and packaging requirements to address the magnet ingestion hazard, see Tab C of the NPR briefing package. The following is an overview of these weaknesses.

Throughout the standard development process, CPSC staff emphasized that performance requirements for magnets are necessary to adequately address the magnet ingestion hazard. Such requirements typically include size and strength requirements for the magnets themselves, as in the toy standard and this proposed rule. However, ASTM F3458–21 does not include performance requirements to prevent magnet sets intended for users 14 years and older from containing small, powerful magnets, and instead, relies on requirements to inform and encourage consumers to keep magnets away from children. As incident data indicate, children and teens access magnet products, including magnet sets, that are intended for older users, making it important to address the magnet ingestion hazard for magnet sets intended for users 14 years and older. However, safety messaging (e.g., warnings and instructions) and packaging requirements, without performance requirements for the magnets themselves, are not likely to adequately address the hazard.

Safety Messaging. Safety literature has shown that warnings are the least effective strategy for addressing a hazard, relative to designing out the hazard or designing guards against the hazard. This is because safety messaging relies on persuading consumers to avoid

⁷⁶ 15 U.S.C. 1471–1477.

hazards, but numerous factors can reduce the likelihood that consumers will read and follow safety messaging.

One factor that weighs against consumers heeding safety warnings is their perception that magnet products present a low safety risk. Magnets in products intended for amusement or jewelry are likely to appear simple, familiar, and non-threatening to children, teens, and caregivers. Incident data and consumer reviews demonstrate that consumers commonly recognize these types of magnetic products as suitable playthings for children, which undermines the perceived credibility of warnings that state the magnets are hazardous for children. The availability of children's toys that are similar to subject magnet products intended for users 14 years and older may also affect consumers' perception of the hazard because the products appear similar, and some are marketed for children. Once familiar with a product, consumers tend to generalize across similar products, and the more familiar consumers are with a product, the less likely they are to look for, or read, warnings and instructions. If caregivers observe their child, or their child's peers using a product or a similar product without incident, caregivers may conclude that their child can use the product safely, regardless of what the warnings state. This is also true for recommendations from others, including online reviews of products, which can influence the likelihood of consumers disregarding warnings. Staff reviewed numerous consumer reviews of subject magnet products, and found that many indicated that consumers purchased the product for a child, or that their children started playing with it, despite the product not being intended for users under 14 years old. Similarly, when a child or teen repeatedly uses the product in or around their mouth without ingesting a magnet or experiencing consequences from ingestion, they and their caregivers are likely to conclude that the hazard is not likely to occur, or is not relevant to them.

Another reason that safety messaging has limited effectiveness is that consumers misunderstand the hazard. For small, powerful magnets, the internal interaction hazard is a hidden hazard, so consumers are unlikely to anticipate and appreciate the risk to children, especially older children and teens who do not have a history of mouthing or ingesting inedible objects. However, of the magnet ingestion cases that identify whether the ingestions were intentional or accidental, the majority describe accidental ingestions,

which is much more difficult for consumers to appreciate and prevent.

Similarly, there are developmental factors that predispose older children and teens to disregard warnings and use the small, powerful magnet products in and around their mouths and noses. As discussed above, older children and teens are at a developmental stage in which they test limits and bend rules. Experimentation and peer influence are common determinants of behavior for this age group. Small, powerful magnets offer a seemingly safe and reversible way to try out lip, tongue, cheek, and nose piercings; and if children and teens see their peers doing this, they may act similarly, despite being aware of the risks.

In addition, consumers misunderstand the progression of symptoms associated with magnet ingestions, which may lead them to disregard warnings. As incident reports show, many children, teens, and caregivers wrongly assume that, when ingested, magnets will pass through the body without causing harm. This contributes to delays between ingestion and correct treatment, increasing the risks associated with magnet ingestion.

Another factor that limits the potential effectiveness of safety messaging is how children and teens obtain magnets they ingest. As incident data show, children and teens commonly obtain ingested magnets loose in their environments, from friends, or at school, where the product is separated from any packaging or instructions that bear warnings. Because small, powerful magnets themselves are too small to bear warnings, these children and teens, and their caregivers, may not be made aware of the hazard.

Finally, safety messaging has been ineffective at reducing the magnet ingestion hazard, to date. As discussed above, and in Tab C of the NPR briefing package, staff has examined dozens of incident reports that indicate children and teens obtained and ingested small, powerful magnets even when the product was marketed and prominently labeled with warnings about the hazard and stated that the product was not appropriate for children. For example, of the CPSRMS incidents reported to have occurred between January 1, 2010 and December 31, 2020, staff examined at least 44 incidents in which a child ingested a magnet product that included warnings about the hazard and cautioned to keep the product away from children. Similarly, of 41 magnet sets for which staff assessed consumer reviews, 35 percent of the reviews mentioned use by children, despite 68

percent including a warning about the magnet ingestion hazard.

Another indication of the ineffectiveness of safety messaging to address the magnet ingestion hazard, to date, is the upward trend in magnet ingestion cases in recent years, despite many years of consumer awareness campaigns. As discussed above, for many years, CPSC has drawn attention to the magnet ingestion hazard through recalls, safety alerts, public safety bulletins, and rulemaking activity. In addition, there have been numerous public outreach efforts by health organizations and other consumer advocacy groups to warn consumers about the internal interaction hazard posed by small, powerful magnets. Despite these efforts, magnet ingestion incidents have increased in recent years.

Packaging. Similar to safety messaging, there are several reasons staff considers packaging requirements inadequate to address the magnet ingestion hazard. For one, incident data show that children and teens commonly access ingested magnets loose in their environment and from friends, in which case the product is likely to be separated from its packaging, rendering CR packaging or visual cues that all magnets are in the package ineffective.

In addition, the features provided for in ASTM F3458–21 to make the packaging difficult for children to open would not be effective at preventing older children and teens from accessing the magnets in the packaging. For example, the third packaging option provided in the standard allows the packaging to meet the requirements in 16 CFR 1700.15 and 1700.20. Those provisions are intended to make packaging significantly difficult for children under 5 years old to open within a reasonable time. Thus, such packaging does not prevent all children under 5 years old from opening it, particularly given ample time, and it is not intended to prevent any children 5 years and older from opening the packaging. As the incident data indicate, the majority of magnet ingestion incidents involved victims 5 years and older, making this packaging ineffective at restricting their access. Similarly, for the alternative packaging options in the standard, children and teens are likely to have cognitive and motor skills sufficient to access the products.

Even if CR packaging features did prevent children and teens from opening the packaging, the effectiveness of packaging to address the hazard would rely on consumers correctly repackaging all the magnets after every use, which is likely unrealistic. For one,

the products often are intended for purposes that make repackaging after each use unlikely. For example, products such as magnet sets are intended to assemble and display complex sculptures, and some jewelry may involve creating designs, making consumers unlikely to disassemble their designs to repackage all the magnets after every use. In addition, consumers are not likely to perceive the products as hazardous because they are intended for amusement or jewelry and are not hazardous in appearance, and therefore, would not consider it necessary to repackage all the magnets after every use. Even for products that are obviously hazardous and commonly use CR packaging, such as chemicals and pharmaceuticals, consumers have inconsistently used the packaging. Consumers may also consider CR packaging a nuisance, making them unlikely to store magnets in the packaging after every use.

In addition, the small size of the magnets and large number of magnets (particularly in some magnet sets and magnetic jewelry sets), make it unlikely that consumers would return all the magnets to the packaging after every use. The small size and often large quantity of magnets in a set make locating and counting the magnets after every use, to ensure they are all returned to the package, not feasible or realistic. For example, staff has identified products that were involved in magnet ingestion incidents that consisted of thousands of 2.5 mm diameter magnets. Staff has found that it is common for magnets to be flicked away from one another when they are being handled, such as when separating magnets, resulting in magnets being dropped. These actions are foreseeable, particularly for magnets intended for fidgeting and building. In examining magnet sets, staff found that many sets are sold with extra pieces, in part, because losing magnets is expected. In addition, many incident reports and consumer reviews of magnet sets mention lost magnets. Given the large number of magnets often included in a set, their small size, and their tendency to be separated and lost, it is unlikely that consumers will use CR packaging effectively. The time and effort necessary to locate, assemble, and repackage such small and numerous magnets is likely to be beyond what consumers are willing to spend.

For these reasons, ASTM F3458–21, alone, is not sufficient to address the magnet ingestion hazard because it does not impose performance requirements on magnets themselves, and it does not

apply to several products that are involved in magnet ingestion incidents.

E. EN 71–1: 2014

The European standard applies to children's toys, which are products intended for use in play by children younger than 14 years old. The requirements regarding magnets in EN 71–1: 2014 are essentially the same as in ASTM F963–17—any loose as-received magnet and magnetic component must either have a flux index less than 50 kG² mm², or not fit entirely in a small parts cylinder. The flux index is determined using the same method as in ASTM F963–17, and the small parts cylinder is the same as in ASTM F963–17. EN 71–1: 2014 also requires use-and-abuse testing similar to ASTM F963–17, to ensure that toys do not liberate a hazardous magnet or hazardous magnetic component. The standard includes a similar exemption to ASTM F963–17 for magnetic/electrical experimental sets intended for children 8 years of age and older, which need only bear a warning regarding the magnet ingestion hazard.

Thus, the provisions addressing the magnet ingestion hazard in EN 71–1: 2014 are largely the same as in ASTM F963–17. As discussed above, for ASTM F963–17, CPSC staff does not consider these provisions capable of adequately reducing the risk of injury and death associated with magnet ingestions because of the limited scope of the standard. Because the standard only applies to toys intended for children under 14 years old, it does not impose any requirements on products intended for older users, or products that would not be considered playthings. As the incident data indicate, magnet ingestion incidents include children and teens ingesting products intended for older users, and ingesting jewelry, neither of which this standard addresses.

F. ISO 8124–1: 2018

This standard applies to toys, which are products intended for use in play by children under 14 years old. The standard requires any loose as-received magnet and magnetic component to either have a flux index less than 50 kG² mm² or not fit entirely within a small parts cylinder. The flux index is determined the same way as in ASTM F963–17, and the small parts cylinder is the same as in ASTM F963–17. ISO 8124–1 also requires similar use-and-abuse testing to ASTM F963–17, to ensure that a hazardous magnet or hazardous magnetic component does not liberate from a toy. Similar to ASTM F963–17, ISO 8124–1 also provides an exemption for magnetic/electrical

experimental sets intended for children 8 years and older, which need only bear a warning regarding the magnet ingestion hazard.

Thus, the provisions addressing the magnet ingestion hazard in ISO 8124–1: 2018 are largely the same as in ASTM F963–17. As discussed above, for ASTM F963–17, CPSC staff does not consider these provisions capable of adequately reducing the risk of injury and death associated with magnet ingestions because of the limited scope of the standard. Because the standard only applies to toys intended for children under 14 years old, it does not impose any requirements on products intended for older users, or products that would not be considered playthings. As the incident data indicate, magnet ingestion incidents include children and teens ingesting products intended for older users, and ingesting jewelry, neither of which this standard addresses.

G. Compliance With Existing Standards

CPSC has limited information about the extent to which products comply with existing standards. Based on staff's analysis, only a small number of magnet ingestion incidents for which a product type could be identified involved children's toys subject to ASTM F963, which provides some indication that children's toys commonly comply with the standard. Of the magnet ingestion incidents that involved children's toys, staff identified six incidents that involved internal interaction of the magnets through body tissue, again suggesting there may be a high level of compliance with the standard. None of the products in these six incidents complied with the magnet requirements in ASTM F963.

CPSC staff does not have detailed information about the extent to which products comply with ASTM F2923, F2999, or F3458. Incident reports commonly do not provide enough detail for staff to identify the specific product (*e.g.*, brand) to obtain it and assess it for compliance. In addition, for ASTM F3458, the standard was adopted recently (March 2021), making it difficult to determine the level of compliance with it. CPSC seeks comments and data about the level of compliance with the existing standards that address the magnet ingestion hazard.

VI. Description of and Basis for the Proposed Rule

A. Scope and Definitions

1. Proposed Requirements

The proposed rule applies to “subject magnet products,” defined as “a

consumer product that is designed, marketed, or intended to be used for entertainment, jewelry (including children's jewelry), mental stimulation, stress relief, or a combination of these purposes, and that contains one or more loose or separable magnets." The proposed rule exempts from its scope, toys that are subject to 16 CFR part 1250, *Safety Standard Mandating ASTM F963 for Toys*.

The proposed rule only applies to "consumer products," as defined in the CPSA, which are "article[s], or component part[s] thereof, produced or distributed (I) for sale to a consumer for use in or around a permanent or temporary household or residence, a school, in recreation, or otherwise, or (ii) for the personal use, consumption or enjoyment of a consumer in or around a permanent or temporary household or residence, a school, in recreation, or otherwise." 15 U.S.C. 2052(a)(1). Consumer products do not include products that are not customarily produced or distributed for sale to, or for the use or consumption by, or enjoyment of, a consumer. *Id.*

The proposed rule also defines "hazardous magnets" as "a magnet that fits entirely within the cylinder described in 16 CFR 1501.4 and that has a flux index of 50 kG² mm² or more when tested in accordance with the method described in this part 1262."

2. Basis for Proposed Requirements

To determine the appropriate scope of products to cover in the proposed rule to adequately reduce the risk of injury and death associated with magnet ingestions, CPSC staff considered magnet ingestion incident data, magnet use patterns, magnet ingestion rates when other mandatory standards took effect, recalls, child development and behavioral patterns, the uses of hazardous magnets in consumer products, consumer reviews for products with loose or separable hazardous magnets, existing standards, contributions from stakeholders in the ASTM Subcommittee F15.77 on Magnets, and relevant research literature. The definition of "subject magnet products" consists of several elements that include and exclude certain products from the scope of the proposed rule. This section discusses the reasons for the criteria in the definition. The basis for the elements of the proposed definition of "hazardous magnets" is discussed below, as part of the basis for the performance requirements in the proposed rule.

a. Consumer Products

Subject magnet products are limited to "consumer products," as that term is defined in the CPSA. Accordingly, any product that is not customarily produced or distributed for sale to or use by a consumer, is not within the scope of the proposed rule. This could include professional, industrial, or commercial products that would not customarily be available to or used by consumers. This element of the definition is included because CPSC's authority under the CPSA is limited to consumer products, and because products that are not customarily available to consumers would not be likely to pose a magnet ingestion hazard to children and teens.

b. Loose or Separable Magnets

Subject magnet products are limited to products that contain "loose or separable magnets." This is because magnets that are not loose or separable, such as non-removable magnets that are integrated into or attached to a product, would not pose an ingestion hazard. For example, a magnetic clasp attached to a necklace would not pose an ingestion hazard because it is connected to a larger object, making it unlikely to be swallowed.

In addition, the definition of "subject magnet products" specifically refers to magnets. Although not explicit in the definition, this refers to permanent magnets, which are magnets that maintain their magnetic field after being removed from the magnetizing source. Staff does not consider it necessary to specify that the standard applies to permanent magnets. For one, products that lose their magnetism when separated from their magnetizing source (*e.g.*, electromagnets that lose their magnetism when separated from the source of electricity) are unlikely to exceed the size criteria in the proposed rule when functioning as magnets because, to be magnetized, the product would have to be attached to its magnetizing source, which would render the product too large to fit entirely within the small parts cylinder. When separated from its magnetizing source, thereby making the item potentially small enough to fit entirely in the small parts cylinder, the item would lose its magnetism, and no longer be a "magnet" subject to the standard. In addition, for the magnet to be "loose or separable" it would need to be a magnet (*i.e.*, magnetized) when loose and separated from other components, including a magnetizing source. CPSC seeks comments on whether it is necessary for the proposed rule to

specify that it applies only to permanent magnets, or whether the rule should apply to non-permanent magnets as well.

c. One or More Magnets

The definition also specifies that subject magnet products include "one or more" loose or separable magnets; thus, they include products with only a single loose or separable magnet. There are two reasons for including this in the definition of "subject magnet products." First, an individual magnet can interact internally through body tissue with an unrelated magnet or a ferromagnetic object, resulting in an internal interaction injury. Thus, even a product with a single loose or separable magnet poses the same internal interaction hazard as products with multiple magnets. Second, subject magnet products may be sold as individual magnets or with a choice of how many magnets to include in a set. Staff identified magnets sets on the market that are sold with extra pieces to serve as replacements for magnets lost from the set. Thus, magnets sold individually may be intended as, or may be used as, part of a set, posing the risk of children and teens ingesting more than one magnet. Limiting the proposed rule to products that include two or more loose or separable magnets would not address the hazard posed by a single magnet, and would leave a gap in the standard to allow firms to sell magnets individually, without having to comply with the proposed rule. Moreover, applying the proposed rule to products that include a single loose or separable magnet is consistent with the toy standard in 16 CFR part 1250 because ASTM F963-17 applies to products that contain one or more hazardous magnets.

d. Amusement or Jewelry

The definition of "subject magnet products" is limited to products that are designed, marketed, or intended to be used for entertainment, jewelry, mental stimulation, stress relief, or a combination of these purposes. Essentially, this means that the proposed rule applies to products that are designed, marketed, or intended for amusement or jewelry. This section discusses the reasons CPSC considers it appropriate to focus on magnet products intended for amusement and jewelry to reduce the risk of injury and death associated with magnet ingestions. The focus on amusement and jewelry products is also consistent with

international standards, which address these products, in particular.⁷⁷

Description of Products. Magnets intended for amusement include a variety of products for consumer entertainment, mental stimulation, and stress relief. Whether a product is designed, marketed, or intended to be used for these purposes depends on multiple considerations, such as how the manufacturer describes the product, marketing and advertising for the product, product packaging and displays, and how consumers are reasonably likely to perceive or use the product. Common examples of products that contain loose or separable magnets intended for entertainment, mental stimulation, or stress relief (other than children's toys) include products commonly referred to as "executive toys," "desk toys," "magnet sets," and "rock magnets." Magnet sets generally are aggregations of separable magnets commonly used for manipulating or constructing sculptures. Rock magnets generally are loose magnets shaped like rocks and intended for entertainment or fidgeting. These are some examples, and additional products may be designed, marketed, or intended to be used for entertainment, mental stimulation, stress relief, or a combination of these purposes.

Subject magnet products that are jewelry also include a variety of products, such as jewelry intended for adults or for children, jewelry making sets, and magnetic piercings and studs. For example, staff has identified necklaces made of numerous small magnets, in multiple shapes, that consumers can rearrange in various configurations.

Incident Data. As the incident data indicate, magnet ingestion cases generally involve seven categories of magnet products (see section IV.A. *Incident Data*, above, for a detailed description of the categories): Magnet sets, magnet toys, jewelry, home/kitchen magnets, ASTM F963 magnet toys, science kits, and unidentified products. Products categorized as magnet sets, magnet toys, and ASTM F963 magnet toys are generally intended for amusement, however, ASTM F963 magnet toys are excluded from the scope of the proposed rule.

As the incident data show, products categorized as amusement and jewelry, by far, are the most common product categories identified in magnet ingestion incidents. Table 1 shows that magnet

toys, by far, were the most common product type category identified⁷⁸ in NEISS magnet ingestion incidents (110 of 279, or 39 percent), followed by magnet sets (58 of 279, or 21 percent), and jewelry (53 of 279, or 19 percent). The remaining identified product categories made up fewer of the magnet ingestion cases: Home/kitchen magnets (46 of 279, or 16 percent), ASTM F963 magnet toys (11 of 279, or 4 percent), and science kits (1 of 279, or less than 1 percent). Thus, for NEISS magnet ingestion incidents in which the product category could be identified, 79 percent (221 of 279 incidents) involved products in the magnet sets, magnet toys, or jewelry categories.

CPSRMS data similarly show that magnet sets, magnet toys, and jewelry are the primary categories of products identified in magnet ingestion reports. As Table 9 shows, magnet sets, by far, were the most common product type identified⁷⁹ in CPSRMS magnet ingestion incidents, making up 56 percent (134 of 241) of the incidents for which product type categories could be identified, followed by magnet toys (49 of 241, or 20 percent), and jewelry (31 of 241, or 13 percent). The remaining identified product categories made up fewer of the magnet ingestion cases: ASTM F963 magnet toys (21 of 241, or 9 percent), home/kitchen magnets (6 of 241, or 2 percent), and 0 science kits. Thus, for CPSRMS magnet ingestion incidents in which the product category could be identified, 89 percent (214 of 241 incidents) involved products in the magnet sets, magnet toys, or jewelry categories.

The severity of health outcomes associated with magnet ingestions provides further support for focusing on amusement and jewelry products in the proposed rule. Fatalities are one indication of the severity of health outcomes. As discussed above, CPSC identified seven fatalities that involved the ingestion of hazardous magnets between November 24, 2005 and January 5, 2021, 5 of which occurred in

⁷⁸ As explained above, for many NEISS incidents, there was insufficient information for staff to identify the category of magnet products involved. Of the 1,072 NEISS magnet ingestion incidents from 2010 through 2020, staff categorized 793 as "unidentified" magnet product types. For this reason, this analysis focuses on the remaining 279 incidents for which staff could categorize the product type.

⁷⁹ Like NEISS data, CPSRMS data also includes incidents for which there was insufficient information for staff to determine the category of magnet products involved. However, the proportion of incidents in the unidentified magnet product type category is much lower in CPSRMS than in NEISS data. Nevertheless, this analysis focuses on the 241 incidents for which staff could categorize the product type.

the United States. CPSC was able to definitively identify one of the products involved in these incidents (a 2005 death in the United States), which was a children's toy building set, a product intended for amusement. In addition, the most recent incident (a 2021 death in the United States) involved a magnet set, which is also a product intended for amusement. Of the remaining five incidents, three incidents (a 2013 death in the United States and two deaths in other countries) involved magnets that matched the characteristics of magnets typically found in magnet sets, but did not identify the involved product with certainty; one incident (a 2018 death in the United States) involved magnets that matched the characteristics of magnets typically found in magnet sets, and the product was described consistently with magnet sets (*i.e.*, a magnet fidget toy building set); and one incident (a 2020 death in the United States) did not provide information about the product type. This suggests that amusement products, such as magnet sets, are involved in the most severe magnet ingestion cases.

Whether a victim was hospitalized after ingesting magnets provides another indication of the severity of injuries or the need for significant treatment. As Table 10 shows, using CPSRMS data, the most common product types identified⁸⁰ in magnet ingestion cases that resulted in hospitalization were magnet sets (88 of 160, or 55 percent), followed by magnet toys (36 of 160, or 23 percent), and jewelry (21 of 160, or 13 percent). Hospitalizations for the remaining identified magnet categories were much lower: ASTM F963 magnet toys (10 of 160, or 6 percent), and home/kitchen magnets (5 of 160, or 3 percent).⁸¹ Thus, for CPSRMS magnet ingestion incidents in which the product category could be identified, 91 percent (145 of 160 incidents) of hospitalizations involved magnet sets, magnet toys, or jewelry. Moreover, as Table 10 shows, magnet ingestions from magnet toys, magnet sets, and jewelry, all resulted in hospitalization far more often than they resulted in other non-hospitalization dispositions.

Use patterns at the time magnets were ingested also show the need to address amusement and jewelry products. The most common identified use pattern at the time of a magnet ingestion was playing, meaning the victim was playing

⁸⁰ To determine the type of products involved in magnet ingestion hospitalizations, this analysis excludes the 27 incidents for which there was insufficient information to categorize the type of magnet ingested.

⁸¹ There were no incidents in CPSRMS that were identified as involving science kits.

⁷⁷ As discussed above, Canada's efforts to address the magnet ingestion hazard have focused on products intended for amusement, and New Zealand's and Australia's efforts have focused on products intended for amusement and jewelry.

with, fidgeting with, or orally exploring magnets at the time of ingestion. This use pattern would be expected for products intended for amusement, since they are intended for play. As Table 13 shows, in both NEISS and CPSRMS incidents, by far, playing was the most common use pattern identified,⁸² making up 70 percent (143 of 203) of the NEISS incidents, and 47 percent (61 of 129) of the CPSRMS incidents with identified use patterns. The next most common use pattern, after playing, was jewelry, meaning the magnets were being used as jewelry at the time of the incident. These made up 15 percent (31 of 203) of the NEISS incidents, and 33 percent (43 of 129) of the CPSRMS incidents with identified use patterns. The remaining identified use patterns made up fewer of the incidents. As discussed in section IV.A.5.

Uncertainties in Incident Data, above, it is reasonable to conclude that magnet ingestions in the unidentified product type category follow this same pattern, with most involving products intended for amusement or jewelry.

Together, these factors—the prevalence of magnet ingestion incidents that involve products categorized as magnet sets, magnet toys, or jewelry; the higher rate of hospitalizations and deaths for these product categories; and the fact that the primary uses of magnets at the time of ingestion were playing and jewelry—demonstrate that magnet sets, magnet toys, and jewelry are the primary products involved in magnet ingestion incidents and pose an increased risk of serious health implications when ingested. For these reasons, CPSC considers a rule addressing these specific product categories necessary to adequately reduce the risk of injury and death associated with magnet ingestions. The definition of “subject magnets” in the proposed rule, which is limited to amusement and jewelry products, focuses the proposed rule on these most problematic products.

Developmental and Behavioral Factors. Child and teen development and behavior also support the need to address magnets intended for amusement and jewelry in the proposed rule. Small, powerful magnets, in general, are likely to appeal to children and teens. The tactile appeal, shine, color, snapping/clicking sounds when manipulated, novelty, unpredictability,

and complexity of magnets appeal to children and teens. For younger children, it is developmentally normal to explore and put objects in their mouths. Incident data demonstrate this, with younger children more likely to ingest magnets intentionally (see Figures 3 and 4). Teens are at a developmental stage that involves testing limits, experimentation, bending rules, and conforming to peer pressures. Consistent with this, teens commonly ingested magnets accidentally when experimenting with them to simulate jewelry or piercings (see Figures 3 and 4). Magnets offer children and teens a seemingly safe and reversible way to try lip, tongue, cheek, and nose piercings.

CPSC staff considers products that are intended for amusement and jewelry to be more likely to be accessible to and appealing to children and teens than other magnet products. Products that are intended for amusement and jewelry are likely to be perceived by children, teens, and caregivers as appropriate for use by children and teens; that perception is likely to make them accessible and appealing to children and teens. In contrast, magnets excluded from the scope of the proposed rule (e.g., home/kitchen magnets, such as hardware magnets for fastening items together, or shower curtain magnets) are likely to be part of common household products, making them less conspicuous, accessible, and appealing to children and teens, since they are not intended for amusement or jewelry, and making caregivers less likely to give them to, purchase them for, or allow their use by children and teens.

Incident data and consumer reviews support this assessment. As the incident data indicate, for magnet ingestions in which staff could identify the product type involved, most products were magnet sets and magnet toys, neither of which are products intended for use by children under 14 years old (see Table 1 and Table 9). Despite this, the vast majority of magnet ingestion incidents involved children under 14 years old (see Table 5 and Table 12), which demonstrates that children and teens access these amusement products intended for older users. Similarly, incident data show that, where the use pattern at the time of ingestion is known, victims were, by far, most often playing with the magnet (see Table 13), suggesting that victims may be attracted to and access products that appear to be playthings. The second most common identified use pattern was jewelry (see Table 13), suggesting that children and teens are also particularly likely to

interact with magnets that are part of jewelry.⁸³

Of the magnet ingestion incidents for which the source of access could be identified, 19 percent (26 of 135) involved magnets that were purchased for the victim (see Table 14), despite most incidents involving children under 14 years old and products intended for users 14 years and older. This suggests that children, teens, and caregivers perceive products like magnet sets and magnet toys to be appealing to and appropriate for children and teens.

Another reason children and teens are particularly likely to be attracted by and access amusement products that include magnets is that these products often look the same as products intended as toys for children. Consumer reviews of products demonstrate this, with consumers commonly considering subject magnet products suitable playthings for children, and purchasing them for children, even when warnings state otherwise. Staff identified numerous incidents in which children ingested magnets from products that were marketed and labeled as not intended for children, and bore warnings regarding the magnet ingestion hazard. For example, staff identified 16 recent incidents in which children ingested magnets from a magnet set that included warnings and marketing indicating that the product was intended for adults. For older children, in particular, parents often do not expect that children would place magnets in their mouths.

Recalls. Recalls of magnet products further demonstrate the need to focus on magnets intended for amusement. Of the 18 recalls that involved the magnet ingestion hazard between January 1, 2010 and August 17, 2021, the vast majority involved products intended for amusement. The recalls primarily involved magnet sets and desk toys, rather than children’s toys or other non-amusement products.

⁸³ Incidents categorized as involving jewelry included cases in which the magnet was from a jewelry product or was described as jewelry at the time of ingestion, but the specific product could not be identified. For some of these incidents, it is possible that the magnets did not actually come from jewelry, but rather, came from other magnet products that children and teens were using as jewelry. However, staff considers most cases categorized as jewelry to have involved either jewelry or amusement products, such as magnet sets, being used as jewelry. This is because, of the cases for which staff could determine the product being used as jewelry, only one case in both the NEISS and CPSRMS datasets reported that the magnet being used as jewelry was actually a home/kitchen magnet, and none indicated the magnet was from an ASTM F963 magnet toy.

⁸² For many NEISS and CPSRMS incidents, there was insufficient information for staff to determine the use pattern at the time magnets were ingested. To identify relevant use patterns, this analysis focuses on the 203 NEISS incidents and 129 CPSRMS incidents for which staff could determine the use pattern at the time of ingestion.

e. Excluding Children's Toys

The scope of the proposed rule specifically excludes products that are subject to 16 CFR part 1250. Currently, 16 CFR part 1250 incorporates by reference ASTM F963–17, which defines a “toy” as “any object designed, manufactured, or marketed as a plaything for children under 14 years of age.” As discussed above, ASTM F963–17 includes requirements consistent with the proposed rule, including the same performance requirements regarding size and strength.

Recall information suggests that the toy standard is largely complied with and has been effective at addressing the magnet ingestion hazard in children's toys. As discussed in section IV.A.5. *Uncertainties in Incident Data*, since the toy standard became mandatory, there has been an appreciable decline in recalls of children's toys related to the magnet ingestion hazard. Of the 18 recalls between 2010 and 2021 that involved the magnet ingestion hazard, only 4 involved children's toys, and only 2 of those were confirmed to have been noncompliant with the magnet requirements in ASTM F963. Recalls generally occur when a company receives information about a product being hazardous and reports it to CPSC. As such, the low rate of recalls involving the magnet ingestion hazard in children's toys suggests that these products largely comply with ASTM F963, and that the toy standard has been effective at addressing the magnet ingestion hazard in children's toys.

In addition, as Table 10 suggests, when ASTM F963 magnet toys are ingested, they appear to result in severe injuries less commonly than other products. Magnet ingestions of ASTM F963 magnet toys resulted in hospitalization about as often as they resulted in other non-hospitalization dispositions; in contrast, magnet toys, magnet sets, and jewelry all resulted in hospitalization far more often than they resulted in other non-hospitalization dispositions. This suggests that when ASTM F963 magnet toys are ingested, they may be less likely to result in serious health outcomes requiring hospitalization. Of the 108 CPSRMS cases that had evidence of internal interaction through body tissue, only 6 cases involved products identified as ASTM F963 magnet toys. Of the 124 CPSRMS cases that indicated surgical procedures were necessary as a result of magnet ingestion, only 9 cases involved products identified as ASTM F963 magnet toys. Most, if not all, of the ingestions of ASTM F963 magnet toys that resulted in surgical intervention did

not meet the requirements of ASTM F963.

For these reasons, CPSC does not consider it necessary to further address children's toys in this proposed rule. Nevertheless, there are two elements of the definition of “toys” that are noteworthy for this proposed rule.

First, “toys” are products that are intended as “playthings.” Thus, toys do not include products that are not playthings, even when they are intended for children under 14 years old. For example, children's jewelry, when not intended as a plaything, would not fall under the definition of a “toy” and, therefore, would not be subject to the toy standard.⁸⁴ As such, children's non-toy jewelry is subject to the proposed rule. Additional products may also fall under the scope of the proposed rule, although intended for users under 14 years old, if they do not constitute “playthings,” but otherwise meet the definition of subject magnet products.

Second, the definition of “toys” limits them to products intended for users under 14 years old. However, as magnet ingestion incident data show, products that are intended for users 14 years and older are commonly ingested by children and teens, indicating that the toy standard, on its own, cannot adequately address the magnet ingestion hazard. As discussed above, incidents categorized as involving magnet sets or magnet toys exclude products that staff confirmed were intended as playthings for children under 14 years old. These two categories were the most common categories of identified products involved in magnet ingestion incidents, despite the fact that most incidents involved children and teens under 14 years old. As Figure 2 shows, children as young as 11 months, and many children between 1 and 13 years old ingest products in the magnet toys and magnet sets categories. Staff identified many incidents in which the product ingested was clearly marketed and labeled as intended for adults, with warnings regarding the magnet ingestion hazard, but the product was,

⁸⁴ Section 1.3 of ASTM F963–17 states that the standard applies to “toys intended for use by children under 14 years of age” and section 3.1.91 defines a “toy” as “any object designed, manufactured, or marketed as a plaything for children under 14 years of age.” Section 1.3.1 of ASTM F2923–20 specifies that the standard, which applies to children's jewelry, does not apply to “toy jewelry or any other products that are intended for use by a child when the child plays (that is, a necklace worn by a doll or stuffed animal; novelty jewelry with play value)” and further states that “any product which is predominately used for play value is a toy” and “toys are subject to the requirements of Consumer Safety Specification F963.”

nevertheless, ingested by children under the intended user age. In many cases, caregivers even provided these products to children, despite the warnings. This demonstrates why it is necessary to adopt a standard for products intended for users 14 years and older, in addition to the toy standard, to adequately address the magnet ingestion hazard.

f. Products Not Covered by the Proposed Rule

Based on the definition of “subject magnet products” and the scope of the proposed rule, certain products that contain loose or separable magnets are not subject to the proposed rule. Home and kitchen magnets are one such product, if they do not otherwise meet the definition of subject magnet products. Common examples of home and kitchen magnets are refrigerator magnets, magnetic decorations, hardware for kitchen cabinets, and shower curtain accessories. If such products are not loose or separable or are not designed, marketed, or intended to be used for entertainment, jewelry, mental stimulation, or stress relief, they would not fall under the scope of the proposed rule.

CPSC considers it reasonable to exclude home/kitchen products from the scope of the proposed rule for several reasons. For one, incident data indicate that home/kitchen magnets are far less commonly involved in magnet ingestion incidents than amusement and jewelry products. As Table 1 indicates, 16 percent (46 of 279) of NEISS magnet ingestion incidents for which the product category could be determined involved home/kitchen magnets; as Table 9 indicates, only 2 percent (6 of 241) of CPSRMS magnet ingestion incidents for which the product category could be determined involved home/kitchen magnets. Home/kitchen magnets also make up a very small portion of incidents that resulted in hospitalization. Table 10 shows that, only 3 percent (5 of 160) of the CPSRMS magnet ingestion incidents with identified product types that resulted in hospitalization, involved home/kitchen magnets. Of the 108 CPSRMS cases that had evidence of internal interaction through body tissue, only 1 case involved products identified by staff as home/kitchen products. Of the 124 CPSRMS cases that indicated surgical procedures were necessary as a result of magnet ingestion, only 2 cases involved products identified by staff as home/kitchen products.

In addition, as discussed above, CPSC considers it less likely that children and teens will interact with, play with, or experiment with home/kitchen magnets,

particularly in ways that may lead to ingestion. Home/kitchen products excluded from the proposed rule were intended uses that do not include amusement or jewelry, and are often part of common household products, making them less conspicuous, accessible, and appealing to children and teens, since they are not intended for amusement or jewelry, and making caregivers less likely to give them to, purchase them for, or allow their use by children and teens. In contrast, the intended uses of amusement and jewelry products make them appear less hazardous, and more likely to be appealing and accessible to children and teens.

Other products that would fall outside the scope of the proposed rule include research and educational products, or those intended for commercial or industrial purposes, if they are not also intended for amusement or jewelry.⁸⁵ CPSC considers it appropriate to exclude these products for several reasons. As incident data indicate, almost no magnet ingestion incidents for which product types could be identified involved products intended for education, research, commercial, or industrial use. Among NEISS incidents, only one incident—involving a science kit—potentially involved such a product; no such incidents were identified in CPSRMS data. For that one incident, little information was

⁸⁵ It is also possible that products intended for purposes such as education, research, or industrial applications would not meet the definition of a “consumer product,” if they are not commonly sold to or used by consumers. If, for example, magnets for research purposes were sold through outlets primarily accessible to and used by laboratories or other research facilities, these may not be considered consumer products.

available about the science kit, but staff considered it possible that the product was intended for educational purposes.

Staff also considers it less likely that children or teens would have access to such products. For example, magnets used for research or industrial applications are likely to be in settings that children do not frequent. Even if children could access such products, for the same reasons as home/kitchen magnets, staff considers it less likely that these products would appeal to children, appear to be playthings or jewelry to children or caregivers, or for children to interact with them in ways that would lead to ingestion.

In addition to the likely reduced hazard these out-of-scope products present to children and teens, CPSC also seeks to limit the scope of the proposed rule to the extent possible to reduce the impact on products, such as research, education, and industrial magnet products, that may have important uses and require magnets that are small and strong to serve their function. In contrast, amusement and jewelry products likely serve less critical functions and may still serve their purpose with slightly larger or slightly weaker magnets, or non-separable magnets.

g. Other Factors Not Used in the Proposed Rule

CPSC considered using additional criteria, such as magnet composition or shape, as part of the scope of the proposed rule. However, CPSC did not limit the scope of the proposed rule to specific magnet compositions because staff has found that various magnet compositions have been involved in internal interaction incidents. For

example, NIB is commonly used for smaller magnets from magnet sets and magnetic jewelry sets, and ferrite/hematite is commonly used for larger magnets, such as rock-shaped magnet toys. Staff testing of magnets in consumer products indicates that magnets with various compositions often have very high flux indexes, far in excess of the proposed limit of less than 50 kG² mm², warranting a standard for various compositions. CPSC did not include specific shapes or sizes in the scope of the proposed rule because staff found that various shapes and sizes of magnets present the hazard, including rock-shaped magnets, and most incident reports lack information about the specific shapes and sizes of the magnets. As such, the performance requirements in the proposed rule address magnets that could be ingested, regardless of their shape.

B. Performance Requirements

1. Proposed Requirements

Under the proposed rule, each loose or separable magnet in a subject magnet product that fits entirely within the small parts cylinder described in 16 CFR 1501.4 must have a flux index of less than 50 kG² mm² when tested in accordance with a prescribed method. Thus, the first step is to determine whether each loose or separable magnet in a subject magnet product fits in the small parts cylinder and what its flux index is.

The small parts cylinder is described and illustrated in 16 CFR part 1501.4. Figure 5, below, shows the illustration, including the dimensions, of the cylinder, provided in the regulation.

BILLING CODE 6355-01-P

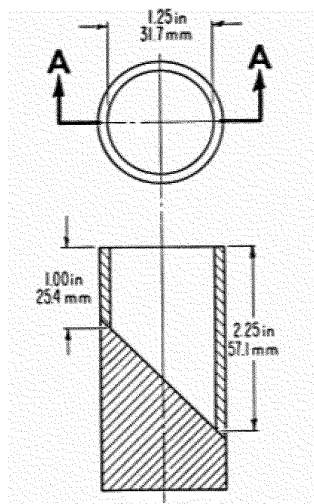

Figure 5: Small parts cylinder in 16 CFR 1501.4

If a magnet fits entirely within this cylinder, then its flux index must be less than $50 \text{ kG}^2 \text{ mm}^2$.

To determine the flux index of a magnet, the proposed rule provides that at least one loose or separable magnet of each shape and size in the subject magnet product must have its flux index determined using the procedure in sections 8.25.1 through 8.25.3 of ASTM F963–17, which specify test equipment, measurements, the test method, and the calculation for determining flux index. The test requires a direct current field gauss meter with a resolution of 5 gauss (G) capable of determining the field with an accuracy of 1.5 percent or better and an axial probe with a specified active area diameter and a distance between the active area and probe tip. Using the meter, the probe tip is placed in contact with the pole surface of the magnet, the probe is kept perpendicular to the surface, and the probe is moved across the surface to find the maximum absolute flux density. The flux index, in $\text{kG}^2 \text{ mm}^2$, is determined by multiplying the area of the pole surface (mm^2) of the magnet by the square of the maximum flux density (kG^2). The flux density must be less than $50 \text{ kG}^2 \text{ mm}^2$ to comply with the proposed rule.

2. Basis for Proposed Requirements

a. Size Requirements

The first portion of the performance requirement in the proposed rule involves determining whether a magnet fits entirely within the small parts cylinder described in 16 CFR 1501.4. The purpose of this requirement is to determine whether a magnet is small enough to be swallowed. If so, then it is subject to strength requirements to reduce the risk of internal interaction

injuries from strong magnets. However, if the magnet is too large to be swallowed, as determined by the small parts cylinder, then it is not subject to any strength requirements.

The small parts cylinder was developed to address choking, aspiration, and ingestion hazards for children, and was largely based on research and data regarding the size of objects children ingest. To address this hazard, since 1980, the Commission's regulations (at 16 CFR part 1501) have specified that certain toys and other articles intended for use by children must not contain choking, aspiration, or ingestion hazards for children. Whether these products present such hazards is determined by whether they fit within the small parts cylinder described in 16 CFR 1501.4.⁸⁶ Several ASTM standards for children's products reference these regulations as well, requiring that products have no small parts as determined by 16 CFR part 1501,⁸⁷ and the small parts cylinder specified in the ASTM standards that addresses magnet ingestions is the same as in 16 CFR 1501.4. Similarly, the small parts cylinders referenced in international standards that address magnet ingestions, including EN 71–1: 2014 and ISO 8124–1: 2018, are also the same as in 16 CFR 1501.4. These standards are developed by consensus of various groups, including consumer groups, children's product engineers and experts, and manufacturers of children's products. As such, the small parts cylinder in 16 CFR 1501.4 is consistent

⁸⁶ See 43 FR 47684 (Oct. 16, 1978); 44 FR 34892 (June 15, 1979).

⁸⁷ For example, ASTM F2088–20, *Standard Consumer Safety Specification for Infant and Cradle Swings*.

with consensus standards developed with cooperation and input from various experts, is widely recognized, and has long been used as a way to identify products that children can ingest.

Incident data further support the effectiveness of the small parts cylinder in 16 CFR part 1501.4 to address the magnet ingestion hazard. As discussed above, magnet ingestion incidents substantially declined during the years the magnet sets rule was announced and in effect, and substantially increased after the rule was vacated. The magnet sets rule included the same performance requirements regarding size and strength as this proposed rule, including the small parts cylinder. The marked decline in magnet ingestions during that rule suggests that the performance requirements in that rule were effective at reducing the risk of children ingesting magnets.

Similarly, there was a significant decline in recalls involving the magnet ingestion hazard after the toy standard became mandatory. The toy standard requires compliance with ASTM F963, which includes the same small parts cylinder as 16 CFR 1501.4. As such, this decline in recalled toys that present a magnet ingestion hazard after the toy standard became mandatory suggests that the requirements in that rule were effective at reducing the risk of children ingesting magnets. The low number of magnet ingestion incidents that identify ASTM F963 magnet toys as the involved product also indicates that the requirements in the standard have been effective at addressing the magnet ingestion hazard. Moreover, when magnet ingestions did occur with children's toys, they rarely resulted in

the internal interaction hazard, and those that did result in internal interaction, did not comply with the toy standard.

For these reasons, the proposed rule uses 16 CFR 1501.4 as the means of determining whether a child could ingest a particular magnet, thereby subjecting it to performance requirements regarding strength, to reduce the risk of injury.

b. Strength Requirements

When a magnet is small enough to fit entirely within the small parts cylinder, the proposed rule requires that the magnet have a flux index less than 50

$\text{kG}^2 \text{mm}^2$. This provision consists of two elements—a method for determining flux index, and a flux index limit of less than $50 \text{ kG}^2 \text{mm}^2$. This requirement is intended to reduce the risk that a magnet is strong enough to cause internal interaction injuries, if ingested. This section discusses the rationale for both the flux index methodology and the flux index limit in the proposed rule.

Flux Index Methodology. The proposed rule incorporates by reference the provisions in ASTM F963 that specify the method for measuring and calculating flux index. The ASTM Subcommittee F15.22 on Toy Safety

developed this methodology and ASTM first published it in ASTM F963–07. The magnetic flux index estimates the magnet attraction force of individual single-pole magnets.

A magnet's composition, mass, and shape determine its magnetic field. This field is aligned with its north and south magnetic poles (see Figure 6). Surface flux density is a measurement of the magnetic field intensity at a given perpendicular distance above an area (dimension "x" in Figure 6). The maximum flux density is measured perpendicular to the pole surface of a magnet.

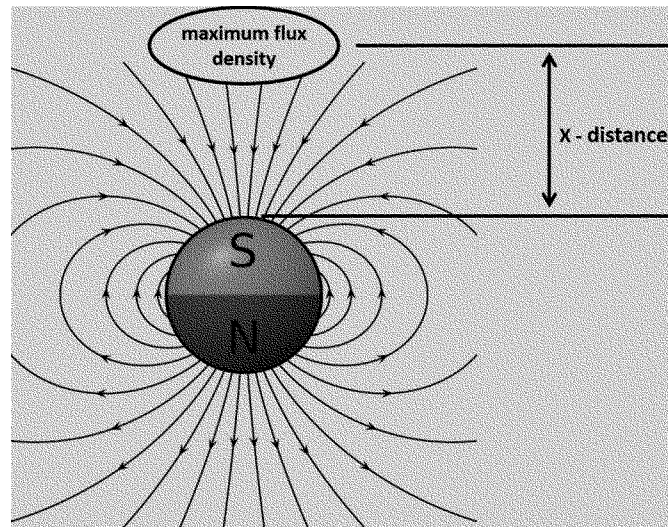

Figure 6: Magnetic field of spherical magnet.

BILLING CODE 6355-01-C

The ASTM F963 working group that developed the flux index methodology aimed to address injuries involving children ingesting small, powerful magnets. As such, it was designed to address the same hazard at issue in this proposed rule, and minimize the risk of internal injuries when magnets are ingested. As part of an ASTM standard, this methodology was developed by consensus, with input from various stakeholders, such as children's product manufacturers, consumer groups, and children's product engineers and experts. In addition, this methodology is used in multiple ASTM standards that address the magnet ingestion hazard, international standards (including EN 71-1: 2014 and ISO 8124-1: 2018), and the mandatory toy standard in 16 CFR part 1250. As part of these standards, the methodology is widely recognized and accepted, and has been used for many years.

CPSC staff considers this methodology effective for assessing the strength of subject magnet products. Incident data also support the effectiveness of the flux index methodology in ASTM F963 to address the magnet ingestion hazard. Magnet ingestion incidents appreciably declined during the years the magnet sets rule was announced and in effect, and appreciably increased after the rule was vacated. The magnet sets rule included the same size and strength limits as this proposed rule, and incorporated by reference the flux index methodology in ASTM F963. The decline in magnet ingestions during that rule suggests that the performance requirements in that rule were effective at reducing the risk of injury and death associated with magnet ingestions. Similarly, there was a significant decline in recalls involving the magnet ingestion hazard after the toy standard

became mandatory. The toy standard requires compliance with ASTM F963 and, therefore, includes the same flux index methodology as this proposed rule. The decline in recalled toys that present a magnet ingestion hazard after the toy standard became mandatory suggests that the requirements in that rule were effective at reducing the risk of injury and death associated with magnet ingestions. The low number of magnet ingestion incidents that identify ASTM F963 magnet toys as the involved product also indicates that the requirements in the standard have been effective at reducing the magnet ingestion hazard. When magnet ingestions did occur with children's toys, they rarely resulted in the internal interaction hazard, and those that did result in internal interaction, did not comply with the toy standard.

For these reasons, the proposed rule uses the flux index methodology in

ASTM F963–17 as the means of measuring the strength of magnets for purposes of limiting the risk of internal interaction injuries when ingested.

There are two issues that the Commission seeks input on regarding the flux index methodology. The first issue involves how many magnets to test. The proposed rule and ASTM F963–17 do not explicitly state how many magnets from a product to test, or whether to use statistical sampling. The proposed rule requires at least one loose or separable magnet of each shape and size to be tested, and specifies that each loose or separable magnet in a subject magnet product that fits entirely within the small parts cylinder must have a flux index less than 50 kG² mm². Similarly, section 4.38.1 of ASTM F963–17 states that “toys shall not contain a loose as-received hazardous magnet or a loose as-received hazardous magnetic component.” These provisions indicate that each magnet may need to be tested to ensure that compliance with the size and strength provisions.

However, subject magnet products may consist of hundreds or thousands of individual magnets. As such, it may be reasonable to require that only a “representative sample” or “at least one representative sample of each shape and size” be tested. CPSC staff’s testing of magnets, described below, suggests that individual magnets within the same product may have different flux indexes, which may suggest that it is important to test each individual magnet in a product. CPSC seeks comments on how firms would test products to align with the proposed requirements, whether another requirement regarding the number of magnets to test is appropriate, and how firms would satisfy such alternative requirements.

The second issue for which the Commission seeks comments is the utility of the flux index methodology for certain magnets—in particular, small spherical magnets. Staff has found the flux index methodology straightforward and consistent when used for large disc magnets. However, staff encountered some challenges finding the location of the poles for magnets smaller than 3 mm in diameter because of difficulties handling these particularly small spherical magnets. This may result in inaccurate measurements of the highest flux index values if the value is not measured above the magnet’s pole. Staff testing of 2.5 mm spherical magnets, described below, illustrates this potential issue.

To examine possible ways to address this, staff refined the test procedure in ASTM F963–17 to include additional

detail to locate the magnet pole and secure the magnet on a base, rather than holding it. This test procedure maintained the flux index methodology in ASTM F963–17, and merely added information to it, which staff found improved the accuracy and consistency of flux density measurements and calculations. This refined procedure is provided in detail in the Appendix to Tab D of the NPR briefing package. To summarize, the refined test method consists of the following steps:

(1) Use a flat magnetic or ferromagnetic utensil to attract spherical magnets into alignment with pole orientation towards the utensil;

(2) Transfer the spherical magnets from the utensil to a flat surface covered in at least 2 mm depth of putty that is dense/thick enough to maintain the configuration of the spherical magnets in the proper pole orientation (established by magnetic attraction with the utensil); and

(3) With the spherical magnets aligned in the flat surface putty with pole orientation facing away from the test surface, use the gauss meter probe to determine the maximum flux value of each individual magnet.

The additional detail in this refined procedure is one option for potentially supplementing the flux index methodology in ASTM F963–17. However, there are other potential alternatives to the method in ASTM F963–17, such as considering attraction and repulsion forces. The Commission requests comments on the variability of flux index results, issues determining the flux index of smaller magnets, and potential refinements or alternatives to the proposed methodology for assessing the strength of magnets.

Flux Index Limit. The proposed rule limits the flux index of magnets small enough to be swallowed to less than 50 kG² mm². ASTM introduced this flux index limit in 2007, in ASTM F963–07.⁸⁸ ASTM set the flux index limit at 50 kG² mm² based on measurements of flux indexes in magnetic toys that were involved in magnet ingestion incidents at the time, which generally had flux index measurements over 70 kG² mm². Based on this information, 70 kG² mm² was determined to be an unsafe flux index measurement, and ASTM set the limit at 50 kG² mm² to provide a factor of safety.

As part of an ASTM standard, the flux index limit was developed by consensus of various groups, including consumer groups, children’s product engineers

⁸⁸ ASTM F963–2007 specified that prohibited hazardous magnets had a flux index greater than 50 kG² mm², however, this was revised in later versions of the standard, and ASTM F963–17 now prohibits hazardous magnets with a flux index of 50 kG² mm² or more.

and experts, and manufacturers of children’s products. Additional ASTM standards, as well as international standards that address magnet ingestions, including EN 71–1: 2014 and ISO 8124–1: 2018, also include a flux index limit of 50 kG² mm² for ingestible magnets. As such, the flux index limit of 50 kG² mm² is consistent with consensus standards developed with cooperation and input from various experts, is widely recognized, and has long been used as a way to reduce the internal interaction hazard when magnets are ingested.

Incident data support the effectiveness of this flux index limit to address the magnet ingestion hazard. Magnet ingestion incidents substantially declined during the years the magnet sets rule was announced and in effect, and substantially increased after the rule was vacated. The magnet sets rule included a flux index limit of 50 kG² mm² for ingestible magnets. The marked decline in magnet ingestions during that rule suggests that the performance requirements in that rule were effective at reducing the risk of injury and death associated with magnet ingestions. Similarly, there was a significant decline in recalls involving the magnet ingestion hazard after the toy standard became mandatory. The toy standard requires compliance with ASTM F963 and, therefore, includes the same 50 kG² mm² limit for ingestible magnets as the proposed rule. This decline in recalled toys for magnet ingestion hazards suggests that the requirements in that rule were effective at reducing the risk of injury and death associated with magnet ingestions. The low number of magnet ingestion incidents that identify ASTM F963 magnet toys as the involved product also indicate that the requirements in that standard have been effective at addressing the magnet ingestion hazard. Moreover, when magnet ingestions did occur with children’s toys, they rarely resulted in internal interaction, and those that did result in internal interaction, did not comply with the toy standard.

Staff’s assessment of the flux index of subject magnet products, including those involved in magnet ingestion incidents, and those known to have involved internal interaction injuries, indicates that subject magnet products have a wide range of flux indexes. The most common subject magnet products staff identified are 3 to 6 mm and have flux indexes of 300 to 400 kG² mm².

However, staff’s testing of smaller 2.5 mm magnets, some of which resulted in internal interaction injuries when ingested, yielded flux indexes close to 50 kG² mm². CPSC expects that, in order

to comply with the proposed rule, firms will use magnets with flux indexes sufficiently lower than 50 kG² mm² in subject magnet products, to account for manufacturing and testing variances/ tolerances, which may result in subject magnet products having flux indexes even lower than required by the rule.

Based on the widespread and longstanding use of the flux index limit of 50 kG² mm², its development and acceptance by multiple stakeholders, the effectiveness of standards that have used this limit to address magnet ingestion incidents, and staff testing showing that magnets involved in internal interaction incidents had flux indexes close to 50 kG² mm², the Commission proposes to require that magnets that are small enough to ingest have a flux index of less than 50 kG² mm².

However, the Commission seeks comments on this flux index limit, whether a lower limit may be appropriate, and seeks testing and safety data supporting an appropriate flux index limit. CPSC testing of a small sample of subject magnet products suggests that magnets with a flux index lower than (*i.e.*, weaker than) 50 kG² mm² may be capable of causing internal interaction injuries, indicating that a

flux index limit lower than 50 kG² mm² may be appropriate to address the internal interaction hazard; however, this testing did not provide conclusive evidence that magnets weaker than 50 kG² mm² present an internal interaction hazard. This testing is described below.

CPSC Testing. To gather information about the flux index methodology, flux index limit, and what flux index can interact internally through body tissue, staff conducted testing on a small number of magnets. Staff tested magnets with diameters smaller than 5 mm because they generally had lower flux indexes than larger magnets, and because these smaller magnets presented the testing challenges described above. Staff used the test method in ASTM F963–17 with the additions described in the Appendix to Tab D of the NPR briefing package. This testing involved only a small number of samples, and a limited variety of products, sizes, and shapes. As such, while this testing is informative and raises potential issues, the broader significance of these results is limited.

In March, April, and June 2021, CPSC staff tested magnets with diameters smaller than 5 mm, including 2.5 mm diameter spherical magnets from nine exemplar samples of one brand of

magnet set, and two incident samples of the same brand.⁸⁹ Additionally, staff tested 3 mm diameter spherical magnets from two incident samples from unknown manufacturers. Staff selected these samples because of their involvement in internal interaction incidents. CPSC is aware of 16 ingestion incidents and one nasal insertion incident involving the 2.5 mm diameter spherical magnets that staff tested.⁹⁰ These 17 incidents resulted in at least 10 surgeries (such as appendectomy and bowel resection) and six instances of internal interaction through body tissue. The nasal insertion incident involved two 2.5 mm diameter spherical magnets attracting through and perforating the victim’s nasal septum, which is tissue thicker than the GI walls.

In March 2021, staff conducted inter-rater reliability testing (*i.e.*, the extent to which 2 or more observations agree) in which 3 staff members tested the same 21 exemplar 2.5 mm diameter spherical magnets. Three magnets were tested from each of 7 sets/samples of the same magnet set brand. Staff chose 3 magnets from each set to analyze intra-set variability in magnetic flux index. Table 15 shows the results of this testing.

TABLE 15—INTER-RATER RELIABILITY TEST MEASUREMENTS OF 2.5 mm SPHERICAL MAGNETS [March 2021]

Test set	Magnet 1 (kG ² mm ²)			Magnet 2 (kG ² mm ²)			Magnet 3 (kG ² mm ²)		
	Tester 1	Tester 2	Tester 3	Tester 1	Tester 2	Tester 3	Tester 1	Tester 2	Tester 3
1	53.788	56.294	42.730	48.950	50.797	47.197	50.797	53.246	50.462
2	59.477	60.876	53.926	52.055	54.175	40.755	53.372	56.197	74.308
3	29.021	29.627	28.191	29.205	30.752	27.507	39.152	41.192	35.507
4	33.226	33.932	31.232	51.627	54.623	36.160	53.605	53.705	42.825
5	42.940	41.681	46.425	52.600	51.631	48.106	46.501	48.576	44.031
6	34.381	34.838	34.217	40.974	40.279	39.920	35.085	36.197	33.905
7	55.118	56.522	53.955	56.819	57.577	56.230	40.890	34.274	39.933

These results suggest several points of interest. For one, they indicate that there was some variation in flux index results across testers. In addition, these results suggest that magnets from the same set tend have more similar flux index measurements than magnets from different sets of the same product. The results also suggest that there is variation in the flux indexes of magnets from the same set, and the same products (across sets). The flux index measurements of 21 exemplar 2.5 mm diameter spherical magnets from 7

different magnet sets of the same brand ranged from 27.507 to 74.308 kG² mm². This variation in flux indexes, potentially due to manufacturing variation and testing variation, may necessitate that firms use magnets with flux indexes sufficiently lower than 50 kG² mm² in subject magnet products, to account for this potential variation in flux index results.

This variation also may have implications for the number of magnets in a product that should be tested to assess flux index. Under the proposed

rule, one loose or separable magnet with a flux index of 50 kG² mm² or more in a subject magnet product makes the whole product violative. However, this above testing suggests that this determination may be affected by the number or sample of magnets tested from a product because a product that includes multiple magnets may contain some magnets that meet and some that exceed the flux index limit. Thus, this testing may have implications for how many magnets from a product should be tested (*e.g.*, all magnets in the product,

⁸⁹ Exemplar refers to products that are the same model and brand as those involved in the incident, but not the actual product involved in the incident. Incident samples refer to the actual products involved in an incident.

⁹⁰ Many of these cases occurred after the NEISS and CPSRMS data extraction used for the NPR briefing package and, therefore, are not captured in those datasets.

a representative sample of magnets in the product).
 In addition, because this testing used exemplars, and not the magnets that were actually ingested, staff cannot determine what flux index measurements resulted in internal interaction injuries. However, these results suggest that magnets ranging from approximately 30 to 70 kG² mm² could have resulted in internal interaction injuries. If the actual magnets involved in the incident had flux indexes of 50 kG² mm² or more, the

proposed rule would address these injuries; if the actual magnets involved in the incident had flux indexes closer to 30 to 40 kG² mm², the proposed rule may not address these injuries.
 In March and April 2021, staff conducted similar testing. Three staff members tested spherical magnets from 4 separate sample/sets that were involved in internal interaction incidents. Set 1 included a single 2.5 mm diameter magnet that had not been ingested, but was from a set of ingested magnets that had interacted

internally through a victim's body tissue. The remaining 3 sets had magnets that were ingested and removed from the intestines of the victim who swallowed them (*i.e.*, interacted internally through victims' body tissue). Staff tested 3 magnets from each of these 3 sets; 2 of the 3 sets were composed of 3 mm diameter magnets and 1 set was composed of 2.5 mm diameter magnets. The results are provided in Table 16.

TABLE 16—TEST MEASUREMENTS OF 2.5 mm AND 3 mm SPHERICAL MAGNET SETS INVOLVED IN INGESTION INCIDENTS

Set	Magnet 1 (kG ² mm ²)			Magnet 2 (kG ² mm ²)			Magnet 3 (kG ² mm ²)		
	Tester 1	Tester 2	Tester 3	Tester 1	Tester 2	Tester 3	Tester 1	Tester 2	Tester 3
1	42.020	45.173	41.766	N/A	N/A	N/A	N/A	N/A	N/A
2	76.919	82.469	65.959	72.911	70.882	63.795	70.206	68.475	63.843
3	46.239	48.513	46.384	47.536	49.427	47.991	48.309	52.135	48.749
4	93.979	96.426	89.349	90.240	96.383	88.218	89.070	94.970	95.712

The results in Table 16 show similar trends as the testing above, with there being some variation across testers, less variation within sets than across sets, and a range of flux indexes across magnets, and sets. Set 1 in Table 16 was the same brand as the sets shown in Table 15, was a 2.5 mm spherical magnet, and had flux indexes that ranged from 41.766 to 45.173 kG² mm². Although this magnet was from a set that was ingested and interacted internally through body tissue, this exact magnet was not ingested, so staff cannot determine the flux index of the magnets that were ingested, but it is possible that the magnets that interacted through body tissue were also in this range, with flux indexes less than 50 kG² mm².

Sets 2 and 4 in Table 16 were 3 mm diameter spherical magnets from 2 sets from unknown manufacturers. The magnets staff tested for these sets were actually ingested and had interacted internally through a victim's body tissue. As such, the results for these sets are particularly useful for assessing the magnet strength that may attract internally through body tissue. These

magnets had flux indexes that ranged from 63.795 to 96.426 kG² mm². Thus, the limit of 50 kG² mm² in the proposed rule would address the magnet interaction hazard these magnets presented, with a factor of safety to account for potential variation in results across testers, manufacturing variation, and variation due to the challenges of testing small spherical magnets.

Set 3 in Table 16 included three 2.5 mm diameter spherical magnets from a magnet set of the same brand as those in Table 15. The tested magnets had been ingested and interacted internally through the victim's tissue. Thus, like sets 2 and 4, these results are particularly useful for assessing the magnet strength that may attract internally through body tissue. The flux indexes for these magnets ranged from 46.239 to 52.135 kG² mm². Using only Tester 1 or Tester 3's results, these magnets would comply with the proposed rule because these testers found flux indexes less than 50 kG² mm² for all 3 magnets. Using Tester 2's results, these magnets would not comply with the proposed rule because magnet 3 in the set had a flux index of

more than 50 kG² mm². Because, depending on the tester, this set may comply with the proposed rule but interacted internally through body tissue, these results raise the question whether a lower flux index limit may be appropriate. However, even with a flux index limit of 50 kG² mm², it is possible that the proposed rule would address the incident involving these magnets because the flux indexes for this set were very close to 50 kG² mm². To comply with the proposed rule, firms may build in a factor of safety to ensure their magnets are not close to 50 kG² mm², to account for variation in test results and testers and ensure their products will comply with the standard.

In June 2021, CPSC staff tested magnets from 2 more exemplar magnet sets of the same brand shown in Table 15, each of which consisted of spherical rare-earth magnets that were 2.5 mm in diameter. Magnet sets of this brand and type were known to have been involved in at least 6 internal interaction incidents. Staff measured the flux index of 3 magnets from each set and calculated the flux index values. The results are in Table 17.

TABLE 17—TEST MEASUREMENTS OF TWO 2.5 mm DIAMETER MAGNET SETS [June 2021]

Magnet	Sample magnet set 1					Sample magnet set 2				
	Max flux (kG)	Max flux ² (kG ²)	Diameter (mm)	Area (mm ²)	Flux index	Max flux (kG)	Max flux ² (kG ²)	Diameter (mm)	Area (mm ²)	Flux index
1	2.812	7.907	2.520	4.985	39.417	3.343	11.174	2.520	4.985	55.705
2	2.714	7.363	2.550	5.104	37.585	3.450	11.903	2.590	5.266	62.677
3	2.798	7.826	2.410	4.559	35.683	3.275	10.726	2.530	5.025	53.896

Again, these results indicate variation in the flux indexes of magnets within the same set, and that flux indexes are more similar within a set than across sets. For the 6 magnets tested, flux indexes ranged from 35.683 to 62.677 kG² mm².

The following provides a summary of the consolidated results of all of these tests. Staff assessed 2.5 mm and 3 mm diameter spherical magnets associated with internal interaction incidents. The exemplar 2.5 mm magnets had flux index values between 27.507 to 74.308 kG² mm². Incident samples with magnets involved in internal interaction injuries had flux index values between 46.239 and 52.135 kG² mm² for the 2.5 mm magnets, and 63.795 to 96.426 kG² mm² for the 3 mm diameter magnets. In general, these results suggest that the proposed rule would address the internal interaction hazard associated with magnet ingestions because many of the sets tested would not comply with the proposed rule because at least one of the tested magnets had a flux index of 50 kG² mm² or more. For the reasons described above, staff considers the flux index methodology and limit in the proposed rule to be appropriate to adequately address the magnet ingestion hazard.

However, these results also suggest that there is some variability in the flux index values, which may have implications for the proposed flux index test methodology. These results also indicate that magnets that may have flux indexes lower than 50 kG² mm² may have caused internal interaction injuries, suggesting that a lower flux index limit than 50 kG² mm² may be appropriate; however, the results are inconclusive because staff could not identify, with certainty, the flux indexes of magnets that actually caused internal interaction injuries. In addition, staff notes the limited scope of this testing, including the small sample size, and limited variety of products tested. The Commission seeks comments on the proposed requirements regarding flux index methodology and limits, including information about whether flux indexes below 50 kG² mm² present an internal interaction hazard.

VII. Preliminary Regulatory Analysis⁹¹

The Commission is proposing to issue a rule under sections 7 and 9 of the CPSA. The CPSA requires that the Commission prepare a preliminary regulatory analysis and publish it with the text of the proposed rule. 15 U.S.C.

⁹¹ Further detail regarding the preliminary regulatory analysis is available in Tab E of the NPR briefing package.

2058(c). The following discussion is extracted from staff's memorandum, "Preliminary Regulatory Analysis of a Draft Proposed Rule that Would Establish a Standard for Hazardous Magnet Products," available in Tab E of the NPR briefing package.

A. Preliminary Description of Potential Costs and Benefits of the Proposed Rule

The preliminary regulatory analysis must include a description of the potential benefits and costs of the proposed rule. The benefits of the rule are measured as the expected reduction in the societal costs of deaths and injuries that would result from adopting the proposed rule and any benefits that cannot be quantified. The costs of the rule consist of the added costs associated with modifying or discontinuing products that do not comply with the requirements of the rule, including any impacts on the utility of the products for consumers, as well as any costs that cannot be quantified.

1. Deaths and Injuries Related to Magnet Ingestions

As discussed above, based on NEISS data, which is a nationally representative probability sample of about 100 U.S. hospitals, there were an estimated 4,400 ED-treated magnet ingestions between 2010 and 2020 that involved subject magnet products, and an additional estimated 18,100 ED-treated magnet ingestions that involved unidentified magnet products, of which CPSC concludes a large portion involved subject magnet products.

In addition to injuries initially treated in hospital EDs, many product-related injuries are treated in other medical settings, such as, physicians' offices, clinics, and ambulatory surgery centers. Some injuries also result in direct hospital admissions, bypassing hospital EDs entirely. CPSC estimates the number of subject magnet product injuries treated outside of hospital EDs with CPSC's Injury Cost Model (ICM), which uses empirical relationships between the characteristics of injuries (diagnosis and body part) and victims (age and sex) initially treated in hospital EDs and the characteristics of those initially treated in other settings.⁹²

⁹² A detailed discussion of the ICM and these methods is in: Miller, T.R., Lawrence, B.A., Jensen, A.F., Waehrer, G.M., Spicer, R.S., Lestina, D.C., and Cohen, M.A., *The Consumer Product Safety Commission's Revised Injury Cost Model*, Calverton, MD: Public Services Research Institute (2000); Bhattacharya, S., Lawrence, B., Miller, T., Zaloshnja, E., Jones, P., *Ratios for Computing Medical Treated Injury Incidence and Its Standard Error from NEISS Data* (Contract CPSC-D-05-0006, Task Order 8), Calverton, MD: Pacific Institute for

The ICM estimate of injuries treated outside of hospitals or hospital EDs (e.g., in doctors' offices, clinics) is based on data from the Medical Expenditure Panel Survey (MEPS). The MEPS is a nationally representative survey of the civilian, non-institutionalized population that quantifies individuals' use of health services and corresponding medical expenditures. It combines data from a panel of participants interviewed quarterly over a two-year period with data from the respondents' medical providers. The MEPS is administered by the Agency for Healthcare Research and Quality (AHRQ). The ICM uses the MEPS data, in combination with a classification tree analysis technique, to project the number and characteristics of injuries treated outside of hospitals. To project the number of direct hospital admissions that bypass hospital EDs, the ICM uses data from the Nationwide Inpatient Sample of the Healthcare Cost and Utilization Project (HCUP-NIS), which was also analyzed using a classification tree analysis technique. HCUP is a family of healthcare databases and related software tools and products developed through a federal-state-industry partnership and sponsored by AHRQ. The HCUP-NIS provides information annually on approximately 3 to 4 million in-patient stays from about 1,000 hospitals.

The classification tree analysis technique (also called decision tree) is a statistical tool that divides and sorts data into smaller and smaller groups for estimating the ED share of injuries until no further gains in predictive power can be obtained. This technique allows for more precise estimates of injuries treated in doctor visits or injuries admitted directly to the hospital than other regression techniques. For example, where data permit, the age and sex of the victim can have an influence on the estimates of the number of injuries treated outside the ED. Combining the national estimates of NEISS with the non-ED estimates from the ICM using classification tree techniques provides total estimated medically-treated injuries.

Based on the estimate of 2,135 magnet injuries initially treated in hospital EDs annually during 2017 through 2020, the ICM projects that another 856 magnet injuries were treated annually outside of hospitals (e.g., in doctors' offices,

Research and Evaluation (2012); and Lawrence, B.A., *Revised Incidence Estimates for Nonfatal, Non-Hospitalized Consumer Product Injuries Treated Outside Emergency Departments* (Contract CPSC-D-89-09-0003, Task Order 2), Calverton, MD: Pacific Institute for Research and Evaluation (2013).

clinics) and that there were about 264 direct hospital admissions annually, bypassing the ED. Thus, combined with the ED-treated injuries, staff estimates that there were a total of 3,255 medically treated injuries annually involving subject magnets products from 2017 through 2020.

2. Societal Costs of Deaths and Injuries

The ICM is fully integrated with NEISS and provides estimates of the societal costs of injuries reported through NEISS, as well as the societal costs of other medically treated injuries estimated by the ICM. The major aggregated societal cost components provided by the ICM include medical costs, work losses, and the intangible costs associated with lost quality of life or pain and suffering.

Medical costs include three categories of expenditures: (1) Medical and hospital costs associated with treating the injury victim during the initial recovery period and in the long term, including the costs associated with corrective surgery, the treatment of chronic injuries, and rehabilitation services; (2) ancillary costs, such as costs for prescriptions, medical

equipment, and ambulance transport; and (3) costs of health insurance claims processing. CPSC derived the cost estimates for these expenditure categories from a number of national and state databases, including MEPS, HCUP–NIS, the Nationwide Emergency Department Sample (NEDS), the National Nursing Home Survey (NNHS), MarketScan® claims data, and a variety of other federal, state, and private databases.

Work loss estimates are intended to include: (1) The forgone earnings of the victim, including lost wage work and household work; (2) the forgone earnings of parents and visitors, including lost wage work and household work; (3) imputed long term work losses of the victim that would be associated with permanent impairment; and (4) employer productivity losses, such as the costs incurred when employers spend time juggling schedules or training replacement workers. Estimates are based on information from HCUP–NIS, NEDS, Detailed Claims Information (a workers’ compensation database), the National Health Interview Survey, U.S. Bureau of Labor Statistics, and other sources. The

intangible, or non-economic, costs of injury reflect the physical and emotional trauma of injury, as well as the mental anguish of victims and caregivers. Intangible costs are difficult to quantify because they do not represent products or resources traded in the marketplace. Nevertheless, they typically represent the largest component of injury cost and need to be accounted for in any benefit-cost analysis involving health outcomes. The ICM develops a monetary estimate of these intangible costs from jury awards for pain and suffering. While these awards can vary widely on a case-by-case basis, studies have shown them to be systematically related to a number of factors, including economic losses, the type and severity of injury, and the age of the victim.⁹³ CPSC derived estimates for the ICM from regression analysis of jury awards in nonfatal product liability cases involving consumer products compiled by Jury Verdicts Research, Inc.

Table 18 provides annual estimates of the injuries and societal costs associated with ingestions of magnets categorized as magnet sets, magnet toys, and jewelry.

TABLE 18—ESTIMATED AVERAGE ANNUAL MEDICALLY TREATED INJURIES AND ASSOCIATED SOCIETAL COSTS FOR INGESTIONS OF PRODUCTS CATEGORIZED AS MAGNET SETS, MAGNET TOYS, AND JEWELRY, FOR 2017 THROUGH 2020

Injury disposition	Estimated No.	Estimated societal costs (\$ millions) *
Doctor/Clinic	164	\$2.2
Treated and Released from Hospital ED	278	6.2
Admitted to Hospital through ED (NEISS)	† 159	26.4
Direct Hospital Admissions, Bypassing	77	12.8
Total Medically Attended Injuries	678	47.6

* In 2018 dollars.

† This estimate may not be reliable because of the small number of cases on which it is based.

The 2017 through 2020 NEISS estimates suggest an estimated annual average of about 437 ED-treated injuries, comprised of 278 injuries that were treated and released and 159 injuries that required hospitalization. Additionally, based on estimates from the ICM, 164 injuries were treated outside of hospitals annually and another 77 injuries resulted in direct hospital admission.

Based on ICM estimates, these injuries resulted in annual societal costs of about \$47.6 million (in 2018 dollars) during 2017 through 2020. The average estimated societal cost per injury was

about \$13,000 for injuries treated in physician’s offices, clinics, and other non-hospital settings; about \$22,000 for injuries to victims who were treated and released from EDs; and about \$166,000 for injuries that required admission to the hospital for treatment. Medical costs and work losses (including work losses of caregivers) accounted for about 44 percent of these injury cost estimates, and the less tangible costs of injury associated with pain and suffering accounted for about 56 percent of the estimated injury costs.

Table 18 reflects magnet ingestion incidents that involved products

categorized as magnet sets, magnet toys, and jewelry—it does not include incidents categorized as involving unidentified product types. However, as discussed in section IV.A.5.

Uncertainties in Incident Data, above, most of the incidents in this unidentified product type category likely involved subject magnet products. Thus, in addition to the magnet ingestion incidents upon which Table 15 was based, there were 322 NEISS cases during 2017 through 2020 (representing about 1,873 ED-treated injuries annually) in the unidentified product type category. Based on ICM

⁹³ W. Kip Viscusi (1988), *The determinants of the disposition of product liability cases: Systematic compensation or capricious awards?*, International Review of Law and Economics, 8, 203–220; Gregory

B. Rodgers (1993), *Estimating jury compensation for pain and suffering in product liability cases involving nonfatal personal injury*, Journal of Forensic Economics 6(3), 251–262; and Mark A.

Cohen and Ted R. Miller (2003), *“Willingness to award” nonmonetary damages and implied value of life from jury awards*, International Journal of Law and Economics, 23, 165–184.

estimates for unidentified product types involved in magnet ingestion injuries, average annual societal costs for 2017–2020 totaled \$151.8 million. Consequently, to the extent that the unidentified magnet products were products that would be covered by the proposed rule, Table 18 could substantially understate the societal costs associated with the ingestion of subject magnet products.

3. Potential Benefits of Proposed Rule

The benefits of the proposed rule would be the reduction in the risk of

injury and death from magnet ingestions and the resulting value of the societal costs of the injuries that the rule would prevent. In addition to the injuries reflected in the analysis above, staff is aware of 5 fatalities in the United States resulting from magnet ingestions. Thus, the rule would reduce the likelihood of future fatalities as well as injuries.

The annual expected benefits of the rule depend on the exposure to risk associated with subject magnet products, as well as the estimated societal costs described in Table 18,

above. Although subject magnet products may retain their magnetism for many years, it is likely that some are discarded well before that time. Thus, the actual expected product life of subject magnet products is uncertain; this analysis presents a range of potential benefit estimates under an assumed product life of 1.5, 2, and 3 years. Table 19 presents benefit estimates under the alternative product life assumptions (line (b)).

TABLE 19—PRESENT VALUE OF SOCIETAL COSTS PER SUBJECT MAGNET PRODUCT IN USE (OR GROSS BENEFITS OF A RULE), FOR THREE EXPECTED PRODUCT LIVES FROM 2017 THROUGH 2020.

(a) Aggregate Annual Societal Costs (millions \$)	\$47.6	\$47.6	\$47.6
(b) Expected Useful Product Life (years)	1.5	2	3
(c) Magnet Products in Use, Average Annual	444,000	545,000	701,000
(d) Annual Societal Costs per Subject Magnet Product [(a) ÷ (c)]	\$107	\$87	\$68
(e) Present Value of Societal Costs, per Subject Magnet Product (3% Discount Rate)	\$160	\$171	\$190
(f) Present Value of Societal Costs, per Subject Magnet Product (7% Discount Rate)	\$154	\$162	\$178

In Table 19, line (a) shows the average annual aggregate societal costs from Table 18. Line (c) presents the average annual estimated number of subject magnet products in use from 2017 through 2020, based on producer-reported annual magnet set sales⁹⁴ collected by the Directorate for Compliance through mid-2012 and assumptions of annual sales of all

subject magnet products through 2020 (including an assumption of 500,000 units per year for 2018–2020), an assumed expected product life of 1.5, 2, and 3 years (line b), and the application of the CPSC’s Product Population Model, a computer algorithm that projects the number of products in use given estimates of annual product sales and product failure rates. The

Commission requests information on annual sales and expected product life of subject magnet products.

Figure 7 shows changes in the estimated number of subject magnet products in use, from 2009 through 2020.

BILLING CODE 6355-01-P

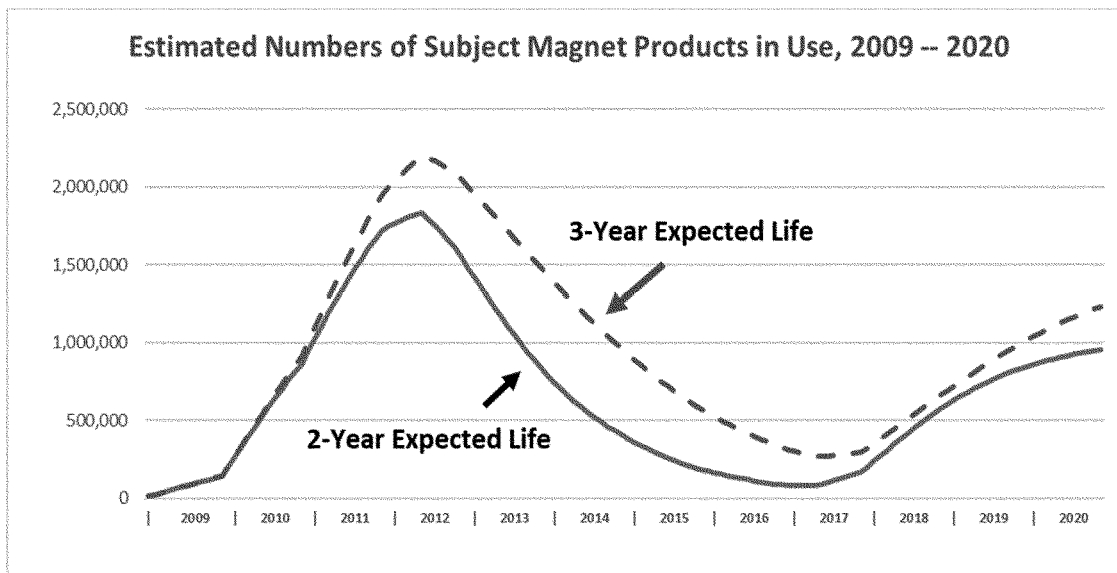

Figure 7: Estimated Numbers of Subject Magnet Products in Use, 2009-2020.

⁹⁴ Although this information is for magnet sets, and not all subject magnet products, staff primarily

had information about magnet sets, and magnet sets

likely make up a large portion of subject magnet products.

In Table 19, the annual estimated societal costs per subject magnet product in use (line d) are presented as the quotient of the annual societal costs (line a), per product in use, and the estimated average number of products in use (line c). Based on these estimates, and an assumed average product life ranging from 1.5 to 3 years, the present value of societal costs, per subject magnet product, ranges from about \$160 to about \$190 using a 3 percent discount rate (line e), or from about \$154 to \$178 using a 7 percent discount rate (line f).

The first order estimate of benefits would be equal to the present value of societal costs, presented in lines (e) and (f) and would range from about \$154 (with a 1.5-year product life and a 7 percent discount rate) to \$190 (with a 3-year product life and a 3 percent discount rate) per subject magnet product. The aggregate benefits would range from \$80 million to \$95 million using the 500,000 units assumption from Table 19 and 3 percent discount rate.⁹⁵ If the proposed rule allows some products to remain on the market that present the magnet ingestion hazard, the benefits of the rule would be reduced by some unknown amount and would be measured as the net reduction in injuries and the concomitant reduction in societal costs that would result.

4. Costs Associated With the Proposed Rule

This section discusses the costs associated with the proposed rule, which include costs to consumers and to manufacturers/importers of subject magnet products. Both consumers and producers benefit from the production

⁹⁵ Aggregate benefits are the product of the per-unit benefit (\$160 and \$190 for a 1.5-year and 3-year useful life discounted at 3 percent), and 500,000 estimated annual units.

and sale of consumer products. The consuming public obtains the use value or utility associated with the consumption of products; producers obtain income and profits from the production and sale of products. Consequently, the costs of requiring that subject magnet products comply with the proposed rule would consist of: (1) The lost use value experienced by consumers who would no longer be able to purchase magnets that do not meet the standard (lost consumer surplus); and (2) the lost income and profits to firms that could not produce and sell non-complying products (lost producer surplus).

Both consumer and producer surplus depend on product sales, among other things. However, CPSC does not know the unit sales of subject magnet products. Therefore, this analysis considers possible costs associated with several estimates of sales, ranging from about 250,000 to 1 million subject magnet products per year. For purposes of discussion, the analysis below assumes annual sales of 500,000 per year.

a. Costs to Consumers

The primary cost associated with the proposed rule is lost utility to consumers. Subject magnet products may be used for a variety of purposes, including amusement and jewelry. Previous comments CPSC has received regarding magnet sets, which likely comprise the majority of subject magnet products on the market, indicate that consumers use them as a manipulative or construction item for entertainment, such as puzzle working, sculpture building, mental stimulation, or stress relief. CPSC is also aware of claims that the magnets can have beneficial therapeutic value for children with

attention-deficit/hyperactivity disorder. Incident data also suggests that magnet sets are used as jewelry. The individual magnets in subject magnet products might also have additional uses, apart from those for which they are intended (e.g., using magnets from a magnet set on a refrigerator). However, there would presumably be little lost utility for these unintended product uses since products intended for those purposes (e.g., refrigerator magnets) would be unaffected by the proposed rule. If products that comply with the proposed rule do not serve the identical utility (e.g., consumers prefer smaller, stronger magnets), this represents lost utility to consumers. CPSC notes that the proposed rule applies to amusement and jewelry products and, therefore, would not affect products intended for research, education, industrial, or commercial uses, if they do not otherwise meet the definition of subject magnet products.

CPSC cannot estimate the use value that consumers receive from subject magnet products, so the following discussion instead describes use value conceptually. In general, use value includes the amount of: (1) Consumer expenditures for the product, plus (2) consumer surplus. Assuming annual sales of about 500,000 subject magnet products annually, and assuming an average retail price of about \$20 (based on price data for magnet sets), consumer expenditures would amount to about \$10 million annually. These expenditures represent the minimum value that consumers would expect to get from these products. It is represented by the area of the rectangle OBDE in the standard supply and demand graph in Figure 8, where B equals \$20, and E equals 500,000 units.

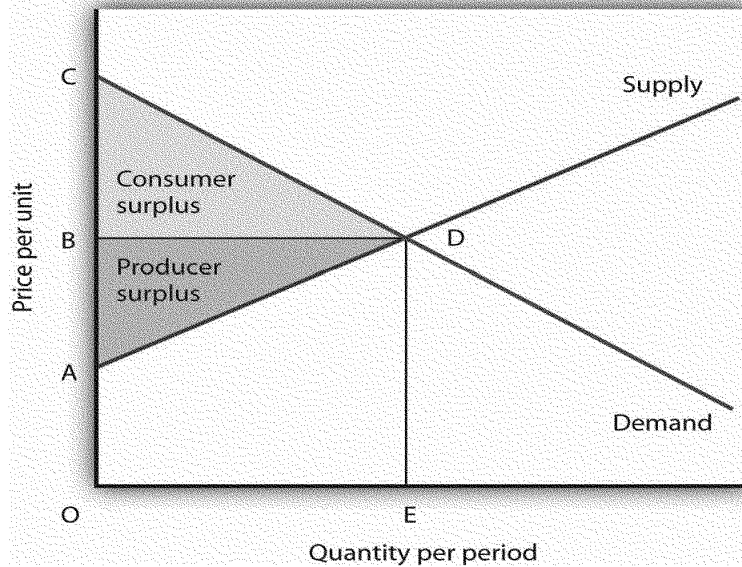

Figure 8: Supply and demand graph illustrating the concepts of consumer and producer surplus.

BILLING CODE 6355-01-C

In Figure 8, consumer surplus is given by the area of the triangle BCD under the graph's demand function, and represents the difference between the market-clearing price and the maximum amount consumers would have been willing to pay for the product. This consumer surplus will vary for individual consumers, but it represents a benefit to consumers over and above what they paid.⁹⁶ For example, tickets to a concert might sell for \$100 each, but some consumers who buy them for \$100 would have been willing to pay \$150 per ticket. Those consumers paid \$100 and received benefits that they value at \$150, thereby receiving a consumer surplus of \$50.⁹⁷

In general, the use value of the subject magnet products obtained by consumers is represented by the area of the trapezoid OCDE in Figure 8. However, the prospective loss in use value associated with the proposed rule would amount to, at most, the area of the triangle representing the consumer surplus. This is because consumers

would no longer be able to obtain utility from the products that do not comply with the proposed rule, but they would have the \$10 million (represented by the rectangle OBDE) that they would have spent on non-complying subject magnet products in the absence of a rule. The net loss in consumer surplus associated with the proposed rule would be reduced by consumers' ability to purchase replacement products that comply with the proposed rule and provide the same utility, or by their ability to purchase other products that provide use-value.

CPSC does not have information regarding aggregate consumer surplus or, by extension, the amount of utility that would be lost as a result of the proposed rule. However, if, for example, consumers who purchased subject magnet products that do not comply with the proposed rule at an average price of \$20 would have been willing to spend, on average, \$35 to \$45 per product (*i.e.*, an additional \$15 to \$25 per product), the lost utility might amount to about \$7.5 million (*i.e.*, [$\$35 - \20] \times 500,000 units annually) to \$12.5 million (*i.e.*, [$\$45 - \20] \times 500,000 units annually) on an annual basis.

However, the loss in consumer surplus described above represents the maximum loss of consumer utility from the proposed rule because consumers are likely to gain some amount of consumer surplus from products that are purchased as an alternative to subject magnet products that would no longer be available because of the rule. If, for example, there were close substitutes (*e.g.*, products that are

similarly satisfying and priced) for the subject magnet products that do not meet the standard, the overall loss in consumer surplus (and, hence, the costs of the proposed rule) likely would be small. Staff is aware of subject magnet products that comply with the proposed rule. For example, there are magnet sets with flux indexes less than 50 kG² mm², magnetic desk sculptures that use a magnetic base and ferromagnetic pieces, sets of large magnetic balls, and a wide variety of fidget toys. Manufacturers of magnetic jewelry with loose or separable magnets have options for complying with the rule, including using magnets that are not hazardous, or close substitutes that are nonmagnetic. If jewelry manufacturers wish to offer separable pieces on necklaces or bracelets, they might offer nonmagnetic pieces that attach to a bracelet or necklace incorporating attached magnets. Additionally, magnetic stud earrings and faux piercing jewelry have clip-on alternatives and pierced jewelry as substitutes. These products and alternatives suggest that compliant products may provide similar utility to non-compliant subject magnet products.

b. Costs to Manufacturers/Importers

The lost benefits to firms that could result from the proposed rule are measured by a loss in producer surplus. Producer surplus is a profit measure that is somewhat analogous to consumer surplus. Whereas consumer surplus is a measure of benefits received by individuals who consume products, net of the cost of purchasing the products, producer surplus is a measure of the

⁹⁶ The concept of consumer surplus is discussed in the Office of Management and Budget's Circular A-4, *Regulatory Analysis*, available through 68 FR 58366 (Oct. 9, 2003), and has been applied in a number of CPSC staff analyses.

⁹⁷ If the above graph represents the market for tickets, the demand curve describes the quantity of tickets demanded at each price (*i.e.*, the quantity of tickets consumers are willing and able to purchase at each price). In this example, the \$150 that the consumer would have been willing to pay for the ticket is represented on the demand curve at a point to the left of point D. The consumer surplus is given by the relevant point on the demand curve (*i.e.*, where price = \$150), minus the market clearing price of \$100.

benefits accrued to firms that produce and sell products, net of the costs of producing them. Producer surplus is defined as the total revenue (TR) of firms selling subject magnet products, less the total variable costs (TVC) of production. Variable costs are costs that vary with the level of output and usually include expenditures for raw materials, wages, distribution of the product, and similar costs.

In Figure 8, above, total revenue is given by the area OBDE, which is the product of sales and price. The total variable costs of production are given by the area under the supply function, OADE. Consequently, producer surplus is given by the triangle ABD, which is the area under the market clearing price and above the supply function. Note that this represents the maximum loss to producers; if there were product alternatives that were similar to subject magnet products that suppliers could produce and sell, the lost producer surplus could be less.

Following the example above, if sales of the subject magnet products average about 500,000 units annually, with an average retail price of about \$20 per product, then total industry revenues have averaged about \$10 million annually (*i.e.*, 500,000 units × \$20 per product). Information provided by

magnet set sellers suggests that the average import cost of magnet sets to U.S. importers, a major variable cost, may amount to about \$10 per set, or an average of about \$5 million annually (*i.e.*, 500,000 sets × \$10 import cost per set). Apart from the import costs, the variable costs of production are probably relatively small. Because subject magnet products are often packaged and shipped from China and sometimes sent directly to the importers point of sale, U.S. labor costs may be low; and because subject magnet products are small, storage costs are probably low. If, for example, the variable costs of production account for about half of the difference between total revenues (\$10 million) and import costs (\$5 million), producer surplus would amount to about \$2.5 million (*i.e.*, (\$10 million – \$5 million) ÷ 2) annually. At most, the lost producer surplus would amount to about \$5 million annually, if there were no variable costs other than the costs of importing the magnets (*i.e.*, total revenue of \$10 million for 500,000 units annually less the import costs of about \$5 million). While this information is specifically related to magnet sets, a similar relationship could apply to other subject magnet products.

Like costs to consumers, lost producer surplus could be offset by products that comply with the proposed rule. That is, although firms could not offer subject magnet products that do not comply with the proposed rule, they could offer substitutions that serve the same or similar purpose but comply with the proposed rule.

As noted above, CPSC does not know the actual sales levels of non-complying subject magnet products, and does not have information to reliably estimate either consumer surplus or producer surplus. Table 20, below, provides rough estimates of the possible costs of the rule, for various hypothetical sales levels ranging from 250,000 to 1 million products annually. The cost estimates are based on a number of assumptions described above, and are made for illustrative purposes. Nevertheless, because the range of sales is wide, and is likely to include actual sales levels on an annual basis, it is reasonable to assume that the costs of the proposed rule could range from about \$5 to \$8.75 million (if sales amount to about 250,000 products annually), to about \$20 to \$35 million (if sales amount to about 1 million products annually). As noted above, these costs could be partially offset by products that comply with the proposed rule.

TABLE 20—POSSIBLE COSTS OF THE PROPOSED RULE, FOR VARIOUS LEVELS OF NON-COMPLYING SUBJECT MAGNET PRODUCT SALES

Magnet product sales (annually)	Consumer surplus (millions \$)	Producer surplus (millions \$)	Total costs (millions \$)
250,000	\$3.75 to \$6.25	\$1.25 to \$2.5	\$5 to \$8.75.
500,000	\$7.5 to \$12.5	\$2.5 to \$5	\$10 to \$17.5.
750,000	\$11.25 to \$18.75	\$3.75 to \$7.5	\$15 to \$26.25.
1,000,000	\$15 to \$25	\$5 to \$10	\$20 to \$35.

In addition to lost producer surplus, manufacturers/importers of subject magnet products that comply with the proposed rule would likely incur some additional costs associated with certifying that their products comply with the rule. Section XII. Testing, Certification, and Notice of Requirements, below, describes the requirements in section 14 of the CPSA regarding certifications. To summarize, consumer products that are subject to a mandatory standard must be certified as complying with the standard.

Certification must be based on a test of each product or a reasonable testing program. For subject magnet products, the costs of this testing may be minimal, especially for manufacturers that currently have product testing done for products subject to the requirements in ASTM F963–17, which is mandated in

16 CFR part 1250. Importers may rely upon testing completed by other parties, such as their foreign suppliers, if those tests provide sufficient information for the manufacturers or importers to certify that the magnets in their products comply with the proposed rule. For subject magnet products that are children’s products, such as children’s jewelry, the certification must be based on testing by an accredited third-party conformity assessment body, at somewhat higher costs.

B. Reasons for Not Relying on a Voluntary Standard

When the Commission issues an ANPR, it must invite interested parties to submit existing standards or provide a statement of intention to modify or develop a standard that would address the hazard at issue. 15 U.S.C. 2058(a).

When CPSC receives such standards or statements in response to an ANPR, the preliminary regulatory analysis must provide reasons that the proposed rule does not include such standards. *Id.* 2058(c). In the present rulemaking, the Commission did not issue an ANPR. Accordingly, CPSC did not receive submissions of standards or statement of intention to develop standards regarding the magnet ingestion hazard.

Nevertheless, staff evaluated existing standards relevant to magnet ingestions and determined that these standards would not adequately reduce the risk of injury associated with magnet ingestions because they do not cover the products most often involved in incidents or do not include adequate performance requirements to reduce the risk of injury. A detailed discussion of these standards, and why staff considers

them inadequate, is in section V. Relevant Existing Standards.

C. Alternatives to the Proposed Rule

Finally, a preliminary regulatory analysis must describe alternatives to the proposed rule that CPSC considered, their potential costs and benefits, and a brief explanation of the reasons the alternatives were not chosen. CPSC considered several alternatives to the proposed rule. These alternatives, their potential costs and benefits, and the reasons the Commission did not select them, are described in detail in section VIII. Alternatives to the Proposed Rule, below, and Tab F of the NPR briefing package.

VIII. Alternatives to the Proposed Rule

CPSC considered several alternatives to reduce the risk of injuries and death associated with ingestion of subject magnet products. However, as discussed below, CPSC does not consider any of these alternatives capable of adequately reducing the risk of injury and death.

A. No Mandatory Standard

One alternative to the proposed rule is to take no regulatory action and, instead, rely on the ASTM standards to address the magnet ingestion hazard. As discussed above, there are four ASTM standards that address the magnet ingestion hazard, covering children's toys, jewelry, and magnet sets. Relying on these standards would eliminate the costs associated with the proposed rule because it would not mandate compliance. ASTM F3458, in particular, has the potential to address the magnet ingestion hazard because it applies to magnet sets, which are involved in a large portion of magnet ingestion incidents where the product type could be identified.

However, there are considerable limitations and unknowns associated with this alternative. The shortcomings of the ASTM standards are discussed in detail in section V. Relevant Existing Standards. For one, CPSC does not consider ASTM F3458 capable of adequately reducing the magnet ingestion hazard because of its limited scope and lack of size and strength requirements for magnets. Although Subcommittee F15.77 on Magnets formed a task group to consider revising ASTM F3458–21 to include performance requirements for magnet sets intended for users 14 years and older, CPSC does not know whether the standard will be revised or what requirements may be added to it.

Moreover, ASTM F3458 applies only to magnet sets, which are not the only products implicated in magnet ingestion

incidents. Additional magnet toys intended for users 14 years and older, as well as jewelry are also implicated. Although ASTM has standards regarding the magnet ingestion hazard in jewelry, CPSC considers those standards inadequate because they do not impose size and strength limits on all jewelry with loose or separable magnets. In addition, CPSC does not know the level of compliance with ASTM F3458, ASTM F2999, or ASTM F2923; if the rate of compliance is low, these would not be an effective way to address the hazard, even if the requirements in these standards were adequate. Finally, waiting for ASTM to revise its standards to adequately address the hazard would delay the safety benefits of the proposed rule. For these reasons, the Commission did not select this alternative.

B. Alternative Performance Requirements

Another alternative to the proposed rule is to adopt a mandatory standard with less stringent requirements than the proposed rule, such as a higher flux index limit, or different requirements for certain shapes and sizes of magnets. This may reduce the costs associated with the rule by allowing firms to market and consumers to use a wider variety of products than under the proposed rule. The reduction in costs would depend on the specific requirements adopted.

However, this option would likely reduce the safety benefits of the rule. If the alternative performance requirements reduced costs by allowing more products to remain on the market, it likely would also leave more hazardous products on the market, thereby decreasing the safety benefits. Therefore, the Commission did not select this alternative. The Commission seeks comments on what potential alternative performance requirements may adequately reduce the risk of injury associated with magnet ingestions, while reducing costs to firms and impacts on consumer utility.

C. Safety Messaging

Instead of performance requirements, the Commission could require safety messaging on products to address the magnet ingestion hazard, such as through requirements for labeling and instructional literature. This alternative would reduce the costs associated with the proposed rule because it would allow firms to continue to sell subject magnet products with loose or separable hazardous magnets and the costs of warnings and instructional information likely would be small.

However, CPSC does not consider this alternative effective for adequately reducing the risk of injury and death associated with magnet ingestions. For a detailed discussion of why labeling and instructional literature requirements are insufficient to adequately address the magnet ingestion hazard, see section V.D. *ASTM F3458–21*. To summarize, warnings are the least effective strategy for addressing a hazard, relative to designing out the hazard or designing guards against the hazard. The effectiveness of warnings depends on convincing consumers to avoid the hazard, and there are numerous reasons consumers may disregard warnings for these products. Caregivers do not expect older children and teens to ingest inedible objects; the magnet ingestion hazard is not readily apparent; caregivers and children underestimate the likelihood and severity of the hazard; magnets are often ingested accidentally; and children and teens commonly access magnets without their packaging, such as from friends or at school.

Warning information on labels and instructional literature, as well as public outreach efforts to inform consumers of the hazard, have been used to try to address the magnet ingestion hazard for many years. However, these efforts have been unsuccessful at reducing the magnet ingestion hazard, as evidenced by the increase in magnet ingestion incidents in recent years, and magnet ingestion incidents involving products with clear warnings.

For these reasons, the Commission did not select this alternative.

D. Packaging Requirements

Another alternative is for the Commission to require special packaging for subject magnet products that contain hazardous magnets to limit children's access to the products. Such packaging could, for example, help consumers determine if all magnets have been returned to the packaging and include child-resistant features. Although this alternative would create some costs associated with packaging, those costs likely would be lower than the proposed rule because they would allow subject magnet products to remain unchanged. Staff estimates that the cost of safety packaging may amount to about \$1 per magnet product, depending on the requirements and features of the packaging.

However, CPSC does not consider this alternative effective for adequately reducing the risk of injury and death associated with magnet ingestions. For a detailed discussion of why packaging requirements are insufficient to

adequately address the magnet ingestion hazard, see section *V.D. ASTM F3458–21*. To summarize, for packaging requirements to be effective at preventing the magnet ingestion hazard, users would have to repackage all magnets after each use, and the packaging would have to prevent children and teens from accessing the magnets. Neither of these are likely to occur to a sufficient extent to address the hazard.

For one, consumers are unlikely to repackage all magnets after each use. After assembling structures or jewelry, or using the magnets for other purposes, consumers would be unlikely to disassemble their creations to return them to the package. In addition, products often contain hundreds or thousands of magnets, making it time consuming and difficult to ensure all of the magnets are returned to the package. Moreover, small magnets become loose in the environment and are hard to locate to return to the package. In addition, consumers often do not perceive subject magnet products as hazardous, making it less likely that they would repackage all of the magnets. Even for products that are obviously hazardous and commonly use CR packaging, such as chemicals and pharmaceuticals, consumers use the packaging inconsistently. Consumers may also consider CR packaging a nuisance, making them unlikely to store magnets in the packaging after every use.

Even if consumers return all magnets to a package after each use, safety features to prevent easy access to the contents of the package would only address a minority of the vulnerable population. Safety packaging is generally intended to restrict children under 5 years old from accessing package contents. Older children and teens are likely to have the cognitive and motor skills necessary to access products in special packaging. This is problematic because incident data show that older children and teens make up the majority of magnet ingestion victims. In addition, many incidents involve children and teens acquiring magnets without the product packaging, such as from friends, at school, or loose in the environment. For these reasons, the Commission did not select this alternative.

E. Aversive Agents

Instead of the size and strength requirements in the proposed rule, the Commission could require manufacturers to coat loose or separable hazardous magnets in subject magnet products with aversive agents, such foul

odors or bitterants. Aversive agents may dissuade some children and teens from placing hazardous magnets in their mouths. This alternative would reduce the costs associated with the proposed rule because it would allow firms to continue to sell subject magnet products with loose or separable hazardous magnets, would allow consumers to continue to use them, and the costs of such coatings likely would be small.

However, real-world investigations have not demonstrated that bitterants are effective at preventing ingestions.⁹⁸ Bitterants do not deter initial ingestion because the user has not yet tasted the bitterant; this makes them ineffective at protecting users from harms that can result from a single ingestion. Incident reports indicate that ingesting a single magnet (and ferromagnetic object), or multiple magnets at once or in quick succession, can result in serious injuries. Thus, the ineffectiveness of bitterants to prevent an initial ingestion makes them ineffective for addressing the magnet ingestion hazard.

Similarly, once a magnet is in a person's mouth, they may not be able to prevent ingestion even if deterred by a bitterant. The power of the magnetic forces can cause magnets to move erratically as pieces repel or attract, and movement of magnets toward the back of the throat can trigger the reflex to swallow the magnets before the person can remove them. Bitterants would be particularly ineffective for accidental ingestions, where victims did not intentionally place magnets in their mouths; incident data indicate that some magnet ingestions involve unintentional ingestions, particularly for older victims. Moreover, incidents involving ingestion of other hazardous substances demonstrates the ineffectiveness of aversive agents to prevent ingestions. Children frequently ingest unpalatable substances, such as gasoline, cleaners, and ammonia, indicating that unpleasant taste or odor, alone, is not sufficient to deter children from ingesting items or substances. In addition, some portion of the population, possibly as high as 30 percent, may be insensitive to certain bitterants.

For these reasons, the Commission did not select this alternative.

F. Longer Effective Date

Another alternative is to provide a longer effective date for a final rule. In this proposed rule, the Commission

⁹⁸ This alternative is discussed in detail in the Final Rule briefing package for the 2014 rule on magnet sets, available at: https://www.cpsc.gov/s3fs-public/pdfs/foia_SafetyStandardforMagnetSets-FinalRule.pdf.

proposes to make a final rule effective 30 days after the final rule is published. A longer effective date would reduce the impact of the rule on manufacturers and importers by extending the time firms have to develop products that comply with the rule or modify products to comply with the rule. However, delaying the effective date would delay the safety benefits of the rule as well. As such, the Commission did not select this alternative. However, the Commission requests comments about the proposed effective date.

IX. Paperwork Reduction Act

This proposed rule does not contain a collection of information that is subject to public comment and review by the Office of Management and Budget under the Paperwork Reduction Act of 1995 (44 U.S.C. 3501–3521).⁹⁹

X. Initial Regulatory Flexibility Analysis¹⁰⁰

When an agency is required to publish a proposed rule, section 603 of the Regulatory Flexibility Act (5 U.S.C. 601–612) requires that the agency prepare an initial regulatory flexibility analysis (IRFA) that describes the impact that the rule would have on small businesses and other entities. An IRFA is not required if the head of an agency certifies that the proposed rule will not have a significant economic impact on a substantial number of small entities. 5 U.S.C. 605. The IRFA must contain:

- (1) A description of why action by the agency is being considered;
- (2) a succinct statement of the objectives of, and legal basis for, the proposed rule;
- (3) a description of and, where feasible, an estimate of the number of small entities to which the proposed rule will apply;
- (4) a description of the projected reporting, recordkeeping and other compliance requirements of the proposed rule, including an estimate of the classes of small entities that will be subject to the requirement and the type of professional skills necessary for preparation of the report or record; and
- (5) identification, to the extent practicable, of relevant Federal rules that may duplicate, overlap, or conflict with the proposed rule.

An IRFA must also describe any significant alternatives that would accomplish the objectives of the applicable statutes and minimize any significant economic impact on small

⁹⁹ There is an Office of Management and Budget control number, under the Paperwork Reduction Act, for collection of information regarding third-party testing for children's products, addressed in 16 CFR part 1107.

¹⁰⁰ Further details about the initial regulatory flexibility analysis are available in Tab F of the NPR briefing package. Additional information about costs associated with the rule are available in Tab E of the NPR briefing package.

entities. Alternatives could include: (1) Establishing different compliance or reporting requirements that consider the resources available to small businesses; (2) clarification, consolidation, or simplification of compliance and reporting requirements for small entities; (3) use of performance rather than design standards; and (4) an exemption from coverage of the rule, or any part of the rule thereof, for small entities.

The IRFA for this proposed rule is available in Tab F of the NPR briefing package; this section provides an overview of the impact of the proposed rule on small businesses.

A. Reason for Agency Action

The intent of this rulemaking is to reduce deaths and injuries resulting from magnet ingestions. As incident data show, magnet ingestion incidents have increased in recent years, and commonly involve products categorized as amusement or jewelry products. Most incidents involve children and teens, particularly under 14 years old. If ingested, some magnets are powerful enough to interact internally with one another through body tissue, and resist natural bodily forces to separate the magnets. This interaction has led to serious injuries and several deaths in the United States. The internal interaction hazard is a hidden hazard, which children and caregivers are unlikely to anticipate, appreciate, and avoid, as demonstrated by incident data. Incident data and the health outcomes of magnet ingestions demonstrate the need for agency action.

B. Objectives of and Legal Basis for the Rule

The objective of the proposed rule is to reduce the risk of injury and death associated with ingestion of hazardous magnets, as discussed above. The proposed rule would be issued under the authority of sections 7 and 9 of the CPSA.

C. Small Entities to Which the Rule Will Apply

The proposed rule would apply to small entities that manufacture, import, or sell subject magnet products, which are products with one or more magnets, which are loose or separable, and designed, marketed, or intended to be used by consumers for entertainment, jewelry (including children's jewelry), mental stimulation, stress relief, or a combination of these purposes. Examples of subject magnet products include magnet sets, other types of magnet toys intended for users 14 years and older, and jewelry with separable

magnets that can be arranged by the consumer.

Because CPSC's previous rulemaking work regarding magnet ingestions has focused on magnet sets, CPSC staff has more detailed information about magnet sets than other subject magnet products. For this reason, this analysis provides detailed information about magnet sets; however, staff also provides information about additional subject magnet products, to the extent information about these products is available.

All of the importers of magnet sets are small businesses under U.S. Small Business Administration (SBA) size standards, and CPSC expects that this is also true for manufacturers and importers of other subject magnet products. Currently, nearly all marketers (firms or individuals) of magnet sets sell through internet sites, rather than through physical retail stores such as bookstores, gift shops and other outlets (which commonly sold magnet sets from 2009 through mid-2012). Some of these internet sites are operated by the importers, but the majority of sellers (in terms of distinct firms or individuals, if not unit sales) appear to sell through their stores, operated on the sites of other internet platforms. These online retail outlets may also be used commonly by manufacturers and sellers of other subject magnet products.

As discussed above, in late 2018, IEC examined the market for magnet sets. In its review of internet platforms, IEC found a total of 69 sellers. IEC also identified 10 manufacturers and 2 retailers, which also are small businesses.¹⁰¹ CPSC staff provided IEC with staff's prior research, which identified at least 121 sellers of magnet sets on two major internet retail platforms. IEC reviewed these sellers with the intention of merging CPSC's research with newer information but found that the vast majority of sellers CPSC identified no longer sold magnet sets, indicating high turnover rates.

In 2020, CPSC staff reviewed the status of previously identified sellers of magnet sets on two major internet platforms and found further evidence of high turnover rates: Most of the sellers identified in late 2018 no longer sold magnet sets or had abandoned their stores. Only 9 of 69 sellers were still selling magnet sets. The remaining sellers no longer offered magnet sets or no longer operated on the platforms. In addition, staff identified 29 sellers that

IEC had not identified as active in the market in late 2018.

Based on this information, CPSC staff expects the dominant business model for importers of magnet sets will be direct sales to consumers using their own internet websites or other internet shopping sites. However, the proposed rule could also affect some third-party retailers of the products, whether selling them online or in physical stores. Such retailers sell a wide variety of consumer products; retailers classified as small businesses that sell the products would not be likely to derive significant proportions of total revenues from sales of affected magnet sets, and the impacts on individual firms should be minimal.

D. Compliance, Reporting, and Recordkeeping Requirements in the Proposed Rule

The proposed rule would establish a mandatory standard that all subject magnet products would have to meet to be sold in the United States. As stated above, the proposed rule would require consumer products that are designed, marketed, or intended to be used for entertainment, jewelry, mental stimulation, stress relief, or a combination of these purposes, and that contain one or more loose or separable magnets to meet performance requirements. The proposed performance requirements specify that each loose or separable magnet in a subject magnet product that is small enough to fit entirely in the small parts cylinder must have a flux index less than 50 kG² mm². The requirements of the proposed standard are described, in detail, in this preamble, and the proposed regulatory text is at the end of this notice.

In addition, certification requirements, which are discussed in section XII. Testing, Certification, and Notification of Requirements, below, would apply to subject magnet products. To summarize, section 14 of the CPSA requires manufacturers, importers, or private labelers of a consumer product that is subject to a consumer product safety rule to certify, based on a test of each product or a reasonable testing program, that the product complies with all rules, bans or standards applicable to the product. The proposed rule specifies the test procedure to use to determine whether a subject magnet product complies with the requirements. For products that manufacturers certify, manufacturers would issue a general certificate of conformity (GCC). In the case of subject magnet products that could be considered children's products, the certification must be based on testing by

¹⁰¹ IEC classified manufacturers as firms producing and selling their own magnet set products, and retailers as firms that typically sell magnets from multiple manufacturers.

an accredited third-party conformity assessment body.

The requirements for the GCC are stated in section 14 of the CPSA. Among other requirements, each certificate must identify the manufacturer or private labeler issuing the certificate and any third-party conformity assessment body on whose testing the certificate relies; the date and place of manufacture; the date and place where the product was tested; each party's name, full mailing address, telephone number; and contact information for the individual responsible for maintaining records of test results. The certificates must be furnished to each distributor or retailer of the product and to CPSC, if requested.

1. Costs of the Proposed Rule That Would Be Incurred by Small Manufacturers

Small manufacturers and importers of subject magnet products would likely incur some costs to certify that their products meet the requirements of the proposed rule, as required by section 14 of the CPSA. The certification must be based on a test of each product or a reasonable testing program. The costs of the testing might be minimal, especially for small manufacturers that currently have product testing done for products subject to the requirements in ASTM F963–17, which is mandated by 16 CFR part 1250. Importers may also rely on testing completed by other parties, such as their foreign suppliers, if those tests provide sufficient information for the manufacturers or importers to certify that the magnets in their products comply with the proposed rule. As noted above, for subject magnet products that could be considered children's products, such as children's jewelry, the certification must be based on testing by an accredited third-party conformity assessment body, at somewhat higher costs. The Commission requests comments regarding the costs or other impacts of the certification requirements under section 14 of the CPSA.

2. Impact on Small Businesses

As discussed in the preliminary regulatory analysis, the primary impact of the proposed rule on small businesses would be the lost income and profits to firms that could not produce, import, and sell non-complying products in the future. The lost benefits to firms resulting from a proposed rule are measured by a loss in producer surplus, which is a measure of the total revenue of firms selling the magnets, less the total variable costs of production. As predominantly imported products, the

variable costs for small businesses handling subject magnet products are mainly the import costs. The producer surplus for magnet sets could average about \$5 to \$10 per unit, based on an average price of \$20. A similar relationship could apply to other subject magnet products affected by the proposed rule.

A few small firms whose businesses focus on sales of subject magnet products that would not comply with the proposed rule, including some of the firms selling products on their own websites, would face relatively greater losses in producer surplus. These and other small businesses could respond to the rule by marketing magnets that comply with or are not subject to the proposed rule. Such measures could offset losses in producer surplus.

E. Federal Rules That May Duplicate, Overlap, or Conflict With the Proposed Rule

CPSC did not identify any federal rules that duplicate, overlap, or conflict with the proposed rule.

F. Alternatives Considered To Reduce the Burden on Small Entities

As discussed in section VIII. Alternatives to the Proposed Rule, above, CPSC examined several alternatives to the proposed rule, which could reduce the burden on firms, including small entities. For the reasons described in that section, the Commission concluded that those alternatives would not adequately reduce the risk of injury and death associated with magnet ingestions, and is not proposing those alternatives. See Tab F of the NPR briefing package for further discussion of alternatives to the proposed rule. The Commission seeks comments on any alternatives that would reduce the impact on small entities, while adequately reducing the risk of injury and death associated magnet ingestions.

XI. Incorporation by Reference

The proposed rule incorporates by reference ASTM F963–17. The Office of the Federal Register (OFR) has regulations regarding incorporation by reference. 1 CFR part 51. Under these regulations, in the preamble of an NPR, an agency must summarize the incorporated material, and discuss the ways in which the material is reasonably available to interested parties or how the agency worked to make the materials reasonably available. 1 CFR 51.5(a). In accordance with the OFR requirements, this preamble summarizes the provisions of ASTM

F963–17 that the Commission proposes to incorporate by reference.

The standard is reasonably available to interested parties and interested parties can purchase a copy of ASTM F963–17 from ASTM International, 100 Barr Harbor Drive, P.O. Box C700, West Conshohocken, PA 19428–2959 USA; telephone: (610) 832–9585; www.astm.org. Additionally, during the NPR comment period, a read-only copy of ASTM F963–17 is available for viewing on ASTM's website at: <https://www.astm.org/CPSC.htm>. Once a final rule takes effect, a read-only copy of the standard will be available for viewing on the ASTM website at: <https://www.astm.org/READINGLIBRARY/>. Interested parties can also schedule an appointment to inspect a copy of the standard at CPSC's Division of the Secretariat, U.S. Consumer Product Safety Commission, 4330 East-West Highway, Bethesda, MD 20814, telephone: (301) 504–7479; email: cpsc-os@cpsc.gov.

XII. Testing, Certification, and Notice of Requirements

Section 14(a) of the CPSA includes requirements for certifying that children's products and non-children's products comply with applicable mandatory standards. 15 U.S.C. 2063(a). Section 14(a)(1) addresses required certifications for non-children's products, and sections 14(a)(2) and (a)(3) address certification requirements specific to children's products.

A "children's product" is a consumer product that is "designed or intended primarily for children 12 years of age or younger." *Id.* 2052(a)(2). The following factors are relevant when determining whether a product is a children's product:

- Manufacturer statements about the intended use of the product, including a label on the product if such statement is reasonable;
- whether the product is represented in its packaging, display, promotion, or advertising as appropriate for use by children 12 years of age or younger;
- whether the product is commonly recognized by consumers as being intended for use by a child 12 years of age or younger; and
- the Age Determination Guidelines issued by CPSC staff in September 2002, and any successor to such guidelines. *Id.* "For use" by children 12 years and younger generally means that children will interact physically with the product based on reasonably foreseeable use. 16 CFR 1200.2(a)(2). Children's products may be decorated or embellished with a childish theme, be sized for children, or

be marketed to appeal primarily to children. *Id.* 1200.2(d)(1).

As discussed above, some subject magnet products (e.g., children's jewelry) are children's products and some are not. Therefore, a final rule would require subject magnet products that are not children's products to meet the certification requirements under section 14(a)(1) of the CPSA and would require subject magnet products that are children's products to meet the certification requirements under sections 14(a)(2) and (a)(3) of the CPSA. The Commission's requirements for certificates of compliance are codified in 16 CFR part 1110.

Non-Children's Products. Section 14(a)(1) of the CPSA requires every manufacturer (which includes importers¹⁰²) of a non-children's product that is subject to a consumer product safety rule under the CPSA or a similar rule, ban, standard, or regulation under any other law enforced by the Commission to certify that the product complies with all applicable CPSC requirements. 15 U.S.C. 2063(a)(1).

Children's Products. Section 14(a)(2) of the CPSA requires the manufacturer or private labeler of a children's product that is subject to a children's product safety rule to certify that, based on testing by a third-party conformity assessment body (i.e., testing laboratory), the product complies with the applicable children's product safety rule. *Id.* 2063(a)(2). Section 14(a) also requires the Commission to publish a notice of requirements (NOR) for a testing laboratory to obtain accreditation to assess conformity with a children's product safety rule. *Id.* 2063(a)(3)(A). Because some subject magnet products are children's products, the proposed rule is a children's product safety rule, as applied to those products. Accordingly, if the Commission issues a final rule, it must also issue an NOR.

The Commission published a final rule, codified at 16 CFR part 1112, entitled *Requirements Pertaining to Third Party Conformity Assessment Bodies*, which established requirements and criteria concerning testing laboratories. 78 FR 15836 (Mar. 12, 2013). Part 1112 includes procedures for CPSC to accept a testing laboratory's accreditation and lists the children's product safety rules for which CPSC has published NORs. When CPSC issues a new NOR, it must amend part 1112 to include that NOR. Accordingly, as part of this NPR, the Commission proposes

to amend part 1112 to add this proposed standard for magnets to the list of children's product safety rules for which CPSC has issued an NOR.

Testing laboratories that apply for CPSC acceptance to test subject magnet products that are children's products for compliance with the new rule would have to meet the requirements in part 1112. When a laboratory meets the requirements of a CPSC-accepted third party conformity assessment body, the laboratory can apply to CPSC to include 16 CFR part 1262, *Safety Standard for Magnets*, in the laboratory's scope of accreditation of CPSC safety rules listed on the CPSC website at: www.cpsc.gov/labsearch.

XIII. Environmental Considerations

The Commission's regulations address whether CPSC is required to prepare an environmental assessment (EA) or an environmental impact statement (EIS). 16 CFR 1021.5. Those regulations list CPSC actions that "normally have little or no potential for affecting the human environment," and, therefore, fall within a "categorical exclusion" under the National Environmental Policy Act (42 U.S.C. 4231–4370h) and the regulations implementing it (40 CFR parts 1500–1508) and do not require an EA or EIS. 16 CFR 1021.5(c). Among those actions are rules that provide performance standards for products. *Id.* 1021.5(c)(1). Because this proposed rule would create performance requirements for subject magnet products, the proposed rule falls within the categorical exclusion, and thus, no EA or EIS is required.

XIV. Preemption

Executive Order (E.O.) 12988, *Civil Justice Reform* (Feb. 5, 1996), directs agencies to specify the preemptive effect of a rule in the regulation. 61 FR 4729 (Feb. 7, 1996), section 3(b)(2)(A). In accordance with E.O. 12988, CPSC states the preemptive effect of the proposed rule, as follows:

The regulation for subject magnet products is proposed under authority of the CPSA. 15 U.S.C. 2051–2089. Section 26 of the CPSA provides that "whenever a consumer product safety standard under this Act is in effect and applies to a risk of injury associated with a consumer product, no State or political subdivision of a State shall have any authority either to establish or to continue in effect any provision of a safety standard or regulation which prescribes any requirements as to the performance, composition, contents, design, finish, construction, packaging or labeling of such product which are designed to deal with the same risk of

injury associated with such consumer product, unless such requirements are identical to the requirements of the Federal Standard." 15 U.S.C. 2075(a). The federal government, or a state or local government, may establish or continue in effect a non-identical requirement for its own use that is designed to protect against the same risk of injury as the CPSC standard if the federal, state, or local requirement provides a higher degree of protection than the CPSA requirement. *Id.* 2075(b). In addition, states or political subdivisions of a state may apply for an exemption from preemption regarding a consumer product safety standard, and the Commission may issue a rule granting the exemption if it finds that the state or local standard: (1) Provides a significantly higher degree of protection from the risk of injury or illness than the CPSA standard, and (2) does not unduly burden interstate commerce. *Id.* 2075(c).

Thus, the requirements proposed in today's **Federal Register** would, if finalized, preempt non-identical state or local requirements for subject magnet products designed to protect against the same risk of injury and prescribing requirements regarding the performance, composition, contents, design, finish, construction, packaging or labeling of subject magnet products.

XV. Effective Date

The CPSA requires that consumer product safety rules take effect at least 30 days after the date the rule is promulgated, but not later than 180 days after the date the rule is promulgated unless the Commission finds, for good cause shown, that an earlier or later effective date is in the public interest and, in the case of a later effective date, publishes the reasons for that finding. 15 U.S.C. 2058(g)(1). The Commission proposes that this rule, and the amendment to part 1112, become effective 30 days after publication of the final rule in the **Federal Register**. The rule would apply to all subject magnet products manufactured or imported on or after the effective date. The Commission requests comments on the proposed effective date.

XVI. Proposed Findings

As discussed in section II. Statutory Authority, above, the CPSA requires the Commission to make certain findings when issuing a consumer product safety standard. 15 U.S.C. 2058(f)(1), (f)(3). This section discusses preliminary support for those findings.

¹⁰² The CPSA defines a "manufacturer" as "any person who manufactures or imports a consumer product." 15 U.S.C. 2052(a)(11).

A. Degree and Nature of the Risk of Injury

To issue a final rule, the CPSA requires the Commission to make findings regarding the degree and nature of the risk of injury the rule is designed to eliminate or reduce. NEISS incident data indicate that there were an estimated 4,400 magnet ingestions treated in U.S. hospital EDs between January 1, 2010 and December 31, 2020 that involved products categorized as being for amusement or jewelry, which are the products subject to this rule. An additional estimated 18,100 ED-treated magnet ingestions during this period involved unidentified magnet products. CPSC concludes that a large portion of these unidentified magnet product incidents likely involved subject magnet products, for the reasons stated below.

In addition to magnet ingestion injuries treated in U.S. hospital EDs, the ICM projects that there were an estimated 3,255 magnet ingestion injuries per year treated in medical settings other than EDs from 2017 through 2020. Incident reports available through CPSRMS indicate that there were at least 284 magnet ingestions between January 1, 2010 and December 31, 2020, 75 percent of which involved products categorized as being for amusement or jewelry, which are the products subject to this rule, and an additional 15 percent involved unidentified magnet products, which CPSC concludes are likely to have involved subject magnet products for the reasons stated below.

The potential injuries when a person ingests one or more magnets are serious. Health threats posed by magnet ingestion include pressure necrosis, volvulus, bowel obstruction, bleeding, fistulae, ischemia, inflammation, perforation, peritonitis, sepsis, ileus, ulceration, aspiration, and death, among others. These conditions can result from magnets attracting to each other through internal body tissue, or a single magnet attracting to a ferromagnetic object. CPSC is aware of several fatal magnet ingestion incidents resulting from internal interaction of the magnets.

As indicated above, CPSC concludes that many of the magnet ingestion incidents for which information was insufficient to identify the specific product type involved subject magnet products. This conclusion is supported by incident data, trends in magnet ingestion rates and recalls surrounding mandatory standards, and behavioral and developmental considerations. Incident data indicate that, of the magnet ingestion incidents for which CPSC could identify a product type, the

primary products involved were magnet sets, magnet toys, and jewelry; this is likely to apply to incidents that lacked product identification information as well.

Trends in magnet ingestion rates surrounding a previous Commission rule on magnet sets indicate that magnet ingestions significantly declined during the time the rule was in effect, and significantly increased after the rule was vacated. This indicates that a large portion of magnet ingestions involved magnet sets, which are subject magnet products. Similarly, incident data and recalls surrounding the Commission's mandatory standard for magnets in children's toys, in 16 CFR part 1250, indicate that, while amusement products are involved in most magnet ingestion incidents with identifiable product types, those amusement products are not children's toys. Relatively few magnet ingestion incidents identify children's toys as the product involved, suggesting that these make up few of the unidentified product type incidents as well. And the number of recalls of children's products for magnet-related hazards has appreciably declined since 16 CFR part 1250 took effect, suggesting that these products do not make up a large portion of magnet ingestion incidents.

Finally, behavioral and developmental factors support the conclusion that many magnet ingestions with unidentified product types involve subject magnet products. These include the attractiveness of magnetic products and their features to children and teens, consumers' perception that amusement and jewelry products are appropriate and safe for children, and consumers' underappreciation of the magnet ingestion hazard.

B. Number of Consumer Products Subject to the Proposed Rule

To issue a final rule, the CPSA requires the Commission to make findings regarding the approximate number of consumer products subject to the rule. Staff estimates that there are approximately 500,000 subject magnet products sold annually in the United States. However, to account for a range of sales estimates, staff also provided information for sales ranging from 250,000 to 1 million units annually.

C. The Public Need for Subject Magnet Products and the Effects of the Proposed Rule on Their Utility, Cost, and Availability

To issue a final rule, the CPSA requires the Commission to make findings regarding the public's need for the products subject to the rule and the

probable effect of the rule on the cost, availability, and utility of such products. Consumers use subject magnet products for entertainment, mental stimulation, stress relief, and jewelry. The proposed rule requires subject magnet products to meet performance requirements regarding size or strength, but does not restrict the design of products. As such, subject magnet products that meet the standard would continue to serve the purpose of amusement or jewelry for consumers. Magnets that comply with the proposed rule, such as non-separable magnets, larger magnets, weaker magnets, or non-permanent magnets, would likely still be useful for amusement or jewelry. However, it is possible that there may be some negative effect on the utility of subject magnet products if compliant products function differently or do not include certain desired characteristics.

Retail prices of subject magnet products generally average under \$20. CPSC has identified subject magnet products that comply with the proposed rule, indicating that the costs of compliant and non-compliant products are comparable.

If the costs associated with redesigning or modifying subject magnet products to comply with the proposed rule result in manufacturers discontinuing products, there may be some loss in availability to consumers. However, this would be mitigated to the extent that compliant products meet the same consumer needs.

D. Other Means To Achieve the Objective of the Proposed Rule, While Minimizing Adverse Effects on Competition and Manufacturing

To issue a final rule, the CPSA requires the Commission to make findings regarding ways to achieve the objective of the rule while minimizing adverse effects on competition, manufacturing, and commercial practices. CPSC considered several alternatives to achieve the objective of reducing unreasonable risks of injury and death associated with magnet ingestions.

One alternative is to take no regulatory action and instead rely on existing ASTM standards to address the magnet ingestion hazard. This would eliminate costs associated with the rule by avoiding a mandatory standard; however, this alternative is unlikely to adequately reduce the risk of injury and death associated with magnet ingestions. For one, none of the existing standards address all of the products most commonly identified in magnet ingestion incidents, and several of the standards provide exceptions to

performance requirements for certain subject magnet products. In addition, under the existing standards, certain subject magnet products would not be subject to performance requirements regarding size and strength, instead relying on alternative requirements, such as safety messaging, which is unlikely to adequately reduce the magnet ingestion hazard.

Another alternative is a mandatory standard with less stringent requirements than the proposed rule, such as a higher flux index limit, or different requirements for certain shapes and sizes of magnets. This could reduce the costs associated with a rule by allowing firms to market a wider variety of products than under the proposed rule. However, for this alternative to reduce costs, it would allow more products to remain on the market, thereby decreasing the safety benefits.

Safety messaging requirements are another alternative to the proposed rule. This would reduce the costs associated with the rule because it would not require modifying or discontinuing subject magnet products, and the costs of warnings and instructional information likely would be small. However, this alternative is not likely to adequately reduce the risk of injury and death associated with magnet ingestions because the effectiveness of safety messaging depends on consumers seeing the messaging and being convinced to avoid the hazard. Incident data indicate that children commonly access ingested magnets from sources that are unlikely to include the product packaging bearing instructions or warnings. Moreover, consumers are unlikely to consistently heed warnings because of the perception that subject magnet products are appropriate for children, and underappreciation of the magnet ingestion hazard. Safety messaging is generally considered the least effective way to address product hazards, and has been ineffective at addressing the magnet ingestion hazard, to date.

Another alternative is to require special packaging to limit children's access to subject magnet products. Such packaging could help consumers determine if all magnets have been returned to the container and include child-resistant features. Although this alternative would create some packaging costs, those likely would be lower than the costs associated with the proposed rule because it would allow subject magnet products to remain unchanged. However, this alternative is not likely to adequately reduce the risk of injury and death associated with magnet ingestions. For packaging requirements

to be effective, users would have to repackage all magnets after each use, which is unlikely given the size and number of magnets in a product, the potential to lose magnets, and consumers' demonstrated underappreciation of the hazard. In addition, packaging is unlikely to be effective because it generally only restricts young children (under 5 years old) from accessing package contents, and would not prevent older children or teens from accessing the package contents, although the majority of magnet ingestion incidents involved children 5 years and older.

Another alternative is to require subject magnet products to be coated with aversive agents. This alternative would reduce the costs associated with the rule because it would allow firms to continue to sell subject magnet products and the costs of such coatings likely would be small. However, such requirements are not likely to adequately reduce the risk of injury and death associated with magnet ingestions because they do not address ingestions that occur when the first magnet is placed in the victim's mouth, before the aversive agent is detected, accidental ingestions, or children who are developmentally inclined to place objects in their mouths.

Another alternative is to provide a longer effective date for the final rule. This may reduce the costs associated with the rule by spreading them over a longer period, but it would also delay the safety benefits of the rule.

E. Unreasonable Risk

To issue a final rule, the CPSA requires the Commission to find that the rule, including the effective date, is reasonably necessary to eliminate or reduce an unreasonable risk of injury associated with the product. Factors the Commission considered with respect to this preliminary finding include the likelihood and severity of the risk, and the potential costs and benefits associated with the proposed rule.

As described above, there were an estimated 23,700 magnet ingestions treated in U.S. hospital EDs from January 1, 2010 to December 31, 2020. Although this includes ingestions of all magnet types, and is not limited to subject magnet products, it provides an indication of the frequency with which children and teens ingest magnets, and the need to address the magnet ingestion hazard. Of these estimated 23,700 ED-treated magnet ingestions, an estimated 4,400 involved products categorized as being used for amusement or jewelry, which are the products subject to this rule, and an

additional estimated 18,100 involved unidentified magnet product types. As discussed with respect to the finding regarding the degree and nature of the risk of injury, a large portion of the incidents involving unidentified magnet products likely involve subject magnet products. In addition, the ICM projects that there were an additional estimated 3,255 magnet ingestion injuries per year treated in medical settings other than EDs from 2017 through 2020. Trend analysis indicates that magnet ingestions have significantly increased in recent years.

The potential injuries when a person ingests one or more magnets are serious. Health threats posed by magnet ingestion include pressure necrosis, volvulus, bowel obstruction, bleeding, fistulae, ischemia, inflammation, perforation, peritonitis, sepsis, ileus, ulceration, aspiration, and death, among others. These conditions can result from magnets attracting to each other through internal body tissue, or a single magnet attracting to a ferromagnetic object. One indication of the potential severity of magnet ingestions is hospitalization rates. Considering NEISS data, approximately 18 percent of estimated ED-treated magnet ingestions result in hospitalization. Of the 284 CPSRMS magnet ingestion cases, approximately twice as many resulted in hospitalization as other non-hospitalization treatment (187 hospitalizations, 94 other treatments). For subject magnet products, in particular, hospitalization was two to three times as common as other treatments. Specifically, for magnet set ingestions, 88 resulted in hospitalization and 46 resulted in other treatment; for magnet toys, 36 resulted in hospitalization and 13 resulted in other treatment; and for jewelry, 21 resulted in hospitalization, and 10 resulted in other treatment.

Another clear indication of the severity of health risks are fatal incidents. Staff identified five fatal magnet ingestion incidents that occurred in the United States between November 24, 2005 and January 5, 2021.¹⁰³ All of these incidents involved victims who died from injuries resulting from internal interaction of the magnets. Four of the five incidents involved children 2 years old or younger (the additional death involved an adult). At least one of these fatal incidents involved a magnet set, one involved an

¹⁰³ CPSC is also aware of two deaths in other countries, which involved ingestion of hazardous magnets. Although staff does not know the specific products involved in these incidents, the magnets were similar, if not identical to magnets typically found in magnet sets.

amusement product, and two fatal incidents provided product descriptions consistent with subject magnet products.

CPSC staff estimates that the rule could result in aggregate benefits of about \$80 million to \$95 million annually; this estimate excludes magnet ingestion incidents involving unidentified magnet products, which are likely to commonly involve subject magnet products, making the benefits of the rule substantially greater. CPSC staff estimates that the costs to consumers and manufacturers associated with the rule could range from \$10 million to \$17.5 million annually, assuming annual sales of 500,000 units.

For these reasons, the Commission concludes preliminarily that ingestion of subject magnet products poses an unreasonable risk of injury and finds that the proposed rule is reasonably necessary to reduce that unreasonable risk of injury.

F. Public Interest

To issue a final rule, the CPSC requires the Commission to find that issuing the rule is in the public interest. This proposed rule is intended to address an unreasonable risk of injury and death posed by magnet ingestions. The Commission believes that compliance with the requirements of the proposed rule will significantly reduce magnet ingestion deaths and injuries in the future; thus, the rule is in the public interest.

G. Voluntary Standards

To issue a final rule, the CPSC requires the Commission to find that, if a voluntary standard addressing the risk of injury has been adopted and implemented, that either compliance with the voluntary standard is not likely to result in the elimination or adequate reduction of the risk or injury, or there is unlikely to be substantial compliance with the voluntary standard.

The Commission is aware of six voluntary and international standards that address the magnet ingestion hazard: ASTM F963–17, *Standard Consumer Safety Specification for Toy Safety*; ASTM F2923–20, *Standard Specification for Consumer Product Safety for Children's Jewelry*; ASTM F2999–19, *Standard Consumer Safety Specification for Adult Jewelry*; ASTM F3458–21, *Standard Specification for Marketing, Packaging, and Labeling Adult Magnet Sets Containing Small, Loose, Powerful Magnets (with a Flux Index $\geq 50 \text{ kG}^2 \text{ mm}^2$)*; EN–71–1: 2014, *Safety of Toys; Part 1: Mechanical and Physical Properties*; and ISO 8124–1: 2018, *Safety of Toys—Part 1: Safety*

Aspects Related to Mechanical and Physical Properties. The Commission does not consider the standards likely to result in an adequate reduction of the risk of injury associated with magnet ingestions because of the scope of products each standard covers, and the types of requirements included in them.

None of these standards apply to all of the products most commonly identified in magnet ingestion incidents—magnet sets intended for users 14 years and older, magnet toys intended for users 14 years and older, and jewelry. Moreover, even for the products the standards do address, several standards provide exceptions for certain amusement and jewelry products, imposing only warning requirements for those products.

In addition, several of the standards do not impose performance requirements on magnets themselves, such as size and strength requirements, instead recommending or requiring safety messaging or packaging. CPSC does not consider safety messaging or packaging requirements sufficient, without additional performance requirements, to adequately reduce the risk of injury and death associated with magnet ingestions. Incident data indicate that children commonly access ingested magnets from sources that do not include packaging or safety messaging; children and caregivers have commonly disregarded safety messaging to date; safety packaging only limits young children from accessing its contents, which does not address the majority of magnet ingestions, which involve older children and teens; and safety packaging requires users to repackaging all magnets after every use to be effective, which is unlikely given the large number and small size of magnets often in subject magnet products.

H. Relationship of Benefits to Costs

On a per unit basis (as shown in Table 19), CPSC estimates the expected benefits per unit to range from \$160 (assuming a 1.5-year product life and a 3 percent discount rate) to \$190 (assuming a 3-year product life and a 3 percent discount rate). The estimated expected cost to manufacturers per unit is between about \$5 and \$10, and there is an unquantifiable cost to consumers associated with lost utility and availability.

CPSC estimates the aggregate benefits of the rule to be \$80 million to \$95 million annually and estimates the cost of the rule to be between \$10 million to \$17.5 million annually, assuming sales of 500,000 units annually (estimated costs range from \$5 million to \$35 million annually, depending on annual

sales between 250,000 and 1 million units). The Commission believes, preliminarily, that the benefits expected from the proposed rule bear a reasonable relationship to its costs.

I. Least Burdensome Requirement That Would Adequately Reduce the Risk of Injury

CPSC considered several less-burdensome alternatives to the proposed rule. One alternative is to take no regulatory action and, instead, rely on existing standards to address the magnet ingestion hazard. This would reduce the burden associated with the rule by avoiding a mandatory standard; however, this alternative is unlikely to adequately address the magnet ingestion hazard because none of the existing standards apply performance requirements to all of the products most commonly involved in magnet ingestions incidents.

Another alternative is a mandatory standard with less stringent requirements than the proposed rule, such as a higher flux index limit, or different requirements for certain shapes and sizes of magnets. This could reduce the burden associated with a rule by allowing firms to market a wider variety of products than under the proposed rule. However, this alternative would reduce the safety benefits because allowing certain hazardous magnets in subject magnet products to remain on the market does not address the hazard such products pose.

Safety messaging is another alternative to the proposed rule. This alternative would reduce the burdens associated with the rule because it would not require modifying or discontinuing subject magnet products, and the costs of such warnings and instructional information likely would be small. However, this alternative is not likely to adequately reduce the magnet ingestion hazard. Safety messaging is generally the least effective way to reduce hazards associated with consumer products; incident data shows children commonly access ingested magnets from sources that do not include product packaging, where warnings are provided; incident data, behavioral and developmental factors, and other information indicate that children and caregivers commonly disregard safety messaging regarding the magnet ingestion hazard; and this approach has not been effective at adequately reducing the hazard, to date.

Another alternative is to require special packaging to limit children's access to subject magnet products. Such packaging could help consumers determine if all magnets have been

returned to the container and include child-resistant features. Although this alternative would create some packaging costs, those costs likely would be lower than the proposed rule because it would allow subject magnet products to remain unchanged. However, this alternative is not likely to adequately reduce the risk of injury and death associated with magnet ingestions. Consumers are unlikely to repackage all magnets after each use, given the small size and large number of magnets in products, the potential to lose magnets, and consumers' demonstrated underappreciation of the hazard. In addition, packaging requirements are unlikely to be effective because they generally only restrict young children (under 5 years old) from accessing package contents, and would not prevent older children or teens from accessing the package contents, although the majority of magnet ingestion incidents involved children 5 years and older.

Another alternative is to require subject magnet products to be coated with aversive agents. This alternative would reduce the burden associated with the rule because it would allow firms to continue to sell subject magnet products and the costs of such coatings likely would be small. However, such requirements are not likely to adequately address the hazard because they do not address ingestions that occur when the first magnet is placed in the victim's mouth, before the aversive agent is detected, accidental ingestions, or children who are developmentally inclined to place objects in their mouths.

Another alternative is to provide a longer effective date for the final rule. This may reduce the burdens associated with the rule by spreading them over a longer period, but it would also delay the safety benefits of the rule.

XVII. Request for Comments

The Commission requests comments on all aspects of the proposed rule. Comments should be submitted in accordance with the instructions in the **ADDRESSES** section at the beginning of this notice. The following are specific comment topics that the Commission would find helpful:

A. Scope and Definitions

- The scope of products covered by the proposed rule, and whether additional products should be included or excluded from the scope;
- Specifically, whether home/kitchen magnets or education products should be addressed in the rule;

- Data supporting any recommendations to include or exclude products from the scope of the rule; and
- Information and data about magnets involved in ingestion incidents that are categorized as unidentified product types in staff's analysis.

B. Performance Requirements

- Application of the ASTM F963 test method for measuring flux density, particularly to test small diameter spherical magnets in the 2 to 3 mm diameter range;
- Variances in flux density measurements of small spherical magnets, including correct identification of pole surfaces, accurate measurement of maximum absolute flux density, and accurate calculation of maximum cross section of the magnetic poles;
- Potential alternative methods of assessing the strength of magnets or their ability to cause internal interaction injuries;
- How many magnets should be tested, including whether all loose or separable magnets in subject magnet products should be tested, or only a representative sample or at least one representative sample of each shape and size should be tested, and how firms may satisfy such requirements;
- Whether statistical sampling should be used to determine how many magnets to test in a subject magnet product and to reasonably verify the tested sample is representative, particularly for products made up of numerous individual magnets;
- The proposed flux index limit of 50 kG² mm², including data on whether magnets with flux indexes less than 50 kG² mm² pose concern for the internal interaction hazard; and
- Whether the rule should include requirements similar to ASTM F963 to ensure that products do not liberate hazardous magnets after use and abuse testing.

C. Safety Messaging and Packaging Requirements

- Whether the rule should include requirements for safety messaging, particularly for products with flux indexes within the permissible range for which there is uncertainty about the flux indexes that can cause internal interaction hazards;
- Whether the rule should include requirements for packaging, particularly for products with flux indexes within the permissible range for which there is uncertainty about the flux indexes that can cause internal interaction hazards;

- What safety messaging requirements should include, and why they should be included; and
- What packaging requirements should include, and why they should be included.

D. Existing Standards

- Data regarding the level of compliance with existing standards that address magnet ingestions, including ASTM standards.

E. Economic Analysis (Preliminary Regulatory Analysis and IRFA)

- The estimates and other valuations used in CPSC's analysis regarding benefits and costs associated with the proposed rule;
- The annual unit sales of subject magnet products;
- The expected product life of subject magnet products;
- The number of subject magnet products subject to the proposed rule;
- The accuracy and reasonableness of the benefits estimates;
- Information about the costs to consumers associated with the proposed rule, including consumer needs for subject magnet products, and the potential impact of the proposed rule on the utility, cost, and availability of subject magnet products for those needs;
- The accuracy and reasonableness of the cost estimates for manufacturers and importers (if available, sales or other shipment data would be helpful);
- The potential impact of the proposed rule on small entities;
- Costs associated with testing and certification requirements, including requirements in section 14 of the CPSA, particularly for small businesses;
- Potential modifications to subject magnet products to comply with the proposed rule, and the costs associated with those modifications;
- The types and magnitude of manufacturing costs that might disproportionately impact small businesses or were not considered in the agency's analysis;
- The different impacts on small businesses associated with different effective dates; and
- Other alternatives that would minimize the impact on small businesses while reducing the magnet ingestion hazard.

F. Effective Date

- The reasonableness of the proposed 30-day effective date and recommendations for a different effective date, if justified. Comments recommending a longer effective date should describe the problems associated with meeting the proposed effective

date and the justification for a longer one.

G. Anti-Stockpiling

- Whether the Commission should consider including in the rule anti-stockpiling provisions to prevent manufacturing or importing of non-compliant subject magnet products at an increased rate during the period between announcing a final rule and the effective date of the rule; and
- Information relevant to whether an anti-stockpiling provision is necessary.

XVIII. Promulgation of a Final Rule

Section 9(d)(1) of the CPSA requires the Commission to promulgate a final consumer product safety rule within 60 days of publishing a proposed rule. 15 U.S.C. 2058(d)(1). Otherwise, the Commission must withdraw the proposed rule if it determines that the rule is not reasonably necessary to eliminate or reduce an unreasonable risk of injury associated with the product, or is not in the public interest. *Id.* However, the Commission can extend the 60-day period, for good cause shown, if it publishes the reasons for doing so in the **Federal Register**. *Id.*

The Commission finds that there is good cause to extend the 60-day period for this rulemaking. Under both the Administrative Procedure Act and the CPSA, the Commission must provide an opportunity for interested parties to submit written comments on a proposed rule. 5 U.S.C. 553; 15 U.S.C. 2058(d)(2). The Commission typically provides 75 days for interested parties to submit written comments. A shorter comment period may limit the quality and utility of information CPSC receives in comments, particularly for areas where it seeks data and other detailed information that may take time for commenters to compile. In addition, the CPSA requires the Commission to provide interested parties with an opportunity to make oral presentations of data, views, or arguments. 15 U.S.C. 2058. This requires time for the Commission to arrange a public meeting for this purpose, and provide notice to interested parties in advance of that meeting. After receiving written and oral comments, CPSC staff must have time to review and evaluate those comments.

These factors make it impractical for the Commission to issue a final rule within 60 days of this proposed rule. Moreover, issuing a final rule within 60 days of the NPR may limit commenters' ability to provide useful input on the rule, and CPSC's ability to evaluate and take that information into consideration in developing a final rule. Accordingly,

the Commission finds that there is good cause to extend the 60-day period.

XIX. Conclusion

For the reasons stated in this preamble, the Commission proposes requirements for subject magnet products to address an unreasonable risk of injury associated with ingestion of such products.

List of Subjects

16 CFR Part 1112

Administrative practice and procedure, Audit, Consumer protection, Reporting and recordkeeping requirements, Third-party conformity assessment body.

16 CFR Part 1262

Consumer protection, Imports, Incorporation by reference, Safety.

For the reasons discussed in the preamble, the Commission proposes to amend Title 16 of the Code of Federal Regulations as follows:

PART 1112—REQUIREMENTS PERTAINING TO THIRD PARTY CONFORMITY ASSESSMENT BODIES

- 1. The authority citation for part 1112 continues to read as follows:

Authority: Pub. L. 110–314, section 3, 122 Stat. 3016, 3017 (2008); 15 U.S.C. 2063.

- 2. Amend § 1112.15 by adding paragraph (b)(52) to read as follows:

§ 1112.15 When can a third party conformity assessment body apply for CPSC acceptance for a particular CPSC rule or test method?

* * * * *

(b) * * *

(52) 16 CFR part 1262, Safety Standard for Magnets.

* * * * *

- 3. Add part 1262 to read as follows:

PART 1262—SAFETY STANDARD FOR MAGNETS

Sec.

1262.1 Scope, purpose, application, and exemptions.

1262.2 Definitions.

1262.3 Requirements.

1262.4 Test procedure for determining flux index.

1262.5 Findings.

Authority: 15 U.S.C. 2056, 2058

§ 1262.1 Scope, purpose, application, and exemptions.

(a) *Scope and purpose.* This part 1262, a consumer product safety standard, prescribes the safety requirements for a *subject magnet product*, as defined in § 1262.2(b). These requirements are intended to reduce or

eliminate an unreasonable risk of death or injury to consumers who ingest one or more *hazardous magnets* (as defined in § 1262.2(a)) from a *subject magnet product*.

(b) *Application.* Except as provided in paragraph (c) of this section, all *subject magnet products* that are manufactured in the United States, or imported, on or after [effective date], are subject to the requirements of this part 1262, if they are *consumer products*. Section 3(a)(1) of the Consumer Product Safety Act (15 U.S.C. 2052(a)(1)) defines the term *consumer product* as an “article, or component part thereof, produced or distributed

(i) for sale to a consumer for use in or around a permanent or temporary household or residence, a school, in recreation, or otherwise, or

(ii) for the personal use, consumption or enjoyment of a consumer in or around a permanent or temporary household or residence, a school, in recreation, or otherwise.” The term does not include products that are not customarily produced or distributed for sale to, or for the use or consumption by, or enjoyment of, a consumer.

(c) *Exemptions.* Toys that are subject to 16 CFR part 1250, *Safety Standard Mandating ASTM F963 for Toys*, are exempt from this part 1262.

§ 1262.2 Definitions.

In addition to the definitions given in section 3 of the Consumer Product Safety Act (15 U.S.C. 2052), the following definitions apply for purposes of this part 1262:

(a) *Hazardous magnet* means a magnet that fits entirely within the cylinder described in 16 CFR 1501.4 and that has a flux index of 50 kG² mm² or more when tested in accordance with the method described in this part 1262.

(b) *Subject magnet product* means a consumer product that is designed, marketed, or intended to be used for entertainment, jewelry (including children's jewelry), mental stimulation, stress relief, or a combination of these purposes, and that contains one or more loose or separable magnets.

§ 1262.3 Requirements.

Each loose or separable magnet in a *subject magnet product* that fits entirely within the cylinder described in 16 CFR 1501.4 must have a flux index of less than 50 kG² mm² when tested in accordance with the method described in 1262.4.

§ 1262.4 Test procedure for determining flux index.

(a) Select at least one loose or separable magnet of each shape and size in the *subject magnet product*.

(b) Measure the flux index of each selected magnet in accordance with the procedure in section 8.25.1 through 8.25.3 of ASTM F963-17, *Standard Consumer Safety Specification for Toy Safety*, approved on May 1, 2017. The Director of the Federal Register approves this incorporation by reference in accordance with 5 U.S.C. 552(a) and 1 CFR part 51. You may obtain a copy from ASTM International, 100 Barr Harbor Drive, P.O. Box C700, West Conshohocken, PA 19428-2959; phone: (610) 832-9585; www.astm.org. A read-only copy of the standard is available for viewing on the ASTM website at <https://www.astm.org/READINGLIBRARY/>. You may inspect a copy at the Division of the Secretariat, U.S. Consumer Product Safety Commission, 4330 East-West Highway, Bethesda, MD 20814, telephone (301) 504-7479, email: cpsc-os@cpsc.gov, or at the National Archives and Records Administration (NARA). For information on the availability of this material at NARA, email fr.inspection@nara.gov, or go to: www.archives.gov/federal-register/cfr/ibr-locations.html.

§ 1262.5 Findings.

(a) *General.* Section 9(f) of the Consumer Product Safety Act (15 U.S.C. 2058(f)) requires the Commission to make findings concerning the following topics and to include the findings in the rule. Because the findings are required to be published in the rule, they reflect the information that was available to the Consumer Product Safety Commission (Commission, CPSC) when the standard was issued on [final rule publication date].

(b) *Degree and nature of the risk of injury.* (1) The standard is designed to reduce the risk of death and injury associated with magnet ingestions. The Commission has identified 284 magnet ingestions that were reported to have occurred between January 1, 2010 and December 31, 2020. Seventy-five percent of these incidents involved amusement or jewelry products, which are the products covered by this rule, and an additional 15 percent involved unidentified magnet products, a large portion of which CPSC concludes are likely to have involved subject magnet products, based on developmental and behavioral factors, identified products involved in magnet ingestion incidents, products involved in recalls for magnet ingestion hazards, and trend analyses indicating a significant decrease in magnet ingestion incidents when there was a mandatory standard for certain subject magnet products. There were an estimated 4,400 magnet ingestions treated in U.S. hospital emergency

departments between January 1, 2010 and December 31, 2020 that involved products categorized as being for amusement or jewelry, which are the products subject to this rule, and an additional estimated 18,100 emergency department treated magnet ingestions involving unidentified magnet products, a large portion of which CPSC concludes are likely to have involved subject magnet products for the reasons stated above. In addition, the Injury Cost Model projects that there were an additional estimated 3,255 magnet ingestion injuries per year treated in medical settings other than emergency departments from 2017 through 2020.

(2) The potential injuries when a child or teen ingests one or more magnets are serious. Health threats posed by magnet ingestion include pressure necrosis, volvulus, bowel obstruction, bleeding, fistulae, ischemia, inflammation, perforation, peritonitis, sepsis, ileus, ulceration, aspiration, and death, among others. These conditions can result from magnets attracting to each other through internal body tissue, or a single magnet attracting to a ferromagnetic object. CPSC is aware of several fatal magnet ingestion incidents that occurred in the United States, resulting from internal interaction of the magnets (small intestine ischemia and volvulus).

(c) *Number of consumer products subject to the rule.* Approximately 500,000 subject magnet products are estimated to be sold annually in the United States.

(d) *The need of the public for subject magnet products and the effects of the rule on their cost, availability, and utility.* (1) Consumers use subject magnet products for entertainment, mental stimulation, stress relief, and jewelry. The proposed rule requires subject magnet products to meet performance requirements regarding size or strength, but does not restrict the design of products. As such, subject magnet products that meet the standard would continue to serve the purpose of amusement or jewelry for consumers. Magnets that comply with the proposed rule, such as non-separable magnets, larger magnets, weaker magnets, or non-permanent magnets, would likely still be useful for amusement or jewelry. However, it is possible that there may be some negative effect on the utility of subject magnet products if compliant products function differently or do not include certain desired characteristics.

(2) Retail prices of subject magnet products generally average under \$20. CPSC has identified subject magnet products that comply with the proposed rule, indicating that the cost of

compliant and non-compliant products are comparable.

(3) If the costs associated with redesigning or modifying subject magnet products to comply with the proposed rule results in manufacturers discontinuing products, there may be some loss in availability to consumers. However, this would be mitigated to the extent that compliant products meet the same consumer needs.

(e) *Other means to achieve the objective of the rule while minimizing adverse effects on competition, manufacturing, and commercial practices.* (1) The Commission considered several alternatives to achieve the objective of reducing unreasonable risks of injury and death associated with magnet ingestions. One alternative is to take no regulatory action and, instead rely on existing voluntary standards to address the magnet ingestion hazard. This would eliminate costs associated with the rule by avoiding a mandatory standard; however, this alternative is unlikely to adequately reduce the risk of injury and death associated with magnet ingestions. For one, none of the existing standards address all of the products most commonly identified in magnet ingestion incidents, and several of the standards provide exceptions to performance requirements for certain subject magnet products. In addition, under the existing standards, certain subject magnet products would not be subject to performance requirements regarding size and strength, instead relying on alternative requirements, such as safety messaging, which is unlikely to adequately reduce the magnet ingestion hazard.

(2) Another alternative is a mandatory standard with less stringent requirements than the proposed rule, such as a higher flux index limit, or different requirements for certain shapes and sizes of magnets. This could reduce the costs associated with a rule by allowing firms to market a wider variety of products than under the proposed rule. However, for this alternative to reduce costs, it would allow more products to remain on the market, thereby decreasing the safety benefits.

(3) Safety messaging requirements are another alternative to the proposed rule. This would reduce the costs associated with the rule because it would not require modifying or discontinuing subject magnet products, and the costs of warnings and instructional information likely would be small. However, this alternative is not likely to adequately reduce the risk of injury and death associated with magnet ingestion because the effectiveness of safety

messaging depends on consumer seeing the messaging and convincing them to avoid the hazard. Incident data indicate that children commonly access ingested magnets from sources that are unlikely to include the product packaging bearing instructions or warnings. Moreover, consumers are unlikely to consistently heed warnings because of the perception that subject magnet products are appropriate for children, and underappreciation of the magnet ingestion hazard. Safety messaging is generally considered the least effective way to address product hazards, and has been ineffective at addressing the magnet ingestion hazard, to date.

(4) Another alternative is to require special packaging to limit children's access to subject magnet products. Such packaging could help consumers determine if all magnets have been returned to the container and include child-resistant features. Although this alternative would create some packaging costs, those likely would be lower than the costs associated with the proposed rule because it would allow subject magnet products to remain unchanged. However, this alternative is not likely to adequately reduce the risk of injury and death associated with magnet ingestions. For packaging requirements to be effective, users would have to repackage all magnets after each use, which is unlikely given the small size and large number of magnets often in a product, the potential to lose magnets, and consumers' demonstrated underappreciation of the hazard. In addition, packaging requirements are unlikely to be effective because they generally only restrict young children (under 5 years old) from accessing package contents, and would not prevent older children or teens from accessing the package contents, although the majority of magnet ingestion incidents involved children 5 years and older.

(5) Another alternative is to require subject magnet products to be coated with aversive agents. This alternative would reduce the costs associated with the rule because it would allow firms to continue to sell subject magnet products and the costs of such coatings likely would be small. However, such requirements are not likely to adequately reduce the risk of injury and death associated with magnet ingestions because they do not address ingestions that occur when the first magnet is placed in the victim's mouth, before the aversive agent is detected, accidental ingestions, or children who are developmentally inclined to place objects, including unpalatable substances, in their mouths.

(6) Another alternative is to provide a longer effective date for the final rule. This may reduce the costs associated with the rule by spreading them over a longer period, but it would also delay the safety benefits of the rule.

(f) *Unreasonable risk.* (1) Incident data indicate that there were an estimated 23,700 magnet ingestions treated in U.S. hospital emergency departments from January 1, 2010 to December 31, 2020. Although this includes ingestions of all magnet types, and is not limited to subject magnet products, it provides an indication of the frequency with which children and teens ingest magnets, and the need to address the magnet ingestion hazard. Of these estimated 23,700 emergency department treated magnet ingestions, an estimated 4,400 involved products categorized as being for amusement or jewelry, which are the products subject to this rule, and an additional estimated 18,100 involved unidentified magnet product types. The Commission considers a large portion of the incidents involving unidentified magnet products to have been subject magnet products, based on the factors described above with respect to the finding regarding the degree and nature of the risk of injury. In addition, the Injury Cost Model projects that there were an additional estimated 3,255 magnet ingestion injuries per year treated in medical settings other than emergency departments from 2017 through 2020. Trend analysis indicates that magnet ingestions have significantly increased in recent years.

(2) The potential injuries when a person ingests one or more magnets are serious. Health threats posed by magnet ingestion include pressure necrosis, volvulus, bowel obstruction, bleeding, fistulae, ischemia, inflammation, perforation, peritonitis, sepsis, ileus, ulceration, aspiration, and death, among others. These conditions can result from magnets attracting to each other through internal body tissue, or a single magnet attracting to a ferromagnetic object. Magnet ingestion incidents commonly result in hospitalization, particularly when subject magnet products are ingested. The Commission is aware of five fatal magnet ingestion incidents that occurred in the United States between November 24, 2005 and January 5, 2021. Four of these incidents involved children 2 years old or younger, and all five victims died from injuries resulting from internal interaction of the magnets. Four of the five incidents identified the products as magnet sets, amusement products, or described them as having characteristics

that are consistent with subject magnet products.

(3) For these reasons, the Commission preliminarily concludes that the rule is reasonably necessary to eliminate or reduce an unreasonable risk of injury associated with the product.

(g) *Public interest.* This rule is intended to address an unreasonable risk of injury and death posed by magnet ingestions. The Commission believes that compliance with the requirements of the rule will significantly reduce magnet ingestion deaths and injuries in the future; thus, the rule is in the public interest. For these reasons, the Commission preliminarily concludes that issuing the rule is in the public interest.

(h) *Voluntary standards.* (1) The Commission is aware of six voluntary and international standards that address the magnet ingestion hazard: ASTM F963–17, *Standard Consumer Safety Specification for Toy Safety*; ASTM F2923–20, *Standard Specification for Consumer Product Safety for Children's Jewelry*; ASTM F2999–19, *Standard Consumer Safety Specification for Adult Jewelry*; ASTM F3458–21, *Standard Specification for Marketing, Packaging, and Labeling Adult Magnet Sets Containing Small, Loose, Powerful Magnets (with a Flux Index $\geq 50 \text{ kG}^2 \text{ mm}^2$)*; EN–71–1: 2014, *Safety of Toys; Part 1: Mechanical and Physical Properties*; and ISO 8124–1: 2018, *Safety of Toys—Part 1: Safety Aspects Related to Mechanical and Physical Properties*. The Commission does not consider the standards likely to result in an adequate reduction of the risk of injury associated with magnet ingestions because of the scope of products each standard covers, and the types of requirements included in them.

(2) None of these standards apply to all of the products most commonly identified in magnet ingestion incidents—magnet sets intended for users 14 years and older, magnet toys intended for users 14 years and older, and jewelry. Even for the products the standards do address, several standards provide exceptions for certain amusement and jewelry products, imposing only warning requirements for those products.

(3) In addition, several of the standards do not impose performance requirements on magnet themselves, such as size and strength requirements, instead recommending or requiring safety messaging or packaging. CPSC does not consider safety messaging or packaging requirements sufficient, without additional performance requirements, to adequately reduce the risk of injury and death associated with

magnet ingestions. Incident data indicate that children commonly access ingested magnets from sources that do not include packaging or safety messaging; children and caregivers have commonly disregarded safety messaging to date; safety packaging only limits young children (typically, children under 5 years old) from accessing its contents, which does not address magnet ingestions by older children and teens, which make up the majority of incidents; and safety packaging requires users to repackage all magnets after every use to be effective, which is unlikely given the large number and small size of magnets often in subject magnet products.

(4) For these reasons, the Commission preliminarily concludes that compliance with existing standards is not likely to result in the elimination or adequate reduction of the risk of injury associated with magnet ingestion.

(i) *Relationship of benefits to costs.* (1) CPSC estimates the aggregate benefits of the rule to be \$80 million to \$95 million annually and estimates the cost of the rule to be between \$10 million to \$17.5 million annually, assuming sales of 500,000 units annually (estimated costs range from \$5 million to \$35 million annually, depending on annual sales between 250,000 and 1 million units).

(2) On a per unit basis, CPSC estimates the expected benefits per unit to range from \$160 (assuming a 1.5-year product life and a 3 percent discount rate) to \$190 (assuming a 3-year product life and a 3 percent discount rate). The estimated expected cost to manufacturers per unit is between about \$5 and \$10, and there is an unquantifiable cost to consumers associated with lost utility and availability.

(3) Based on this analysis, the Commission preliminarily finds that the benefits expected from the rule bear a reasonable relationship to its anticipated costs.

(j) *Least burdensome requirement that would adequately reduce the risk of injury.* (1) CPSC considered several less-burdensome alternatives to the proposed rule. One alternative is to take no regulatory action and, instead, rely

on existing standards to address the magnet ingestion hazard. This would reduce the burden associated with the rule by avoiding a mandatory standard, however, this alternative is unlikely to adequately address the magnet ingestion hazard because none of the existing standards apply performance requirements to all of the products most commonly involved in magnet ingestions incidents.

(2) Another alternative is a mandatory standard with less stringent requirements than the proposed rule, such as a higher flux index limit, or different requirements for certain shapes and sizes of magnets. This could reduce the burden associated with a rule by allowing firms to market a wider variety of products than under the proposed rule. However, this alternative would reduce the safety benefits because allowing certain hazardous magnets in subject magnet products to remain on the market does not address the hazard such products pose.

(3) Safety messaging is another alternative to the proposed rule. This alternative would reduce the burdens associated with the rule because it would not require modifying or discontinuing subject magnet products, and the costs of such warnings and instructional information likely would be small. However, this alternative is not likely to adequately reduce the magnet ingestion hazard. Safety messaging is generally the least effective way to reduce hazards associated with consumer products; incident data shows children commonly access ingested magnets from sources that do not include product packaging, where warnings are provided; incident data, behavioral and developmental factors, and other information indicate that children and caregivers commonly disregard safety messaging regarding the magnet ingestion hazard; and this approach has not been effective at adequately reducing the hazard, to date.

(4) Another alternative is to require special packaging to limit children's access to subject magnet products. Such packaging could help consumers determine if all magnets have been returned to the container and include

child-resistant features. Although this alternative would create some packaging costs, those costs likely would be lower than the proposed rule because it would allow subject magnet products to remain unchanged. However, this alternative is not likely to adequately reduce the risk of injury and death associated with magnet ingestions. Consumers are unlikely to repackage all magnets after each use, given the small size and large number of magnets in products, the potential to lose magnets, and consumers' demonstrated underappreciation of the hazard. In addition, packaging requirements would only prevent young children (typically, children under 5 years old) from accessing the product, not older children or teens, who are involved in the majority of magnet ingestion incidents.

(5) Another alternative is to require subject magnet products to be coated with aversive agents. This alternative would reduce the burden associated with the rule because it would allow firms to continue to sell subject magnet products and the costs of such coatings likely would be small. However, such requirements are not likely to adequately address the hazard because they do not address ingestions that occur when the first magnet is placed in the victim's mouth, before the aversive agent is detected, accidental ingestions, or children who are developmentally inclined to place objects in their mouths.

(6) Another alternative is to provide a longer effective date for the final rule. This may reduce the burdens associated with the rule by spreading them over a longer period, but it would also delay the safety benefits of the rule.

(7) For these reasons, the Commission preliminarily finds that the rule imposes the least burdensome requirement that prevents or adequately reduces the risk of injury associated with magnet ingestions.

Alberta E. Mills,

Secretary, Consumer Product Safety Commission.

[FR Doc. 2021-27826 Filed 1-7-22; 8:45 am]

BILLING CODE 6355-01-P