



# FEDERAL REGISTER

---

Vol. 79

Monday,

No. 81

April 28, 2014

---

Part II

## Environmental Protection Agency

---

40 CFR Parts 79, 80, 85, et al.

Control of Air Pollution From Motor Vehicles: Tier 3 Motor Vehicle  
Emission and Fuel Standards; Final Rule

**ENVIRONMENTAL PROTECTION AGENCY**

**40 CFR Parts 79, 80, 85, 86, 600, 1036, 1037, 1039, 1042, 1048, 1054, 1065, and 1066**

[EPA-HQ-OAR-2011-0135; FRL 9906-86-OAR]

RIN 2060-AQ86

**Control of Air Pollution From Motor Vehicles: Tier 3 Motor Vehicle Emission and Fuel Standards**

**AGENCY:** Environmental Protection Agency (EPA).

**ACTION:** Final rule.

**SUMMARY:** This action establishes more stringent vehicle emissions standards and will reduce the sulfur content of gasoline beginning in 2017, as part of a systems approach to addressing the impacts of motor vehicles and fuels on air quality and public health. The gasoline sulfur standard will make emission control systems more effective for both existing and new vehicles, and will enable more stringent vehicle emissions standards. The vehicle standards will reduce both tailpipe and evaporative emissions from passenger cars, light-duty trucks, medium-duty passenger vehicles, and some heavy-duty vehicles. This will result in significant reductions in pollutants such as ozone, particulate matter, and air toxics across the country and help state and local agencies in their efforts to attain and maintain health-based National Ambient Air Quality

Standards. Motor vehicles are an important source of exposure to air pollution both regionally and near roads. These vehicle standards are intended to harmonize with California's Low Emission Vehicle program, thus creating a federal vehicle emissions program that will allow automakers to sell the same vehicles in all 50 states. The vehicle standards will be implemented over the same timeframe as the greenhouse gas/fuel efficiency standards for light-duty vehicles (promulgated by EPA and the National Highway Safety Administration in 2012), as part of a comprehensive approach toward regulating emissions from motor vehicles.

**DATES:** This final rule is effective on June 27, 2014. The incorporation by reference of certain publications listed in this regulation is approved by the Director of the Federal Register as of June 27, 2014.

**ADDRESSES:** EPA has established a docket for this action under Docket ID No. EPA-HQ-OAR-2011-0135. All documents in the docket are listed on the [www.regulations.gov](http://www.regulations.gov) Web site. Although listed in the index, some information is not publicly available, e.g., CBI or other information whose disclosure is restricted by statute. Certain other material, such as copyrighted material, is not placed on the Internet and will be publicly available only in hard copy form. Publicly available docket materials are available either electronically in [www.regulations.gov](http://www.regulations.gov) or in hard copy at

the Air and Radiation Docket and Information Center, EPA/DC, EPA West, Room 3334, 1301 Constitution Ave. NW., Washington, DC. The Public Reading Room is open from 8:30 a.m. to 4:30 p.m., Monday through Friday, excluding legal holidays. The telephone number for the Public Reading Room is (202) 566-1744, and the telephone number for the Air Docket is (202) 566-1742.

**FOR FURTHER INFORMATION CONTACT:** JoNell Iffland, Office of Transportation and Air Quality, Assessment and Standards Division (ASD), Environmental Protection Agency, 2000 Traverwood Drive, Ann Arbor MI 48105; Telephone number: (734) 214-4454; Fax number: (734) 214-4816; Email address: [iffland.jonell@epa.gov](mailto:iffland.jonell@epa.gov).

**SUPPLEMENTARY INFORMATION:**

**I. General Information**

*A. Does this action apply to me?*

Entities potentially affected by this rule include gasoline refiners and importers, ethanol producers, ethanol denaturant producers, butane and pentane producers, gasoline additive manufacturers, transmix processors, terminals and fuel distributors, light-duty vehicle manufacturers, independent commercial importers, alternative fuel converters, and manufacturers and converters of vehicles between 8,500 and 14,000 lbs gross vehicle weight rating (GVWR).

Potentially regulated categories include:

Category	NAICS <sup>a</sup> Code	SIC <sup>b</sup> Code	Examples of potentially affected entities
Industry .....	324110 .....	2911 .....	Petroleum refineries (including importers).
Industry .....	325110 .....	2869 .....	Butane and pentane manufacturers.
Industry .....	325193 .....	2869 .....	Ethyl alcohol manufacturing.
Industry .....	324110, 211112 .....	2911, 1321 .....	Ethanol denaturant manufacturers.
Industry .....	211112 .....	1321 .....	Natural gas liquids extraction and fractionation.
Industry .....	325199 .....	2869 .....	Other basic organic chemical manufacturing.
Industry .....	486910 .....	4613 .....	Natural gas liquids pipelines, refined petroleum products pipelines.
Industry .....	424690 .....	5169 .....	Chemical and allied products merchant wholesalers.
Industry .....	325199 .....	2869 .....	Manufacturers of gasoline additives.
Industry .....	424710 .....	5171 .....	Petroleum bulk stations and terminals.
Industry .....	493190 .....	4226 .....	Other warehousing and storage-bulk petroleum storage.
Industry .....	336111, 336112 .....	3711 .....	Light-duty vehicle and light-duty truck manufacturers.
Industry .....	811111, 811112, 811198 .....	7538, 7533, 7534 .....	Independent commercial importers.
Industry .....	335312, 336312, 336322, 336399, 811198.	3621, 3714, 3519, 3599, 7534	Alternative fuel converters.
Industry .....	333618, 336120, 336211, 336312.	3699, 3711, 3713, 3714 .....	On-highway heavy-duty engine & vehicle (>8,500 lbs GVWR) manufacturers.

<sup>a</sup>North American Industry Classification System (NAICS).

<sup>b</sup>Standard Industrial Classification (SIC).

This table is not intended to be exhaustive, but rather provides a guide for readers regarding entities likely to be regulated by this action. This table lists

the types of entities that EPA is now aware could potentially be regulated by this action. Other types of entities not listed in the table could also be

regulated. To determine whether your activities are regulated by this action, you should carefully examine the applicability criteria in 40 CFR parts 79,

80, 85, 86, 600, 1036, 1065, and 1066 and the referenced regulations. If you have any questions regarding the applicability of this action to a particular entity, consult the person listed in the preceding **FOR FURTHER INFORMATION CONTACT** section.

*B. Did EPA conduct a peer review before issuing this action?*

This regulatory action was supported by influential scientific information. Therefore, EPA conducted peer reviews in accordance with OMB's Final Information Quality Bulletin for Peer Review. EPA conducted several peer reviews in connection with data supporting the Tier 3 program, including new research on the effects of fuel properties changes (including sulfur effects) on exhaust and evaporative emissions of Tier 2 vehicles. The refinery-by-refinery cost model was also peer reviewed. The peer review reports are located in the docket for today's action, as well as the agency's response to the peer review comments.

## Table of Contents

- I. Executive Summary and Program Overview
  - A. Introduction
  - B. Overview of the Tier 3 Program
    - 1. Major Public Comments and Key Changes From the Proposal
    - 2. Key Components of the Tier 3 Program
  - C. What will the impacts of the standards be?
- II. Why is EPA taking this action?
  - A. Basis for Action Under the Clean Air Act
    - 1. Clean Air Act Section 202
    - 2. Clean Air Act Section 211
  - B. Overview of Public Health Impacts of Motor Vehicles and Fuels
    - 1. Ozone
    - 2. Particulate Matter
    - 3. Oxides of Nitrogen and Sulfur
    - 4. Carbon Monoxide
    - 5. Mobile Source Air Toxics
    - 6. Near-Roadway Pollution
    - 7. Environmental Impacts of Motor Vehicles and Fuels
- III. How would this rule reduce emissions and air pollution?
  - A. Effects of the Vehicle and Fuel Changes on Mobile Source Emissions
    - 1. How do vehicles produce the emissions addressed in this action?
    - 2. How will the changes to gasoline sulfur content affect vehicle emissions?
  - B. How will emissions be reduced?
    - 1. NO<sub>x</sub>
    - 2. VOC
    - 3. CO
    - 4. Direct PM<sub>2.5</sub>
    - 5. Air Toxics
    - 6. SO<sub>2</sub>
    - 7. Greenhouse Gases
  - C. How will air pollution be reduced?
    - 1. Ozone
    - 2. Particulate Matter
    - 3. Nitrogen Dioxide
    - 4. Air Toxics
- IV. Vehicle Emissions Program
  - A. Tier 3 Tailpipe Emission Standards for Light-Duty Vehicles, Light-Duty Trucks, and Medium-Duty Passenger Vehicles
    - 1. How the Tier 3 Program is harmonized with the California LEV III Program
    - 2. Summary of the Tier 3 FTP and SFTP Tailpipe Standards
    - 3. FTP Standards
    - 4. SFTP Standards
    - 5. Feasibility of the NMOG+NO<sub>x</sub> and PM Standards
    - 6. Impact of Gasoline Sulfur Control on the Effectiveness of the Vehicle Emission Standards
    - 7. Other Provisions
  - B. Tailpipe Emissions Standards for Heavy-Duty Vehicles
    - 1. Overview and Scope of Vehicles Regulated
    - 2. HDV Exhaust Emissions Standards
    - 3. Supplemental FTP Standards for HDVs
    - 4. HDV Emissions Averaging, Banking, and Trading
    - 5. Feasibility of HDV Standards
    - 6. Other HDV Provisions
  - C. Evaporative Emissions Standards
    - 1. Tier 3 Evaporative Emission Standards
    - 2. Program Structure and Implementation Flexibilities
    - 3. Technological Feasibility
    - 4. Heavy-Duty Gasoline Vehicle (HDGV) Requirements
    - 5. Evaporative Emission Requirements for FFVs
    - 6. Test Procedures and Certification Test Fuel
  - D. Improvements to In-Use Performance of Fuel Vapor Control Systems
    - 1. Reasons for Adding a Leak Test Standard
    - 2. Nature, Scope and Timing of Leak Standard
    - 3. Leak Standard Test Procedure
    - 4. Certification and Compliance
      - a. In-Use Verification Program (IUV) Requirements for the Leak Standard
  - E. Onboard Diagnostic System Requirements
    - 1. Onboard Diagnostic (OBD) System Regulation Changes—Timing
    - 2. Revisions to EPA OBD Regulatory Requirements
    - 3. Provisions for Emergency Vehicles
    - 4. Future Considerations
  - F. Emissions Test Fuel
    - 1. Gasoline Emissions Test Fuel: Ethanol Content and Volatility
    - 2. Other Gasoline Emissions Test Fuel Specifications
    - 3. Flexible Fuel Vehicle Exhaust Emissions Test Fuel
    - 4. Implementation Schedule
    - 5. Implications of Emission Test Fuel Changes on CAFE Standards, GHG Standards, and Fuel Economy Labels
    - 6. Consideration of Test Fuel for Nonroad Engines and Highway Motorcycles
    - 7. CNG and LPG Emissions Test Fuel Specifications
  - G. Small Business Provisions
    - 1. Lead Time and Relaxed Interim Standards
    - 2. Assigned Deterioration Factors
- 3. Reduced Testing Burden and OBD Requirements
- 4. Hardship Relief
- 5. Eligibility for the Flexibilities
- H. Compliance Provisions
  - 1. Exhaust Emission Test Procedures
  - 2. Reduced Test Burden
  - 3. Miscellaneous Provisions
  - 4. Manufacturer In-Use Verification Program (IUV) Requirements
- V. Fuel Program
  - A. Overview
    - 1. Background
    - 2. Summary of Final Tier 3 Fuel Program Standards
  - B. Annual Average Sulfur Standard
  - C. Per-Gallon Sulfur Caps
    - 1. Standards
    - 2. Requirements for Gasoline Additives
  - D. Averaging, Banking, and Trading Program
    - 1. How will the ABT Program assist with compliance?
    - 2. ABT Modeling
    - 3. Eligibility
    - 4. Credit Generation and Use
    - 5. Credit Trading Provisions
    - 6. ABT Provisions for Small Refiners and Small Volume Refineries
    - 7. Deficit Carryforward
  - E. Additional Program Flexibilities
    - 1. Regulatory Flexibility Provisions
    - 2. Provisions for Refiners Facing Hardship Situations
  - F. Compliance Provisions
    - 1. Registration, Reporting, and Recordkeeping Requirements
    - 2. Sampling and Testing Requirements
    - 3. Small Refiner Compliance
    - 4. Small Volume Refinery Compliance
    - 5. Attest Engagements, Violations, and Penalties
    - 6. Special Fuel Provisions and Exemptions
  - G. Standards for Oxygenates (Including Denatured Fuel Ethanol) and Certified Ethanol Denaturants
  - H. Standards for Fuel Used in Flexible Fueled Vehicles
  - I. Sulfur Standards for Purity Butane and Purity Pentane Streams Blended into Gasoline
  - J. Standards for CNG and LPG
  - K. Refinery Air Permitting Interactions
    - 1. Proposal
    - 2. Updated Assessment of Tier 3 Refinery Changes and Permitting Implications
    - 3. Comments and Responses
  - L. Refinery Feasibility
    - 1. Comments Received
    - 2. Is it feasible for refiners to comply with a 10 ppm average sulfur standard?
    - 3. Can refiners meet the January 1, 2017 start date?
  - M. Statutory Authority for Tier 3 Fuel Controls
    - 1. Section 211(c)(1)(A)
    - 2. Section 211(c)(1)(B)
    - 3. Section 211(c)(2)(B)
    - 4. Section 211(c)(2)(C)
- VI. Technical Amendments and Regulatory Streamlining
  - A. Fuel Program Amendments
    - 1. Fuels Program Regulatory Streamlining
    - 2. Performance-Based Measurement Systems (PBMS)
    - 3. Downstream Pentane Blending

- 4. Acceptance of Top Tier Deposit Control Test Data
- 5. Potential Broader Regulatory Streamlining Through Program Restructuring
- B. Engine, Vehicle and Equipment Programs Amendments
  - 1. Fuel Economy Labeling
  - 2. Removing Obsolete Regulatory Text
  - 3. Motorcycle Driving Schedules
  - 4. Updating Reference Procedures
- VII. What are the cost impacts of the rule?
  - A. Estimated Costs of the Vehicle Standards
    - 1. What changes have been made to vehicle program costs since proposal?
    - 2. Summary of Vehicle Program Costs
  - B. Estimated Costs of the Fuel Program
    - 1. Overview
    - 2. Methodology
    - 3. Fuel Program Costs
    - 4. Other Cost Estimates
  - C. Summary of Program Costs
- VIII. What are the estimated benefits of the rule?
  - A. Overview
  - B. Quantified Human Health Impacts
  - C. Monetized Benefits
  - D. What are the limitations of the benefits analysis?
  - E. Illustrative Analysis of Estimated Monetized Impacts Associated With the Rule in 2018
- IX. Alternatives Analysis
  - A. Vehicle Emission Standards
    - 1. Shorter NMOG+NO<sub>x</sub> Standard Phase-in
    - 2. NMOG+NO<sub>x</sub> Standards Phase-in and Early Tier 3 Credits
    - 3. NMOG+NO<sub>x</sub> Standards
    - 4. PM Standards
    - 5. Higher Ethanol Content of Emissions Test Fuel
  - B. Fuel Sulfur Standards
    - 1. Annual Average Sulfur Standard
    - 2. Refinery Gate Sulfur Cap
  - C. Program Start Date
- X. Economic Impact Analysis
  - A. Introduction
  - B. Vehicle Sales Impacts
  - C. Impacts on Petroleum Refinery Sector Production
  - D. Employment Impacts
    - 1. Employment Impacts in the Auto Sector
    - 2. Refinery Employment Impacts
- XI. Public Participation
- XII. Statutory and Executive Order Reviews
  - A. Executive Order 12866: Regulatory Planning and Review and Executive Order 13563: Improving Regulation and Regulatory Review
  - B. Paperwork Reduction Act
  - C. Regulatory Flexibility Act
    - 1. Overview
    - 2. Background
    - 3. Reason for Today's Rule
    - 4. Legal Basis for Agency Action
    - 5. Summary of Potentially Affected Small Entities
    - 6. Reporting, Recordkeeping, and Compliance
    - 7. Related Federal Rules
    - 8. Steps Taken To Minimize the Economic Impact on Small Entities
  - D. Unfunded Mandates Reform Act
  - E. Executive Order 13132: Federalism

- F. Executive Order 13175: Consultation and Coordination With Indian Tribal Governments
- G. Executive Order 13045: Protection of Children From Environmental Health Risks and Safety Risks
- H. Executive Order 13211: Actions Concerning Regulations That Significantly Affect Energy Supply, Distribution, or Use
- I. National Technology Transfer and Advancement Act
- J. Executive Order 12898: Federal Actions To Address Environmental Justice in Minority Populations and Low-Income Populations
- K. Congressional Review Act
- XIII. Statutory Provisions and Legal Authority

## I. Executive Summary and Program Overview

### A. Introduction

In this action, EPA is finalizing a major program designed to reduce air pollution from passenger cars and trucks. This program includes new standards for both vehicle emissions and the sulfur content of gasoline, considering the vehicle and its fuel as an integrated system. We refer to this program as the “Tier 3” vehicle and fuel standards.

This rule is part of a comprehensive approach to address the impacts of motor vehicles on air quality and public health. Over 149 million Americans are currently experiencing unhealthy levels of air pollution, which are linked with respiratory and cardiovascular problems and other adverse health impacts that lead to increased medication use, hospital admissions, emergency department visits, and premature mortality.<sup>1</sup> Motor vehicles are a particularly important source of exposure to air pollution, especially in urban areas. By 2018, we project that in many areas that are not attaining health-based ambient air quality standards (i.e., “nonattainment areas”), passenger cars and light trucks will contribute 10–25 percent of total nitrogen oxides (NO<sub>x</sub>) emissions, 15–30 percent of total volatile organic compound (VOC) emissions, and 5–10 percent of total direct particulate matter (PM<sub>2.5</sub>) emissions.<sup>2</sup> These compounds form ozone, PM, and other air pollutants,

<sup>1</sup> The 149 million represents people living in O<sub>3</sub>, PM<sub>2.5</sub>, PM<sub>10</sub>, and SO<sub>2</sub> nonattainment areas. Data come from Summary Nonattainment Area Population Exposure Report, current as of December 5, 2013 at: <http://www.epa.gov/oar/oaqps/greenbk/popexp.html> and contained in Docket EPA-HQ-OAR-2011-0135.

<sup>2</sup> Mobile source contributions derived from inventories developed for this rule. For more information on these inventories see the Emissions Inventory Technical Support Document (TSD) for the final Tier 3 Rule, Docket ID No. EPA-HQ-OAR-2011-0135.

whose health and environmental effects are described in more detail in Section II. Cars and light trucks also continue to be a significant contributor to air pollution directly near roads, with gasoline vehicles accounting for more than 50 percent of near-road concentrations of some criteria and toxic pollutants.<sup>3</sup> More than 50 million people live, work, or go to school in close proximity to high-traffic roadways, and the average American spends more than one hour traveling along roads each day.<sup>4,5</sup> Over 80 percent of daily trips use personal vehicles.<sup>6</sup>

The standards set forth in this rule will significantly reduce levels of multiple air pollutants (such as ambient levels of ozone, PM, nitrogen dioxide (NO<sub>2</sub>), and mobile source air toxics (MSATs)) across the country, with immediate benefits from the gasoline sulfur control standards starting in 2017. These reductions will help state and local agencies in their effort to attain and maintain health-based National Ambient Air Quality Standards (NAAQS). Few other national strategies exist that will deliver the same magnitude of multi-pollutant reductions and associated public health protection that is projected to result from the Tier 3 standards. Without this action to reduce nationwide motor vehicle emissions, areas would have to adopt other, less cost-effective measures to reduce emissions from other sources under their state or local authority. In the absence of additional controls, certain areas would continue to have ambient ozone concentrations exceeding the NAAQS in the future. See Section III.C for more details.

The Clean Air Act authorizes EPA to establish emissions standards for motor vehicles to address air pollution that may reasonably be anticipated to endanger public health or welfare

<sup>3</sup> For example, see Fujita, E.M.; Campbell, D.E.; Zielinska, B.; Arnott, W.P.; Chow, J.C. (2011) Concentrations of Air Toxics in Motor Vehicle-Dominated Environments. Health Effects Institute Research Report 156. Available at <http://www.healtheffects.org>.

<sup>4</sup> U.S. Census Bureau (2011). Current Housing Reports, Series H150/09, American Housing Survey for the United States: 2009. U.S. Government Printing Office, Washington, DC. Available at <http://www.census.gov/hhes/www/housing/ahs/ahs09/ahs09.html>. (Note that this survey includes estimates of homes within 300 feet of highways with four or more lanes, railroads, and airports.)

<sup>5</sup> Drago, R. (2011). Secondary activities in the 2006 American Time Use Survey. U.S. Bureau of Labor Statistics Working Paper 446. Available at <http://www.bls.gov>.

<sup>6</sup> Santos, A.; McGuckin, N.; Yukiko Nakamoto, H.; Gray, D.; Liss, S. (2011) Summary of Travel Trends: 2009 National Household Travel Survey. Federal Highway Administration report no FHWA-PL-11-022. Available at <http://nhts.ornl.gov/publications.shtml>.

(section 202). EPA also has authority to establish fuel controls to address such air pollution (section 211). These statutory authorities are described in Section II.A.

The vehicle and gasoline sulfur standards we are finalizing represent a “systems approach” to reducing vehicle exhaust and evaporative emissions by addressing the vehicle and fuel as a system. The systems approach enables emission reductions that are both technologically feasible and cost-effective beyond what would be possible looking at vehicle and fuel standards in isolation. We first applied such an approach with our Tier 2 vehicle/gasoline sulfur standards (finalized in 2000).<sup>7</sup> We believe that a similar approach for the Tier 3 standards is a cost-effective way to achieve substantial additional emissions reductions.

The Tier 3 standards include new light- and heavy-duty vehicle emission standards for exhaust emissions of VOC (specifically, non-methane organic gases, or NMOG), NO<sub>x</sub>, and PM, as well as new evaporative emissions standards. The fully phased-in standards for light-duty vehicle, light-duty truck, and medium-duty passenger vehicle tailpipe emissions are an 80 percent reduction in fleet average NMOG+NO<sub>x</sub> compared to current standards, and a 70 percent reduction in per-vehicle PM standards. The fully phased-in Tier 3 heavy-duty vehicle tailpipe emissions standards for NMOG+NO<sub>x</sub> and PM are on the order of 60 percent lower than current standards. Finally, the fully phased-in evaporative emissions standards represent a 50 percent reduction from current standards.

The vehicle emission standards, combined with the reduction of gasoline sulfur content from the current 30 parts per million (ppm) average down to a 10 ppm average, will result in dramatic emissions reductions for NO<sub>x</sub>, VOC, direct PM<sub>2.5</sub>, carbon monoxide (CO) and air toxics. For example, in 2030, when Tier 3 vehicles will make up the majority of the fleet as well as vehicle miles traveled, NO<sub>x</sub> and VOC emissions from on-highway vehicles will be reduced by about 21 percent, and CO emissions will be reduced by about 24 percent. National emissions of many air toxics from on-highway vehicles will also be reduced by 10 to nearly 30 percent. Reductions will continue beyond 2030 as more of the fleet is composed of vehicles meeting the fully phased-in Tier 3 standards. For example, the Tier 3 program will reduce on-highway emissions of NO<sub>x</sub> and VOC

nearly 31 percent by 2050, when vehicles meeting the fully phased-in Tier 3 standards will comprise almost the entire fleet.

Gasoline vehicles depend to a great degree on catalytic converters to reduce levels of pollutants in their exhaust, including NMOG and NO<sub>x</sub>, as well as PM (specifically, the volatile hydrocarbon fraction), CO, and most air toxics. The catalytic converters become significantly less efficient when exposed to sulfur. The Tier 2 rulemaking required refiners to take steps to reduce sulfur levels in gasoline by approximately 90 percent, to an average of 30 ppm. As discussed in Section IV.A.6, subsequent research provides a compelling case that even this level of sulfur not only degrades the emission performance of vehicles on the road today, but also inhibits necessary further reductions in vehicle emissions performance to reach the Tier 3 standards. Thus, the 10 ppm average sulfur standard for Tier 3 is significant in two ways: it enables vehicles designed to the Tier 3 tailpipe exhaust standards to meet these standards in-use for the duration of their useful life, and it facilitates immediate emission reductions from all the vehicles on the road at the time the fuel sulfur controls are implemented. EPA is not the first regulatory agency to recognize the need for lower-sulfur gasoline. Agencies in Europe and Japan have already imposed gasoline sulfur caps of 10 ppm, and the State of California is already averaging 10 ppm sulfur with a per gallon cap of 20 ppm. Other states are preempted by the Clean Air Act from adopting new fuel programs to meet air quality objectives. Consequently, they could not receive the air quality benefits of lower sulfur gasoline without federal action.

This action is one aspect of a comprehensive national program regulating emissions from motor vehicles. EPA’s final rule for reducing greenhouse gas (GHG) emissions from light-duty (LD) vehicles starting with model year (MY) 2017 (referred to here as the “2017 LD GHG” standards) is another aspect of this comprehensive program.<sup>8</sup> The Tier 3 program addresses interactions with the 2017 LD GHG rule in a manner that aligns implementation of the two actions, to achieve significant criteria pollutant and GHG emissions reductions while providing regulatory certainty and compliance efficiency. As vehicle manufacturers introduce new vehicle platforms for compliance with

the GHG standards, they will be able to design them for compliance with the Tier 3 standards at the same time. The Tier 3 standards are also closely coordinated with California’s Low Emission Vehicle (LEV) III program to create a vehicle emissions program that will allow automakers to sell the same vehicles in all 50 states. (In December 2012 EPA approved a waiver of Clean Air Act preemption for the California Air Resources Board’s (CARB’s) LEV III program with compliance beginning in 2015. Twelve states adopted the LEV III program under Section 177 of the Clean Air Act.<sup>9</sup>) We have worked closely with individual vehicle manufacturers and their trade associations, who have emphasized the importance of a harmonized national program. Together, the Tier 3, 2017 LD GHG, and LEV III standards will provide significant reductions in GHGs, criteria pollutants and air toxics from motor vehicles while streamlining programs and enabling manufacturers to design a single vehicle for nationwide sales, thus reducing their costs of compliance. In this way, the Tier 3 program responds to the May 21, 2010 Presidential Memorandum that requested that EPA develop a comprehensive approach toward regulating motor vehicles, including consideration of non-GHG emissions standards.<sup>10</sup>

As part of the systems approach to this program, we have considered the types of fuels on which vehicles will be operating in the future. In particular, the renewable fuels mandate that was revised by the Energy Independence and Security Act (EISA) and is being implemented through the Renewable Fuel Standards program (RFS2)<sup>11</sup> is resulting in the use of significant amounts of ethanol-blended gasoline. We are updating the specifications of the emissions test fuel with which vehicles demonstrate compliance with emissions standards, in order to better reflect the ethanol content and other properties of gasoline that is in use today and is expected in future years.

Section I provides an overview of the vehicle and fuel standards we are finalizing as well as the impacts of the standards. The public health issues and statutory requirements that have prompted this action are described in Section II, and our discussion of how

<sup>9</sup> These states include Connecticut, Delaware, Maryland, Maine, Massachusetts, New Jersey, New York, Oregon, Pennsylvania, Rhode Island, Washington, and Vermont.

<sup>10</sup> The Presidential Memorandum is found at: <http://www.whitehouse.gov/the-press-office/presidential-memorandum-regarding-fuel-efficiency-standards>.

<sup>11</sup> 75 FR 14670 (March 26, 2010).

<sup>7</sup> 65 FR 6698 (February 10, 2000).

<sup>8</sup> EPA’s GHG standards are part of a joint National Program with the National Highway Traffic Safety Administration, which also set coordinated standards for Corporate Average Fuel Economy (CAFE). 77 FR 62623 (October 15, 2012).

the Tier 3 standards will reduce emissions and air pollution is presented in Section III. Details of the standards and how they will be implemented can be found in Sections IV through VI. Sections VII through X contain our discussion of the standards' technological feasibility and costs, benefits, and economic impacts. Sections XI through XIII address public participation, statutory and executive orders, and statutory provisions and legal authority under the Clean Air Act covered in this rulemaking.

This final rule is based on extensive public input received in response to EPA's Tier 3 proposal. The proposal was signed and posted on the EPA Web site on March 29, 2013, and published in the **Federal Register** on May 21, 2013. EPA held two public hearings in Philadelphia and Chicago in April 2013. In response to stakeholder requests, EPA extended the public comment period to July 1, 2013. We received more than 200,000 public comments. A broad range of stakeholders provided comments, including state and local governments, auto manufacturers, emissions control suppliers, refiners, fuel distributors and others in the petroleum industry, renewable fuels providers, environmental organizations, consumer groups, labor groups, private citizens, and others. Some of the issues raised in comments included lead time and the program's start date, the vehicle manufacturers' support for a 50-state program harmonized with California, the need for and degree of gasoline sulfur control (including the level of the sulfur cap), the ethanol content of vehicle certification test fuel, and various details on the flexibilities and other program design features of both the vehicle and fuels standards.

#### B. Overview of the Tier 3 Program

In the 14 years since EPA established the Tier 2 Vehicle Program, manufacturers of light-duty vehicles and automotive technology suppliers have continued to develop a wide range of improved technologies capable of reducing vehicle emissions. The California LEV II program has been instrumental in the continuous technology improvements by requiring year after year reductions in fleet average hydrocarbon levels, in addition to requiring the introduction of advanced exhaust and evaporative emission controls in partial zero emission vehicles (PZEVs). This technological progress has made it possible for manufacturers to achieve emission reductions well beyond the requirements of the Tier 2 program if

gasoline sulfur levels are lowered further.

As a result, in conjunction with lower gasoline sulfur standards, we are establishing new Tier 3 standards for exhaust emissions of NMOG, NO<sub>x</sub>, and PM, as well as for evaporative hydrocarbon emissions. These vehicle emissions standards will phase in beginning with MY 2017. The structure of the Tier 3 standards is very similar to that of the existing Tier 2 program. As with the Tier 2 program, the standards will apply to all light-duty vehicles (LDVs, or passenger cars), light-duty trucks (LDT1s, LDT2s, LDT3s, and LDT4s) and Medium-Duty Passenger Vehicles (MDPVs). We also are establishing separate but closely related standards for heavy-duty vehicles up to 14,000 lbs Gross Vehicle Weight Rating (GVWR).<sup>12</sup> We have concluded that the vehicle emissions standards, in conjunction with the reductions in fuel sulfur also required by this action, are feasible across the fleet in the timeframe provided.

Auto manufacturers have stressed the importance of being able to design, produce, and sell a single fleet of vehicles in all 50 states that complies with both the Tier 3 and California LEV III programs, as well as the greenhouse gas (GHG)/Corporate Average Fuel Economy (CAFE) programs in the same timeframe. To that end, we worked closely with the California Air Resources Board and vehicle manufacturers to align the two programs as closely as possible. This consistency among the federal and California programs means that manufacturers do not need to design unique versions of vehicles with different emission control hardware and calibrations for different geographic areas. This allows manufacturers to avoid the additional costs of parallel design, development, calibration, and manufacturing. We also have designed the Tier 3 program to be implemented in the same timeframe as the GHG emissions and fuel economy standards for model years 2017–2025. We expect that in response to these programs, manufacturers will be developing entirely new powertrains for most of their vehicles. Because the Tier 3 standards will phase in over the same timeframe, manufacturers are in a better position to simultaneously respond to all of these requirements.

Overall, the final Tier 3 program is very similar to the program we proposed. As discussed below and

throughout this preamble, the program phases in over several years—with the primary vehicle emission standards starting in Model Year (MY) 2017 (2018 for heavier vehicles) and the gasoline sulfur control provisions beginning in 2017.

As discussed above, we received a large number and wide range of comments on the proposed rule. Several comments raise particularly significant issues concerning some fundamental components of the Tier 3 program, including when the vehicle-related and fuel-related requirements begin. We briefly discuss these key issues in this section, and in more detail later in this preamble. The Summary and Analysis of Comments document provides our responses to the comments we received; it is located in the docket for this rulemaking and also on EPA's Web site at [www.epa.gov/otaq/tier3.htm](http://www.epa.gov/otaq/tier3.htm).

#### 1. Major Public Comments and Key Changes From the Proposal

##### a. Start Date and Lead Time Issues

##### (1) Gasoline Sulfur Control Program

Many stakeholders commented on the proposed 2017 start date of the Tier 3 program, with state and NGO organizations supporting finalizing the standards as proposed. Conversely, refiners, importers, and others in the fuel industry commented that they believed the proposed start date would not provide a sufficient amount of lead time to meet the requirements of the Tier 3 program, and that EPA has historically provided at least four years of lead time in previous fuels rulemakings. These commenters noted that five years of lead time is needed to allow for necessary refinery changes to be made during a refinery's normal turnaround/shutdown schedule (these occur every four years, on average) and to allow adequate time for the permitting process. These commenters also stated that, given the proposed flexibility provisions for vehicles, that a 2017 fuel program start date was not truly needed to enable the vehicle technology. Further, these commenters stated that they believed insufficient lead time would drive up the costs for regulated entities as they would need to do unscheduled shutdowns to install and/or revamp equipment to meet the proposed standards. Lastly, they stated that the uncertainty regarding the potential availability of credits would make meeting a 2017 start date more challenging.

As discussed in greater detail in Section V below, we are finalizing the proposed start date of January 1, 2017. We understand refiners' concerns,

<sup>12</sup> These heavy-duty vehicles were not included in the Tier 2 program but were subject to standards in a subsequent rule covering the heavy-duty sector (66 FR 5002, January 18, 2001).

including their concerns over the necessary capital investments and potential off-cycle turnarounds/shutdowns to make refinery modifications for Tier 3. In light of these concerns, we are finalizing additional flexibilities beyond those already in the proposal and we are confident that the program being finalized today addresses these concerns. Considering all the flexibilities offered to regulated parties, there is, in effect, nearly 6 years of time to comply provided for those refineries that may need it. As discussed in Section V.D, we are finalizing a credit averaging, banking, and trading (ABT) program that will allow for a smooth transition from the Tier 2 to Tier 3 ABT programs (including provisions for early credit generation beginning in 2014). These early credit provisions, coupled with the ability to carry over credits from Tier 2 into Tier 3 (an additional flexibility being finalized today that was not part of the proposal), will allow for early actions to reduce sulfur levels by some refineries to be used to delay the need for actions at other refineries until 2020. This structure of the ABT program allows refineries and importers the flexibility to choose the most economical compliance strategy—investment in technology, use of credits, or both—for meeting the Tier 3 average gasoline sulfur standard. In addition, approved small refineries and small volume refineries are given an additional three years from the January 1, 2017, Tier 3 program start date to comply (January 1, 2020).

We proposed that the Tier 2 ABT program would not only be separate from the Tier 3 ABT program, but that it would also end at the start of the Tier 3 program in 2017. The implications of this meant that any Tier 2 credits generated after 2012 would run the risk of expiring before the end of their full five-year life if they were not used before January 1, 2017. Commenters requested that EPA consider allowing such Tier 2 “banked” credits to receive their full five-year life. This would eliminate any incentive refineries may have to use these credits prior to the end of the Tier 2 program to raise their in-use sulfur levels. The ABT program that we are finalizing today enables a seamless transition from Tier 2 to Tier 3, including an allowance for Tier 2 banked credits to be used for their full five-year life or through December 31, 2019, whichever is earlier. Not only does this provision effectively provide more lead time and flexibility for refineries and importers, but we believe these banked credits will help to provide certainty of the availability of

credits for refineries and importers who may want to rely on them for compliance.

Finally, as discussed in Section V.E.2, we are also finalizing hardship provisions that allow refineries to petition for delayed compliance, on a case-by-case basis, for situations of extreme hardship or extreme unforeseen circumstances. These provisions, similar to those implemented in past fuel rulemakings, provide a safety valve should all the other flexibilities provided prove insufficient. As part of these hardship provisions, we are finalizing the ability for refineries to carry a deficit for up to 3 years, providing them with yet additional flexibility during the transition to Tier 3 should it prove necessary.

#### (2) Vehicle Emission Control Program

There were no major concerns raised for the proposed MY 2017 start date for lighter light-duty vehicles, although commenters from the auto manufacturing industry raised concerns about the lead time we proposed for heavier light-duty vehicles. Specifically, commenters pointed to Clean Air Act section 202(a)(3)(C) that, for vehicles over 6,000 lbs GVWR, requires that EPA emission standards provide at least four years of lead time and three years of regulatory stability.

In light of this statutory requirement, in addition to the primary declining fleet average standards starting in MY 2018 for heavier vehicles, EPA proposed an alternative phase-in schedule for any manufacturer that prefers a longer lead time and annual stability for these vehicles in lieu of the declining fleet average standards option. The commenters stated that the proposed alternative pathway would be too difficult to take advantage of in comparison to the primary program and thereby failed to comply with the Clean Air Act.

In considering these comments, EPA also considered that during the development of the Tier 3 program and in their comments, the same auto industry commenters consistently urged EPA to design the Tier 3 program to harmonize with the California LEV III standards as closely and as early as possible. As discussed in detail below in Section IV.A, extensive data that EPA has generated or received continue to support the conclusion that the primary fleet-average standards provide a compliance path that is feasible across the industry and that closely harmonizes with LEV III. EPA believes that we have reasonably resolved these somewhat competing concerns—early harmonization vs. additional lead

time—by finalizing the primary declining fleet average standards as proposed while also finalizing revised alternative phase-in compliance schedules (see Section IV.A.2.c). In response to the comments on this topic, we have revised the alternative phase-in schedules to reduce their associated burden for manufacturers, while still maintaining environmental benefits that are equivalent to the primary program. We also include provisions in the percent-of-sales phase-in alternatives that allow manufacturers to exclude vehicle models that begin their 2019 model year production early in 2018, in order to provide four years of lead time.

#### b. Emissions Test Fuel

In-use gasoline has changed considerably since EPA last revised specifications for the test gasoline used in emissions testing of light- and heavy-duty vehicles. Perhaps most importantly, gasoline containing 10 percent ethanol by volume (E10) has replaced non-oxygenated gasoline (E0) across the country. As a result, we are updating federal emissions test fuel specifications to better match in-use fuel.

In the NPRM, EPA proposed that the specified gasoline for emissions testing be changed from E0 to E15 as a forward-looking approach. Since then, several factors have led EPA to reconsider that approach, including minimal proliferation on a national scale of stations offering E15 and the complexities that E15 would introduce for long-term harmonization with California’s use of E10 in their LEV VIII program. We received comments from a broad set of stakeholders including the auto and oil industries, states, and NGOs with a general consensus that E15 would not be appropriate as the official test fuel at this time. Ethanol industry commenters supported E15 certification fuel, but provided no timeline by which this blend level would be representative of in-use fuel. In light of the comments received and EPA’s assessment of the current and projected levels of ethanol in gasoline in use, we are finalizing E10 as the new emissions test fuel.

In deciding to finalize E10 test fuel, EPA considered whether to change the volatility of the test fuel, typically expressed as pounds per square inch (psi) Reid Vapor Pressure (RVP). As discussed in detail in Section IV.F, after considering technical and policy implications as well as stakeholder comments, we have concluded that the most appropriate approach is to maintain an RVP of 9 psi for the E10 emissions test fuel at this time. EPA considered raising test fuel RVP to 10

psi, but decided to leave it unchanged at 9 psi based on what would have been the associated increase in stringency of the Tier 3 evaporative standard with 10 psi and the loss of regulatory harmony on evaporative emissions with California's LEV III program.

As a result, after reassessing market trends and considering comments, EPA concludes that the most appropriate approach is to finalize an ethanol content of 10 percent and an RVP of 9 psi for emissions test gasoline. We will continue to monitor ethanol trends in the gasoline market, as discussed later in this preamble.

#### c. Gasoline Sulfur Caps

As described in more detail in Section V.C. we proposed two options for the Tier 3 per-gallon sulfur caps—maintaining the Tier 2 refinery gate sulfur cap of 80 ppm (with a 95 ppm downstream sulfur cap), and lowering to a 50 ppm refinery gate sulfur cap beginning January 1, 2020 (with a 65 ppm downstream cap). We received comments supporting lower per-gallon caps which noted potential environmental benefits, greater certainty that vehicles would see lower and more uniform gasoline sulfur levels, and the ability to enable new vehicle technologies requiring very low sulfur levels. Conversely, comments received in support of maintaining the Tier 2 per-gallon caps cited concerns on cost, flexibility for turnarounds/unplanned shutdowns (due to refinery fires, natural disasters, etc.), and gasoline supply and/or price impacts.

Analysis performed since the time of the proposal found that a lower refinery gate cap would likely result in higher costs to the fuels industry and a decreased ability to handle off-spec product (potentially impacting gasoline supply and pricing), without any significant increase in the nationwide emissions reductions provided by the Tier 3 program. Thus, in today's action we are retaining the Tier 2 per-gallon sulfur caps. The 80 ppm refinery gate cap will provide refiners needed flexibility in allowing for naturally-occurring fuel batch variability, as well as more certainty that they will be able to continue producing and distributing gasoline during turnarounds/upsets to avoid a total shutdown. It will also provide more certainty for transmixture processors, additive manufacturers, and other downstream parties in producing gasoline.

However, we do understand commenters' concerns that retaining the Tier 2 sulfur caps might create regional differences in the benefits of the Tier 3 program. Therefore we will continue to

monitor in-use sulfur levels and their impact on vehicle emissions to ascertain whether a future reduction in the per-gallon cap may be necessary.

#### d. Effect of Gasoline Sulfur on Tier 3 Vehicle Emissions

The need for and level of gasoline sulfur control was a key issue raised in public comments. The petroleum industry raised concerns that there was insufficient basis for the proposed 10 ppm average sulfur level, while auto manufacturers and emissions control equipment manufacturers stressed that the feasibility of the Tier 3 vehicle standards was dependent on near-zero gasoline sulfur levels. This issue is discussed in detail below in Section IV.A.6. In sum, EPA believes that the range of studies conducted by EPA and others in recent years, along with the comments submitted by the auto industry and emissions control manufacturers during the comment period and more recently, strongly reinforce our conclusion that the impact of gasoline sulfur poisoning on exhaust catalyst performance is significant.

Sulfur is a well-known catalyst poison. The nature of sulfur's interactions with active catalytic materials is complex and varies with catalyst composition, exhaust gas composition, and exhaust temperature. Thus, even if a manufacturer were able to certify a new vehicle to the new stringent standards, the manufacturer's ability to maintain the emission performance of that vehicle in-use is greatly jeopardized if the vehicle is being operated on gasoline sulfur levels greater than 10 ppm. In fact, due to the variation in actual vehicle operation, any amount of gasoline sulfur will deteriorate catalyst efficiency. Vehicle manufacturers and suppliers, both individually and through their trade associations, stressed the need for gasoline sulfur to be reduced to near zero levels in order for them to meet the proposed standards. However, we believe that a 10 ppm average sulfur level is sufficiently low to enable compliance with the Tier 3 vehicle standards, and as described below and in Section V, reducing sulfur levels further would cause sulfur control costs to quickly escalate.

Taken together, this information provides a compelling argument that the fleetwide Tier 3 vehicle standards are achievable only with a reduction of gasoline sulfur content from the current 30 ppm average down to a 10 ppm average.

#### e. SFTP (US06) PM Standard for Light-Duty Vehicles

The final Tier 3 vehicle standards are largely unchanged from their proposed levels. One change from the proposal is the PM emissions standards as measured on the US06 test cycle. The US06 cycle is part of the composite Supplemental Federal Test Procedure (SFTP) and simulates aggressive driving. The US06 PM standards are part of the suite of Tier 3 tailpipe standards that limit emissions under a wide range of common vehicle driving conditions. Newer emissions test data presented in the NPRM, as well as more recent additional test data submitted in public comments, show that a numerically lower US06 PM standard is feasible and appropriately reflects the actual emissions performance achieved by many vehicles in the fleet today while preventing increased emissions in the future.

Taken together, the test results clearly show that most current light-duty vehicles—regardless of engine technology, emission control strategy, or vehicle size—are performing at much lower US06 emission levels than previously documented. Based on these newer data, we believe that it is appropriate to finalize a numerically lower US06 PM emission standard for LDVs, LDTs, and MDPVs, and to set a single standard for both lighter and heavier vehicles in this vehicle segment. In general, the final US06 PM standard for these vehicles begins to phase in at a level of 10 mg/mi in MYs 2017 and 2018, stepping down to a level of 6 mg/mi in MY2019. See Section IV.A.4.b for additional discussion of the US06 standards and how they will phase in.

#### 2. Key Components of the Tier 3 Program

##### a. Tailpipe Standards for Light-Duty Vehicle, Light-Duty Truck, and Medium-Duty Passenger Vehicle Tailpipe Emissions

We are establishing a comprehensive program that includes new fleet-average standards for the sum of NMOG and NO<sub>x</sub> tailpipe emissions (presented as NMOG+NO<sub>x</sub>) as well as new per-vehicle standards for PM.<sup>13</sup> These standards, when applied in conjunction with reduced gasoline sulfur content, will result in very significant improvements in vehicle emissions from the levels of the Tier 2 program. For these pollutants, the standards are measured on test procedures that represent a range of

<sup>13</sup> A discussion of the reasons for combining NMOG and NO<sub>x</sub> for this purpose is in Section IV.A.3.a below.



vehicle operation, including the Federal Test Procedure (or FTP, simulating typical driving) and the Supplemental Federal Test Procedure (or SFTP, a composite test simulating higher ambient temperatures, higher vehicle speeds, and quicker accelerations). In addition to the standards, we are extending the regulatory useful life period during which the standards apply (see Section IV.A.7.b below) and making test fuel more representative of expected real-world fuel (see Section I.B.2.e below). The final standards are in most cases identical to those of California's LEVIII program, which provides the 50-state harmonization strongly supported by the auto industry.

As proposed, the new Tier 3 FTP and SFTP NMOG+NO<sub>x</sub> standards are fleet-average standards, meaning that a manufacturer calculates the average emissions of the vehicles it sells in each model year and compares that average to the applicable standard for that model year. The manufacturer certifies each of its vehicles to a per-vehicle "bin" standard (see Section IV.A.2) and sales-weights these values to calculate its fleet-average NMOG+NO<sub>x</sub> emissions for each model year. Table I-1 summarizes the fleet average standards for NMOG+NO<sub>x</sub> evaluated over the FTP. The standards for light-duty vehicles begin in MY 2017 at a level representing a 46 percent reduction from the Tier 2 requirements. For the light-duty fleet

over 6000 lbs GVWR, and MDPVs, the standards apply beginning in MY 2018. As shown, these fleet-average standards decline during the first several years of the program, becoming increasingly stringent until ultimately reaching an 81 percent reduction when the transition is complete. The FTP NMOG+NO<sub>x</sub> program includes two separate sets of declining fleet-average standards, with LDVs and small light trucks in one grouping and heavier light trucks and MDPVs in a second grouping, that converge at 30 milligrams per mile (mg/mi) in MY 2025 and later. As mentioned above, we are also providing alternative percent phase-in schedules for this and the other light-duty standards.

TABLE I-1—TIER 3 LDV, LDT, AND MDPV FLEET AVERAGE FTP NMOG+NO<sub>x</sub> STANDARDS [mg/mi]

	Model year								
	2017 <sup>a</sup>	2018	2019	2020	2021	2022	2023	2024	2025 and later
LDV/LDT1 <sup>b</sup> .....	86	79	72	65	58	51	44	37	30
LDT2,3,4 and MDPV .....	101	92	83	74	65	56	47	38	30

<sup>a</sup>For LDV and LDTs above 6000 lbs GVWR and MDPVs, the fleet average standards apply beginning in MY 2018.

<sup>b</sup>These standards apply for a 150,000 mile useful life. Manufacturers can choose to certify some or all of their LDVs and LDT1s to a useful life of 120,000 miles. If a vehicle model is certified to the shorter useful life, a proportionally lower numerical fleet-average standard applies, calculated by multiplying the respective 150,000 mile standard by 0.85 and rounding to the nearest mg. See Section IV.A.7.c.

Similarly, as proposed, the NMOG+NO<sub>x</sub> standards measured over the SFTP are fleet-average standards, declining from MY 2017 until MY 2025,

as shown in Table I-2. In this case, the same standards apply to both lighter and heavier vehicles in the light-duty fleet. In MY 2025, the SFTP

NMOG+NO<sub>x</sub> standard reaches its final fleet average level of 50 mg/mi.

TABLE I-2—TIER 3 LDV, LDT, AND MDPV FLEET AVERAGE SFTP NMOG+NO<sub>x</sub> STANDARDS [mg/mi]

	Model year								
	2017 <sup>a</sup>	2018	2019	2020	2021	2022	2023	2024	2025 and later
NMOG + NO <sub>x</sub> .....	103	97	90	83	77	70	63	57	50

<sup>a</sup>For LDVs and LDTs above 6000 lbs GVWR and MDPVs, the fleet average standards apply beginning in MY 2018.

As proposed, manufacturers can also earn credits if their fleet average NMOG+NO<sub>x</sub> performance is better than the applicable standard in any model year. Credits that have been previously banked or obtained from other manufacturers can be used, or credits can be traded to other manufacturers. Manufacturers would also be allowed to carry forward deficits in their credit balance. (See Sections IV.A.7.a and IV.A.7.m).

We are also establishing PM standards as part of the Tier 3 program, for both the FTP and US06 cycles (as described above, US06 is a component of the SFTP test). Research has demonstrated that

the level of PM from gasoline light-duty vehicles is more significant than previously thought.<sup>14</sup> Although many vehicles today are performing at or near the levels of the new standards, the data indicate that improvements, especially in high-load fuel control and in the durability of engine components, are possible.

<sup>14</sup>Nam, E.; Fulper, C.; Warila, J.; Somers, J.; Michaels, H.; Baldauf, R.; Rykowski, R.; and Scarbro, C. (2008). Analysis of Particulate Matter Emissions from Light-Duty Gasoline Vehicles in Kansas City, EPA420-R-08-010. Assessment and Standards Division Office of Transportation and Air Quality U.S. Environmental Protection Agency Ann Arbor, MI, April 2008.

Under typical driving, as simulated by the FTP, the PM emissions of most current-technology gasoline vehicles are fairly low at certification and in use, well below the Tier 2 PM standards. At the same time we see considerable variation in PM emissions among vehicles of various makes, models, and designs. As a result, as proposed, we are setting the new FTP PM standard at a level that will ensure that all new vehicles perform at the level already being achieved by well-designed Tier 2 vehicles. The PM standards apply to each vehicle separately (i.e., not as a fleet average). Also, in contrast to the declining NMOG+NO<sub>x</sub> standards, the

PM standard on the FTP for certification testing is 3 mg/mi for all vehicles and for all model years. As for the NMOG+NO<sub>x</sub> standards, for vehicles over 6000 lbs GVWR, the FTP PM standard applies beginning in MY 2018. Manufacturers can phase in their vehicle models as a percent of U.S. sales through MY 2022. Most vehicles are

already performing at this stringent PM level, and the primary intent of the standard is to bring all light-duty vehicles to the typical level of PM performance being demonstrated by many of today's vehicles.

As proposed, the Tier 3 program also includes a temporary in-use FTP PM standard of 6 mg/mi for the testing of in-

use vehicles that applies during the percent phase-in period only. This in-use standard will address the in-use variability and durability uncertainties that accompany the introduction of new technologies. Table I-3 presents the FTP certification and in-use PM standards and the phase-in percentages.

TABLE I-3—PHASE-IN FOR TIER 3 FTP PM STANDARDS

	2017 <sup>a</sup>	2018	2019	2020	2021	2022 and later
Phase-In (percent of U.S. sales) .....	<sup>b</sup> 20	20	40	70	100	100
Certification Standard (mg/mi) .....	3	3	3	3	3	3
In-Use Standard (mg/mi) .....	6	6	6	6	6	3

<sup>a</sup>For LDVs and LDTs above 6000 lbs GVWR and MDPVs, the FTP PM standards apply beginning in MY 2018.

<sup>b</sup>Manufacturers comply in MY 2017 with 20 percent of their LDV and LDT fleet under 6,000 lbs GVWR, or alternatively with 10 percent of their total LDV, LDT, and MDPV fleet.

Finally, as discussed in Section I.B.1.e above, the Tier 3 program includes PM standards evaluated over the US06 driving cycle (the US06 is one part of the SFTP procedure) of 10 mg/mi through MY 2018 and of 6 mg/mi for 2019 and later model years, for light-duty vehicles. As in the case of the FTP PM standards, the intent of the US06 PM standard is to bring the emission performance of all vehicles to that already being demonstrated by many vehicles in the current light-duty fleet.

b. Heavy-Duty Vehicle Tailpipe Emissions Standards

As discussed in detail in Section IV.B, we are setting Tier 3 exhaust emissions standards for complete heavy-duty vehicles (HDVs) between 8,501 and 14,000 lbs GVWR. Vehicles in this GVWR range are often referred to as Class 2b (8,501–10,000 lbs) and Class 3 (10,001–14,000 lbs) vehicles, and are typically heavy-duty pickup trucks and work or shuttle vans. Most are built by companies with even larger light-duty truck markets, and as such they frequently share major design characteristics and emissions control technologies with their LDT

counterparts. However, in contrast to the largely gasoline-fueled LDT fleet, roughly half of the heavy-duty pickup and van fleet in the U.S. is diesel-fueled. This is an important consideration in setting emissions standards, as diesel engine emissions control strategies differ from those of gasoline engines.

As proposed, the key elements of the Tier 3 program for HDVs parallel those being adopted for passenger cars and LDTs, with adjustments in standard levels, emission test requirements, and implementation schedules appropriate to this sector. These key elements include combined NMOG+NO<sub>x</sub> declining fleet average standards, a phase-in of PM standards, adoption of a new emissions test fuel for gasoline-fueled vehicles, extension of the regulatory useful life to 150,000 miles or 15 years (whichever occurs first), and a first-ever requirement for HDVs to meet standards over an SFTP drive cycle that addresses real-world driving modes not well-represented by the FTP cycles.

We are adopting the Class 2b and Class 3 fleet average NMOG+NO<sub>x</sub> standards shown in Table I-4, as proposed. The standards become more stringent in successive model years from

2018 to 2022, with voluntary standards made available in 2016 and 2017, all of which are set at levels that match those of California's LEV III program for these classes of vehicles. Each covered HDV sold by a manufacturer in each model year contributes to this fleet average based on the mg/mi NMOG+NO<sub>x</sub> standard level of the "bin" declared for it by the manufacturer, who chooses from a set of seven discrete Tier 3 bins specified in the regulations. These bin standards then become the compliance standards for the vehicle over its useful life, with some adjustment provided for in-use testing in the early model years of the program.

As proposed, manufacturers can also earn credits for fleet average NMOG+NO<sub>x</sub> levels below the standard in any model year. Tier 3 credits that were previously banked, obtained from other manufacturers, or transferred across the Class 2b/Class 3 categories can be used to help demonstrate compliance. Unused credits expire after 5 model years. Manufacturers will also be allowed to carry forward deficits in their credit balance for up to 3 model years.

TABLE I-4—TIER 3 HDV FLEET AVERAGE FTP NMOG+NO<sub>x</sub> STANDARDS [mg/mi]

Model Year .....	Voluntary		Required program				
	2016	2017	2018	2019	2020	2021	2022 and later.
Class 2b .....	333	310	278	253	228	203	178.
Class 3 .....	548	508	451	400	349	298	247.

We are adopting the proposed FTP PM standards of 8 mg/mi and 10 mg/mi for Class 2b and Class 3 HDVs, respectively, phasing in as an increasing

percentage of a manufacturer's sales per year. We are adopting the same phase-in schedule as for the light-duty sector during model years 2018–2019–2020–

2021: 20–40–70–100 percent, respectively, and a more flexible but equivalent alternative PM phase-in is also being adopted. Tier 3 HDVs will

also be subject to CO and formaldehyde exhaust emissions standards that are more stringent than the existing standards.

Finally, we are setting first-ever nationwide SFTP standards for HDVs to ensure a robust overall control program that precludes high off-FTP cycle emissions by having vehicle designers consider them in their choice of compliance strategies. As for light-duty vehicles, we are requiring that SFTP compliance be based on a weighted composite of measured emissions from testing over the FTP cycle, the SC03 cycle, and an aggressive driving cycle, with the latter tailored to various HDV sub-categories: the US06 cycle for most HDVs, the highway portion of the US06 cycle for low power-to-weight Class 2b HDVs, and the LA-92 (or “Unified”) cycle for Class 3 HDVs. The SFTP standards are the same as those adopted for California LEV III vehicles, and apply to NMOG+NO<sub>x</sub>, PM, and CO emissions.

The HDV program outlined above and described in detail in Section IV.B is substantially what we proposed. Commenters generally supported the scope, stringency, and implementation phase-in of this program. However, some industry commenters requested changes to some specific provisions of the proposal, and the program we are adopting reflects improvements we have made in response. These are: (1) A limited allowance for engine certification of Class 3 complete diesel vehicles to avoid a potential need for dual chassis- and engine-based certification and to better harmonize with LEV III, (2) relaxed interim in-use testing standards to facilitate a smooth transition to the Tier 3 standards and to better harmonize with LEV III, (3) adoption of combined NMOG+NO<sub>x</sub> standards for the two highest (interim) bins, with a restriction placed on NO<sub>x</sub> levels in certification testing, to enhance the utility of these bins and to better harmonize with LEV III, and (4) a provision in the percent-of-sales phase-in alternative to allow manufacturers to exclude vehicle models that begin their 2019 model year production early in 2018, in order to provide four years of lead time. Commenters also requested relaxed standards for testing at high altitudes and changes to the credits program structure for generation of early credits and use of LEV III-based “vehicle emission credits”, but we did not adopt these for reasons explained in Section IV.B.

Overall, we expect the Tier 3 program we are adopting for HDVs to result in substantial reductions in harmful emissions from this large fleet of work

trucks and vans. The fully-phased in Tier 3 standards levels for NMOG+NO<sub>x</sub> and PM are on the order of 60 percent lower than the current standards that took full effect in the 2009 model year.

#### c. Evaporative Emission Standards

Gasoline vapor emissions from vehicle fuel systems occur when a vehicle is in operation, when it is parked, and when it is being refueled. These evaporative emissions, which occur on a daily basis from gasoline-powered vehicles, are primarily functions of temperature, fuel vapor pressure, and activity. EPA first instituted evaporative emission standards in the early 1970s to address emissions when vehicles are parked after being driven. These are commonly referred to as hot soak plus diurnal emissions. Over the subsequent years the test procedures have been modified and improved and the standards have become more numerically stringent. We have addressed emissions which arose from new fuel system designs by putting in place new requirements such as running loss emission standards and test procedure provisions to address permeation emissions. Subsequently standards were put in place to control refueling emissions from all classes of gasoline-powered motor vehicles up to 10,000 lbs GVWR. Evaporative and refueling emission control systems have been in place for most of these vehicles for many years. These controls have led to significant reductions, but evaporative and refueling emissions still constitute 30–40 percent of the summer on-highway mobile source hydrocarbon inventory. These fuel vapor emissions are ozone and PM precursors, and also contain air toxics such as benzene.

To control evaporative emissions, EPA is establishing more stringent standards that will require covered vehicles to have essentially zero fuel vapor emissions in use. These include more stringent evaporative emissions standards, new test procedures, and a new fuel/evaporative system leak emission standard. The program also includes refueling emission standards for all complete heavy-duty gasoline vehicles (HDGVs) over 10,000 lbs GVWR. EPA is including phase-in flexibilities as well as credit and allowance programs. The standards, harmonized with California’s “zero evap” standards, are designed to allow for a use of common technology in vehicle models sold throughout the U.S. The level of the standard remains above zero to account for nonfuel background emissions from the vehicle hardware.

Requirements to meet the Tier 3 evaporative emission regulations phase

in over a six model year period. We are finalizing three options for the 2017 model year, but after that the sales percentage requirements are 60 percent for MYs 2018 and 2019, 80 percent for model years 2020 and 2021, and 100 percent for model years 2022 and later. In Table I-5 we present the Tier 3 evaporative hot soak plus diurnal emission standards by vehicle class. The standards are approximately a 50 percent reduction from the existing standards. To enhance flexibility and reduce costs, EPA is finalizing provisions that allow manufacturers to generate allowances through early certifications (basically before the 2017 model year) and to demonstrate compliance using averaging concepts. Manufacturers may comply on average within each of the four vehicle categories, but not across these categories. EPA is not making any changes to the existing light-duty running loss or refueling emission standards, with the exception of the certification test fuel requirement discussed in Section I.B.2 below.

TABLE I-5—TIER 3 EVAPORATIVE EMISSION STANDARDS  
[g/test]

Vehicle class	Highest hot soak + diurnal level (over both 2-day and 3-day diurnal tests)
LDV, LDT1 .....	0.300
LDT2 .....	0.400
LDT3, LDT4, MDPV .....	0.500
HDGVs .....	0.600

Flexible Fuel Vehicles (FFVs) must meet the same evaporative emission standards as non-FFVs using Tier 3 emissions certification test fuel. However, FFVs must meet the refueling emission standards using 10 psi RVP fuel to account for emissions resulting from commingling with non-E85 blends that may be in the vehicle’s fuel tank.

EPA is establishing the canister bleed emission test procedure and emission standard to help ensure fuel vapor emissions are eliminated. Under this provision, manufacturers are required to measure diurnal emissions over the 2-day diurnal test procedure from just the fuel tank and the evaporative emission canister and comply with a 0.020 gram per test (g/test) standard for all LDVs, LDTs, and MDPVs, without averaging. The corresponding canister bleed test standard for HDGVs is 0.030 g/test. The Tier 3 evaporative emission standards will be phased in over a period of six model years between MY 2017 and MY

2022, with the leak test phasing in beginning in 2018.

Data from in-use evaporative emissions testing indicates that vapor leaks from vehicle fuel/evaporative systems are found in the fleet and that even very small leaks have the potential to make significant contributions to the mobile source VOC inventory. To help address this issue, we are also adding a new standard and test procedure to control vapor leaks from vehicle fuel and vapor control systems. The standard will prohibit leaks with a cumulative equivalent diameter of 0.02 inches or greater. We are adding this simple and inexpensive test and emission standard to help ensure vehicles maintain zero fuel vapor emissions over their full useful life. New LDV, LDT, MDPV, and HDGV equal to or less than 14,000 lbs GVWR meeting the Tier 3 evaporative emission regulations are also required to meet the leak standard beginning in the 2018 model year. Manufacturers must comply with the leak standard phase-in on the same percentage of sales schedule as that for the Tier 3 evaporative emission standards. Manufacturers will comply with the leak emission standard during certification and in use. The leak emission standard does not apply to HDGVs above 14,000 lbs GVWR.

EPA is also establishing new refueling emission control requirements for all complete HDGVs equal to or less than 14,000 lbs GVWR (i.e., Class 2b/3 HDGVs), starting in the 2018 model year, and for all larger complete HDGVs by the 2022 model year. The existing refueling emission control requirements apply to complete Class 2b HDGVs, and EPA is extending those requirements to other complete HDGVs, since the fuel and evaporative control systems on these vehicles are very similar to those on their lighter-weight Class 2b counterparts.

#### d. Onboard Diagnostic Systems (OBD)

EPA and CARB both have OBD regulations applicable to the vehicle classes covered by the Tier 3 emission standards. In the past the requirements have been very similar, so most manufacturers have met CARB OBD requirements and, as permitted in our regulations, EPA has generally accepted compliance with CARB's OBD requirements as satisfying EPA's OBD requirements. Over the past several years CARB has upgraded its requirements to help improve the effectiveness of OBD in ensuring good in-use exhaust and evaporative system emissions performance. We have reviewed these provisions and agree with CARB that these revisions will

help to improve in-use emissions performance, while at the same time harmonizing with the CARB program. Toward that end, we are adopting and incorporating by reference the current CARB OBD regulations, effective for the 2017 MY, with a few minor differences including phase-in flexibility provisions and specific additions to enhance the implementation of the leak standard. EPA is retaining the provision that certifying with CARB's program would permit manufacturers to seek a separate EPA certificate on that basis.

#### e. Emissions Test Fuel

As described above, after reassessing market trends and considering comments, EPA is finalizing E10 as the ethanol blend level in emissions test gasoline for Tier 3 light-duty and heavy-duty gasoline vehicles. We will continue to monitor the in-use gasoline supply and based on such review may initiate rulemaking action to revise the specifications for emissions test fuel to include a higher ethanol blend level. EPA is also making additional changes that are consistent with CARB's LEV III emissions test fuel specifications, including new specifications for octane, distillation temperatures, aromatics, olefins, sulfur and benzene. (See Section IV.F below for a detailed discussion of all the revised emission test fuel parameters.)

As discussed in Sections IV.A.7.d (tailpipe emission testing) and IV.C.5.b (evaporative emission testing), we are requiring certification of all Tier 3 light-duty and chassis-certified heavy-duty gasoline vehicles on federal E10 test fuel. The new test fuel specifications will apply to new vehicle certification, assembly line, and in-use testing.

With a change in the ethanol content of the test fuel, EPA also needed to consider whether a change is warranted in the volatility of the test fuel, typically expressed as pounds per square inch (psi) Reid Vapor Pressure (RVP). As discussed in detail in Section IV.F below, after considering several technical and policy implications as well as stakeholder comments, EPA has concluded that the most appropriate approach is to maintain an RVP of 9 psi for the E10 certification fuel at this time.

In addition to finalizing a new E10 emissions test fuel, we are also finalizing detailed specifications for the E85 emissions test fuel used for flexible fuel vehicle (FFV) certification, as discussed in Section IV.F.3.<sup>15</sup> This will

<sup>15</sup> Flexible fuel vehicles are currently required to meet emissions certification requirements using both E0 and E85 test fuels. However, there were no detailed regulatory specifications regarding the

resolve uncertainty and confusion in the certification of FFVs designed to operate on ethanol levels up to 83 percent. Furthermore, we allow vehicle manufacturers to request approval for an alternative certification fuel such as a high-octane 30 percent ethanol by volume blend (E30) for vehicles that may be optimized for such fuel.

#### f. Fuel Standards

Under the Tier 3 fuel program, gasoline must contain no more than 10 ppm sulfur on an annual average basis beginning January 1, 2017. Similar to the Tier 2 gasoline program, the Tier 3 program will apply to gasoline in the U.S. and the U.S. territories of Puerto Rico and the Virgin Islands, excluding California. The program will result in gasoline that contains, on average, two-thirds less sulfur than it does today. In addition, following discussions with numerous refiners and other segments of the fuel market (e.g., pipelines, terminals, marketers, ethanol industry representatives, transmix processors, additive manufacturers, etc.), the Tier 3 fuel program contains considerable flexibility to ease both initial and long-term implementation of the program. The program that we are finalizing today includes an averaging, banking, and trading (ABT) program that allows refiners and importers to spread out their investments over nearly a 6-year period through the use of an early credit program and then rely on ongoing nationwide averaging to meet the 10 ppm sulfur standard. In addition there is a three-year delay for small refiners and "small volume refineries". As a result of the early credit program, we anticipate considerable reductions in gasoline sulfur levels prior to 2017, with a complete transition to the 10 ppm average occurring by January 1, 2020. For more information on the gasoline sulfur program flexibilities, refer to Section V.E.

Under today's Tier 3 gasoline sulfur program, we are maintaining the current 80 ppm refinery gate and 95 ppm downstream per-gallon caps. We also evaluated and sought comment on the potential of lowering the per-gallon caps. While there are advantages and disadvantages with each of the sulfur cap options that we proposed, we believe that retaining the current Tier 2 sulfur caps is prudent at this time, as explained in more detail in Section V.C. Further, the stringency of the 10 ppm annual average standard will result in reduced gasoline sulfur levels nationwide. Today's program requires

composition of E85 test fuels before those finalized today.

that manufacturers of gasoline additives that are used downstream of the refinery at less than 1 volume percent must limit the sulfur contribution to the finished gasoline from the use of their additive to less than 3 ppm when the additive is used at the maximum recommended treatment rate (see Section V.C.2). This requirement will preclude the unnecessary use of high sulfur content additives in gasoline.

The vehicle emissions standards finalized today are fuel-neutral (i.e., they are applicable regardless of the type of fuel that the vehicle is designed to use). There currently are no sulfur standards for the fuel used in compressed natural gas (CNG) and liquid propane gas (LPG) vehicles. We requested comment on whether it is necessary for EPA to establish sulfur standards for CNG and LPG to enable them meeting more stringent vehicle emissions standards. EPA is deferring finalizing in-use sulfur requirements for CNG/LPG in this final rule to provide additional time to work with stakeholders to collect data on current CNG/LPG sulfur content, to determine whether additional control of in-use CNG/LPG sulfur content is needed, and to evaluate the feasibility and costs associated with potential additional sulfur controls (see Section V.J). Given that the information provided suggests that CNG/LPG sulfur levels tend to be low already, the vehicle emissions standards finalized today will apply to CNG/LPG vehicles in addition to vehicles fueled on gasoline, diesel fuel, or any other fuel. The sulfur content of highway diesel fuel is already required to meet a 15 ppm sulfur cap, which is sufficient for diesel fuel vehicles to meet the Tier 3 emissions standards.

As the number of flex-fuel vehicles (FFVs) in the in-use fleet increases, it is becoming increasingly important that all fuels used in FFVs, not just gasoline, meet fuel quality standards. A lack of clarity regarding the standards that apply to fuels used in FFVs could also act to impede the further expansion of ethanol blended fuels with concentrations greater than 15 volume percent, which is important to satisfying the requirements of the RFS2 program. Hence, we sought comment on appropriate regulatory mechanisms to implement in-use quality standards for E51–83 and E16–50 in the Tier 3 proposal. Additional work is needed on some issues that could not be accommodated within the timeline for this Tier 3 final rule. Therefore, we are choosing not to finalize these provisions at this time. We intend to finalize in-use fuel quality standards for E51–83 and

perhaps E16–50 as well in a follow-up final rule.

#### g. Regulatory Streamlining and Technical Amendments

This action also includes a number of items to help streamline the in-use fuels regulations at 40 CFR parts 79 and 80. The majority of these items involve clarifying vague or inconsistent language, removal or updating of outdated provisions, and decreasing in frequency and/or volume of reporting burden where data are no longer needed or are redundant with other EPA fuels programs. In general, we believe that these changes will reduce the burden on industry and allow the standards and resulting environmental benefits to be achieved as early as possible with no expected loss in environmental control. In some cases, these regulatory streamlining items are non-substantive amendments that correct minor errors or inconsistencies in the regulations.

The regulatory streamlining items that we are finalizing for the in-use fuels regulations are changes that we believe are straightforward and should be made quickly.

This action also includes a variety of technical amendments to certification-related requirements for engine and vehicle emission standards; adjusting the fuel economy label provisions to correspond to the new Tier 3 standards, removing obsolete regulatory text, and making several minor corrections and clarifications.

Please refer to Section VI for a complete discussion of technical amendments and regulatory streamlining provisions and issues.

#### C. What will the impacts of the standards be?

The final Tier 3 vehicle and fuel standards together will reduce dramatically emissions of NO<sub>x</sub>, VOC, PM<sub>2.5</sub>, and air toxics. The gasoline sulfur standards, which will take effect in 2017, will provide large immediate reductions in emissions from existing gasoline vehicles and engines. NO<sub>x</sub> emissions are projected to be reduced by about 260,000 tons, or about 10 percent of emissions from on-highway vehicles, in 2018, and these emission reductions will increase over time as newer vehicles become a larger percentage of the fleet. In 2030, when 70 percent of the miles travelled are projected to be from vehicles that meet the fully phased-in Tier 3 standards, we expect the NO<sub>x</sub> and VOC emissions to be reduced by about 330,000 tons and 170,000 tons, respectively, or 25 percent and 16 percent of emissions from on-highway vehicles compared to their

2030 levels without the Tier 3 program. Emissions of CO are projected to decrease by almost 3.5 million tons, or 24 percent of emissions from on-highway vehicles. Emissions of many air toxics will also be reduced, including benzene, 1,3-butadiene, acetaldehyde, formaldehyde, acrolein and ethanol, with reductions projected to range from 10 to nearly 30 percent of national emissions from on-highway vehicles. We expect these reductions to continue beyond 2030 as more of the fleet continues to turn over to Tier 3 vehicles; for example, by 2050, when nearly all of the fleet will have turned over to vehicles meeting the fully phased-in Tier 3 standards, we estimate the Tier 3 program will reduce on-highway emissions of NO<sub>x</sub> and VOC nearly 31 percent from the level of emissions projected without Tier 3 controls.<sup>16</sup>

These reductions in emissions of NO<sub>x</sub>, VOC, PM<sub>2.5</sub> and air toxics from the Tier 3 standards are projected to lead to significant decreases in ambient concentrations of ozone, PM<sub>2.5</sub> and air toxics (including notable nationwide reductions in benzene concentrations) by 2030, and will immediately reduce ozone in 2017 when the sulfur controls take effect. Additional information on the emission and air quality impacts of the final Tier 3 program is presented in Sections III.B and C.

Exposure to ambient concentrations of ozone, PM<sub>2.5</sub>, and air toxics is linked to adverse human health impacts such as premature deaths as well as other important public health and environmental effects (see Section II.B). The final Tier 3 standards are expected to reduce these adverse impacts and yield significant benefits, including those we can monetize and those we are unable to quantify. We estimate that by 2030, the emission reductions of the Tier 3 standards will annually prevent between 660 and 1,500 PM-related premature deaths, between 110 and 500 ozone-related premature deaths, 81,000 work days lost, 210,000 school absence days, and approximately 1.1 million minor restricted-activity days. The estimated annual monetized health benefits of the Tier 3 standards in 2030 (2011\$) is between \$7.4 and \$19 billion, assuming a 3-percent discount rate (or between \$6.7 billion and \$18 billion assuming a 7-percent discount rate). We project the final fuel standards to cost on average 0.65 cent (i.e., less than a penny) per gallon of gasoline, and the final vehicle standards to have an

<sup>16</sup> To estimate the benefits of the final Tier 3 rule, we performed air quality modeling for the year 2030.

average cost that increases in proportion to the increase in stringency during the phase-in period, from \$28 per vehicle in 2017 to \$72 per vehicle in 2025, when the standards are fully phased in. We estimate the annual cost of the overall program in 2030 will be approximately \$1.5 billion, and the 2030 benefits will be between 4.5 and 13 times the costs of the program.

The estimated benefits in Table I-6 include all of the human health impacts we are able to quantify and monetize at this time. However, the full complement of human health and welfare effects associated with PM, ozone and air toxics remain unquantified because of current limitations in methods and/or available data. As a result, the health benefits quantified in this section are likely underestimates of the total benefits attributable to the final standards. See Sections VII and VIII for detailed descriptions of the costs and benefits of this action.

TABLE I-6—SUMMARY OF ESTIMATED ANNUAL BENEFITS AND COSTS ASSOCIATED WITH THE FINAL TIER 3 PROGRAM

[Billions, 2011\$]<sup>a</sup>

Description	2030
Vehicle Program Costs .....	\$0.76
Fuels Program Costs .....	\$0.70
Total Estimated Costs <sup>b</sup> .....	\$1.5
Total Estimated Health Benefits: <sup>c d e f</sup>	
3 percent discount rate .....	\$7.4–\$19
7 percent discount rate .....	\$6.7–\$18
Annual Net Benefits (Total Benefits – Total Costs):	
3 percent discount rate .....	\$5.9–\$18
7 percent discount rate .....	\$5.2–\$17

**Notes:**

<sup>a</sup>All estimates represent annual benefits and costs anticipated for the year 2030. Totals are rounded to two significant digits and may not sum due to rounding.

<sup>b</sup>The calculation of annual costs does not require amortization of costs over time. Therefore, the estimates of annual cost do not include a discount rate or rate of return assumption (see Section VII of the preamble for more information on vehicle and fuel costs).

<sup>c</sup>Total includes ozone and PM<sub>2.5</sub> estimated benefits. Range was developed by adding the estimate from the Bell et al., 2004 ozone premature mortality function to PM<sub>2.5</sub>-related premature mortality derived from the American Cancer Society cohort study (Krewski et al., 2009) for the low estimate and ozone premature mortality derived from the Levy et al., 2005 study to PM<sub>2.5</sub>-related premature mortality derived from the Six-Cities (Lepeule et al., 2012) study for the high estimate.

<sup>d</sup>Annual benefits analysis results reflect the use of a 3 percent and 7 percent discount rate in the valuation of premature mortality and nonfatal myocardial infarctions, consistent with EPA and OMB guidelines for preparing economic analyses.

<sup>e</sup>Valuation of premature mortality based on long-term PM exposure assumes discounting over the SAB recommended 20-year segmented lag structure described in the Regulatory Impact Analysis for the 2012 PM National Ambient Air Quality Standards (December, 2012).

<sup>f</sup>Not all possible benefits are quantified and monetized in this analysis; the total monetized benefits presented here may therefore be underestimated. Potential benefit categories that have not been quantified and monetized, due to current limitations in methods and/or data availability, are listed in Table VIII-2. For example, we have not quantified a number of known or suspected health and welfare effects linked with reductions in ozone and PM (e.g., reductions in heart rate variability, reduced material damage to structures and cultural monuments, and reduced eutrophication in coastal areas). We are also unable to quantify health and welfare benefits associated with reductions in air toxics.

## II. Why is EPA taking this action?

The Clean Air Act authorizes EPA to establish emissions standards for motor vehicles to address air pollution that may reasonably be anticipated to endanger public health or welfare. EPA also has authority to establish fuel controls to address such air pollution. These statutory requirements are described in Section II.A.

Emissions from motor vehicles and their fuels contribute to ambient levels of ozone, PM, NO<sub>2</sub>, sulfur dioxide (SO<sub>2</sub>) and CO, which are all pollutants for which EPA has established health-based NAAQS. These pollutants are linked with respiratory and/or cardiovascular problems and other adverse health impacts leading to increased medication use, hospital admissions, emergency department visits, and premature mortality. Over 149 million people currently live in areas designated nonattainment for one or more of the current NAAQS for ozone, PM<sub>2.5</sub>, PM<sub>10</sub>, and SO<sub>2</sub>.<sup>17</sup>

Motor vehicles also emit air toxics, and the most recent available data indicate that the majority of Americans continue to be exposed to ambient concentrations of air toxics at levels which have the potential to cause adverse health effects, including cancer, immune system damage, and neurological, reproductive, developmental, respiratory, and other health problems.<sup>18</sup> A more detailed discussion of the health and environmental effects of these pollutants is included in Section II.B.

Cars and light trucks also continue to be a significant contributor to air

pollution directly near roads, with gasoline vehicles accounting for more than 50 percent of near-road concentrations of some criteria and toxic pollutants.<sup>19</sup> More than 50 million people live, work, or go to school in close proximity to high-traffic roadways, and the average American spends more than one hour traveling each day, with over 80 percent of daily trips occurring by personal vehicle.<sup>20 21 22 23 24</sup>

Exposure to traffic-related pollutants has been linked with adverse health impacts such as respiratory problems (particularly in asthmatic children) and cardiovascular problems.

In the absence of additional controls such as Tier 3 standards, many areas will continue to have ambient ozone and PM<sub>2.5</sub> concentrations exceeding the NAAQS in the future. States and local areas are required to adopt control measures to attain the NAAQS and, once attained, to demonstrate that control measures are in place sufficient to maintain the NAAQS for ten years (and eight years later, a similar demonstration is required for another ten-year period). The Tier 3 standards will be a critical part of many areas' strategies to attain and maintain the NAAQS. Maintaining the NAAQS has been challenging for some areas in the past, particularly those where high population growth rates lead to significant annual increases in vehicle trips and vehicle miles traveled. Our air quality modeling for this final rule, which is described in more detail in Section III.C, projects that in 2018 a significant number of counties outside

<sup>19</sup> For example, see Fujita, E.M.; Campbell, D.E.; Zielinska, B.; Arnott, W.P.; Chow, J.C. (2011) Concentrations of Air Toxics in Motor Vehicle-Dominated Environments. Health Effects Institute Research Report 156. Available at <http://www.healtheffects.org>.

<sup>20</sup> Rowangould, G.M. (2013) A census of the US near-roadway population: public health and environmental justice considerations. Transportation Research Part D 25: 59–67.

<sup>21</sup> U.S. Census Bureau (2011). Current Housing Reports, Series H150/09, American Housing Survey for the United States: 2009. U.S. Government Printing Office, Washington, DC. Available at <http://www.census.gov/hhes/www/housing/ahs/ahs09/ahs09.html>.

<sup>22</sup> Drago, R.(2011). Secondary activities in the 2006 American Time Use Survey. U.S. Bureau of Labor Statistics Working Paper 446. Available at <http://www.bls.gov>.

<sup>23</sup> U.S. Department of Transportation, Bureau of Transportation Statistics. (2003) National Household Travel Survey 2001 Highlights Report. Government Printing Office, Washington, DC. Available at [http://www.bts.gov/publications/highlights\\_of\\_the\\_2001\\_national\\_household\\_travel\\_survey/](http://www.bts.gov/publications/highlights_of_the_2001_national_household_travel_survey/).

<sup>24</sup> Santos, A.; McGuckin, N, Yukiko Nakamoto, H.; Gray, D.; Liss, S. (2011) Summary of Travel Trends: 2009 National Household Travel Survey. Federal Highway Administration report no FHWA-PL-11-022. Available at <http://nhts.ornl.gov/publications.shtml>.

<sup>17</sup> Data come from Summary Nonattainment Area Population Exposure Report, current as of December 5, 2013 at: <http://www.epa.gov/oar/oaqps/greenbk/popexp.html> and contained in Docket EPA-HQ-OAR-2011-0135.

<sup>18</sup> U.S. EPA. (2011) Summary of Results for the 2005 National-Scale Assessment. [www.epa.gov/ttn/atw/nata2005/05pdf/sum\\_results.pdf](http://www.epa.gov/ttn/atw/nata2005/05pdf/sum_results.pdf).

CA will be within 10 percent of the 2008 ozone NAAQS, in the absence of additional controls. These counties in particular will benefit from the Tier 3 standards as they work to ensure long-term maintenance of the NAAQS.

Section III provides more detail on how we expect this action will reduce motor vehicle emissions and ambient levels of pollution. We project that the Tier 3 program will meaningfully reduce ozone concentrations as early as 2017 (the first year of the program), and even more significantly in 2030. The estimated reductions are of significant enough magnitude to bring ozone levels in some counties from above the standard to below the standard, even without any additional controls. We also project that the Tier 3 standards will reduce ambient PM<sub>2.5</sub> concentrations.

Without this action to reduce nationwide motor vehicle emissions, areas would have to adopt other measures to reduce emissions from other sources under their state or local authority. Few other measures exist for providing multi-pollutant reductions of the same magnitude and cost-effectiveness as those expected from the Tier 3 standards. Furthermore, most states do not have the authority to lower the sulfur in gasoline, which is needed to immediately reduce emissions from the existing fleet and also enable new vehicles to meet the Tier 3 emissions standards throughout their useful life.

The projected reductions in ambient ozone and PM<sub>2.5</sub> that will result from the Tier 3 standards will provide significant health benefits. We estimate that by 2030, the standards will annually prevent between 660 and 1,500 PM-related premature deaths, between 110 and 500 ozone-related premature deaths, 81,000 work days lost, 210,000 school absence days, and approximately 1.1 million minor restricted-activity days (see Section VIII for more details). This action will also reduce air toxics; for example, we project that in 2030, the Tier 3 standards will decrease ambient benzene concentrations by 10–25 percent in some urban areas. Furthermore, the Tier 3 standards will reduce traffic-associated pollution near major roads.

EPA is finalizing Tier 3 vehicle and fuel standards as part of a comprehensive nationwide program for regulating all types of air pollution from motor vehicles. EPA recently finalized standards to reduce GHG emissions from light-duty vehicles, starting with model year 2017.<sup>25</sup> The Tier 3 standards in this final rule, which address non-

GHGs, will be implemented on the same timeframe, thus allowing manufacturers to optimize their vehicle redesigns over both sets of standards. Furthermore, the Tier 3 vehicle and fuel standards are also closely aligned with California's LEV III program, in such a way that manufacturers will be able to design a single vehicle for nationwide sales. This reduces the cost of compliance for auto manufacturers.

This Tier 3 rulemaking responds to the President's request in his May 2010 memorandum for EPA to review the adequacy of its existing non-GHG standards for new motor vehicles and fuels, and to promulgate new standards, if necessary, as part of a comprehensive approach to regulating motor vehicles.<sup>26</sup> Based on our review, we have concluded that improved vehicle technology, combined with lower sulfur gasoline, make it feasible and cost-effective to reduce emissions well below the current Tier 2 levels. These emission reductions are necessary to reduce air pollution that is (and projected to continue to be) at levels that endanger public health and welfare.

#### *A. Basis for Action Under the Clean Air Act*

##### *1. Clean Air Act Section 202*

We are setting motor vehicle emission standards under the authority of section 202 of the Clean Air Act. Section 202(a) provides EPA with general authority to prescribe vehicle standards, subject to any specific limitations elsewhere in the Act. EPA is setting standards for larger light-duty trucks and MDPVs under the general authority of section 202(a)(1) and under section 202(a)(3), which requires that standards applicable to emissions of hydrocarbons, NO<sub>x</sub>, CO and PM from heavy-duty vehicles<sup>27</sup> reflect the greatest degree of emission reduction available for the model year to which such standards apply, giving appropriate consideration to cost, energy, and safety. In addition, section 202(k) provides EPA with authority to issue and revise regulations applicable to evaporative emissions of hydrocarbons from all gasoline-fueled

motor vehicles during: (1) Operation, and (2) over 2 or more days of nonuse; under ozone-prone summertime conditions. Regulations under section 202(k) shall take effect as expeditiously as possible and shall require the greatest degree of emission reduction achievable by means reasonably expected to be available for production during any model year to which the regulations apply, giving appropriate consideration to fuel volatility, and to cost, energy, and safety factors associated with the application of the appropriate technology. Further, section 206 and in particular section 206(d) of the Clean Air Act authorizes EPA to establish methods and procedures for testing whether a motor vehicle or motor vehicle engine conforms with section 202 requirements.

##### *2. Clean Air Act Section 211*

We are adopting gasoline sulfur controls pursuant to our authority under section 211(c)(1) of the CAA. This section allows EPA to establish a fuel control if at least one of the following two criteria is met: (1) The emission products of the fuel cause or contribute to air pollution which may reasonably be anticipated to endanger public health or welfare; or (2) the emission products of the fuel will impair to a significant degree the performance of any emissions control device or system which is either in general use or which the Administrator finds has been developed to a point where in a reasonable time it will be in general use were the fuel control to be adopted. We are finalizing gasoline sulfur controls based on both of these criteria. Under the first criterion, we believe that gasoline with current levels of sulfur contributes to ambient levels of air pollution that endanger public health and welfare, as described in Section II.B. Under the second criterion, we believe that gasoline sulfur impairs the emissions control systems of vehicles, as discussed in Section III.A.2.

#### *B. Overview of Public Health Impacts of Motor Vehicles and Fuels*

Motor vehicles emit pollutants that contribute to ambient concentrations of ozone, PM, NO<sub>2</sub>, SO<sub>2</sub>, CO, and air toxics. Motor vehicles are significant contributors to emissions of VOC and NO<sub>x</sub>, which contribute to the formation of both ozone and PM<sub>2.5</sub>. Over 149 million people currently live in counties designated nonattainment for one or more of the NAAQS, and this figure does not include the people living in areas with a risk of exceeding the

<sup>26</sup> The Presidential Memorandum is found at: <http://www.whitehouse.gov/the-press-office/presidential-memorandum-regarding-fuel-efficiency-standards>.

<sup>27</sup> LDTs that have gross vehicle weight ratings above 6000 lbs and all MDPVs are considered "heavy-duty vehicles" under the CAA. See section 202(b)(3)(C). For regulatory purposes, we generally refer to those LDTs which are above 6000 lbs GVWR and at or below 8500 lbs GVWR as "heavy light-duty trucks" made up of LDT3s and LDT4s, and we have defined MDPVs primarily as vehicles between 8500 and 10000 lbs GVWR designed primarily for the transportation of persons. See 40 CFR 86.1803–01.



NAAQS in the future.<sup>28</sup> The majority of Americans continue to be exposed to ambient concentrations of air toxics at levels which have the potential to cause adverse health effects.<sup>29</sup> In addition, populations who live, work, or attend school near major roads experience elevated exposure concentrations to a wide range of air pollutants.<sup>30</sup>

EPA has already adopted many emission control programs that are expected to reduce ambient pollution concentrations. As a result of these programs, the number of areas that continue to violate the ozone and PM<sub>2.5</sub> NAAQS or have high levels of air toxics is expected to continue to decrease. However, the baseline air quality modeling completed for this rule predicts that without additional controls there will continue to be a need for reductions in ozone, PM<sub>2.5</sub> and air toxics concentrations in some locations in the future. Section III.C of this preamble presents the air quality modeling results for this action.

## 1. Ozone

### a. Background

Ground-level ozone pollution is typically formed through reactions involving VOC and NO<sub>x</sub> in the lower atmosphere in the presence of sunlight. These pollutants, often referred to as ozone precursors, are emitted by many types of pollution sources, such as highway and nonroad motor vehicles and engines, power plants, chemical plants, refineries, makers of consumer and commercial products, industrial facilities, and smaller area sources.

The science of ozone formation, transport, and accumulation is complex. Ground-level ozone is produced and destroyed in a cyclical set of chemical reactions, many of which are sensitive to temperature and sunlight. When ambient temperatures and sunlight levels remain high for several days and the air is relatively stagnant, ozone and its precursors can build up and result in more ozone than typically occurs on a single high-temperature day. Ozone and its precursors can be transported hundreds of miles downwind from precursor emissions, resulting in

<sup>28</sup> Data come from Summary Nonattainment Area Population Exposure Report, current as of December 5, 2013 at: <http://www.epa.gov/oar/oaqps/greenbk/popexp.html> and contained in Docket EPA-HQ-OAR-2011-0135.

<sup>29</sup> U.S. EPA. (2011) Summary of Results for the 2005 National-Scale Assessment. [www.epa.gov/ttn/atw/nata2005/05pdf/sum\\_results.pdf](http://www.epa.gov/ttn/atw/nata2005/05pdf/sum_results.pdf).

<sup>30</sup> Health Effects Institute Panel on the Health Effects of Traffic-Related Air Pollution. (2010) Traffic-related air pollution: a critical review of the literature on emissions, exposure, and health effects. HEI Special Report 17. Available at <http://www.healtheffects.org/>.

elevated ozone levels even in areas with low local VOC or NO<sub>x</sub> emissions.

### b. Health Effects of Ozone

This section provides a summary of the health effects associated with exposure to ambient concentrations of ozone.<sup>31</sup> The information in this section is based on the information and conclusions in the February 2013 Integrated Science Assessment for Ozone (Ozone ISA) prepared by EPA's Office of Research and Development (ORD).<sup>32</sup> The Ozone ISA concludes that human exposures to ambient concentrations of ozone are associated with a number of adverse health effects and characterizes the weight of evidence for these health effects.<sup>33</sup> The discussion below highlights the Ozone ISA's conclusions pertaining to health effects associated with both short-term and long-term periods of exposure to ozone.

For short-term exposure to ozone, the Ozone ISA concludes that respiratory effects, including lung function decrements, pulmonary inflammation, exacerbation of asthma, respiratory-related hospital admissions, and mortality, are causally associated with ozone exposure. It also concludes that cardiovascular effects, including decreased cardiac function and increased vascular disease, and total mortality are likely to be causally associated with short-term exposure to ozone and that evidence is suggestive of a causal relationship between central nervous system effects and short-term exposure to ozone.

For long-term exposure to ozone, the Ozone ISA concludes that respiratory effects, including new onset asthma, pulmonary inflammation and injury, are likely to be a causally related with ozone exposure. The Ozone ISA characterizes the evidence as suggestive of a causal relationship for associations

<sup>31</sup> Human exposure to ozone varies over time due to changes in ambient ozone concentration and because people move between locations which have notable different ozone concentrations. Also, the amount of ozone delivered to the lung is not only influenced by the ambient concentrations but also by the individuals breathing route and rate.

<sup>32</sup> U.S. EPA. Integrated Science Assessment of Ozone and Related Photochemical Oxidants (Final Report). U.S. Environmental Protection Agency, Washington, DC, EPA/600/R-10/076F, 2013. The ISA is available at <http://cfpub.epa.gov/ncea/isa/recordisplay.cfm?deid=247492#Download>.

<sup>33</sup> The ISA evaluates evidence and draws conclusions on the causal relationship between relevant pollutant exposures and health effects, assigning one of five "weight of evidence" determinations: causal relationship, likely to be a causal relationship, suggestive of a causal relationship, inadequate to infer a causal relationship, and not likely to be a causal relationship. For more information on these levels of evidence, please refer to Table II in the Preamble of the ISA.

between long-term ozone exposure and cardiovascular effects, reproductive and developmental effects, central nervous system effects and total mortality. The evidence is inadequate to infer a causal relationship between chronic ozone exposure and increased risk of lung cancer.

Finally, interindividual variation in human responses to ozone exposure can result in some groups being at increased risk for detrimental effects in response to exposure. The Ozone ISA identified several groups that are at increased risk for ozone-related health effects. These groups are people with asthma, children and older adults, individuals with reduced intake of certain nutrients (i.e., Vitamins C and E), outdoor workers, and individuals having certain genetic variants related to oxidative metabolism or inflammation. Ozone exposure during childhood can have lasting effects through adulthood. Such effects include altered function of the respiratory and immune systems. Children absorb higher doses (normalized to lung surface area) of ambient ozone, compared to adults, due to their increased time spent outdoors, higher ventilation rates relative to body size, and a tendency to breathe a greater fraction of air through the mouth. Children also have a higher asthma prevalence compared to adults. Additional children's vulnerability and susceptibility factors are listed in Section XII.G.

### c. Current and Projected Concentrations of Ozone

Concentrations that exceed the level of the ozone NAAQS occur in many parts of the country, including major population centers such as Atlanta, Baltimore, Chicago, Dallas, Houston, New York, Philadelphia, and Washington, DC. In addition, our modeling without the Tier 3 controls projects that in the future we will continue to have many counties that will have ambient ozone concentrations above the level of the NAAQS (see Section III.C.1). States will need to meet the standard in the 2015–2032 time frame for the 2008 ozone NAAQS. The emission reductions and significant ambient ozone improvements from this rule, which will take effect starting in 2017, will be helpful to states as they work to attain and maintain the ozone NAAQS.

The primary and secondary NAAQS for ozone are 8-hour standards with a level of 0.075 ppm. The most recent revision to the ozone standards was in 2008; the previous 8-hour ozone standards, set in 1997, had a level of 0.08 ppm. In 2004, the U.S. EPA



designated nonattainment areas for the 1997 8-hour ozone NAAQS.<sup>34</sup> <sup>35</sup> As of December 5, 2013, there were 39 ozone nonattainment areas for the 1997 ozone NAAQS composed of 216 full or partial counties with a total population of over 112 million. Nonattainment designations for the 2008 ozone standard were finalized on April 30, 2012 and May 31, 2012.<sup>36</sup> As of December 5, 2013, there were 46 ozone nonattainment areas for the 2008 ozone NAAQS, composed of 227 full or partial counties, with a population of over 123 million. As of December 5, 2013, over 135 million people are living in ozone nonattainment areas.<sup>37</sup>

States with ozone nonattainment areas are required to take action to bring those areas into attainment. The attainment date assigned to an ozone nonattainment area is based on the area's classification. Most ozone nonattainment areas were required to attain the 1997 8-hour ozone NAAQS in the 2007 to 2013 time frame and then to maintain it thereafter.<sup>38</sup> The attainment dates for areas designated nonattainment for the 2008 8-hour ozone NAAQS are in the 2015 to 2032 timeframe, depending on the severity of the problem in each area. In addition, EPA is currently working on a review of the ozone NAAQS. If EPA revises the ozone standards pursuant to that review, the attainment dates associated with areas designated nonattainment for that NAAQS would be 5 or more years after the final rule is promulgated, depending on the severity of the problem in each area.

EPA has already adopted many emission control programs that are expected to reduce ambient ozone levels. As a result of these and other federal, state and local programs, 8-hour ozone levels are expected to improve in the future. However, even with the

implementation of all current state and federal regulations, there are projected to be counties violating the ozone NAAQS well into the future. Thus additional federal control programs, such as Tier 3, can assist areas with attainment dates in 2018 and beyond in attaining the NAAQS as expeditiously as practicable and may relieve areas with already stringent local regulations from some of the burden associated with adopting additional local controls.

## 2. Particulate Matter

### a. Background

Particulate matter is a highly complex mixture of solid particles and liquid droplets distributed among numerous atmospheric gases which interact with solid and liquid phases. Particles range in size from those smaller than 1 nanometer ( $10^{-9}$  meter) to over 100 micrometer ( $\mu\text{m}$ , or  $10^{-6}$  meter) in diameter (for reference, a typical strand of human hair is 70  $\mu\text{m}$  in diameter and a grain of salt is about 100  $\mu\text{m}$ ). Atmospheric particles can be grouped into several classes according to their aerodynamic and physical sizes, including ultrafine particles ( $<0.1 \mu\text{m}$ ), accumulation mode or 'fine' particles ( $<1$  to  $3 \mu\text{m}$ ), and coarse particles ( $>1$  to  $3 \mu\text{m}$ ).<sup>39</sup> For regulatory purposes, fine particles are measured as  $\text{PM}_{2.5}$  and inhalable or thoracic coarse particles are measured as  $\text{PM}_{10-2.5}$ , corresponding to their size (diameter) range in micrometers. The EPA currently has standards that measure  $\text{PM}_{2.5}$  and  $\text{PM}_{10}$ .<sup>40</sup>

Particles span many sizes and shapes and may consist of hundreds of different chemicals. Particles are emitted directly from sources and are also formed through atmospheric chemical reactions; the former are often referred to as "primary" particles, and the latter as "secondary" particles. Particle concentration and composition varies by time of year and location, and in addition to differences in source emissions, is affected by several weather-related factors, such as temperature, clouds, humidity, and wind. A further layer of complexity comes from particles' ability to shift between solid/liquid and gaseous

phases, which is influenced by concentration and meteorology, especially temperature.

Fine particles are produced primarily by combustion processes and by transformations of gaseous emissions (e.g., sulfur oxides ( $\text{SO}_x$ ), oxides of nitrogen, and volatile organic compounds (VOC)) in the atmosphere. The chemical and physical properties of  $\text{PM}_{2.5}$  may vary greatly with time, region, meteorology, and source category. Thus,  $\text{PM}_{2.5}$  may include a complex mixture of different components including sulfates, nitrates, organic compounds, elemental carbon and metal compounds. These particles can remain in the atmosphere for days to weeks and travel hundreds to thousands of kilometers.

### b. Health Effects of PM

Scientific studies show ambient PM is associated with a broad range of health effects. These health effects are discussed in detail in the December 2009 Integrated Science Assessment for Particulate Matter (PM ISA).<sup>41</sup> The PM ISA summarizes health effects evidence associated with both short- and long-term exposures to  $\text{PM}_{2.5}$ ,  $\text{PM}_{10-2.5}$ , and ultrafine particles. The PM ISA concludes that human exposures to ambient  $\text{PM}_{2.5}$  concentrations are associated with a number of adverse health effects and characterizes the weight of evidence for these health outcomes.<sup>42</sup> The discussion below highlights the PM ISA's conclusions pertaining to health effects associated with both short- and long-term PM exposures. Further discussion of health effects associated with  $\text{PM}_{2.5}$  can also be found in the rulemaking documents for the most recent review of the PM NAAQS completed in 2012.<sup>43</sup> <sup>44</sup>

The EPA concludes that a causal relationship exists between both long-

<sup>34</sup> 69 FR 23858 (April 30, 2004).

<sup>35</sup> A nonattainment area is defined in the Clean Air Act (CAA) as an area that is violating an ambient standard or is contributing to a nearby area that is violating the standard.

<sup>36</sup> 77 FR 30088 (May 21, 2012) and 77 FR 34221 (June 11, 2012).

<sup>37</sup> The 135 million total is calculated by summing, without double counting, the 1997 and 2008 ozone nonattainment populations contained in the Summary Nonattainment Area Population Exposure report (<http://www.epa.gov/oar/oaqps/greenbk/popexp.html>). If there is a population associated with both the 1997 and 2008 nonattainment areas, and they are not the same, then the larger of the two populations is included in the sum.

<sup>38</sup> The Los Angeles South Coast Air Basin 8-hour ozone nonattainment area and the San Joaquin Valley Air Basin 8-hour ozone nonattainment area are designated as Extreme and will have to attain before June 15, 2024. The Sacramento, Coachella Valley, Western Mojave and Houston 8-hour ozone nonattainment areas are designated as Severe and will have to attain by June 15, 2019.

<sup>39</sup> U.S. EPA. (2009). Integrated Science Assessment for Particulate Matter (Final Report). U.S. Environmental Protection Agency, Washington, DC, EPA/600/R-08/139F. Figure 3-1.

<sup>40</sup> Regulatory definitions of PM size fractions, and information on reference and equivalent methods for measuring PM in ambient air, are provided in 40 CFR Parts 50, 53, and 58. With regard to national ambient air quality standards (NAAQS) which provide protection against health and welfare effects, the 24-hour  $\text{PM}_{10}$  standard provides protection against effects associated with short-term exposure to thoracic coarse particles (i.e.,  $\text{PM}_{10-2.5}$ ).

<sup>41</sup> U.S. EPA. (2009). Integrated Science Assessment for Particulate Matter (Final Report). U.S. Environmental Protection Agency, Washington, DC, EPA/600/R-08/139F.

<sup>42</sup> The causal framework draws upon the assessment and integration of evidence from across epidemiological, controlled human exposure, and toxicological studies, and the related uncertainties that ultimately influence our understanding of the evidence. This framework employs a five-level hierarchy that classifies the overall weight of evidence and causality using the following categorizations: causal relationship, likely to be causal relationship, suggestive of a causal relationship, inadequate to infer a causal relationship, and not likely to be a causal relationship (U.S. EPA. (2009). Integrated Science Assessment for Particulate Matter (Final Report). U.S. Environmental Protection Agency, Washington, DC, EPA/600/R-08/139F, Table 1-3).

<sup>43</sup> 78 FR 3086 (January 15, 2013), pages 3103-3104.

<sup>44</sup> 77 FR 38890 (June 29, 2012), pages 38906-38911.

and short-term exposures to PM<sub>2.5</sub> and premature mortality and cardiovascular effects and a likely causal relationship exists between long- and short-term PM<sub>2.5</sub> exposures and respiratory effects. Further, there is evidence suggestive of a causal relationship between long-term PM<sub>2.5</sub> exposures and other health effects, including developmental and reproductive effects (e.g., low birth weight, infant mortality) and carcinogenic, mutagenic, and genotoxic effects (e.g., lung cancer mortality).<sup>45</sup>

As summarized in the Final PM NAAQS rule, and discussed extensively in the 2009 PM ISA, the scientific evidence available since the completion of the 2006 PM NAAQS review significantly strengthens the link between long- and short-term exposure to PM<sub>2.5</sub> and premature mortality, while providing indications that the magnitude of the PM<sub>2.5</sub>-mortality association with long-term exposures may be larger than previously estimated.<sup>46,47</sup> The strongest evidence comes from recent studies investigating long-term exposure to PM<sub>2.5</sub> and cardiovascular-related mortality. The evidence supporting a causal relationship between long-term PM<sub>2.5</sub> exposure and mortality also includes consideration of new studies that demonstrated an improvement in community health following reductions in ambient fine particles.

Several studies evaluated in the 2009 PM ISA have examined the association between cardiovascular effects and long-term PM<sub>2.5</sub> exposures in multi-city studies conducted in the U.S. and Europe. While studies were not available in the 2006 PM NAAQS review with regard to long-term exposure and cardiovascular-related morbidity, studies published since then have provided new evidence linking long-term exposure to PM<sub>2.5</sub> with an array of cardiovascular effects such as heart attacks, congestive heart failure, stroke, and mortality. This evidence is coherent with studies of short-term exposure to PM<sub>2.5</sub> that have observed associations with a continuum of effects

ranging from subtle changes in indicators of cardiovascular health to serious clinical events, such as increased hospitalizations and emergency department visits due to cardiovascular disease and cardiovascular mortality.<sup>48</sup>

As detailed in the 2009 PM ISA, extended analyses of studies available in the 2006 PM NAAQS review as well as epidemiological studies conducted in the U.S. and abroad published since then provide stronger evidence of respiratory-related morbidity effects associated with long-term PM<sub>2.5</sub> exposure. The strongest evidence for respiratory-related effects is from studies that evaluated decrements in lung function growth (in children), increased respiratory symptoms, and asthma development. The strongest evidence from short-term PM<sub>2.5</sub> exposure studies has been observed for increased respiratory-related emergency department visits and hospital admissions for chronic obstructive pulmonary disease (COPD) and respiratory infections.<sup>49</sup>

The body of scientific evidence detailed in the 2009 PM ISA is still limited with respect to associations between long-term PM<sub>2.5</sub> exposures and developmental and reproductive effects as well as cancer, mutagenic, and genotoxic effects, but is somewhat expanded from the 2006 review. The strongest evidence for an association between PM<sub>2.5</sub> and developmental and reproductive effects comes from epidemiological studies of low birth weight and infant mortality, especially due to respiratory causes during the post-neonatal period (i.e., 1 month to 12 months of age).<sup>50</sup> With regard to cancer effects, “[m]ultiple epidemiologic studies have shown a consistent positive association between PM<sub>2.5</sub> and lung cancer mortality, but studies have generally not reported associations between PM<sub>2.5</sub> and lung cancer incidence.”<sup>51</sup>

Specific groups within the general population are at increased risk for experiencing adverse health effects related to PM exposures.<sup>52,53,54,55</sup> The evidence detailed in the 2009 PM ISA expands our understanding of previously identified at-risk populations and lifestages (i.e., children, older adults, and individuals with pre-existing heart and lung disease) and supports the identification of additional at-risk populations (e.g., persons with lower socioeconomic status, genetic differences). Additionally, there is emerging, though still limited, evidence for additional potentially at-risk populations and lifestages, such as those with diabetes, people who are obese, pregnant women, and the developing fetus.<sup>56</sup>

For PM<sub>10-2.5</sub>, the 2009 PM ISA concluded that available evidence was suggestive of a causal relationship between short-term exposures to PM<sub>10-2.5</sub> and cardiovascular effects (e.g., hospital admissions and ED visits, changes in cardiovascular function), respiratory effects (e.g., ED visits and hospital admissions, increase in markers of pulmonary inflammation), and premature mortality. Data were inadequate to draw conclusions regarding the relationships between long-term exposure to PM<sub>10-2.5</sub> and various health effects.<sup>57,58,59</sup>

For ultrafine particles, the 2009 PM ISA concluded that the evidence was suggestive of a causal relationship between short-term exposures and cardiovascular effects, including changes in heart rhythm and vasomotor function (the ability of blood vessels to expand and contract). It also concluded that there was evidence suggestive of a causal relationship between short-term exposure to ultrafine particles and respiratory effects, including lung function and pulmonary inflammation,

<sup>52</sup> U.S. EPA. (2009). Integrated Science Assessment for Particulate Matter (Final Report). U.S. Environmental Protection Agency, Washington, DC, EPA/600/R-08/139F. Chapter 8 and Chapter 2.

<sup>53</sup> 77 FR 38890 (June 29, 2012).

<sup>54</sup> 78 FR 3104 (January 15, 2013).

<sup>55</sup> U.S. EPA. (2011). Policy Assessment for the Review of the PM NAAQS. U.S. Environmental Protection Agency, Washington, DC, EPA/452/R-11-003. section 2.2.1.

<sup>56</sup> U.S. EPA. (2009). Integrated Science Assessment for Particulate Matter (Final Report). U.S. Environmental Protection Agency, Washington, DC, EPA/600/R-08/139F. Chapter 8 and Chapter 2 (Section 2.4.1).

<sup>57</sup> U.S. EPA. (2009). Integrated Science Assessment for Particulate Matter (Final Report). U.S. Environmental Protection Agency, Washington, DC, EPA/600/R-08/139F. Section 2.3.4 and Table 2-6.

<sup>58</sup> 78 FR 3167-8 (January 15, 2013).

<sup>59</sup> 77 FR 38947-51 (June 29, 2012).

<sup>45</sup> These causal inferences are based not only on the more expansive epidemiological evidence available in this review but also reflect consideration of important progress that has been made to advance our understanding of a number of potential biologic modes of action or pathways for PM-related cardiovascular and respiratory effects (U.S. EPA. (2009). Integrated Science Assessment for Particulate Matter (Final Report). U.S. Environmental Protection Agency, Washington, DC, EPA/600/R-08/139F, chapter 5).

<sup>46</sup> 78 FR 3103-3104 (January 15, 2013).

<sup>47</sup> U.S. EPA. (2009). Integrated Science Assessment for Particulate Matter (Final Report). U.S. Environmental Protection Agency, Washington, DC, EPA/600/R-08/139F, chapter 6 (Section 6.5) and chapter 7 (Section 7.6).

<sup>48</sup> U.S. EPA. (2009). Integrated Science Assessment for Particulate Matter (Final Report). U.S. Environmental Protection Agency, Washington, DC, EPA/600/R-08/139F, chapter 2 (section 2.3.1 and 2.3.2) and chapter 6.

<sup>49</sup> U.S. EPA. (2009). Integrated Science Assessment for Particulate Matter (Final Report). U.S. Environmental Protection Agency, Washington, DC, EPA/600/R-08/139F, chapter 2 (section 2.3.1 and 2.3.2) and chapter 6.

<sup>50</sup> U.S. EPA. (2009). Integrated Science Assessment for Particulate Matter (Final Report). U.S. Environmental Protection Agency, Washington, DC, EPA/600/R-08/139F, chapter 2 (section 2.3.1 and 2.3.2) and chapter 7.

<sup>51</sup> U.S. EPA. (2009). Integrated Science Assessment for Particulate Matter (Final Report). U.S. Environmental Protection Agency, Washington, DC, EPA/600/R-08/139F. pg 2-13.

with limited and inconsistent evidence for increases in ED visits and hospital admissions. Data were inadequate to draw conclusions regarding the relationship between short-term exposure to ultrafine particle and additional health effects including premature mortality as well as long-term exposure to ultrafine particles and all health outcomes evaluated.<sup>60 61</sup>

### c. Current and Projected Concentrations of PM<sub>2.5</sub>

There are two primary NAAQS for PM<sub>2.5</sub>: an annual standard (12.0 micrograms per cubic meter (µg/m<sup>3</sup>)) and a 24-hour standard (35 µg/m<sup>3</sup>), and two secondary NAAQS for PM<sub>2.5</sub>: an annual standard (15.0 µg/m<sup>3</sup>) and a 24-hour standard (35 µg/m<sup>3</sup>). The initial PM<sub>2.5</sub> standards were set in 1997 and revisions to the standards were finalized in 2006 and in December 2012. The December 2012 rule revised the level of the primary annual PM<sub>2.5</sub> standard from 15.0 µg/m<sup>3</sup> to 12.0 µg/m<sup>3</sup>.<sup>62</sup>

There are many areas of the country that are currently in nonattainment for the annual and 24-hour PM<sub>2.5</sub> NAAQS. Our modeling without the Tier 3 controls projects that in the future we will continue to have many areas that will have ambient PM<sub>2.5</sub> concentrations above the level of the NAAQS (see Section III.C.2). States will need to meet the 2006 24-hour standards in the 2015–2019 timeframe and the 2012 primary annual standard in the 2021–2025 timeframe. The emission reductions and improvements in ambient PM<sub>2.5</sub> concentrations from this action, which will take effect starting in 2017, will be helpful to states as they work to attain and maintain the PM<sub>2.5</sub> NAAQS.

In 2005 the EPA designated 39 nonattainment areas for the 1997 PM<sub>2.5</sub> NAAQS.<sup>63</sup> As of December 5, 2013, over 68 million people lived in the 24 areas that are still designated as nonattainment for the 1997 annual PM<sub>2.5</sub> NAAQS. These PM<sub>2.5</sub> nonattainment areas are comprised of 135 full or partial counties. EPA anticipates making initial area designation decisions for the 2012 primary annual PM<sub>2.5</sub> NAAQS in December 2014, with those designations likely becoming effective in early

2015.<sup>64</sup> On November 13, 2009 and February 3, 2011, the EPA designated 32 nonattainment areas for the 2006 24-hour PM<sub>2.5</sub> NAAQS.<sup>65</sup> As of December 5, 2013, 28 of these areas remain designated as nonattainment, and they are composed of 104 full or partial counties with a population of over 65 million. In total, there are currently 39 PM<sub>2.5</sub> nonattainment areas with a population of over 84 million people.<sup>66</sup>

States with PM<sub>2.5</sub> nonattainment areas will be required to take action to bring those areas into attainment in the future. Designated nonattainment areas not currently attaining the 1997 annual PM<sub>2.5</sub> NAAQS are required to attain the NAAQS by 2015 and will be required to maintain the 1997 annual PM<sub>2.5</sub> NAAQS thereafter. The 2006 24-hour PM<sub>2.5</sub> nonattainment areas are required to attain the 2006 24-hour PM<sub>2.5</sub> NAAQS in the 2015 to 2019 time frame and will be required to maintain the 2006 24-hour PM<sub>2.5</sub> NAAQS thereafter. Areas to be designated nonattainment for the 2012 primary annual PM<sub>2.5</sub> NAAQS will likely be required to attain the 2012 NAAQS in the 2021 to 2025 time frame. The Tier 3 standards finalized here begin taking effect in 2017.

The EPA has already adopted many mobile source emission control programs that are expected to reduce ambient PM concentrations. As a result of these and other federal, state and local programs, the number of areas that fail to meet the PM<sub>2.5</sub> NAAQS in the future is expected to decrease. However, even with the implementation of all current state and federal regulations, there are projected to be counties violating the PM<sub>2.5</sub> NAAQS well into the future. Thus additional federal control programs, such as Tier 3, can assist areas with attainment dates in 2017 and beyond in attaining the NAAQS as expeditiously as practicable and may relieve areas with already stringent local regulations from some of the burden associated with adopting additional local controls.

### d. Current Concentrations of PM<sub>10</sub>

In the December 2012 action in which the EPA promulgated the revised primary annual PM<sub>2.5</sub> NAAQS, the EPA also retained the existing primary and secondary 24-hour PM<sub>10</sub> standards at

150 µg/m<sup>3</sup>. As of December 5, 2013, over 11 million people live in the 40 areas that are designated as nonattainment for the PM<sub>10</sub> NAAQS. There are 33 full or partial counties that make up the PM<sub>10</sub> nonattainment areas.

## 3. Oxides of Nitrogen and Sulfur

### a. Background

Nitrogen dioxide (NO<sub>2</sub>) is a member of the NO<sub>x</sub> family of gases. Most NO<sub>2</sub> is formed in the air through the oxidation of nitric oxide (NO) emitted when fuel is burned at a high temperature. Sulfur dioxide (SO<sub>2</sub>), a member of the sulfur oxide (SO<sub>x</sub>) family of gases, is formed from burning fuels containing sulfur (e.g., coal or oil derived), extracting gasoline from oil, or extracting metals from ore.

SO<sub>2</sub> and NO<sub>2</sub> and their gas phase oxidation products can dissolve in water droplets and further oxidize to form sulfuric and nitric acid which react with ammonia to form sulfates and nitrates, both of which are important components of ambient PM. The health effects of ambient PM are discussed in Section II.B.2.b of this preamble. NO<sub>x</sub> and VOC are the two major precursors of ozone. The health effects of ozone are covered in Section II.B.2.1.b.

### b. Health Effects of NO<sub>2</sub>

The most recent review of the health effects of oxides of nitrogen completed by the EPA can be found in the 2008 Integrated Science Assessment for Nitrogen Oxides (NO<sub>x</sub> ISA).<sup>67</sup> The EPA concluded that the findings of epidemiologic, controlled human exposure, and animal toxicological studies provide evidence that is sufficient to infer a likely causal relationship between respiratory effects and short-term NO<sub>2</sub> exposure. The 2008 NO<sub>x</sub> ISA concluded that the strongest evidence for such a relationship comes from epidemiologic studies of respiratory effects including increased respiratory symptoms, emergency department visits, and hospital admissions. Based on both short- and long-term exposure studies, the 2008 NO<sub>x</sub> ISA concluded that individuals with preexisting pulmonary conditions (e.g., asthma or COPD), children, and older adults are potentially at greater risk of NO<sub>2</sub>-related respiratory effects. Based on findings from controlled human exposure studies, the 2008 NO<sub>x</sub> ISA also drew two broad conclusions regarding airway responsiveness following NO<sub>2</sub> exposure. First, the NO<sub>x</sub>

<sup>60</sup> U.S. EPA. (2009). Integrated Science Assessment for Particulate Matter (Final Report). U.S. Environmental Protection Agency, Washington, DC, EPA/600/R-08/139F. Section 2.3.5 and Table 2–6.

<sup>61</sup> 78 FR 3121 (January 15, 2013).

<sup>62</sup> U.S. EPA (2012). National Ambient Air Quality Standards for Particulate Matter. <http://www.epa.gov/PM2012/finalrule.pdf>. 78 FR 3164.

<sup>63</sup> 70 FR 19844 (April 14, 2005).

<sup>64</sup> U.S. EPA (2012). Fact Sheet: Implementing the Standards. <http://www.epa.gov/airquality/particlepollution/2012/decfsimp.pdf>.

<sup>65</sup> 74 FR 58688 (November 13, 2009) and 76 FR 6056 (February 3, 2011).

<sup>66</sup> Data come from Summary Nonattainment Area Population Exposure Report, current as of July 31, 2013 at: <http://www.epa.gov/oar/oaqps/greenbk/popexp.html> and contained in Docket EPA–HQ–OAR–2011–0135.

<sup>67</sup> U.S. EPA (2008). *Integrated Science Assessment for Oxides of Nitrogen—Health Criteria (Final Report)*. EPA/600/R-08/071. Washington, DC: U.S. EPA.

ISA concluded that NO<sub>2</sub> exposure may enhance the sensitivity to allergen-induced decrements in lung function and increase the allergen-induced airway inflammatory response following 30-minute exposures of asthmatic adults to NO<sub>2</sub> concentrations as low as 260 ppb. Second, exposure to NO<sub>2</sub> has been found to enhance the inherent responsiveness of the airway to subsequent nonspecific challenges in controlled human exposure studies of healthy and asthmatic adults. Small but statistically significant increases in nonspecific airway hyperresponsiveness were reported for asthmatic adults following 30-minute exposures to 200–300 ppb NO<sub>2</sub> and following 1-hour exposures of asthmatics to 100 ppb NO<sub>2</sub>. Enhanced airway responsiveness could have important clinical implications for asthmatics since transient increases in airway responsiveness following NO<sub>2</sub> exposure have the potential to increase symptoms and worsen asthma control. Together, the epidemiologic and experimental data sets form a plausible, consistent, and coherent description of a relationship between NO<sub>2</sub> exposures and an array of adverse health effects that range from the onset of respiratory symptoms to hospital admission.

In evaluating a broader range of health effects, the 2008 NO<sub>x</sub> ISA concluded evidence was “suggestive but not sufficient to infer a causal relationship” between short-term NO<sub>2</sub> exposure and premature mortality and between long-term NO<sub>2</sub> exposure and respiratory effects. The latter was based largely on associations observed between long-term NO<sub>2</sub> exposure and decreases in lung function growth in children. Furthermore, the 2008 NO<sub>x</sub> ISA concluded that evidence was “inadequate to infer the presence or absence of a causal relationship” between short-term NO<sub>2</sub> exposure and cardiovascular effects as well as between long-term NO<sub>2</sub> exposure and cardiovascular effects, reproductive and developmental effects, premature mortality, and cancer.<sup>68</sup> The conclusions for these health effect categories were informed by uncertainties in the evidence base such as the independent effects of NO<sub>2</sub> exposure within the broader mixture of traffic-related pollutants, limited evidence from experimental studies, and/or an overall limited literature base.

<sup>68</sup> U.S. EPA (2008). *Integrated Science Assessment for Oxides of Nitrogen—Health Criteria (Final Report)*. EPA/600/R-08/071. Washington, DC: U.S. EPA.

#### c. Health Effects of SO<sub>2</sub>

Information on the health effects of SO<sub>2</sub> can be found in the 2008 Integrated Science Assessment for Sulfur Oxides (SO<sub>2</sub> ISA).<sup>69</sup> Short-term peaks of SO<sub>2</sub> have long been known to cause adverse respiratory health effects, particularly among individuals with asthma. In addition to those with asthma (both children and adults), potentially sensitive groups include all children and the elderly. During periods of elevated ventilation, asthmatics may experience symptomatic bronchoconstriction within minutes of exposure. Following an extensive evaluation of health evidence from epidemiologic and laboratory studies, the EPA concluded that there is a causal relationship between respiratory health effects and short-term exposure to SO<sub>2</sub>. Separately, based on an evaluation of the epidemiologic evidence of associations between short-term exposure to SO<sub>2</sub> and mortality, the EPA concluded that the overall evidence is suggestive of a causal relationship between short-term exposure to SO<sub>2</sub> and mortality.

#### d. Current Concentrations of NO<sub>2</sub>

The EPA most recently completed a review of the primary NAAQS for NO<sub>2</sub> in January 2010. There are two primary NAAQS for NO<sub>2</sub>: an annual standard (53 ppb) and a 1-hour standard (100 ppb). The EPA promulgated area designations in the **Federal Register** on February 17, 2012. In this initial round of designations, all areas of the country were designated as “unclassifiable/attainment” for the 2010 NO<sub>2</sub> NAAQS based on data from the existing air quality monitoring network. The EPA and state agencies are working to establish an expanded network of NO<sub>2</sub> monitors, expected to be deployed in the 2014–2017 time frame. Once three years of air quality data have been collected from the expanded network, the EPA will be able to evaluate NO<sub>2</sub> air quality in additional locations.<sup>70 71</sup>

#### e. Current Concentrations of SO<sub>2</sub>

The EPA most recently completed a review of the primary SO<sub>2</sub> NAAQS in

<sup>69</sup> U.S. EPA. (2008). *Integrated Science Assessment (ISA) for Sulfur Oxides—Health Criteria (Final Report)*. EPA/600/R-08/047F. Washington, DC: U.S. Environmental Protection Agency.

<sup>70</sup> U.S. EPA. (2012). Fact Sheet—Air Quality Designations for the 2010 Primary Nitrogen Dioxide (NO<sub>2</sub>) National Ambient Air Quality Standards. <http://www.epa.gov/airquality/nitrogenoxides/designations/pdfs/20120120FS.pdf>.

<sup>71</sup> U.S. Environmental Protection Agency (2013). Revision to Ambient Nitrogen Dioxide Monitoring Requirements. March 7, 2013. <http://www.epa.gov/airquality/nitrogenoxides/pdfs/20130307fr.pdf>.

June 2010. The current primary NAAQS for SO<sub>2</sub> is a 1-hour standard of 75 ppb. The EPA finalized the initial area designations for 29 nonattainment areas in 16 states in a notice published in the **Federal Register** on August 5, 2013. In this first round of designations, EPA only designated nonattainment areas that were violating the standard based on existing air quality monitoring data provided by the states. The Agency did not have sufficient information to designate any area as “attainment” or make final decisions about areas for which additional modeling or monitoring is needed (78 FR 47191, August 5, 2013). EPA anticipates designating areas for the revised SO<sub>2</sub> standard in multiple rounds.

#### 4. Carbon Monoxide

Carbon monoxide (CO) is a colorless, odorless gas emitted from combustion processes. Nationally and, particularly in urban areas, the majority of CO emissions to ambient air come from mobile sources.

##### a. Health Effects of Carbon Monoxide

Information on the health effects of CO can be found in the January 2010 Integrated Science Assessment for Carbon Monoxide (CO ISA).<sup>72</sup> The CO ISA concludes that ambient concentrations of CO are associated with a number of adverse health effects.<sup>73</sup> This section provides a summary of the health effects associated with exposure to ambient concentrations of CO.<sup>74</sup>

Controlled human exposure studies of subjects with coronary artery disease show a decrease in the time to onset of exercise-induced angina (chest pain) and electrocardiogram changes following CO exposure. In addition, epidemiologic studies show associations between short-term CO exposure and cardiovascular morbidity, particularly increased emergency room visits and hospital admissions for coronary heart

<sup>72</sup> U.S. EPA. (2010). *Integrated Science Assessment for Carbon Monoxide (Final Report)*. U.S. Environmental Protection Agency, Washington, DC, EPA/600/R-09/019F, 2010. Available at <http://cfpub.epa.gov/ncea/cfm/recordisplay.cfm?deid=218686>.

<sup>73</sup> The ISA evaluates the health evidence associated with different health effects, assigning one of five “weight of evidence” determinations: causal relationship, likely to be a causal relationship, suggestive of a causal relationship, inadequate to infer a causal relationship, and not likely to be a causal relationship. For definitions of these levels of evidence, please refer to Section 1.6 of the ISA.

<sup>74</sup> Personal exposure includes contributions from many sources, and in many different environments. Total personal exposure to CO includes both ambient and nonambient components; and both components may contribute to adverse health effects.

disease (including ischemic heart disease, myocardial infarction, and angina). Some epidemiologic evidence is also available for increased hospital admissions and emergency room visits for congestive heart failure and cardiovascular disease as a whole. The CO ISA concludes that a causal relationship is likely to exist between short-term exposures to CO and cardiovascular morbidity. It also concludes that available data are inadequate to conclude that a causal relationship exists between long-term exposures to CO and cardiovascular morbidity.

Animal studies show various neurological effects with in-utero CO exposure. Controlled human exposure studies report central nervous system and behavioral effects following low-level CO exposures, although the findings have not been consistent across all studies. The CO ISA concludes the evidence is suggestive of a causal relationship with both short- and long-term exposure to CO and central nervous system effects.

A number of studies cited in the CO ISA have evaluated the role of CO exposure in birth outcomes such as preterm birth or cardiac birth defects. The epidemiologic studies provide limited evidence of a CO-induced effect on preterm births and birth defects, with weak evidence for a decrease in birth weight. Animal toxicological studies have found perinatal CO exposure to affect birth weight, as well as other developmental outcomes. The CO ISA concludes the evidence is suggestive of a causal relationship between long-term exposures to CO and developmental effects and birth outcomes.

Epidemiologic studies provide evidence of associations between ambient CO concentrations and respiratory morbidity such as changes in pulmonary function, respiratory symptoms, and hospital admissions. A limited number of epidemiologic studies considered copollutants such as ozone, SO<sub>2</sub>, and PM in two-pollutant models and found that CO risk estimates were generally robust, although this limited evidence makes it difficult to disentangle effects attributed to CO itself from those of the larger complex air pollution mixture. Controlled human exposure studies have not extensively evaluated the effect of CO on respiratory morbidity. Animal studies at levels of 50–100 ppm CO show preliminary evidence of altered pulmonary vascular remodeling and oxidative injury. The CO ISA concludes that the evidence is suggestive of a causal relationship between short-term CO exposure and respiratory morbidity, and inadequate to

conclude that a causal relationship exists between long-term exposure and respiratory morbidity.

Finally, the CO ISA concludes that the epidemiologic evidence is suggestive of a causal relationship between short-term concentrations of CO and mortality. Epidemiologic studies provide evidence of an association between short-term exposure to CO and mortality, but limited evidence is available to evaluate cause-specific mortality outcomes associated with CO exposure. In addition, the attenuation of CO risk estimates which was often observed in copollutant models contributes to the uncertainty as to whether CO is acting alone or as an indicator for other combustion-related pollutants. The CO ISA also concludes that there is not likely to be a causal relationship between relevant long-term exposures to CO and mortality.

#### b. Current Concentrations of CO

There are two NAAQS for CO: an 8-hour standard (9 ppm) and a 1-hour standard (35 ppm). The primary NAAQS for CO were retained in August 2011. There are currently no CO nonattainment areas; as of September 27, 2010, all CO nonattainment areas were redesignated to maintenance areas. The designations were based on the existing community-wide monitoring network. EPA is making changes to the ambient air monitoring requirements for CO. The new requirements are expected to result in approximately 52 CO monitors operating near roads within 52 urban areas by January 2015 (76 FR 54294, August 31, 2011).

#### 5. Mobile Source Air Toxics

Light-duty vehicle emissions contribute to ambient levels of air toxics known or suspected as human or animal carcinogens, or that have noncancer health effects. The population experiences an elevated risk of cancer and other noncancer health effects from exposure to the class of pollutants known collectively as “air toxics.”<sup>75</sup> These compounds include, but are not limited to, benzene, 1,3-butadiene, formaldehyde, acetaldehyde, acrolein, polycyclic organic matter, and naphthalene. These compounds were identified as national or regional risk drivers or contributors in the 2005 National-scale Air Toxics Assessment

<sup>75</sup> U.S. EPA. (2011) Summary of Results for the 2005 National-Scale Assessment. [www.epa.gov/ttn/atw/nata2005/05pdf/sum\\_results.pdf](http://www.epa.gov/ttn/atw/nata2005/05pdf/sum_results.pdf).

and have significant inventory contributions from mobile sources.<sup>76</sup>

#### a. Health Effects of Air Toxics

##### i. Benzene

The EPA's Integrated Risk Information System (IRIS) database lists benzene as a known human carcinogen (causing leukemia) by all routes of exposure, and concludes that exposure is associated with additional health effects, including genetic changes in both humans and animals and increased proliferation of bone marrow cells in mice.<sup>77 78 79</sup> EPA states in its IRIS database that data indicate a causal relationship between benzene exposure and acute lymphocytic leukemia and suggest a relationship between benzene exposure and chronic non-lymphocytic leukemia and chronic lymphocytic leukemia. EPA's IRIS documentation for benzene also lists a range of  $2.2 \times 10^{-6}$  to  $7.8 \times 10^{-6}$  as the unit risk estimate (URE) for benzene.<sup>80 81</sup> The International Agency for Research on Carcinogens (IARC) has determined that benzene is a human carcinogen and the U.S. Department of Health and Human Services (DHHS) has characterized benzene as a known human carcinogen.<sup>82 83</sup>

A number of adverse noncancer health effects including blood disorders, such as preleukemia and aplastic anemia, have also been associated with

<sup>76</sup> U.S. EPA (2011) 2005 National-Scale Air Toxics Assessment. <http://www.epa.gov/ttn/atw/nata2005>.

<sup>77</sup> U.S. EPA. (2000). Integrated Risk Information System File for Benzene. This material is available electronically at: <http://www.epa.gov/iris/subst/0276.htm>.

<sup>78</sup> International Agency for Research on Cancer, IARC monographs on the evaluation of carcinogenic risk of chemicals to humans, Volume 29, Some industrial chemicals and dyestuffs, International Agency for Research on Cancer, World Health Organization, Lyon, France 1982.

<sup>79</sup> Irons, R.D.; Stillman, W.S.; Colagiovanni, D.B.; Henry, V.A. (1992). Synergistic action of the benzene metabolite hydroquinone on myelopoietic stimulating activity of granulocyte/macrophage colony-stimulating factor in vitro. *Proc. Natl. Acad. Sci.* 89:3691–3695.

<sup>80</sup> A unit risk estimate is defined as the increase in the lifetime risk of an individual who is exposed for a lifetime to 1 µg/m<sup>3</sup> benzene in air.

<sup>81</sup> U.S. EPA. (2000). Integrated Risk Information System File for Benzene. This material is available electronically at: <http://www.epa.gov/iris/subst/0276.htm>.

<sup>82</sup> International Agency for Research on Cancer (IARC). (1987). Monographs on the evaluation of carcinogenic risk of chemicals to humans, Volume 29, Supplement 7, Some industrial chemicals and dyestuffs, World Health Organization, Lyon, France.

<sup>83</sup> U.S. Department of Health and Human Services National Toxicology Program. (2011). 12th Report on Carcinogens. Available at: <http://ntp.niehs.nih.gov/?objectid=03C9AF75-E1BF-FF40-DBA9EC0928DF8B15>.

long-term exposure to benzene.<sup>84 85</sup> The most sensitive noncancer effect observed in humans, based on current data, is the depression of the absolute lymphocyte count in blood.<sup>86 87</sup> EPA's inhalation reference concentration (RfC) for benzene is 30 µg/m<sup>3</sup>. The RfC is based on suppressed absolute lymphocyte counts seen in humans under occupational exposure conditions. In addition, recent work, including studies sponsored by the Health Effects Institute, provides evidence that biochemical responses are occurring at lower levels of benzene exposure than previously known.<sup>88 89 90 91</sup> EPA's IRIS program has not yet evaluated these new data. EPA does not currently have an acute reference concentration for benzene. The Agency for Toxic Substances and Disease Registry (ATSDR) Minimal Risk Level (MRL) for acute exposure to benzene is 29 µg/m<sup>3</sup> for 1–14 days exposure.<sup>92 93</sup>

## ii. Formaldehyde

In 1991, EPA concluded that formaldehyde is a carcinogen based on

nasal tumors in animal bioassays.<sup>94</sup> An Inhalation Unit Risk for cancer and a Reference Dose for oral noncancer effects were developed by the Agency and posted on the IRIS database. Since that time, the National Toxicology Program (NTP) and International Agency for Research on Cancer (IARC) have concluded that formaldehyde is a known human carcinogen.<sup>95 96 97</sup>

The conclusions by IARC and NTP reflect the results of epidemiologic research published since 1991 in combination with previous animal, human and mechanistic evidence. Research conducted by the National Cancer Institute reported an increased risk of nasopharyngeal cancer and specific lymphohematopoietic malignancies among workers exposed to formaldehyde.<sup>98 99 100</sup> A National Institute of Occupational Safety and Health study of garment workers also reported increased risk of death due to leukemia among workers exposed to formaldehyde.<sup>101</sup> Extended follow-up of a cohort of British chemical workers did not report evidence of an increase in nasopharyngeal or lymphohematopoietic cancers, but a continuing statistically significant excess in lung cancers was reported.<sup>102</sup> Finally, a study of embalmers reported formaldehyde exposures to be associated with an increased risk of

myeloid leukemia but not brain cancer.<sup>103</sup>

Health effects of formaldehyde in addition to cancer were reviewed by the Agency for Toxic Substances and Disease Registry in 1999<sup>104</sup> and supplemented in 2010,<sup>105</sup> and by the World Health Organization.<sup>106</sup> These organizations reviewed the literature concerning effects on the eyes and respiratory system, the primary point of contact for inhaled formaldehyde, including sensory irritation of eyes and respiratory tract, pulmonary function, nasal histopathology, and immune system effects. In addition, research on reproductive and developmental effects and neurological effects were discussed.

EPA released a draft Toxicological Review of Formaldehyde—Inhalation Assessment through the IRIS program for peer review by the National Research Council (NRC) and public comment in June 2010.<sup>107</sup> The draft assessment reviewed more recent research from animal and human studies on cancer and other health effects. The NRC released their review report in April 2011.<sup>108</sup> The EPA is currently revising the draft assessment in response to this review.

## iii. Acetaldehyde

Acetaldehyde is classified in EPA's IRIS database as a probable human carcinogen, based on nasal tumors in rats, and is considered toxic by the inhalation, oral, and intravenous routes.<sup>109</sup> The URE in IRIS for

<sup>84</sup> Aksoy, M. (1989). Hematotoxicity and carcinogenicity of benzene. *Environ. Health Perspect.* 82: 193–197.

<sup>85</sup> Goldstein, B.D. (1988). Benzene toxicity. *Occupational medicine. State of the Art Reviews.* 3: 541–554.

<sup>86</sup> Rothman, N., G.L. Li, M. Dosemeci, W.E. Bechtold, G.E. Marti, Y.Z. Wang, M. Linet, L.Q. Xi, W. Lu, M.T. Smith, N. Titenko-Holland, L.P. Zhang, W. Blot, S.N. Yin, and R.B. Hayes. (1996). Hematotoxicity among Chinese workers heavily exposed to benzene. *Am. J. Ind. Med.* 29: 236–246.

<sup>87</sup> U.S. EPA. (2002). *Toxicological Review of Benzene (Noncancer Effects)*. Environmental Protection Agency, Integrated Risk Information System (IRIS), Research and Development, National Center for Environmental Assessment, Washington DC. This material is available electronically at <http://www.epa.gov/iris/subst/0276.htm>.

<sup>88</sup> Qu, O.; Shore, R.; Li, G.; Jin, X.; Chen, C.L.; Cohen, B.; Melikian, A.; Eastmond, D.; Rappaport, S.; Li, H.; Rupa, D.; Suramaya, R.; Songnian, W.; Huifant, Y.; Meng, M.; Winnik, M.; Kwok, E.; Li, Y.; Mu, R.; Xu, B.; Zhang, X.; Li, K. (2003). HEI Report 115, Validation & Evaluation of Biomarkers in Workers Exposed to Benzene in China.

<sup>89</sup> Qu, Q., R. Shore, G. Li, X. Jin, L.C. Chen, B. Cohen, et al. (2002). Hematological changes among Chinese workers with a broad range of benzene exposures. *Am. J. Industr. Med.* 42: 275–285.

<sup>90</sup> Lan, Qing, Zhang, L., Li, G., Vermeulen, R., et al. (2004). Hematotoxicity in Workers Exposed to Low Levels of Benzene. *Science* 306: 1774–1776.

<sup>91</sup> Turtletaub, K.W. and Mani, C. (2003). Benzene metabolism in rodents at doses relevant to human exposure from Urban Air. *Research Reports Health Effect Inst. Report No.113*.

<sup>92</sup> U.S. Agency for Toxic Substances and Disease Registry (ATSDR). (2007). *Toxicological profile for benzene*. Atlanta, GA: U.S. Department of Health and Human Services, Public Health Service. <http://www.atsdr.cdc.gov/ToxProfiles/tp3.pdf>.

<sup>93</sup> A minimal risk level (MRL) is defined as an estimate of the daily human exposure to a hazardous substance that is likely to be without appreciable risk of adverse noncancer health effects over a specified duration of exposure.

<sup>94</sup> EPA. Integrated Risk Information System. Formaldehyde (CASRN 50–00–0) <http://www.epa.gov/iris/subst/0419/htm>.

<sup>95</sup> National Toxicology Program, U.S. Department of Health and Human Services (HHS), 12th Report on Carcinogens, June 10, 2011.

<sup>96</sup> IARC Monographs on the Evaluation of Carcinogenic Risks to Humans Volume 88 (2006): Formaldehyde, 2-Butoxyethanol and 1-tert-Butoxypropan-2-ol.

<sup>97</sup> IARC Monographs on the Evaluation of Carcinogenic Risks to Humans Volume 100F (2012): Formaldehyde.

<sup>98</sup> Hauptmann, M.; Lubin, J. H.; Stewart, P. A.; Hayes, R. B.; Blair, A. 2003. Mortality from lymphohematopoietic malignancies among workers in formaldehyde industries. *Journal of the National Cancer Institute* 95: 1615–1623.

<sup>99</sup> Hauptmann, M.; Lubin, J. H.; Stewart, P. A.; Hayes, R. B.; Blair, A. 2004. Mortality from solid cancers among workers in formaldehyde industries. *American Journal of Epidemiology* 159: 1117–1130.

<sup>100</sup> Beane Freeman, L. E.; Blair, A.; Lubin, J. H.; Stewart, P. A.; Hayes, R. B.; Hoover, R. N.; Hauptmann, M. 2009. Mortality from lymphohematopoietic malignancies among workers in formaldehyde industries: The National Cancer Institute cohort. *J. National Cancer Inst.* 101: 751–761.

<sup>101</sup> Pinkerton, L. E. 2004. Mortality among a cohort of garment workers exposed to formaldehyde: an update. *Occup. Environ. Med.* 61: 193–200.

<sup>102</sup> Coggon, D., EC Harris, J Poole, KT Palmer. 2003. Extended follow-up of a cohort of British chemical workers exposed to formaldehyde. *J National Cancer Inst.* 95:1608–1615.

<sup>103</sup> Hauptmann, M.; Stewart P. A.; Lubin J. H.; Beane Freeman, L. E.; Hornung, R. W.; Herrick, R. F.; Hoover, R. N.; Fraumeni, J. F.; Hayes, R. B. 2009. Mortality from lymphohematopoietic malignancies and brain cancer among embalmers exposed to formaldehyde. *Journal of the National Cancer Institute* 101:1696–1708.

<sup>104</sup> ATSDR. 1999. *Toxicological Profile for Formaldehyde*. U.S. Department of Health and Human Services (HHS), July 1999.

<sup>105</sup> ATSDR. 2010. *Addendum to the Toxicological Profile for Formaldehyde*. U.S. Department of Health and Human Services (HHS), October 2010.

<sup>106</sup> IPCS. 2002. *Concise International Chemical Assessment Document 40. Formaldehyde*. World Health Organization.

<sup>107</sup> EPA (U.S. Environmental Protection Agency). 2010. *Toxicological Review of Formaldehyde (CAS No. 50–00–0)—Inhalation Assessment: In Support of Summary Information on the Integrated Risk Information System (IRIS)*. External Review Draft. EPA/635/R–10/002A. U.S. Environmental Protection Agency, Washington DC [online]. Available: [http://cfpub.epa.gov/ncea/irs\\_drats/recdisplay.cfm?deid=223614](http://cfpub.epa.gov/ncea/irs_drats/recdisplay.cfm?deid=223614).

<sup>108</sup> NRC (National Research Council). 2011. *Review of the Environmental Protection Agency's Draft IRIS Assessment of Formaldehyde*. Washington DC: National Academies Press. [http://books.nap.edu/openbook.php?record\\_id=13142](http://books.nap.edu/openbook.php?record_id=13142).

<sup>109</sup> U.S. EPA (1991). *Integrated Risk Information System File of Acetaldehyde*. Research and Development, National Center for Environmental Assessment, Washington, DC. This material is available electronically at <http://www.epa.gov/iris/subst/0290.htm>.

acetaldehyde is  $2.2 \times 10^{-6}$  per  $\mu\text{g}/\text{m}^3$ .<sup>110</sup> Acetaldehyde is reasonably anticipated to be a human carcinogen by the U.S. DHHS in the 12th Report on Carcinogens and is classified as possibly carcinogenic to humans (Group 2B) by the IARC.<sup>111</sup> EPA is currently conducting a reassessment of cancer risk from inhalation exposure to acetaldehyde.

The primary noncancer effects of exposure to acetaldehyde vapors include irritation of the eyes, skin, and respiratory tract.<sup>113</sup> In short-term (4 week) rat studies, degeneration of olfactory epithelium was observed at various concentration levels of acetaldehyde exposure.<sup>114</sup> Data from these studies were used by EPA to develop an inhalation reference concentration of  $9 \mu\text{g}/\text{m}^3$ . Some asthmatics have been shown to be a sensitive subpopulation to decrements in functional expiratory volume (FEV1 test) and bronchoconstriction upon acetaldehyde inhalation.<sup>116</sup> The agency is currently conducting a reassessment of the health hazards from inhalation exposure to acetaldehyde.

#### iv. Acrolein

EPA most recently evaluated the toxicological and health effects literature related to acrolein in 2003 and concluded that the human carcinogenic potential of acrolein could not be determined because the available data were inadequate. No information was available on the carcinogenic effects of acrolein in humans and the animal data provided inadequate evidence of

carcinogenicity.<sup>117</sup> The IARC determined in 1995 that acrolein was not classifiable as to its carcinogenicity in humans.<sup>118</sup>

Lesions to the lungs and upper respiratory tract of rats, rabbits, and hamsters have been observed after subchronic exposure to acrolein.<sup>119</sup> The Agency has developed an RfC for acrolein of  $0.02 \mu\text{g}/\text{m}^3$  and an RfD of  $0.5 \mu\text{g}/\text{kg}\text{-day}$ .<sup>120</sup> EPA is considering updating the acrolein assessment with data that have become available since the 2003 assessment was completed.

Acrolein is extremely acrid and irritating to humans when inhaled, with acute exposure resulting in upper respiratory tract irritation, mucus hypersecretion and congestion. The intense irritancy of this carbonyl has been demonstrated during controlled tests in human subjects, who suffer intolerable eye and nasal mucosal sensory reactions within minutes of exposure.<sup>121</sup> These data and additional studies regarding acute effects of human exposure to acrolein are summarized in EPA's 2003 IRIS Human Health Assessment for acrolein.<sup>122</sup> Studies in humans indicate that levels as low as 0.09 ppm ( $0.21 \text{ mg}/\text{m}^3$ ) for five minutes may elicit subjective complaints of eye irritation with increasing concentrations leading to more extensive eye, nose and respiratory symptoms. Acute exposures in animal studies report bronchial hyper-responsiveness. Based on animal

data (more pronounced respiratory irritancy in mice with allergic airway disease in comparison to non-diseased mice<sup>123</sup>) and demonstration of similar effects in humans (e.g., reduction in respiratory rate), individuals with compromised respiratory function (e.g., emphysema, asthma) are expected to be at increased risk of developing adverse responses to strong respiratory irritants such as acrolein. EPA does not currently have an acute reference concentration for acrolein. The available health effect reference values for acrolein have been summarized by EPA and include an ATSDR MRL for acute exposure to acrolein of  $7 \mu\text{g}/\text{m}^3$  for 1–14 days exposure; and Reference Exposure Level (REL) values from the California Office of Environmental Health Hazard Assessment (OEHHA) for one-hour and 8-hour exposures of  $2.5 \mu\text{g}/\text{m}^3$  and  $0.7 \mu\text{g}/\text{m}^3$ , respectively.<sup>124</sup>

#### v. 1,3-Butadiene

EPA has characterized 1,3-butadiene as carcinogenic to humans by inhalation.<sup>125</sup> The IARC has determined that 1,3-butadiene is a human carcinogen and the U.S. DHHS has characterized 1,3-butadiene as a known human carcinogen.<sup>127</sup>

<sup>123</sup> Morris JB, Symanowicz PT, Olsen JE, et al. (2003). Immediate sensory nerve-mediated respiratory responses to irritants in healthy and allergic airway-diseased mice. *J Appl Physiol* 94(4):1563–1571.

<sup>124</sup> U.S. EPA. (2009). Graphical Arrays of Chemical-Specific Health Effect Reference Values for Inhalation Exposures (Final Report). U.S. Environmental Protection Agency, Washington, DC. EPA/600/R-09/061, 2009. <http://cfpub.epa.gov/ncea/cfm/recordisplay.cfm?deid=211003>.

<sup>125</sup> U.S. EPA. (2002). Health Assessment of 1,3-Butadiene. Office of Research and Development, National Center for Environmental Assessment, Washington Office, Washington, DC. Report No. EPA600-P-98-001F. This document is available electronically at <http://www.epa.gov/iris/supdocs/buta-sup.pdf>.

<sup>126</sup> U.S. EPA. (2002). "Full IRIS Summary for 1,3-butadiene (CASRN 106–99–0)" Environmental Protection Agency, Integrated Risk Information System (IRIS), Research and Development, National Center for Environmental Assessment, Washington, DC <http://www.epa.gov/iris/subst/0139.htm>.

<sup>127</sup> International Agency for Research on Cancer (IARC). (1999). Monographs on the evaluation of carcinogenic risk of chemicals to humans, Volume 71, Re-evaluation of some organic chemicals, hydrazine and hydrogen peroxide and Volume 97 (in preparation), World Health Organization, Lyon, France.

<sup>128</sup> International Agency for Research on Cancer (IARC). (2008). Monographs on the evaluation of carcinogenic risk of chemicals to humans, 1,3-Butadiene, Ethylene Oxide and Vinyl Halides (Vinyl Fluoride, Vinyl Chloride and Vinyl Bromide) Volume 97, World Health Organization, Lyon, France.

<sup>129</sup> NTP. (2011). Report on Carcinogens, Twelfth Edition. Research Triangle Park, NC: U.S. Department of Health and Human Services, Public Health Service, National Toxicology Program. 499 pp.

<sup>110</sup> U.S. EPA (1991). Integrated Risk Information System File of Acetaldehyde. This material is available electronically at <http://www.epa.gov/iris/subst/0290.htm>.

<sup>111</sup> NTP. (2011). Report on Carcinogens, Twelfth Edition. Research Triangle Park, NC: U.S. Department of Health and Human Services, Public Health Service, National Toxicology Program. 499 pp.

<sup>112</sup> International Agency for Research on Cancer (IARC). (1999). Re-evaluation of some organic chemicals, hydrazine, and hydrogen peroxide. IARC Monographs on the Evaluation of Carcinogenic Risk of Chemical to Humans, Vol 71. Lyon, France.

<sup>113</sup> U.S. EPA (1991). Integrated Risk Information System File of Acetaldehyde. This material is available electronically at <http://www.epa.gov/iris/subst/0290.htm>.

<sup>114</sup> U.S. EPA. (2003). Integrated Risk Information System File of Acrolein. Research and Development, National Center for Environmental Assessment, Washington, DC. This material is available electronically at <http://www.epa.gov/iris/subst/0364.htm>.

<sup>115</sup> Appleman, L.M., R.A. Woutersen, and V.J. Feron. (1982). Inhalation toxicity of acetaldehyde in rats. I. Acute and subacute studies. *Toxicology*. 23: 293–297.

<sup>116</sup> Myou, S.; Fujimura, M.; Nishi K.; Ohka, T.; and Matsuda, T. (1993) Aerosolized acetaldehyde induces histamine-mediated bronchoconstriction in asthmatics. *Am. Rev. Respir. Dis.* 148(4 Pt 1): 940–943.

<sup>117</sup> U.S. EPA. (2003). Integrated Risk Information System File of Acrolein. Research and Development, National Center for Environmental Assessment, Washington, DC. This material is available at <http://www.epa.gov/iris/subst/0364.htm>.

<sup>118</sup> International Agency for Research on Cancer (IARC). (1995). Monographs on the evaluation of carcinogenic risk of chemicals to humans, Volume 63. Dry cleaning, some chlorinated solvents and other industrial chemicals. World Health Organization, Lyon, France.

<sup>119</sup> U.S. EPA. (2003). Integrated Risk Information System File of Acrolein. Office of Research and Development, National Center for Environmental Assessment, Washington, DC. This material is available at <http://www.epa.gov/iris/subst/0364.htm>.

<sup>120</sup> U.S. EPA. (2003). Integrated Risk Information System File of Acrolein. Office of Research and Development, National Center for Environmental Assessment, Washington, DC. This material is available at <http://www.epa.gov/iris/subst/0364.htm>.

<sup>121</sup> U.S. EPA. (2003) Toxicological review of acrolein in support of summary information on Integrated Risk Information System (IRIS) National Center for Environmental Assessment, Washington, DC. EPA/635/R-03/003. p. 10. Available online at: <http://www.epa.gov/ncea/iris/toxreviews/0364tr.pdf>.

<sup>122</sup> U.S. EPA. (2003) Toxicological review of acrolein in support of summary information on Integrated Risk Information System (IRIS) National Center for Environmental Assessment, Washington, DC. EPA/635/R-03/003. Available online at: <http://www.epa.gov/ncea/iris/toxreviews/0364tr.pdf>.



There are numerous studies consistently demonstrating that 1,3-butadiene is metabolized into genotoxic metabolites by experimental animals and humans. The specific mechanisms of 1,3-butadiene-induced carcinogenesis are unknown; however, the scientific evidence strongly suggests that the carcinogenic effects are mediated by genotoxic metabolites. Animal data suggest that females may be more sensitive than males for cancer effects associated with 1,3-butadiene exposure; there are insufficient data in humans from which to draw conclusions about sensitive subpopulations. The URE for 1,3-butadiene is  $3 \times 10^{-5}$  per  $\mu\text{g}/\text{m}^3$ .<sup>130</sup> 1,3-butadiene also causes a variety of reproductive and developmental effects in mice; no human data on these effects are available. The most sensitive effect was ovarian atrophy observed in a lifetime bioassay of female mice.<sup>131</sup> Based on this critical effect and the benchmark concentration methodology, an RFC for chronic health effects was calculated at 0.9 ppb (approximately  $2 \mu\text{g}/\text{m}^3$ ).

#### vi. Ethanol

EPA is planning to develop an assessment of the health effects of exposure to ethanol, a compound which is not currently listed on EPA's IRIS database. Extensive health effects data are available for ingestion of ethanol, while data on inhalation exposure effects are sparse. In developing the assessment, EPA is evaluating pharmacokinetic models as a means of extrapolating across species (animal to human) and across exposure routes (oral to inhalation) to better characterize the health hazards and dose-response relationships for low levels of ethanol exposure in the environment.

#### vii. Polycyclic Organic Matter

The term polycyclic organic matter (POM) defines a broad class of compounds that includes the polycyclic aromatic hydrocarbon compounds (PAHs). One of these compounds, naphthalene, is discussed separately below. POM compounds are formed primarily from combustion and are present in the atmosphere in gas and particulate form. Cancer is the major concern from exposure to POM. Epidemiologic studies have reported an

increase in lung cancer in humans exposed to diesel exhaust, coke oven emissions, roofing tar emissions, and cigarette smoke; all of these mixtures contain POM compounds.<sup>132 133</sup> Animal studies have reported respiratory tract tumors from inhalation exposure to benzo[a]pyrene and alimentary tract and liver tumors from oral exposure to benzo[a]pyrene.<sup>134</sup> In 1997 EPA classified seven PAHs (benzo[a]pyrene, benz[a]anthracene, chrysene, benzo[b]fluoranthene, benzo[k]fluoranthene, dibenz[a,h]anthracene, and indeno[1,2,3-cd]pyrene) as Group B2, probable human carcinogens.<sup>135</sup> Since that time, studies have found that maternal exposures to PAHs in a population of pregnant women were associated with several adverse birth outcomes, including low birth weight and reduced length at birth, as well as impaired cognitive development in preschool children (3 years of age).<sup>136 137</sup> These and similar studies are being evaluated as a part of the ongoing IRIS assessment of health effects associated with exposure to benzo[a]pyrene.

#### viii. Naphthalene

Naphthalene is found in small quantities in gasoline and diesel fuels. Naphthalene emissions have been measured in larger quantities in both gasoline and diesel exhaust compared with evaporative emissions from mobile sources, indicating it is primarily a product of combustion. Acute (short-term) exposure of humans to

naphthalene by inhalation, ingestion, or dermal contact is associated with hemolytic anemia and damage to the liver and the nervous system.<sup>138</sup> Chronic (long term) exposure of workers and rodents to naphthalene has been reported to cause cataracts and retinal damage.<sup>139</sup> EPA released an external review draft of a reassessment of the inhalation carcinogenicity of naphthalene based on a number of recent animal carcinogenicity studies.<sup>140</sup> The draft reassessment completed external peer review.<sup>141</sup> Based on external peer review comments received, a revised draft assessment that considers all routes of exposure, as well as cancer and noncancer effects, is under development. The external review draft does not represent official agency opinion and was released solely for the purposes of external peer review and public comment. The National Toxicology Program listed naphthalene as "reasonably anticipated to be a human carcinogen" in 2004 on the basis of bioassays reporting clear evidence of carcinogenicity in rats and some evidence of carcinogenicity in mice.<sup>142</sup> California EPA has released a new risk assessment for naphthalene, and the IARC has reevaluated naphthalene and re-classified it as Group 2B: possibly carcinogenic to humans.<sup>143</sup> Naphthalene also causes a number of chronic non-cancer effects in animals,

<sup>138</sup> U.S. EPA. 1998. Toxicological Review of Naphthalene (Reassessment of the Inhalation Cancer Risk), Environmental Protection Agency, Integrated Risk Information System, Research and Development, National Center for Environmental Assessment, Washington, DC. This material is available electronically at <http://www.epa.gov/iris/subst/0436.htm>.

<sup>139</sup> U.S. EPA. 1998. Toxicological Review of Naphthalene (Reassessment of the Inhalation Cancer Risk), Environmental Protection Agency, Integrated Risk Information System, Research and Development, National Center for Environmental Assessment, Washington, DC. This material is available electronically at <http://www.epa.gov/iris/subst/0436.htm>.

<sup>140</sup> U.S. EPA. (1998). Toxicological Review of Naphthalene (Reassessment of the Inhalation Cancer Risk), Environmental Protection Agency, Integrated Risk Information System, Research and Development, National Center for Environmental Assessment, Washington, DC. This material is available electronically at <http://www.epa.gov/iris/subst/0436.htm>.

<sup>141</sup> Oak Ridge Institute for Science and Education. (2004). External Peer Review for the IRIS Reassessment of the Inhalation Carcinogenicity of Naphthalene. August 2004. <http://cfpub.epa.gov/ncea/cfm/recordisplay.cfm?deid=84403>.

<sup>142</sup> NTP. (2011). Report on Carcinogens, Twelfth Edition. Research Triangle Park, NC: U.S. Department of Health and Human Services, Public Health Service, National Toxicology Program. 499 pp.

<sup>143</sup> International Agency for Research on Cancer (IARC). (2002). Monographs on the Evaluation of the Carcinogenic Risk of Chemicals for Humans. Vol. 82. Lyon, France.

<sup>132</sup> Agency for Toxic Substances and Disease Registry (ATSDR). (1995). Toxicological profile for Polycyclic Aromatic Hydrocarbons (PAHs). Atlanta, GA: U.S. Department of Health and Human Services, Public Health Service. Available electronically at <http://www.atsdr.cdc.gov/ToxProfiles/TP.asp?id=122&tid=25>.

<sup>133</sup> U.S. EPA (2002). *Health Assessment Document for Diesel Engine Exhaust*. EPA/600/8-90/057F Office of Research and Development, Washington DC. <http://cfpub.epa.gov/ncea/cfm/recordisplay.cfm?deid=29060>.

<sup>134</sup> International Agency for Research on Cancer (IARC). (2012). Monographs on the Evaluation of the Carcinogenic Risk of Chemicals for Humans, Chemical Agents and Related Occupations. Vol. 100F. Lyon, France.

<sup>135</sup> U.S. EPA (1997). Integrated Risk Information System File of indeno[1,2,3-cd]pyrene. Research and Development, National Center for Environmental Assessment, Washington, DC. This material is available electronically at <http://www.epa.gov/ncea/iris/subst/0457.htm>.

<sup>136</sup> Perera, F.P.; Rauh, V.; Tsai, W.-Y.; et al. (2002). Effect of transplacental exposure to environmental pollutants on birth outcomes in a multiethnic population. *Environ Health Perspect.* 111: 201–205.

<sup>137</sup> Perera, F.P.; Rauh, V.; Whyatt, R.M.; Tsai, W.Y.; Tang, D.; Diaz, D.; Hoepner, L.; Barr, D.; Tu, Y.H.; Camann, D.; Kinney, P. (2006). Effect of prenatal exposure to airborne polycyclic aromatic hydrocarbons on neurodevelopment in the first 3 years of life among inner-city children. *Environ Health Perspect* 114: 1287–1292.

<sup>130</sup> U.S. EPA. (2002). "Full IRIS Summary for 1,3-butadiene (CASRN 106-99-0)" Environmental Protection Agency, Integrated Risk Information System (IRIS), Research and Development, National Center for Environmental Assessment, Washington, DC. <http://www.epa.gov/iris/subst/0139.htm>.

<sup>131</sup> Bevan, C.; Stadler, J.C.; Elliot, G.S.; et al. (1996). Subchronic toxicity of 4-vinylcyclohexene in rats and mice by inhalation. *Fundam. Appl. Toxicol.* 32:1–10.



including abnormal cell changes and growth in respiratory and nasal tissues.<sup>144</sup> The current EPA IRIS assessment includes noncancer data on hyperplasia and metaplasia in nasal tissue that form the basis of the inhalation RfC of 3  $\mu\text{g}/\text{m}^3$ .<sup>145</sup> The ATSDR MRL for acute exposure to naphthalene is 0.6 mg/kg/day.

#### ix. Other Air Toxics

In addition to the compounds described above, other compounds in gaseous hydrocarbon and PM emissions from motor vehicles will be affected by this action. Mobile source air toxic compounds that will potentially be impacted include ethylbenzene, propionaldehyde, toluene, and xylene. Information regarding the health effects of these compounds can be found in EPA's IRIS database.<sup>146</sup>

#### b. Current Concentrations of Air Toxics

The most recent available data indicate that the majority of Americans continue to be exposed to ambient concentrations of air toxics at levels which have the potential to cause adverse health effects.<sup>147</sup> The levels of air toxics to which people are exposed vary depending on where people live and work and the kinds of activities in which they engage, as discussed in detail in U.S. EPA's most recent Mobile Source Air Toxics Rule.<sup>148</sup> According to the National Air Toxic Assessment (NATA) for 2005,<sup>149</sup> mobile sources were responsible for 43 percent of outdoor toxic emissions and over 50 percent of the cancer risk and noncancer hazard associated with primary emissions. Mobile sources are also large contributors to precursor emissions which react to form secondary concentrations of air toxics. Formaldehyde is the largest contributor to cancer risk of all 80 pollutants

quantitatively assessed in the 2005 NATA. Mobile sources were responsible for over 40 percent of primary emissions of this pollutant in 2005, and are major contributors to formaldehyde precursor emissions. Benzene is also a large contributor to cancer risk, and mobile sources account for over 70 percent of ambient exposure. Over the years, EPA has implemented a number of mobile source and fuel controls which have resulted in VOC reductions, which also reduced formaldehyde, benzene and other air toxic emissions.

#### 6. Near-Roadway Pollution

Locations in close proximity to major roadways generally have elevated concentrations of many air pollutants emitted from motor vehicles. Hundreds of such studies have been published in peer-reviewed journals, concluding that concentrations of CO, NO, NO<sub>2</sub>, benzene, aldehydes, particulate matter, black carbon, and many other compounds are elevated in ambient air within approximately 300–600 meters (about 1,000–2,000 feet) of major roadways. Highest concentrations of most pollutants emitted directly by motor vehicles are found at locations within 50 meters (about 165 feet) of the edge of a roadway's traffic lanes.

A recent large-scale review of air quality measurements in vicinity of major roadways between 1978 and 2008 concluded that the pollutants with the steepest concentration gradients in vicinities of roadways were CO, ultrafine particles, metals, elemental carbon (EC), NO, NO<sub>x</sub>, and several VOCs.<sup>150</sup> These pollutants showed a large reduction in concentrations within 100 meters downwind of the roadway. Pollutants that showed more gradual reductions with distance from roadways included benzene, NO<sub>2</sub>, PM<sub>2.5</sub>, and PM<sub>10</sub>. In the review article, results varied based on the method of statistical analysis used to determine the trend.

For pollutants with relatively high background concentrations relative to near-road concentrations, detecting concentration gradients can be difficult. For example, many aldehydes have high background concentrations as a result of photochemical breakdown of precursors from many different organic compounds. This can make detection of gradients around roadways and other primary emission sources difficult. However, several studies have measured aldehydes in multiple weather conditions, and found higher

concentrations of many carbonyls downwind of roadways.<sup>151, thmsp:152</sup> These findings suggest a substantial roadway source of these carbonyls.

In the past 15 years, many studies have been published with results reporting that populations who live, work, or go to school near high-traffic roadways experience higher rates of numerous adverse health effects, compared to populations far away from major roads.<sup>153</sup> In addition, numerous studies have found adverse health effects associated with spending time in traffic, such as commuting or walking along high-traffic roadways.<sup>154 155 156 157</sup> The health outcomes with the strongest evidence linking them with traffic-associated air pollutants are respiratory effects, particularly in asthmatic children, and cardiovascular effects. Numerous reviews of this body of health literature have been published as well. In 2010, an expert panel of the Health Effects Institute (HEI) published a review of hundreds of exposure, epidemiology, and toxicology studies.<sup>158</sup> The panel rated how the evidence for each type of health outcome supported a conclusion of a causal association with traffic-associated air pollution as either "sufficient," "suggestive but not sufficient," or "inadequate and

<sup>151</sup> Liu, W.; Zhang, J.; Kwon, J.I.; et al. (2006). Concentrations and source characteristics of airborne carbonyl compounds measured outside urban residences. *J Air Waste Manage Assoc* 56: 1196–1204.

<sup>152</sup> Cahill, T.M.; Charles, M.J.; Seaman, V.Y. (2010). Development and application of a sensitive method to determine concentrations of acrolein and other carbonyls in ambient air. *Health Effects Institute Research Report* 149. Available at <http://dx.doi.org>.

<sup>153</sup> In the widely-used PubMed database of health publications, between January 1, 1990 and August 18, 2011, 605 publications contained the keywords "traffic, pollution, epidemiology," with approximately half the studies published after 2007.

<sup>154</sup> Laden, F.; Hart, J.E.; Smith, T.J.; Davis, M.E.; Garshick, E. (2007) Cause-specific mortality in the unionized U.S. trucking industry. *Environmental Health Perspect* 115:1192–1196.

<sup>155</sup> Peters, A.; von Klot, S.; Heier, M.; Trentinaglia, I.; Hörmann, A.; Wichmann, H.E.; Löwel, H. (2004) Exposure to traffic and the onset of myocardial infarction. *New England J Med* 351: 1721–1730.

<sup>156</sup> Zanobetti, A.; Stone, P.H.; Spelzer, F.E.; Schwartz, J.D.; Coull, B.A.; Suh, H.H.; Nearing, B.D.; Mittleman, M.A.; Verrier, R.L.; Gold, D.R. (2009) T-wave alternans, air pollution and traffic in high-risk subjects. *Am J Cardiol* 104: 665–670.

<sup>157</sup> Dubowsky Adar, S.; Adamkiewicz, G.; Gold, D.R.; Schwartz, J.; Coull, B.A.; Suh, H. (2007) Ambient and microenvironmental particles and exhaled nitric oxide before and after a group bus trip. *Environ Health Perspect* 115: 507–512.

<sup>158</sup> Health Effects Institute Panel on the Health Effects of Traffic-Related Air Pollution. (2010). *Traffic-related air pollution: a critical review of the literature on emissions, exposure, and health effects*. HEI Special Report 17. Available at <http://www.healtheffects.org>.

<sup>144</sup> U.S. EPA. (1998). *Toxicological Review of Naphthalene*. Environmental Protection Agency, Integrated Risk Information System, Research and Development, National Center for Environmental Assessment, Washington, DC. This material is available electronically at <http://www.epa.gov/iris/subst/0436.htm>.

<sup>145</sup> U.S. EPA. (1998). *Toxicological Review of Naphthalene*. Environmental Protection Agency, Integrated Risk Information System (IRIS), Research and Development, National Center for Environmental Assessment, Washington, DC <http://www.epa.gov/iris/subst/0436.htm>.

<sup>146</sup> U.S. EPA Integrated Risk Information System (IRIS) database is available at: [www.epa.gov/iris](http://www.epa.gov/iris).

<sup>147</sup> U.S. EPA. (2011) Summary of Results for the 2005 National-Scale Assessment. [www.epa.gov/ttn/atw/nata2005/05pdf/sum\\_results.pdf](http://www.epa.gov/ttn/atw/nata2005/05pdf/sum_results.pdf).

<sup>148</sup> U.S. Environmental Protection Agency (2007). *Control of Hazardous Air Pollutants from Mobile Sources; Final Rule*. 72 FR 8434, February 26, 2007.

<sup>149</sup> U.S. EPA. (2011). 2005 National-Scale Air Toxics Assessment. <http://www.epa.gov/ttn/atw/nata2005/>.

<sup>150</sup> Karner, A.A.; Eisinger, D.S.; Niemeier, D.A. (2010). Near-roadway air quality: synthesizing the findings from real-world data. *Environ Sci Technol* 44: 5334–5344.

insufficient.” The panel categorized evidence of a causal association for exacerbation of childhood asthma as “sufficient.” The panel categorized evidence of a causal association for new onset asthma as between “sufficient” and as “suggestive but not sufficient.” “Suggestive of a causal association” was how the panel categorized evidence linking traffic-associated air pollutants with exacerbation of adult respiratory symptoms and lung function decrement. It categorized as “inadequate and insufficient” evidence of a causal relationship between traffic-related air pollution and health care utilization for respiratory problems, new onset adult asthma, chronic obstructive pulmonary disease (COPD), nonasthmatic respiratory allergy, and cancer in adults and children. Other literature reviews have been published with conclusions similar to the HEI panel’s.<sup>159 160 161</sup> Health outcomes with few publications suggest the possibility of other effects still lacking sufficient evidence to draw definitive conclusions. Among these outcomes with a small number of positive studies are neurological impacts (e.g., autism and reduced cognitive function) and reproductive outcomes (e.g., preterm birth, low birth weight).<sup>162 163 164 165</sup>

In addition to health outcomes, particularly cardiopulmonary effects, conclusions of numerous studies suggest mechanisms by which traffic-related air pollution affects health. Numerous studies indicate that near-roadway exposures may increase systemic inflammation, affecting organ systems, including blood vessels and

lungs.<sup>166 167 168 169</sup> Long-term exposures in near-road environments have been associated with inflammation-associated conditions, such as atherosclerosis and asthma.<sup>170 171 172</sup>

Several studies suggest that some factors may increase susceptibility to the effects of traffic-associated air pollution. Several studies have found stronger respiratory associations in children experiencing chronic social stress, such as in violent neighborhoods or in homes with high family stress.<sup>173 174 175</sup>

The risks associated with residence, workplace, or schools near major roads are of potentially high public health significance due to the large population in such locations. According to the 2009 American Housing Survey, over 22 million homes (17.0 percent of all U.S. housing units) were located within 300 feet of an airport, railroad, or highway with four or more lanes. This corresponds to a population of more

than 50 million U.S. residents in close proximity to high-traffic roadways or other transportation sources. Based on 2010 Census data, a 2013 publication estimated that 19 percent of the U.S. population (over 59 million people) lived within 500 meters of roads with at least 25,000 annual average daily traffic (AADT), while about 3.2 percent of the population lived within 100 meters (about 300 feet) of such roads.<sup>176</sup> Another 2013 study estimated that 3.7 percent of the U.S. population (about 11.3 million people) lived within 150 meters (about 500 feet) of interstate highways, or other freeways and expressways.<sup>177</sup> As discussed in Section III, on average, populations near major roads have higher fractions of minority residents and lower socioeconomic status. Furthermore, on average, Americans spend more than an hour traveling each day, bringing nearly all residents into a high-exposure microenvironment for part of the day.

In light of these concerns, EPA has required and is working with states to ensure that air quality monitors be placed near high-traffic roadways for determining NAAQS compliance for CO, NO<sub>2</sub>, and PM<sub>2.5</sub> (in addition to those existing monitors located in neighborhoods and other locations farther away from pollution sources). Near-roadway monitors for NO<sub>2</sub> begin operation between 2014 and 2017 in Core Based Statistical Areas (CBSAs) with population of at least 500,000. Monitors for CO and PM<sub>2.5</sub> begin operation between 2015 and 2017. These monitors will further our understanding of exposure in these locations.

EPA continues to research near-road air quality, including the types of pollutants found in high concentrations near major roads and health problems associated with the mixture of pollutants near roads.

## 7. Environmental Impacts of Motor Vehicles and Fuels

### a. Plant and Ecosystem Effects of Ozone

The welfare effects of ozone can be observed across a variety of scales, i.e. subcellular, cellular, leaf, whole plant, population and ecosystem. Ozone effects that begin at small spatial scales, such as the leaf of an individual plant, when they occur at sufficient

<sup>159</sup>Boothe, V.L.; Shendell, D.G. (2008). Potential health effects associated with residential proximity to freeways and primary roads: review of scientific literature, 1999–2006. *J Environ Health* 70: 33–41.

<sup>160</sup>Salam, M.T.; Islam, T.; Gilliland, F.D. (2008). Recent evidence for adverse effects of residential proximity to traffic sources on asthma. *Curr Opin Pulm Med* 14: 3–8.

<sup>161</sup>Raaschou-Nielsen, O.; Reynolds, P. (2006). Air pollution and childhood cancer: a review of the epidemiological literature. *Int J Cancer* 118: 2920–9.

<sup>162</sup>Volk, H.E.; Hertz-Picciotto, I.; Delwiche, L.; et al. (2011). Residential proximity to freeways and autism in the CHARGE study. *Environ Health Perspect* 119: 873–877.

<sup>163</sup>Franco-Suglia, S.; Gryparis, A.; Wright, R.O.; et al. (2007). Association of black carbon with cognition among children in a prospective birth cohort study. *Am J Epidemiol*. doi: 10.1093/aje/kwm308. [Online at <http://dx.doi.org>]

<sup>164</sup>Power, M.C.; Weisskopf, M.G.; Alexeev, S.E.; et al. (2011). Traffic-related air pollution and cognitive function in a cohort of older men. *Environ Health Perspect* 2011: 682–687.

<sup>165</sup>Wu, J.; Wilhelm, M.; Chung, J.; et al. (2011). Comparing exposure assessment methods for traffic-related air pollution in an adverse pregnancy outcome study. *Environ Res* 111: 685–6692.

<sup>166</sup>Riediker, M. (2007). Cardiovascular effects of fine particulate matter components in highway patrol officers. *Inhal Toxicol* 19: 99–105. doi: 10.1080/08958370701495238 Available at <http://dx.doi.org>.

<sup>167</sup>Alexeev, S.E.; Coull, B.A.; Gryparis, A.; et al. (2011). Medium-term exposure to traffic-related air pollution and markers of inflammation and endothelial function. *Environ Health Perspect* 119: 481–486. doi:10.1289/ehp.1002560 Available at <http://dx.doi.org>.

<sup>168</sup>Eckel, S.P.; Berhane, K.; Salam, M.T.; et al. (2011). Traffic-related pollution exposure and exhaled nitric oxide in the Children’s Health Study. *Environ Health Perspect* (IN PRESS). doi:10.1289/ehp.1103516. Available at <http://dx.doi.org>.

<sup>169</sup>Zhang, J.; McCreanor, J.E.; Cullinan, P.; et al. (2009). Health effects of real-world exposure diesel exhaust in persons with asthma. *Res Rep Health Effects Inst* 138. [Online at <http://www.healtheffects.org>].

<sup>170</sup>Adar, S.D.; Klein, R.; Klein, E.K.; et al. (2010). Air pollution and the microvasculature: a cross-sectional assessment of in vivo retinal images in the population-based Multi-Ethnic Study of Atherosclerosis. *PLoS Med* 7(11): E1000372. doi:10.1371/journal.pmed.1000372. Available at <http://dx.doi.org>.

<sup>171</sup>Kan, H.; Heiss, G.; Rose, K.M.; et al. (2008). Prospective analysis of traffic exposure as a risk factor for incident coronary heart disease: the Atherosclerosis Risk in Communities (ARIC) study. *Environ Health Perspect* 116: 1463–1468. doi:10.1289/ehp.11290. Available at <http://dx.doi.org>.

<sup>172</sup>McConnell, R.; Islam, T.; Shankardass, K.; et al. (2010). Childhood incident asthma and traffic-related air pollution at home and school. *Environ Health Perspect* 1021–1026.

<sup>173</sup>Islam, T.; Urban, R.; Gauderman, W.J.; et al. (2011). Parental stress increases the detrimental effect of traffic exposure on children’s lung function. *Am J Respir Crit Care Med* (In press).

<sup>174</sup>Clougherty, J.E.; Levy, J.I.; Kubzansky, L.D.; et al. (2007). Synergistic effects of traffic-related air pollution and exposure to violence on urban asthma etiology. *Environ Health Perspect* 115: 1140–1146.

<sup>175</sup>Chen, E.; Schrier, H.M.; Strunk, R.C.; et al. (2008). Chronic traffic-related air pollution and stress interact to predict biologic and clinical outcomes in asthma. *Environ Health Perspect* 116: 970–5.

<sup>176</sup>Rowangould, G.M. (2013) A census of the U.S. near-roadway population: public health and environmental justice considerations. *Transportation Research Part D* 25: 59–67.

<sup>177</sup>Boehmer, T.K.; Foster, S.L.; Henry, J.R.; Woghiren-Akinnifesi, E.L.; Yip, F.Y. (2013) Residential proximity to major highways—United States, 2010. *Morbidity and Mortality Weekly Report* 62(3):46–50.

magnitudes (or to a sufficient degree) can result in effects being propagated along a continuum to larger and larger spatial scales. For example, effects at the individual plant level, such as altered rates of leaf gas exchange, growth and reproduction can, when widespread, result in broad changes in ecosystems, such as productivity, carbon storage, water cycling, nutrient cycling, and community composition.

Ozone can produce both acute and chronic injury in sensitive species depending on the concentration level and the duration of the exposure.<sup>178</sup> In those sensitive species,<sup>179</sup> effects from repeated exposure to ozone throughout the growing season of the plant tend to accumulate, so that even low concentrations experienced for a longer duration have the potential to create chronic stress on vegetation.<sup>180</sup> Ozone damage to sensitive species includes impaired photosynthesis and visible injury to leaves. The impairment of photosynthesis, the process by which the plant makes carbohydrates (its source of energy and food), can lead to reduced crop yields, timber production, and plant productivity and growth. Impaired photosynthesis can also lead to a reduction in root growth and carbohydrate storage below ground, resulting in other, more subtle plant and ecosystems impacts.<sup>181</sup> These latter impacts include increased susceptibility of plants to insect attack, disease, harsh weather, interspecies competition and overall decreased plant vigor. The adverse effects of ozone on areas with sensitive species could potentially lead to species shifts and loss from the affected ecosystems,<sup>182</sup> resulting in a loss or reduction in associated ecosystem goods and services. Additionally, visible ozone injury to leaves can result in a loss of aesthetic value in areas of special scenic significance like national parks and

wilderness areas and reduced use of sensitive ornamentals in landscaping.<sup>183</sup>

The Integrated Science Assessment (ISA) for Ozone presents more detailed information on how ozone affects vegetation and ecosystems.<sup>184</sup> The ISA concludes that ambient concentrations of ozone are associated with a number of adverse welfare effects and characterizes the weight of evidence for different effects associated with ozone.<sup>185</sup> The ISA concludes that visible foliar injury effects on vegetation, reduced vegetation growth, reduced productivity in terrestrial ecosystems, reduced yield and quality of agricultural crops, and alteration of below-ground biogeochemical cycles are causally associated with exposure to ozone. It also concludes that reduced carbon sequestration in terrestrial ecosystems, alteration of terrestrial ecosystem water cycling, and alteration of terrestrial community composition are likely to be causally associated with exposure to ozone.

#### b. Visibility

Visibility can be defined as the degree to which the atmosphere is transparent to visible light.<sup>186</sup> Visibility impairment is caused by light scattering and absorption by suspended particles and gases. Visibility is important because it has direct significance to people's enjoyment of daily activities in all parts of the country. Individuals value good visibility for the well-being it provides them directly, where they live and work, and in places where they enjoy recreational opportunities. Visibility is also highly valued in significant natural areas, such as national parks and wilderness areas, and special emphasis is given to protecting visibility in these areas. For more information on visibility see the final 2009 PM ISA.<sup>187</sup>

<sup>183</sup> 73 FR 16490/16497 (March 27, 2008).

<sup>184</sup> U.S. EPA. Integrated Science Assessment of Ozone and Related Photochemical Oxidants (Final Report). U.S. Environmental Protection Agency, Washington, DC, EPA/600/R-10/076F, 2013. The ISA is available at <http://cfpub.epa.gov/ncea/isa/recordisplay.cfm?deid=247492#Download>.

<sup>185</sup> The Ozone ISA evaluates the evidence associated with different ozone related health and welfare effects, assigning one of five "weight of evidence" determinations: Causal relationship, likely to be a causal relationship, suggestive of a causal relationship, inadequate to infer a causal relationship, and not likely to be a causal relationship. For more information on these levels of evidence, please refer to Table II of the ISA.

<sup>186</sup> National Research Council, (1993). Protecting Visibility in National Parks and Wilderness Areas. National Academy of Sciences Committee on Haze in National Parks and Wilderness Areas. National Academy Press, Washington, DC. This book can be viewed on the National Academy Press Web site at <http://www.nap.edu/books/0309048443/html/>.

<sup>187</sup> U.S. EPA. (2009). Integrated Science Assessment for Particulate Matter (Final Report).

EPA is working to address visibility impairment. In 1999, EPA finalized the regional haze program to protect the visibility in Mandatory Class I Federal areas.<sup>188</sup> There are 156 national parks, forests and wilderness areas categorized as Mandatory Class I Federal areas.<sup>189</sup> These areas are defined in CAA section 162 as those national parks exceeding 6,000 acres, wilderness areas and memorial parks exceeding 5,000 acres, and all international parks which were in existence on August 7, 1977. EPA has also concluded that PM<sub>2.5</sub> causes adverse effects on visibility in other areas that are not protected by the Regional Haze Rule, depending on PM<sub>2.5</sub> concentrations and other factors that control their visibility impact effectiveness such as dry chemical composition and relative humidity (i.e., an indicator of the water composition of the particles). EPA revised the PM<sub>2.5</sub> standards in December 2012 and established a target level of protection that is expected to be met through attainment of the existing secondary standards for PM<sub>2.5</sub>.

#### i. Current Visibility Levels

As mentioned in Section II.B.2.c, millions of people live in nonattainment areas for the PM<sub>2.5</sub> NAAQS. These populations, as well as large numbers of individuals who travel to these areas, are likely to experience visibility impairment. In addition, while visibility trends have improved in mandatory class I federal areas, the most recent data show that these areas continue to suffer from visibility impairment. In summary, visibility impairment is experienced throughout the U.S., in multi-state regions, urban areas, and remote mandatory class I federal areas.

#### c. Atmospheric Deposition

Wet and dry deposition of ambient particulate matter delivers a complex mixture of metals (e.g., mercury, zinc, lead, nickel, aluminum, cadmium), organic compounds (e.g., polycyclic organic matter, dioxins, furans) and inorganic compounds (e.g., nitrate, sulfate) to terrestrial and aquatic ecosystems. The chemical form of the compounds deposited depends on a variety of factors including ambient conditions (e.g., temperature, humidity, oxidant levels) and the sources of the material. Chemical and physical transformations of the compounds occur in the atmosphere as well as the media onto which they deposit. These

U.S. Environmental Protection Agency, Washington, DC, EPA/600/R-08/139F.

<sup>188</sup> 64 FR 35714 (July 1, 1999).

<sup>189</sup> 62 FR 38680-38681 (July 18, 1997).

<sup>178</sup> 73 FR 16486 (March 27, 2008).

<sup>179</sup> 73 FR 16491 (March 27, 2008). Only a small percentage of all the plant species growing within the U.S. (over 43,000 species have been catalogued in the USDA PLANTS database) have been studied with respect to ozone sensitivity.

<sup>180</sup> The concentration at which ozone levels overwhelm a plant's ability to detoxify or compensate for oxidant exposure varies. Thus, whether a plant is classified as sensitive or tolerant depends in part on the exposure levels being considered. Chapter 9, section 9.3.4 of U.S. EPA, 2013 Integrated Science Assessment for Ozone and Related Photochemical Oxidants. Office of Research and Development/National Center for Environmental Assessment. U.S. Environmental Protection Agency. EPA 600/R-10/076F.

<sup>181</sup> 73 FR 16492 (March 27, 2008).

<sup>182</sup> 73 FR 16493/16494 (March 27, 2008). Per footnote 2 above, ozone impacts could be occurring in areas where plant species sensitive to ozone have not yet been studied or identified.

transformations in turn influence the fate, bioavailability and potential toxicity of these compounds.

Atmospheric deposition has been identified as a key component of the environmental and human health hazard posed by several pollutants including mercury, dioxin and PCBs.<sup>190</sup>

Adverse impacts on water quality can occur when atmospheric contaminants deposit to the water surface or when material deposited on the land enters a waterbody through runoff. Potential impacts of atmospheric deposition to waterbodies include those related to both nutrient and toxic inputs. Adverse effects to human health and welfare can occur from the addition of excess nitrogen via atmospheric deposition. The nitrogen-nutrient enrichment contributes to toxic algae blooms and zones of depleted oxygen, which can lead to fish kills, frequently in coastal waters. Deposition of heavy metals or other toxics may lead to the human ingestion of contaminated fish, impairment of drinking water, damage to freshwater and marine ecosystem components, and limits to recreational uses. Several studies have been conducted in U.S. coastal waters and in the Great Lakes Region in which the role of ambient PM deposition and runoff is investigated.<sup>191 192 193 194 195</sup>

Atmospheric deposition of nitrogen and sulfur contributes to acidification, altering biogeochemistry and affecting animal and plant life in terrestrial and aquatic ecosystems across the United States. The sensitivity of terrestrial and aquatic ecosystems to acidification from nitrogen and sulfur deposition is predominantly governed by geology. Prolonged exposure to excess nitrogen and sulfur deposition in sensitive areas acidifies lakes, rivers and soils. Increased acidity in surface waters

creates inhospitable conditions for biota and affects the abundance and nutritional value of preferred prey species, threatening biodiversity and ecosystem function. Over time, acidifying deposition also removes essential nutrients from forest soils, depleting the capacity of soils to neutralize future acid loadings and negatively affecting forest sustainability. Major effects include a decline in sensitive forest tree species, such as red spruce (*Picea rubens*) and sugar maple (*Acer saccharum*), and a loss of biodiversity of fishes, zooplankton, and macro invertebrates.

In addition to the role nitrogen deposition plays in acidification, nitrogen deposition also leads to nutrient enrichment and altered biogeochemical cycling. In aquatic systems increased nitrogen can alter species assemblages and cause eutrophication. In terrestrial systems nitrogen loading can lead to loss of nitrogen sensitive lichen species, decreased biodiversity of grasslands, meadows and other sensitive habitats, and increased potential for invasive species. For a broader explanation of the topics treated here, refer to the description in Section 6.3.2 of the RIA.

Adverse impacts on soil chemistry and plant life have been observed for areas heavily influenced by atmospheric deposition of nutrients, metals and acid species, resulting in species shifts, loss of biodiversity, forest decline, damage to forest productivity and reductions in ecosystem services. Potential impacts also include adverse effects to human health through ingestion of contaminated vegetation or livestock (as in the case for dioxin deposition), reduction in crop yield, and limited use of land due to contamination.

Atmospheric deposition of pollutants can reduce the aesthetic appeal of buildings and culturally important articles through soiling, and can contribute directly (or in conjunction with other pollutants) to structural damage by means of corrosion or erosion. Atmospheric deposition may affect materials principally by promoting and accelerating the corrosion of metals, by degrading paints, and by deteriorating building materials such as concrete and limestone. Particles contribute to these effects because of their electrolytic, hygroscopic, and acidic properties, and their ability to adsorb corrosive gases (principally sulfur dioxide).

#### i. Current Nitrogen and Sulfur Deposition

Over the past two decades, the EPA has undertaken numerous efforts to

reduce nitrogen and sulfur deposition across the U.S. Analyses of long-term monitoring data for the U.S. show that deposition of both nitrogen and sulfur compounds has decreased over the last 19 years.<sup>196</sup> The data show that reductions were more substantial for sulfur compounds than for nitrogen compounds. In the eastern U.S., where data are most abundant, total sulfur deposition decreased by about 44 percent between 1990 and 2007, while total nitrogen deposition decreased by 25 percent over the same time frame.<sup>197</sup> These numbers are generated by the U.S. national monitoring network and they likely underestimate nitrogen deposition because neither ammonia nor organic nitrogen is measured. Although total nitrogen and sulfur deposition has decreased over time, many areas continue to be negatively impacted by deposition. Deposition of inorganic nitrogen and sulfur species routinely measured in the U.S. between 2005 and 2007 were as high as 9.6 kilograms of nitrogen per hectare (kg N/ha) averaged over three years and 20.8 kilograms of sulfur per hectare (kg S/ha) averaged over three years.<sup>198</sup>

#### d. Environmental Effects of Air Toxics

Emissions from producing, transporting and combusting fuel contribute to ambient levels of pollutants that contribute to adverse effects on vegetation. Volatile organic compounds, some of which are considered air toxics, have long been suspected to play a role in vegetation damage.<sup>199</sup> In laboratory experiments, a wide range of tolerance to VOCs has been observed.<sup>200</sup> Decreases in harvested seed pod weight have been reported for the more sensitive plants, and some studies have reported effects on seed germination, flowering and fruit ripening. Effects of individual VOCs or

<sup>190</sup> U.S. EPA. (2000). Deposition of Air Pollutants to the Great Waters: Third Report to Congress. Office of Air Quality Planning and Standards. EPA-453/R-00-0005.

<sup>191</sup> U.S. EPA. (2004). National Coastal Condition Report II. Office of Research and Development/Office of Water. EPA-620/R-03/002.

<sup>192</sup> Gao, Y., E.D. Nelson, M.P. Field, et al. (2002). Characterization of atmospheric trace elements on PM<sub>2.5</sub> particulate matter over the New York-New Jersey harbor estuary. *Atmos. Environ.* 36: 1077-1086.

<sup>193</sup> Kim, G., N. Hussain, J.R. Scudlark, and T.M. Church. (2000). Factors influencing the atmospheric depositional fluxes of stable Pb, <sup>210</sup>Pb, and <sup>7</sup>Be into Chesapeake Bay. *J. Atmos. Chem.* 36: 65-79.

<sup>194</sup> Lu, R., R.P. Turco, K. Stolzenbach, et al. (2003). Dry deposition of airborne trace metals on the Los Angeles Basin and adjacent coastal waters. *J. Geophys. Res.* 108(D2, 4074): AAC 11-1 to 11-24.

<sup>195</sup> Marvin, C.H., M.N. Charlton, E.J. Reiner, et al. (2002). Surficial sediment contamination in Lakes Erie and Ontario: A comparative analysis. *J. Great Lakes Res.* 28(3): 437-450.

<sup>196</sup> U.S. EPA. (2013). U.S. EPA's Report on the Environment. Data accessed online November 25, 2013 at: <http://cfpub.epa.gov/eroe/index.cfm?fuseaction=detail.viewInd&lv=list.listBySubTopic&r=216610&subtop=341&ch=46>.

<sup>197</sup> U.S. EPA. (2012). U.S. EPA's Report on the Environment. Data accessed online February 15, 2012 at: <http://cfpub.epa.gov/eroe/index.cfm?fuseaction=detail.viewPDF&ch=46&lShowInd=0&subtop=341&lv=list.listByChapter&r=216610>.

<sup>198</sup> U.S. EPA. (2012). U.S. EPA's Report on the Environment. Data accessed online February 15, 2012 at: <http://cfpub.epa.gov/eroe/index.cfm?fuseaction=detail.viewPDF&ch=46&lShowInd=0&subtop=341&lv=list.listByChapter&r=216610>.

<sup>199</sup> U.S. EPA. (1991). Effects of organic chemicals in the atmosphere on terrestrial plants. EPA/600/3-91/001.

<sup>200</sup> Cape JN, ID Leith, J Binnie, J Content, M Donkin, M Skewes, DN Price, AR Brown, AD Sharpe. (2003). Effects of VOCs on herbaceous plants in an open-top chamber experiment. *Environ. Pollut.* 124:341-343.

their role in conjunction with other stressors (e.g., acidification, drought, temperature extremes) have not been well studied. In a recent study of a mixture of VOCs including ethanol and toluene on herbaceous plants, significant effects on seed production, leaf water content and photosynthetic efficiency were reported for some plant species.<sup>201</sup>

Research suggests an adverse impact of vehicle exhaust on plants, which has in some cases been attributed to aromatic compounds and in other cases to nitrogen oxides.<sup>202 203 204</sup>

### III. How would this rule reduce emissions and air pollution?

#### A. Effects of the Vehicle and Fuel Changes on Mobile Source Emissions

The Tier 3 vehicle and fuel standards will significantly reduce the tailpipe and evaporative emissions of light- and heavy-duty vehicles in several ways, as described in this section. In addition, the gasoline sulfur standard will reduce emissions of SO<sub>2</sub> from existing gasoline-powered vehicles and equipment. As described in Section II, all of these emission reductions will in turn improve air quality nationwide and reduce the health effects associated with air pollution from mobile sources.

As with the Tier 2 program, EPA is implementing closely-coordinated requirements for both automakers and refiners in the same rulemaking action. The Tier 3 vehicle emission standards and gasoline sulfur standards represent a “systems approach” to reducing vehicle-related exhaust and evaporative emissions. By recognizing the relationships among the various sources of emissions addressed by this action, we have been able to integrate the provisions into a single, coordinated program.

1. How do vehicles produce the emissions addressed in this action?

The degree to which vehicles produce exhaust and evaporative emissions depends on the design and functionality of the engine and the associated exhaust

and evaporative emission controls, in concert with the properties of the fuel on which the vehicle is operating. In the following paragraphs, we discuss how light- and heavy-duty vehicles produce each of these types of emissions, both from the tailpipe and from the fuel system.

#### a. Tailpipe (Exhaust) Emissions

The pollutants emitted at the vehicle's tailpipe and their quantities depend on how the fuel is combusted in the engine and how the resulting gases are treated in the exhaust system. Historically, much of tailpipe emission control has focused on hydrocarbon compounds (HC) and NO<sub>x</sub>. The portion of hydrocarbons that is methane is minimally reactive in forming ozone. Thus, for emission control purposes, the focus is generally on non-methane hydrocarbons (NMHC), which are also expressed as non-methane organic gases (NMOG) in order to account for oxygenates (usually ethanol) now usually present in the fuel.

Tailpipe hydrocarbon emissions also include several toxic pollutants, including benzene, acetaldehyde, and formaldehyde. To varying degrees, the mass emissions of these pollutants are reduced along with other hydrocarbons by the catalytic converter and improved engine controls.

Light- and heavy-duty gasoline vehicles also emit PM and CO. PM forms directly as a combustion product (as elemental carbon or soot) and indirectly as semi-volatile hydrocarbon compounds that form particles in the exhaust system or soon after exiting the tailpipe. CO is a product of incomplete fuel combustion.

When operating properly, modern exhaust emission controls (centering on the catalytic converter) can reduce much of the HC (including toxics), NO<sub>x</sub> and CO exiting the engine. However, tailpipe emissions are increased during periods of vehicle startup, as catalytic converters must warm up to be effective; during subsequent operation due to the interference of sulfur in the gasoline; during high load operating events, as the catalyst is overwhelmed or its operation is modified to protect against permanent damage; and as a vehicle ages, as the catalyst degrades in performance due to the effects of high temperature operation and contaminants in the fuel and lubricating oil.

#### b. Evaporative Emissions

Gasoline vehicles also produce vapors in the fuel tank and fuel system that can be released as evaporative emissions. These vapors are primarily the lighter,

more volatile hydrocarbon compounds in gasoline. As discussed in Section IV below, vehicle evaporative (“evap”) control systems are designed to block or capture vapors as they are generated. Vapors are generated in the vehicle fuel tank and fuel system (and released to the atmosphere if not adequately controlled) as fuel heats up due to ambient temperature increase and/or vehicle operation. Fuel vapors are also released when they permeate through elastomers in the fuel system, when they leak at connections or due to damaged components, and during refueling events.

In general, the evap emission controls on current vehicles (and that will be improved under this action) consist of a canister filled with activated charcoal and connected by hoses to the fuel system. The hoses direct generated vapors to the canister, which collects the vapors on the carbon and stores them until the system experiences a “purge” event. During purge, the engine draws fresh air through the canister, carrying vapors released by the carbon to the engine to be combusted and restoring the capacity of the canister. Evaporative emissions occur when vapors are emitted to the atmosphere because the evap system is compromised, the carbon canister is overwhelmed, or vapors permeate or leak. As such, evaporative emission controls also involve proper material selection for fuel system components, careful design of these components, and onboard diagnostics to check the system for failure.

2. How will the changes to gasoline sulfur content affect vehicle emissions?

Gasoline vehicles rely on highly efficient aftertreatment catalysts to control tailpipe emissions of harmful pollutants like CO and NO<sub>x</sub>, as well as VOCs that include air toxics and precursor compounds to ozone and secondary PM in the atmosphere. These catalysts utilize finely-dispersed precious metals that are susceptible to deactivation by sulfur compounds in the exhaust. Studies have repeatedly demonstrated that the presence of even a tiny amount of sulfur in fuel has a measurable impact on the ability of the catalyst to control emissions, and that emission levels of most pollutants, especially NO<sub>x</sub>, are very sensitive to fuel sulfur.<sup>205 206</sup>

<sup>205</sup> The Effects of Ultra-Low Sulfur Gasoline on Emissions from Tier 2 Vehicles in the In-Use Fleet, EPA-420-R-14-002.

<sup>206</sup> Durbin, T., “The Effect of Fuel Sulfur on NH<sub>3</sub> and Other Emissions from 2000–2001 Model Year

<sup>201</sup> Cape JN, ID Leith, J Binnie, J Content, M Donkin, M Skewes, DN Price, AR Brown, AD Sharpe. (2003). Effects of VOCs on herbaceous plants in an open-top chamber experiment. *Environ. Pollut.* 124:341–343.

<sup>202</sup> Viskari E-L. (2000). Epicuticular wax of Norway spruce needles as indicator of traffic pollutant deposition. *Water, Air, and Soil Pollut.* 121:327–337.

<sup>203</sup> Ugrekhelidze D, F Korte, G Kvesitadze. (1997). Uptake and transformation of benzene and toluene by plant leaves. *Ecotox. Environ. Safety* 37:24–29.

<sup>204</sup> Kammerbauer H, H Selinger, R Rommelt, A Ziegler-Jons, D Knoppik, B Hock. (1987). Toxic components of motor vehicle emissions for the spruce *Picea abies*. *Environ. Pollut.* 48:235–243.

Sulfur naturally occurs in crude oil and is carried through the refining process into gasoline. EPA's Tier 2 rulemaking for light-duty vehicles, published in 2000, required refiners to reduce sulfur levels in gasoline to an average of 30 ppm, a reduction of about 90 percent from the in-use baseline. At the time, there were indications that sulfur reductions below 30 ppm may provide additional emission benefits. However, the data was insufficient to quantify the benefits to the existing fleet, and the Tier 2 vehicle standards could be achieved without lowering sulfur below 30 ppm.<sup>207</sup>

As discussed in Section IV.A.6, subsequent research provides a compelling case that even this level of sulfur degrades the emission performance of vehicles on the road today and inhibits necessary further reductions in vehicle emissions performance, which depend on optimum catalyst performance to reach emission targets. A study conducted by EPA and the auto industry in support of the Mobile Source Air Toxics (MSAT) rule found significant reductions in NO<sub>x</sub>, CO and total HC when nine Tier 2 vehicles were tested on ultra-low sulfur fuel.<sup>208</sup> In particular, the study found a 32 percent decrease in NO<sub>x</sub> when sulfur was reduced from 32 ppm to 6 ppm (equivalent to a 25 percent decrease if sulfur levels were reduced from 30 to 10 ppm, assuming a linear effect). Another recent study by Umicore showed reductions of 41 percent for NO<sub>x</sub> and 17 percent for hydrocarbons on a PZEV operating on fuel with 33 ppm and 3 ppm fuel (equivalent to reductions of 27 percent and 11 percent, respectively, if sulfur levels were reduced from 30 to 10 ppm, assuming a linear effect).<sup>209</sup>

A larger study of Tier 2 vehicles recently completed by EPA confirmed these results, showing significant reductions in FTP-composite NO<sub>x</sub> (14 percent), CO (10 percent) and total HC (15 percent) on the 5 ppm fuel, relative to 28 ppm fuel (equivalent to 12 percent, 9 percent, and 13 percent reduction, respectively, if sulfur levels were reduced from 30 to 10 ppm, assuming a linear effect).<sup>210</sup> For NO<sub>x</sub>,

the majority of overall reductions were driven by large reductions on warmed-up periods of the test cycle (Bag 2), which showed a 52 percent reduction using 5 ppm fuel relative to 28 ppm fuel (equivalent to 45 percent reduction if sulfur levels were reduced from 30 to 10 ppm, assuming a linear effect), consistent with the role of sulfur in catalyst degradation discussed above. For additional details regarding these results, please see Section IV.A.6.c.

Our application of these study results assumes a linear effect of sulfur level on catalyst efficiency between the high and low sulfur test fuels. This is reasonable given that the mass flow rate of sulfur in exhaust gas changes in proportion to its concentration in the fuel, and that the chemical kinetics of adsorption of sulfur to the precious metal sites is approximately first order. Linearity of effect is also supported by past studies with multiple fuel sulfur levels such as the CRC E-60 and 2000 AAM/AIAM/Oil Industry emission test programs.<sup>211 212</sup>

Based on these analyses, the benefits of the Tier 3 sulfur standard are significant in two ways: They enable vehicles designed to the Tier 3 tailpipe exhaust standards to meet these standards for the duration of their useful life, and they facilitate immediate emission reductions from all the vehicles on the road at the time the sulfur controls are implemented.

#### *B. How will emissions be reduced?*

The Tier 3 standards will reduce emissions of VOC, NO<sub>x</sub> (including NO<sub>2</sub>), direct PM<sub>2.5</sub>, CO, SO<sub>2</sub>, and air toxics. The sulfur standards will reduce emissions from the on-road fleet immediately upon implementation in calendar year 2017. The vehicle standards will begin to reduce emissions as the cleaner cars and trucks begin to enter the fleet in model year 2017 and model year 2018, respectively. The magnitude of reduction will grow as more Tier 3 vehicles enter the fleet. We present emission reductions in calendar year 2018 to reflect the early reductions expected from the Tier 3 standards, and in calendar year 2030, when 70 percent of the miles travelled are from vehicles that meet the fully phased-in Tier 3 standards. Although 2030 is the farthest year that is feasible for air quality modeling, the full

reduction of the vehicle program will be realized after 2030, when the fleet has fully turned over to vehicles that meet the fully phased-in Tier 3 standards; thus we present emission reductions projected in 2050 as well (see Chapter 7 of the RIA).

Emission reductions are estimated on an annual basis, for all 50 U.S. states plus the District of Columbia, Puerto Rico and the U.S. Virgin Islands. The reductions were estimated using a version of EPA's MOVES model updated for this analysis, as described in detail in Chapter 7 of the RIA. This version of MOVES includes our most recent data on how vehicle emissions are affected by changes in sulfur, ethanol, RVP, and other fuel properties. We estimated emission reductions compared to a reference case that assumed renewable fuel volumes and ethanol blends based on the U.S. Energy Information Administration's Annual Energy Outlook 2013 (AEO2013).<sup>213</sup> As described in Chapter 7 of the RIA, the reference and control scenarios based on AEO2013 reflect a mix of E10, E15, and E85 in both 2018 and 2030. The reference case assumed an average sulfur level of 30 ppm (10 ppm in California) and continuation of the Tier 2 vehicle program indefinitely, with the exception of California and Section 177 states that have adopted the LEV III program.

The analysis described here accounts for the following national onroad rules:

- Tier 2 Motor Vehicle Emissions Standards and Gasoline Sulfur Control Requirements (65 FR 6698, February 10, 2000)
- Heavy-Duty Engine and Vehicle Standards and Highway Diesel Fuel Sulfur Control Requirements (66 FR 5002, January 18, 2001)
- Mobile Source Air Toxics Rule (72 FR 8428, February 26, 2007)
- Regulation of Fuels and Fuel Additives: Changes to Renewable Fuel Standard Program (75 FR 14670, March 26, 2010)
- Light-Duty Vehicle Greenhouse Gas Emission Standards and Corporate Average Fuel Economy Standards for 2012–2016 (75 FR 25324, May 7, 2010)
- Greenhouse Gas Emissions Standards and Fuel Efficiency Standards for Medium- and Heavy-Duty Engines and Vehicles (76 FR 57106, September 15, 2011)
- 2017 and Later Model Year Light-Duty Vehicle Greenhouse Gas Emissions and Corporate Average Fuel Economy

Vehicles", May 2003. Published as Report E-60 by the Coordinating Research Council, Alpharetta, GA.

<sup>207</sup> 65 FR 6698 (February 10, 2000).

<sup>208</sup> Regulatory Impact Analysis for the Control of Hazardous Air Pollutants from Mobile Sources Final Rule, EPA 420-R-07-002, Chapter 6.

<sup>209</sup> Ball D., Clark D., Moser D. (2011), Effects of Fuel Sulfur on FTP NO<sub>x</sub> Emissions from a PZEV 4 Cylinder Application. SAE 2011 World Congress Paper 2011-01-0300.

<sup>210</sup> The Effects of Ultra-Low Sulfur Gasoline on Emissions from Tier 2 Vehicles in the In-Use Fleet, EPA-420-R-14-002.

<sup>211</sup> Durbin, T., "The Effect of Fuel Sulfur on NH<sub>3</sub> and Other Emissions from 2000–2001 Model Year Vehicles", May 2003. Published as Report E-60 by the Coordinating Research Council, Alpharetta, GA.

<sup>212</sup> "AAM/AIAM/Oil Industry Low Sulfur & Oxygenate Test Program", 2000, last accessed on 01/15/14 at the following URL: [http://www.arb.ca.gov/fuels/gasoline/carfg3/aam\\_prstn.pdf](http://www.arb.ca.gov/fuels/gasoline/carfg3/aam_prstn.pdf).

<sup>213</sup> U.S. Energy Information Administration, Annual Energy Outlook (April 15, 2013).

Standards (77 FR 62623, October 15, 2012)

The analysis also accounts for many other national rules and standards. In addition, the modeling accounts for state and local rules including California's most recent Low Emission Vehicle (LEV III) program adopted in California and twelve other states (also referred to as Section 177 states),<sup>214</sup> local fuel standards, Inspection/Maintenance programs, Stage II refueling controls, the National Low Emission Vehicle Program (NLEV), and the Section 177 states LEV and LEV II

programs. See the Tier 3 emissions modeling TSD for more detail.

A summary of emission reductions projected to result from Tier 3, relative to the reference case, is shown in calendar years 2018 and 2030 for NO<sub>x</sub>, VOC, direct PM<sub>2.5</sub>, CO, SO<sub>2</sub>, and total air toxics in Table III-1. For many pollutants, the immediate reductions in 2018 are significant; for example, combined NO<sub>x</sub> and VOC emissions will be reduced by over 300,000 tons. By 2030, combined NO<sub>x</sub> and VOC emissions will be reduced by roughly 500,000 tons, one quarter of the onroad inventory. Many of the modeled air toxics will be significantly reduced as

well, including benzene, 1,3-butadiene, acetaldehyde, acrolein and ethanol (ranging from 10 to nearly 30 percent of the national onroad inventory by 2030). The relative reduction in overall emissions will continue to increase beyond 2030 as more of the fleet continues to turn over to Tier 3 vehicles; for example, by 2050, when nearly all of the fleet will have turned over to vehicles meeting the fully phased-in Tier 3 standards, we estimate the Tier 3 program will reduce onroad emissions of NO<sub>x</sub> and VOC nearly 31 percent from the level of emissions projected without Tier 3 controls.

TABLE III-1—ESTIMATED EMISSION REDUCTIONS FROM THE TIER 3 STANDARDS  
[Annual U.S. short tons]

	2018		2030	
	Tons	% of Onroad inventory	Tons	% of Onroad inventory
NO <sub>x</sub> .....	264,369	10	328,509	25
VOC .....	47,504	3	167,591	16
CO .....	278,879	2	3,458,041	24
Direct PM <sub>2.5</sub> .....	130	0.1	7,892	10
Benzene .....	1,916	6	4,762	26
SO <sub>2</sub> .....	14,813	56	12,399	56
1,3-Butadiene .....	257	5	677	29
Formaldehyde .....	513	2	1,277	10
Acetaldehyde .....	600	3	2,067	21
Acrolein .....	40	3	127	15
Ethanol .....	2,704	2	19,950	16

Reductions for each pollutant are discussed in the following sections, focusing on the contribution of program elements to the total reductions summarized above.

1. NO<sub>x</sub>

The Tier 3 sulfur standards will significantly reduce NO<sub>x</sub> emissions immediately upon implementation of the program. As discussed above, recent research on the impact of sulfur on Tier 2 technology vehicles shows the potential for significant reductions in NO<sub>x</sub> emissions from the existing fleet of

Tier 2 vehicles by lowering sulfur levels to 10 ppm. Prior research shows that NO<sub>x</sub> emissions will also be expected to decrease from the fleet of older (pre-Tier 2) light-duty vehicles as well as heavy-duty gasoline vehicles,<sup>215</sup> although to a lesser extent than for Tier 2 vehicles.

Table III-2 shows the reduction in NO<sub>x</sub> emissions, in annual short tons, projected in calendar years 2018 and 2030. The reductions are split into those attributable to the introduction of low sulfur fuel in the pre-Tier 3 fleet (defined for this analysis as model years prior to 2017); and reductions

attributable to vehicle standards enabled by low sulfur fuel (model year 2017 and later). As shown, upon implementation of the Tier 3 sulfur standards, total onroad NO<sub>x</sub> emissions are projected to drop 10 percent. This is primarily due to large reductions from Tier 2 gasoline vehicles, which contribute about one-quarter of the NO<sub>x</sub> emissions from the on-road fleet in 2018. The relative reduction grows as cleaner vehicles turn over into the fleet. By 2030, we project that the reduction in overall onroad NO<sub>x</sub> inventory will be 25 percent.

TABLE III-2—PROJECTED NO<sub>x</sub> REDUCTIONS FROM TIER 3 PROGRAM  
[Annual U.S. tons]

	2018	2030
Total reduction .....	264,369	328,509
Reduction from pre-Tier 3 fleet due to sulfur standard .....	242,434	56,324
Reduction from Tier 3 fleet due to vehicle and sulfur standards .....	21,934	272,185
Percent reduction in onroad NO <sub>x</sub> emissions .....	10%	25%

<sup>214</sup> These states include Connecticut, Delaware, Maryland, Maine, Massachusetts, New Jersey, New

York, Oregon, Pennsylvania, Rhode Island, Washington, and Vermont.

<sup>215</sup> Rao, V. (2001), Fuel Sulfur Effects on Exhaust Emissions: Recommendations for MOBILE6, EPA-420-R-01-039.

2. VOC

Table III-3 shows the reduction in VOC emissions, in annual short tons, projected in calendar years 2018 and 2030 resulting from the Tier 3

standards. In 2018, as with NO<sub>x</sub>, we project reductions from the pre-Tier 3 fleet with the fuel standards. By 2030, the reduction in overall onroad VOC emissions will be 16 percent, the majority of this from the vehicles

meeting the fully phased-in Tier 3 standards. The evaporative standards are projected to account for roughly one third of the overall vehicle program reduction in 2030.

TABLE III-3—PROJECTED VOC REDUCTIONS FROM TIER 3 PROGRAM  
[Annual U.S. tons]

	2018	2030
Total reduction .....	47,504	167,591
Reduction from pre-Tier 3 fleet due to sulfur standard .....	38,786	11,249
Reduction from Tier 3 fleet due to vehicle and sulfur standards .....	8,718	156,343
Exhaust .....	43,009	105,253
Evaporative .....	4,495	62,339
Percent reduction in onroad VOC emissions .....	3%	16%

3. CO

Table III-4 shows the reductions for CO, broken down by pre- and post-Tier 3 in the manner described for NO<sub>x</sub> and

VOC above. In contrast to NO<sub>x</sub> and VOC, the immediate CO reductions in the onroad fleet from sulfur control in 2018 are small, based on research showing that fuel sulfur level has a

minimal impact on CO emissions from Tier 2 vehicles. The CO exhaust standards are projected to reduce onroad CO emissions by 24 percent in 2030.

TABLE III-4—PROJECTED CO REDUCTIONS FROM TIER 3 PROGRAM  
[Annual U.S. tons]

	2018	2030
Total reduction .....	278,879	3,458,041
Reduction from pre-Tier 3 fleet due to sulfur standard .....	122,171	17,734
Reduction from Tier 3 fleet due to vehicle and sulfur standards .....	156,708	3,440,307
Percent reduction in onroad CO emissions .....	2%	24%

4. Direct PM<sub>2.5</sub>

Reductions in direct emissions of PM<sub>2.5</sub> are projected to result solely from the vehicle tailpipe standards, so meaningful reductions are realized mainly as the fleet turns over. By 2030, we project a reduction of about 7,900 tons annually, which represents approximately 10 percent of the onroad direct PM<sub>2.5</sub> inventory. The relative reduction in onroad emissions is

projected to grow to 28 percent in 2050, when nearly all of the fleet will have turned over to vehicles meeting the fully phased-in Tier 3 standards. Reductions in NO<sub>x</sub> and VOC emissions will also reduce secondary PM formation, which is quantified as part of the air quality analysis described in Section III.C.

evaporative standards. Air toxics are generally a subset of compounds making up VOC, so the reduction trends tend to track the VOC reductions presented above, for most air toxics. Table III-5 presents reductions for certain key air toxics, and Table III-6 presents reductions for the sum of 71 different toxic compounds.

5. Air Toxics

Emissions of air toxics also will be reduced by the sulfur, exhaust and

TABLE III-5—REDUCTIONS FOR CERTAIN INDIVIDUAL COMPOUNDS  
[Annual U.S. tons]

	Tons reduced in 2018	% Reduction in onroad emissions	Tons reduced in 2030	% Reduction in onroad emissions
Benzene .....	1,916	6	4,762	26
Acetaldehyde .....	600	3	2,067	21
Formaldehyde .....	513	2	1,277	10
1,3-Butadiene .....	257	5	677	29
Acrolein .....	40	3	127	15
Naphthalene .....	99	3	269	15
Ethanol .....	2,704	2	19,950	16

The totals shown in Table III-6 represent the sum of 71 species including the toxics in Table III-5, 15 polycyclic aromatic hydrocarbon (PAH)

compounds in gas and particle phase, and additional gaseous compounds such as toluene, xylenes, styrene, hexane, 2,2,4-trimethylpentane, n-hexane, and

propionaldehyde (see Appendix 7A of the RIA). As shown, in 2030, the overall onroad inventory of total toxics will be reduced by 15 percent, with nearly one



half of the vehicle program reductions coming from the evaporative standards.

TABLE III-6—REDUCTIONS IN TOTAL MOBILE SOURCE AIR TOXICS  
[Annual U.S. tons]

	2018	2030
Total reduction .....	15,583	64,558
Reduction from pre-Tier 3 fleet due to sulfur standard .....	11,981	3,517
Reduction from Tier 3 fleet due to vehicle and sulfur standards .....	3,602	61,041
Exhaust .....	13,340	34,595
Evaporative .....	2,243	29,963
Percent reduction in onroad toxics emissions .....	3%	15%

6. SO<sub>2</sub>

SO<sub>2</sub> emissions from mobile sources are a direct function of sulfur in the fuel, and reducing sulfur in gasoline

will result in immediate reductions in SO<sub>2</sub> from the on and off-road fleet. The reductions, shown in Table III-7, are a function of the sulfur level and fuel consumption. This is reflected in the

relative contribution of on-road vehicles and off-road equipment, where off-road gasoline consumption accounts for approximately 5 percent of overall gasoline use.<sup>216</sup>

TABLE III-7—PROJECTED SO<sub>2</sub> REDUCTIONS FROM TIER 3 PROGRAM  
[Annual U.S. tons]

	2018	2030
Total reduction .....	15,565	13,261
Reduction from onroad vehicles due to sulfur standard .....	14,813	12,399
Reduction from off-road equipment due to sulfur standard .....	752	862
Percent reduction in onroad SO <sub>2</sub> emissions .....	56%	56%

7. Greenhouse Gases

Reductions in nitrous oxide (N<sub>2</sub>O) emissions and methane (CH<sub>4</sub>) emissions, both potent greenhouse gas emissions, are projected for gasoline cars and trucks as a result of the sulfur and tailpipe standards. A study conducted by the University of California-Riverside found a 29 percent reduction in N<sub>2</sub>O emissions over the FTP when sulfur was reduced from 30 to 5 ppm,<sup>217</sup> while EPA research described in Section IV.A.6 on sulfur effects found a 26 percent reduction in CH<sub>4</sub> emissions when sulfur was reduced from 28 to 5 ppm.<sup>218</sup>

Several studies have established correlations between reductions in tailpipe NO<sub>x</sub> emissions and reductions in N<sub>2</sub>O from gasoline cars and trucks,<sup>219 220 221 222</sup> as well as

correlations between reductions in tailpipe HC emissions and reductions in CH<sub>4</sub>.<sup>223 224</sup> Studies by Winer, et al (2005) and Behrentz et al (2004) reported N<sub>2</sub>O: NO<sub>x</sub> ratios of 0.06 and 0.095, respectively, and supported the application of N<sub>2</sub>O: NO<sub>x</sub> ratios to NO<sub>x</sub> emissions as a reasonable method for estimating N<sub>2</sub>O emission inventories. CARB has also used N<sub>2</sub>O: NO<sub>x</sub> ratio to develop the N<sub>2</sub>O emissions inventories for the LEV III program, based on a regression analysis suggesting N<sub>2</sub>O: NO<sub>x</sub> ratio of 0.04, on average.<sup>225</sup>

As detailed in Chapter 7.3 of the RIA, the N<sub>2</sub>O reductions are estimated by employing two different methodologies, resulting in a range of reductions. The first method applies the relationship between N<sub>2</sub>O and NO<sub>x</sub> from a regression

model<sup>226</sup> to NO<sub>x</sub> inventories from both Tier 3 and pre-Tier 3 vehicles. The second method applies the regression of N<sub>2</sub>O and NO<sub>x</sub> only to Tier 3 vehicles and uses the UC Riverside sulfur results to estimate the N<sub>2</sub>O reductions from pre-Tier 3 vehicles. Using a 100-year global warming potential of 298 for N<sub>2</sub>O according to the 2007 IPCC AR4,<sup>227</sup> the estimated N<sub>2</sub>O reduction is 2.2 million metric tons of carbon dioxide equivalent (MMTCO<sub>2e</sub>) in 2018, growing to the range between 3.8 to 4.0 MMTCO<sub>2e</sub> in 2030. For 2018, there was an agreement between the two methodologies described above, resulting in a single estimate. MOVES can be used to directly estimate CH<sub>4</sub> reductions from the sulfur and vehicle standards, estimating an additional 0.1 MMTCO<sub>2e</sub>

<sup>216</sup> U.S. Energy Information Administration, Annual Energy Outlook 2013 (April 15, 2013).

<sup>217</sup> Huai, et al. (2004), Estimates of the emission rates of nitrous oxide from light-duty vehicles using different chassis dynamometer test cycles, Atmospheric Environment 6621-6629

<sup>218</sup> The Effects of Ultra-Low Sulfur Gasoline on Emissions from Tier 2 Vehicles in the In-Use Fleet, EPA-420-R-14-002,

<sup>219</sup> Michaels, H. (1998) Emissions of Nitrous Oxide from Highway Mobile Sources, U.S. EPA EPA420-R-98-009.

<sup>220</sup> Behrentz, et al. (2004), Measurements of nitrous oxide emissions from light-duty motor vehicles: A pilot study, Atmospheric Environment 4291-4303.

<sup>221</sup> Meffert, et. al (2000) Analysis of Nitrous Oxide Emissions from Light Duty Passenger Cars, SAE 2000-01-1952.

<sup>222</sup> Winer, et al. (2005) Estimates of Nitrous Oxide Emissions and the Effects of Catalyst Composition and Aging, State of California Air Resources Board 02-313.

<sup>223</sup> Meszler, D. (2004), Light Duty Vehicle Methane and Nitrous Oxide Emissions: Greenhouse Gas Impacts, Study for Northeast States Center for a Clean Air Future.

<sup>224</sup> Graham, L., Greenhouse Gas Emissions from 1997-2005 Model Year Light Duty Vehicles, Environment Canada ERMD Report #04-44.

<sup>225</sup> LEV III Mobile Source Emissions Inventory Technical Support Document—Appendix T, January 2012, last accessed on 01/15/14 at the

following URL: <http://www.arb.ca.gov/regact/2012/leviiighg2012/levappt.pdf>.

<sup>226</sup> U.S. EPA, 2014, Memorandum to Docket: Regression Analysis of Nitrous Oxide and Oxides of Nitrogen from Motor Vehicles.

<sup>227</sup> The global warming potentials (GWP) used in this rule are consistent with the 100-year time frame values in the 2007 Intergovernmental Panel on Climate Change (IPCC) Fourth Assessment Report (AR4). At this time, the 1996 IPCC Second Assessment Report (SAR) 100-year GWP values are used in the official U.S. greenhouse gas inventory submission to the United Nations Framework Convention on Climate Change (per the reporting requirements under that international convention, which were last updated in 2006). N<sub>2</sub>O has a 100-year GWP of 298 and CH<sub>4</sub> has a 100-year GWP of 25 according to the 2007 IPCC AR4.

reduction in 2018, growing to 0.3 MMTCO<sub>2e</sub> in 2030. The total GHG reduction from the Tier 3 rule is 2.3 MMTCO<sub>2e</sub> in 2018, and between 4.1 and 4.3 MMTCO<sub>2e</sub> in 2030.

These reductions will be partially offset by CO<sub>2</sub> emissions associated with higher energy use required in the process of removing sulfur within the refinery. As an extension of our refinery-by-refinery cost modeling described in Section VII.B., we calculated the CO<sub>2</sub> emission impacts of Tier 3 gasoline sulfur control. We estimated refinery-specific changes in process energy and then applied emission factors that correspond to those changes, on a refinery-by-refinery basis. As described in Chapter 4.5 of the RIA, the results showed an increase of up to 1.9 MMTCO<sub>2e</sub> in 2018 and 1.6 MMTCO<sub>2e</sub> in 2030 for all U.S. refineries complying with the lower sulfur standards assuming that the sulfur standards are fully phased-in. In 2018, the combined impact of CH<sub>4</sub> and N<sub>2</sub>O emission reductions from the vehicles and CO<sub>2</sub> emission increases from the refineries shows a slight net decrease on a CO<sub>2</sub> equivalent basis. While still small, this net decrease grows to a range between 2.5 to 2.7 MMTCO<sub>2e</sub> by 2030.

We do not expect the Tier 3 vehicle standards to result in any discernible changes in vehicle CO<sub>2</sub> emissions or fuel economy. Emissions of the pollutants that are controlled by the Tier 3 program—NMOG, NO<sub>x</sub>, and PM—are not a function of the amount of fuel consumed, since manufacturers need to design their catalytic emission control systems to reduce these emissions regardless of their engine-out levels.

### C. How will air pollution be reduced?

Reductions in emissions of NO<sub>x</sub>, VOC, PM<sub>2.5</sub> and air toxics expected as a result of the Tier 3 standards are projected to lead to significant improvements in air quality. The air quality modeling predicts significant improvements in ozone concentrations due to the Tier 3 standards. Ambient PM<sub>2.5</sub> and NO<sub>2</sub> concentrations are also expected to improve as a result of the Tier 3 program. Decreases in ambient concentrations of air toxics are projected with the Tier 3 standards, including notable nationwide reductions in benzene concentrations. Our air quality modeling also predicts improvements in visibility and sulfur deposition, as well as substantial decreases in nitrogen deposition as a result of the Tier 3 standards. The results of our air quality modeling of the impacts of the Tier 3 rule are summarized in the following section.

#### 1. Ozone

The air quality modeling done for this action projects that in 2018, with all current and required controls in effect but excluding the emissions changes expected to occur as a result of the Tier 3 standards or any other additional controls, at least 19 counties, with a projected population of over 37 million people, would have projected design values above the level of the 2008 8-hour ozone standard of 75 ppb. In 2030 the modeling projects that in the absence of Tier 3 standards or any other additional controls there will be 6 counties with a population of over 19 million people with projected design values above the level of the 2008 8-hour ozone standard of 75 ppb. An additional 37 million people will be living in the 43 counties that will be close to (within 10 percent of) the level of the ozone standard.

Air quality modeling indicates that this action will meaningfully decrease ozone design value concentrations in many areas of the country, including those that are projected to be exceeding, or close to exceeding, the ozone standard. In 2018, the majority of the design value decreases are between 0.5 and 1.0 ppb. In 2030, the Tier 3 rule will result in larger decreases in ozone design values, with the majority of counties projecting decreases of between 0.5 and 1.0 ppb, and over 250 more counties with decreases greater than 1.0 ppb. Since the Tier 3 standards go into effect during the period when some areas are still working to attain the ozone NAAQS, the projected air quality changes will help state and local agencies in their effort to attain and maintain the ozone standard.

#### 2. Particulate Matter

The air quality modeling conducted for this action projects that in 2018, with all current controls in effect but excluding the emissions changes expected to occur as a result of Tier 3 standards or any other additional controls, at least 14 counties, with a projected population of over 20 million people, would have projected design values above the level of the annual standard of 12 µg/m<sup>3</sup> and at least 24 counties, with a projected population of over 18 million people, would have projected design values above the level of the 24-hour standard of 35 µg/m<sup>3</sup>. In 2030, the modeling projects that in the absence of Tier 3 standards or any other additional controls there will be 13 counties, with a projected population of over 21 million people, with projected design values above the level of the annual standard of 12 µg/m<sup>3</sup> and 18

counties, with a projected population of over 12 million people, with projected design values above the level of the 24-hour standard of 35 µg/m<sup>3</sup>. Since the Tier 3 standards go into effect during the period when some areas are still working to attain the 2006 and 2012 PM<sub>2.5</sub> NAAQS, the projected air quality changes will be useful to state and local agencies in their effort to attain and maintain the PM<sub>2.5</sub> standards.

The Tier 3 standards will reduce 24-hour and annual PM<sub>2.5</sub> design values due to projected tailpipe reductions in primary PM<sub>2.5</sub>, SO<sub>2</sub>, NO<sub>x</sub> and VOCs from reductions in fuel sulfur and engine controls. In 2018 the standards will have a small impact on annual PM<sub>2.5</sub> design values in the majority of modeled counties. However, in over 200 counties annual PM<sub>2.5</sub> design values are projected to decrease by greater than 0.01 µg/m<sup>3</sup>. In 2030 annual PM<sub>2.5</sub> design values in the majority of modeled counties will decrease by between 0.01 and 0.05 µg/m<sup>3</sup> and in over 140 additional counties design values are projected to decrease by greater than 0.05 µg/m<sup>3</sup>. In addition, in 2018 24-hour PM<sub>2.5</sub> design values in over 200 counties are projected to decrease by between 0.05 and 0.15 µg/m<sup>3</sup> and in 2030 24-hour PM<sub>2.5</sub> design values in over 180 counties decrease by at least 0.15 µg/m<sup>3</sup>.

#### 3. Nitrogen Dioxide

Although our modeling indicates that by 2030 the majority of the country will experience decreases of less than 0.1 ppb in their annual NO<sub>2</sub> concentrations due to this rule, annual NO<sub>2</sub> concentrations are projected to decrease by more than 0.3 ppb in most urban areas. These emissions reductions would also likely decrease 1-hour NO<sub>2</sub> concentrations and help any potential nonattainment areas to attain and maintain the standard. Additional information on the emissions reductions that are projected with this rule is available in Section 7.2.1 of the RIA.

#### 4. Air Toxics

Our modeling indicates that the impacts of final Tier 3 standards include notable nationwide reductions in benzene and generally small decreases in ambient concentrations of other air toxics, mainly in urban areas. Although reductions are greater in 2030 (when 70 percent of the miles travelled are from vehicles that meet the fully phased-in Tier 3 standards) than in 2017 (the first year of the final program), our modeling projects there will be small immediate reductions in ambient concentrations of air toxics due to the Tier 3 sulfur controls. Furthermore, the full reduction of the vehicle program will be realized

after 2030, when the fleet has fully turned over to vehicles meeting the fully phased-in Tier 3 standards. Air toxics pollutants dominated by primary emissions (or a decay product of a directly emitted pollutant), such as benzene, are impacted more than air toxics that primarily result from photochemical transformation.

Specifically, in 2030, our modeling projects that the Tier 3 rule will decrease ambient benzene concentrations across much of the country on the order of 1 to 5 percent, with reductions ranging from 10 to 25 percent in some urban areas. Our modeling also shows reductions of 1,3-butadiene and acrolein concentrations in 2030 ranging between 1 and 25 percent and 1 and 10 percent respectively, with 1,3-butadiene

decreases of at least 0.005 µg/m<sup>3</sup> in urban areas. These toxics are national risk drivers and the reductions in ambient concentrations from this rule will result in reductions in risks from cancer and noncancer health effects. In some parts of the country (mainly urban areas), ethanol and formaldehyde concentrations are projected to decrease on the order of 1 to 10 percent and 1 to 2.5 percent respectively in 2030 as a result of the Tier 3 rule. Decreases in ethanol concentrations are expected due to reductions in VOC as a result of the Tier 3 standards. Changes in ambient acetaldehyde concentrations are generally less than 1 percent across the U.S., although the Tier 3 rule may decrease acetaldehyde concentrations in some urban areas by 1 to 2.5 percent in 2030. Changes in ambient naphthalene

concentrations are generally between 1 and 10 percent in 2030 with absolute decreases of up to 0.005 µg/m<sup>3</sup>.

Although the reductions in ambient air toxics concentrations expected from the Tier 3 standards are generally small, they are projected to benefit the majority of the U.S. population. As shown in Table III–8, over 75 percent of the total U.S. population is projected to experience a decrease in ambient benzene and 1,3-butadiene concentrations of at least 1 percent. Over 60 percent of the U.S. population is projected to experience at least a 1 percent decrease in ambient ethanol and acrolein concentrations, and over 35 percent would experience a similar decrease in ambient formaldehyde concentrations with the Tier 3 standards.

TABLE III–8—PERCENT OF TOTAL POPULATION EXPERIENCING CHANGES IN ANNUAL AMBIENT CONCENTRATIONS OF TOXIC POLLUTANTS IN 2030 AS A RESULT OF THE TIER 3 STANDARDS

Percent change (percent)	Benzene (percent)	Acrolein (percent)	1,3-Butadiene (percent)	Formaldehyde (percent)	Ethanol (percent)	Acetaldehyde (percent)	Naphthalene (percent)
≤ -50							
> -50 to ≤ -25							
> -25 to ≤ -10	2.29	0.75	19.07				10.74
> -10 to ≤ -5	20.63	12.72	27.29		5.39		31.56
> -5 to ≤ -2.5	27.50	25.17	15.37	0.60	24.08		20.58
> -2.5 to ≤ -1	28.60	24.62	18.33	35.34	34.10	11.77	14.98
> -1 to < 1	20.97	36.74	19.93	64.06	36.43	88.23	22.14
≥ 1 to < 2.5							
≥ 2.5 to < 5							
≥ 5 to < 10							
≥ 10 to < 25							
≥ 25 to < 50							
≥ 50							

In addition, as described in Section 7.2.4.4.2 of the RIA, our modeling projects that acrolein concentrations would decrease to levels below the inhalation reference concentration for acrolein (0.02 µg/m<sup>3</sup>) for over 5 million people in 2030, meaning that as a result of the Tier 3 standards, 5 million fewer Americans will be exposed to ambient levels of acrolein high enough to present a potential for adverse health effects.

5. Visibility

Air quality modeling conducted for this final action was used to project visibility conditions in 137 mandatory class I federal areas across the U.S. The results show that in 2030 all the modeled areas will continue to have annual average deciview levels above background and the Tier 3 rule will improve visibility in all these areas.<sup>228</sup>

<sup>228</sup> The level of visibility impairment in an area is based on the light-extinction coefficient and a unitless visibility index, called a “deciview,” which is used in the valuation of visibility. The deciview metric provides a scale for perceived visual changes

The average visibility at all modeled mandatory class I federal areas on the 20 percent worst days is projected to improve by 0.02 deciviews, or 0.16 percent, in 2030. Section 7.2.5.5 of the RIA contains more detail on the visibility portion of the air quality modeling.

6. Nitrogen and Sulfur Deposition

Our air quality modeling projects substantial decreases in nitrogen deposition as a result of the Tier 3 standards. The standards will result in annual percent decreases of greater than 2.5 percent in most major urban areas and greater than 5 percent in a few areas. In addition, smaller decreases, in the 1 to 2.5 percent range, will occur over much of the rest of the country. The impacts of the Tier 3 standards on

over the entire range of conditions, from clear to hazy. Under many scenic conditions, the average person can generally perceive a change of one deciview. The higher the deciview value, the worse the visibility. Thus, an improvement in visibility is a decrease in deciview value.

sulfur deposition are smaller, ranging from no change to decreases of over 2.5 percent in some areas. For maps of 2030 deposition impacts and additional information on these impacts see Section 7.2.5.6 of the RIA.

7. Environmental Justice

Environmental justice (EJ) is a principle asserting that all people deserve fair treatment and meaningful involvement with respect to environmental laws, regulations, and policies. EPA seeks to provide the same degree of protection from environmental health hazards for all people. As referenced below, numerous studies have found that some environmental hazards are more prevalent in areas with high population fractions of racial/ethnic minorities and people with low socioeconomic status (SES), as would be expected on the basis of those areas’ share of the general population.

As discussed in Section II of this document, concentrations of many air pollutants are elevated near high-traffic

roadways. If minority populations and low-income populations disproportionately live near such roads, then an issue of EJ may be present. Such disparities may be due to multiple factors.<sup>229</sup>

People with low SES often live in neighborhoods with multiple stressors and health risk factors, including reduced health insurance coverage rates, higher smoking and drug use rates, limited access to fresh food, visible neighborhood violence, and elevated rates of obesity and some diseases such as asthma, diabetes, and ischemic heart disease. Although questions remain, several studies find stronger associations between air pollution and health in locations with such chronic neighborhood stress, suggesting that populations in these areas may be more susceptible to the effects of air pollution.<sup>230 231 232 233</sup> Household-level stressors such as parental smoking and relationship stress also may increase susceptibility to the adverse effects of air pollution.<sup>234 235</sup>

To address the existing conditions in areas near major roadways, in comparison with other locations, we reviewed existing scholarly literature examining the topic, and conducted our

own evaluation of two national datasets: The U.S. Census Bureau's American Housing Survey for calendar year 2009 and the U.S. Department of Education's database of school locations.

Existing publications that address EJ issues generally report that populations living near major roadways (and other types of transportation infrastructure) tend to be composed of larger fractions of nonwhite residents. People living in neighborhoods near such sources of air pollution also tend to be lower in income than people living elsewhere. Numerous studies evaluating the demographics and socioeconomic status of populations or schools near roadways have found that they include a greater percentage of minority residents, as well as lower SES (indicated by variables such as median household income). Locations in these studies include Los Angeles, CA; Seattle, WA; Wayne County, MI; Orange County, FL; and the State of California.<sup>236 237 238 239 240 241</sup>

More recently, three publications report nationwide analyses that compare the demographic patterns of people who do or do not live near major roadways.<sup>242 243 244</sup> All three of these studies found that people living near major roadways are more likely to be minorities or low in SES. They also

found that the outcomes of their analyses varied between regions within the U.S. However, only one such study looked at whether such conclusions were confounded by living in a location with higher population density and how demographics differ between locations nationwide. In general, it found that higher density areas have higher proportions of low income and minority residents.

We analyzed two national databases that allowed us to evaluate whether homes and schools were located near a major road. One database, the American Housing Survey (AHS), includes descriptive statistics of over 70,000 housing units across the nation. The study is conducted every two years by the U.S. Census Bureau. We analyzed data from the 2009 AHS. The second database we analyzed was the U.S. Department of Education's Common Core of Data, which includes enrollment and location information for schools across the U.S.

In analyzing the 2009 AHS, we focused on whether or not a housing unit was located within 300 feet of "4-or-more lane highway, railroad, or airport."<sup>245</sup> We analyzed whether there were differences between houses and householders in such locations and those not in them.<sup>246</sup> We included other variables, such as land use category, region of country, and housing type. We found that homes with a nonwhite householder were 22–34 percent more likely to be located within 300 feet of these large transportation facilities, while homes with a Hispanic householder were 17–33 percent more likely. Households near large transportation facilities were, on average, lower in income and educational attainment, more likely to be a rental property and located in an urban area.

In examining schools near major roadways, we examined the Common Core of Data (CCD) from the U.S. Department of Education, which includes information on all public elementary and secondary schools and school districts nationwide.<sup>247</sup> To determine school proximities to major roadways, we used a geographic

<sup>229</sup> Depro, B.; Timmins, C. (2008) Mobility and environmental equity: Do housing choices determine exposure to air pollution? North Carolina State University Center for Environmental and Resource Economic Policy.

<sup>230</sup> Clougherty, J.E.; Kubzansky, L.D. (2009) A framework for examining social stress and susceptibility to air pollution in respiratory health. *Environ Health Perspect* 117: 1351–1358. Doi:10.1289/ehp.0900612 [Online at <http://dx.doi.org>].

<sup>231</sup> Clougherty, J.E.; Levy, J.I.; Kubzansky, L.D.; Ryan, P.B.; Franco Suglia, S.; Jacobson Canner, M.; Wright, R.J. (2007) Synergistic effects of traffic-related air pollution and exposure to violence on urban asthma etiology. *Environ Health Perspect* 115: 1140–1146. doi:10.1289/ehp.9863 [Online at <http://dx.doi.org>].

<sup>232</sup> Finkelstein, M.M.; Jerrett, M.; DeLuca, P.; Finkelstein, N.; Verma, D.K.; Chapman, K.; Sears, M.R. (2003) Relation between income, air pollution and mortality: a cohort study. *Canadian Med Assn J* 169: 397–402.

<sup>233</sup> Shankardass, K.; McConnell, R.; Jerrett, M.; Milam, J.; Richardson, J.; Berhane, K. (2009) Parental stress increases the effect of traffic-related air pollution on childhood asthma incidence. *Proc Natl Acad Sci* 106: 12406–12411. doi:10.1073/pnas.0812910106 [Online at <http://dx.doi.org>].

<sup>234</sup> Lewis, A.S.; Sax, S.N.; Wason, S.C.; Campleman, S.L. (2011) Non-chemical stressors and cumulative risk assessment: An overview of current initiatives and potential air pollutant interactions. *Int J Environ Res Public Health* 8: 2020–2073. Doi:10.3390/ijerph8062020 [Online at <http://dx.doi.org>].

<sup>235</sup> Rosa, M.J.; Jung, K.H.; Perzanowski, M.S.; Kelvin, E.A.; Darling, K.W.; Camann, D.E.; Chillrud, S.N.; Whyatt, R.M.; Kinney, P.L.; Perera, F.P.; Miller, R.L. (2010) Prenatal exposure to polycyclic aromatic hydrocarbons, environmental tobacco smoke and asthma. *Respir Med* (In press). doi:10.1016/j.rmed.2010.11.022 [Online at <http://dx.doi.org>].

<sup>236</sup> Marshall, J.D. (2008) Environmental inequality: Air pollution exposures in California's South Coast Air Basin.

<sup>237</sup> Su, J.G.; Larson, T.; Gould, T.; Cohen, M.; Buzzelli, M. (2010) Transboundary air pollution and environmental justice: Vancouver and Seattle compared. *GeoJournal* 57: 595–608. doi:10.1007/s10708-009-9269-6 [Online at <http://dx.doi.org>].

<sup>238</sup> Chakraborty, J.; Zandbergen, P.A. (2007) Children at risk: Measuring racial/ethnic disparities in potential exposure to air pollution at school and home. *J Epidemiol Community Health* 61: 1074–1079. doi: 10.1136/jech.2006.054130 [Online at <http://dx.doi.org>].

<sup>239</sup> Green, R.S.; Smorodinsky, S.; Kim, J.J.; McLaughlin, R.; Ostro, B. (2003) Proximity of California public schools to busy roads. *Environ Health Perspect* 112: 61–66. doi:10.1289/ehp.6566 [Online at <http://dx.doi.org>].

<sup>240</sup> Wu, Y.; Batterman, S.A. (2006) Proximity of schools in Detroit, Michigan to automobile and truck traffic. *J Exposure Sci & Environ Epidemiol*. doi:10.1038/sj.jes.7500484 [Online at <http://dx.doi.org>].

<sup>241</sup> Su, J.G.; Jerrett, M.; de Nazelle, A.; Wolch, J. (2011) Does exposure to air pollution in urban parks have socioeconomic, racial, or ethnic gradients? *Environ Res* 111: 319–328.

<sup>242</sup> Rowangould, G.M. (2013) A census of the US near-roadway population: Public health and environmental justice considerations. *Transportation Research Part D*: 59–67.

<sup>243</sup> Tian, N.; Xue, J.; Barzyk, T.M. (2013) Evaluating socioeconomic and racial differences in traffic-related metrics in the United States using a GIS approach. *J Exposure Sci Environ Epidemiol* 23: 215–222.

<sup>244</sup> Boehmer, T.K.; Foster, S.L.; Henry, J.R.; Woghiren-Akinnifesi, E.L.; Yip, F.Y. (2013) Residential proximity to major highways—United States, 2010. *Morbidity and Mortality Weekly Report* 62(3): 46–50.

<sup>245</sup> This variable primarily represents roadway proximity. According to the Central Intelligence Agency's World Factbook, in 2010, the United States had 6,506,204 km or roadways, 224,792 km of railways, and 15,079 airports. Highways thus represent the overwhelming majority of transportation facilities described by this factor in the AHS.

<sup>246</sup> Bailey, C. (2011) Demographic and Social Patterns in Housing Units Near Large Highways and other Transportation Sources. Memorandum to docket.

<sup>247</sup> <http://nces.ed.gov/ccd/>.

information system (GIS) to map each school and roadways based on the U.S. Census's TIGER roadway file.<sup>248</sup> We found that minority students were overrepresented at schools within 200 meters of the largest roadways, and that schools within 200 meters of the largest roadways also had higher than expected numbers of students eligible for free or reduced-price lunches. For example, Black students represent 21.57 percent of students at schools located within 200 meters of a primary road, whereas Black students represent 16.62 percent of students in all U.S. schools. Hispanic students represent 30.13 percent of students at schools located within 200 meters of a primary road, whereas Hispanic students represent 21.93 percent of students in all U.S. schools.

Overall, there is substantial evidence that people who live or attend school near major roadways are more likely to be of a minority race, Hispanic ethnicity, and/or low SES. The emission reductions from this rule are projected to result in widespread air quality improvements, but the impact on pollution levels in close proximity to roadways is expected to be most direct. Thus, this rule is likely to help in mitigating the disparity in racial, ethnic, and economically-based exposures.

#### IV. Vehicle Emissions Program

In the 14 years since EPA finalized the Tier 2 Vehicle Program, manufacturers of light-duty vehicles have continued to develop a wide range of improved technologies capable of reducing emissions, especially exhaust hydrocarbons, nitrogen oxides (NO<sub>x</sub>), and particulate matter (PM), and evaporative hydrocarbons. The California LEV II program has been instrumental in the auto industry's continuous technology improvements by requiring year after year reductions in fleet average exhaust hydrocarbon levels. In addition, California set performance standards that have resulted in the introduction of advanced exhaust and evaporative emission controls in partial zero emission vehicles (PZEVs). Overall, this progress in vehicle technology has made it possible for manufacturers to achieve emission reductions with a number of today's vehicles that go well beyond the requirements of the Tier 2 program.

Extensive data from existing Tier 2 (and California LEV II) vehicles presented in the NPRM and received since the proposal have demonstrated the potential for further significant

reductions. For exhaust emissions, these opportunities include addressing: Emissions produced at start-up; emissions under high-speed, high-load conditions; the effects of sulfur in gasoline; the effects of increased oil consumption; and the effects of age on vehicles and control systems. In addition, technologies now exist that have inherently low evaporative emission characteristics and demonstrate improved in-use durability. Based on this body of data, we are adopting more stringent standards designed to reduce emissions, primarily exhaust non-methane organic gases (NMOG), NO<sub>x</sub>, and PM and evaporative hydrocarbon emissions from new vehicles. As discussed in detail below and in the final RIA, we have concluded that, in conjunction with the reductions in fuel sulfur also required in this action, the new vehicle emissions standards are feasible, accounting for costs, across the fleet in the timeframe of the program. We believe that simultaneous reductions in fuel sulfur will be a key factor in enabling the entire fleet of vehicles subject to Tier 3 to meet the new emission standards in-use, throughout the life of the vehicles (see Section IV.A.6 below).

We received a large number and wide range of comments on the proposed vehicle emission program, and we have carefully considered all of them. (The Summary and Analysis of Comments document addresses the comments received; it is located in the docket for this rulemaking and also on EPA's Web site at [www.epa.gov/otaq/tier3.htm](http://www.epa.gov/otaq/tier3.htm).) With very few exceptions, we are finalizing the Tier 3 vehicle emission program as proposed, including the levels of the new emission standards and the phase-in schedules. In several cases, as discussed in detail below, the comments and/or newer technical information have resulted in adjustments to the proposed program, including when the requirements begin, what fuel is used for vehicle compliance testing, and what the PM standard level is for testing under aggressive driving conditions. The final Tier 3 vehicle provisions, like the proposal, also harmonize closely with California's LEV III program.

This section describes in detail the program for reducing tailpipe and evaporative emissions from light-duty vehicles (LDVs, or passenger cars), light-duty trucks (LDT1s, 2s, 3s, and 4s), Medium-Duty Passenger Vehicles (MDPVs), and certain heavy-duty vehicles (HDVs). Sections IV.A and IV.B discuss the tailpipe emission standards and time lines, and other provisions for new LDVs, LDTs, and MDPVs and for

new heavy-duty vehicles up to 14,000 lbs Gross Vehicle Weight Rating (GVWR). Section IV.C presents the new Tier 3 evaporative emissions standards and program and Section IV.D describes the new evaporative emissions leak test. Section IV.E presents improvements to the existing Onboard Diagnostics (OBD) provisions. In Section IV.F, we describe new provisions to update our federal certification fuel to better match today's in-use fuel. We also discuss in this section the compliance flexibilities for small auto manufacturing companies and small-volume manufacturers (IV.G) as well as new testing and test procedure provisions and other compliance provisions (IV.H).

#### *A. Tier 3 Tailpipe Emission Standards for Light-Duty Vehicles, Light-Duty Trucks, and Medium-Duty Passenger Vehicles*

##### 1. How the Tier 3 Program Is Harmonized With the California LEV III Program

In describing the Tier 3 program for light- and heavy-duty vehicles in this preamble, we discuss how the provisions are consistent with the California Air Resources Board (CARB) LEV III program.<sup>249</sup> During the development of the proposed rule and in their comments, auto manufacturers stressed to us the importance of their being able to design and produce a single fleet of vehicles for all 50 states that simultaneously complies with requirements under the Tier 3 program and the LEV III program, as well as greenhouse gas/CAFE requirements they are facing in the same timeframe. To the extent that the federal and California programs are consistent, special versions of vehicles with different emission control hardware and calibrations for different geographic areas will be unnecessary. This will allow manufacturers to avoid the additional costs of parallel design, development, calibration, and manufacturing. Consistency among programs also eliminates the need to supply aftermarket parts for repair of multiple versions of a vehicle. We believe that the most effective and efficient national program will result from close coordination between CARB LEV III and federal Tier 3 program elements and their implementation.

<sup>249</sup> See California Low-Emission Vehicles (LEV) & GHG 2012 regulations adopted by the State of California Air Resources Board, March 22, 2012, Resolution 12-21 incorporating by reference Resolution 12-11, which was adopted January 26, 2012. Available at <http://www.arb.ca.gov/regact/2012/leviiighg2012/leviiighg2012.htm> (last accessed December 2, 2013).

<sup>248</sup> Pedde, M.; Bailey, C. (2011) Identification of Schools within 200 Meters of U.S. Primary and Secondary Roads. Memorandum to the docket.

To that end, we worked closely with CARB and the vehicle manufacturers, the latter both individually and through their trade associations, to align the two programs. The Tier 3 program is identical to LEV III in most major respects for light-duty vehicles (and heavy-duty vehicles, as described in sections below). The levels and the timing of the declining fleet-average NMOG+NO<sub>x</sub> standards are identical to those in LEV III. The Tier 3 emissions bins to which manufacturers will certify individual vehicle models in order to comply with the fleet-average standards, are also identical to those in LEV III. Similarly, the light-duty Tier 3 FTP PM standards and percent phase-in match those for LEV III through MY 2024.

We note there are a few light-duty Tier 3 and LEV III provisions that are different, for reasons discussed below. For example, the LEV III program and the Tier 3 program have different light-duty PM requirements late in the program (i.e., after MY 2024 (IV.A.3.b.)), and the two programs have different final NMOG+NO<sub>x</sub> standards for small volume manufacturers (IV.G.1). As also discussed below, we are finalizing a revised SFTP (US06) PM standard, and CARB has commented that it plans to take similar action in near future. CARB also indicated in their comments that they intend to consider several additional actions to further align several minor aspects of LEV III with the Tier 3 program once Tier 3 is finalized.

Beyond the provisions mentioned above, the differences between the programs are not major and most will exist only in the transitional years of the Tier 3 program. These additional differences result from the fact that the LEV III requirements begin slightly earlier and that a limited phase-in of some provisions is necessary for a smooth transition to overall aligned programs. These temporary differences include the process for how early compliance credits are generated and used (e.g., Section IV.A.7.a); how quickly manufacturers will need to move toward certifying all of their vehicle models to longer useful-life values (e.g., Section IV.A.7.c) and on the new test fuel (e.g., Section IV.A.7.d); and transitional emissions bins to facilitate the transition from Tier 2 to Tier 3 (Section IV.A.7.n).

## 2. Summary of the Tier 3 FTP and SFTP Tailpipe Standards

### a. Major Comments on and Significant Changes to the Proposal

As mentioned above, we are finalizing most aspects of the comprehensive Tier 3 vehicle program as we proposed them.

The levels of the FTP and SFTP standards for the key tailpipe pollutants of concern—the sum of NMOG and NO<sub>x</sub> emissions, expressed as NMOG+NO<sub>x</sub>, and PM—are the same as proposed (except for the numerically lower final PM SFTP (US06) standard, as discussed below). In addition, the timing of the requirements remains the same as in the NPRM, starting with MY2017 and MY2018 and phasing in according to the same declining fleet-average schedule for the NMOG+NO<sub>x</sub> standards and the same percent-of-sales phase-in schedule for the PM standards. We continue to believe that these elements form a robust framework for the Tier 3 vehicle program and closely harmonize with the respective elements of California's LEV III program.

There are several important provisions of the light-duty Tier 3 program that we have revised from the proposal, based on further consideration and information that we received from commenters. We discuss each of these in detail later in this section and summarize them here.

- As described below in Section IV.A.2.c, each of the four primary Tier 3 emission standards has an associated alternative phase-in option for heavier light-duty vehicles that a manufacturer can choose if it prefers a later start date (to provide 4 years of lead time) and a stable standard.<sup>250</sup> We proposed that a manufacturer choosing these options be required to apply the alternative phase-in schedule to its entire light-duty fleet. In response to comments from automakers that this restriction would be unnecessarily burdensome, we reconsidered this provision. For the reasons discussed below, we are allowing a manufacturer to apply the alternative phase-in schedules to only their heavier light-duty vehicles, instead of their entire light-duty fleet. However, manufacturers have largely indicated that they plan on adopting the primary program which is harmonized with LEV III.

- This Tier 3 rule provides an opportunity for EPA to reassess the degree to which the gasoline used for vehicle emissions testing and certification reflects in-use gasoline around the country. In the case of ethanol content, we proposed that the emissions test fuel contain 15 percent ethanol (E15), anticipating a significant shift to higher ethanol content in use in the near future. For several reasons described below (Section IV.F.1), this

<sup>250</sup>In this preamble, “heavier light-duty vehicles” refers to LDVs and LDTs greater than 6,000 lbs GVWR and MDPVs, and “lighter light-duty vehicles” refers to LDVs and LDTs up to 6,000 lbs GVWR.

shift in in-use fuel is not materializing as quickly as expected, and E10 continues to be almost universal today. We received a near consensus among comments from stakeholders that E10 test fuel is more appropriate. We agree that E10 most appropriately reflects in-use gasoline around the country today and into the foreseeable future, and thus we are finalizing E10 for the test fuel. In addition, as discussed in Section IV.F.1, we are finalizing a fuel volatility specification for test fuel of 9 psi RVP, as proposed.

- We are finalizing a set of standards for PM as measured on the aggressive-driving segment of the SFTP test cycle (the US06 cycle) based on US06 PM test data that we published as part of the NPRM, along with more recent test data developed by California. Our review of these data has led us to finalize numerically lower levels for the US06 PM standards than we proposed. The data presented in the NPRM as well as the data provided by California clearly show that the proposed US06 PM standards were inappropriately high, that US06 PM emissions are not closely related to vehicle weight, and that lower values for the standards would achieve the goal of the program to bring all vehicles in the light-duty fleet to the US06 PM levels that are being met by many vehicles today. Based on the body of available data, we are establishing 6 mg/mi as the long-term US06 PM standard. (This compares to the proposed standards of 10 and 20 mg/mi for lighter and heavier light-duty vehicles, respectively.) However, because there remains some uncertainty about how manufacturers will achieve this level in the early years of the program, we are setting the standard at 10 mg/mi for the early years of the program, for MYs 2017 and 2018. Similarly, we are providing a less-stringent standard of 10 mg/mi for testing of in-use vehicles in recognition of the challenges of the requirements as vehicles age.

- In the Tier 3 program, as for vehicle emission control programs in the past, manufacturers are responsible for the emissions performance of the vehicle for a specified “useful life” of the vehicle. EPA proposed that vehicles meet the Tier 3 standards for 150,000 miles or 15 years, identical to the LEV III program's approach. We proposed an option for lighter light-duty vehicles to certify to a shorter useful life of 120,000 miles or 10 (or 11, as applicable) years, as set in the Tier 2 program. We proposed that manufacturers certifying to the shorter useful life would need to meet numerically lower NMOG+NO<sub>x</sub> standards (85 percent of the respective

150,000-mile NMOG+NO<sub>x</sub> standards). We also proposed that a manufacturer choosing the shorter useful life for one vehicle model would need to use that useful life and associated standards for all of its lighter vehicles. Auto industry commenters stated that applying the provision across a manufacturer's fleet would create an onerous compliance burden. We have reconsidered our proposed approach, and as discussed in Section IV.A.7.c below, we will allow a manufacturer to split its lighter light-duty fleet among models certified for either the 150,000 mile or 120,000 mile useful life and associated standards.

- Another area of substantial comment, primarily from the petroleum refining industry, questioned the technological need of auto manufacturers for lower in-use sulfur levels in order to meet the Tier 3 vehicle emission standards. In contrast, auto manufacturers and emissions control system manufacturers commented that lower sulfur gasoline is critical to meet the Tier 3 standards. After careful consideration of the comments, we continue to believe that the large body of data presented in the NPRM, supplemented by newer data that consistently reinforces the earlier conclusions, strongly supports our determination of the need for average in-use gasoline sulfur levels to be at 10 ppm sulfur or lower for manufacturers to meet the Tier 3 vehicle standards across their fleets for the useful life of the vehicles. See Section IV.A.6 below for a detailed discussion of the need for gasoline sulfur control.

#### b. Structure of the Primary Tier 3 Tailpipe Standards

As proposed, compliance with the standards is based on vehicle testing using test procedures that represent a range of vehicle operation, including the Federal Test Procedure (FTP) and the Supplemental Federal Test Procedure (SFTP). The Tier 3 FTP and SFTP NMOG+NO<sub>x</sub> standards are fleet-average standards, meaning that the manufacturer calculates the sales-weighted average emissions of the vehicles it sells in each model year, accounting for any Tier 3 emissions credits or deficits, and compares that average to the applicable standard for that model year. The fleet average standards for NMOG+NO<sub>x</sub> evaluated over the FTP are the same values as proposed and are summarized in Table IV-2 and discussed in detail below. For lighter light-duty vehicles, the standards begin in MY 2017 at a level representing a 46 percent reduction from the current Tier 2 requirements for lighter vehicles and then become increasingly stringent,

culminating in an 81 percent reduction in MY 2025. The FTP NMOG+NO<sub>x</sub> program includes separate fleet average standards for heavier vehicles that begin in MY 2018 and then converge with the standards for lighter vehicles at 30 milligrams per mile (mg/mi) in MY 2025 and later, as proposed.<sup>251 252</sup>

Manufacturers will determine their fleet average FTP NMOG+NO<sub>x</sub> emission values as we proposed, based on the per-vehicle "bin standards" to which they certify each vehicle model. Manufacturers will be free to certify vehicles to any of the bins, so long as the sales-weighted average of the NMOG+NO<sub>x</sub> values from the selected bins meets the fleet average standard for that model year. Table IV-1 presents the per-vehicle bin standards. Similarly, the fleet average NMOG+NO<sub>x</sub> standards measured over the SFTP are summarized in Table IV-4 and discussed in detail below. The SFTP NMOG+NO<sub>x</sub> fleet average standards decline from MY 2017 until MY 2025. In this case, the same standards apply to both lighter and heavier vehicles. In MY 2025, the SFTP NMOG+NO<sub>x</sub> standard reaches its fully phased-in fleet average level of 50 mg/mi.

Also as proposed, the new Tier 3 PM standards apply to each vehicle separately. The PM standards are per-vehicle cap standards and not fleet-average standards. Also, in contrast to the declining NMOG+NO<sub>x</sub> standards, the PM standard on the FTP is a constant 3 mg/mi for all vehicles and for all model years, phasing in to an increasing percentage of vehicle sales beginning in MY 2017 for vehicles at or below 6,000 lbs Gross Vehicle Weight Rating (GVWR) and in MY 2018 for vehicles above 6,000 lbs GVWR. As discussed in Section IV.A.3.b above, based on data generated by EPA and CARB test programs, most current light-duty vehicles are already performing at or below the 3 mg/mi level. However, some vehicles are emitting above this level, due to such factors as excessive fueling during cold start and combustion chamber and fuel system designs that are not optimized for low PM emissions. The intent of the 3 mg/mi standard is to bring all light-duty vehicles to the PM level typical of that

being demonstrated by most light-duty vehicles today. To address the uncertainties that will accompany the introduction of new technologies, the program includes a separate in-use FTP PM standard of 6 mg/mi for the testing of in-use vehicles during the phase-in period, as proposed, as described in more detail below.

As presented in Table IV-3, for vehicles at or below 6000 lbs GVWR, these FTP PM certification and in-use standards phase in over several years, beginning with a requirement that at least 20 percent of a company's U.S. sales of these vehicles comply with the Tier 3 standards in MY 2017. We are also finalizing an option for a manufacturer to choose to certify 10 percent of its total light-duty fleet sales—including LDVs and LDT over 6,000 lbs GVWR and MDPVs—to the Tier 3 FTP PM standards in MY 2017. Manufacturers would reach a 100 percent compliance requirement in MY 2021.

Finally, the Tier 3 program includes PM standards evaluated over the US06 cycle (a component of the SFTP test that captures higher speeds and accelerations). Based on emissions test data presented in the NPRM and additional data submitted in public comments, and as presented in Table IV-5 and further discussed in Section IV.A.4.b below, we are establishing a single long-term US06 PM standard of 6 mg/mi for both lighter and heavier vehicles, a level that is numerically lower than what we proposed. However, because there remains some uncertainty about how manufacturers will decide to achieve this level in the early years of the program, we are setting the standard through MY 2018 at 10 mg/mi. The US06 PM standards phase in using the same 20–20–40–70–100 percent schedule, and on the same vehicles, as the new FTP PM standards. The 10 mg/mi standard applies in MYs 2017 and 2018 (at a percent-of-sales requirement of 20 percent, and the long-term 6 mg/mi standard applies in MYs 2019 and later, increasing from 40 to 100 percent of sales. This US06 standard will apply to the same vehicle models that a manufacturer chooses to certify to the FTP PM standard during the percent phase-in period. As in the case of the FTP PM standards, the intent of the standard is to bring the emission performance of all vehicles to that already being demonstrated by many vehicles in the current light-duty fleet. As proposed, we include a separate in-use US06 PM standard during in the middle years of the program, but at a different numerical level and during

<sup>251</sup> The declining NMOG+NO<sub>x</sub> fleet-average standards consist of one set of declining standards that applies to light-duty vehicles (LDVs) and small light trucks (LDT1s) and a second set of declining standards that applies to heavier light trucks (LDT2s, LDT3s, LDT4s), and MDPVs.

<sup>252</sup> This preamble presents the new Tier 3 standards in terms of milligrams per mile (mg/mi) for convenience. Throughout the associated Tier 3 regulatory language we continue to present the standards in terms of grams per mile (g/mi) for consistency with earlier programs.



different years than proposed (as discussed in Section IV.A.4.b below).

We did not propose new emission requirements for any vehicle or fuel over the cold temperature test cycles (i.e., the 20 °F cold carbon monoxide (CO) and non-methane hydrocarbon (NMHC) tests), but requested comment on that decision. Only the automakers commented on this topic, agreeing with EPA's approach of not changing its cold temperature requirements. As indicated in the proposal, we are not establishing any new cold temperature requirements in this rule.

### c. Alternate Phase-In Schedules

For heavier light-duty vehicles (i.e., LDVs and LDTs greater than 6,000 lbs GVWR, plus MDPVs), EPA is also finalizing alternative phase-in schedules for each of the four primary vehicle emission standards: FTP NMOG+NO<sub>x</sub>, FTP PM, SFTP NMOG+NO<sub>x</sub>, and US06 PM.<sup>253</sup> These alternative phase-ins are available if a manufacturer prefers stable standards and four full years of lead time, as specified in the Clean Air Act for heavier vehicles. We describe each of the alternative phase-ins in more detail below, including several ways in which we have revised the proposed provisions.

EPA received comment on the proposed alternative phase-in provisions, primarily from automakers and their trade associations. These comments questioned whether the proposed structure of and restrictions on the use of the alternative phase-ins were so onerous as to unduly restrict a manufacturer from choosing the alternative phase-ins and their lead time and stability provisions as set forth in the Clean Air Act. The commenters criticized the proposed requirement that a manufacturer using the alternative phase-ins apply the alternative schedules to its entire light-duty fleet, both below and above 6,000 lbs GVWR. EPA had proposed this provision to minimize the complexity of complying with the alternative phase-in if a manufacturer's heavier and lighter light-duty vehicles had different compliance structures.

In consideration of these concerns, we have removed from the alternative phase-in provisions the requirement that a manufacturer apply the alternative schedules to its entire light-duty fleet including vehicles below 6,000 lbs GVWR. For the practical functioning of the program, the final rule requires that any manufacturer choosing to use the alternative phase-in

apply all four alternative phase-in schedules to its entire light-duty fleet above 6,000 lbs GVWR. We believe that the alternative phase-ins allow manufacturers to comply with emission standards in a time frame that is clearly feasible and fully compliant with the CAA requirements for lead time and regulatory stability. To the extent that manufacturers choose to use them, the alternative would result in overall emission reductions essentially identical to those of the primary program.

The alternative phase-in schedules would begin to apply to each vehicle for either MY 2019 or MY 2020, depending on exactly when the manufacturer begins production of the vehicle. (See Section 86.1811–17(b)(8)(i) for how we implement this provision.) For models that begin MY 2019 production after the fourth anniversary of the signing of this final rule, the alternative phase-in would provide four full years of lead time and would first apply for MY 2019. The phase-in obligation would be calculated based only on those vehicles beginning production after the fourth anniversary date. For models beginning production before that date, the alternative phase-in would first apply for MY 2020, and the phase-in percentage for MY 2020 would be based on the manufacturer's entire fleet of heavier light-duty vehicles. Based on historical certification patterns, few models begin production before mid-calendar-year, so we expect that the vast majority of MY 2019 vehicles will begin production after the 4-year anniversary and thus the alternative phase-ins, if chosen, will typically apply beginning in MY 2019.

At the time of certification for MY 2018, a manufacturer must declare whether it intends to apply the alternative phase-in schedules to its heavier light-duty vehicles. A manufacturer choosing the alternative phase-ins would be committed to this phase-in approach for the duration of the phase-ins, and could not later choose the fleet-average approach for NMOG+NO<sub>x</sub> standards. For all vehicles below 6,000 lbs GVWR, the primary program will apply, beginning in MY 2017. For a manufacturer's vehicles subject to the alternative phase-ins, there would be no new tailpipe emissions requirements beyond the Tier 2 program until the beginning of the alternative phase-in schedules; that is, MY 2019 or 2020, as explained above.

As discussed above, a manufacturer choosing the alternative phase-in approach for its heavier light-duty vehicles would be required to use all four phase-ins together. The next

paragraphs explain how each of the alternative phase-ins requires an increasing percent of the manufacturer's sales to comply with the alternative standards. Thus, until the end of the phase-ins, some percent of a manufacturer's affected vehicles will meet the new standard and the remainder of that year's sales will not yet comply with Tier 3. For the practical functioning of the program, a manufacturer choosing the alternative phase-ins would be required to comply with exactly the same segment of their fleet in each model year for all four alternative phase-ins. For example, a manufacturer that complies with the 70 percent MY 2020 requirement for the FTP NMOG+NO<sub>x</sub> standard with a segment of its vehicle fleet must meet the 70 percent MY 2020 requirement for the FTP PM standard with the same set of vehicles. Vehicles covered by the alternative phase-in programs would be considered "Final Tier 3" vehicles and thus would also need to comply with the Tier 3 certification fuel and full useful life provisions.

For the FTP and SFTP NMOG+NO<sub>x</sub> alternative phase-in schedules, once the phase-in is complete for a segment of a manufacturer's fleet, the standards continue for that set of vehicles through MY 2024, after which the full Tier 3 program applies regardless of the phase-in strategy. Thus, the fleet-average standards that decline through MY 2024 do not apply for these vehicles.

Although manufacturers would implement all four alternative phase-in schedules together, as discussed above, each alternative phase-in has unique characteristics. The following paragraphs explain the unique provisions of each.

#### (1) Alternative Phase-In Schedule for the FTP NMOG+NO<sub>x</sub> Standard

Instead of the primary FTP NMOG+NO<sub>x</sub> declining fleet average standards, a manufacturer choosing the alternative phase-ins would comply with a stable fleet average FTP NMOG+NO<sub>x</sub> standard of 30 mg/mi that would apply to an increasing percentage of a manufacturer's combined sales of LDVs and LDTs above 6,000 lbs GVWR and MDPVs. This percent phase-in would match the percentages in the primary PM percent phase-in schedule, as discussed above—specifically, 40 percent of MY 2019 heavier light-duty vehicles (excluding those vehicles with production beginning before the 4-year anniversary), 70 percent of all of its heavier light-duty vehicles in MY 2020, and 100 percent compliance in MY 2021 and later model years.

<sup>253</sup> Tier 3 standards for CO and HCHO phase in with the NMOG+NO<sub>x</sub> standards, as applicable.



(2) Alternative Phase-In Schedule for the FTP PM Standard

Instead of the primary FTP PM percent phase-in schedule, a manufacturer choosing the alternative phase-ins would postpone the beginning of its FTP PM phase-in for its LDVs and LDTs above 6,000 lbs GVWR and MDPVs until MY 2019 or 2020 (depending on the dates production begins for its vehicle models, as discussed above). The manufacturer would then comply with the 3 mg/mi per-vehicle FTP PM standard (and the 6 mg/mi in-use standard) on an increasing percentage of these vehicles, following the 40–70–100 percentage phase-in of the primary PM program—specifically, 40 percent of MY 2019 heavier light-duty vehicles (excluding those vehicles with production beginning before the 4-year anniversary), 70 percent of all of its heavier light-duty vehicles in MY 2020, and 100 percent compliance in MY 2021 and later model years.

(3) Alternative Phase-In Schedule for the SFTP NMOG+NO<sub>x</sub> Standard

As with the other alternative phase-ins, instead of the primary SFTP NMOG+NO<sub>x</sub> declining fleet average standards, a manufacturer choosing the alternative phase-ins would comply with a stable fleet average SFTP NMOG+NO<sub>x</sub> standard of 50 mg/mi that would apply to an increasing percentage of a manufacturer’s combined sales of LDVs and LDTs above 6000 lbs GVWR and MDPVs. This percent phase-in again would match the percentages in the primary PM percent phase-in schedule, as discussed above—specifically, 40 percent of MY 2019 heavier light-duty vehicles (excluding those vehicles with production beginning before the 4-year anniversary), 70 percent of all of its heavier light-duty vehicles in MY 2020, and 100 percent compliance in MY 2021 and later model years.

(4) Alternative Phase-In Schedule for the US06 PM Standard

Finally, instead of the primary US06 PM percent phase-in schedule, a manufacturer choosing the alternative phase-ins would postpone the beginning of the US06 phase-in for its LDVs and LDTs above 6,000 lbs GVWR and MDPVs until MY 2019 or 2020 (depending on the dates production begins for its vehicle models, as discussed above). The manufacturer would then comply with the 10 mg/mi US06 PM standard for 40 percent of MY 2019 heavier light-duty vehicles (excluding those vehicles with production beginning before the 4-year anniversary), 70 percent of all of its heavier light-duty vehicles in MY 2020, with 100 percent compliance in MY 2021, and then 100 percent compliance with the 6 mg/mi standard in MY 2022 and later model years.

The next sections describe in more detail the new Tier 3 standards, how they will be implemented over time, and the technological approaches that we believe are or will be available to manufacturers in order to comply.

3. FTP Standards

As summarized above, we are finalizing, largely as proposed, new standards for the primary pollutants of concern for this rule (NMOG, NO<sub>x</sub>, and PM) as measured on the FTP. The following paragraphs describe in more detail these FTP standards for NMOG+NO<sub>x</sub> and PM, as well as for carbon monoxide (CO) and formaldehyde (HCHO).

a. FTP NMOG+NO<sub>x</sub> Standards

The Tier 3 NMOG and NO<sub>x</sub> standards are expressed in terms of the sum of the two pollutants—NMOG+NO<sub>x</sub> in mg/mi.<sup>254</sup> We received no comments recommending a different approach. The California LEV III standards are also expressed as NMOG+NO<sub>x</sub>; aligning Tier 3 with LEV III is an important element of facilitating a national program.

EPA received a number of comments about how the proposed NMOG+NO<sub>x</sub>

standards transition from the existing Tier 2 standards, but there was little comment recommending different levels of the standards themselves, especially later in the program. Based on our extensive evaluation of existing and emerging vehicle technologies (see Section IV.A.5) and the level of sulfur in gasoline that will be available during the implementation timeframe of this rule, and considering the comments we received, we continue to believe that the fully phased-in level for the fleet-average FTP NMOG+NO<sub>x</sub> standard of 30 mg/mi is the most stringent level that we can reasonably establish. As discussed in Sections IV.A.5 and IV.A.6 below, when necessary margins of compliance and the demonstrated effects of fuel sulfur on emissions performance are considered, the 30 mg/mi standard is effectively very close to zero. The 30 mg/mi Tier 3 NMOG+NO<sub>x</sub> standard is also consistent with the final LEV III standard.

A key compliance mechanism adapted from the Tier 2 program is a “bin” structure for the FTP emission standards. For these purposes, a bin is a set of several standards that must be complied with as a group. Thus, as proposed, each FTP Tier 3 bin has an NMOG+NO<sub>x</sub> standard and a PM standard, as well as CO and HCHO standards.

We intend for the Tier 3 CO and HCHO standards to prevent new engine and emission control designs that result in increases in CO and HCHO emissions, compared to levels being achieved today. The standards are based on the comparable current LEV II and Tier 2 bin standards for these pollutants, which we believe are sufficiently protective at this time. There were no comments on the proposed CO and HCHO standards. The current standards are not technology-forcing, and we believe that this will continue to be the case as Tier 3 technologies are developed.

Table IV–1 presents the bin structure for light-duty vehicle, light-duty truck, and MDPV FTP standards.

TABLE IV–1—TIER 3 FTP STANDARDS FOR LDVs, LDTs AND MDPVs [mg/mi]

Bin	NMOG+NO <sub>x</sub> (mg/mi)	PM <sup>a</sup> (mg/mi)	CO (g/mi)	HCHO (mg/mi)
Bin 160 .....	160	3	4.2	4
Bin 125 .....	125	3	2.1	4
Bin 70 .....	70	3	1.7	4
Bin 50 .....	50	3	1.7	4

<sup>254</sup> See California Low-Emission Vehicles (LEV) & GHG 2012 regulations adopted by the State of California Air Resources Board, March 22, 2012,

Resolution 12–21 incorporating by reference Resolution 12–11, which was adopted January 26, 2012. Available at <http://www.arb.ca.gov/regact/>

[2012/leviiighg2012/leviiighg2012.htm](http://2012/leviiighg2012/leviiighg2012.htm) (last accessed December 2, 2013).

TABLE IV-1—TIER 3 FTP STANDARDS FOR LDVs, LDTs AND MDPVs—Continued  
[mg/mi]

Bin	NMOG+NO <sub>x</sub> (mg/mi)	PM <sup>a</sup> (mg/mi)	CO (g/mi)	HCHO (mg/mi)
Bin 30 .....	30	3	1.0	4
Bin 20 .....	20	3	1.0	4
Bin 0 .....	0	0	0	0

<sup>a</sup>In MYs 2017–20, the PM standard applies only to that segment of a manufacturer’s vehicles covered by the percent of sales phase-in for that model year.

Consistent with the Tier 2 principle of vehicle and fuel neutrality, the same Tier 3 standards apply to all LDVs, LDTs, or MDPVs, regardless of the fuel they use, as proposed. That is, vehicles certified to operate on any fuel (e.g., gasoline, diesel fuel, E85, CNG, LNG, hydrogen, and methanol) are all subject to the same standards.

The Tier 3 NMOG+NO<sub>x</sub> standards as measured on the FTP will reduce the combined fleet-average emissions gradually from MY 2017 through 2025, as shown in Table IV-2 below. Beginning in MY 2017, there are two separate sets of fleet-average standards

for, first, LDVs and LDT1s and, second, all other LDTs (LDT2s, LDT3s, and LDT4s) and MDPVs. Both fleet-average standards decline annually, converging in MY 2025. These declining average standards are identical to CARB’s LEV III standards.<sup>255</sup>

As proposed and as discussed above (Section IV.A.2.a), the declining fleet-average NMOG+NO<sub>x</sub> FTP standards begin in MY 2017 for light-duty vehicles and light-duty trucks with a GVWR up to and including 6,000 lbs and in MY 2018 for light-duty vehicles and light-duty trucks with a GVWR greater than 6,000 lbs and MDPVs. The standards

apply to the heavier vehicles a year later to facilitate the transition to a 50-state program for all manufacturers. During this transition period, as described above, there will be two fleet-average NMOG+NO<sub>x</sub> standards for each model year, one for LDVs and LDT1s and one for all other LDTs (LDT2s, LDT3s, and LDT4s) and for MDPVs that decline essentially linearly from MY 2017 through MY 2025. At that point, the two fleet-average standards converge and stabilize for all later model years at the same level, 30 mg/mi, as shown in Table IV-2.

TABLE IV-2—TIER 3 LDV, LDT, AND MDPV FLEET AVERAGE FTP NMOG+NO<sub>x</sub> STANDARDS  
[mg/mi]

	Model year								
	2017 <sup>a</sup>	2018	2019	2020	2021	2022	2023	2024	2025 and later
LDV/LDT1 <sup>b</sup> .....	86	79	72	65	58	51	44	37	30
LDT2,3,4 and MDPV .....	101	92	83	74	65	56	47	38	.....

<sup>a</sup>For LDVs and LDTs over 6,000 lbs GVWR and MDPVs, the fleet average standards apply beginning in MY 2018.

<sup>b</sup>These standards apply for a 150,000 mile useful life. Manufacturers can choose to certify their LDVs and LDV1s to a useful life of 120,000 miles. If a vehicle model is certified to the shorter useful life, a proportionally lower numerical fleet average standard applies, calculated by multiplying the respective 150,000 mile standard by 0.85 and rounding to the nearest mg/mi. See Section IV.A.7.c.

As discussed above (Section IV.A.2.c), for LDVs and LDTs above 6,000 lbs GVWR and MDPVs, EPA is also providing an alternative phase-in of the fleet-average 30 mg/mi FTP NMOG+NO<sub>x</sub> standard.

b. FTP PM Standards

We are establishing new FTP standards for PM emissions at the proposed levels—3 mg/mi, with a temporary standard of 6 mg/mi for in-use vehicle testing—as summarized in Table IV-3 below. These levels are intended to ensure that all new vehicles will perform at a level representing what is already being achieved by well-designed emission control technologies today.

Many commenters were either silent on or supportive of the proposed FTP PM standard levels. However, some commenters—including CARB and several NGOs and auto industry suppliers—supported a more stringent standard of 1 mg/mi, which the California LEV III program phases in beginning in MY 2025. After detailed consideration of these comments and information available at this time, we continue to believe that the PM standards that we are finalizing for the federal Tier 3 program are the most stringent technically feasible standards within the implementation timeframe of this rule. (See Section 1.5.1 of the RIA.) We will continue to work closely with CARB in this area. Specifically, our agencies will continue our parallel

evaluations of how improved gravimetric PM measurement methods can reduce PM mass measurement variability at very low PM levels and how this relates to the evolving technological capabilities of automakers to reach very low PM levels with sufficient compliance margins.

PM emissions over the FTP are generally attributed to the cold start, when PM formation from combustion of the fuel is facilitated by the operating conditions, including a cold combustion chamber and fuel enrichment. During cold-start operation, PM control is less effective, especially the oxidation by the catalytic converter of semi-volatile organic compounds from the lubricating oil. We believe that for vehicles that are not already at the Tier 3 levels, the new

<sup>255</sup> See California Low-Emission Vehicles (LEV) & GHG 2012 regulations adopted by the State of California Air Resources Board, March 22, 2012,

Resolution 12–21 incorporating by reference Resolution 12–11, which was adopted January 26, 2012. Available at <http://www.arb.ca.gov/regact/>

[2012/leviiighg2012/leviiighg2012.htm](http://www.arb.ca.gov/regact/2012/leviiighg2012/leviiighg2012.htm) (last accessed January 14, 2014).

standards can be achieved with improvements to the fuel controls during the cold start, without the need for any new technology or hardware. We also expect that manufacturers will pay close attention to maintaining low PM emissions during the implementation of newer technologies like gasoline direct injection (GDI) and turbocharged engines. Improvements in cold-start exhaust catalyst performance for NMOG+NO<sub>x</sub> control will also reduce emissions of semi-volatile organic PM. For these reasons, cold start PM levels are relatively independent of vehicle application and therefore we are finalizing a single FTP PM standard for all light-duty vehicles, as proposed.

Unlike the NMOG+NO<sub>x</sub> FTP standard, it is not necessary for the FTP PM standard to phase in on a declining curve over time, since most manufacturers are already producing vehicles that meet the new standards. We are finalizing the proposed PM FTP percent-of-sales phase-in during the first 5 years of the Tier 3 program in response to concerns expressed by automakers about logistical, facilities, and compliance challenges with a standard in the range of 3 mg/mi in the early years of the program. Beginning in MY 2017 (and in MY 2018 for LDVs and LDTs over 6,000 lbs GVWR and

MDPVs), manufacturers will need to comply with the PM standard with a minimum of 20 percent of their U.S. sales. As shown in Table IV-3, the percentage of the manufacturer's sales that need to comply increases each year, reaching 100 percent in MY 2021. In addition to this percent phase-in, we are also establishing, as proposed, a separate PM standard of 6 mg/mi that will apply only for in-use testing of vehicles certified to the new standards, and only during the percent phase-in period.

Due to the MY 2018 start date for vehicles over 6,000 lbs GVWR, manufacturers that have few or no vehicle models over 6,000 lbs GVWR will be required to certify a larger percentage of their total light-duty sales in MY 2017 than full line manufacturers. While we believe that most manufacturers will likely choose a single large-volume durability group to meet the 2017 requirements, we are also including an option that a manufacturer could use to comply with the MY 2017 PM requirements. Under this option, a manufacturer may choose to certify 10 percent of its total light-duty vehicle sales in MY 2017 to the new PM standards, including light-duty vehicles over 6,000 lbs. This approach is consistent with the CARB LEV III

program, which requires that 10 percent of all light-duty vehicle sales meet the new PM standards in MY 2017.

Because of the expected time and expense of performing emission tests on the improved PM test procedures, we are limiting the number of tests using the new procedures that a manufacturer needs to perform at certification and during in-use testing, as proposed. Specifically, manufacturers will only be required to test vehicles representing a minimum of 25 percent of a model's durability test groups during certification each model year (and a minimum of 2 durability groups).<sup>256</sup> Manufacturers may select which durability groups to test, but will need to rotate the groups tested each year to eventually cover their whole fleet. Similarly, manufacturers performing in-use testing under the In-Use Verification Program can limit their testing to 50 percent of their low- and high-mileage test vehicles. Again, manufacturers will need to rotate their vehicle models so that each model will be tested every other year. Overall, we believe that the flexibility that these provisions provide will facilitate the expeditious implementation of the Tier 3 program, with no significant impact on the benefits of the program.

TABLE IV-3—SUMMARY OF TIER 3 LDV, LDT, AND MDPV FTP STANDARDS

Program element	Units	Model year							Notes
		2017 <sup>a</sup>	2018	2019	2020	2021	2022	2023+	
NMOG+NO <sub>x</sub> Standard (fleet average) .....	mg/mi ..	Per declining fleet averages (see Table IV-2) <sup>b</sup>							
<b>PM Standards</b>									
Phase-in .....	% .....	20 <sup>c</sup>	20	40	70	100	100	100	
<b>FTP:</b>									
Certification .....	mg/mi ..	3	3	3	3	3	3	3	Note d.
In-use .....	mg/mi ..	6	6	6	6	6	3	3	Note e.

<sup>a</sup> For LDVs and LDTs above 6,000 lbs GVWR and MDPVs, the FTP PM standards apply beginning in MY 2018.

<sup>b</sup> The percent phase-in does not apply to the declining fleet average standards.

<sup>c</sup> Manufacturers comply in MY 2017 with 20 percent of their LDV and LDT fleet under 6,000 lbs GVWR, or alternatively with 10 percent of their total LDV, LDT, and MDPV fleet.

<sup>d</sup> Manufacturers must test 25 percent of each model year's durability groups, and a minimum of 2.

<sup>e</sup> Manufacturers must test 50 percent of their combined low- and high- mileage in-use vehicles.

As discussed in Section IV.A.2.c above, for LDVs and LDTs above 6,000 lbs GVWR and MDPVs, EPA is providing an alternative phase-in of the 3 mg/mi FTP PM standard.

4. SFTP Standards

In addition to addressing vehicle emissions during typical driving, as addressed by the FTP standards

presented above, the Tier 3 program also addresses emissions during more severe driving conditions. Thus, we are finalizing NMOG+NO<sub>x</sub> and PM standards as measured on the SFTP. The SFTP (and specifically the US06 component of the test) is designed to simulate, among other conditions, higher speeds and higher acceleration

rates, and thus higher loads. As described below, most commenters were supportive of or silent on the proposed SFTP NMOG+NO<sub>x</sub> standards and the associated declining fleet-average phase-in schedule, but several commenters stated that the level of the standards should be more stringent than proposed. Based on our analysis of the stringency

<sup>256</sup> Durability groups are a subset of engine families. Several engine families may have the same durability group.

of the program, discussed in Section IV.A.5 below and in Chapter 1 of the RIA, we disagree that more stringent SFTP NMOG+NO<sub>x</sub> standards are necessary or appropriate at this time, and we are finalizing the standards and phase-in schedule as proposed. However, we are finalizing more stringent SFTP standards for PM, which focus on the US06 test component, based on newer data and public comments. These are also described below.

The Tier 3 SFTP standards are necessary to address emissions during high-load conditions, when engines can go into a fuel “enrichment” mode and the engine’s controls may temporarily create a rich air/fuel mixture to protect exhaust components from thermal damage. Enrichment can increase emissions of NMOG+NO<sub>x</sub> and PM, primarily due to the incomplete combustion that occurs under rich conditions and the diminished effectiveness of the catalyst in these circumstances. However, enrichment can be minimized or eliminated in current and future engines, where components can be thermally protected even under high-load conditions by careful electronic management of the air/fuel mixture and the combustion process. We are finalizing these SFTP standards, as well as limitations on the amount of enrichment that drivers can command (see Section IV.A.4.c below) to address this important source of vehicle emission.

We are also finalizing an SFTP composite CO standard of 4.2 g/mi for all model years 2017 (or 2018 for LDVs and LDTs over 6000 lbs GVWR and MDPVs) and later. This standard represents no effective change from the current Tier 2 SFTP CO standard, which we believe is already at a level that is sufficiently stringent.

#### a. SFTP NMOG+NO<sub>x</sub> Standards

We are finalizing the Tier 3 SFTP NMOG+NO<sub>x</sub> standards and declining fleet-average phase-in schedule as proposed and as presented in Table IV–5 below. Most commenters were generally supportive of these standards or silent about them. However, several commenters stated that the proposed standards are too lenient, based on their evaluation of vehicle emission test data we presented in the NPRM. We have considered these comments and have reviewed the data from the NPRM. Our

conclusion from that data continues to be that the SFTP NMOG+NO<sub>x</sub> emission levels that we are finalizing ensure that manufacturers essentially eliminate fuel enrichment events and their emissions consequences, thereby resulting in important emissions reductions. See Chapter 1 of the RIA for an analysis of this data. We do not believe that significant additional reductions would result from SFTP weighted NMOG+NO<sub>x</sub> standards more stringent than the 50 mg/mi fully phased-in level. In addition, we believe that the 50 mg/mi standard will ensure that the SFTP performance of future vehicles with future technologies continues to be comparable to that of the current fleet. The SFTP emissions value for certification of gaseous pollutants will continue to be calculated as a weighted composite value of emissions on three cycles ( $0.35 \times \text{FTP} + 0.28 \times \text{US06} + 0.37 \times \text{SC03}$ ), as is done for the Tier 2 SFTP standards.

To provide flexibility in meeting the fleet-average standards, manufacturers will, as proposed, determine the specific SFTP composite standard for each individual vehicle family and report that self-selected standard and the measured emission performance. (These self-selected standards are analogous to “family emission limits,” or “FELs,” used in other programs (e.g., heavy-duty highway engine standards).) For each family, a manufacturer will choose any composite NMOG+NO<sub>x</sub> standard, up to 180 mg/mi, in even 10 mg/mi increments. The manufacturer will then calculate the sales-weighted average of all the selected standards of the families across its fleet and compare that emissions value to the applicable fleet-average standards for that model year. Table IV–4 presents the declining fleet-average SFTP NMOG+NO<sub>x</sub> standards.

As discussed in Section IV.A.2.c above, for LDVs and LDTs above 6,000 lbs GVWR and MDPVs, EPA is providing an alternative phase-in of the 50 mg/mi SFTP NMOG+NO<sub>x</sub> standard.

#### b. US06 PM Standards

We are finalizing a single short-term US06 PM standard of 10 mg/mi for MYs 2017 and 2018 (or only for MY 2018 for LDVs and LDTs over 6,000 lbs GVWR and MDPVs) and a single long-term standard of 6 mg/mi for MY 2019 and later. These standards are numerically lower than those we proposed, and less complex in their structure. As discussed

below and in Chapter 1 of the RIA, a substantial body of more recent PM data from a variety of vehicles tested on the US06 cycle has given us greater understanding of the feasible level of control of these emissions, both currently and in the timeframe of the Tier 3 standards, including what level of control we may reasonably require for the light-duty fleet. The standards we are finalizing reflect this review. Much of the more recent data was developed late in the development of the NPRM and, although we made it available in the rulemaking docket to inform potential commenters, the proposed standards did not reflect consideration of the newer data. Since the NPRM, additional data from CARB have become available, and we have considered all of this information in finalizing the US06 PM standards.

We believe that the fully phased-in US06 PM standard of 6 mg/mi will achieve the goal that we presented in the NPRM—to maintain the performance being achieved by current well-performing vehicles taking into account reasonable compliance margins. Comments from stakeholders representing states, including CARB, and several NGOs urged EPA to finalize more stringent standards than those proposed, in some cases advocating for standards below 6 mg/mi. Conversely, auto industry commenters generally supported the proposed standards. We have concluded that the body of recent data clearly shows that the long-term 6 mg/mi standard, is the appropriate level to prevent any significant “backsliding” in US06 PM emissions as new vehicles and technologies enter the fleet. At the same time, the 6 mg/mi standard provides a reasonable compliance margin—about 50% above the average levels of current vehicles, which are averaging about 4 mg/mi. A long-term standard numerically lower than 6 mg/mi would run counter to our intent to bring the emissions performance of all vehicles to that already being demonstrated by many vehicles in the current light-duty fleet. We believe the long-term US06 PM standard we are finalizing is appropriate based on all of the information available at this time and will not hinder introduction of new technologies manufacturers may choose for compliance with the other Tier 3 standards or other rules.

The short-term, less-stringent US06 standard of 10 mg/mi (applicable in MYs 2017 and 2018) responds to automaker concerns about uncertainties stemming from simultaneous regulatory requirements and rapidly evolving exhaust and engine technologies in the coming years. We recognize that vehicle control technologies for both criteria and GHG emissions are evolving and will continue to do so, including an expected expansion of gasoline direct injection (GDI) technologies (see IV.A.5.c and the RIA). Also, the transition to lower sulfur in-use gasoline required by this rule may create temporary additional challenges in consistently achieving lower US06 PM emissions (see IV.A.6 and the RIA). We believe that most manufacturers will implement similar if not identical emission control strategies to comply (or, more often, to continue to comply with) with both the 10 mg/mi and the 6 mg/mi standards. In so doing, we expect them to use the temporary additional compliance margin provided by the 10 mg/mi standard to reduce uncertainties about potential variability in performance (in use and, in particular, later in vehicle life) during the early years of developing and commercializing their control technologies.<sup>257</sup>

The 10 mg/mi standard will expire after MY 2018, and the long-term standard of 6 mg/mi will take effect. As the implementation of the program continues, we believe a limited degree of relief for testing of in-use vehicles is appropriate. Manufacturers commented

that because of the industry's general lack of experience with stringent PM standards, especially as the newly-designed vehicles age, less stringent standards for in-use testing would reduce near-term concerns about performance variability early in the program. We agree, and we are finalizing a separate standard of 10 mg/mi for in-use vehicle testing for the intermediate years of the program, MYs 2019 through MY 2023. This standard is numerically lower than the proposed in-use standards—again because of the availability of improved US06 test data as described above—but the purpose of providing an in-use standard remains the same. The in-use standard, in conjunction with the short-term 10 mg/mi standard represents a longer duration for the in-use standard than we had proposed, again based on comments from the industry about their compliance concerns with new US06 standards. For MY 2024 and later, there will be no separate in-use standard and all vehicles will need to meet the long-term standard at certification and in use.

EPA proposed that different US06 PM standards apply to lighter and heavier vehicles. The newer US06 PM test data discussed above also make clear that the US06 PM performance of current vehicles is not closely related to vehicle weight, although the earlier data had indicated that this might be the case. Several commenters urged EPA to finalize a single standard for vehicles above and below 6,000 lbs GVWR based on the newer data. At the same time, auto manufacturers generally supported

the proposed vehicle weight distinction, asserting a higher degree of uncertainty about the emission performance of their larger vehicles, especially in the early years of the program and in light of simultaneous technology challenges. The newer data clearly show that larger vehicles today are generally achieving US06 PM levels very similar to smaller vehicles, and well below the proposed standards. We are not finalizing separate US06 standards for heavier and lighter vehicles because separate standards are unwarranted based on a review of the newer data. However, we believe that the short-term 10 mg/mi standard, as well as the temporary in-use vehicle testing standard, will significantly reduce manufacturer compliance uncertainties in the early years of the program for all vehicles, as discussed above.

As with the FTP PM standards, manufacturers will comply with the US06 PM standards with the same increasing minimum percentage of their vehicles, as shown in Table IV.5. Also as with the FTP PM phase-in, we are providing the option for a manufacturer to choose to certify 10 percent of its total light-duty vehicle sales in MY 2017 to the new US06 PM standards, including light-duty vehicles over 6,000 lbs GVWR.

As discussed in Section IV.A.2.c above, for LDVs and LDTs more than 6,000 lbs GVWR and MDPVs, EPA is also providing an alternative phase-in of the US06 PM standards.

All of the SFTP/US06 standards are shown in Table IV-4 and Table IV-5.

TABLE IV-4—TIER 3 LDV, LDT, AND MDPV SFTP COMPOSITE FLEET AVERAGE STANDARDS

	Model year								
	2017 <sup>a</sup>	2018	2019	2020	2021	2022	2023	2024	2025 and later
NMOG+NO <sub>x</sub> (mg/mi) .....	103	97	90	83	77	70	63	57	50
CO (g/mi) .....	4.2 <sup>a</sup>								

<sup>a</sup>For LDVs and LDTs above 6,000 lbs GVWR and MDPVs, the NMOG+NO<sub>x</sub> and CO standards apply beginning in MY 2018.

TABLE IV-5—SUMMARY OF LDV, LDT, AND MDPV TIER 3 SFTP STANDARDS

Program element	Units	Model year								Notes
		2017 <sup>a</sup>	2018	2019	2020	2021	2022	2023	2024+	
NMOG+NO <sub>x</sub> Standard (fleet average) .....	mg/mi ..	Per declining fleet average for cars and trucks (see Table IV-4) <sup>b</sup>								
PM Standards: <i>Phase-in</i> .....	% .....	20 <sup>c</sup>	20	40	70	100	100	100	100	

<sup>257</sup> We note that the purpose of the percent phase-in schedule for the FTP and US06 PM standards is to facilitate the expansion of manufacturers' PM testing facilities, which have been relatively limited in their availability prior to these new emission

standards. While effectively providing more time for technology development as well as for expansion of facilities, we believe that the PM standards are designed to be fully feasible in the early years of the program and do not themselves

require the phase-in relief, especially given the short-term 10 mg/mi standard and the temporary relaxed in-use testing standards.

TABLE IV-5—SUMMARY OF LDV, LDT, AND MDPV TIER 3 SFTP STANDARDS—Continued

Program element	Units	Model year								Notes	
		2017 <sup>a</sup>	2018	2019	2020	2021	2022	2023	2024+		
US06:											
LDV, LDT, MDPV: Certification .....	mg/mi ..	10	10	6	6	6	6	6	6	6	Note d.
LDV, LDT, MDPV: In-Use .....				10	10	10	10	10	10		

<sup>a</sup> For LDVs and LDTs above 6,000 lbs GVWR and MDPVs, the standards apply beginning in MY 2018.

<sup>b</sup> The percent phase-in does not apply to the declining fleet average standards.

<sup>c</sup> Manufacturers comply in MY 2017 with 20 percent of their LDV and LDT fleet under 6,000 lbs GVWR, or alternatively with 10 percent of their total LDV, LDT, and MDPV fleet.

<sup>d</sup> Manufacturers must test 25 percent of each model year's durability groups, minimum of 2.

c. Enrichment Limitation for Spark-Ignition Engines

To prevent emissions that result from excessive enrichment from auxiliary emission control devices (AECD) that are substantially present during the SFTP cycles, we are finalizing limitations on the magnitude of enrichment that can be commanded, including enrichment episodes encountered during in-use operation. During conditions where enrichment is demonstrated to be present on the SFTP, the nominal air-to-fuel ratio cannot be richer at any time than the leanest air-to-fuel ratio required to obtain maximum torque (lean best torque or LBT). An air-to-fuel ratio of LBT plus a tolerance of 4 percent additional enrichment will be allowed in actual vehicle testing to protect for any in-use variance in the air-to-fuel ratio from the nominal LBT air-to-fuel determination, for such reasons as air or fuel distribution differences from production variances or aging.

LBT is defined as the leanest air-to-fuel ratio required at a speed and load point with a fixed spark advance to make peak torque. Specifically, an increase in fuel will not result in an increase in torque while maintaining a fixed spark advance. LBT is determined by setting the spark advance to a setting that is less than or equal to the spark advance required for best torque (MBT) and maintaining that spark advance when sweeping the air-to-fuel ratio. This fixed spark advance requirement is intended to prevent torque changes related to spark changes masking true LBT. One manufacturer commented that there is no universally accepted definition or procedure to determine LBT so we should retain the Tier 2 LBT requirements. We believe that the proposed definition provides sufficient clarity and will generally agree with most manufacturers' internal definition of LBT. Additionally, we are finalizing the flexibility that manufacturers may request approval of an alternative LBT definition for a unique technology or

control strategy. The Agency may determine that an enrichment amount is excessive or not necessary and therefore deem that the approach does not meet the air-to-fuel ratio requirements.

Enrichment required for thermal protection will continue to be allowed upon demonstration of necessity to the Agency, based upon temperature limitations of the engine or exhaust components. Manufacturers will be required to provide descriptions of all components requiring thermal protection, temperature limitations of the components, how the enrichment strategy will detect over-temperature conditions and correct them, and a justification regarding why the enrichment is the minimum necessary to protect the specific components. The Agency may determine that the enrichment is not justified or is not the minimum necessary based on the use of engineering judgment using industry-reported thermal protection requirements.

A manufacturer commented that this requirement to report enrichment requirements for component protection for every application is burdensome and unnecessary. EPA believes that closer review of off-cycle enrichment by the agency, including enrichment for component protection, is necessary to ensure emissions are well controlled under all operating conditions. While this requirement may in some cases require additional resources at certification, this information has generally been required to be maintained by manufactures to support use of enrichment as an auxiliary emission control device (AECD) and therefore should be an exercise of reporting existing records for most manufacturers.

The requirements described in this section apply for vehicles certified to any of the Tier 3 standards.

5. Feasibility of the NMOG+NO<sub>x</sub> and PM Standards

In the proposal, we concluded that all of the Tier 3 emissions standards are

technologically feasible in the time frame of the program. The technical conclusions we reached at that time have been further reinforced by information we received in the public comments or has otherwise become available and placed in the docket for this rulemaking. After considering the comments received and with additional supporting information in Chapter 1 of the RIA, we conclude that the Tier 3 standards are feasible and reasonable, considering lead-time provided and expected compliance costs.

For each of the emission standards, the lead time provided by the program is more than sufficient for all manufacturers to comply. First, manufacturers in many cases are already adopting complying technologies for reasons other than this rulemaking. For example, many of the technologies that manufacturers have begun to develop for model years as early as MY 2014 in response to the CARB LEV III FTP and SFTP NMOG+NO<sub>x</sub> standards for the California market will likely represent steps toward compliance with this national program. Similarly, manufacturers have been producing some limited vehicle offerings since as early as MY 2000 that comply with our final MY 2025 standards in response to the CARB PZEV requirements. In addition, as described above, our program incorporates a number of phase-in provisions that will ease the transition to compliance, including time some manufacturers may need to install PM testing capability and to ramp up production on a national scale. This feasibility assessment is based on a variety of complementary technical data, studies, and analyses. As described below, these include our analysis of the stringency of the standards as compared to current Tier 2 emission levels. We also discuss below our observation that manufacturers are currently certifying several vehicle models under the California LEV II program that could likely achieve the Tier 3 NMOG+NO<sub>x</sub> and PM standards or similar levels. EPA has assessed the

emissions control challenges manufacturers will generally face (e.g., cold start NMOG reductions and running (warmed-up) NO<sub>x</sub> emissions under typical and more aggressive driving conditions) and the corresponding technologies that we expect to be available to manufacturers to meet these challenges. Our feasibility assessment accounts for the fact that the Tier 3 program will apply to all types of new vehicles, ranging from small cars to large pick-up trucks and MDPVs and representing a wide diversity in applications and in specific engine designs.

It is important to note that our primary assessment of the feasibility of engine and emission control technologies is based on the assumption that vehicles will be certified on gasoline with a fuel sulfur content of 10 ppm and operated on in-use gasoline with an average of 10 ppm sulfur.<sup>258</sup> Therefore, our primary assessment does not incorporate the degradation of emission control system caused by higher levels of sulfur content, as is discussed in Section IV.A.6 below and further discussed in the RIA. This assessment reinforces the critical role of gasoline sulfur control in making it possible for EPA to establish emission standards at these very stringent levels. See Section IV.6 below for a full discussion of our current knowledge of the effects of gasoline sulfur on current Tier 2 vehicle emissions as well as our projections of how we expect that sulfur will affect compliance on vehicles with standards in the range of the Tier 3 standards. The projections are based on extensive EPA testing of Tier 2 vehicles as well as targeted evaluation of passenger cars and heavier trucks performing at or near the Tier 3 Bin 30 (30 mg/mi NMOG+NO<sub>x</sub>) including manufacturer supplied data of a prototype Tier 3 light-duty truck as discussed in Section IV.6.

Since there are multiple aspects to the Tier 3 program, it is necessary to consider technical feasibility in light of the different program requirements and their interactions with each other. In many cases, manufacturers will be able to address more than one requirement with the same general technological approach (e.g., faster catalyst light-off can improve both FTP NMOG+NO<sub>x</sub> and PM emissions). At the same time, the feasibility assessment must consider that different technologies may be needed on different types of vehicle

applications (e.g., cars versus trucks) and must consider the relative effectiveness of these technologies in reducing emissions for the full useful life of the vehicle while operating on expected in-use fuel. For example, certain smaller vehicles with correspondingly small engines may be less challenged to meet FTP standards than larger vehicles with larger engines. Conversely, these smaller vehicles may have more difficulty meeting the more aggressive SFTP requirements than vehicles with larger and more powerful engines. Additionally, the ability to meet the SFTP emission requirements can also be impacted by the path taken to meet the FTP requirements (e.g., larger volume catalysts for US06 emissions control vs. smaller catalysts for improved FTP cold-start emissions control). Throughout the following discussion, we address how these factors, individually and in interaction with each other, affect the feasibility of the final program.

#### a. FTP NMOG+NO<sub>x</sub> Standards

The Tier 3 emission requirements include stringent NMOG+NO<sub>x</sub> standards on the FTP that will require new vehicle hardware in order to achieve the 30 mg/mi fleet average level in MY 2025. The type of new hardware that will be required will vary depending on the specific application and emission challenges. Smaller vehicles with corresponding smaller engines will generally need less new hardware while larger vehicles may need additional hardware and improvements beyond what will be needed for the smaller vehicles. While some vehicles, especially larger light trucks, may face higher costs in meeting the standards, it is important to remember that not every vehicle needs to meet the standard. The program has been structured to provide higher emission standard "bins" (see Table IV-1 above) to which manufacturers may certify more challenged vehicles, so long as these vehicles are offset with vehicles certified in lower emission bins such that the fleet-wide average meets the standards. We believe that the availability of the less-stringent bins will allow for the balancing of feasibility and cost considerations of compliance strategies for all vehicles. In the Tier 2 program, manufacturers took advantage of this flexibility, especially in the early years of the program. Then, as technologies improved and/or became less expensive and the need for averaging diminished, manufacturers began certifying all or most of their fleets to the average bin (Tier 2 Bin 5). We anticipate that manufacturers will

follow a similar trend with the Tier 3 standards, relying on fleet averaging more significantly in the transitional years but certifying increasing numbers of their vehicles to the final fleet average standard of 30 mg/mi in the later years of the program.

In order to assess the technical feasibility of a 30 mg/mi NMOG+NO<sub>x</sub> national fleet average FTP standard, EPA conducted two supporting analyses. The initial analyses performed were of the current Tier 2 and LEV II fleets. This provided a baseline for the current federal fleet emissions performance, as well as the emissions performance of the California LEV II fleet. The second consideration was a modal analysis of typical vehicle emissions under certain operating conditions. In this way EPA determined the specific emissions performance challenges that vehicle manufacturers will face in meeting the lower fleet average emission standards. Each of these considerations is described in greater detail below.

The current Tier 2 federal fleet is certified to an average of Tier 2 Bin 5, equivalent to 160 mg/mi NMOG+NO<sub>x</sub>.<sup>259</sup> As an example, for MY 2009 when the Tier 2 program was fully implemented across all vehicle types, 92 percent of LDVs and LDT1s were certified to Tier 2 Bin 5 and 91 percent of LDT2s through LDT4s were certified to Tier 2 Bin 5. This trend has generally continued through MY 2013 as the most recent certification results indicate that manufacturers are continuing to certify primarily to Tier 2 Bin 5 standards for the federal fleet however there has been a shift to more certifications using the cleaner bins as discussed in the RIA. This is not an unexpected result as there is no motivation prior to implementation of the Tier 3 rulemaking for vehicle manufacturers to produce a federal fleet that over-complies with respect to the existing Tier 2 standards. By comparison, in the California fleet where compliance with the declining fleet average NMOG requirement and the "PZEV" program requires manufacturers to certify vehicles to cleaner levels, only 30 percent of the LDVs and LDT1s are certified to Tier 2 Bin 5 and 60 percent are certified to cleaner bins such as Tier 2 Bin 3 and 4. The situation regarding the truck fleet in California is similarly stratified, with 37 percent of the LDT2s through LDT4s being certified to Tier 2

<sup>258</sup> Our technology, feasibility, and cost assessments are also consistent with an assumption that certification fuel will contain 10 percent ethanol and will have other properties as specified in Section IV.F below.

<sup>259</sup> The Tier 2 program does not combine NMOG and NO<sub>x</sub> emissions into one fleet-average standard. The fleet-average standard in that program is for NO<sub>x</sub> emissions alone. The NO<sub>x</sub> fleet-average requirement of .07 gm/mi is the same level as the Bin 5 NO<sub>x</sub> standard.



Bin 5 and 55 percent being certified to the cleaner Tier 2 Bin 3 and 4. In many cases identical vehicles are being certified to a lower standard in California and a higher standard federally simply because there is no incentive to over perform to the federal standards. We note that vehicles certified to a lower standard in California are operated on gasoline with an average sulfur content of 10 ppm and thereby are able to maintain their emissions performance in-use. Based on these patterns of federal and California certification, EPA believes that much of the existing Tier 2 fleet could currently be certified to a lower federal fleet average immediately, with no significant feasibility concerns, if lower sulfur gasoline were made available nationwide.

Regardless of the Tier 2 bin standards at which manufacturers choose to certify their vehicles, actual measured emissions performance of these vehicles is typically well below the numerical standards. This difference is referred to as “compliance margin” and is a result of manufacturers’ efforts to address all the sources of variability, including:

- Test-to-test variability (within one test site and lab-to-lab)
- Build variation expectations
- Manufacturing tolerances and stack-up
- Vehicle operation (for example: driving habits, ambient temperature, etc.)
- Fuel composition
- The effects of fuel sulfur on exhaust catalysts and oxygen sensors
- The effects of other fuel components, including ethanol and gasoline additives
- Oil consumption
- The impact of oil additives and oil ash on exhaust catalysts and oxygen sensors

For MY 2009 thru MY 2013, the compliance margin for a Tier 2 Bin 5 vehicle averaged approximately 60 percent. In other words, actual vehicle emissions performance was on average about 40 percent of a 160 mg/mi NMOG+NO<sub>x</sub> standard, or about 64 mg/mi. By comparison, for California-certified vehicles, the average Super Ultra Low Emission Vehicle (SULEV) compliance margin was somewhat less for the more stringent standards, approximately 50 percent. We believe that the recent California experience is a likely indicator of compliance margins that manufacturers will design for in order to comply with the Tier 3 FTP standards. Thus, a typical Tier 2 Bin 5 vehicle, performing at 40 percent of the current standard (i.e., at about 64 mg/

mi) will need improvements sufficient to reach about 15 mg/mi (50 percent of a 30 mg/mi standard).

To understand how the several currently-used technologies described below could be used by manufacturers to reach the stringent Tier 3–NMOG+NO<sub>x</sub> standards, it is helpful to consider emissions formation in common modes of operation for gasoline engines, or modal analysis.<sup>260</sup> The primary challenge faced by manufacturers for producing Tier 3 compliant light-duty gasoline vehicle powertrains will be keeping warmed-up running emissions at effectively zero emissions levels while reducing the emissions during cold-start operation which, based on modal analysis of a gasoline-powered vehicle being operated on the FTP cycle, occurs during about the first 50 seconds after engine start. Thus, we believe that to comply with the Tier 3 FTP standards, manufacturers will focus on effective control of these cold-start emissions while maintaining zero running emissions; this is only possible when sulfur levels in the fuel do not degrade catalyst performance. As discussed below, light-duty manufacturers are already applying several technologies capable of significant reductions in these cold start emissions to vehicles currently on the road.

During the analysis of current vehicles certified to the cleanest emission levels (Tier 2 Bin 2 and LEV II SULEV) it was noted that no large pick-ups equipped with their application specific engines were performing at the 30 mg/mi NMOG+NO<sub>x</sub> level. We believe that these applications may be the most challenging due to the fact that the design criteria required to provide the utility aspect may have direct impact on their ability to implement some of the technologies described in section IV.A.5.d below. Since these vehicles represent a substantial and important part of the light-duty fleet, EPA performed a technical feasibility study directly targeting this class of vehicles.

In order to assess the technical feasibility of a 30 mg/mi FTP NMOG+NO<sub>x</sub> standard, EPA purchased a 2011 Chevrolet Silverado heavy-light-duty (LDT4) pickup truck with a developmental goal of modifying the truck to achieve exhaust emission levels in compliance with the Tier 3 Bin 30 emissions standards including a reasonable compliance margin. The truck was equipped with a 5.3L V8 with

<sup>260</sup> A modal analysis provides a second-by-second view of the total amount of emissions over the entire cycle being considered.

General Motors’ “Active Fuel Management” cylinder deactivation system. This particular truck was chosen as an example of a Tier 3 prototype in part because cylinder deactivation is a key technology for light-truck compliance with future GHG standards and in part because it achieved very low emissions in the OEM, Tier 2-compliant configuration (certified to Tier 2 Bin 4). A prototype exhaust system was obtained from MECA consisting of high-cell-density (900 cpsi) thin-wall (2.5 mil), high-PGM, close-coupled Pd-Rh catalysts with an additional under-body Pd-Rh catalyst. The total catalyst volume was approximately 116 in<sup>3</sup> with a specific PGM loading of 125 g/ft<sup>3</sup> and approximate loading ratio of 0:80:5 (Pt:Pd:Rh). Third-party (non-OEM) EMS calibration tools were used to modify the powertrain calibration in an effort to improve catalyst light-off performance. The final test configuration used approximately 4 degrees of timing retard and approximately 200 rpm higher idle speed relative to the OEM configuration during and immediately following cold-start. The exhaust catalyst system and HEGO sensors were bench aged to an equivalent 150,000 miles using standard EPA accelerated catalyst bench-aging procedures. The truck was tested on California LEV III E10 certification fuel at 9 ppm gasoline sulfur levels.

The EPA Tier 3 prototype Silverado achieved NMOG+NO<sub>x</sub> emissions of 18 mg/mi on the 9 ppm S fuel. The NMOG+NO<sub>x</sub> emissions were approximately 60% of the Bin 30 standard and thus are consistent with meeting the Tier 3 Bin 30 exhaust emissions standard with a moderate compliance margin. The technologies used on the prototype Silverado to achieve these emission levels are common approaches used today on smaller vehicles. They do not compromise any of the design utility of this vehicle class and are some of the same approaches we expect manufacturers to use to meet the Tier 3 Bin 30 exhaust emissions standards.

#### b. SFTP NMOG+NO<sub>x</sub> Standards

The increase in the stringency of the SFTP NMOG+NO<sub>x</sub> standards, specifically across the US06 cycle, will generally only require additional focus on fuel control of the engines and diligent implementation of new technologies that manufacturers are already introducing or are likely to introduce in response to the current and 2017 LD GHG emission standards. These include downsized gasoline direct injection (GDI) and turbocharged engines, which may also include

improvements to the engine and emission control hardware to tolerate higher combustion and exhaust temperatures expected in these future GHG-oriented engine designs when under higher loads. The upgraded materials or components will enable manufacturers to rely less on fuel enrichment during high-speed/high-load operation to protect components from overheating. This fuel enrichment is currently the source of elevated VOC, NO<sub>x</sub>, and PM emissions seen in a subset of the current Tier 2 fleet.

With respect to enrichment, the primary method available to manufacturers to protect the catalyst and other exhaust components from over-temperature conditions has been changes to the fuel/air mixture by increasing the fuel fraction, but this is no longer the only tool available to manufacturers for this purpose. With the application of electronic throttle controls, variable valve timing, exhaust gas recirculation and other exhaust temperature influencing technologies on nearly every light-duty vehicle, the manufacturer has the ability to systematically control the operation and combustion processes of the engine to minimize or altogether avoid areas and modes of operation where thermal issues can occur. While some of these solutions could in some cases result in a small and temporary reduction in vehicle performance (absolute power levels), we believe that it could be an effective way to reduce NMOG+NO<sub>x</sub> emissions over the SFTP test.

Additionally, some components, especially catalysts, can experience accelerated thermal deterioration that occurs when operating at higher temperatures for more time than expected under normal operation (e.g., trailer towing, mountain grades). Some upgrades of existing vehicle emission control technology, like catalyst substrates and washcoats may be required to limit thermal deterioration and ensure vehicle emissions compliance throughout the useful life of the vehicle.

In order to assess the technical feasibility of a 50 mg/mi NMOG+NO<sub>x</sub> national fleet average SFTP standard, EPA conducted an analysis of SFTP levels of Tier 2 and LEV II vehicles. The analysis was performed on the US06 results from current Tier 2 and LEV II vehicles tested in the in-use verification program (IUVP) by manufacturers and submitted to EPA. This analysis provided a baseline for the current Tier 2 and LEV II fleet emissions performance, as well as the SFTP emissions performance capability of the cleanest vehicles meeting the Tier 3 FTP

standards. The analysis concluded that most vehicles in the IUVP testing program are already capable of meeting the composite SFTP standard of 50 mg/mi when the Tier 3 FTP standard levels are factored into the composite calculation. With the technological improvements already underway as discussed above, we believe all MY 2017 and later vehicles will be able to comply with the SFTP standards, either directly or through the flexibility of the averaging, banking and trading program. For further information on the analysis see Chapter 1 of the RIA.

#### c. FTP and SFTP PM Standards

As described above for NMOG+NO<sub>x</sub> over the SFTP, the increase in the stringency of the FTP and SFTP PM standards will generally also only require additional focus on fuel control of the engines and attention to PM emissions during the implementation of new technologies like gasoline direct injection (GDI) and turbocharged engines. Some upgrades of existing vehicle emission control technology may be required to ensure vehicle emissions performance is maintained throughout the useful life of the vehicle. These upgrades may include improvements to the engine to control wear that could result in increased PM from oil consumption and selection of GDI systems that will be capable of continuing to perform optimally even as the systems age.

We based our conclusions about the ability of manufacturers to meet the PM standards largely on the PM performance of the existing fleet, both on the FTP and SFTP. In the case of FTP testing of current vehicles, data on both low and high mileage light-duty vehicles demonstrate that the majority of vehicles are currently achieving levels at or below the Tier 3 FTP PM standards.

The testing results can be found in Chapter 1 of the RIA. A small number of vehicles are at or just over the Tier 3 FTP PM standard at low mileage and could require calibration changes and/or catalyst changes to meet the new standards. It is our expectation that the same calibration and catalyst changes required to address NMOG will also provide the necessary PM control. Vehicles that currently have higher PM emissions over the FTP or SFTP at higher mileages will likely be required to control oil consumption and combustion chamber deposits.

We also analyzed PM test data results on the US06 test cycle from Tier 2 vehicles. The data show that many vehicles are already at or below the Tier 3 standards on the US06 test cycle.

Vehicles that have high PM emission rates on the US06 will likely need to control enrichment and oil consumption, particularly later in life. As described above for SFTP NMOG+NO<sub>x</sub> control, enrichment can be more accurately managed through available electronic engine controls. The strategies for reducing oil consumption are similar to those described above for controlling oil consumption on the FTP. However, given the higher engine speeds experienced on the US06 and the increase in oil consumption that can accompany this kind of operation, manufacturers will most likely focus on oil sources stemming from the piston to cylinder interface and positive crankcase ventilation (PCV).

Manufacturers have informed us that they have already reduced or are planning to reduce the oil consumption of their engines by improved sealing of the paths of oil into the combustion chamber and improved piston-to-cylinder interfaces. Auto manufacturers have stated that they are already taking or considering these actions to address issues of customer satisfaction and cost of ownership. In addition, many vehicle manufacturers acknowledge the relationship between combustion chamber deposits and PM formation and are actively pursuing design changes to mitigate fuel impingement within the combustion chamber and its commensurate PM effects. Both types of controls are being widely applied by manufacturers today.

#### d. Technologies Manufacturers Are Likely To Apply

Most of the technologies expected to be applied to light-duty vehicles to meet the stringent Tier 3 standards will address the emissions control system's ability to reduce emission during cold start while maintaining zero or near zero running emissions. The effectiveness of current vehicle emissions control systems at reducing cold start emissions depends in large part on the time it takes for the catalyst to light off, which is typically defined as the catalyst reaching a temperature of 250 °C. In order to improve catalyst light-off, we expect that manufacturers will add technologies that provide heat from combustion more readily to the catalyst or improve the catalyst efficiency at lower temperatures. These technologies include calibration changes, catalyst platinum group metals (PGM) loading and strategy, thermal management, close-coupled catalysts, and secondary air injection, all which generally improve emission performance of all pollutants. In some cases where the catalyst light-off and efficiency are not

enough to address the cold start NMOG emissions, hydrocarbon adsorbers may be applied to trap hydrocarbons until such time that the catalyst is lit off. Note that with the exception of hydrocarbon adsorbers each of these technologies addresses NMOG, NO<sub>x</sub>, and PM performance. The technologies are described in greater detail below. Additional information on these technologies can also be found in Chapter 1 of the RIA.

- **Engine Control Calibration Changes**—These include changes to retard spark and/or adjust air/fuel mixtures such that more combustion heat is created during the cold start. Control changes may include injection strategies in GDI applications, unique cold-start variable valve timing and lift, and other available engine parameters. Engine calibration changes can affect NMOG, NO<sub>x</sub> and PM emissions.

- **Catalyst PGM Loading**—Additional PGM loading, increased loading of other active materials, and improved dispersion of PGM and other active materials in the catalyst provide a greater number of sites available to catalyze emissions and addresses NMOG, NO<sub>x</sub> and PM emissions. Catalyst PGM loading, when implemented in conjunction with low sulfur gasoline, will effectively eliminate NO<sub>x</sub> emissions under warmed-up conditions.

- **Thermal Management**—This category of technologies includes all design attributes meant to conduct the

combustion heat into the catalyst with minimal cooling. This includes insulating the exhaust piping between the engine and the catalyst, reducing the wetted area of the exhaust path, reducing the thermal mass of the exhaust system, and/or using close-coupled catalysts (i.e., the catalysts are packaged as close as possible to the engine's cylinder head to mitigate the cooling effects of longer exhaust piping). Thermal management technologies primarily address NMOG emissions, but also affect NO<sub>x</sub> and PM emissions.

- **Secondary Air Injection**—By injecting air directly into the exhaust stream, close to the exhaust valve, combustion can be maintained within the exhaust, creating additional heat by which to increase the catalyst temperature. The air/fuel mixture must be adjusted to provide a richer exhaust gas for the secondary air to be effective. There can be a NO<sub>x</sub> emissions disbenefit to use of secondary air injection since it can impact the ability of oxygen storage components (OSC) within the catalyst to take up excess oxygen as necessary to promote NO<sub>x</sub> reduction reactions immediately following cold start conditions.

- **Hydrocarbon Adsorber**—Traps hydrocarbons during a cold start until the catalyst lights off, and then releases the hydrocarbons to be converted by the catalyst.

- **Gasoline Sulfur**—The relative effectiveness for NMOG and NO<sub>x</sub> control of the exhaust-catalyst related

technologies is constrained by gasoline fuel sulfur levels. Thus, reduced sulfur in gasoline is an enabling technology to achieve the standards and maintain this performance during in-use operation. We discuss the relationship between gasoline sulfur and emissions in greater detail in Section IV.6 below and in the RIA.

Several commenters indicated that large light-duty trucks (e.g., pickups and full-size sport utility vehicles (SUVs) in the LDT3 and LDT4 categories) will be the most challenging light-duty vehicles to bring into compliance with the Tier 3 NMOG+NO<sub>x</sub> standards at the 30 mg/mi corporate average emissions level. A similar challenge was addressed when large light-duty trucks were brought into compliance with the Tier 2 standards over the past decade. Figure IV-1 provides a graphical representation of the effectiveness of Tier 3 technologies for large light-duty truck applications. A compliance margin is shown in both cases. Note that the graphical representation of the effectiveness of catalyst technologies on NO<sub>x</sub> and NMOG when going from Tier 2 to Tier 3 levels also includes a reduction in gasoline sulfur levels from 30 ppm to 10 ppm.

<sup>261</sup> The technologies and levels of control in this figure are based on a combination of confidential business information submitted by auto manufacturers and suppliers, public data, and EPA staff engineering judgment.

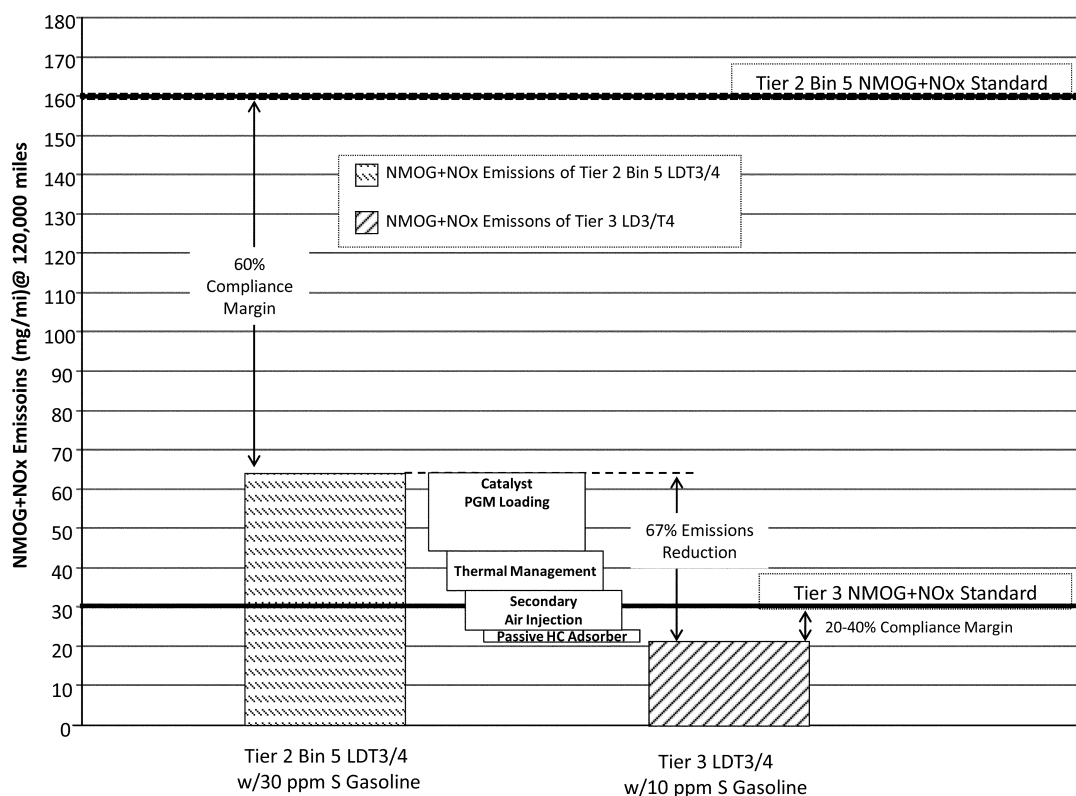

**Figure IV-1: Contribution of Tier 3 Technologies to Large Light-Duty Truck Compliance<sup>261</sup>**

#### 6. Impact of Gasoline Sulfur Control on the Effectiveness of the Vehicle Emission Standards

In this section, we discuss the impact of gasoline sulfur control on the feasibility of the Tier 3 vehicle emissions standards and on the exhaust emissions of the existing in-use vehicle fleet. Section IV.A.6.a describes the chemistry and physics of the impacts of gasoline sulfur compounds on exhaust catalysts. Sections IV.A.6.b, c and d summarize research on the impacts of gasoline sulfur on vehicles utilizing various degrees of emission control technology, with Section IV.A.6.b summarizing historical studies on the impact of gasoline sulfur on vehicle emissions, Section IV.A.6.c describing impacts on Tier 2 vehicles and the existing light-duty vehicle fleet, and Section IV.A.6.d describing impacts on vehicles using technology consistent with what we expect to see in the future Tier 3 vehicle fleet. Section IV.A.6.e provides EPA's assessment of the level of gasoline sulfur control necessary for light-duty vehicles to comply with Tier 3 exhaust emission standards.

EPA's primary findings are:

- Reducing gasoline sulfur content to a 10 ppm average will provide immediate and significant exhaust emissions reductions to the current, in-use fleet of light-duty vehicles.

- Reducing gasoline sulfur content to an average of 10 ppm will enable vehicle manufacturers to certify their entire product lines of new light-duty vehicles to the final Tier 3 30 fleet average standards. Without such sulfur control it would not be possible for vehicle manufacturers to reduce emissions sufficiently below Tier 2 levels to meet the new Tier 3 standards because it would require offsetting significantly higher exhaust emissions resulting from the higher sulfur levels. EPA has not identified any existing or developing technologies that would compensate for or offset the higher exhaust emissions resulting from higher fuel sulfur levels.

#### a. Gasoline Sulfur Impacts on Exhaust Catalysts

Modern three-way catalytic exhaust systems utilize platinum group metals (PGM), metal oxides and other active materials to selectively oxidize organic compounds and carbon monoxide in the

exhaust gases. These systems simultaneously reduce NO<sub>x</sub> when air-to-fuel ratio control operates in a condition of relatively low amplitude/high frequency oscillation about the stoichiometric point. Sulfur is a well-known catalyst poison. There is a large body of work demonstrating sulfur inhibition of the emissions control performance of PGM three-way exhaust catalyst systems.<sup>262 263 264 265 266 267 268 269 270 271</sup>

<sup>262</sup> Beck, D.D., Sommers, J.W., DiMaggio, C.L. (1994). Impact of sulfur on model palladium-only catalysts under simulated three-way operation. *Applied Catalysis B: Environmental* 3, 205–227.

<sup>263</sup> Beck, D.D., Sommers, J.W. (1995). Impact of sulfur on the performance of vehicle aged palladium monoliths." *Applied Catalysis B: Environmental* 6, 185–200.

<sup>264</sup> Beck, D.D., Sommers, J.W., DiMaggio, C.I. (1997). Axial characterization of oxygen storage capacity in close coupled lightoff and underfloor catalytic converters and impact of sulfur. *Applied Catalysis B: Environmental* 11, 273–290.

<sup>265</sup> Waqif, M., Bazin, P., Saur, O. Lavalley, J.C., Blanchard, G., Touret, O. (1997). Study of ceria sulfation. *Applied Catalysis B: Environmental* 11, 193–205.

<sup>266</sup> Bazin, P., Saur, O. Lavalley, J.C., Blanchard, G., Visciglio, V., Touret, O. (1997). "Influence of platinum on ceria sulfation." *Applied Catalysis B: Environmental* 13, 265–274.

The nature of sulfur interactions with washcoat materials, active catalytic materials and catalyst substrates is complex and varies with catalyst composition, exhaust gas composition and exhaust temperature. The variation of these interactions with exhaust gas composition and temperature means that the operational history of a vehicle is an important factor; continuous light-load operation, throttle tip-in events and enrichment under high-load conditions can all impact sulfur interactions with the catalyst.

Sulfur from gasoline is oxidized during spark-ignition engine combustion primarily to SO<sub>2</sub> and, to a much lesser extent, SO<sub>3</sub><sup>-2</sup>. Sulfur oxides selectively chemisorb with, and in some cases react with, active sites and coating materials within the catalyst, thus inhibiting the intended catalytic reactions. Sulfur oxides inhibit pollutant catalysis chiefly by selective poisoning of active PGM, ceria sites, and the alumina washcoating material (see Figure IV-2).<sup>272</sup> The amount of sulfur retained by an exhaust catalyst system is primarily a function of the concentration of sulfur oxides in the incoming exhaust gases, air-to-fuel ratio feedback and control by the engine management system, the operating temperature of the catalyst and the

active materials and coatings used within the catalyst.

In their supplemental comments to the Tier 3 proposal, API criticized the use of emissions data generated using gasoline with sulfur content outside of the range of 10 ppm to 30 ppm within EPA and other analyses of the impacts of gasoline sulfur on exhaust emissions from current in-use (Tier 2) and future (Tier 3) light-duty vehicles. Specific examples include:

- Comparisons of exhaust emissions at 5 ppm and 28 ppm gasoline sulfur levels within the recent EPA study of emissions from Tier 2 vehicles.<sup>273</sup>
- Comparison of exhaust emissions of a SULEV vehicle at 8 ppm and 33 ppm gasoline sulfur levels within the Takei et al. study.<sup>274</sup>
- Comparison of exhaust emissions of a PZEV vehicle at 3 ppm and 33 ppm gasoline sulfur levels within the Ball et al. study.<sup>275</sup>

The relationship between changes in gasoline sulfur content and NO<sub>x</sub>, HC, NMHC and NMOG emissions is typically linear. The linearity of sulfur impacts on NO<sub>x</sub>, NMHC and NMOG emissions is supported by past studies with multiple fuel sulfur levels all of which compare gasoline with differing sulfur levels that are below approximately 100 ppm (e.g., CRC E-60 and 2001 AAM/AIAM programs as well as comments on this rulemaking submitted by MECA).<sup>276 277 278</sup> An

assumption of linearity of the effect of gasoline sulfur level on catalyst efficiency between any two test fuels with differing sulfur levels is reasonable given that the mass flow rate of sulfur in exhaust gas changes in proportion to its concentration in the fuel, and that the chemistry of adsorption of sulfur on the active catalyst sites is an approximately-first-order chemisorption until all active sites within a catalyst reach an equilibrium state relative to further input of sulfur compounds. The relative linearity of the effect of gasoline sulfur level on NMOG and NO<sub>x</sub> emissions allows exhaust emissions results generated within EPA and other studies of gasoline sulfur at levels immediately above or below either 10 ppm or 30 ppm to be normalized to either 10 ppm sulfur (Tier 3 gasoline) or to 30 ppm sulfur (Tier 2 gasoline, which are used in the analysis of the impacts of the Tier 3 gasoline standards on existing in-use vehicles and future Tier 3 vehicles.

In their supplemental comments to the Tier 3 proposal, API also commented that EPA did not show the sulfur impact on exhaust emissions at intermediate sulfur levels between 10 ppm and 30 ppm. In response, based on the relative linearity of the effect of gasoline sulfur level on NMOG and NO<sub>x</sub> emissions allowing exhaust emissions to be estimated for gasoline sulfur levels between 10 and 30 ppm, data in EPA's analysis shows increases NMOG+NO<sub>x</sub> emissions (as fuel sulfur increases) that become more severe (i.e., higher percentage increase in NMOG+NO<sub>x</sub> emissions) for vehicles with extremely low<sup>279</sup> exhaust emission (SULEV, PZEV, LEV III, Tier 3) as described in further detail in Sections IV.A.6.d and e.

<sup>267</sup> Takei, Y., Kungasa, Y., Okada, M., Tanaka, T., Fujimoto, Y. (2000). Fuel Property Requirement for Advanced Technology Engines. SAE Technical Paper 2000-01-2019.

<sup>268</sup> Takei, Y., Kungasa, Y., Okada, M., Tanaka, T., Fujimoto, Y. (2001). "Fuel properties for advanced engines." *Automotive Engineering International* 109 12, 117-120.

<sup>269</sup> Kubsh, J.E., Anthony, J.W. (2007). The Potential for Achieving Low Hydrocarbon and NO<sub>x</sub> Exhaust Emissions from Large Light-Duty Gasoline Vehicles. SAE Technical Paper 2007-01-1261.

<sup>270</sup> Shen, Y., Shuai, S., Wang, J. Xiao, J. (2008). Effects of Gasoline Fuel Properties on Engine Performance. SAE Technical Paper 2008-01-0628.

<sup>271</sup> Ball, D., Clark, D., Moser, D. (2011). Effects of Fuel Sulfur on FTP NO<sub>x</sub> Emissions from a PZEV 4 Cylinder Application. SAE Technical Paper 2011-01-0300.

<sup>272</sup> Heck, R.M., Farrauto, R.J. (2002). Chapter 5: Catalyst Deactivation in *Catalytic Air Pollution Control, 2nd Edition*. John Wiley and Sons, Inc.

<sup>273</sup> The Effects of Ultra-Low Sulfur Gasoline on Emissions from Tier 2 Vehicles in the In-Use Fleet, EPA-420-R-14-002.

<sup>274</sup> Takei, Y., Kungasa, Y., Okada, M., Tanaka, T., Fujimoto, Y. (2000). Fuel Property Requirement for Advanced Technology Engines. SAE Technical Paper 2000-01-2019.

<sup>275</sup> Ball, D., Clark, D., Moser, D. (2011). Effects of Fuel Sulfur on FTP NO<sub>x</sub> Emissions from a PZEV 4 Cylinder Application. SAE Technical Paper 2011-01-0300.

<sup>276</sup> Coordinating Research Council. 2003. "The Effect of Fuel Sulfur on NH<sub>3</sub> and Other Emissions from 2000-2001 Model Year Vehicles." CRC Project No. E-60 Final Report. Accessed on the Internet on 12/4/2013 at the following URL: <http://www.crao.com/reports/recentstudies2003/E-60%20Final%20Report.pdf>.

<sup>277</sup> Alliance of Automobile Manufacturers. 2001. "AAM-AIAM Industry Low Sulfur Test Program."

<sup>278</sup> Manufacturers of Emission Controls Association. 2013. "The Impact of Gasoline Fuel Sulfur on Catalytic Emission Control Systems."

<sup>279</sup> Vehicles that meet the cleanest emission standards by demonstrate very low cold start NMOG and NO<sub>x</sub> emissions and zero or near-zero running NMOG and NO<sub>x</sub> emissions.

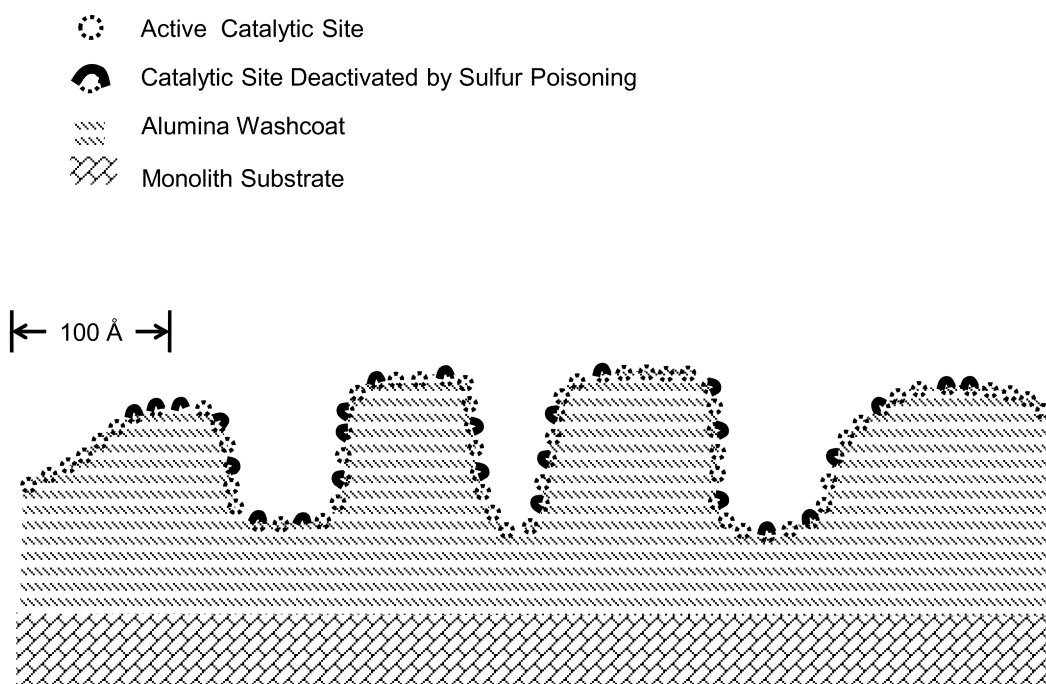

**Figure IV-2 Functional schematic showing selective poisoning of active catalytic sites by sulfur compounds. Adapted from Heck and Farrauto 2002.<sup>280</sup>**

Selective sulfur poisoning of platinum (Pt) and rhodium (Rh) is primarily from surface-layer chemisorption. Sulfur poisoning of palladium (Pd) and ceria appears to be via chemisorption combined with formation of more stable metallic sulfur compounds, e.g. PdS and Ce<sub>2</sub>O<sub>2</sub>S, present in both surface and bulk form (i.e., below the surface layer).<sup>281 282 283 284</sup> Ceria, zirconia and other oxygen storage components (OSC) play an important role that is crucial to NO<sub>x</sub> reduction over Rh as the engine air-to-fuel ratio oscillates about the stoichiometric closed-loop control

<sup>280</sup> Heck, R.M., Farrauto, R.J. (2002). Chapter 5: Catalyst Deactivation in *Catalytic Air Pollution Control, 2nd Edition*. John Wiley and Sons, Inc.

<sup>281</sup> Luo, T., Gorte, R.J. (2003). A Mechanistic Study of Sulfur Poisoning of the Water-Gas-Shift Reaction Over Pd/Ceria." *Catalysis Letters*, 85, Issues 3–4, pg. 139–146.

<sup>282</sup> Li-Dun, A., Quan, D.Y. (1990). "Mechanism of sulfur poisoning of supported Pd(Pt)/Al<sub>2</sub>O<sub>3</sub> catalysts for H<sub>2</sub>-O<sub>2</sub> reaction." *Applied Catalysis* 61, Issue 1, pg. 219–234.

<sup>283</sup> Waqif, M., Bazin, P., Saur, O., Lavalley, J.C., Blanchard, G., Touret, O. "Study of ceria sulfation." *Applied Catalysis B: Environmental* 11 (1997) 193–205.

<sup>284</sup> Bazin, P., Saur, O., Lavalley, J.C., Blanchard, G., Visciglio, V., Touret, O. "Influence of platinum on ceria sulfation." *Applied Catalysis B: Environmental* 13 (1997) 265–274.

point.<sup>285</sup> Ceria sulfation interferes with OSC functionality within the catalyst and thus can have a detrimental impact on the catalyst's ability to effectively reduce NO<sub>x</sub> emissions. Water-gas-shift reactions are important for NO<sub>x</sub> reduction over catalysts combining Pd and ceria. This reaction can be blocked by sulfur poisoning and may be responsible for observations of reduced NO<sub>x</sub> activity over Pd/ceria catalysts even with exposure to fairly low levels of sulfur (equivalent to 15 ppm in gasoline).<sup>286 287</sup> Pd is also of increased importance for meeting Tier 3 standards due to its unique application in the close-coupled-catalyst location required for vehicles certifying to very stringent emission standards. Close-coupling means that the exhaust catalyst is moved as close as possible to the engine's exhaust ports within the packaging constraints of an engine compartment. This ensures that the catalyst reaches its minimal operational,

<sup>285</sup> Heck, R.M., Farrauto, R.J. (2002). Chapter 6: Automotive Catalyst in *Catalytic Air Pollution Control, 2nd Edition*. John Wiley and Sons, Inc.

<sup>286</sup> Luo, T., Gorte, R.J. (2003) A Mechanistic Study of Sulfur Poisoning of the Water-Gas-Shift Reaction Over Pd/Ceria. *Catalysis Letters*, 85, Issues 3–4, pg. 139–146.

<sup>287</sup> Beck, D.D., Sommers, J.W. (1995) Impact of sulfur on the performance of vehicle aged palladium monoliths. *Applied Catalysis B: Environmental* 6, 185–200.

or "light-off", temperature as quickly as possible after the vehicle is started. It also means, however, that the exhaust catalyst(s) in the close-coupled location(s) are subject to higher exhaust temperatures during fully-warmed up operation. Pd is required in closed-coupled catalysts due to its resistance to high-temperature thermal sintering thereby maintaining sufficient durability of the emissions control system over the useful life of a vehicle. Sulfur removal from Pd requires rich operation at higher temperatures than required for sulfur removal from other PGM catalysts.

In addition to its interaction with catalyst materials, sulfur can also react with the wash-coating itself to form alumina sulfate, which in turn can block coating pores and reduce gaseous diffusion to active materials below the coating surface (see Figure IV–2).<sup>288</sup> This may be a significant mechanism for the observed storage of sulfur compounds at light and moderate load operation with subsequent, rapid release as sulfate particulate matter emissions

<sup>288</sup> Beck, D.D., Sommers, J.W. (1995) Impact of sulfur on the performance of vehicle aged palladium monoliths. *Applied Catalysis B: Environmental* 6, 185–200.

when high-load, high-temperature conditions are encountered.<sup>289</sup>

Operating the catalyst at a sufficiently high temperature under net reducing conditions (e.g., air-to-fuel equivalence that is net fuel-rich of stoichiometry) can effectively release the sulfur oxides from catalyst components. Thus, regular operation at sufficiently high temperatures at net fuel-rich air-to-fuel ratios can minimize the effects of fuel sulfur levels on catalyst active materials and catalyst efficiency; however, it cannot completely eliminate the effects of sulfur poisoning. In current vehicles, desulfurization conditions occur typically at high loads when there is a degree of commanded enrichment (i.e., fuel enrichment commanded by the engine management system primarily for protection of engine and/or exhaust system components). A study of Tier 2 vehicles in the in-use fleet recently completed by EPA<sup>290</sup> shows that emission levels immediately following high speed/load operation is still a function of fuel sulfur level for the gasoline used following desulfurization. If a vehicle operates on gasoline with less than 10 ppm sulfur, exhaust emissions stabilize over repeat FTP tests at emissions near those of the first FTP that follows the high speed/load operation and catalyst desulfurization. If the vehicle continues to operate on higher sulfur gasoline following desulfurization, exhaust emissions creep upward until a new equilibrium exhaust emissions level is established. This suggests that lower fuel sulfur levels achieve emission benefits unachievable by catalyst desulfurization procedures alone. Continued operation on gasoline with a 10 ppm average sulfur content or lower is necessary after catalyst desulfurization in order to achieve emissions reductions with the current in-use fleet.<sup>291</sup> Furthermore, regular operation at the high exhaust temperatures and rich air-to-fuel ratios necessary for catalyst desulfurization is not desirable and may not be possible for future Tier 3 vehicles for several reasons:

- Thermal sintering and resultant catalyst degradation: The temperatures necessary to release sulfur oxides are high enough to lead to thermal

degradation of the catalyst over time via thermal sintering of active materials. Sintering reduces the surface area available to participate in reactions and thus reduces the overall effectiveness of the catalyst.

- Operational conditions: It is not always possible to maintain fuel-rich operational conditions and exhaust catalyst temperatures that are high enough for sulfur removal because of cold weather, idle conditions and light-load operation.

- Increased emissions: In order to achieve greater emission reductions across a fuller range of in-use driving conditions, vehicle manufacturers' use of commanded enrichment, which has been beneficial for sulfur removal, will be greatly reduced or eliminated under Tier 3. Additionally, the fuel-rich air-to-fuel ratios necessary for sulfur removal from active catalytic surfaces would result in increased PM, NMOG, CO and air toxic emissions, particularly at the high-temperature, high load conditions (e.g., US06 or comparable) necessary for sulfur removal. Previously used levels of commanded enrichment (e.g., under Tier 2) would interfere with the strategies necessary to comply with more stringent Tier 3 SFTP exhaust emissions standards. There are also additional provisions within the Tier 3 standards that further restrict the use of US06 and off-cycle commanded enrichment in an effort to reduce high-load and off-cycle PM, NMOG, CO and air toxic emissions.<sup>292</sup>

- Expected changes to engine performance necessary to reduce fuel consumption and greenhouse gas emissions will improve the thermal efficiency of engines and may result in reduced exhaust temperatures.

#### b. Previous Studies of Gasoline Sulfur Impacts

This section summarizes studies to provide historical context regarding what is known about the direct impacts of gasoline sulfur on vehicle exhaust emissions. Reducing fuel sulfur levels has been the primary regulatory mechanism EPA has used to minimize sulfur contamination of exhaust catalysts and to ensure optimum emissions performance over the useful life of a vehicle. The impact of gasoline sulfur on exhaust catalyst systems has become even more important as vehicle emission standards have become more stringent. Studies have suggested a progressive increase in catalyst

sensitivity to sulfur when standards increase in stringency and emissions levels decrease. Emission standards under the programs that preceded the Tier 2 program (Tier 0, Tier 1, and National LEV, or NLEV) were high enough that the impact of sulfur was considered of little importance. The Tier 2 program recognized the importance of sulfur and reduced the sulfur levels in the fuel from around 300 ppm to 30 ppm in conjunction with the new emission standards.<sup>293</sup> At that time, very little work had been done to evaluate the effect of further reductions in fuel sulfur, especially on in-use vehicles that may have some degree of catalyst deterioration due to real-world operation or on vehicles with extremely low tailpipe emissions as described earlier.

In 2005, EPA and several automakers jointly conducted a research program, the Mobile Source Air Toxics (MSAT) Study that examined the effects of sulfur and other gasoline properties such as benzene and volatility on emissions from a fleet of nine Tier 2 compliant vehicles.<sup>294</sup> The study found significant reductions in NO<sub>x</sub>, CO and total hydrocarbons (HC) when the vehicles were tested on low sulfur fuel, relative to 32 ppm fuel. In particular, the study found a 48 percent increase in NO<sub>x</sub> over the FTP when gasoline sulfur was increased from 6 ppm to 32 ppm. Given the preparatory procedures related to catalyst clean-out and loading used by these studies, these results may represent a "best case" scenario relative to what would be expected under more typical driving conditions. Nonetheless, these data suggested the effect of in-use sulfur loading was largely reversible for Tier 2 vehicles, and that there were likely to be significant emission reductions possible with further reductions in gasoline sulfur level. More recently, EPA completed a comprehensive study on the effects of gasoline sulfur on the exhaust emissions of Tier 2 vehicles at low to moderate mileage levels.<sup>295</sup> Further details of this study are summarized in Section IV.A.6.c of this preamble.

In the NPRM, we summarized the limited data available regarding the

<sup>289</sup> Maricq, M. M., Chace, R.E., Xu, N., Podsiadlik, D.H. (2002). The Effects of the Catalytic Converter and Fuel Sulfur Level on Motor Vehicle Particulate Matter Emissions: Gasoline Vehicles." *Environmental Science and Technology*, 36, No. 2 pg. 276–282.

<sup>290</sup> The Effects of Ultra-Low Sulfur Gasoline on Emissions from Tier 2 Vehicles in the In-Use Fleet, EPA-420-R-14-002.

<sup>291</sup> See Preamble Section IV.A.6.c and Chapter 1 of the RIA (Section 1.2.3.2) for more details on this study and its results.

<sup>292</sup> See § 86.1811–17 (LD) within the Tier 3 regulations. Tier 3 restrictions to commanded enrichment are also discussed in further detail within section IV.A.4.c of this preamble.

<sup>293</sup> Tier 2 Regulatory Impact Analysis, EPA 420-R-99-023, December 22, 1999, last accessed on the Internet on 12/04/2013 at the following URL: <http://epa.gov/tier2>.

<sup>294</sup> Chapter 6 of the Regulatory Impact Analysis for the Control of Hazardous Air Pollutants from Mobile Sources Final Rule, EPA 420-R-07-002, February 2007, last accessed on the Internet on 12/04/2013 at the following URL: <http://nepis.epa.gov/Exe/ZyPDF.cgi?Dockkey=P1004LNN.PDF>.

<sup>295</sup> The Effects of Ultra-Low Sulfur Gasoline on Emissions from Tier 2 Vehicles in the In-Use Fleet, EPA-420-R-14-002.



impact of gasoline sulfur on the near-zero exhaust emission vehicle technologies that will be necessary for Tier 3 compliance. Vehicles certified to California LEV II SULEV and PZEV standards and federal Tier 2 Bin 2 standards achieve levels of exhaust emissions control consistent with the levels of control that will be necessary for Tier 3 compliance. While these vehicles represent only a relatively small subset (e.g., typically small light-duty vehicles and light-duty trucks with limited GVWR or towing utility) of the broad range of vehicles that will need to comply with Tier 3 standards as part of a fleet-wide average, data on these vehicles provide an opportunity to study the impact of gasoline sulfur on near-zero exhaust emission technologies and is generally representative of technology that are expected to be used with mid-size and smaller light-duty vehicles for Tier 3 compliance. Vehicle testing by Toyota (Takei et al.) of LEV I, LEV II ULEV and prototype SULEV vehicles showed larger percentage increases in NO<sub>x</sub> and HC emissions for SULEV vehicles as gasoline sulfur increased from 8 ppm to 30 ppm, as compared to other LEV vehicles they tested.<sup>296</sup> Ball et al. of Umicore Autocat USA, Inc. studied the impact of gasoline fuel sulfur levels of 3 ppm and 33 ppm on the emissions of a 2009 Chevrolet Malibu PZEV.<sup>297</sup> Umicore's testing of the Malibu PZEV vehicle showed a pronounced and progressive trend of increasing NO<sub>x</sub> emissions (referred to as "NO<sub>x</sub> creep") when switching from a 3 ppm sulfur gasoline to repeated, back-to-back FTP tests using 33 ppm sulfur gasoline. The PZEV Chevrolet Malibu, after being aged to an equivalent of 150,000 miles, demonstrated emissions at a level consistent with the Tier 3 Bin 30 NMOG+NO<sub>x</sub> standards when operated on 3 ppm sulfur fuel and for at least one FTP test after switching to 33 ppm certification fuel. Following operation over 2 FTP cycles on 33 ppm sulfur fuel, NO<sub>x</sub> emissions alone were more than double the Tier 3 30 mg/mi NMOG+NO<sub>x</sub> standard.<sup>271</sup> This represents a 70% NO<sub>x</sub> increase between 3 ppm sulfur and 33 ppm sulfur

<sup>296</sup> Takei, Y., Kungasa, Y., Okada, M., Tanaka, T., Fujimoto, Y. (2000). Fuel Property Requirement for Advanced Technology Engines. SAE Technical Paper 2000-01-2019.

<sup>297</sup> Ball, D., Clark, D., Moser, D. (2011). Effects of Fuel Sulfur on FTP NO<sub>x</sub> Emissions from a PZEV 4 Cylinder Application. SAE Technical Paper 2011-01-0300.

gasolines, approximately 2–3 times of what has been previously reported for similar changes in fuel sulfur level for Tier 2 and older vehicles.<sup>298 299</sup>

Both the Umicore and Toyota studies suggest that the emissions from vehicles using near-zero exhaust emissions control technology similar to what is expected for compliance with the Tier 3 standards are more sensitive to changes in gasoline sulfur content at low (sub-30 ppm) sulfur concentrations than technology used to meet the higher Federal Tier 2 and California LEV II standards. The Umicore and Toyota studies clearly indicate that a progressive increase in catalyst sensitivity to sulfur continues as exhaust emissions decrease from levels required by federal Tier 2 and California LEV II emissions standards to the lower levels required by Tier 3 emissions standards. In addition, although vehicles with Tier 2 technology have somewhat less sulfur sensitivity compared to future Tier 3 vehicles, there is still significant opportunity for further emissions reductions from the existing in-use fleet by reducing gasoline sulfur content from 30 ppm to 10 ppm. The results of recent testing demonstrating the potential for in-use emissions reductions from further gasoline sulfur control are summarized in Section IV.A.6.c. Recent data on the impact of gasoline sulfur on vehicles with exhaust emission control technologies that we expect to be used with Tier 3 vehicles is summarized in Sections IV.A.6.d and e.

#### c. EPA Testing of Gasoline Sulfur Effects on Tier 2 Vehicles and the In-Use Fleet

Both the MSAT<sup>300</sup> and Umicore<sup>301</sup> studies showed the emission reduction potential of lower sulfur fuel on Tier 2 and later technology vehicles over the FTP cycle. However, assessing the potential for reduction on the in-use fleet requires understanding how sulfur

<sup>298</sup> The Effects of Ultra-Low Sulfur Gasoline on Emissions from Tier 2 Vehicles in the In-Use Fleet, EPA-420-R-14-002.

<sup>299</sup> Shapiro, E. (2009). National Clean Gasoline—An Investigation of Costs and Benefits. Published by the Alliance of Automobile Manufacturers.

<sup>300</sup> Chapter 6 of the Regulatory Impact Analysis for the Control of Hazardous Air Pollutants from Mobile Sources Final Rule, EPA 420-R-07-002, February 2007, last accessed on the Internet on 12/04/2013 at the following URL: <http://nepis.epa.gov/Exec/ZyPDF.cgi?Dockkey=P1004LNN.PDF>.

<sup>301</sup> Ball, D., Clark, D., Moser, D. (2011). Effects of Fuel Sulfur on FTP NO<sub>x</sub> Emissions from a PZEV 4 Cylinder Application. SAE Technical Paper 2011-01-0300.

exposure over time impacts emissions, and what the state of catalyst sulfur loading is for the typical vehicle in the field. In response to these data needs, EPA conducted a new study to assess the emission reductions expected from the in-use Tier 2 fleet with a reduction in fuel sulfur level from current levels.<sup>302</sup> It was designed to take into consideration what was known from prior studies on sulfur build-up in catalysts over time and the effect of periodic regeneration events that may result from higher speed and load operation over the course of day-to-day driving.

The study sample described in this analysis consisted of 93 cars and light trucks recruited from owners in southeast Michigan, covering model years 2007–9 with approximately 20,000–40,000 odometer miles.<sup>303</sup> The makes and models targeted for recruitment were chosen to be representative of high sales vehicles covering a range of types and sizes. Test fuels were two non-ethanol gasolines with properties typical of certification test fuel, one at a sulfur level of 5 ppm and the other at 28 ppm. All emissions data was collected using the FTP cycle at a nominal temperature of 75 °F.

Using the 28 ppm test fuel, emissions data were collected from vehicles in their as-received state as well as following a high-speed/load "clean-out" procedure consisting of two back-to-back US06 cycles intended to reduce sulfur loading in the catalyst. A statistical analysis of this data showed highly significant reductions in several pollutants including NO<sub>x</sub> and hydrocarbons, demonstrating that sulfur loadings have a large effect on exhaust catalyst performance, and that Tier 2 vehicles can achieve significant reductions based on removing, at least in part, the negative impact of the sulfur loading on catalyst efficiency (Table IV-6). For example, Bag 2 NO<sub>x</sub> emissions dropped 31 percent between the pre- and post-cleanout tests on 28 ppm fuel.

<sup>302</sup> The Effects of Ultra-Low Sulfur Gasoline on Emissions from Tier 2 Vehicles in the In-Use Fleet, EPA-420-R-14-002.

<sup>303</sup> The NPRM modeling was based on analysis of 81 passenger cars and trucks. Since the NPRM, twelve additional Tier 2 vehicles were tested and included in the statistical analysis described in the docketed final report, examining the effect of sulfur on emissions from Tier 2 vehicles. The analysis based on the complete set of 93 Tier 2 vehicles is reflected in the results presented in this section and the emissions modeling for FRM.

TABLE IV-6—PERCENT REDUCTION IN IN-USE EMISSIONS AFTER THE CLEAN-OUT USING 28 PPM TEST FUEL <sup>A</sup>

	NO <sub>x</sub> (p-value)	THC (p-value)	CO (p-value)	NMHC (p-value)	CH <sub>4</sub> (p-value)	PM (p-value)
Bag 1 .....			6.0% (0.0151)			15.4% ( $< 0.0001$ )
Bag 2 .....	31.4% (0.0003)	14.9% (0.0118)		18.7% (0.0131)	14.4% (0.0019)	
Bag 3 .....	35.4% ( $< 0.0001$ )	20.4% ( $< 0.0001$ )	21.5% (0.0001)	27.7% ( $< 0.0001$ )	10.3% ( $< 0.0001$ )	24.5% ( $< 0.0001$ )
FTP Composite .....	11.4% (0.0002)	3.8% (0.0249)	6.8% (0.0107)	3.5% (0.0498)	6.0% (0.0011)	13.7% ( $< 0.0001$ )
Bag 1-Bag 3 .....			7.2% (0.0656)			

<sup>a</sup> The clean-out effect is not significant at  $\alpha = 0.10$  when no reduction estimate is provided.

To assess the impact of lower sulfur fuel on in-use emissions, further testing was conducted on a representative subset of vehicles on 28 ppm and 5 ppm fuel with accumulated mileage. A first step in this portion of the study was to assess the differences in the effectiveness of the clean-out procedure under different fuel sulfur levels. Table IV-7 presents a comparison of emissions immediately following (<50

miles) the clean-out procedures at the low vs. high sulfur level. These results show significant emission reductions for the 5 ppm fuel relative to the 28 ppm fuel immediately after this clean-out; for example, Bag 2 NO<sub>x</sub> emissions were 34 percent lower on the 5 ppm fuel vs. the 28 ppm fuel. This indicates that the catalyst is not fully desulfurized, even after a clean out procedure, as long as there is sulfur in the fuel. This further

indicates that current sulfur levels in gasoline continue to have a long-term, adverse effect on exhaust emissions control that is not fully removed by intermittent clean-out procedures that can occur in day-to-day operation of a vehicle and demonstrates that lowering sulfur levels to 10 ppm on average will significantly reduce the effects of sulfur impairment on emissions control technology.

TABLE IV-7—PERCENT REDUCTION IN EXHAUST EMISSIONS WHEN GOING FROM 28 PPM TO 5 PPM SULFUR GASOLINE FOR THE FIRST THREE REPEAT FTP TESTS IMMEDIATELY FOLLOWING CLEAN-OUT

	NO <sub>x</sub> (p-value)	THC (p-value)	CO (p-value)	NMHC (p-value)	CH <sub>4</sub> (p-value)	PM <sup>a</sup>
Bag 1 .....	5.3% (0.0513)	6.8% (0.0053)	6.2% (0.0083)	5.7% (0.0276)	14.0% ( $< 0.0001$ )	
Bag 2 .....	34.4% (0.0036)	33.9% ( $< 0.0001$ )	( <sup>a</sup> )	26.4% (0.0420)	49.4% ( $< 0.0001$ )	
Bag 3 .....	42.5% ( $< 0.0001$ )	36.9% ( $< 0.0001$ )	14.7% (0.0041)	51.7% ( $< 0.0001$ )	28.5% ( $< 0.0001$ )	
FTP Composite .....	15.0% (0.0002)	13.3% ( $< 0.0001$ )	8.5% (0.0050)	10.9% (0.0012)	23.6% ( $< 0.0001$ )	
Bag 1-Bag 3 .....	( <sup>a</sup> )	( <sup>a</sup> )	( <sup>a</sup> )	( <sup>a</sup> )	( <sup>a</sup> )	

<sup>a</sup> The effectiveness of clean-out cycle is not significant at  $\alpha = 0.10$ .

To assess the overall in-use reduction between high and low sulfur fuel, a mixed model analysis of all data as a function of fuel sulfur level and miles driven after cleanout was performed. This analysis found highly significant

reductions for several pollutants, as shown in Table IV-8. Reductions for Bag 2 NO<sub>x</sub> were particularly high, estimated at 52 percent between 28 ppm and 5 ppm overall. For all pollutants, the model fitting did not find a

significant miles-by-sulfur interaction, suggesting the relative differences were not dependent on miles driven after clean-out.

TABLE IV-8—PERCENT REDUCTION IN EMISSIONS FROM 28 PPM TO 5 PPM FUEL SULFUR ON IN-USE TIER 2 VEHICLES

	NO <sub>x</sub> (p-value)	THC (p-value)	CO (p-value)	NMHC (p-value)	CH <sub>4</sub> (p-value)	NO <sub>x</sub> +NMOG (p-value)	PM <sup>a</sup>
Bag 1 .....	7.1% (0.0216)	9.2% (0.0002)	6.7% (0.0131)	8.1% (0.0017)	16.6% ( $< 0.0001$ )	N/A	
Bag 2 .....	51.9% ( $< 0.0001$ )	43.3% ( $< 0.0001$ )	( <sup>a</sup> )	42.7% (0.0003)	51.8% ( $< 0.0001$ )	N/A	
Bag 3 .....	47.8% ( $< 0.0001$ )	40.2% ( $< 0.0001$ )	15.9% (0.0003)	54.7% ( $< 0.0001$ )	29.2% ( $< 0.0001$ )	N/A	
FTP Composite .....	14.1% (0.0008)	15.3% ( $< 0.0001$ )	9.5% ( $< 0.0001$ )	12.4% ( $< 0.0001$ )	29.3% ( $< 0.0001$ )	14.4% ( $< 0.0001$ )	
Bag 1-Bag 3 .....	( <sup>a</sup> )	5.9% (0.0074)	( <sup>a</sup> )	( <sup>b</sup> )	( <sup>b</sup> )	N/A	

<sup>a</sup> Sulfur level not significant at  $\alpha = 0.10$ .

<sup>b</sup> Inconclusive because the mixed model did not converge.

Major findings from this study include:

- Largely reversible sulfur loading is occurring in the in-use fleet of Tier 2 vehicles and has a measureable effect on emissions of NO<sub>x</sub>, hydrocarbons, and other pollutants of interest.

- The effectiveness of high speed/load procedures in restoring catalyst efficiency is limited when operating on higher sulfur fuel.

- Reducing fuel sulfur levels from current levels to levels in the range of the Tier 3 gasoline sulfur standards is expected to achieve significant reductions in emissions of NO<sub>x</sub>, hydrocarbons, and other pollutants of interest in the current in-use fleet.

- Assuming that the emissions impacts vs. gasoline sulfur content are approximately linear, changing gasoline sulfur content from 30 ppm to 10 ppm would result in NMOG+NO<sub>x</sub> emissions decreasing from 52 mg/mi to 45 mg/mi, respectively (a 13% decrease), and NO<sub>x</sub> emissions decreasing from 19 mg/mi to 16 mg/mi, respectively (a 16% decrease), for the vehicles in the study.

To evaluate the robustness of the statistical analyses assessing the overall in-use emissions reduction between operation on high and low sulfur fuel (Table IV–8), a series of sensitivity analyses were performed to assess the impacts on study results of measurements from low-emitting vehicles and influential vehicles, as documented in detail in the report.<sup>304</sup> The sensitivity analyses showed that the magnitude and the statistical significance of the results were not impacted and thus demonstrated that the results are statistically robust. We also subjected the design of the experiment and data analysis to a contractor-led independent peer-review process in accordance with EPA's peer review guidance. The results of the peer review<sup>305</sup> <sup>306</sup> largely supported the study design, statistical analyses, and the conclusions from the program and raised only minor concerns that have not changed the overall conclusions and have subsequently been addressed in the final version of the report.<sup>307</sup>

Overall, the reductions found in this study are in agreement with other low sulfur studies conducted on Tier 2

vehicles, namely MSAT and Umicore studies mentioned above, in terms of the magnitude of NO<sub>x</sub> and HC reductions when switching from 28 ppm to 5 ppm fuel.<sup>308</sup> We have reviewed the results of the emission effects study performed by SGS, which was included with API's comments on the Tier 3 proposal, and have concluded that these results are also consistent with the findings of EPA's Tier 2 in-use study, specifically that exhaust emissions performance is sensitive to fuel sulfur level.<sup>309</sup> The SGS study also suggests that negative effects of exposure to a somewhat higher sulfur level (80 ppm in this case) are largely reversible for Tier 2 vehicles, meaning that reducing fuel sulfur levels nationwide will bring significant immediate benefits by reducing emissions of the existing fleet. For further details regarding the Tier 2 In-Use Gasoline Sulfur Effects Study, see the final report.<sup>310</sup>

As a follow-on phase to the Tier 2 in-use study, EPA analyzed five vehicles<sup>311</sup> certified to Tier 2 Bin 4, LEV II ULEV and LEV II SULEV exhaust emissions standards to assess the gasoline sulfur sensitivity of Tier 2 and California LEV II vehicles with emission levels approaching or comparable to the Tier 3 standards. The analysis found that these low-emitting Tier 2 vehicles showed similar or greater sensitivity to fuel sulfur levels compared to the original Tier 2 test fleet—for example, a 24 percent reduction in FTP composite NO<sub>x</sub> emissions when sulfur is reduced from 28 ppm to 5 ppm.<sup>312</sup> Test results discussed below in section IV.A.6.d also confirm that there is significantly increased sensitivity of exhaust emissions to gasoline sulfur as vehicle technologies advance towards exhaust emissions approaching near-zero emissions (e.g., Tier 3 Bin 50 and lower). The impact of fuel sulfur on vehicles with exhaust emission control technologies that we expect to be used with Tier 3 vehicles is summarized in the next two sections (Preamble IV.A.6.d and e).

<sup>308</sup> Ball, D., Clark, D., Moser, D. (2011). Effects of Fuel Sulfur on FTP NO<sub>x</sub> Emissions from a PZEV 4 Cylinder Application. SAE Technical Paper 2011-01-0300.

<sup>309</sup> American Petroleum Institute. 2013. Supplemental Comments of the American Petroleum Institute. Available in the docket for this final rule, docket no. EPA-HQ-OAR-2011-0135.

<sup>310</sup> The Effects of Ultra-Low Sulfur Gasoline on Emissions from Tier 2 Vehicles in the In-Use Fleet, EPA-420-R-14-002.

<sup>311</sup> The make and model of the tested vehicles are Honda Crosstour, Chevrolet Malibu, Chevrolet Silverado, Ford Focus and Subaru Outback.

<sup>312</sup> The Effects of Ultra-Low Sulfur Gasoline on Emissions from Tier 2 Vehicles in the In-Use Fleet, EPA-420-R-14-002.

EPA believes that the studies by EPA and others described in this section strongly support our conclusion that reducing gasoline sulfur content to a 10 ppm average will result in significant exhaust emissions reductions from the current in-use fleet. However, some commenters have expressed concerns about the relevance and appropriateness of the data, as well as the conclusions drawn from them. The Summary and Analysis of Comments document, available in the docket for this rulemaking, provides our responses to those comments.

#### d. Testing of Gasoline Sulfur Effects on Vehicles With Tier 3/LEV III Technology

The Tier 3 fleet average exhaust emissions standards of 30 mg/mi NMOG+NO<sub>x</sub> will require large reductions of emissions across a broad range of light-duty vehicles and trucks with differing degrees of utility. Previous studies of sulfur impacts on extremely low exhaust emission vehicles (e.g., Toyota, Umicore) were limited to mid-size or smaller light-duty vehicles. There are currently no LDT3 or any LDT4 vehicles certified at or below Federal Tier 2 Bin 3 or to the California LEV II SULEV exhaust emission standards with the exception of a single hybrid electric SUV. At the time of the Tier 3 NPRM, EPA was not aware of any existing data demonstrating the impact of changes in gasoline sulfur content on larger vehicles with technology comparable to what would be expected for compliance with Tier 3 exhaust emission standards. In their supplemental comments to the Tier 3 proposal, API criticized EPA's reliance on emissions data from older vehicles that were not considered to be examples of future Tier-3-like vehicles. In order to further evaluate this issue, the Agency initiated a test program at EPA's National Vehicle and Fuel Emissions Laboratory (NVFEL) in Ann Arbor, Michigan. The Agency obtained a heavy-light-duty truck and applied changes to the design and layout of the exhaust catalyst system and to the calibration of the engine management system consistent with our engineering analyses of technology necessary to meet Tier 3 Bin 30 emissions with a 20 to 40% compliance margin at 150,000 miles. EPA also requested that Umicore loan the Agency the vehicle tested in their study to undergo further evaluation of gasoline sulfur impacts on exhaust emissions. In addition, Ford Motor Company completed testing of fuel sulfur effects on a Tier 3/LEV III developmental heavy-light-duty truck and submitted a summary report of their

<sup>304</sup> The Effects of Ultra-Low Sulfur Gasoline on Emissions from Tier 2 Vehicles in the In-Use Fleet, EPA-420-R-14-002.

<sup>305</sup> Peer Review of the Effects of Fuel Sulfur Level on Emissions from the In-Use Tier 2 Vehicles, EPA-HQ-OAR-2011-0135-1847.

<sup>306</sup> EPA In-Use Sulfur Report—Response to Peer-Review Comments, EPA-HQ-OAR-2011-0135-1848.

<sup>307</sup> The Effects of Ultra-Low Sulfur Gasoline on Emissions from Tier 2 Vehicles in the In-Use Fleet, EPA-420-R-14-002.

findings as part of their supplemental comments to the Tier 3 NPRM. The results of these three test programs are summarized below.

i. Ford Motor Company Tier 3 Sulfur Test Program

Ford Motor Company recently completed testing of a heavy-light-duty truck (i.e., between 6,000 and 8,500 pounds GVWR) under development to meet the Tier 3 Bin 50 standards on two different fuel sulfur levels and submitted the resulting data to EPA as part of its supplemental comments.<sup>313</sup><sup>314</sup> The test results from this vehicle are particularly important when considering the following factors:

- These are the first detailed emissions data submitted by a vehicle manufacturer to the Agency demonstrating emissions of a heavy-light-duty-truck consistent with Tier 3 Bin 50 or lower emissions levels.
- The truck tested uses a version of Ford's 2.0 L GTDI engine, an engine with high BMEP (approximately 23-bar) that can allow significant engine displacement downsizing while maintaining the truck's utility. This is a key enabling GHG reduction strategy analyzed by EPA in the 2017–2025 GHG Final Rule.<sup>315</sup>
- The vehicle was specifically under development by a vehicle manufacturer with an engineering target of meeting Tier 3 Bin 50 and LEV III ULEV50 exhaust emissions standards. Turbocharged, downsized engines are key technologies within Ford's strategy to reduce GHG emissions.<sup>316</sup> EPA expects that trucks with configurations similar to this developmental Ford Explorer (downsized engines with reduced GHG emissions and very low emissions of NMOG+NO<sub>x</sub>) will become increasingly prevalent within the

timeframe of the implementation of the Tier 3 regulations.

The developmental truck used close-coupling of both catalyst substrates and relatively high PGM loading (150 g/ft<sup>3</sup>). Ford used accelerated aging of the catalysts and O<sub>2</sub> sensors to an equivalent of 150,000 miles (the Tier 3 full useful life). The developmental hardware and engine management calibration configuration of this truck was designed to meet federal Tier 3 Bin 50 and California LEV III ULEV50 standards of 50 mg/mi NMOG+NO<sub>x</sub> at 150,000 miles. The emissions data submitted by Ford included NO<sub>x</sub> and NMHC emissions during operation on E10 California LEV III certification fuel at two different sulfur levels, 10 ppm and 26.5 ppm. Ford did not provide NMOG emissions data but there was sufficient information for EPA to calculate NMOG emissions from the provided NMHC data using calculations from Title 40 CFR 1066.665.

The truck demonstrated average FTP NMOG+NO<sub>x</sub> emissions of 37 mg/mi on the 10 ppm E10 California LEV III fuel, emissions that are consistent with compliance with Bin 50 and ULEV50 standards with a reasonable margin of compliance (emissions at approximately 70% of the standard). Retesting of the same vehicle on LEV3 E10 blended<sup>317</sup> to 26.5 ppm S resulted in average NMOG+NO<sub>x</sub> emissions of 53 mg/mi, 6% above the Tier 3 Bin 50 standard. Ford found a high level of statistical significance with respect to the increase of emissions with increasing fuel sulfur. Assuming a linear effect of sulfur on emissions performance, NMOG+NO<sub>x</sub> emissions would be approximately 56 mg/mi at 30 ppm sulfur, which is approximately 12% above the Bin 50 exhaust emissions standard. This also represents an increase in NMOG+NO<sub>x</sub> emissions of 53% with an approximate doubling of NO<sub>x</sub> emissions and a 13% increase in NMOG for 30 ppm sulfur gasoline vs. 10 ppm sulfur gasoline.

The advanced technology Ford truck, which was shown to be capable of complying with the Tier 3 Bin 50 standard with a reasonable margin of compliance on 10 ppm sulfur gasoline, in effect reverted to approximately LEV II ULEV exhaust emissions levels when tested on higher sulfur gasoline, equivalent to the previous level of emissions control to which earlier models of this vehicle were certified for MY 2013. The effect of increasing gasoline sulfur levels from 10 ppm to 30

ppm<sup>318</sup> on this vehicle essentially negated the entire benefit of the advances in emissions control technology that were applied by the vehicle manufacturer to meet developmental goals for compliance with Tier 3 standards. This clearly indicates, for this vehicle model using technology representative of what would be expected for compliance with Tier 3 Bin 50 and post 2017 GHG standards, reducing gasoline sulfur to 10 ppm is needed for the advances in technology to achieve their intended effectiveness in reducing NMOG+NO<sub>x</sub> emissions. The advances in vehicle technology and the reduction in gasoline sulfur clearly are both needed to achieve the emissions reductions called for by Tier 3.

ii. EPA Re-Test of Umicore 2009 Chevrolet Malibu PZEV

Ball et al. of Umicore Autocat USA, Inc. previously studied the impact of gasoline fuel sulfur levels of 3 ppm and 33 ppm on the emissions of a 2009 Chevrolet Malibu PZEV.<sup>319</sup> In their supplemental comments, API commented that the composition of the two test fuels outside of sulfur content was not held constant and thus the exhaust emissions differences attributed to the difference in gasoline sulfur levels may have been due to other fuel property differences. For example, the 3 ppm fuel used by Ball et al. was nonoxygenated EEE Clear test fuel (essentially, Tier 2 Federal certification gasoline except with near-zero sulfur) while the 33 ppm fuel was an oxygenated California Phase 2 LEV II certification fuel. Thus it was not entirely clear if the changes in NO<sub>x</sub> emissions observed between tests with the two fuels were significantly impacted by fuel composition variables other than gasoline sulfur content. EPA obtained the same test vehicle from Umicore for retesting at the EPA NVFEL facility using the 5 ppm and 28 ppm sulfur E0 test fuels and vehicle test procedures used in EPA gasoline sulfur effects testing on Tier 2 vehicles (see Section IV.6.b).

In EPA's retest of the 2009 Chevrolet Malibu PZEV, when sulfur was the only difference between the test fuels, the gasoline with higher sulfur resulted in significantly higher increases in NO<sub>x</sub> emissions with increasing fuel sulfur content than was observed in the

<sup>313</sup> Ford Motor Company. 2013. "Quality Changes Needed to Meet Tier 3 Emission Standards and Future Greenhouse Gas Requirements." Attachment 2: "Tier 3 Sulfur Test Program—Ford Motor Company Summary Report." Available within EPA Docket for this final rule, EPA-HQ-2011-0135.

<sup>314</sup> Dominic DiCicco, Ford Motor Company. 2013. "Additional data as requested. RE: Ford Supplemental Comments on Tier 3." Available within EPA Docket for this final rule, EPA-HQ-2011-0135.

<sup>315</sup> See 77 FR 62840–62862, October 15, 2012; and Joint Technical Support Document: Final Rulemaking for 2017–2025 Light-Duty Vehicle Greenhouse Gas Emission Standards and Corporate Average Fuel Economy Standards (EPA-420-R-12-901), August 2012, Chapter 3.4.1.7–3.4.1.8 (pages 3–88–3–95).

<sup>316</sup> Ford Motor Company. 2012. "Sustainability 2011/2012—Improving Fuel Economy." Accessed on the Internet on 11/21/2013 at: <http://corporate.ford.com/microsites/sustainability-report-2011-12/environment-products-plan-economy>. Available within EPA Docket for this final rule, EPA-HQ-2011-0135.

<sup>317</sup> Ford used the same tert-butyl sulfide fuel sulfur additives used within the EPA testing in IV.A.6.c and d.

<sup>318</sup> Emissions at 30 ppm sulfur estimated assuming approximately linear emissions effects between 10, 26.5 and 30 ppm gasoline sulfur levels.

<sup>319</sup> Ball, D., Clark, D., Moser, D. (2011). Effects of Fuel Sulfur on FTP NO<sub>x</sub> Emissions from a PZEV 4 Cylinder Application. SAE Technical Paper 2011-01-0300. Available in the docket for this final rule.

previous testing by Ball et al. at Umicore. Assuming emissions impacts vs. gasoline sulfur content are approximately linear, the original data from Ball et al. would have resulted in a predicted increase in NO<sub>x</sub> emissions of approximately 40% when increasing gasoline sulfur from 10 ppm to 30 ppm. The EPA re-testing of the same vehicle that controlled for other fuel composition differences resulted in a predicted increase in NO<sub>x</sub> emissions of 93% when increasing gasoline sulfur from 10 ppm to 30 ppm, with NO<sub>x</sub> emissions approximately doubling from 22 g/mi to 43 g/mi, with no statistically significant difference in NMOG emissions and with an increase in NMOG+NO<sub>x</sub> emissions of 56%. The approximate doubling in NO<sub>x</sub> emissions with the Malibu PZEV between 10 ppm and 30 ppm sulfur was nearly identical to the results found during testing of the Tier 3 Bin 50 developmental Ford Explorer discussed above. The results confirm that fuel compositional differences other than sulfur may have impacted exhaust emissions results in the Ball et al. study by underreporting a substantial portion of the effect of increased sulfur on NO<sub>x</sub> emissions. When controlling for other fuel composition differences, the resultant increase in NO<sub>x</sub> exhaust emissions due to increasing gasoline sulfur was more than double that observed in the original Ball et al. study. The observed increase in NMOG+NO<sub>x</sub> emissions during EPA testing of the Malibu PZEV was also comparable to results found with the developmental Tier 3 Bin 50 Ford Explorer. There was also a much higher increase in NO<sub>x</sub> and NMOG+NO<sub>x</sub> emissions for both the Malibu PZEV and the Tier 3 Bin 50 Explorer with increased gasoline sulfur than was observed with Tier 2 vehicles in the EPA Tier 2 in-use study. (See also Chapter 1.2.4 of the RIA)

iii. EPA Prototype Tier 3 Heavy-Light-Duty Truck Test Program

EPA purchased a 2011 Chevrolet Silverado heavy-light-duty (LDT4) pickup truck with a developmental goal of modifying the truck to achieve exhaust emissions consistent with compliance with the Tier 3 Bin 30 emissions standards. The truck was equipped with a 5.3L V8 with General Motors' "Active Fuel Management" cylinder deactivation system. This particular truck was chosen in part because cylinder deactivation is a key technology for light-truck compliance with future GHG standards and in part because it achieved very low emissions in its OEM, Tier 2-compliant configuration (certified to Tier 2 Bin 4).

A prototype exhaust system was obtained from MECA consisting of high-cell-density (900 cpsi) thin-wall (2.5 mil), high-PGM, close-coupled Pd-Rh catalysts with an additional under-body Pd-Rh catalyst. The total catalyst volume was approximately 116 in<sup>3</sup> with a specific PGM loading of 125 g/ft<sup>3</sup> and approximate loading ratio of 0:80:5 (Pt:Pd:Rh). Third-party (non-OEM) EMS calibration tools were used to modify the powertrain calibration in an effort to improve catalyst light-off performance. The final test configuration used approximately 4 degrees of timing retard and approximately 200 rpm higher idle speed relative to the OEM configuration during and immediately following cold-start. The exhaust catalyst system and HEGO sensors were bench aged to an equivalent 150,000 miles using standard EPA accelerated catalyst bench-aging procedures.<sup>320</sup> The truck was tested on California LEV III E10 certification fuel at 9 and 29 ppm gasoline sulfur levels.

The EPA Tier 3 prototype Silverado achieved NMOG+NO<sub>x</sub> emissions of 18 mg/mi on the 9 ppm S fuel. The NMOG+NO<sub>x</sub> emissions were approximately 60% of the Bin 30 standard and thus are consistent with meeting the Tier 3 Bin 30 exhaust emissions standard with a moderate compliance margin. NMOG+NO<sub>x</sub> emissions increased to 29 mg/mi on the 29 ppm S fuel and one out of four tests exceeded the Bin 30 exhaust emissions standards. NMOG+NO<sub>x</sub> emissions would be at 19 mg/mi and 30 mg/mi with 10 ppm and 30 ppm gasoline sulfur, respectively, assuming a linear effect of sulfur on emissions performance. This represents an increase in NMOG+NO<sub>x</sub> emissions of approximately 55%, comparable to increases observed with both the EPA-tested Chevrolet Malibu PZEV and the developmental Tier 3 Bin 50 Ford Explorer. The impact of increased gasoline sulfur on NMOG+NO<sub>x</sub> emissions was due to comparable increases (on a percentage basis) in both NMOG and NO<sub>x</sub> emissions. This effect of gasoline sulfur on the Prototype Silverado truck's emissions differed from the sulfur impacts observed on the developmental Ford Explorer, which primarily affected NO<sub>x</sub> emissions, and the Malibu PZEV, where the impact was entirely on NO<sub>x</sub> emissions.

e. Gasoline Sulfur Level Necessary for New Light-Duty Vehicles To Achieve Tier 3 Exhaust Emissions Standards

Meeting Tier 3 NMOG+NO<sub>x</sub> standards will require major reductions in exhaust emissions across the entire fleet of new light-duty vehicles. As discussed in previous sections, the Tier 3 program will require reductions in fleet average NMOG+NO<sub>x</sub> emissions of over 80 percent for the entire fleet of light-duty vehicles and light-duty trucks. This significant level of fleet average emission reduction will require reductions from all parts of the fleet, including vehicles models with exhaust emissions currently at or near the level of the fully phased-in Tier 3 FTP NMOG+NO<sub>x</sub> fleet average standard of 30 mg/mi.

Compliance with the more stringent Tier 3 fleet average standards will require vehicle manufacturers to certify a significant amount of vehicles to bin standards that are below the Bin 30 fleet average standard to offset other vehicles that are certified to bin standards that remain somewhat above the Bin 30 fleet average even after significantly reducing their emissions. At the same time, the stringency of the Tier 3 standards will push almost all vehicle models to be close to or below the Bin 30 fleet average standard. There are only 2 compliance bins below Bin 30, i.e., Bin 20 and Bin 0, available to offset emissions of vehicles certifying above Bin 30. There is also very limited ability for vehicle manufacturers to certify vehicles below the stringent Tier 3 fleet average exhaust emissions standard since Bin 20 and Bin 30 standards for individual vehicle certification test groups are approaching the engineering limits of what can be achieved for vehicles using an internal combustion engine and Bin 0 can only be achieved by electric-only vehicle operation. The result is that there is a very limited ability to offset sales of vehicles certified above the 30 mg/mi fleet average emission standard. This means in general that vehicle models currently with higher emissions will have to achieve significant emissions reductions to minimize the gap, if any, between their certified bin levels under Tier 3 and the Tier 3 Bin 30 fleet average standard, and vehicle models currently at or below Bin 30 will also have to achieve further emissions reductions under Tier 3 to offset the vehicles that remain certified to bin standards somewhat above Bin 30. The end result is a need for major reductions from all types of vehicles in the light-duty fleet, including those above as well as most vehicles that are already near, at, or

<sup>320</sup> U.S. Code of Federal Regulations, Title 40, § 86.1823-08 "Durability demonstration procedures for exhaust emissions."

below the Tier 3 Bin 30 fleet average standard.

Achieving exhaust emissions reductions of over 80% for the fleet, with major reductions across all types of light-duty vehicles and light-duty trucks, will be a major technological challenge. Vehicles already have made significant advances in controlling cold start emissions and maximizing exhaust catalyst efficiency (e.g., improving warm-up and catalyst light-off after cold starts and maintaining very high catalyst efficiency once warmed up) in order to meet Tier 2 and LEV II emissions standards. There are no “low-hanging fruit” remaining for additional NMOG+NO<sub>x</sub> reductions from light-duty vehicles from a technology perspective, meaning that vehicle manufacturers cannot merely change one aspect of emissions control and thereby achieve all of the required reductions. Instead, compliance with light-duty Tier 3 exhaust emissions standards will require significant improvements in all areas of emissions control—with further improvements in fuel-system management and mixture preparation during cold start, improvements in achieving catalyst light-off immediately after cold start, and improved catalyst efficiency during stabilized, fully-warmed-up conditions. Manufacturers will need further improvements in each of these areas with nearly every vehicle in order to comply with the fleet-average Tier 3 standards.

From a technology perspective, the most likely control strategies will involve using exhaust catalyst technologies and powertrain calibration primarily focused on reducing cold-start emissions of NMOG, and on reducing both cold-start and warmed-up (running) emissions of NO<sub>x</sub>. An important part of this strategy, particularly for larger vehicles having greater difficulty achieving cold-start NMOG emissions control, will be to reduce NO<sub>x</sub> emissions to near-zero levels. This will involve controlling engine-out NO<sub>x</sub> emissions during cold start, shortening the cold start period prior to catalyst light-off of NO<sub>x</sub> reduction reactions, and better controlling NO<sub>x</sub> emissions once the catalyst is fully warmed up. This is needed to allow a sufficient NMOG compliance margin so that vehicles can meet the combined NMOG+NO<sub>x</sub> emissions standards for their full useful life.

While significant NMOG+NO<sub>x</sub> emissions reductions can be achieved from better control of cold start NMOG emissions, there are practical engineering limits to NMOG control for larger displacement vehicles (e.g., large

light-duty trucks with significant payload and trailer towing capabilities). This is based in part on the impact on NMOG emissions of the larger engine surface-to-volume ratio and resultant heat conduction from the combustion chamber during warm-up. There are also tradeoffs between some cold-start NMOG controls and cold-start NO<sub>x</sub> control. For example, secondary air injection and/or leaner fueling strategies improve catalyst light-off for NMOG after a cold-start but also place OSC components in an oxidation state that limits potential for NO<sub>x</sub> reduction and thus often result in higher cold-start NO<sub>x</sub> emissions. Some applications achieve lower NMOG+NO<sub>x</sub> emissions without the use of secondary air injection by careful calibration, changes to the catalyst formulation and balancing of catalyst HC and NO<sub>x</sub> activity. The EPA Prototype Silverado and the developmental Ford Explorer are specific examples of this approach.

Because of engineering limitations with large vehicles, heavy-light-trucks and other vehicles with significant utility, we expect many applications will need close to 100% efficiency in NO<sub>x</sub> control under fully warmed-up conditions and very fast light-off of NO<sub>x</sub> reduction reactions over the exhaust catalyst almost immediately after cold-start for those applications. This will require significant improvements in catalytic and engine-out NO<sub>x</sub> reduction compared with Tier 2 vehicles and will be especially important for heavier vehicles due to the challenges of achieving low NMOG.

These technology improvements—improving warm-up and catalyst light-off after cold starts and maintaining very high catalyst efficiency—once warmed up—all rely on 10 ppm average sulfur fuel to achieve the very significant emissions reductions required for the fleet to achieve the Tier 3 Bin 30 fleet average emissions standard. The evidence from the test results and specific vehicle examples discussed above clearly indicate that leaving the gasoline sulfur level at 30 ppm would largely negate the benefits of key technology improvements expected to be used for compliance with Tier 3 exhaust emissions standards. Without the lower 10 ppm gasoline sulfur content, the Tier 3 exhaust fleet average emissions standards would not be achievable across the broad range of vehicles that must achieve significant exhaust emissions reductions.

One aspect of the need for sulfur levels of 10 ppm average stems from the fact that achieving the Tier 3 emission standards will require very careful control of the exhaust chemistry and

exhaust temperatures to ensure high catalyst efficiency. The impact of sulfur on OSC components in the catalyst makes this a challenge even at relatively low (10 ppm) gasoline sulfur levels. NO<sub>x</sub> conversion by exhaust catalysts is strongly influenced by the OSC components like ceria. Ceria sulfation may play an important role in the large degradation of NO<sub>x</sub> emission control with increased fuel sulfur levels observed in the MSAT, Umicore and EPA Tier 2 In-Use Gasoline Sulfur Effects studies and the much more severe NO<sub>x</sub> emissions degradation observed in recent test data from PZEV and prototype/developmental Tier 3/LEV III vehicles.<sup>321</sup>

The importance of lower sulfur gasoline is also demonstrated by the fact that vehicles certified to California SULEV are typically certified to higher bins for the federal Tier 2 program. Light-duty vehicles certified to CARB SULEV and federal Tier 2 Bin 2 exhaust emission standards accounted for approximately 3.1 percent and 0.4 percent, respectively, of vehicle sales for MY2009. Light-duty vehicles certified to SULEV under LEV II are more typically certified federally to Tier 2 Bin 3, Bin 4 or Bin 5, and vehicles certified to SULEV and Tier 2 Bins 3–5 comprised approximately 2.5 percent of sales for MY2009. In particular, nonhybrid vehicles certified in California as SULEV are not certified to federal Tier 2 Bin 2 emissions standards even though the numeric limits for NO<sub>x</sub> and NMOG are shared between the California LEV II and federal Tier 2 programs for SULEV and Bin 2. Confidential business information shared by the auto companies indicate that the primary reason is an inability to demonstrate compliance with SULEV/Bin 2 emission standards after vehicles have operated in-use on gasoline with greater than 10 ppm sulfur and with exposure to the higher sulfur gasoline sold nationwide. While vehicles certified to the LEV II SULEV and Tier 2 Bin 2 standards both demonstrate compliance using certification gasoline with 15–40 ppm sulfur content, in-use compliance of SULEV vehicles in California occurs after significant, sustained operation on gasoline with an average of 10 ppm sulfur and a maximum cap of 30 ppm sulfur while federally certified vehicles under the Tier 2 program operate on gasoline with an average of 30 ppm sulfur and a maximum cap of 80 ppm sulfur. Although the SULEV and Tier 2 Bin 2

<sup>321</sup> Heck, R.M., Farrauto, R.J. (2002). Chapter 6: Automotive Catalyst in *Catalytic Air Pollution Control, 2nd Edition*. John Wiley and Sons, Inc.

standards are numerically equivalent, the increased sulfur exposure of in-use vehicles certified under the federal Tier 2 program results in a need for a higher emissions compliance margin to take into account the impact of in-use gasoline sulfur on full useful life vehicle emissions. As a result, vehicles certified to California SULEV typically certify to emissions standards under the federal Tier 2 program that are 1–2 certification bins higher (e.g., SULEV certified federally as Tier 2 Bin 3 or Bin 4) in order to ensure in-use compliance with emissions standards out to the full useful life of the vehicle when operating on higher-sulfur gasoline.

There are currently no LDTs larger than LDT2 with the exception of a single hybrid electric SUV certified to Tier 2 Bin 2 or SULEV emissions standards. We expect that additional catalyst technologies, for example increasing catalyst surface area (volume or substrate cell density) and/or increased PGM loading, will need to be applied to larger vehicles in order to achieve the catalyst efficiencies necessary to comply with the Tier 3 standards, and any sulfur impact on catalyst efficiency will have a larger impact on vehicles and trucks that rely more on very high catalyst efficiencies in order to achieve very low emissions. The vehicle emissions data referenced in Section IV.A.6.d represents the only known data on non-hybrid vehicles spanning a range from mid-size LDVs to heavy-light-trucks at the very low criteria pollutant emissions levels that will be needed to comply with the Tier 3 exhaust emissions standards. The developmental Ford Explorer, Chevrolet Malibu PZEV and EPA prototype Chevrolet Silverado vehicles described in section IV.A.6.c also represent a range of different technology approaches to both criteria pollution control and GHG reduction (e.g., use of secondary air vs. emphasizing cold-start NO<sub>x</sub> control, use of engine downsizing via turbocharging vs. cylinder deactivation for GHG control, etc.) and represent a broad range of vehicle applications and utility (mid-size LDV, LDT3, LDT4). All of the vehicles with Tier 3/LEV III technology demonstrated greater than 50% increases in NMOG+NO<sub>x</sub> emissions when increasing gasoline sulfur from 10 ppm to 30 ppm. Two of the vehicles showed a doubling of NO<sub>x</sub> emissions when increasing gasoline sulfur from 10 ppm to 30 ppm. Both of the heavy-light-duty trucks with specific engineering targets of meeting Tier 3 emissions were capable of meeting their targeted emission standards with a sufficient compliance

margin on 10 ppm sulfur gasoline and could not meet their targeted emissions standards or could not achieve a reasonable compliance margin when tested with 30 ppm sulfur gasoline.

The negative impact of gasoline sulfur on catalytic activity and the resultant loss of exhaust catalyst effectiveness to chemically reduce NO<sub>x</sub> and oxidize NMOG occur across all vehicle categories. However, the impact of gasoline sulfur on the effectiveness of exhaust catalysts to control NO<sub>x</sub> emissions in the fully-warmed-up condition is particularly of concern for larger vehicles (the largest LDVs and LDT3s, LDT4s, and MDPVs). Manufacturers face the most significant challenges in reducing cold-start NMOG emissions for these vehicles. Because of the need to reach near-zero NO<sub>x</sub> emissions levels in order to offset engineering limitations on further NMOG exhaust emissions control with these vehicles, any significant degradation in NO<sub>x</sub> emissions control over the useful life of the vehicle would likely prevent some if not most larger vehicles from reaching a combined NMOG+NO<sub>x</sub> level low enough to comply with the 30 mg/mi fleet-average standard. Any degradation in catalyst performance due to gasoline sulfur would reduce or eliminate the margin necessary to ensure in-use compliance with the Tier 3 emissions standards. Certifying to a useful life of 150,000 miles versus the current 120,000 miles will further add to manufacturers' compliance challenge for Tier 3 large light trucks (See Section IV.A.7.c below for more on the useful life requirements.) These vehicles represent a sufficiently large segment of light-duty vehicle sales now and for the foreseeable future such that their emissions could not be sufficiently offset (and thus the fleet-average standard could not be achieved) by certifying other vehicles to bins below the fleet average standard.

As discussed above, achieving Tier 3 levels as an average across the light-duty fleet will require fleet wide reductions of approximately 80%. This will require significant reductions from all light duty vehicles, with the result that some models and types of vehicles will be at most somewhat above the Tier 3 level, and all other models will be at or somewhat below Tier 3 levels. Achieving these reductions presents a major technology challenge. The required reductions are of a magnitude that EPA expects manufacturers to employ advances in technology in all of the relevant areas of emissions control—reducing engine-out emissions, reducing the time to catalyst lightoff, improving

exhaust catalyst durability at 120,000 or 150,000 miles and improving efficiency of fully warmed up exhaust catalysts. All of these areas of emissions control need to be improved, and gasoline sulfur reduction to a 10 ppm average is a critical part of achieving Tier 3 levels through these emissions control technology improvements.

The use of 10 ppm average sulfur fuel is an essential part of achieving Tier 3 levels while applying an array of advancements in emissions control technology to the light-duty fleet. The testing of Tier 2 and Tier 3 type technology vehicles, as well as other information, shows that sulfur has a very large impact on the effectiveness of the control technologies expected to be used in Tier 3 vehicles. Without the reduction in sulfur to a 10 ppm average, the major technology improvements projected under Tier 3 would only result in a limited portion of the emissions reductions needed to achieve Tier 3 levels. For example, without the reduction in sulfur from a 30 ppm to 10 ppm average, the technology improvements would not come close to achieving Tier 3 levels. In some cases this may result in the same effectiveness as the current Tier 2 technology and achieve only approximately Tier 2 levels of exhaust emissions control.

Achieving Tier 3 levels without a reduction in sulfur to 10 ppm levels would only be possible if there were technology improvements significantly above and beyond those discussed above. Theoretically, without reducing sulfur levels to 10 ppm average, emissions control technology improvements would need to provide upwards of twice as much, and in some cases significantly more than twice as much, emissions control effectiveness as the Tier 3 technology improvements discussed above in Section IV.A.6.d. EPA has not identified technology improvements that could provide such a large additional increase in emissions control effectiveness, across the light-duty fleet, above and beyond that provided by the major improvements in technology discussed above, without any additional gasoline reductions in gasoline sulfur content. The impact of sulfur reduction on the effectiveness of the available technology improvements plays such a large role in achieving the Tier 3 levels that there would be no reasonable basis to expect that technology would be available, at the 30 ppm sulfur level, to fill the emission control gap left from no sulfur reduction, and achieve the very significant fleetwide reductions needed to meet the Tier 3 fleet average standards. In effect reducing sulfur from



30 ppm to 10 ppm has such a large impact on the ability of the technology improvements to achieve Tier 3 emissions levels that absent these sulfur reductions there is not a suite of technology advancements available to fill the resulting gap in emissions reductions. We cannot identify a technology path for vehicles that would achieve the Tier 3 Bin 30 average standard, across the fleet, with sulfur at 30 ppm levels, and as a result Tier 3 levels would not be technically feasible and achievable.

This analysis also applies to gasoline sulfur levels between 10 and 30 ppm, e.g., 20 ppm. The Tier 3 required emissions reductions are so large and widespread across the fleet, and the technology challenges are sufficiently high, especially for heavier vehicles, that the large increase in emissions that would occur from a higher average sulfur level compared to a 10 ppm average would lead to an inability for vehicle technologies to widely achieve Tier 3 levels as a fleet wide average in order to meet the Bin 30 fleet average standard.

EPA acknowledges that some models in the light-duty fleet, when viewed in isolation, may be able to achieve Tier 3 levels at current sulfur levels of 30 ppm average. Under the Tier 3 fleet average standards, it is not sufficient for one or a few of a manufacturer's vehicle models to meet Tier 3 levels because the manufacturer's light-duty vehicle fleet as a whole must achieve the Tier 3 30 mg/mi exhaust emissions standard as a fleet-wide average. As discussed above, all vehicle models will need to achieve further reductions and be either below or no more than somewhat above Tier 3 levels to achieve the Tier 3 standard as a fleet wide average. Absent the reductions in sulfur levels to 10 ppm average, this is not achievable from a technology perspective.

As discussed in Section V.B, the average 10 ppm gasoline sulfur standard is feasible and is the level that appropriately balances costs with the emission reductions that it provides and enables. Not only will a 10 ppm sulfur standard enable vehicle manufacturers to certify their entire product line of vehicles to the Tier 3 fleet average standards, but reducing gasoline sulfur to 10 ppm will better enable these vehicles to maintain their emission performance in-use over their full useful life. Higher sulfur levels would make it impossible for vehicle manufacturers to meet the Tier 3 standards, and would forego the very large immediate reductions from the existing fleet. Reducing the sulfur level below 10 ppm would further reduce vehicle emissions

and allow the Tier 3 vehicle standards to be achieved more easily. However, we believe that a 10 ppm average standard is sufficient to allow vehicles to meet the Tier 3 standards. Further, as discussed in Sections V.B and IX.B there are significant challenges associated with reducing sulfur below 10 ppm.

## 7. Other Provisions

### a. Early Credits

The California LEV III program is scheduled to begin at least two model years earlier than the federal Tier 3 program.<sup>322</sup> The Tier 3 standards begin in MY 2017 for vehicles 6,000 lbs GVWR and less, and in MY 2018 for vehicles over 6,000 lbs GVWR. As a result, LEV III vehicles sold in California beginning in MY 2015 will be required to meet a lower fleet average NMOG+NO<sub>x</sub> level than the federal fleet will be meeting at that time. In addition, the California NMOG+NO<sub>x</sub> standards will further decline before Tier 3 begins, resulting in the gap growing between the current federal program and LEV III.

We are finalizing an early credit program that with minor revisions is as we proposed. We have designed the early credit provisions to accomplish three goals: (1) To encourage manufacturers to produce a cleaner federal fleet earlier than otherwise required; (2) to provide valuable flexibility to the manufacturers to facilitate the significant "step down" from the current Tier 2 Bin 5 fleet average required in MY 2016 to the LEV III-based declining fleet average in MY 2017; and (3) to create an overall Tier 3 program that although starts later, is equivalent in stringency to the LEV III program such that manufacturers will be able to produce a 50-state fleet at the earliest opportunity. Commenters were generally supportive of or silent on the early credits program as proposed.

The early credit program we are finalizing includes several distinct provisions. The first provision allows manufacturers to generate early federal credits against the current Tier 2 Bin 5 requirement<sup>323</sup> in MYs 2015 and 2016 for vehicles under 6,000 lbs GVWR and MYs 2016 and 2017 for vehicles greater than 6,000 lbs GVWR. Early credits will

<sup>322</sup> See California Low-Emission Vehicles (LEV) & GHG 2012 regulations adopted by the State of California Air Resources Board, March 22, 2012, Resolution 12–21 incorporating by reference Resolution 12–11, which was adopted January 26, 2012. Available at <http://www.arb.ca.gov/regact/2012/leviiighg2012/leviiighg2012.htm> (last accessed December 2, 2013).

<sup>323</sup> Tier 2 standards are not set in the form of NMOG+NO<sub>x</sub>. The equivalent Tier 2 Bin 5 fleet average in NMOG+NO<sub>x</sub> terms is equal to 160 mg/mi (90 mg/mi NMOG + 70 mg/mi NO<sub>x</sub>).

only be available to manufacturers that comply under the primary program (declining fleet average), not the alternative phase-in approach (Section IV.A.2.c above). In order to generate these credits, manufacturers sum the bin specific NMOG and NO<sub>x</sub> certification standards for each federally certified Tier 2 vehicle and the bin NMOG+NO<sub>x</sub> standards for any vehicle certified under the Early Tier 3 provision described below and calculate an NMOG+NO<sub>x</sub> fleet average for the entire manufacturers fleet sold in a model year. Credits are based on how far the fleet average is below the existing Tier 2 Bin 5 requirement (160 mg/mi total of NMOG and NO<sub>x</sub>). We expect that manufacturers will be able to achieve a fleetwide average below the Tier 2 Bin 5 level by several means, such as certifying LEV III vehicles either under Tier 2 or as Early Tier 3 vehicles under Tier 3 (discussed in the next section) to bin levels lower than Tier 2 Bin 5. Our analysis, presented in Section IV.A.5 above and Chapter 1 of the RIA, shows that manufacturers could certify many vehicles currently certified to Tier 2 Bin 5 to a lower bin—e.g., to Tier 2 Bin 3 or Bin 4—by simply accepting a relatively small reduction in compliance margins. Many manufacturers certify Tier 2 vehicles to Tier 2 Bin 5 but also certify the same vehicle to a cleaner emission standard under the LEV II program (e.g. ULEV) with only a compliance margin difference.

We believe that the early credit provision will help us realize both our first and second goals presented above. For example, a manufacturer certifying their federal fleet to Tier 2 Bin 4 will earn 50 mg/mi of NMOG+NO<sub>x</sub> credits per vehicle (i.e., 160 mg/mi minus 110 mg/mi), which we believe will encourage manufacturers to certify a cleaner federal fleet and provide a reasonable opportunity for credit generation to facilitate the "step down" in stringency.

At the same time, if we allowed manufacturers to generate excessive early credits, manufacturers might thereby delay their compliance with the Tier 3 program, and thus the harmonization with LEV III, for several years. This would be in direct conflict with our third goal of creating a program of equal stringency to the California program as early as possible. In order to address this concern, we proposed and are finalizing a provision limiting the application of the early Tier 3 credits to the following conditions:

- Early Tier 3 credits generated as described above could be used without limitation in MY 2017 on the portion of

the fleet entering the Tier 3 program in that MY.

- Credits used for compliance in MY 2018 and beyond will be capped at an amount equal to the lesser of the manufacturer's federal credits as calculated above or the manufacturer's LEV III credits scaled up by the ratio of 50-state sales to California and LEV III required states sales. This limitation accounts for the fact that some LEV III credits may have begun to expire and will no longer be eligible as a basis for Tier 3 early credits.

By capping the available federal Tier 3 early credits, we believe that the two programs, LEV III and Tier 3 will be at parity in terms of relative stringency starting in MY 2018. In addition, because the number of Tier 3 early credits that can be used is based on the number of LEV III credits that the manufacturer has generated, there may be additional motivation for manufacturers to over-perform in California during the initial model years, accelerating emission reduction benefits.

Finally, we are adopting, as proposed, a limitation on the life of Tier 3 early credits to 5 years, with no discounting, consistent with the California LEV III program.

#### b. Early Tier 3 Compliance

We are finalizing, as proposed, the requirement that manufacturers begin the Tier 3 program in MY 2017 for vehicles up to 6,000 lbs GVWR and MY 2018 for vehicles above 6,000 lbs GVWR under the primary phase-in. The only proposed compliance approach available prior to MY 2017 was for manufacturers to continue to certify vehicles to the existing Tier 2 standards with the opportunity to earn early credits (see previous section) that could be used in MY 2017 and later.

Several auto industry commenters suggested additional provisions that could facilitate earlier harmonization between Tier 3 and LEV III and streamlining of development and certification of vehicle models. Specifically, these commenters requested the ability to have vehicles certified to the Tier 3 standards in MYs 2015 and 2016. They commented that this would allow them to develop, certify and sell a vehicle model for all 50 states, reducing the complexity of potentially different federal and California requirements in MYs 2015 and 2016. Additionally, commenters noted that the Tier 3 program provides more flexibility in the certification bin structure compared with the existing Tier 2, providing them additional opportunities to generate early credits.

To address this concern, we are finalizing a provision to allow manufacturers to certify to Tier 3 standards starting in MY 2015 as "Early Tier 3" vehicles. Manufacturers will have the option to certify their vehicle models to meet the Tier 3 emission requirements in MY 2015 and 2016 for all LDVs, LDTs, and MDPVs, which would have been required to begin in MY 2017 under the primary program. As an example, a manufacturer choosing to certify a vehicle as Early Tier 3 can bring the same vehicle models certified to LEV III standards<sup>324</sup> in MY 2015 or 2016 into the Early Tier 3 program by meeting all the same requirements under the primary Tier 3 schedule. There would not be a Tier 3 fleet average requirement for FTP or SFTP in MY 2015 or 2016 (and 2017 for vehicles over 6,000 lbs GVWR and up to 8,500 and MDPVs) if all the same vehicle models certified to LEV III are also certified as the Early Tier 3 vehicles meeting the same LEV III emission standards and also the Tier 3 additional requirements (high altitude, and cold CO and hydrocarbons). These Early Tier 3 vehicles would replace any Tier 2 offering of the vehicle model consistent with the LEV III offering replacing the LEV II models. If a manufacturer chooses to certify only a portion of their LEV III vehicle models as Early Tier 3 vehicles in a given MY, they will be required to meet the LEV III fleet average requirements in that MY for those models certified as Early Tier 3 vehicles. All vehicles models not certified as Early Tier 3 vehicles must meet all Tier 2 requirements.

#### c. Useful Life

The "useful life" of a vehicle is the period of time, in terms of years and miles, during which a manufacturer is responsible for the vehicle's emissions performance. For the Tier 3 program, we are finalizing several changes to the existing useful life provisions that are appropriate to the new Tier 3 standards described above.

The auto manufacturing industry has uniformly expressed the desire to produce and sell a single national vehicle fleet, including a general ability and willingness of the industry to certify their vehicles to a 150,000 mile, 15 year full useful life, as required by the LEV III program. However, the CAA, written at a time when vehicles did not last as long as they do today, precludes EPA from requiring a useful life value longer than 120,000 miles (and 10 or 11 years, depending on vehicle category and weight) for lighter light-duty

vehicles (LDVs and LDTs up to 3,750 lbs loaded vehicle weight (LVW) and up to 6,000 lbs GVWR (i.e., LDT1s)).

For heavier light-duty vehicles (i.e., LDT2s, 3s, 4s, as well as MDPVs, representing a large fraction of the light-duty fleet), this statutory restriction does not apply, and we are finalizing a 150,000 mile, 15 year useful life value, as proposed. For the lighter vehicles, we are continuing to apply the 120,000 mile (and 10 or 11 year, as applicable) useful life requirement from the Tier 2 program, also as proposed. For these lighter vehicles, manufacturers are allowed to choose to certify to either useful life value in complying with the fleet average.<sup>325</sup> In order for the Tier 3 NMOG+NO<sub>x</sub> standards to represent the same level of stringency regardless of which useful life value manufacturers choose, we proposed and are finalizing proportionally lower numerical values (85 percent of the NMOG+NO<sub>x</sub> 150,000 mile standards based on a data analysis in Chapter 1 of the RIA) for the declining fleet average FTP NMOG+NO<sub>x</sub> standards when a manufacturer chooses the 120,000 mile useful life. A manufacturer choosing the 120,000 mile useful life for any vehicle must maintain separate 120,000 mile and 150,000 mile useful life fleet averages for purposes of FTP NMOG+NO<sub>x</sub> fleet average compliance. Credits generated towards the required fleet averages are not transferable between the two useful life fleet averages.

We proposed that a manufacturer that certifies any vehicle model under the 120,000 mile provision be required to certify all their LDVs and LDT1s to the 120,000 mile useful life and associated numerically lower FTP NMOG+NO<sub>x</sub> fleet average standard. Comments from the auto industry expressed a concern that this approach would be inflexible to manufacturers' needs and unnecessarily burdensome. We have considered these comments, and we believe that the emission benefits of Tier 3 program will not be adversely affected if manufacturers are allowed to certify these lighter vehicles to the 120,000 mile useful life standards on a test group basis, and therefore we are finalizing this approach. Standards for all other pollutants<sup>326</sup> and all other test cycles such as SFTP remain the same regardless of whether manufacturers

<sup>325</sup> CARB has stated that they do not expect to accept vehicles certified under the federal Tier 3 program to a 120,000 mile useful life value for California certification, and thus for meeting California's fleet average NMOG+NO<sub>x</sub> standards.

<sup>326</sup> PM, CO, and HCHO.

<sup>324</sup> Including LEV III SFTP requirements.

choose the 120,000 mile or the 150,000 mile useful life periods.

For emission standards other than PM standards (e.g., NMOG+NO<sub>x</sub> standards), as proposed, manufacturers will be required to certify all vehicles to the 150,000 mile useful life beginning with the first model year that a vehicle model is certified to the FTP NMOG+NO<sub>x</sub> Bin 70 or lower (other than vehicles not yet required to meet a 150,000 mile useful life during the program phase in, and vehicles for which a manufacturer has the option and chooses to apply the 120,000 mile useful life value). This useful life requirement will apply as early as MY 2017. Beginning in MY 2020, all vehicles will need to certify to the 150,000 mile useful life for all emissions, regardless of NMOG+NO<sub>x</sub> certification bin, unless they are eligible for, and the manufacturer has chosen the 120,000 mile useful life and associated standards. (Note that the timing of the requirement to certify on the new test fuel follows the same approach as for the useful life requirement for emission standards other than PM standards (i.e., based on the first year a model is certified to FTP NMOG+NO<sub>x</sub> Bin 70 or below) as described in the next section.) For FTP and SFTP PM useful life requirements, manufacturers will be required to certify to 150,000 mile useful life for PM all vehicles that are included in the manufacturer's phase-in percentage meeting the new PM standards (other than eligible vehicles for which a manufacturer chooses to apply the 120,000 miles useful life value).

#### d. Test Fuels for Exhaust Criteria Emissions Standards

We recognize that test fuels are an important element of a national program. Vehicle manufacturers have emphasized in their comments the desire to reduce their test burdens by producing one vehicle that is tested on a single test procedure and on a single test fuel and that meets both California and federal requirements. Although we have been able to reasonably align the Tier 3 program with the LEV III program in most key respects, we recognize that the Tier 3 and LEV III test fuels are different, and that there may still exist some differences in emissions performance between vehicles tested on the two fuels. The largest difference between the two fuels is the Reid Vapor Pressure (RVP), and other differences in distillation properties and aromatic levels also exist (largely related to differences in actual in-use fuel nationally and in California). We are finalizing as proposed the requirement that manufacturers certify vehicles on

the new Tier 3 E10 test fuels<sup>327</sup> beginning with the first model year that a vehicle model is certified to the FTP NMOG+NO<sub>x</sub> Bin 70 or lower.<sup>328</sup> This requirement may apply as early as MY 2017 for vehicles up to 6000 lbs GVWR and MY 2018 for vehicles greater than 6000 lbs GVWR.<sup>329</sup> This requirement also applies to vehicles certified at Bin 70 and lower that are brought into the Tier 3 program under the Early Tier 3 option described in IV.A.7.b above, with the exception of the specific provision allowing the use of LEV III fuels discussed below. Beginning in MY 2020, all gasoline-fueled models will need to certify on the Tier 3 test fuels for all exhaust emission requirements, regardless of their certification bin.<sup>330</sup> As discussed in Section IV.A.7.c above, manufacturers must also meet the 150,000 mile useful life requirements for NMOG+NO<sub>x</sub> standards for these same vehicles as they are certified to Bin 70 and lower.

During the transition period from Tier 2 fuel to the new Tier 3 and LEV III E10 fuels, manufacturers have indicated that they face a substantial workload challenge of developing and certifying each vehicle model to the two new fuels simultaneously. We recognize this transitional challenge and are including an additional option. We are finalizing as proposed an option that vehicles certified in MYs 2015 through 2019 to California LEV III standards using California LEV III E10 certification test fuels and test procedures can be used for certifying to EPA Tier 2 or Tier 3 exhaust emission standards, including PM. A manufacturer may submit LEV III test data on vehicles tested using the new LEV III E10 fuels for Tier 2 or Tier 3 certifications. Consistent with existing Tier 2 policy, EPA may test vehicles certified to Tier 2 standards using LEV III test results on Tier 2 fuel for confirmatory or in-use exhaust testing. For vehicles certified in MY 2017 through 2019 to Tier 3 standards using LEV III E10 fuels, EPA will only use LEV III E10 fuels for confirmatory and in-use testing (except for high altitude or cold CO and hydrocarbons testing, as described below). Vehicles certified to

<sup>327</sup> This includes fuels used for cold temperature and high altitude testing and durability requirements. See Section IV.F below.

<sup>328</sup> The lower Bins are Bin 0, Bin 20, Bin 30 and Bin 50.

<sup>329</sup> Vehicles above 6000 lb GVWR choosing the alternative phase-in schedules described in Section IV.A.2.c above generally would begin using the Tier 3 test fuels for MY2019.

<sup>330</sup> Diesel fueled and alternative fueled vehicles will continue to test on the fuels used under the Tier 2 program except for E85 fueled vehicles, for which we are finalizing new test fuel specifications (see Section IV.F below).

the provisions of Early Tier 3 (Section IV.A.7.b above) will be treated the same as Tier 3 vehicles certified in MY 2017. For example, for MY 2015 and 2016, EPA will consider Early Tier 3 vehicles to be part of the Tier 3 program for purposes of fuel-related testing obligations. We will not accept test results using LEV II fuels for Tier 3 vehicle certification, including Early Tier 3 certifications, with the exception of the PZEV exhaust carry-over provision described below.

California does not have fuel specifications for high altitude testing or cold CO and hydrocarbon testing. For this reason, we are finalizing that for vehicles that manufacturers choose to certify using LEV III fuel and test procedures, manufacturers must use program-specific federal test fuels to comply with these federal-only requirements (i.e. Tier 2 vehicles will use Tier 2 fuel and Tier 3 vehicles will use Tier 3 fuel). Similarly, high altitude and cold CO and hydrocarbon confirmatory and in-use testing for these vehicles will be performed on the federal fuel that the manufacturer is required to use at certification as specified above regardless of whether LEV III or federal fuel is used for other testing.

We proposed the requirement that after MY 2019, all Tier 3 certification, confirmatory and in-use emission testing be required to use only the proposed Tier 3 E15 test fuel because it was believed to be a worst case fuel for emissions. Because we are finalizing Tier 3 E10 test fuels which are very similar as explained above to LEV III E10 test fuels, and not considered a worst case fuel, we are not finalizing the requirement for all testing to be performed on Tier 3 E10 test fuel. Instead, for certifications after MY 2019, EPA will continue to allow LEV III test results to be submitted for certification to Tier 3 standards, consistent with protocol under the Tier 2 program. However, if a manufacturer chooses to submit certification results for compliance with Tier 3 standards using the LEV III test fuel, then for confirmatory and in-use testing we will hold vehicles to the Tier 3 standards while using the Tier 3 fuel in addition to the LEV III test fuel; we will not allow new or carry-over certifications using LEV II or Tier 2 certification test fuels after MY 2019. CARB has indicated that they will accept Tier 3 test data (on federal certification test fuels) to obtain a California certificate as early as MY 2015. In this manner manufacturers should be able to avoid compliance testing on more than one fuel, since vehicles certified to Interim or Final

Tier 3 status using federal certification test fuels could also obtain LEV III certification.

Auto industry commenters noted that the LEV III program provides an allowance for manufacturers to carry over PZEV-certified vehicle exhaust data<sup>331</sup> from the LEV II program into LEV III compliance in MY 2015 through MY 2019. Thus, CARB allows these PZEV vehicles to use emission testing results using LEV II fuel (i.e. California Phase II test fuel) to meet the LEV III obligations. The commenters suggested that EPA allow manufacturers to carry over such PZEV 150,000 mile useful life exhaust emission data to meet the Tier 3 standards. We agree that this approach is appropriate during the transition, and we are finalizing this provision for MY 2015 through MY 2019, including allowing Early Tier 3 compliance at the Bin 30 level as a combined NMOG+NO<sub>x</sub> standard. EPA will hold vehicles certified using this provision to the Tier 3 emission requirements when they are tested on the LEV II fuel for confirmatory and in-use. Compliance testing of these vehicles for all other Tier 3 obligations (i.e., high-altitude testing and Cold CO and hydrocarbons testing) must be performed using Tier 3 fuel, and these vehicles will be required to meet the Tier 3 standards for Bin 30.

#### e. High Altitude Requirements

FTP emission standards are historically designed to be applicable at all altitudes. Under Tier 2, the same FTP emission bin standards applied to vehicles tested at both low and high-altitude. However, fundamental physical challenges exist at high altitude resulting in typically higher emissions during cold starts compared with starts at lower altitudes (i.e., sea level), and these challenges become more pronounced as emission standards become more stringent. This expected increase in emissions is primarily due to the lower air density at higher altitudes. Due to the lower air density, the needed volume of the hot combustion exhaust required to quickly heat the catalyst in the first minute after a cold start is reduced. As a result, catalyst light-off is delayed and cold start emissions can increase. Vehicles under the Tier 2 program typically have had sufficient compliance margins to absorb this increase in emissions during testing under high-altitude conditions. However, given the extremely low standards we are finalizing in Tier 3, manufacturers will have less

compliance margin with which to address the issue.

Under the Tier 3 program, we expect that the emission control technologies selected for low altitude performance will also provide very significant emission control at high altitude.<sup>332</sup> However, as explained above, unique emission challenges exist with operation at higher altitude, often requiring manufacturers to design their emission controls specifically for higher altitude.

We do not believe that the impact of the fairly small fraction of overall U.S. driving that occurs in high altitude locations warrants a requirement for additional technologies to be applied specifically for high-altitude conditions. To avoid requiring manufacturers to use special high-altitude emission control technologies, we are allowing manufacturers limited relief for certification testing at high altitude, as proposed. Specifically, for sea-level certifications to Tier 3 Bins 20, 30, and 50, a manufacturer could comply with the next less-stringent bin for testing at high altitude. For example, a manufacturer can certify to Bin 50 for testing at high altitude versus Bin 30 at sea level). For vehicles certified at sea level to Bins 70 and 125, manufacturers can comply with standards 35 mg/mi higher (e.g., 105 mg/mi and 160 mg/mi, respectively). We are providing no high altitude relief for vehicles certified to Bin 160. This high altitude relief provision applies to all Final Tier 3 vehicles for the duration of the Tier 3 program.

For intermediate altitudes that fall between the specified low and high altitude test conditions, the emission performance should continue to be representative of the controls implemented to meet standards at the required altitude test conditions, consistent with Tier 2 protocol. Any deviation in the use of these controls at the intermediate altitudes may be considered an AECD that must be reported by the manufacturer and justified as not being a defeat device.<sup>333</sup>

Table IV-9 presents the Tier 3 high altitude standards.

TABLE IV-9—TIER 3 HIGH ALTITUDE STANDARDS

Bin	Sea level FTP standard (mg/mi NMOG+NO <sub>x</sub> )	Altitude FTP standard (mg/mi NMOG+NO <sub>x</sub> )
Bin 160 .....	160	160
Bin 125 .....	125	160
Bin 70 .....	70	105
Bin 50 .....	50	70
Bin 30 .....	30	50
Bin 20 .....	20	30

#### f. Highway Test Standards

Sustained high-speed operation can result in NO<sub>x</sub> emissions that may not be represented on either the FTP or SFTP cycles. Although we are not aware of any serious issues with this mode of operation with current Tier 2 vehicles, we are interested in preventing increases in these NO<sub>x</sub> emissions as manufacturers develop new or improved engine and emission control technologies.

For this reason, we are finalizing, as proposed, a provision that the Tier 3 FTP NMOG+NO<sub>x</sub> standards above also apply on the Highway Fuel Economy Test (HFET), which is performed as a part of GHG and Fuel Economy compliance testing. Thus, the Tier 3 FTP NMOG+NO<sub>x</sub> standard for the bin at which a manufacturer has chosen to certify a vehicle will also apply on the HFET test. For example, if a manufacturer certifies a vehicle to Bin 70, the vehicle's NMOG+NO<sub>x</sub> performance over the HFET could not exceed 70 mg/mi. Manufacturers will simply need to ensure that the same emission control strategies implemented for the FTP and SFTP cycles are also effective during the highway test cycle. We believe that this requirement will not require manufacturers to take any unique technological action, will not add technology costs, and will not add significantly to the certification burden.

#### g. Interim 4,000 Mile SFTP Standards

During the period of the declining NMOG+NO<sub>x</sub> standards, we are finalizing the proposed requirement that interim Tier 3 vehicles meet 4,000 mile SFTP standards, consistent with the existing Tier 2 and LEV II program requirements. The 4,000 mile standards apply to each vehicle model individually and to each component of the SFTP composite cycle. This approach is designed to prevent excessive emission levels from individual vehicle models being masked by the averaging of the manufacturer's fleet emissions. Similarly, this approach also prevents poor performance on a

<sup>331</sup> California's PZEV exhaust standards are the same as their SULEV standards and the Tier 3 Bin 30, and are certified to a 150,000 mile useful life.

<sup>332</sup> *High-altitude conditions* means a test altitude of 1,620 meters (5,315 feet). *Low altitude conditions* means a test altitude less than 549 meters (1,800 feet).

<sup>333</sup> § 86.1809-12 Prohibition of defeat devices

single cycle of the SFTP. We believe it is appropriate to require any individual Interim Tier 3 vehicle to at a minimum

meet the existing requirements under the Tier 2 and LEV II programs. Table IV-10 below presents the 4,000 mile

SFTP standards for interim Tier 3 vehicles.

TABLE IV-10—4,000 MILE SFTP EXHAUST STANDARDS FOR INTERIM TIER 3 VEHICLES  
[grams/mile]

Vehicle category	US06 NMOG+NO <sub>x</sub>	US06 CO	SC03 NMOG+NO <sub>x</sub>	SC03 CO
LDV/LDT1 .....	0.14	8.0	0.20	2.7
LDT2 .....	0.25	10.5	0.27	3.5
LDT3 .....	0.4	10.5	0.31	3.5
LDT4 .....	0.6	11.8	0.44	4.0

We believe that vehicles considered to be Final Tier 3 vehicles (i.e., they meet the Tier 3 PM requirements, specifically the stringent SFTP PM standards) will have sufficiently robust designs that the 4,000 mile SFTP standards will no longer be necessary and so will not apply to those vehicles. Additionally, once the program reaches the fully phased-in fleet average composite standard of 50 mg/mi in 2025, high SFTP emissions even on a limited portion of a manufacturer’s fleet should be effectively mitigated, and the 4,000 mile SFTP standards will no longer apply.

h. Phase-In Schedule

As proposed, the major provisions of the Tier 3 program phase in based on model year and on the emission levels to which manufacturers certify their vehicles. As described in Section IV.A.3, under the Tier 3 program, manufacturers are required to certify each vehicle model to an FTP bin, which is then used to calculate the NMOG+NO<sub>x</sub> fleet average of all of its Tier 3 vehicles. Manufacturers must also determine the SFTP levels of each model and calculate the NMOG+NO<sub>x</sub> fleet average for the SFTP requirements as described in Section IV.A.4. These separate FTP and SFTP fleet average calculations satisfy one aspect of certification under the Tier 3 program, specifically the standards associated with each model year.

As described in Sections IV.A.7.c and IV.A.7.d above, the longer (150,000 mile) useful life value, as applicable, and the new Tier 3 test fuel for exhaust testing will be implemented as manufacturers certify vehicles to more stringent NMOG+NO<sub>x</sub> standards, with the threshold to implement both of these provisions being Bin 70. Beginning in MY 2017, any vehicle certified to Bin 70 or lower will be required to be certified on Tier 3 test fuel. In addition, any vehicle certified to Bin 70 or lower that is required to meet

the longer 150,000 mile useful life will be required to do so at that point. Independent of the Tier 3 test fuel phase in schedule, the 150,000 mile useful life for PM standards will be required when the vehicle is certified to the new Tier 3 PM standards as described below in the PM phase-in schedules. Beginning in MY 2020, all gasoline-fueled vehicles will be required to be certified for exhaust emissions on the Tier 3 test fuel, regardless of their certification bin or applicable useful life.

Manufacturers must also comply with more stringent PM standards on a percent phase-in schedule. Compliance with the PM standards, which is consistent with the CARB LEV III program, is independent of the NMOG+NO<sub>x</sub> fleet average requirements described above. The PM emission standards for FTP and SFTP described in Section IV.A.3 and 4 respectively will be implemented as a percent phase-in requirement as described below under a primary phase-in schedule or under an optional phase-in schedule.

Vehicle models that a manufacturer certifies to a Tier 3 NMOG+NO<sub>x</sub> bin, that meet the requirements of the PM phase-in schedule, and that comply with the other Tier 3 requirements (i.e., 150,000 mile useful life and Tier 3 test fuel, as applicable) will be considered “Final Tier 3” compliant vehicles. All other vehicles certified to Tier 3 bins but not yet meeting the PM and other Tier 3 requirements will be considered “Interim Tier 3” compliant vehicles. At the completion of the percent phase-in period for PM (2021 for the primary PM phase-in schedule and 2022 for the optional PM phase-in schedule, as described below), 100 percent of vehicles will need to meet all of the Tier 3 requirements and will be considered Final Tier 3 vehicles.

As proposed, for the PM requirements, each model year manufacturers must meet either the primary PM percent phase-in or the

optional PM phase-in as described in the following subsections. The primary percent PM phase-in schedule is composed of fixed annual minimum phase-in percentages that we expect most manufacturers to choose in order to comply with the Tier 3 requirements. The optional PM phase-in schedule provides additional flexibility for manufacturers with too few product offerings to allow for a sufficiently gradual transition into the Final Tier 3 requirements, as described below. In either case, Interim Tier 3 vehicles not yet meeting the Tier 3 PM standards must at a minimum meet the Tier 2 PM full useful life FTP PM standard of 10 mg/mi and the SFTP PM weighted composite standard of 70 mg/mi.

i. Primary PM Percent Phase-In Schedule

It is important to note that the percent phase-in of the new Tier 3 PM standards and the declining fleet average NMOG+NO<sub>x</sub> standards that we are finalizing are separate and independent elements of the Tier 3 program. “Phase-in” in the context of Tier 3 PM standards means the fraction of a manufacturer’s fleet that is required to meet the new Tier 3 PM standards in a given model year. We expect that manufacturer fleets may consist of a mix of vehicle models certified to Tier 2, LEV II, LEV III and Tier 3 standards throughout the percent phase-in period.

As discussed above, vehicles originally certified to Tier 2, LEV II, and LEV III may be carried over into the Tier 3 program as Interim Tier 3 vehicles. A vehicle will be considered a Final Tier 3 vehicle when it is certified to one of the Tier 3 bins, meets the new Tier 3 PM standards for FTP (3mg/mi) and US06 (10 or 6 mg/mi), certifies to the 150,000 useful life value (as applicable), and certifies on the new Tier 3 test fuel. Table IV-11 below presents the PM phase-in schedule for Final Tier 3 vehicles.

TABLE IV-11—PM PHASE-IN SCHEDULE FOR FINAL TIER 3 VEHICLES

Model year	2017	2018	2019	2020	2021	2022 and later
Manufacturer's Fleet (%) .....	20 <sup>a</sup> .....	20	40	70	100	100
Vehicle Types .....	≤ 6,000 lbs GVWR ....	All vehicles ≤ 8,500 lbs GVWR and MDPVs				

<sup>a</sup> Manufacturers comply in MY 2017 with 20 percent of their LDV and LDT fleet under 6,000 lbs GVWR, or alternatively with 10 percent of their total LDV, LDT, and MDPV fleet Optional PM Phase-in

The PM percent-of-sales phase-in schedule described above will allow manufacturers with multiple vehicle models to plan the phase-in of those models based on anticipated volumes of each vehicle model. However, manufacturers certifying only a few vehicle models might not benefit from this schedule. This is because, in order to satisfy the phase-in schedule percentages, they may have to over-comply with the required percentages earlier than will a manufacturer with many vehicle models available for the phase-in.

For instance, a manufacturer with only two models that each equally account for 50 percent of their sales will be required to introduce (at least) one of the models in MY 2017 to meet the PM phase-in requirement of 20 percent in the first year. Because it represents 50 percent of the manufacturer's sales, this model will then also meet the requirements for MY 2018 (20 percent) and MY 2019 (40 percent). To meet the MY 2020 requirement of 70 percent of sales, however, the manufacturer will need to introduce the second Tier 3 vehicle that year. Thus the manufacturer will have introduced 100 percent of its Tier 3 models one year earlier than required of a manufacturer that is able to delay the final 30 percent of its fleet until MY 2021 (by distributing its models over the entire phase-in period).

To provide for more equivalent phasing in of the PM requirements among all manufacturers in the early years of the program, we are finalizing, as proposed, an optional "indexed" PM phase-in schedule that can be used by a manufacturer to meet its PM percent phase-in requirements. A manufacturer that exceeds the phase-in requirements in any given year will be allowed to, in effect, offset some of the phase-in requirements in a later model year. The optional phase-in schedule will be acceptable if it passes a mathematical test. The mathematical test is designed to provide manufacturers a benefit from certifying to the standards at higher volumes than they are obligated to under the normal phase-in schedule, while ensuring that significant numbers of vehicles are meeting the new Tier 3 requirements during each year of the

optional phase-in schedule. In this approach, manufacturers weight the earlier years by multiplying their percent phase-in by the number of years prior to MY 2022 (i.e., the second year of the 100 percent phase-in requirement).

The mathematical equation for applying the optional PM phase-in is as follows:  $(5 \times APP_{2017}) + (4 \times APP_{2018}) + (3 \times APP_{2019}) + (2 \times APP_{2020}) + (1 \times APP_{2021}) = 540$ , where APP is the actual phase-in percentage for the referenced model year.

The sum of the calculation must be greater than or equal to 540, which is the result when the optional phase-in equation is applied to the primary percent phase-in schedule (i.e.,  $5 \times 20\% + 4 \times 20\% + 3 \times 40\% + 2 \times 70\% + 1 \times 100\% = 540$ ).

Applying the optional PM phase-in equation to the hypothetical manufacturer in the example above, the manufacturer can postpone its model introductions by one year each, to MY 2018 and MY 2021. Its calculation is  $(5 \times 0\% + 4 \times 50\% + 3 \times 50\% + 2 \times 50\% + 1 \times 100\% = 550$ , and thus the phase-in is acceptable.

i. In-Use Standards

i. NMOG+NO<sub>x</sub>

The Tier 3 emission standards will require a substantial migration of emission control technology historically used only on a small percent of the fleet and typically limited to smaller vehicles and engines. While we believe that these technologies can generally be used on any vehicle and are applicable to the entire fleet, manufacturers have less experience with the in-use performance of these technologies across the fleet. For example, technologies that accelerate catalyst warm-up such as catalyst location close to the engine exhaust ports and other advanced thermal management approaches will be new to certain vehicle types, particularly larger vehicles (i.e., LDT3/4s), which have historically not relied on these technologies to meet emission standards.

As proposed, to help manufacturers address the lack of in-use experience and associated challenges with the expanded introduction of these

technologies, particularly in the larger vehicles, we are finalizing temporarily-relaxed in-use NMOG+NO<sub>x</sub> standards that will apply to all vehicles certified to Bins 70 and cleaner as Interim or Final Tier 3 vehicles. The in-use standards will apply during the entire percent phase-in period (i.e., through MY 2021). The in-use standards are 40 percent less stringent than the certification standards, providing a significant but reasonable temporary cushion for the uncertainties associated with new technologies (or new applications of existing technologies) over the life of the vehicles.

The in-use NMOG+NO<sub>x</sub> standards are shown in Table IV-12.

TABLE IV-12—FTP IN-USE STANDARDS FOR LIGHT DUTY VEHICLES AND MDPVS

[mg/mi]	
Bin	NMOG+NO <sub>x</sub> (mg/mi)
Bin 160 .....	160
Bin 125 .....	125
Bin 70 .....	98
Bin 50 .....	70
Bin 30 .....	42
Bin 20 .....	28

ii. PM

As with the NMOG+NO<sub>x</sub> standards, the introduction of new emission control technologies or new applications of existing technologies (e.g., GDI, turbocharging, downsized engines) will create significant uncertainties for manufacturers about in-use performance over the vehicle's useful life. We are finalizing as proposed a temporary in-use FTP standard for PM of 6 mg/mi for all light duty vehicles certified to the Tier 3 full useful life 3 mg/mi standard. Since the Tier 3 FTP PM standard has a percent phase-in schedule spread over several years, starting in 2017 with full phase-in completed in 2022, we are finalizing the requirement that the in-use standard apply to all vehicles certified to the new PM standards during the entire percent phase-in period (i.e., through MY 2021).

We also proposed temporarily-relaxed in-use US06 PM standards. As described

in Section IV.A.4.b above, we are finalizing an in-use US06 PM standard of 10 mg/mi for the intermediate years of the program (MYs 2019 through 2023) in response to industry concerns about emissions variability as the new standards become effective.

j. FFVs

Because of the physical and chemical differences in how emissions are generated and controlled between vehicles operating on different blends of gasoline and ethanol, manufacturers of vehicles designed for high-percentage blends of ethanol (usually called Flexible Fuel Vehicles, or FFVs) may face unique compliance challenges under the Tier 3 program. Historically, under the Tier 2 program, FFVs have only been required to meet all Tier 2 emission standards, FTP and SFTP, while operating on gasoline (E0); when operating on the alternative fuel (generally this means a blend that is nominally 85 percent ethanol, or E85), they have only been required to meet the FTP emission standards.

However, E85 use may rise considerably in the future as ethanol use increases in response to the Renewable Fuels Standards (RFS). Thus, as the Tier 3 program is implemented, it is increasingly important that FFVs maintain their emission performance when operating on E85 across different operating conditions.

We believe that at standard test conditions, requiring manufacturers to meet the Tier 3 standards on any blend of gasoline and ethanol will not be significantly more challenging technologically than compliance on lower ethanol blends, including the E10 Tier 3 test fuel we are adopting. We are thus finalizing, as proposed, the requirement that in addition to complying with the Tier 3 requirements when operating on Tier 3 test fuel, FFVs also comply with both the FTP and the SFTP emission standards when operating on E85. This includes the requirement to meet emission standards for both Tier 3 test fuel and E85 for the FTP, highway test, and SFTP emission standards at standard test temperatures (i.e., 68 °F to 86 °F). Since FFVs can operate on any blend of gasoline and ethanol (up to a nominal 85 percent ethanol), the emission requirements apply to operation at all levels of the alternative fuel that can be achieved with commercially available fuels. However, for exhaust emission compliance demonstration purposes, we will test on Tier 3 test fuel and on fuel with the highest available ethanol content.

k. Credit for Direct Ozone Reduction (DOR) Technology

Since the late 1990s, technologies have been commercialized with which vehicles can remove ozone from the air that flows over the vehicle's coolant radiator. In such direct ozone reduction (DOR) technology, a catalytic coating on the radiator is designed to convert ambient ozone into gaseous oxygen, as a way of addressing the air quality concerns about ozone. Detailed technical analyses for the California LEV II and the federal Tier 2 programs showed that when properly designed these systems can remove sufficient ozone from the air to be equivalent to a quantifiable reduction in tailpipe NMOG emissions. In the earlier programs, both California and EPA provided methodologies through which a manufacturer could demonstrate the capability and effectiveness of the ozone-reducing technology and be granted an NMOG credit. A small number of vehicle models with DOR applications received credit under the LEV II program; no manufacturer formally applied for credits under the federal Tier 2 program.

Some manufacturers have expressed an interest in the continued availability of a DOR credit as a part of their potential LEV III and Tier 3 compliance strategies. EPA believes that when a DOR system is shown to be effective in reducing ozone, a credit toward Tier 3 compliance is warranted. We are finalizing a provision, as proposed, that manufacturers following the California methodology for demonstrating effectiveness and calculating an appropriate credit for a DOR system be granted a specific credit toward the NMOG portion of the NMOG+NO<sub>x</sub> standard.<sup>334</sup> As with the California program, such a credit may not exceed 5 mg/mi NMOG.

l. Credit for Adopting a 150,000-Mile Emissions Warranty

Under the Tier 3 standards, manufacturers are expected to design their emission control systems to continue to operate effectively for a useful life of 150,000 miles (120,000 miles for some smaller vehicles). However, manufacturers are only required to replace failed emission control components or systems on customers' vehicles for a limited time period, specified in the Clean Air Act (80,000 miles/8 years for key emission control components). EPA believes that voluntary extension of this warranty obligation by manufacturers would

<sup>334</sup> EPA is incorporating the CARB DOR methodology by reference.

provide additional emission reductions by helping ensure that controls continue to operate effectively in actual operation through the full life of the vehicle.

We are finalizing as proposed that a manufacturer providing its customers with a robust emission control system warranty of 15 years or 150,000 miles be eligible for a modest credit of 5 mg/mi NMOG+NO<sub>x</sub>.<sup>335</sup> Because of the significant liability that manufacturers would be accepting, we do not expect that the use of this credit opportunity will be widespread. However, based on our modeling of the expected deterioration of the emissions of future Tier 3 vehicles absent repair/replacement of failed emission controls, we anticipate that the value to the environment of long emissions warranties in terms of reduced real-world emissions would significantly exceed the 5 mg/mi NMOG+NO<sub>x</sub> credit.<sup>336</sup>

We will use the same criteria for approving such a credit as does the parallel California program.<sup>337</sup> Thus, in addition to committing to customers that failing emission controls will be repaired or replaced for 15 years/150,000 miles, manufacturers will also need to accept the liability that in the event that a specific emissions control device fails on greater than 4 percent of a vehicle model's production, they will recall the entire production of that model for repair.

m. Averaging, Banking, and Trading of Credits

We proposed and are finalizing an averaging, banking, and trading (ABT) program similar to those that have historically been a part of most EPA emission control programs. For the Tier 3 final rule, the ABT program is consistent with the other Tier 3 program elements, the heavy duty exhaust emission standards and the evaporative emission standards programs, with the only exception being credit life during the longer phase in for the light duty program as described below. The ABT program is intended to provide an opportunity for manufacturers to deploy their Tier 3 vehicle models more efficiently, especially during the transition years, and to avoid excessive delays in the necessary technological improvements across the fleet. We have

<sup>335</sup> Manufacturers choosing to comply with the standards for a 120,000 mile useful life for their LDVs and LDT1s are not eligible for this extended warranty credit for those vehicles.

<sup>336</sup> Beardsley, M, et al. (2013, February). Updates to MOVES for the Tier 3 NPRM. Memorandum to the docket.

<sup>337</sup> EPA is incorporating the CARB extended emission warranty provisions by reference.



designed the Tier 3 ABT program to provide for credits to be generated by certifying vehicles that perform better than the fleet-average NMOG+NO<sub>x</sub> standards. These credits may be used within a company to offset vehicles that perform worse than the standards, they may be banked for later use, or they may be traded to other manufacturers.

We are also finalizing limitations on the use of credits for the light-duty fleet. We proposed that Tier 3 credits expire after 5 model years following the model year they are generated and solicited comment on the Tier 3 credit life. In communications regarding the proposed rule, representatives of the auto industry expressed to EPA that the value of the ABT program during the MY 2017–2025 phase-in of the primary program would be improved if credits had a longer credit life.<sup>338</sup> We determined that, with certain restrictions, Tier 3 credit life can be temporarily extended with no adverse impacts on the overall emission reductions of the program. Specifically, we are finalizing a credit life of 8 years for credits generated in MYs 2017–2022 for the FTP and SFTP NMOG+NO<sub>x</sub> fleet average standards for the primary program only. For the heavier light-duty vehicles, the 8-year credit life begins for credits generated in MY 2018. Note that, as proposed, credits generated under the Early Tier 3 Credit provision (Section IV.A.7.a) are limited to 5-year life, and are not affected by the longer credit life.

For credits generated in MYs 2023–2025, the credit life declines by one year of credit life annually, with credit life stabilizing at 5 years for credits generated in MYs 2025 and later. That is, credits generated in MY 2023 have a 7-year life, in MY 2024 a 6-year life, and in MY 2025 and later a 5-year life. However, while credits can be generated, banked, and used internally for the extended time periods, credits cannot be traded to other manufacturers after 5 years.

After considering the views expressed by manufacturers as well as the implementation schedules of this Tier 3 rule and the 2017 light-duty GHG rule, we believe that the temporary up-to-8-year credit life available to manufacturers during the phase-in period provides substantial flexibility to address manufacturer uncertainties about future technology development and product planning during implementation of the Tier 3 program. We also believe this longer credit life provision will alleviate most if not all concerns expressed by manufacturers

with respect to the challenges they may encounter by simultaneous implementation of the two programs.

As proposed, we are finalizing a provision for a manufacturer to create a credit deficit, at certification or at the end of the production year, if its fleet average emissions exceed the standard. A manufacturer would be required to use all of its banked credits, if any, before creating a credit deficit. A credit deficit would need to be resolved before the fourth model year after the deficit was created; that is, a manufacturer may not maintain a credit deficit more than 3 consecutive model years.

#### n. Tier 3 Transitional Emissions Bins

During the development of the proposed rule and in their comments, manufacturers pointed out that they may continue to produce some vehicles as late as MY 2019 that could be certified to Tier 2 Bin 3 or Bin 4 standards. In order to provide manufacturers flexibility in meeting the fleet average standards and to further facilitate the transition, we will allow manufacturers to certify to the combined NMOG+NO<sub>x</sub> levels of these Tier 2 bins through MY 2019. We are finalizing two transitional Tier 3 bins, Bin 110 and Bin 85, that have FTP NMOG+NO<sub>x</sub> standards of 110 mg/mi and 85 mg/mi, respectively (i.e., the sum of the NMOG and NO<sub>x</sub> values from the Tier 2 bins). The associated FTP standards for CO, PM, and HCHO corresponding to these bins are identical to those for vehicles certified to the Tier 3 Bin 125. Tier 3 SFTP standards will apply to these vehicles, and these vehicles will be included in the Tier 3 PM percent phase-in calculations.

#### o. Compliance Demonstration

In general, we are finalizing requirements that manufacturers demonstrate compliance with the Tier 3 light-duty vehicle emission standards in a very similar manner to existing Tier 2 vehicle compliance (see § 86.1860 of the regulatory language). However, for Tier 3, manufacturers must calculate their compliance with the fleet average standards and percent phase-in standards based on annual nationwide sales, including sales in California and Clean Air Act Section 177 states. We believe that this approach represents another step toward achieving the goal of an effectively nationwide program as early as possible, which has been a basic principle in EPA's development of this program and broadly supported by vehicle manufacturers. We also believe that basing compliance on nationwide sales may reduce the need for manufacturers to project future sales

and track past years' sales in a disaggregated way. Because the Tier 3 provisions become increasingly consistent with LEV III provisions as the Tier 3 program phases in, we believe that any disproportionate impacts of different mixes of vehicles in different states are unlikely to occur.

This nationwide compliance calculation approach applies to vehicles as they become subject to the Tier 3 provisions, either the declining fleet-average NMOG+NO<sub>x</sub> curves or the percent phase-in PM standards. Were any manufacturer to choose to use the alternative FTP and SFTP phase-ins, which are not a part of the LEV III program, the manufacturer would not include sales in California or in the Section 177 states in its compliance calculations.

### B. Tailpipe Emissions Standards for Heavy-Duty Vehicles

#### 1. Overview and Scope of Vehicles Regulated

After considering the comments we received, we are adopting the Tier 3 exhaust emissions standards that we proposed for chassis-certified heavy-duty vehicles (HDVs) between 8501 and 14,000 lbs gross vehicle weight rating (GVWR). Vehicles in this GVWR range are often referred to as Class 2b (8501–10,000 lbs) and Class 3 (10,001–14,000 lbs) vehicles, and are typically full-size pickup trucks and work vans certified as complete vehicles.<sup>339</sup> Medium-duty passenger vehicles (MDPVs), although in the Class 2b GVWR range, are subject to Tier 3 standards discussed in Section IV.A. To a large extent, we are also adopting the Tier 3 certification testing and compliance provisions that we proposed for HDVs. There are, however, a number of improvements we are making in response to comments, as discussed in detail below.

The Tier 3 program for HDVs will bring substantial reductions in harmful emissions from this large fleet of work trucks and vans, a fleet that is used extensively on every part of the nation's highway, rural, and urban roadway system. The fully-phased-in Tier 3 standards levels for non-methane organic gas (NMOG) plus oxides of nitrogen (NO<sub>x</sub>), and for particulate matter (PM), are on the order of 60 percent lower than the current standards levels.

<sup>339</sup> 40 CFR 86.1803–01 defines HDVs to also include motor vehicles at or below 8,500 lbs GVWR that have a vehicle curb weight of more than 6,000 lbs or a basic vehicle frontal area in excess of 45 square feet, and these vehicles will also be subject to the Tier 3 standards and other provisions applicable to Class 2b vehicles discussed in this section.

<sup>338</sup> Passavant, G. (January 2014), Meetings with Chrysler—Tier 3 NPRM Lead Time and ABT, Memorandum to Docket.

We proposed to require that diesel-fueled Class 2b and 3 complete vehicles, like their gasoline-fueled counterparts, be certified to the Tier 3 standards on the chassis test; we also proposed to include these vehicles in the Tier 3 HDV averaging, banking, and trading (ABT) program. Currently only gasoline-fueled Class 2b/3 complete HDVs are required to chassis certify.

The International Council for Clean Transportation (ICCT) provided comments in support of this requirement, arguing that it is needed to stop manufacturers from making trucks marginally above 8500 lbs GVWR to avoid light-duty emission standards. The Truck and Engine Manufacturers Association (EMA) opposed mandatory chassis certification for any class of engines or vehicles over 8500 lbs GVWR, arguing that the existing flexibility is needed to minimize unnecessary costs and certification burdens. EMA commented that, at a minimum, EPA should maintain optional certification of diesel engines used in complete Class 3 vehicles. In their joint comments, the Alliance of Automobile Manufacturers and the Association of Global Automakers also requested that EPA retain the option for complete Class 3 diesel vehicles and engines, arguing that otherwise manufacturers may be required to dual certify vehicle models that include variants both under and over 14,000 lbs.

We are sensitive to this issue but remain concerned that the fleet average standard program we are finalizing would not work well if a major fleet component, such as complete Class 3 diesel trucks, can be left in or taken out of the fleet calculation based on what each manufacturer considers to be most advantageous. We believe the resulting competitive issues and uncertainties would be problematic, given the wide variance in gasoline/diesel HDV sales among the manufacturers, our provision for averaging across each manufacturers' entire Class 2b/3 fleet, and the overwhelming preponderance of diesels in the Class 3 market. It would also create uncertainties in the Tier 3 environmental benefits, given the pronounced difference between these Tier 3 standards and the heavy-duty diesel engine standards we set 13 years ago, which we expect to remain in effect for the foreseeable future.

As a result, we are finalizing these provisions as proposed, except that we are providing that manufacturers, instead of certifying complete diesel Class 3 HDVs, may install diesel engines that have been engine-certified for any model year that the engine family has less than half of its sales being installed

in such non-chassis-certified complete Class 3 vehicles. For example, if a company has a certified diesel engine family with 10,001 sales in MY 2020, up to 5,000 of those engines may be installed in complete Class 3 HDVs that are not chassis-certified for exhaust emissions. This provision is intended to help address manufacturers' concern about dual certification, while at the same time ensuring a coherent fleetwide standards regimen in this vehicle class. It also better harmonizes with California's low-emission vehicle (LEV) III program which does not mandate chassis certification for diesel Class 3 vehicles. By only allowing engine-certified vehicles in the case of engines that are primarily produced for other purposes, we believe this approach adequately guards against potential abuse. In the case of complete diesel Class 3 HDVs produced by a company other than the engine certifier, the responsibility for ensuring the sales limit is not exceeded remains with the vehicle manufacturer, who will need to coordinate with the engine supplier to ensure compliance.

Manufacturers of incomplete HDVs that are sold to secondary manufacturers for subsequent completion (less than 10 percent of the Class 2b and 3 U.S. market) are also allowed under existing EPA regulations to certify via either the chassis or engine test, and those who choose to chassis-certify in the future will be subject to Tier 3 requirements. We asked for comment on mandating chassis certification of incomplete Class 2b and 3 vehicles, noting that California's LEV III program includes such a requirement for Class 2b. Commenters expressed opposition to this extension of mandatory chassis certification, despite their general support for harmonization with LEV III; as a result, we are not mandating chassis certification for any incomplete HDVs.

The key elements of the Tier 3 program for HDVs parallel those for passenger cars and light-duty trucks (LDTs), with adjustments in standards levels, emissions test requirements, and implementation schedules, appropriate to this sector. These key elements include:

- A combined NMOG+NO<sub>x</sub> declining fleet average standard beginning in 2018 and reaching the final, fully phased-in level in 2022,
- creation of a bin structure for standards, including standards for carbon monoxide (CO) and formaldehyde,
- PM standards phasing in separately on a percent-of-sales basis,
- changes to the test fuel for gasoline- and ethanol-fueled vehicles,

- extension of the regulatory useful life to 150,000 miles,
- a new requirement to meet standards over the supplemental federal test procedure (SFTP) that addresses real-world driving modes not well-represented by the federal test procedure (FTP) cycle alone, and
- special flexibility provisions for small businesses and small volume manufacturers described in Section IV.G.

As in the light-duty Tier 3 program, we have put a strong emphasis on coordinating HDV Tier 3 program elements with California's LEV III program for Class 2b and 3 vehicles, referred to in LEV III as medium-duty vehicles (MDVs). The goal is to create a coordinated "national program" in which California would accept compliance with Tier 3 standards as sufficient to also satisfy LEV III requirements, thus allowing manufacturers to comply nationwide by marketing a single vehicle fleet. As part of this effort, we proposed that manufacturers of Tier 3 HDVs calculate compliance with the fleet average standards and percent phase-in standards based on annual nationwide sales, including sales in California and in states implementing California standards under Clean Air Act section 177. Commenters expressed emphatic support for this approach and we are finalizing it as a key element of the Tier 3 program.

## 2. HDV Exhaust Emissions Standards

### a. Bin Standards

Manufacturers will certify HDVs to Tier 3 requirements by having them meet the standards for NMOG+NO<sub>x</sub>, PM, CO and formaldehyde for one of the bins listed in Table IV-13. Manufacturers choose bins for their vehicles based on their product plans and corporate strategy for compliance with the fleet average standards discussed in Section IV.B.2.b, and once a vehicle's bin is designated, those bin standards apply throughout its useful life. Because the fleet average standards become more stringent over time, the bin mix will gradually shift from higher to lower bins.

As in the past, there are numerically higher standards levels for Class 3 vehicles than for Class 2b vehicles, reflective of the added challenge in reducing per-mile emissions from large work trucks designed to carry and tow heavier loads. Also, the standards levels for both Class 2b and Class 3 HDVs are significantly higher than those being adopted for light-duty trucks due to marked differences in vehicle size and

capability, and to our requirement to test HDVs in a loaded condition (at the adjusted loaded vehicle weight (ALVW)). By conducting emissions testing with loaded vehicles, the heavy-duty program ensures that emissions controls are effective when these

vehicles are performing one of their core functions: hauling heavy loads. This is a key difference between the heavy-duty and light-duty truck programs. The bin structure and standards levels are consistent with those in California's LEV III program. We requested comment

on the usefulness of creating additional bins between Bin 0 and the next lowest bin in each vehicle class, as a means of encouraging clean technologies and adding flexibility, but commenters saw no need for these.

TABLE IV-13 FTP STANDARDS FOR HDVS

	NMOG+NO <sub>x</sub> (mg/mi)	PM (mg/mi)	CO (g/mi)	Formaldehyde (mg/mi)
<b>Class 2b (8501-10,000 lbs GVWR)</b>				
Bin 395 (interim) .....	395	8	6.4	6
Bin 340 (interim) .....	340	8	6.4	6
Bin 250 .....	250	8	6.4	6
Bin 200 .....	200	8	4.2	6
Bin 170 .....	170	8	4.2	6
Bin 150 .....	150	8	3.2	6
Bin 0 .....	0	0	0	0
<b>Class 3 (10,001-14,000 lbs GVWR)</b>				
Bin 630 (interim) .....	630	10	7.3	6
Bin 570 (interim) .....	570	10	7.3	6
Bin 400 .....	400	10	7.3	6
Bin 270 .....	270	10	4.2	6
Bin 230 .....	230	10	4.2	6
Bin 200 .....	200	10	3.7	6
Bin 0 .....	0	0	0	0

The NMOG+NO<sub>x</sub> standards levels for the highest bins in each class (Class 2b Bin 395 and Class 3 Bin 630) are equal to the sum of the current non-methane hydrocarbon (NMHC) and NO<sub>x</sub> standards levels that took full effect in 2009, as well as to equivalent LEV standards in California's LEV II program. These bins are intended as carryover bins. That is, we expect them to be populated with vehicles that are designed to meet the current standards, and that are being phased out as new lower-emitting vehicle designs phase in to satisfy the Tier 3 fleet average NMOG+NO<sub>x</sub> standard. We also consider the next highest bins (Class 2b Bin 340 and Class 3 Bin 570) to be carryover bins, because they likewise can be readily achieved by vehicles designed for today's EPA and California LEV II emissions programs. As the 2018-2022 phase-in progresses, it will become increasingly difficult to produce vehicles in these bins and still meet the fleet average standard. Therefore vehicles in these bins (as well as some others not yet designed to meet Tier 3 PM standards described in Section IV.B.2.d) will be considered "interim Tier 3" vehicles, and the bins themselves will be considered "interim bins."

To facilitate their use in this carryover function, the interim bins do not require manufacturers to meet Tier 3 exhaust emissions standards on the SFTP, over

the longer useful life, or with the new gasoline test fuel discussed in Section IV.F, although testing on this fuel will be allowed. These requirements do apply in all other bins.

In the context of these relaxed requirements for the interim bins, we proposed two additional measures to help ensure these bins are focused on their function of helping manufacturers transition to the long-term Tier 3 emissions levels. First, we proposed that the interim bins would be available only in the phase-in years of the program; that is, through model year (MY) 2021, as is appropriate to their interim status. Second, vehicles in the interim bins would meet separate NMOG and NO<sub>x</sub> standards rather than combined NMOG+NO<sub>x</sub> standards. The goal was to ensure that a manufacturer does not redesign or recalibrate a vehicle model under combined NMOG+NO<sub>x</sub> Tier 3 standards for such purposes as reducing fuel consumption, through means that result in higher NO<sub>x</sub> or NMOG emissions than exhibited by today's vehicles, contrary to the intended carryover function of the interim bins. Industry commenters objected to both the proposed sunset of the interim bins and the proposed separate NO<sub>x</sub> and NMOG standards, arguing that they overly restrict manufacturer flexibility and work against harmonization with LEV III. However, commenters did not address EPA's concern regarding

increased NO<sub>x</sub> emissions at the interim bin levels.

After considering the comments, we believe a modified approach to the interim bins can at least partly address the industry concerns regarding harmonization while still precluding backsliding on NO<sub>x</sub> levels. We are finalizing the interim bins with combined NMOG+NO<sub>x</sub> standards as requested by the commenters, but are adopting a restriction on deterioration-adjusted NO<sub>x</sub> levels in certification testing, to the levels allowed under the current standards in 40 CFR 86.1816-08. These are 0.2 and 0.4 g/mi for Class 2b and Class 3, respectively. This restriction will not apply to vehicles in use, and does not impose a parallel NMOG restriction. Given our continuing concerns about NO<sub>x</sub> increases that would be allowed by the combined standards at the interim bin levels, we believe that this approach and the associated certification burden are reasonable, noting that manufacturers already must obtain NO<sub>x</sub> test results in certifying to an NMOG+NO<sub>x</sub> standard, and the differing NO<sub>x</sub> and NMOG deterioration mechanisms will likely dictate that they be considered separately in obtaining deteriorated NMOG+NO<sub>x</sub> levels for certification.

We believe that making the interim bins available indefinitely would run counter to their limited purpose as an aid to making the transition to Tier 3

emissions levels. Making these bins permanent would, we believe, necessitate that they take on other key elements of the Tier 3 program such as longer useful life, SFTP compliance, and the use of Tier 3 test fuel. These requirements in turn would negate the usefulness of these bins in helping to carry over some pre-Tier 3 vehicle designs during the transition years in which the declining fleet average standard levels are high enough to accommodate their continued sale. By MY 2022, the fleetwide standard will be stringent enough to effectively eliminate the ability of manufacturers to use interim bins while meeting the declining fleet average standard levels. We are therefore adopting the sunset of the interim bins as proposed, making them available only through MY 2021.

b. Fleet Average NMOG+NO<sub>x</sub> Standards

As in the light-duty Tier 3 program, a key element of the program we are finalizing for HDVs is a fleet average NMOG+NO<sub>x</sub> standard that becomes more stringent in successive model years: in the case of HDVs, from 2018 to 2022. Each HDV sold by a manufacturer in each model year contributes to this fleet average based on the mg/mi NMOG+NO<sub>x</sub> level of the bin declared for it by the manufacturer. Manufacturers may also earn or use credits for fleet average NMOG+NO<sub>x</sub>

levels below or above the standard in any model year, as described in Section IV.B.4. As proposed, we are adopting the separate Class 2b and Class 3 fleet average standards shown in Table IV–14, though a manufacturer can effectively average the two fleet classes using credits (see Section IV.B.4). We believe this split-curve approach is superior to a single phase-in covering all HDVs because it recognizes the different Class 2b/Class 3 fleet mixes among manufacturers and the differing challenge in meeting mg/mi standards for Class 3 vehicles compared to Class 2b vehicles, while still allowing for a corporate compliance strategy based on a combined HDV fleet through the use of credits.

We are adopting the proposed fleet average NMOG+NO<sub>x</sub> standards. These are consistent with those set for the LEV III MDV program in model years 2018 and later. As proposed, we are also adopting provisions allowing manufacturers to voluntarily meet bin and fleet average standards in model years 2016 and 2017 that are consistent with the MDV LEV III standards in those years, for the purpose of generating credits that can be used later or traded to others. These voluntary standards are shown in Table IV–14. This voluntary opt-in program serves the important purpose of furthering consistency

between the federal and California programs, such that manufacturers who wish to can produce a single vehicle fleet for sale nationwide, with the opportunity for reciprocal certification in affected model years. It further incentivizes pulling ahead of Tier 3 technologies, with resulting environmental benefits, by providing for early compliance credits in this nationwide fleet. Commenters expressed support for this harmonized array of HDV emissions standards.

Manufacturers choosing to opt into this early compliance program could start in either model year 2016 or 2017. They would have to meet the full complement of applicable bin standards and requirements for the bins they choose for their vehicles in meeting the 2016/2017 MY fleet average FTP NMOG+NO<sub>x</sub> standards, including SFTP standards in the bins that have SFTP standards. However, they do not need to meet the Tier 3 PM FTP and SFTP standards discussed in Sections IV.B.2.d and IV.B.3.a, or the evaporative emissions standards discussed in Section IV.C, because these requirements phase in on a later schedule. We are not extending the voluntary compliance opportunity to the 2015 model year, based on manufacturer comments indicating it would be of little value.

TABLE IV–14—HDV FLEET AVERAGE NMOG+NO<sub>x</sub> STANDARDS [mg/mi]

Model Year .....	Voluntary		Required program				
	2016	2017	2018	2019	2020	2021	2022 and later.
Class 2b .....	333	310	278	253	228	203	178.
Class 3 .....	548	508	451	400	349	298	247.

We believe that the voluntary program provisions will benefit the environment, the regulated industry, and vehicle purchasers, because it has potential to accomplish early emissions reductions while maintaining the goal of a cost-effective, nationwide vehicle program in every model year going forward.

Although manufacturers will be allowed to meet the fleet average NMOG+NO<sub>x</sub> standard through whatever combination of bin-specific vehicles they choose, it is instructive to note that the fully phased in fleet average standard for model years 2022 and later will be the equivalent of a Class 2b fleet mix of 90 percent Bin 170 and 10 percent Bin 250 vehicles, and a Class 3 fleet mix of 90 percent Bin 230 and 10 percent Bin 400 vehicles. Therefore, it is appropriate to consider Bin 170 Class 2b vehicles and Bin 230 Class 3 vehicles to

be representative of Tier 3-compliant HDVs in the long term.

c. Alternative NMOG+NO<sub>x</sub> Phase-In

We believe the fleet average phase-in described above will be flexible, effective, and highly compatible with manufacturers’ desire to market vehicles nationwide, because of its close alignment with California’s LEV III program for medium-duty vehicles. However, for any HDV manufacturers seeking four years of lead time and three years of stability as specified in Clean Air Act section 202(a)(3)(C), we proposed an alternative compliance path.<sup>340</sup> This alternative approach was

<sup>340</sup> For vehicles above 6,000 lbs GVWR, Clean Air Act section 202(a)(3)(C) requires EPA to provide manufacturers with a minimum of 4 years of lead time before mandatory changes to any standard applicable to hydrocarbon, NO<sub>x</sub>, carbon monoxide,

crafted to be equivalent to the NMOG+NO<sub>x</sub> declining fleet average in the above-described LEV III-harmonized alternative in every model year, except that the period for the voluntary program in the alternative approach would extend an extra model year—through 2018. To ensure that this approach meets the Act’s stability requirement, instead of being structured around an annually declining fleet average standard, the alternative approach requires a manufacturer to demonstrate compliance (including through use of credits) with a schedule of annually increasing percent-of-sales of HDVs certified to the fully phased in 178 mg/mi (Class 2b) and 247 mg/mi (Class 3) standards, as shown in Table

or PM can be implemented, and 3 years of stability between changes to any such standard.

IV–15. We are adopting the alternative proposed, with limited changes  
percent-of-sales phase-in largely as described below.

TABLE IV–15—PERCENT-OF-SALES ALTERNATIVE NMOG+NO<sub>x</sub> PHASE-IN

	Voluntary			Required program			
	2016	2017	2018	<sup>a</sup> 2019	2020	2021	2022 and later.
Model Year .....	2016	2017	2018	<sup>a</sup> 2019	2020	2021	2022 and later.
Class 2b .....	29%	39%	54%	65%	77%	88%	100%.
Class 3 .....	21%	32%	47%	60%	73%	87%	100%.

<sup>a</sup> Special provisions apply to models with an early-starting 2019 model year.

The availability of emissions averaging under our alternative phase-in, discussed below, makes the two alternatives functionally equivalent, not just in the annual emissions reductions they achieve, but also in how manufacturers may design their mix of products to meet the phase-in standards. Commenters who disagreed with this assessment for HDVs did not provide their reasoning, beyond referring to similar comments they had on the parallel light-duty (above 6000 lbs GVWR) alternative phase-in. However, that proposed alternative differs from the one we proposed for HDVs, and the elements in it that were found objectionable by the manufacturers are not in the HDV alternative. (See Section IV.A.3 for discussion of comments on the light-duty alternative.)

Commenters objected that the proposed percent-of-sales alternative has not been shown by EPA to be feasible, or in fact is infeasible because it mandates the early phase-in of low-emitting vehicles certified to the final standards. Such comments miss the fact that, with ABT, every manufacturer can produce the same mix of vehicles in any model year to comply with either HDV phase-in alternative, with the exception that MY 2018 is a voluntary phase-in year under the alternative phase-in and a required year under the LEV III-harmonized phase-in. The ABT provisions enable a manufacturer to adopt a fleet average compliance strategy while utilizing the percent-of-sales phase-in that is identical to what would be required under the LEV III-harmonized phase-in's fleet average standards. By no means are manufacturers forced to make only vehicles certified to the final standards. The percent-of-sales phase-in is thereby no more stringent than the LEV III-harmonized phase-in, and the feasibility analysis provided in Section IV.B.5, which expressly addresses the LEV III-harmonized phase-in, serves to demonstrate the feasibility of both alternatives.

Some comments seem to assert that the percent-of-sales framework for the alternative was chosen by EPA to make

this alternative so stringent (by requiring some vehicles to meet final standards four years early) that no reasonable company would use it. This is incorrect, both in regard to its actual effect (which as explained above is not more stringent), and in regard to our intent. The percent-of-sales framework for the alternative was proposed and is being adopted for the purpose of providing manufacturers with a phase-in alternative that explicitly meets the applicable Clean Air Act stability requirement.

We are making one change to the percent-of-sales alternative, necessitated by the fact that this final rule is being signed in 2014, not 2013 as envisioned in the proposal. HDV models for which the 2019 model year begins before the fourth anniversary of the signature date of this final rule may be excluded from the Tier 3 fleet average compliance calculations and all other Tier 3 requirements. These excluded vehicles would instead need to comply with the applicable pre-Tier 3 standards and requirements for the entire production of these models throughout the 2019 MY. This limited allowance ensures that the alternative meets EPA's obligation for four years of lead time under the Clean Air Act. It is similar to a phase-in alternative we provided in the light-duty vehicle Tier 2 rule (see 65 FR 6747, February 10, 2000). Note that 40 CFR 86.1803–01 defines “model year” as “the manufacturer's annual production period (as determined by the Administrator) which includes January 1 of such calendar year: Provided that if the manufacturer has no annual production period, the term ‘model year’ shall mean the calendar year.” Additional regulations pertaining to the definition of a model year are in 40 CFR 85, subpart X.

This allowance remains optional within the percent-of-sales alternative—a manufacturer may voluntarily include these early-starting 2019 MY vehicles in the Tier 3 program, and in this case these vehicles would be treated no differently under the alternative than vehicles with a later-starting 2019 MY, including with regard to whether

manufacturers choose to make them part of the “phase-in” fleet (vehicles counting toward the phase-in percentages) or the “phase-out” fleet (vehicles not counting toward the phase-in percentages).

Although it is conceivable that manufacturers would commence an early start of the 2019 model year specifically for the purpose of delaying Tier 3 obligations, we do not think this is likely, given the many important constraints and decisions that typically factor into setting this date, and the fact that signature of this final rule is occurring relatively early in the calendar year, well before typical model year start dates. We believe this is a reasonable way to provide a viable percent-of-sales phase-in alternative that has four years of lead time without making the 2019 model year voluntary for all vehicles or putting new constraints on the timing of a manufacturer's model year.

To help ensure that the percent-of-sales alternative is fully equivalent to the LEV III-harmonized alternative in terms of fleet-wide emissions control and technology mix choices, we are including some additional provisions, as proposed. First, the Tier 3 vehicles being phased in under the percent-of-sales alternative, in addition to meeting the fully phased-in FTP NMOG+NO<sub>x</sub> standards, must also meet all other FTP and (as described below) SFTP standards required by the LEV III-harmonized alternative. These include the CO and formaldehyde FTP standards, the 150,000 mile (15 year) useful life requirement, exhaust emissions testing with the new test fuel for gasoline- and ethanol-fueled vehicles discussed in Section IV.F, and the NMOG+NO<sub>x</sub> and CO SFTP standards in Table IV–16. The specific standards are those for the bins in these tables closest to the fully phased-in NMOG+NO<sub>x</sub> standards: Bin 170 for Class 2b and Bin 230 for Class 3. (The PM and evaporative emissions standards phase in on separate schedules under both alternatives, as discussed in Sections IV.B.2.d and IV.C.)

Second, we are making an ABT program available for the percent-of-sales alternative, structured like the one created for the LEV III-harmonized alternative. This involves certifying the vehicles in a manufacturer's HDV fleet to the bin standards, and demonstrating compliance with the fleet average standards for the LEV III-harmonized alternative in each model year, including through the use of ABT credits as in the LEV III-harmonized alternative. We are using the fleet average calculation method for purposes of ABT because, as explained above, we have determined that making this demonstration is equivalent to demonstrating compliance with the percent-of-sales requirement, and we see no value in complicating the program with another set of calculations.

However, we are establishing one difference between the LEV III-harmonized and percent-of-sales alternatives with respect to ABT provisions. Unlike in the LEV III-harmonized alternative, manufacturers will not have to certify all vehicles into bins in order to take advantage of the ABT provisions under the percent-of-sales alternative. Rather they could choose to certify any "phase-out" vehicles (that is, those not counting toward the percent-of-sales phase-in) to the pre-Tier 3 NMHC and NO<sub>x</sub> standards, provided these vehicles do not have family emission limits (FELs) above those standards. These non-Tier 3 vehicles will not be subject to the Tier 3 standards or other vehicle-specific elements of the Tier 3 compliance program. There were no comments on these specific compliance and ABT provisions associated with the percent-of-sales alternative.

#### d. Phase-In of PM Standards

Consistent with the light-duty Tier 3 program discussed in Section IV.A, we are phasing in the PM standards for HDVs as an increasing percentage of a manufacturer's production of chassis-certified HDVs (combined Class 2b and 3) per year. In addition to concerns regarding the availability and required upgrades of test facilities used for both light-duty and heavy-duty vehicle testing, manufacturers have expressed uncertainty about PM emissions with new engine and emissions control technologies entering the market as a result of new greenhouse gas (GHG) standards. Therefore we are adopting the same phase-in schedule as for the light-duty sector in model years 2018–2019–2020–2021: 20–40–70–100 percent, respectively. This will apply to HDVs certified under either

NMOG+NO<sub>x</sub> phase-in alternative. The California Air Resources Board (CARB) is phasing in the LEV III PM standards for HDVs on the same schedule, except that LEV III will also involve a 10 percent PM phase-in in the 2017 model year. We asked for comment on our adding this to our voluntary program for 2017, but received no comments on it and are not including it in the Tier 3 program.

For manufacturers choosing the declining fleet average NMOG+NO<sub>x</sub> compliance path, the PM phase-in requirement for HDVs will be completely independent of the NMOG+NO<sub>x</sub> phase-in, with no requirement that both phase-ins be met on the same vehicles. As a result, vehicles certified to any of the bin standards for NMOG+NO<sub>x</sub> need not necessarily meet Tier 3 PM standards before the 2021 model year. Instead, the current 0.02 g/mi PM standard will apply for those vehicles not yet phased into the Tier 3 PM standards. We are requiring that manufacturers choosing the percent-of-sales phase-in alternative for NMOG+NO<sub>x</sub> meet the PM phase-in requirements with only those vehicles certified to the Tier 3 NMOG+NO<sub>x</sub> standard, except in the 2019 and earlier model years when the standards, including the PM standards, are voluntary, and in the 2021 model year when the 100 percent PM phase-in requirement exceeds the 87–88 percent NMOG+NO<sub>x</sub> phase-in requirement. This is appropriate given the ability of manufacturers to build "phase-out" vehicles (those not counting toward the phase-in percentages) under the percent-of-sales NMOG+NO<sub>x</sub> alternative that are certified entirely to pre-Tier 3 standards while still participating in the Tier 3 ABT program, discussed above.

We will consider any vehicle under either compliance path that is not certified to Tier 3 standards for PM and NMOG+NO<sub>x</sub> (as well as the other, concomitant Tier 3 standards and requirements such as the extended useful life), an "interim Tier 3" vehicle. This term also applies to vehicles certified in one of the interim bins, as discussed above.

Note that compliance with Tier 3 evaporative emissions requirements follows a separate phase-in schedule as described in Section IV.C. As a result, a vehicle in an exhaust emissions family that the manufacturer has phased in to the new useful life and test fuel requirements may be in an evaporative emissions family that has not yet phased in the Tier 3 useful life and test fuel for evaporative emissions compliance and testing.

#### i. Optional PM Phase-In

The percent-of-sales phase-in schedule for the PM standard, described above, will allow manufacturers with multiple vehicle models to determine and plan the phase-in of those models based on anticipated sales volumes of each model. However, manufacturers certifying only a few vehicle models may not be able to take meaningful advantage of this schedule. This is because their limited number of models may force them to over-comply to reach the required minimum percentages, compared to a manufacturer with many vehicle models available from which to choose a phase-in pathway.

For instance, a manufacturer with only two models that each equally account for 50 percent of its sales would be required to introduce (at least) one of the models in MY 2018 to meet the phase-in requirement of 20 percent in the first year. At the 50 percent level, this model would then also meet the requirements for MY 2019 (40 percent). To meet the MY 2020 requirement of 70 percent of sales, however, the manufacturer would need to introduce the second Tier 3 vehicle that year. Thus the manufacturer would have introduced 100 percent of its Tier 3 models one year earlier compared to a manufacturer that was able to delay the final 30 percent of its fleet until MY 2021 by distributing its redesign of models over the entire phase-in period.

To provide for more equal application of this benefit among all manufacturers in the early years of the program, we are adopting the proposed optional "indexed" phase-in schedule that could be used by a manufacturer to meet the phase-in requirements. A manufacturer that exceeds the phase-in requirements in any given year will be allowed to, in effect, offset some of the phase-in requirements in a later model year. The optional phase-in schedule will be acceptable if it passes a mathematical test. The mathematical test is designed to provide manufacturers a benefit from certifying to the standards at higher volumes than they are obligated to under the normal phase-in schedule, while ensuring that the overall population of complying vehicles at the end of the phase-in is roughly the same as under the fixed percentage approach. In this alternative approach, manufacturers will weight Tier 3 PM-compliant vehicles in the earlier years by multiplying their percent phase-in by the number of years prior to MY 2022 (that is, the second year of the 100 percent phase-in requirement).

The mathematical equation for applying the optional phase-in is as follows:

$$(4 \times \text{APP2018}) + (3 \times \text{APP2019}) + (2 \times \text{APP2020}) + (1 \times \text{APP2021}) \geq 440,$$

where APP is the actual phase-in percentage for the referenced model year. The sum of the calculation will need to be greater than or equal to 440, which is the result when the optional phase-in equation is applied to the primary percent phase-in schedule ( $4 \times 20\% + 3 \times 40\% + 2 \times 70\% + 1 \times 100\% = 440$ ). Commenters supported this optional PM phase-in approach.

3. Supplemental FTP Standards for HDVs

Unlike passenger cars and light trucks, HDVs are not currently subject to SFTP standards. SFTP standards are

intended to ensure vehicles have robust emissions control over a wide range of real-world driving patterns not well-covered by the FTP drive cycle. Even though HDVs are not typically driven in the same way as passenger cars and LDTs, especially as they frequently carry or tow heavy loads, we believe some substantial portion of real world heavy-duty pickup and van driving is not well-represented on the FTP cycle.

The goal in setting the SFTP standards levels is not to force manufacturers to add expensive new control hardware for off-FTP cycle conditions, but rather to ensure a robust overall control program that precludes high off-FTP cycle emissions by having vehicle designers consider them in their choice of compliance strategies. High off-FTP cycle emissions, even if encountered relatively infrequently in

real-world driving, could create a substantial inadequacy in the Tier 3 program, which aims to achieve very low overall emissions in use. The SFTP provisions will also help make the HDV program more consistent with the heavy-duty engine program, which for several years has included “not-to-exceed” provisions to control off-cycle emissions. Therefore, in addition to the SFTP provisions, we are further limiting enrichment on spark ignition engines in all areas of operation unless absolutely necessary.

a. SFTP NMOG+NO<sub>x</sub>, PM and CO Standards

The SFTP standards levels are provided in Table IV–16. These are consistent with those adopted in the LEV III program.

TABLE IV–16—SFTP STANDARDS FOR HDVS

Vehicles in FTP bins	NMOG+NO <sub>x</sub> (mg/mi)	PM (mg/mi)	CO (g/mi)
<b>Class 2b with hp/GVWR ≤ 0.024 hp/lb<sup>a</sup></b>			
FTP Bins 200, 250 .....	550	7	22.0
FTP Bins 150, 170 .....	350	7	12.0
<b>Class 2b</b>			
FTP Bins 200, 250 .....	800	10	22.0
FTP Bins 150, 170 .....	450	10	12.0
<b>Class 3</b>			
FTP Bins 270, 400 .....	550	7	6.0
FTP Bins 200, 230 .....	350	7	4.0

<sup>a</sup> These standards apply for vehicles optionally tested using emissions from only the highway portion of the US06 cycle.

We are linking Tier 3 SFTP implementation for HDVs directly to the Tier 3 FTP phase-in and bins for these vehicles. That is, an HDV certified to any of the Tier 3 FTP bin standards must meet the SFTP standards for that bin as well. However, because the FTP PM standard phases in on a separate schedule, we will require that SFTP PM compliance be linked to the same schedule. That is, an HDV certified to the Tier 3 FTP PM standard must meet the applicable SFTP PM standard as well. This approach recognizes the complementary nature of FTP and SFTP provisions and helps to ensure that Tier 3 emissions controls are robust in real world driving. CARB expressed support in its written comments for this approach to linking FTP and SFTP requirements and an intent to propose aligning LEV III with it once the Tier 3 program is finalized.

There are no SFTP requirements for the interim Tier 3 bins in each class

(Class 2b Bins 340 and 395 and Class 3 Bins 570 and 630), because these are essentially carry-over bins from the previous standards to help facilitate the transition to Tier 3, and therefore are not intended to take on new requirements that might prompt a redesign. These implementation provisions are consistent with the approach taken in the LEV III program, except that California applies more of the Tier 3 requirements for SFTP and extended useful life to vehicles in the interim bins.

To help ensure a robust SFTP program that achieves good control over a wide range of real world conditions, we proposed to use a weighted-average composite SFTP cycle, with NMOG+NO<sub>x</sub> emissions calculated from results of testing over three cycles: the US06, the FTP, and the SC03, weighting these results by 0.28, 0.35, and 0.37, respectively. However, at proposal, we determined that the full US06

component of the composite cycle, along with the ALVW loaded test condition, would not be sufficiently representative of real-world driving for two groups of HDVs: Those with low power-to-weight ratios and Class 3 vehicles.

Therefore, as discussed in the proposal, SFTP testing of Class 2b vehicles with power-to-weight ratios at or below 0.024 hp/lb, may, at the manufacturer’s option replace the full US06 component of the composite SFTP emissions with the test results from only the second of the three emissions sampling bags in the US06 test, generally referred to as the “highway” portion of the US06. HDVs so tested will be subject to the correspondingly lower SFTP standards levels shown in the table above. These vehicles will be driven during the test in the same way as the higher power-to-weight Class 2b vehicles (over the full US06 cycle), using best effort (maximum power) if



the vehicle cannot maintain the driving schedule. The large majority of Class 2b vehicles—those with power-to-weight above 0.024 hp/lb—will be required to include emissions over the full US06 cycle in the composite SFTP. We believe that this approach provides a robust but repeatable and reliable test for the full range of Class 2b vehicles, as the highway portion of the US06 retains broad coverage of vehicle speed/acceleration combinations measured in real-world driving. Any testing conducted by EPA would follow the manufacturer's test path for the vehicle.

For Class 3 vehicles, which range up to 14,000 lbs GVWR, we are also concerned that the full US06 cycle would not provide a representative drive cycle for SFTP testing. These vehicles are much larger than the light-duty vehicles that formed the basis for development of the US06 cycle, and loading them to ALVW for the SFTP test yields a very heavy test vehicle, not likely to be safely driven in the real world in a manner that is typified by this aggressive cycle. We believe that the LA-92 (or "Unified") driving cycle developed by CARB is more representative of Class 3 truck driving patterns and will produce more robust results for use in SFTP evaluations. Therefore we are adopting the proposed LA-92 cycle for use in place of the US06 component of the composite SFTP for Class 3 HDVs.

HDVs do not have SC03 emissions requirements under the current HDV standards. Manufacturers of HDVs have indicated that they expect the SC03 emissions to be consistently lower than either the US06 or the FTP emissions levels, and therefore the added SC03 testing burden may be unnecessary. We are therefore providing HDV manufacturers with the option to substitute the FTP emissions levels for the SC03 emissions results for purposes of compliance. However, we will retain the ability to determine the composite emissions using SC03 test results in confirmatory or in-use testing. We received no adverse comments on this proposed approach.

The set of composite SFTP cycles and standards we proposed and are adopting for HDVs is consistent with the MDV LEV III program. We received no adverse comments on them, except with regard to in-use testing as discussed in Section IV.B.6.a.

#### b. Enrichment Limitation for Spark-Ignition Engines

To prevent emissions from excessive enrichment in areas not fully encountered in the SFTP cycles, we proposed and are adopting limitations

in the frequency and magnitude of enrichment episodes for spark-ignition HDVs. These limitations are identical to those for light-duty vehicles. See Section IV.A.4.c for discussion of the requirements and relevant comments received.

#### 4. HDV Emissions Averaging, Banking, and Trading

This section describes how exhaust emissions credits may be earned and used. See Section V.C for similar provisions that apply for evaporative emissions. We are continuing the practice of allowing manufacturers to satisfy standards through the averaging of emissions, as well as through the banking of emissions credits for later use and the trading of credits with others.

There are a number of facets of the Tier 3 ABT program for HDVs that are different from the existing program. First, instead of separate NMHC and NO<sub>x</sub> credits, manufacturers earn combined credits, consistent with the form of the standards.

Second, manufacturers may accrue a deficit in their credit balance. Deficits incurred in a model year may be carried forward but a manufacturer will not be permitted to have a negative overall HDV credit balance in more than 3 consecutive model years. Manufacturers will have to use any new credits to offset any shortfall before those credits can be traded or banked for additional model years. Credits not used within 5 years after they are earned will be forfeited. These 5/3-year credit/deficit life provisions are consistent with our light-duty Tier 3 approach, the California LEV III program for MDVs, and EPA programs for controlling GHG emissions from light- and heavy-duty vehicles.

Third, as part of our new requirement for chassis certification of complete diesel HDVs, we are allowing the chassis-certified diesel HDVs to participate in the Tier 3 ABT program without restriction. Prior to Tier 3 they have not been allowed to earn or use ABT credits. We are not restricting or adjusting credit exchange between diesel and gasoline-fueled HDVs, consistent with our shift to combined NMOG+NO<sub>x</sub> standards that helps to ensure comparable stringency for these two engine types, and consistent also with the LEV III MDV program.

Credits earned by a chassis-certified Tier 3 HDV may be used to demonstrate compliance with NMOG+NO<sub>x</sub> standards for any other chassis-certified Tier 3 HDV, regardless of size and without adjustment. This effectively allows manufacturers to plan a comprehensive

HDV compliance strategy for their entire Class 2b and Class 3 product offering, by balancing credits so as to demonstrate compliance with the standards for both classes.

Industry commenters argued that EPA should align the HDV credit provisions with the light-duty program by allowing early Tier 3 credits to be generated in MYs 2016 and 2017, calculated relative to the highest Class 2b and Class 3 bin NMOG+NO<sub>x</sub> levels (395 and 630 mg/mi, respectively), and capped at a level proportional to the California level in MY 2018. However, these highest bin levels correspond to those of the existing HDV standards for NMHC and NO<sub>x</sub>, and are significantly higher than the MY 2016 and 2017 LEV III levels. Thus vehicles designed to just meet the LEV III standards in these years could generate a large preliminary number of credits under the industry's Tier 3 early credits proposal, credits they would not earn in LEV III, thereby potentially thwarting the harmonization of the two programs. Truncating that credit bank for each manufacturer in 2018 such that it is proportional to their LEV III balance could perhaps, with additional restrictions on trading and banking, restore a harmonized credit status in that year. However, it constitutes an unnecessarily complex and uncertain pathway to the same result as that achieved under EPA's early opt-in provisions.

Commenters requested that we provide for the conversion of pre-Tier 3 HDV credits for use in Tier 3. However, as discussed in the proposal, we are not including provisions for doing so. We believe that by providing an early Tier 3 opt-in program for HDVs, capable of generating credits for two model years before the mandatory standards take effect (even longer under the alternative percent-of-sales phase-in approach), we are giving ample opportunity for the manufacturers to accumulate early credits.

Manufacturers commented that the proposed fleet average compliance approach is incongruous with California's LEV III method based on vehicle equivalent credits (VECs). Although expressing that they have no preference for the method since the stringency is equivalent, they recommended that EPA foster harmonization by providing a compliance option based on VECs. We believe that such an option would add unnecessary complexity to the Tier 3 program, and is made even more unnecessary by the intent expressed in CARB's written comments to propose a fleet average option for LEV III that is identical to EPA's approach.

In the past we have set upper bounds, called family emission limit (FEL) caps, on how high emissions can be for credit-using vehicles, regardless of how many credits might be available. Under our Tier 3 bin structure, we believe that exhaust emission FEL caps are no longer relevant for Tier 3 HDVs, as every vehicle must meet whatever standards apply in the bin chosen for the vehicle by the manufacturer. (The bin standard becomes the effective FEL.) Indeed, because credits and deficits are calculated based on the difference between a manufacturer's fleet average emissions and the fleet average standards for a given model year, credits are not calculated for individual vehicle families at all. Thus the standard for NMOG+NO<sub>x</sub> in the highest allowable bin serves the purpose of the FEL caps in previous programs.

Consistent with our proposal, we are not creating an averaging program for the HDV SFTP program, because we believe that the bin structure and FTP-centered NMOG+NO<sub>x</sub> ABT program provide adequate flexibility for smooth program implementation, especially in light of our aim to have the FTP standards be the primary technology forcers. A separate ABT program for SFTP compliance would add substantial complexity with little benefit, and, by making it possible to demonstrate robust SFTP emissions control on a vehicle that lacks commensurate FTP control, could prove at odds with the primary goal of the supplemental test for HDVs.

5. Feasibility of HDV Standards

The feasibility assessment, discussed in more detail in Chapter 1 of the RIA, recognizes that the Tier 3 program is composed of several new requirements

for Class 2b and 3 heavy-duty vehicles, which include primarily large gasoline and diesel pick-up trucks and vans with diverse application-specific designs. These new exhaust emissions requirements include stringent NMOG+NO<sub>x</sub> and PM standards for the FTP and the SFTP, that will as a whole require new emissions control strategies and hardware in order to achieve the standards. The type of new hardware that will be required will vary depending on the specific application and emissions challenges. Additionally, gasoline and diesel vehicles will require different emissions control strategies and hardware. The level of stringency for the SFTP NMOG+NO<sub>x</sub> standards will generally only require additional precise control of the engine parameters not necessitated in the past because of the lack of SFTP requirements. Similarly, the new PM standards on both the FTP and SFTP cycles will require more precise control of engine operation on gasoline vehicles while diesels already equipped with diesel particulate filters will require minimal changes. The new PM standards may also require that manufacturers consider the durability of their engines to the 150,000 miles useful life requirement with respect to engine wear resulting in increased oil consumption and potentially higher PM emissions.

In order to assess the technical feasibility of NMOG+NO<sub>x</sub> national fleet average FTP standards of 178 mg/mi for Class 2b vehicles and 247 mg/mi for Class 3 vehicles, we conducted an analysis of certification data for the HDVs certified in the 2010 and 2011 MYs. For this final rule, we also reviewed certification records for 2012 and 2013 MY vehicles, and determined

that these primarily involve carryover engines and emission control hardware. Therefore we did not update the NPRM analysis however any new or updated certification results in the 2012 or 2013 MYs are included in the RIA chapter 1 discussion. This analysis provided a baseline for the current HDV fleet emissions performance, as well as the emissions performance specific to the Class 2b and 3 vehicles. The emissions performance of each heavy-duty vehicle class specific to gasoline and diesel is shown in Table IV–17 below. It is important to note that the emissions results are only the 4000 mile test point results and do not incorporate any deterioration which manufacturers must account for when certifying to a full useful life standard. Designs limiting the deterioration of emission control hardware are critical to meeting the emission standards at the useful life of the Tier 3 program. Deterioration factors to adjust the values to the Tier 3 useful life standard of 150,000 miles were not available. However, deterioration factors to adjust to 120,000 miles useful life, and their implications for performance at higher miles, are discussed in the RIA Chapter 1.

The analysis also reflects the importance of the combined NMOG+NO<sub>x</sub> standard approach, where diesels and gasoline HDVs can balance their combined NMOG and NO<sub>x</sub> levels. Diesel vehicles in the analysis produce very low NMHC emissions (NMOG is not reported for diesels) but higher NO<sub>x</sub> emissions, while gasoline vehicles have opposite performance. The combined standard allows manufacturers to determine the proper balance of the unique emissions challenges of a diesel or gasoline vehicle.

TABLE IV–17 2010/11 CERTIFICATION TEST RESULTS AT 4,000 MILES

		NMHC	NMOG	NO <sub>x</sub>	CO	NMOG+NO <sub>x</sub>
Gasoline .....	Class 2b .....	0.050	0.052	0.041	1.648	0.092
	Class 3 .....	0.080	0.083	0.073	2.373	0.156
						NMHC+NO <sub>x</sub>
Diesel .....	Class 2b .....	0.037	.....	0.138	0.195	0.174
	Class 3 .....	0.019	.....	0.249	0.158	0.268
Combined Class 2b .....		0.043	0.026	0.089	0.922	0.133
Combined Class 3 .....		0.050	0.041	0.161	1.265	0.212

Manufacturers typically certify their vehicles at emissions levels well below the numerical standards. This difference is referred to as “compliance margin” and is a result of manufacturers’ efforts to address all the sources of variability that could occur during the certification

or in-use testing processes and during in-use operation. These sources of variability include: Test-to-test variability, test location, build variation and manufacturing tolerances, vehicle operation (for example: Driving habits, ambient temperature, etc.), and the

deleterious effects of sulfur and other oil and fuel contaminants. To meet the NMOG+NO<sub>x</sub> standard of 178 mg/mi for Class 2b and 247 mg/mi for Class 3 vehicles and establish a compliance margin for these sources of variability, manufacturers will need to reduce their

emission levels considerably from the levels indicated in this data set, particularly for diesel vehicles.

However, as discussed above, these emission results do not include the expected emissions deterioration which will be determined by manufacturers during development and certification testing. Therefore, manufacturers will need to further reduce emissions levels in anticipation of the unavoidable emissions deterioration that will occur during the useful life of the vehicle. Further, deterioration is a function of several factors, but it is predominantly due to emissions control hardware thermal exposure (high temperatures), which is typically a significant issue on vehicles used for performing work like Class 2b and 3 vehicles.

We also expect that the 2011 heavy-duty GHG rule will present new challenges to manufacturers' emissions performance goals as vehicles begin to use new engines designed to meet the new GHG requirements.<sup>341</sup> Some of these new technologies may result in emissions challenges that are specific to certain operating conditions. For example, downsized gasoline engines will likely have improved FTP exhaust emissions but have increased challenge with the high-load SFTP requirements. Diesel-fueled vehicles may need to carefully balance engine controls which reduce GHG emissions but can increase criteria emissions (NO<sub>x</sub>).

With regard to the ability of the heavy-duty fleet to meet the PM standards for the FTP and the SFTP, we based our conclusions on some testing of current heavy-duty gasoline vehicles (HDGVs) and the PM performance of the existing light-duty fleet with similar engines. Testing of two HDGVs with the highest sales volume (Ford F250 and Chevrolet Silverado 2500), albeit not aged to full useful life, confirmed that they have similar PM emissions levels as the light-duty counterparts and therefore also meet the standards for both the Class 2b and Class 3 configurations. Data from light-duty gasoline vehicles with similar or common engines with their heavy-duty "sister" vehicle models demonstrates that these vehicles are currently meeting the Tier 3 FTP PM standards at the Tier 2 useful life mileage of 120,000 miles. Heavy-duty diesel vehicles all are equipped with DPFs and have no challenges meeting the FTP or SFTP PM standards being set for Tier 3.

The SFTP test data from the same two heavy-duty vehicles described above indicates that gasoline vehicles can achieve the standards for SFTP

NMOG+NO<sub>x</sub> and PM. Since heavy-duty vehicles are not currently required to comply with any of the SFTP requirements, manufacturers have not focused on improving the emissions performance specifically over the SFTP cycles (US06, LA-92, and SC03). Therefore, although the limited testing results had a high degree of variability, several tests met the PM standards for the high power-to-weight Class 2b vehicles. Consistent with light-duty vehicles that are demonstrating high PM on the US06 will need to control enrichment and oil consumption from engine wear. Recently manufacturers have already been implementing product changes to reduce oil consumption to address both customer satisfaction issues and to reduce cost of vehicle ownership.

Given the technologies likely to be applied to meet the HDV exhaust emissions standards, discussed below, we consider the lead time available before the standards take effect under all of the alternatives to be sufficient. HDV manufacturers are already adopting some of the complying technologies, especially for their light-duty vehicles, and these can readily be adapted for heavy-duty applications. In addition, manufacturers have already begun developing these technologies for HDVs, including diesels, in response to California's recently adopted LEV III MDV standards which begin to take effect in the 2015 model year. Finally, as described above in Sections IV.B.2, IV.B.3, and IV.B.4, our program incorporates a number of phase-in and alternative compliance provisions that will ease the transition to final standards without disrupting heavy-duty pickup and van product redesign cycles. Among these is an alternative phase-in that does not begin mandatory standards until model year 2019.

Comments we received on the proposed HDV standards did not specifically address our analysis of their technical feasibility. The Manufacturers of Emission Controls Association (MECA) outlined diesel and gasoline-engine technologies that they expect will be used to achieve the Tier 3 standards cost-effectively, generally consistent with our draft RIA. Vehicle and engine industry commenters argued that the case we made for feasibility relied too heavily on extending light-duty truck test data, supplemented by testing of only two HDVs, neither of which were fully aged or representative of future vehicles designed to meet our new GHG standards. However, commenters did not question the feasibility, durability, implementability, or effectiveness of the technologies we

identified, or their ability to achieve the proposed standards. Instead, the focus of these comments was on statutory provisions for lead time and stability, and on how relaxed standards for in-use testing and testing at high altitudes would help to implement the standards within the allotted lead time. These issues, including changes we are making in response to the comments, are addressed in Sections IV.B.2.c, IV.B.6.a, and IV.B.6.f.

#### i. Technologies Likely To Be Applied

The technologies expected to be applied to vehicles to meet the lower standards levels will address the emissions control system's ability to control emissions during cold start. Current vehicle emissions control systems depend on the time it takes for the catalyst to light-off, which is typically defined as the catalyst reaching a temperature of 250 °C. While the specific emissions challenge is somewhat different for gasoline engines than for diesel engines, achieving the necessary temperatures in the catalysts is a common challenge. In order to improve catalyst light-off, the manufacturers will likely add technologies that provide heat from combustion more readily to the catalyst or improve the catalyst efficiency at lower temperatures. These technologies could include calibration changes, thermal management, close-coupled catalysts, catalyst Platinum Group Metal (PGM) loading, and possibly secondary air injection. In some cases, where the catalyst light-off response and efficiency are not enough to address the cold start emissions, hydrocarbon adsorbers may be applied to trap hydrocarbons until such time that the catalyst is lit-off. Note that with the exception of hydrocarbon adsorbers each of these technologies addresses both NMOG and NO<sub>x</sub> performance. Key potential technologies are described in greater detail below.

- **Engine Control Calibration Changes**—These include changes to retard spark and/or adjust air/fuel mixtures such that more combustion heat is created during the cold start on gasoline engines. Diesel engines may use unique injection timing strategies or other available engine control parameters. Engine calibration changes can affect NMOG, NO<sub>x</sub> and PM emissions.

- **Thermal Management**—This technology includes all design attributes meant to conduct the combustion heat into the catalyst with minimal cooling on both gasoline and diesel engines. This includes insulating the exhaust piping between the engine and the catalyst, reducing the wetted area of the

<sup>341</sup> 76 FR 57106 (September 15, 2011).

exhaust path and/or reducing the thermal mass of the exhaust system. Close-coupling of catalysts (packaging the catalysts as close to the head of the engine as possible to mitigate the cooling effects of longer exhaust piping) can also be effective, but is more difficult to employ than in light-duty applications because of durability concerns with highly loaded operation and the potential increase in fuel consumption to protect the catalyst from high temperatures.

- Catalyst PGM Loading—Additional PGM loading in the catalyst provides a greater number of sites to catalyze emissions and addresses NMOG, NO<sub>x</sub> and PM emissions.

- Selective Catalytic Reduction Optimization—Diesel applications will continue to refine this NO<sub>x</sub> emissions control strategy through improved hardware design and implementation in vehicle applications. Additional engineering enhancements in the control of the SCR system and related processes will also help reduce emissions levels.

6. Other HDV Provisions

a. In-Use Emissions

The proposal requested comment on the need for relaxation of NMOG+NO<sub>x</sub> and PM standards for in-use vehicle testing. The LEV III program includes these on an interim basis in the more stringent bins in both FTP and SFTP testing. However, in its written comments, CARB expressed the view that the technologies required for SFTP

compliance are well-established, and that sufficient lead time is provided such that interim in-use standards for SFTP are not needed. As a result, CARB expressed an intent to propose aligning the LEV III program with the approach EPA proposed on this matter after the Tier 3 program is finalized. The manufacturers commented that relaxed interim in-use standards are needed in the HDV sector, both for FTP and SFTP standards. The reasons cited were a need to harmonize with LEV III, the scarcity of data on which to establish standards that apply over the full useful life, the extension of that useful life to 150,000 miles, the need for manufacturers to address customer concerns with new products and technologies, uncertainties that accompany the new SFTP cycles and part 1066 testing requirements (especially for PM), and the introduction of innovative technologies required to meet GHG standards in the same timeframe.

After considering the comments we have concluded that relaxed interim in-use standards are appropriate for HDVs, both for FTP and SFTP testing. We are adopting HDV in-use standards levels that are identical to those adopted for LEV III, as shown in Table IV–18. We consider these levels reasonable, in line with relaxed in-use standards adopted in past programs, and helpful toward harmonization. We are not applying interim in-use NMOG+NO<sub>x</sub> standards to the interim (two highest) bins for the FTP standards, because these bins are

intended for carry-over of existing designs, and there should be little uncertainty over their in-use emissions performance. Interim bin vehicles certified to the Tier 3 PM standards shall, however, be subject to the relaxed in-use PM standards in the same way as for HDVs in other bins. Bin 0 standards are driven by specific zero-emissions technologies for which in-use margins would not be appropriate, and so we are not setting in-use standards for Bin 0.

We are also adopting the general approach taken in LEV III of making these interim standards available during the phase-in period (model years 2016–2022) for the first two model years that a test group is newly certified to a Tier 3 NMOG+NO<sub>x</sub> or PM standard. Test groups subsequently recertified to a more stringent NMOG+NO<sub>x</sub> bin standard may begin the two year cycle over again. A test group that is first certified into a Tier 3 bin in model year 2022 or later may not take advantage of the relaxed interim in-use standards. LEV III adopted somewhat different applicability years, for the most part ending earlier, in model year 2020. However, we believe that the modest extension is appropriate to facilitate the Tier 3 phase-in. If a vehicle test group is certified into a Tier 3 bin, but not yet to the Tier 3 PM standard, the in-use standard for PM shall apply for the first two model years it is first certified to the PM standard. In order to better harmonize with LEV III, the availability of these in-use standards includes the voluntary model years.

TABLE IV–18—INTERIM IN-USE STANDARDS FOR HDVS

	FTP (mg/mi)		SFTP (mg/mi)	
	NMOG+NO <sub>x</sub>	PM	NMOG+NO <sub>x</sub>	PM
<b>Class 2b</b>				
Bin 395 (interim) .....	(a)	16	(a)	(a)
Bin 340 (interim) .....	(a)	16	(a)	(a)
Bin 250 .....	370	16	<sup>b</sup> 770/1120	<sup>b</sup> 12/15
Bin 200 .....	300	16	<sup>b</sup> 770/1120	<sup>b</sup> 12/15
Bin 170 .....	250	16	<sup>b</sup> 490/630	<sup>b</sup> 12/15
Bin 150 .....	220	16	<sup>b</sup> 490/630	<sup>b</sup> 12/15
Bin 0 .....	(a)	(a)	(a)	(a)
<b>Class 3</b>				
Bin 630 (interim) .....	(a)	20	(a)	(a)
Bin 570 (interim) .....	(a)	20	(a)	(a)
Bin 400 .....	600	20	770	12
Bin 270 .....	400	20	770	12
Bin 230 .....	340	20	490	12
Bin 200 .....	300	20	490	12
Bin 0 .....	(a)	(a)	(a)	(a)

<sup>a</sup>No relaxed interim in-use standard.

<sup>b</sup>The lower value applies to low power-to-weight vehicles optionally certified using only the highway portion of the SFTP US06.

#### b. HDV Useful Life

Currently the HDV regulatory useful life, the period of use or time during which emissions standards apply, is 120,000 miles or 11 years, whichever occurs first (40 CFR 86.1805–4). For Tier 3 vehicle criteria emissions we are extending the useful life to 150,000 miles or 15 years, whichever occurs first. This change better reflects the improvements in vehicle durability and longevity that have occurred in the several years since the 120,000 mile useful life was established, and maintains consistency with the LEV III MDV program and with our Tier 3 program for large LDTs, for which the same useful life period is being adopted.

The new useful life requirement applies to Tier 3 HDVs in all bins except those designated as interim bins, consistent with the purpose of the interim bins to provide for limited carry-over of pre-Tier 3 vehicle designs during the phase-in period. Although the percentage application in each year will therefore depend on each manufacturer's fleet binning strategy, the declining NMOG+NO<sub>x</sub> fleet average standard will ensure a robust phase-in of the new useful life requirement over the 2018–2022 model years, such that it is expected to be about 50 percent in 2018, and necessarily reaches 100 percent by 2022 when the interim bins are no longer available. For those manufacturers choosing to certify to the voluntary standards, the new useful life will apply even earlier, in model year 2016 or 2017. For manufacturers choosing the alternative percent-of-sales NMOG+NO<sub>x</sub> alternative, the new useful life requirement applies to all HDVs counted toward the phase-in requirement, resulting in a generally equivalent useful life phase-in rate to that of the LEV III-harmonized alternative.

See Section IV.F.5 for further discussion of useful life requirements with regard to GHG standards. Manufacturers may optionally retain the 120,000 mile/11 year useful life for PM on interim Tier 3 vehicles that are not phased in to the Tier 3 PM standards. We received no adverse comments on these useful life provisions.

#### c. Heavy-Duty Alternative Fuel Vehicles

As in the light-duty program, manufacturers must demonstrate heavy-duty flexible fuel vehicle (FFV) and dual-fuel vehicle compliance with both the FTP and the SFTP emissions standards when operating on both the conventional petroleum-derived fuel and the alternative fuel. Dedicated alternative fuel vehicles must

demonstrate compliance with both the FTP and SFTP emission standards while operating on the alternative fuel. For all of these vehicles, this includes the requirement to meet FTP emissions standards when conducting fuel consumption and GHG emissions testing, and also to meet the FTP and highway test requirements at high altitudes (see Sections IV.B.6.e and f). Because FFVs can operate on various combinations of their conventional and alternative fuel, the emissions requirements apply to operation at any mix of the fuels achievable in the fuel tank with commercially available fuels, including for compliance at high altitudes, even though the required demonstration of compliance is limited to the conventional and alternative fuels designated for certification testing. We received no adverse comments on these provisions.

#### d. Existing Provision To Waive HDV PM Testing

EPA's existing program includes a provision for manufacturers to waive measurement of PM emissions in non-diesel heavy-duty vehicle emissions testing. As proposed, we are eliminating this provision. We believe that the Tier 3 PM standards for these vehicles are of sufficient stringency that routine waiver of testing is not appropriate. The CARB LEV III program also reflects this view. We do not expect this change to be onerous for manufacturers, as the number of heavy-duty vehicle families is not large. We received no adverse comments on this change.

#### e. Meeting HDV Standards in Fuel Consumption and GHG Emissions Testing

As with the light-duty Tier 3 program, HDVs must meet the FTP bin standards when tested over both the city and highway test cycles. We do not believe this adds a very significant test burden as vehicle emissions are already required to be measured when these tests are run for GHG and fuel consumption determinations. Nor do we believe that this requirement is design forcing. Rather, we are creating this requirement to ensure that test vehicle calibrations are not set by manufacturers to minimize fuel consumption and GHG emissions, at the expense of causing high criteria pollutant emissions. Considering the additional work involved in measuring PM emissions and the reduced likelihood of high PM emissions on the highway test, we are not mandating that PM emissions testing be included in this requirement. We received no adverse comments on these proposed provisions.

#### f. HDV Altitude Requirements

As in the past, we intend that HDV Tier 3 standards result in emissions controls that are effective over a full range of operating altitudes. We proposed that HDVs be required to meet the FTP bin standards (but not the SFTP standards) at high altitudes, and expressed our expectation that compliance with the FTP standards would require neither the use of special hardware nor adjustment to the level of the standards.

The manufacturers argued in their comments that the reasons EPA cited in proposing relief at high altitudes for light-duty vehicles apply for HDVs as well, and requested that relaxed NMOG+NO<sub>x</sub> standards be adopted in the more stringent bins for testing of HDVs at high altitudes. Ford argued that the challenges could be even greater for HDVs because they are designed to operate at high altitudes with heavy payloads and towed trailers, and this may necessitate the locating of emissions systems farther from exhaust manifolds, thereby increasing catalyst lightoff delays.

Although we agree to a certain extent about the performance of gasoline-fueled HDVs at high altitudes and their similarity to LDVs, the comments did not alter our view that the compliance margins provided in the HDV FTP bin standards compared to what the control technologies can achieve, and the freedom manufacturers have to shift to the more stringent bins gradually as the program phases in, are adequate to account for these effects at altitude. The manufacturers provided no data to counter this view.

We note that our adoption of relaxed interim in-use standards for vehicles in these bins will be directionally helpful to address any remaining concerns by manufacturers regarding emissions at altitude (Section IV.B.6.a). This is because testing at high altitudes is often not required for certification (typically manufacturers use an engineering analysis instead), and thus the relaxed in-use standards will help to facilitate Tier 3 implementation for any HDV designs in which in-use problems at high altitudes surface in the initial model years.

#### C. Evaporative Emissions Standards

Gasoline vapor emissions from vehicle fuel systems, which are a mixture of hydrocarbon compounds, occur when a vehicle is in operation, when it is parked, and when it is being refueled. Evaporative emissions which occur daily from gasoline-powered vehicles are primarily functions of air

and fuel temperature, fuel vapor pressure, and vehicle driving. EPA first instituted evaporative emissions standards in the early 1970s to address hydrocarbon emissions when vehicles are parked after being driven. These are commonly referred to as hot soak and diurnal emissions. Over the subsequent years the test procedures have been modified and improved, the standards have been revised to be more stringent, and we have addressed emissions which arose from new fuel system designs by establishing new requirements such as running loss emission standards and test procedure provisions which address resting losses (e.g., permeation). Onboard refueling vapor recovery (ORVR) requirements for control of refueling emissions first began to phase-in for light-duty vehicles (LDVs) and light-duty trucks (LDTs) in the 1998 MY. These were later expanded to cover medium-duty passenger vehicles (MDPVs) and some heavy-duty gasoline vehicles (HDGVs).

Even though evaporative and refueling emission control systems have been in place for most of these vehicles for many years, evaporative emissions still contribute 30–40 percent of the on-road mobile source hydrocarbon inventory. The rate of these emissions in grams/day (hot soak and diurnal), grams/mile (running loss) or grams per gallon (refueling) depends on (1) the stringency of the applicable emission standards, (2) ambient and fuel temperature, (3) fuel vapor pressure, and (4) the presence/state of repair of the fuel/evaporative control system.

These fuel vapor emissions are ozone and PM precursors, and also contain air toxics such as benzene. Even though there are mature evaporative emission control programs in place, further hydrocarbon emission reductions are needed and can be achieved from further evaporative emission controls on gasoline-powered highway motor vehicles.

This section discusses the vehicle evaporative emission standards and related provisions for LDVs, LDTs, MDPVs, and HDGVs. The evaporative emissions program has six basic elements: (1) The early allowance program (MY 2015–2016), (2) the transitional program (MY 2017), (3) the Tier 3 evaporative emission phase-in program (MY 2018–2021), (4) the fully phased-in standards (MY2022+), (5) requirements for HDGVs including ORVR for the 2018MY, and (6) a leak standard and test procedure which become mandatory for Tier 3 vehicles in the 2018MY. As discussed below, we are finalizing more stringent standards that will apply for the 2- and 3-day

evaporative emissions tests, a canister bleed test procedure and emission standard, and a new certification test fuel specification.<sup>342</sup> As discussed in section IV.D, we are also adding a fuel/vapor system leak standard and test procedure for LDVs, LDTs, and MDPVs. EPA is not changing any existing light-duty running loss or refueling emission standards with the Tier 3 FRM, with the exception of the certification test fuel specification and the addition of a refueling emission controls for complete HDGVs over 10,000 lbs gross vehicle weight rating (GVWR). This section also describes phase-in flexibilities, credit and allowance programs, and other issues related to evaporative emissions control.

In this rule, the vehicle classifications, LDVs, LDTs, MDPVs, and HDGVs, remain unchanged from Tier 2 (see 40 CFR 86.1803–010). For purposes of this discussion of the Tier 3 evaporative emissions program, the vehicle standards can be further placed in four categories: (1) “zero evaporative emission” PZEV vehicles certified by CARB as part of the ZEV program, (2) vehicles certified by CARB to meet LEV III evaporative emission program requirements on CARB certification fuel (7 RVP E10) as early as 2014 MY, (3) vehicles meeting the Tier 3 evaporative emissions program requirements using the Tier 3 certification test fuel (9 RVP E10), and (4) transitional vehicles meeting existing EPA evaporative requirements on Tier 2 certification test fuel (9 RVP E0).<sup>343 344</sup> For ease of reference these four categories may be referred to as PZEV evap, LEV III evap, Tier 3 evap, and Tier 2/MSAT evap in this section.<sup>345</sup>

#### 1. Tier 3 Evaporative Emission Standards

##### a. Final Standards

The Tier 3 program for evaporative emissions builds on previous EPA requirements as well as the evaporative emissions portion of CARB’s recent LEV III rule which starts mandatory phase-in with the 2018 MY. The level of the

standards, the timing of their implementation, and related provisions are designed in great measure to allow manufacturers to design, certify, and build one control system for each evaporative/refueling family to meet CARB and EPA requirements so that these vehicles can be sold in all 50 states. Commenters supported this approach and no commenter opposed the stringency or timing of the evaporative emission standards and related test procedures. We believe the program is appropriate since it will require new more stringent evaporative emissions control technology in new vehicles and also achieve improved in-use system performance.

Section IV.C.1.a.i, which follows, describes the basic emission standard levels for LDVs, LDTs, MDPVs, and HDGVs. Section IV.C.1.a.ii, describes a new canister bleed standard and testing requirement for measuring emissions from the evaporative canister. Section IV.C.1.a.iii discusses the optional use of the CARB LEV III Option 1 evaporative emission standards during a transition period. Next, Section IV.C.1.a.iv discusses interim use of CARB PZEV zero evap data based on CARB Phase II fuel. Finally section IV.C.1.a.iv, discusses the ongoing requirement to meet running loss emission standards.

##### i. Hot Soak Plus Diurnal Standards

The Tier 3 hot soak plus diurnal emission standards are designed to bring into the broader motor vehicle fleet the “zero evap” technology used by the manufacturers in their partial zero emission vehicles (PZEVs). Manufacturers developed this “zero evap” technology as part of their response to meeting the requirements of the CARB Zero Emission Vehicle (ZEV) program. This program, which is in effect in 11 other states, allows manufacturers to meet their ZEV mandate percentages (totally or in-part) by the use of vehicles which among other characteristics have very low fuel vapor emissions.

The hot soak plus diurnal emission standards we are adopting (presented in Table IV–19) are designed to be met with technology that limits Tier 3 vehicles to essentially zero fuel vapor emissions. For the Tier 3 evaporative emissions program, we are not changing the basic 2- and 3-day evaporative emission test procedures other than the certification fuel requirements. The level of the standards primarily accommodates what is often referred to as new vehicle background hydrocarbon emissions. These emissions arise from the off-gassing of volatile hydrocarbons from plastics, rubbers, and other

<sup>342</sup> Certification fuel provisions for evaporative and refueling emissions testing for flexible fuel vehicles (FFVs) are discussed separately below.

<sup>343</sup> We adopted the most recent vehicle evaporative emission standards for LDVs, LDTs, and MDPVs in 2007 (72 FR 8428, February 26, 2007). The most recent standards for HDGVs were adopted in 2000 (66 FR 5165, January 18, 2001).

<sup>344</sup> See Section IV.F for a discussion of the final certification fuel provisions, including discussion of options for and implications of the certification test fuel having 10 percent ethanol.

<sup>345</sup> “PZEV evap” as discussed here refers only to the evaporative emission and useful life requirements of the PZEV program, not the exhaust emission requirements.

polymers found in new vehicles (e.g., new tires, interiors, seats, fuel system components, paints, and adhesives). In the field these emissions decrease over time as the vehicle ages, but this cannot necessarily be replicated in the time that manufacturers typically allocate for vehicle certification or with the techniques normally used for vehicle pre-conditioning. Provisions related to vehicle pre-conditioning before evaporative emissions certification testing are discussed further below.

In the past EPA has set relatively uniform (but not identical) evaporative emission standards for LDVs and LDTs and somewhat higher values for MDPVs and HDGVs. The Tier 3 hot soak plus diurnal emission standards follow this approach, because in general the vehicles have higher levels of non-fuel background emissions as they get larger.

As described in more detail in Section IV.C.2.d below, EPA is finalizing a program that will allow manufacturers to demonstrate compliance with the hot soak plus diurnal evaporative emission standards using averaging concepts. A manufacturer may comply by averaging within each of the four vehicle categories but for the reasons discussed below, may not rely on averaging across categories. The technical approaches to meeting the standards are discussed in Section IV.C.2.

TABLE IV-19 FINAL EVAPORATIVE EMISSION STANDARDS  
[g/test]<sup>a b c</sup>

Vehicle category/ averaging sets	Highest hot soak + diurnal level (over both 2-day and 3-day diurnal tests)
LDV, LDT1 .....	0.300
LDT2 .....	0.400
LDT3, LDT4, MDPV .....	0.500
HDGVs .....	0.600

<sup>a</sup>The standards are in grams of hydrocarbons as measured by flame ionization detector during the diurnal and hot soak emission tests in the enclosure known as the sealed housing for evaporative determination (SHED).

<sup>b</sup>Note that the standards are the same for both tests; existing standards are slightly different for the 2- and 3-day tests.

<sup>c</sup>Vehicle categories are the same as in EPA's Tier 2 final rule; see 65 FR 6698, February 10, 2000.

ii. Canister Bleed Emission Standard

In addition to more stringent hot soak plus diurnal standards, EPA is finalizing a new canister bleed emission test procedure and standard as part of the Tier 3 program. The canister bleed test procedure is described in Section IV.C.6 below. EPA is adopting the canister bleed standard because it is an important tool in moving Tier 3 evaporative emissions control toward zero fuel vapor emissions. No commenter opposed the canister bleed standard or commented on the test procedure. The new test and standard align with the California LEV III requirements and help to ensure that near-zero fuel vapor emissions are being emitted by vehicles from the fuel tank through the evaporative emission canister. Manufacturers will be required to measure diurnal emissions over the 2-day diurnal test procedure from just the fuel tank and the evaporative emission canister using Tier 3 certification fuel and comply with a 0.020 g/test standard for all LDVs, LDTs, and MDPVs and 0.030 g/test for HDGVs. The feasibility of this standard is discussed in Section IV.C.3 below. The canister bleed test and standard drives canister design elements such as total gasoline working capacity, internal architecture, and the type of carbon used. These are also key elements of canister design for the hot soak plus diurnal emission standards.

The canister bleed standard will be implemented differently than the hot soak plus diurnal standard. EPA is not applying the averaging program to this new bleed test standard as compliance is relatively straightforward and low in cost. Therefore, each evaporative/refueling emission family certified by manufacturers will need to demonstrate compliance with their respective standard. As discussed below, the canister bleed standard will not apply at

high altitude, but proportional control is expected. Since the performance of the canister is also evaluated in the hot soak plus diurnal evaporative emissions sealed housing for evaporative determination (SHED) test the canister bleed emission standard will not be included in the In-Use Verification Program of under 40 CFR 86.1845 through 1853, but it must be met in use. We will not have canister bleed specific family criteria for certification but the test will have to be completed and the standard met for each evaporative/refueling family including potentially twice if there are two canisters used. A deterioration factor will not be required, but the manufacturer must certify that the standard will be met for the full useful life. As mentioned above, the standard will have to be met in-use and could be evaluated in EPA confirmatory testing.

The canister bleed standard will have to be met using the same fuels and test procedures used for the hot soak plus diurnal standards. We will accept results on either CARB or EPA test fuels/test temperatures for the canister bleed test provided the same are used for the hot soak plus diurnal test.

iii. Hot Soak Plus Diurnal Standard With the Fuel System Rig Test

As part of its LEV III program, CARB has included an alternative set of evaporative emission standards, referred to as Option 1 standards. These are shown in Table IV-20.

TABLE IV-20 CARB—OPTION 1 EVAPORATIVE EMISSION STANDARDS

Vehicle category	Highest hot soak + diurnal level (over both 2- and 3-day diurnal tests) (g/test)		Running loss (g/mile)
	Vehicle SHED	Rig SHED	
Passenger Car .....	0.350	0.0	0.05
LDT ≤ 6,000 lbs GVWR .....	0.500	0.0	0.05
All other vehicles > 6,000 lbs GVWR .....	0.750	0.0	0.05



The Option 1 standards include evaporative emission standards (hot soak plus diurnal) that are slightly higher numerically than our final standards. Vehicles certified under this option may not use averaging in the CARB LEV III program because they basically represent the same evaporative emission standards as exist for PZEVs under CARBs ZEV program wherein averaging is not permitted. Option 1 also includes an additional SHED test of the vehicle fuel system (rig test) that pre-dates development of the canister bleed emission standard. The rig SHED test is discussed in Section IV.C.6. From a practical perspective, this test is more difficult to conduct than the bleed test discussed above and is intended to force manufacturers to demonstrate at certification that their stand alone (not in chassis) fuel/vapor control system designs have  $\leq 54$  mg fuel vapor emissions.<sup>346</sup> While one commenter was in favor of permanently including Option 1 in the EPA final rule based on what it viewed to be favorable pre-production engineering design features of the rig SHED test, EPA is including Option 1 only as interim compliance alternative for a limited period of time but not as a permanent option in the Tier 3 evaporative emission program. While we see the value to vehicle manufacturers of the rig SHED test as an engineering design and development tool, by its very nature, the rig SHED test and standard is not implementable as an enforceable standard because a fuel system cannot be removed from a vehicle and reconstructed in a SHED for testing without compromising its fundamental structural and mechanical integrity as it existed on the vehicle. We believe that the hot soak plus diurnal SHED test and standard and the canister bleed test and standard will accomplish the objective of keeping fuel vapor emissions to a minimum while doing so in an enforceable manner.

EPA believes most manufacturers will prefer to certify to the averaging based standards in Table IV–1 (similar in stringency and program construct to CARB Option 2). However, because some manufacturers may have vehicle models meeting the CARB Option 1 standards and emission requirements now or in the near future, EPA will allow compliance with the CARB Option 1 standards as an acceptable interim alternative to compliance with the Tier 3 evaporative emission standards if the model is certified by CARB to LEV III requirements before the 2017 MY. These vehicles could then be

certified using carryover provisions through the 2021 MY as part of the evaporative emissions phase-in described below. This is two model years longer than in the proposal, but this extension is reasonable given the life cycle of most fuel/vapor control systems and the goal of aligning with the LEV III program for a national program where possible.<sup>347</sup> As noted in the following sections, vehicles certified under this provision will count toward the phase-in percentage requirements and could earn allowances as discussed below, but the vehicles will not be eligible to earn or use credits for the evaporative emissions averaging program. Carryover vehicles will have to meet the EPA leak standard and the high altitude emission standard to be counted toward the sales percentage requirements for 2018 and later model years.

#### iv. Interim Carryover of PZEV Evap Data for Tier 3 Certification

To earn credits toward compliance with the CARB Zero Evaporative Emissions (ZEV) program requirements, many manufacturers have certified LDVs and LDTs to 150,000 mile useful life emission standards similar to those found in Table IV–20. These vehicles have used CARB Phase II fuel (E0) and met the rig SHED test requirement in lieu of the canister bleed standard, but otherwise have employed the same basic technology EPA expects for the LEV III and Tier 3 programs. EPA is permitting data generated from certification of these vehicles in the 2015 and 2016 MYs to be used for Tier 3 evaporative emissions purposes through the 2019 MY.

#### v. Running Loss Emission Standards

EPA has required vehicles to meet running loss emission standards since the 1996 model year. These requirements, which are specified in 40 CFR 86.134–96, apply to all gasoline-powered highway motor vehicles. EPA is not changing either the test procedures or emission standard for the running loss test. However, the change in certification test fuel will apply to testing for such standards. This is appropriate based on the rationale for implementing a certification fuel change and is necessary since the running loss test is part of the overall test sequence for the 3-day hot soak plus diurnal test. EPA does not anticipate that the change in certification test fuel will impact the stringency of the running loss test and

standards or the manufacturers' ability to comply as part of Tier 3.

#### b. High-Altitude Requirements

Prior to this rule, the most recent vehicle evaporative emission standards were adopted in 2007.<sup>348</sup> The new standards adopted in 2007 apply only to testing under low-altitude conditions.<sup>349</sup> In the 2007 rule, we decided to continue to apply the previous “Tier 2” standards for testing under high-altitude conditions. This was necessary to achieve an equivalent level of overall stringency for high-altitude testing, accounting for the various effects of altitude and lower atmospheric pressure on vapor generation rates, canister loading and purging dynamics, and other aspects of controlling evaporative emissions due primarily to lower air density and vapor concentrations at altitude. While it is important for vehicles to have effective emission controls at high altitudes, we do not want the high-altitude standards and test procedures to dictate the fundamental design of the Tier 3 evaporative emission control systems since the high altitude vehicle population is only about five percent of the national total. Therefore, we believe it is appropriate to address this goal by applying the current 2-day low altitude evaporative emission standards and requirements for high-altitude testing.<sup>350</sup> The vehicle categories for the high altitude standards in this rule are the same as for the low altitude standards. The standards are presented below in Table IV–21. This will both reduce evaporative emissions at high altitude and again create a requirement to confirm that emission controls function effectively at high altitude without forcing manufacturers to apply altitude-specific technologies. The leak standard presented in Section IV.D below will apply equally at low and high altitude testing as compliance is not dependent on air density and vapor concentrations.

<sup>348</sup> See 72 FR 8428 (February 26, 2007).

<sup>349</sup> *Low altitude conditions* means a test altitude less than 549 meters (1,800 feet). *High-altitude conditions* means a test altitude of 1,620 meters (5,315 feet) plus or minus 100 meters (328 feet) or equivalent observed barometric test conditions of 83.3 kPa (24.2 inches Hg) plus or minus 1kPa (0.30 inches Hg) See 40 CFR 86.1803–01.

<sup>350</sup> See Control of Air Pollution from New Motor Vehicles: Heavy-Duty Engine and Vehicle Standards and Highway Diesel Fuel Sulfur Control Requirements 66 FR 5002, January 18, 2001 and Control of Hazardous Air Pollutants from Mobile Sources, 72 FR 8428, February 26, 2007.

<sup>346</sup> Any value  $< 54$ mg rounds down to zero under the regulations.

<sup>347</sup> EPA is incorporating by reference the CARB Option 1 test procedures and emission standards for this interim period.

TABLE IV–21—FINAL HIGH-ALTITUDE  
EVAPORATIVE EMISSION STANDARDS  
(g/test)

Vehicle category	Highest hot soak + diurnal level (over both 2-day and 3-day tests) (g/test)
LDV, LDT1 .....	0.65
LDT2 .....	0.85
LDT3, LDT4 .....	1.15
MDPV .....	1.25
HDGVs ≤ 14,000 lbs GVWR .....	1.75
HDGVs > 14,000 lbs GVWR .....	2.3

A few additional points should be noted about our Tier 3 high altitude evaporative emissions control program. First, EPA does not expect manufacturers to produce vehicles with high-altitude only evaporative control systems. Given the nature of evaporative emission control technology, there should be emission reductions at high altitude proportional to those achieved at lower altitudes. We are not applying the canister bleed test and emission standard at high altitude, but we expect similar emission reductions to those which will occur at low altitude. These vehicles will have to meet the canister bleed emission standard at low altitude and canister bleed emission reductions at high altitude should be proportional as is the case with the low altitude hot soak plus diurnal standards. Any adjustment to meet the standard at high altitude to account for canister adsorption and desorption effects of higher altitudes would result in fundamentally the same technology with an increase in the testing burden but not necessarily more emissions control. Therefore, we believe the low-altitude canister bleed test is sufficient for achieving the level of emission control for operation in both low-altitude and high-altitude conditions. Second, for vehicles certified with FELs above or below the applicable standard for testing at low altitude, the same differential will apply to the FELs for high-altitude. For example, if an LDV was certified with an FEL of 0.400 g instead of the 0.300 g standard, the high-altitude FEL will be 0.75 g (0.65g+0.10g). This high-altitude FEL will not be used for any emission-credit calculations, but it will be used as the emission standard for compliance purposes. Third, gasoline RVP for certification test fuel will be set at 7.8 RVP with 10 percent ethanol, as specified in Section IV.F. Finally, we are finalizing a minor adjustment to the high altitude test procedures. The existing 2- and 3-day test procedures

apply equally at low and high altitude. We are keeping the same basic requirement but will allow for a downward adjustment of 5 °F in the temperatures related to the running loss test within the 3-day test cycle. Thus, the applicable ambient temperatures at § 86.134–96 (f) and (g) will be 90±5 °F instead of 95±5 °F for high altitude testing, and the entire fuel temperature profile from § 86.129–94(d) shifts down by 5 °F. EPA believes this is appropriate given the differences in atmospheric conditions at low versus high altitude and will still result in equivalent control of running loss emissions at higher altitudes. EPA requested comment on the alternative approach of keeping test temperatures the same, but omitting the 3-day test cycle for testing at high altitude. This was supported by one set of commenters, but at this time EPA does not have the data needed to drop such a fundamental test requirement.

As mentioned above, emission data from vehicles meeting the current CARB PZEV zero evap and CARB LEV III Option 1 requirements could be used to qualify that vehicle to meet the Tier 3 evaporative emission regulations for the 2017–2021 MYs. To qualify for a federal certificate, the vehicle will also have to meet the Tier 3 high altitude evaporative emission requirements. CARB does not require vehicles to meet EPA high altitude requirements, so for these vehicles we are giving the manufacturers the option to certify either by providing SHED test data or based on an engineering demonstration using data and analysis and the application of good engineering judgment. For the 2015–2017 MYs, manufacturers can use data based on either Tier 2 or Tier 3 test fuel. Beginning in the 2018 model year, for Tier 3 vehicle certification to the high altitude standard, the data must be based on Tier 3 fuel.

#### c. Useful Life

Trends indicate that vehicle lifetimes are increasing. It is important that emission control systems be designed to meet requirements while vehicles are in use. As discussed in Section IV.A.7 and IV.B.6 of this preamble, along with the new emission standards, we are finalizing a longer useful life of 150,000 miles/15 years, whichever comes first, for LDTs up to 6,000 lbs GVWR but over 3,750 lbs loaded vehicle weight (LVW) (LDT2s), all LDTs over 6,000 lbs GVWR (LDT3/4), MDPVs, and HDGVs. The longer useful life will apply to all certifications to the Tier 3 evaporative emission standards (see Table IV–19 and Table IV–20 above). For an evaporative/refueling family certified to

150,000 miles/15 year useful life for evaporative emissions this useful life will also apply to the hot soak plus diurnal, running loss, canister bleed, fuel system rig, refueling, leak, and high altitude standards. All of these standards impact the fuel and vapor control systems and it is technologically consistent to require the same useful life for these standards because they all rely on the mechanical integrity, durability, and operational performance of the same components in the evaporative emissions control system.

Due to limitations in the CAA, for LDVs and for LDTs up to 6,000 lbs GVWR and at or below 3,750 lbs LVW (LDT1s), we are keeping the current useful life of 120,000 miles/10 years unless, as described in Section IV.A.7, a manufacturer elects alternative exhaust emission requirements that are associated with 150,000 mile/15 year useful life for these vehicles. For manufacturers that select those optional standards, the useful life of 150,000 miles/15 years will apply for all Tier 3 evaporative emission requirements as listed in the previous paragraph.

During the early, transition, and phase-in program periods and until the final year of the allowed phase-in period for the Tier 3 evaporative emission program (MY 2015–2021) the differences between the exhaust and evaporative emission phase-in programs presents the possibility that in some cases a manufacturer could certify a model to the Tier 3 exhaust requirements (or CARB equivalents) but not necessarily to the Tier 3 evaporative emission requirements.<sup>351</sup> In those situations, the final rule provides that a family could have a 150,000 miles/15 years useful life for exhaust emissions but maintain the current useful life for all of the evaporative and refueling emission standards since the vehicle does not yet meet Tier 3 evaporative emission requirements. During the phase-in period, if a family is certified to the Tier 3 evaporative emission requirements but not yet certified for Tier 3 exhaust emission requirements, then the useful life could be 150,000 miles/15 years for evaporative and refueling emissions standards but the existing useful life for exhaust emissions. However, by the 2022 MY the useful life for all of these

<sup>351</sup> By the 2022 MY, all Tier 3 evaporative system emissions certifications must use Tier 3 certification test fuel and test procedures or equivalent CARB test procedures, certification and emission standards. This affects evaporative (hot soak plus diurnal), running loss, and canister bleed emission standards certification. Refueling, spit back and leak standards are only to be met using Federal certification test fuel.

requirements will be 150,000 miles/15 years for LDT2/3/4s, MDPVs, and HDGVs since by that model year all vehicles must be certified using Tier 3 certification fuel and test procedures and meet Tier 3 evaporative emission standards or CARB equivalents.<sup>352</sup>

OBD regulations call for the systems to operate effectively over the useful life of the vehicle. We are not changing that requirement, but rather want to clarify that during the early, transition, and phase-in years of the program (MY 2015–2021), all of the OBD monitoring requirements have the same useful life as that for the exhaust emission standard except for the evaporative system leak monitoring requirement which has the same as that required for the evaporative and refueling emission standards control systems.

d. What requirements must a vehicle meet to qualify as a Tier 3 vehicle for evaporative emissions?

As mentioned above, there are three different revised or new evaporative emission requirements applicable to Tier 3 vehicles. These are the hot soak plus diurnal standards, the canister bleed standard, and the leak standard. In addition the refueling, running loss, and spit back standards are unchanged but will have to be met on Tier 3 certification fuel. Compliance with these requirements is potentially complicated by the fact that the CARB ZEV and LEVIII programs will bring zero evap technology into the market place before or at the same time that Tier 3 implementation begins but with test fuel and test procedure differences. In order to qualify as a Tier 3 vehicle for

evaporative emission purposes the vehicle must meet all applicable requirements on the specified fuel. Unless otherwise specified (e.g., HDGV refueling spit back), if a vehicle does not meet all evaporative emission program requirements, including both the applicable standards and test fuel then it does not qualify as a Tier 3 vehicle for evaporative emission purposes. Table IV–22, below summarizes the requirements that vehicles in various categories must meet to qualify as a Tier 3 vehicle for evaporative emission purposes as a function of model year. The entries in the cells of the table specify the required test fuel. The table is for reference of the reader in reviewing subsequent sections of this preamble. Refer to the regulatory text for specific requirements for the various programs.

TABLE IV–22—REQUIREMENTS FOR VEHICLE TO QUALIFY FOR TIER 3 EVAPORATIVE EMISSIONS PROGRAM AND TEST FUEL REQUIREMENTS

Model year	Program/zero evap stds	HS+DI/running loss	Rig	Canister bleed	Leak (except HHDGV)*	High altitude & refueling/spit back**
<b>MY 2017 TRANSITION PROGRAM</b>						
2017 .....	Percentage—PZEV zero evap (carryover).	CA Ph. 2 .....	CA Ph. 2 .....	N/A .....	N/A .....	EPA Tier 2 or Tier 3.
2017 .....	Percentage—LEV III Opt. 1 .....	CA Ph. 3 .....	CA Ph. 3 .....	N/A .....	N/A .....	EPA Tier 3.
2017 .....	Percentage—LEV III Opt. 2 .....	CA Ph. 3 .....	N/A .....	CA Ph. 3 .....	N/A .....	EPA Tier 3.
2017 .....	Percentage—Tier 3 .....	Tier 3 .....	N/A .....	EPA Tier 3 .....	N/A .....	EPA Tier 3.
2017 .....	PZEV zero evap only (carryover).	CA Ph. 2 .....	CA Ph. 2 .....	N/A .....	N/A .....	EPA Tier 2 or Tier 3.
2017 .....	20/20—PZEV zero evap (carryover).	CA Ph. 2 .....	CA Ph. 2 .....	N/A .....	EPA Tier 3 .....	EPA Tier 2 or Tier 3.
2017 .....	20/20—LEV III Opt. 1 .....	CA Ph. 3 .....	CA Ph. 3 .....	N/A .....	EPA Tier 3 .....	EPA Tier 3.
2017 .....	20/20—LEV III Opt. 2 .....	CA Ph. 3 .....	N/A .....	CA Ph. 3 .....	EPA Tier 3 .....	EPA Tier 3.
2017 .....	20/20—Tier 3 .....	Tier 3 .....	N/A .....	EPA Tier 3 .....	EPA Tier 3 .....	EPA Tier 3.
<b>MY 2018–2021 PHASE-IN PROGRAM</b>						
2018–2019 .....	PZEV zero evap (carryover) .....	CA Ph. 2 .....	CA Ph. 2 .....	N/A .....	EPA Tier 2 or Tier 3.	EPA Tier 2 or Tier 3.
2018–2021 .....	LEV III Opt. 1 .....	CA Ph. 3 .....	CA Ph. 3 .....	N/A .....	EPA Tier 3 .....	EPA Tier 3.
2018–2021 .....	LEV III Opt. 2 .....	CA Ph. 3 .....	N/A .....	CA Ph. 3 .....	EPA Tier 3 .....	EPA Tier 3.
2018–2021 .....	Tier 3 .....	Tier 3 .....	N/A .....	EPA Tier 3 .....	EPA Tier 3 .....	EPA Tier 3.
<b>MY 2022+ FULLY PHASED-IN PROGRAM</b>						
2022+ .....	LEV III Opt. 2 .....	CA Ph. 3 .....	N/A .....	CA Ph. 3 .....	EPA Tier 3 .....	EPA Tier 3.
2022+ .....	Tier 3 .....	Tier 3 .....	N/A .....	EPA Tier 3 .....	EPA Tier 3 .....	EPA Tier 3.

\* LHDGVs are heavy-duty gasoline vehicles with a GVWR equal to or less than 14,000 lbs; HHDGVs are heavy-duty gasoline vehicles with a GVWR in excess of 14,000 lbs.

\*\* Incomplete HDGVs without ORVR may defer demonstrating compliance with the spit back requirement on Tier 3 fuel until the 2022 MY.

2. Program Structure and Implementation Flexibilities

a. Percentage Phase-In Requirements

As proposed, the final Tier 3 evaporative emission standards will be phased in over a period of six MYs

2017–2022. Manufacturers supported the proposed phase-in schedule and there were no issues raised with regard to lead time for any vehicle class. As discussed below, there will be three options for the 2017 MY. For the 2018–2019 MYs, the requirement will apply to

60 percent of a manufacturer’s nationwide sales of all LDVs, LDTs, MDPVs, and HDGVs (including vehicles sold in California and the section 177 states). This will increase to 80 percent for MYs 2020 and 2021 and by MY 2022 it will apply to 100 percent of sales in

<sup>352</sup> The only exception here will be for vehicles not meeting Tier 3 evaporative emission

requirements in the 2022 MY as a result of the use of previously earned allowances.

these four categories. Beginning in MY 2018 any vehicle included in the percentage phase-in, except vehicles that had earned allowances, will have to meet the leak standard discussed in section IV.D.

Evaporative emission requirements for the MY 2017 apply only to LDVs, LDT1s, and LDT2s as defined in 40 CFR 86.1803–01. To be consistent with the start date for Tier 3 exhaust standards, phase-in requirements will not include vehicles over 6,000 lbs GVWR until the 2018 MY. The manufacturers will have three options. The first, which we are calling the “primary” or “percentage” option, requires that a value equal to 40 percent of a manufacturer’s LDVs, LDT1s, and LDT2s sold outside of California and the states that have adopted the CARB ZEV or LEV III programs must meet the Tier 3 evaporative emission requirements on average. The 40 percent is calculated based on vehicles at or below 6,000 lbs GVWR but compliance can be based on vehicles regardless of their GVWR. The second which we are calling the “PZEV zero evap only” option, requires a manufacturer to sell all of the LDVs, LDT1s, and LDT2s certified with CARB as meeting the PZEV evaporative emission requirements (zero evap) in MY 2017 throughout all of the U.S. and not to offer for sale any non-PZEV zero evap version of those specific vehicle models/configurations in any state whose vehicles are covered by the Tier 3 evaporative emission standards. Thus, this will apply to sales in any state except for California and states that have adopted the CARB ZEV or LEV III programs under section 177 of the Clean Air Act. Under this second option, no tracking of sales or end of year compliance calculation will be required. Some manufacturers may find this option attractive, as they have more limited product offerings and find tracking of production and sales more difficult. The third option, which we are terming the 20/20 option, requires that 20 percent of a manufacturer’s LDVs, LDT1s, and LDT2s (e.g., equal to or less than 6,000 lbs GVWR) sold outside of California and the states that have adopted the CARB ZEV or LEV III programs meet the Tier 3 evaporative emission requirements on average and that this 20 percent or another 20 percent of vehicles in the three groups listed above meet the leak standard discussed in section IV.D. Each percentage requirement must be met, (i.e., there is no flexibility to permit meeting shortfalls of the hot soak plus diurnal or leak standard percentages with higher values from the leak

standard category). However, as was the case with the 40 percent option above, compliance can be based on vehicles regardless of their GVWR. The third option was supported by several commenters as a means to address 2017 MY transition issues related to phase-out of current products and phase-in of future products. EPA believes that for these vehicles the leak standard will provide emission reduction benefits comparable in magnitude to the Tier 3 evaporative emission standards. Thus, under this approach, the manufacturers’ product transition concerns can be addressed while achieving the overall evaporative emission reductions from 2017 MY vehicles. It should be noted that these vehicles must also meet the 0.020 inch evaporative system leak monitoring requirement which also takes effect in the 2017 model year.

As discussed below, beginning in the 2018 MY, to be counted toward the percentages needed to meet the Tier 3 phase-in percentages (e.g., 60% in 2018 and 2019 MYs) a Tier 3 compliant vehicle must also meet the leak standard.

At the time of certification, manufacturers will identify which families will be included in their Tier 3 evaporative emission percentage calculations (this could be families above or below the individual Tier 3 evaporative emission standards for the given class of vehicles (Table IV–19) as well as vehicles meeting CARB’s PZEV zero evap or LEV III Option 1 standards (Table IV–20) and could also include earned allowances as discussed below. The manufacturers will use projected sales information for these families plus allowances as desired and available, to show how they expect to meet the phase-in percentage requirements for the model year of interest. At the end of the model year reconciliation the manufacturers will be expected to show that the percentages were met. If the percentages are not met, the manufacturers will either use additional allowances and/or bring more vehicle families/vehicles into the calculation until the sales percentage is met. This step is being required because the initial demonstration of compliance with the fixed percentage at certification is based on projected sales. If the manufacturers did not have to demonstrate that the fixed percentages were met, the percentage would then be a goal and not a requirement and there would be no means to capture the emission reduction shortfalls. This step is unique to the evaporative emission program relative to the NMOG+NO<sub>x</sub> and PM programs because the evaporative program involves both fixed percentages and

ABT. The NMOG+NO<sub>x</sub> program involves ABT but does not involve fixed percentages and the PM program involves fixed percentages but does not involve ABT.

The additional vehicles added to meet the percentage could only be meeting the Tier 2 hot soak plus diurnal requirements. In this case, use the larger of the 2- or 3-day hot soak plus diurnal certification emission levels. Adding these vehicle families/vehicles into the calculations (discussed below) may result in a credit deficit for that model year for a given averaging set. A manufacturer could not have an unresolved deficit for more than three consecutive model years as discussed below. The deficit would have to be eliminated with positive credits not later than the ABT calculation and credit reconciliation which occurs after the fourth model year.

As discussed above for exhaust emissions, while unlikely, it is possible that a manufacturer could in its annual certification preview meeting with EPA, indicate that its technology mix is such that it will have a credit deficit when the sales percentages requirement is met. This could occur if the fleet average evaporative emission value for Tier 3 vehicles did not meet the Tier 3 hot soak plus diurnal standard for the Tier 3 vehicles in any given averaging set. Also, a manufacturer could have a deficit from a previous model. In these situations, certifying with a projected or actual deficit would require EPA approval after submission of a plan from the manufacturer which explains how it will eliminate the deficit within the model years permitted. Even if a manufacturer had projected or actual deficits for two or three consecutive model years, all accrued deficits would have to be eliminated by the reconciliation which occurs after the fourth model year. Within this plan, which would have to be submitted and approved at each annual certification preview meeting, EPA would expect to see progress toward compliance as indicated by such factors as improved emissions performance for future test groups, a substantiated trend toward a more favorable fleet technology sales mix, no backsliding in projected fleet average values, and perhaps other situation specific criteria.

Requiring a showing at the time of certification based on projected sales requires due diligence by the manufacturers and EPA, but the Tier 3 evaporative emissions program allows for fleet averaging, so a validation or “truing up” of these sales projections after the end of the model year is necessary for determining compliance

with the requirements of the standard. This is discussed in Section IV.C.2.d.iii. As discussed further below, validated sales information will also be used for earning early allowances and to show compliance with the alternative phase-in schedule approach.

For these purposes, vehicles included in the phase-in percentage could be: (1) Families which certified to PZEV zero evap or CARB LEV III Option 1 requirements in MYs 2015 and 2016, (2) families certified to meet Tier 3 evaporative emission requirements, (3) any vehicle family certified to the CARB LEV III Option 2 hot soak plus diurnal evaporative emission standards, and (4) vehicles from the early allowance program. To qualify as a Tier 3 certification for evaporative emission purposes, any new evaporative/refueling emission family certifications will have to meet the EPA Tier 3 certification requirements for both test procedure and certification test fuel for the evaporative (hot soak plus diurnal and canister bleed, running loss), refueling, and spit back emission standards. The leak standard will apply in the 2018 and later MYs to all Tier 3 vehicles except HHDGVs and those from the early allowance program. Furthermore, assuming the EPA provisions related to carryover of emissions data are met, 2015–2016 MY CARB PZEV zero evap evaporative emissions certifications could be carried

over until the end of the 2019 MY and included as compliant vehicles within the Tier 3 program if they meet the other applicable Tier 3 requirements. The same is true for CARB LEV VIII Option 1 certification, except carryover would be permitted through the 2021 MY if they meet the other Tier 3 requirements. See Table IV–4 for more detail on the program options and fuel requirements by model year.

The phase-in percentages for MYs 2017 through 2022 reflect a percentage phase-in concept applied successfully by EPA in previous rules involving evaporative and refueling emissions control. The phase-in provides an appropriate balance between the needed emission reductions and time for the manufacturers to make an orderly transition to the new technology on such a broad scale. The higher initial percentage here is appropriate because the expected evaporative emission control technology is already being used to varying degrees by 12 manufacturers on over 50 vehicle models today and is projected to gain even deeper penetration by 2017 due to the partial zero emission vehicles (PZEV) option within the CARB ZEV program.<sup>353</sup>

b. Alternative Phase-In Percentage Scheme

As part of program flexibility, we are allowing manufacturers to demonstrate compliance with the phase-in

percentage requirements of the evaporative emissions program by using a manufacturer-determined alternative phase-in percentage scheme. The alternative phase-in percentage provisions allow manufacturers to use a phase-in more consistent with product plans such as beginning with a lower percentage(s) than required under the primary phase-in during the early years or to benefit from producing and selling more than the minimum percentage of compliant vehicles early. This flexibility could also be helpful in the event that a manufacturer elects to put some vehicles on different phase-in schedules for meeting Tier 3 exhaust and evaporative emission standards. As explained further below, with some limitations, allowances could be used toward compliance with the alternative phase-in scheme values for any given model year.

This approach, which was widely supported in comments by the manufacturers, would be available beginning in the 2017 MY for all manufacturers, except for any manufacturer which used the “PZEV zero evap only” nationwide option for the 2017 MY for whom the approach would be available beginning in 2018 MY. Vehicle and fuel eligibility requirements for the program are summarized in Table IV–23. Refer to the regulatory text for specific requirements.

TABLE IV–23—VEHICLE QUALIFICATIONS FOR 2017–2022MY ALTERNATIVE PHASE-IN PERCENTAGE SCHEMES & TEST FUEL REQUIREMENTS

Model year	Program zero evap stds.	HS+DI/running loss	Rig	Canister bleed	Leak (except HHDGV)*	High altitude & refueling/ Spit back**
2017 .....	PZEV evap (carryover) .....	CA Ph. 2 .....	CA Ph. 2 .....	N/A .....	N/A .....	EPA Tier 2 or Tier 3.
2017 .....	LEV III Opt. 1 .....	CA Ph. 3 .....	CA Ph. 3 .....	N/A .....	N/A .....	EPA Tier 3.
2017 .....	LEV III Opt. 2 .....	CA Ph. 3 .....	N/A .....	CA Ph. 3 .....	N/A .....	EPA Tier 3.
2017 .....	Tier 3 .....	Tier 3 .....	N/A .....	EPA Tier 3 .....	N/A .....	EPA Tier 3.
2018–2019 .....	PZEV evap (carryover) .....	CA Ph. 2 .....	CA Ph. 2 .....	N/A .....	EPA Tier 2 or Tier 3.	EPA Tier 2 or Tier 3.
2018–2021 .....	LEV III Opt. 1 .....	CA Ph. 3 .....	CA Ph. 3 .....	N/A .....	EPA Tier 3 .....	EPA Tier 3.
2018–2022 .....	LEV III Opt. 2 .....	CA Ph. 3 .....	N/A .....	CA Ph. 3 .....	EPA Tier 3 .....	EPA Tier 3.
2018–2022 .....	Tier 3 .....	Tier 3 .....	N/A .....	EPA Tier 3 .....	EPA Tier 3 .....	EPA Tier 3.

\* LHDGVs are heavy-duty gasoline vehicles with a GVWR equal to or less than 14,000 lbs; HHDGVs are heavy-duty gasoline vehicles with a GVWR in excess of 14,000 lbs.

\*\* Incomplete HDGVs without ORVR may defer demonstrating compliance with the spit back requirement on Tier 3 fuel until the 2022 MY.

Under this approach, before the 2017 MY (2018 MY for a manufacturer which used the “PZEV zero evap only” nationwide option for the 2017 MY), a manufacturer will present a plan to EPA which demonstrates that the sum of the products of a weighting factor and the

percentages of their U.S. vehicle sales for each model year from 2017 (2018) through 2022 is greater than or equal to 1280 if the program started in the 2017 MY (or 1040 if the program started in the 2018 MY). The 1280 and 1040 numerical values are equal to the sum

of the product of the weighting factors and the percentage requirements for MY 2017 or 2018 start dates, respectively, as applicable through MY 2022. These are calculated in the following manner:  

$$[(6)(2017MY\%)+(5)(2018MY\%)+4(2019MY\%)+3(2020MY\%)]$$

<sup>353</sup> See [http://driveclean.ca.gov/searchresults\\_by\\_smog.php?smog\\_slider\\_value=9&x=12&y=12](http://driveclean.ca.gov/searchresults_by_smog.php?smog_slider_value=9&x=12&y=12), (last accessed on December 6, 2013).

+2(2021MY%)+(1)(2022MY%)]. The 2017 MY portion of the calculation would not be included if the manufacturer used the “PZEV zero evap only” nationwide option and thus started the alternative phase-in scheme in the 2018 MY. Under the regulations, EPA has the authority to question elements of the plan and to seek clarifications and potential changes as needed. EPA could disapprove the plan and potentially not allow the use of an alternative phase-in scheme for the model year of interest if the manufacturer does not present a viable explanation and rationale as to how the required numerical sum for the phase-in would be achieved.

EPA also sought comment on including the 20 percent value hot soak plus diurnal value from the 20/20 option described above for 2017 MY in this calculation. Manufacturers generally supported including the 2017 MY in the calculation but did not clearly state whether the 40 percent or 20/20 option approach or both were supported. EPA has decided to include both options for the 2017 MY in the alternative phase-in percentage scheme; 40 percent as described above or 20 percent, with the stipulation that any vehicle used to meet the 20 percent requirement in the 2017 MY would also have to meet the OBD evaporative leak monitoring requirements and the leak standard. In other words, the flexibility of using different vehicles as allowed for the 20/20 option in the primary phase-in scheme is not included in the alternative phase-in. Including this restriction avoids the complexity that would be added if two different sets of vehicles were allowed to meet the two elements of the 20/20 option for the

2017 MY, as in the primary phase-in (e.g., expanding the calculation and tracking requirements and incorporating leak standard compliance and OBD evaporative system monitoring as part of the alternative phase-in scheme). If a manufacturer’s hot soak plus diurnal value exceeded 20 percent then that larger value could be used in the alternative phase-in calculation. However, the leak standard value cannot be less than 20 percent and for the first 20 percent the hot soak plus diurnal and the leak must be on the same vehicle and that vehicle must meet the 0.020 inch OBD evaporative system leak monitoring requirement. Compliance would be calculated in the following manner: [(6)(2017MY%)+(5)(2018MY%)+(2019MY%)+3(2020MY%)+2(2021MY%)+(1)(2022MY%)]. If choosing the 20/20 option approach for MY 2017, the value to be met or exceeded in the alternative phase-in would be 1160 which is based on substituting the required phase-in percentages for MYs 2017–2022 in the equation. Under this option as above, before the 2017 MY, the manufacturer would have to submit a plan to EPA which demonstrates that the sum of the products of a weighting factor and the percentages of their U.S. vehicle sales for each model year from 2017 through 2022 is greater than or equal to 1160. A manufacturer that over complies with the targets (i.e., 1040, 1160, 1280) may not trade the excess to another manufacturer. Also, a manufacturer must include all of its affected products in program, not just specific vehicle categories or subcategories.

A manufacturer’s alternative phase-in plan must be approved by EPA prior to the start of production for a given model

year and will have to be reviewed with EPA each subsequent model year to confirm that the manufacturer’s target percentages are being met. This would be expected to occur at the annual certification preview meeting. Manufacturers not meeting their target goals must present revised plans for EPA approval to show how the target percentages and equivalent emission standards will be met. Manufacturers using the alternative phase-in percentage scheme must still show compliance with the hot soak plus diurnal standards in each year as discussed in Section IV.C.2.d.iii even if they fall short of their individual target goal percentages for a given year. EPA is not requiring that manufacturers include Tier 2 vehicles in the calculation for a given model year if they fall short of projections (e.g., if a manufacturer projects 25% in a given model year but only achieves 22%) because it will have to be made up in a subsequent year using a lower multiplier.

c. Allowance Program

We are finalizing incentives for early introduction of vehicles compliant with the Tier 3 evaporative emission regulations. Manufacturers can take advantage of these incentives prior to MY 2018 by selling vehicles that meet the Tier 3 evaporative emission regulations earlier than required or in greater numbers than required. Vehicle eligibility requirements for the allowance program are summarized in Table IV–24. Refer to the regulatory text for specific provisions.

TABLE IV–24—VEHICLE ELIGIBILITY TO EARN ALLOWANCES & TEST FUEL REQUIREMENTS

Model year & program	Vehicle category	HS+DI/running loss	Rig	Canister bleed	High altitude & refueling/spitback*
<b>EVAPORATIVE EMISSIONS</b>					
2015–2016 PZEV zero evap carry-over.	LDV, LDT .....	CA Ph. 2 .....	CA Ph. 2 .....	N/A .....	EPA Tier 2/Tier 3.
2015–2016 LEV III Option 1 .....	LDV, LDT .....	CA Ph. 3 .....	CA Ph. 3 .....	N/A .....	EPA Tier 2/Tier 3.
2015–2016 LEV III Option 2 .....	All .....	CA Ph. 3 .....	N/A .....	CA Ph. 3 .....	EPA Tier 2/Tier 3.
2015–2016 Tier 3 .....	All .....	Tier 3 .....	N/A .....	Tier 3 .....	EPA Tier 3.
2017 “PZEV evap only” carryover .....	LDT 3&4 .....	CA Ph. 2 .....	CA Ph. 2 .....	N/A .....	EPA Tier 2/Tier 3.
2017 “Percentage” option—LEV III Option 1.	LDT3 &4 MDPV, HDGV.	CA Ph. 3 .....	CA Ph. 3 .....	N/A .....	EPA Tier 3.
2017 “Percentage” option LEV III—Option 2.	LDT3/4 MDPV, HDGV.	CA Ph. 3 .....	CA Ph. 3 .....	CA Ph. 3 .....	EPA Tier 3.
2017 “Percentage” option Tier 3 .....	LDT3/4 MDPV, HDGV.	Tier 3 .....	EPA Tier 3 .....	EPA Tier 3 .....	EPA Tier 3.
2017 “20/20” and all MY alt phase-in schemes.	Not available. ....				
2018+ LDV, LDT, MDPV & HDGV .....	Not available. ....				

TABLE IV-24—VEHICLE ELIGIBILITY TO EARN ALLOWANCES & TEST FUEL REQUIREMENTS—Continued

Model year & program	Vehicle category	HS+DI/running loss	Rig	Canister bleed	High altitude & refueling/spitback*
<b>ORVR**</b>					
2015–2017 Early ORVR .....	Complete HDGV >10,000 but ≤14,000 lbs. GVWR.	.....	.....	.....	EPA Tier 2/Tier 3.
2015–2021 Early ORVR .....	Complete HDGV >14,000 lbs. GVWR.	.....	.....	.....	EPA Tier 2/Tier 3.
2015–2021 ORVR .....	Incomplete HDGV >8,500 lbs. GVWR.	.....	.....	.....	EPA Tier 2/Tier 3.

\* LHDGVs are heavy-duty gasoline vehicles with a GVWR equal to or less than 14,000 lbs; HHDGVs are heavy-duty gasoline vehicles with a GVWR in excess of 14,000 lbs. Incomplete HDGVs without ORVR may defer demonstrating compliance with the spit back requirement on Tier 3 fuel until the 2022 MY.

\*\* All ORVR certifications must use Tier 3 fuel by the 2022 model year.

As described below, manufacturers can earn “allowances” for selling any vehicle meeting the Tier 3 evaporative emission program requirements as specified in Table IV–22 earlier than required. The vehicles may be LDVs, LDTs, MDPVs, or HDGVs. Specifically, the allowance program includes the following: (1) For MYs 2015 and 2016, any LDVs and any LDTs meeting the Tier 3 evaporative emission program requirements as specified in Table IV–22 which are sold outside of California and the states that have adopted CARB’s ZEV or LEV III programs, (2) for MYs 2015–2017, any MDPV or HDGV meeting the Tier 3 evaporative emission program requirements as specified in Table IV–22 early and sold in any state, (3) for MY 2017, any LDT3/4 meeting the Tier 3 evaporative emission program requirements as specified in Table IV–22 and sold outside of California and the states that have adopted CARB’s LEV III or ZEV programs, and (4) for MYs 2015–2017, any complete or incomplete HDGV with a GVWR greater than 10,000 lbs meeting the EPA refueling emissions regulations and sold outside of California and the states that have adopted CARB’s LEV III program. EPA asked for comment on extending the ORVR requirement to all HDGVs, complete and incomplete. As discussed in section IV.C.4.b, we are extending ORVR to all complete vehicles over 14,000 lbs GVWR, but are not including incomplete vehicles over 8,500 lbs GVWR in the ORVR requirement at this time. However, we are permitting complete vehicles over 14,000 lbs GVWR and incomplete HDGVs meeting the refueling emission standard to earn allowances through the 2021 MY. Any complete or incomplete HDGV eligible to earn allowances for the model years

and areas discussed above will earn them at a 1:1 rate for refueling emissions compliance purposes and at a 2:1 rate for Tier 3 evaporative emissions purposes because the refueling emission reductions are much larger.

Furthermore, for the 2017 MY, manufacturers choosing EPA’s “percentage” option (see Section IV.C.2.a) could earn allowances for sales of LDT3s, LDT4s, MDPVs, and HDGVs that meet the CARB LEV III or Tier 3 evaporative emission standards and related requirements assuming their LDV, LDT1/2 sales meet the 40 percent requirement. Similarly, manufacturers choosing EPA’s “PZEV zero evap only” option could earn allowances in MY 2017 for LDT3/4s, MDPVs, and HDGVs that meet the “PZEV zero evap” evaporative emission standards, CARB LEV III, or EPA Tier 3 evaporative emission standards and related requirements. EPA has decided not to include allowances for the 2017MY for any manufacturer using the 20/20 option since it would involve identifying not only the vehicles exceeding the 20 percent for the Tier 3 evaporative emission requirements but also the vehicles exceeding the 20 percent for the leak standard and these may be different vehicles. For both the “percentage” and “PZEV zero evap only” options for the 2017 model year, to avoid double counting, the allowances will be earned only for those vehicles sold outside of California and the states that have adopted CARB’s LEV III/ZEV program requirements.

To qualify as a Tier 3 vehicle for evaporative emission allowance purposes the vehicle must meet the requirements summarized in Table IV–22. Manufacturers will earn one allowance for each qualifying vehicle

sold. Manufacturers can use these allowances in MY 2017 through 2022 to help demonstrate compliance with the phase-in percentage requirements and fleet average evaporative emission standards for those years. Since credits and allowances serve primarily the same purpose and allowing for splits of allowances/credits greatly complicates program implementation, the final rule provides that manufacturers can only earn allowances in MYs 2015–2016 for any LDVs and LDT1/2s meeting the Tier 3 evaporative emission regulations which are sold outside of California and the states that have adopted CARB’s ZEV or LEV III programs and for MYs 2015–2017 for any qualifying LDT3/4, MDPV, and HDGV.<sup>354</sup>

Allowances will be used in the compliance determination in the following manner. Vehicles qualifying for allowances can be used in the fleet average evaporative emission standard calculation for any year during the phase-in. This applies to the primary phase-in and alternative phase-in programs. Allowance vehicles will be entered into the compliance calculation with an emission value equivalent to the evaporative emission standard for their vehicle category from Table IV–19 even if it was certified to CARB PZEV zero evap or LEV III Option 1 standards (Table IV–20). For the percent phase-in requirement in either the primary or alternative phase-in schemes, allowance vehicles will count for one vehicle for each allowance used within their vehicle category. For the primary scheme this will be counted as one

<sup>354</sup> LDVs and LDT1/2 sold in California and states which have adopted the LEV III or ZEV programs cannot generate allowances because these programs will already require zero evap technology vehicles in those states in MYs 2015–2016.



vehicle, but for the alternative phase-in option the value will be multiplied by the weighting factor (6 for 2017, 5 for 2018, 4 for 2019, 3 for 2020, etc). Within the alternative phase-in scheme the manufacturer will be limited to using these early allowances for no more than 10 percentage points of the phase-in requirements in any given model year (e.g., MYs 2017–2022). EPA believes this limitation is appropriate since early use in the alternative phase-in scheme is multiplied and early introduction of “zero evap” technology should be encouraged, but not necessarily at the expense of its widespread use across the various vehicle categories as the phase-in progresses. The allowances are designed primarily to facilitate manufacturer transition during the program phase-in. As such, they may not be traded between manufacturers and unused allowances will expire after the 2022 MY.

An example here may be helpful in demonstrating how allowances will work. Take a hypothetical manufacturer who earned a total of 10,000 allowances in MYs 2015 and 2016 and sells 100,000 units per year. In MY 2018, the manufacturer will have a phase-in requirement of 60 percent or 60,000 vehicles. For the primary phase-in option the manufacturer could use part or all of its allowances in 2018 without restriction. For the alternative phase-in scheme assume the manufacturer set its alternative phase-in value at 60 percent for the 2018 MY. The final regulations limit the use of allowances to 10 percentage points of the 60 percent or in this case 10,000 vehicles out of 60,000. Without a multiplier this will require the use of all 10,000 allowances in 2018, but with the multiplier of 5 for MY 2018 only 2,000 allowances are needed to reach the 10 percentage point maximum. Using a similar calculus, the manufacturer could use another 10 percentage points in MY 2019, but it will require 2,500 allowances to reach this level since the multiplier is 4 assuming sales remain at 100,000 units per year. The number of allowances to reach the 10 percentage point level will increase each year as the multiplier decreases.

#### d. Evaporative Emissions Averaging, Banking, and Trading

##### i. Introduction

Throughout EPA’s programs for mobile source emission controls, we have often included emission averaging programs for exhaust emissions. An emission averaging program is an important factor we take into consideration in setting emission

standards under the Clean Air Act. An emission averaging program can reduce the cost and improve the technological feasibility of achieving standards, helping to ensure the standards achieve the greatest achievable reductions, considering cost and other relevant factors, in a time frame that is earlier than might otherwise be possible. Manufacturers gain flexibility in product planning and the opportunity for a more cost-effective introduction of product lines meeting a new standard. Emission averaging programs also create an incentive for the early introduction of new technology, which allows certain emission families to act as leaders for new technology. This can help provide valuable information to manufacturers on the technology before they apply the technology throughout their product line.

These programs generally involve averaging and banking, and sometimes trading (ABT). Averaging allows a manufacturer to certify one or more families at emission levels above the applicable emission standards as long as the increased emissions are offset by one or more families certified below the applicable standards. These are referred to as individual family emission limits (FELs). The over-complying families generate credits that are used by the under-complying families. Compliance is determined on a total mass emissions basis to account for differences in production volume, and on other factors as necessary such as useful life. The average of all emissions for a particular manufacturer’s production within a vehicle category must be at or below the level of the applicable emission standards. Banking allows a manufacturer to generate emission credits and bank them for future use in its own averaging program in later years. Trading allows a manufacturer to sell credits or obtain credits from another manufacturer.

EPA proposed and is finalizing an emissions ABT program for the Tier 3 hot soak plus diurnal evaporative emissions standards. The evaporative emissions ABT program is generally structured and operates the same as that for exhaust emissions as discussed in Section IV.A.7.m. The major difference is the added requirement to reconcile compliance with the fixed percentage requirement as discussed in detail in Section IV.C.2.a. Also, there is a five year credit life for evaporative emissions as opposed to the longer interim values for NMOG+NO<sub>x</sub> FTP and SFTP credits.

This is the EPA’s first averaging type program for evaporative emissions from light-duty or heavy-duty vehicles. It does not apply to the canister bleed

standard or the leak standard because it is the low altitude “zero evap” hot soak plus diurnal standard which will drive the fundamental approach used to comply with all of these requirements. We sought comment on the value of including trading in the program. The comments from the Alliance of Automobile Manufacturers and the Association of Global Automakers very generally supported the inclusion of trading but provided no detail. Upon follow-up from EPA no manufacturer provided any further explanation on the need for the program or how they might use it.<sup>355</sup> In past similar programs for exhaust emissions there have been only a few trades, but incorporating trading within the program adds a degree of flexibility if a manufacturer finds itself in a credit deficit situation. Thus, we have decided to include trading, but credit trades are limited based on the same averaging set restrictions as discussed below for averaging and banking.

The evaporative emissions ABT program will start with the 2017 MY for the percentage and 20/20 options. Prior to the 2017 MY and for other options as discussed in Section IV.C.2.b, manufacturers may earn allowances. The programs will continue for the 2018 MY and beyond for all manufacturers regardless of their 2017 MY option and will not sunset, as does the allowance program. Vehicles generating ABT credits in the 2017 MY or later will not be permitted to also generate allowances as this would be double counting.

A key element of an averaging program is the identification of the averaging sets. This establishes the basis within which evaporative emission families can be averaged for purposes of compliance as well as credit and deficit determinations. As proposed, we are finalizing four averaging sets and the applicable emission standard for each of the averaging sets as shown in Table IV–19. Except as noted in Section IV.C.2.d.2 below, credit exchanges between averaging sets will not be permitted. Participation in ABT is voluntary since a manufacturer could elect to certify each family within the averaging set to its individual standard as if there were no averaging program.

An evaporative emission ABT calculation and assessment involves two distinct steps. The first is the determination of the credit/deficit status of each family relative to its applicable

<sup>355</sup> See Alliance of Automobile Manufacturers and Association of Global Automakers comments on the NPRM (dated July 1, 2013) and Passavant, G. (June 2013) EPA and Auto Industry Meeting Related to Tier 3 Evap and OBD NPRM. Memorandum to the docket.

standard from Table IV–19. The second is the role of ABT calculations in the overall compliance demonstration which is discussed in Section IV.C.2.d.

#### ii. Family Emission Limits

A manufacturer choosing to participate in the evaporative emissions ABT program will certify each emission family to an FEL that applies for the hot soak plus diurnal standard for low altitude testing. The FEL selected by the manufacturer becomes the emission standard for that emission family. Emission credits (or deficits) are based on the difference between the emission standard that applies (by vehicle category) and the FEL. The vehicles will have to meet the FEL for all emission testing. As mentioned in Section IV.C.1.b., above, for vehicles certified with FELs above or below the applicable standard for testing at low altitude, the same differential will apply to the FELs for high-altitude. This high-altitude FEL will not be used for any emission-credit calculations, but it will be used as the emission standard for compliance purposes.

The final rule provides that the FELs selected by the manufacturer must be selected at 0.025 g/test increments above or below the applicable Tier 3 evaporative emission standards for each vehicle category. For example, for LDVs the increments for the FELs would be +/– 0.025 from 0.300 g/test (e.g., 0.225, 0.250, 0.275, 0.300, 0.325, 0.350, 0.375 . . . 0.500). The FEL is used in the compliance demonstration not the certified level. The certified level must be below the FEL, but the FEL could be a higher value than the closest increment value. For example, a certified value of 0.235 g/test could support an FEL of 0.250 g/test or any other higher increment value. One commenter asked that the gradation be finer than 0.025 g/test, but EPA believes this is the appropriate increment, since the standard itself is the sum of two values and rounding of the measured values is involved.

FELs are capped such that they cannot be set any higher than 0.500 g/test for LDVs, 0.650 g/test for LDT1s and LDT2s, 0.900 g/test for LDT3s and LDT4s, 1.000 g/test for MDPVs, 1.4 g/test for HDGVs at or below 14,000 lbs GVWR, and 1.9 g/test for those above 14,000 lbs GVWR, respectively. These FEL caps are the 3-day hot soak plus diurnal emission standards applicable under EPA's existing regulations. While we asked for input on these FEL caps and vehicle groupings, no party provided comment.

Total evaporative emission credits (or deficits) under the Tier 3 hot soak plus

diurnal ABT program will be calculated differently in the 2017 model year and the 2018 and later model years. For 2017 calculations will be based on sales in the U.S. excluding California and the section 177 states which have adopted the LEV III/ZEV programs. For 2018 and later model years it will be based on all 50 states. Calculations will use the following equation: Credits = (fleet average standard – fleet average FEL) × “U.S. sales”. The “fleet average standard” term here is the applicable Tier 3 hot soak plus diurnal standard for the vehicle category from Table IV–19. The sales number used in the 2018 and later MY calculation will be the number of vehicles of the evaporative emission families in that category sold in the U.S. which are subject to the Tier 3 evaporative emission standards. Emission credits banked under the evaporative emission ABT program will have a five year credit life and will not be discounted. This means the credits will maintain their full value through the fifth model year after the model year in which they are generated. At the beginning of the sixth model year after they are generated, the credits will expire and cannot be used by the manufacturer. We are limiting credit life so there is a reasonable overlap between credit generating and credit using vehicles. As mentioned above, for purposes of the compliance calculation, allowance vehicles will have an FEL equivalent to the EPA emission standard (Table IV–19) for their respective vehicle category.

#### iii. Compliance Demonstration

Demonstration of compliance with the evaporative emissions standards is done after the end of each model year. There are two steps. In the first step, as discussed above, manufacturers must show compliance with the applicable phase-in percentages from the primary phase-in scheme (i.e., 40, 60, 80, and 100), the 20/20 option for MY 2017, or an alternative phase-in percentage scheme. It is sales from these families together with their respective FELs which will be used to make the demonstration of compliance with the emission standard on average within each vehicle averaging set. Compliant vehicle types for these purposes are the same as described in Section IV.C.1.c above for projected sales. If the required sales percentages are not met by direct sales or allowances, non-Tier 3 vehicles would have to be identified to make up the shortfall in this calculation but would not be subject to the canister bleed or leak standard requirements.

In the second step, using the FELs, manufacturers calculate the sales-

weighted average emission levels within each of the four vehicle categories using sales for each family.<sup>356</sup> Manufacturers are allowed to use credits only within a defined averaging set. The averaging sets are: (1) LDVs and LDT1s, (2) LDT2s, (3) LDT3s, LDT4s, and MDPVs, and (4) HDGVs. These sales-weighted calculated values must be at or below the emission standard for that vehicle category as shown in Table IV–19, (unless credits from ABT are used). If the difference between the standard and the sales-weighted average FEL is a positive value this could generate banked credit available for future use. If the difference between the standard and the sales-weighted average FEL is a negative value this would be a credit deficit which could be covered by previously banked credits. Credit deficits will be allowed to be carried forward through negative banking. However, manufacturers are required to make up any deficits within the three subsequent model years with credits from vehicles in the same averaging set, except as described below. That is, after calculations for the fourth model year are complete, all previous deficits from the preceding model years will have to be resolved by credits generated by the manufacturer or acquired through trading from vehicles within the same averaging set. As an illustration, a credit deficit accumulated in MY 2017 would have to be eliminated not later than the time that the 2020 MY ABT calculation is submitted to EPA. In no case will a manufacturer be permitted to carry a deficit (negative credit balance) for more than three consecutive model years. Using a similar illustration, all credit deficits accumulated in MYs 2017, 2018, and 2019 would have to be eliminated not later than the time that the 2020 MY ABT calculation is submitted to EPA.

As discussed above, manufacturers are required to identify and include in the calculations for each of the four averaging sets, vehicle families from each of the vehicle categories (see Table IV–19) until the total annual nationwide sales in the given model year equals or exceeds the prescribed percentages. This could include non-Tier 3 vehicles. If the inclusion of non-Tier 3 vehicles results in an exceedance of the hot soak plus diurnal emission standard for that category of vehicles, the credit deficit would have to be made up in a subsequent model year. Credits from

<sup>356</sup> For MY 2017 calculations will be based on sales in the U.S. excluding California and the section 177 states which have adopted the LEV III/ZEV programs. For 2018 and later model years it will be based on all 50 states.

banking and trading can be used to cover deficits at any time within the appropriate averaging set.

Allowances can also be used to demonstrate compliance with the percentage phase-in requirements and the vehicle category average emission standard. For purposes of the percentage phase-in requirements, vehicles which have earned allowances are counted as compliant in the percentage calculation. For purposes of the calculations for compliance with the emission standard, allowance vehicles enter into the evaporative emissions compliance calculation as having an emission rate equivalent to the standard for that category of vehicle. Thus, allowance vehicles can help in demonstrating compliance with the percentage phase-in requirement (up to ten percentage points per model year in the alternative phase-in scheme) and can help in reducing deficits since their calculation value is equivalent to the level of the standard.

As presented in detail above, during the 2017–2021 MYs EPA is allowing manufacturers limited flexibility to meet the percentage phase-in requirements using carryover certification data from vehicles certified to CARB PZEV zero evap and CARB LEV III Option 1 standards in the 2015 or 2016 model years. These vehicles may have certification values slightly higher than those of EPA's Tier 3 program for the given vehicle and vehicle category. Since the emission standard values in Table IV–19 and Table IV–20 are very similar for any given vehicle category, for purposes of simplification during the phase in, EPA in the final rule provides that any CARB PZEV zero evap or CARB LEV III Option 1 vehicles used in the 2017–2021MYs emission standard compliance determination be entered into the calculation with the emission level equivalent to the Tier 3 vehicle category in which the vehicle model would otherwise fit. However, we are not allowing manufacturers to generate emission credits for families certified with EPA based on carryover CARB PZEV zero evap or CARB LEV III Option 1 evaporative emissions data as provided for in Table IV–20. We are not including these vehicles in the ABT program since the programs are not directly comparable, and the structure of the current CARB ZEV program, which is the genesis of most PZEV zero evap offerings, allows for a different number of PZEV sales as a function of manufacturer size and CARB LEV III Option 1 does not permit averaging.

As mentioned above, we are limiting use of credits to only within a defined averaging set. Cost effective technology

is available to meet the hot soak plus diurnal emission standards on average within each of the vehicle categories in the averaging sets, especially since the standards are designed to accommodate nonfuel hydrocarbon background emissions. Thus, further flexibility is not needed. Moreover, we are constraining averaging to within these sets because of equity issues for the manufacturers. We are concerned that in the absence of such constraints the four or five manufacturers with a wide variety of product offerings in most or all of these categories would have a competitive advantage over the majority of manufacturers which have more limited product lines. This effect could be even more pronounced if the number of evaporative families is considered, since larger more diverse manufacturers have more models and thus more evaporative families.

Nonetheless, manufacturer use of credits from different averaging sets to demonstrate compliance is permitted in limited cases. As noted above, if a manufacturer has a credit deficit at the end of a model year in a given averaging set, they will have to use credits from the same averaging set during the next three model years to make up the deficit. However, if a deficit still exists at the end of the third year (i.e., the deficit has existed for three consecutive model years), we are incorporating provisions to permit a manufacturer to use banked or traded credits from a different averaging set to cover the remaining deficit in the fourth model year's ABT calculation, with the following limitations. Manufacturers are able to use credits from the LDV and LDT1 averaging set to address remaining deficits in the LDT2 averaging set, and vice versa. Furthermore, manufacturers are permitted to use credits from the LDT3, LDT4, and MDPV averaging set to address remaining deficits in the HDGV averaging set, and vice versa. No other use of credit exchanges across different averaging sets is allowed. These restrictions are being finalized because of equity concerns caused by the different nature and size of various manufacturer product lines.

For both the percentage phase-in and sales-weighted average calculation steps above, we are basing the calculation on nationwide sales (excluding California and the section 177 states which have adopted the LEVIII/ZEV programs) in the 2017 MY since the anti-backsliding provisions of the LEV III evaporative emissions program are in place through the 2017 MY. The program uses annual nationwide sales beginning in the 2018 MY. We believe this approach is consistent with the manufacturers'

plans for 50-state vehicles. A program design which enables a nationwide program has been an important premise of this rulemaking. Furthermore, this is simpler for the manufacturers and for EPA since it relieves the need to project future model year sales or track past model year sales at a disaggregated level. We recognize that decisions by the manufacturers on a national fleet versus a bifurcated approach such as exists today (California and the section 177 states which have adopted the LEVIII/ZEV programs separate from the rest of U.S. sales) may not yet have been made. The CARB LEV III and EPA phase-in requirements are identical beginning in 2018, so EPA sees little need for concern that a nationwide-based accounting approach could lead to disproportionate state by state impacts or the encouragement of practices which would lead to any particular state or area not receiving the anticipated emission reductions with this nationwide approach to the calculation.

As discussed above, manufacturers not meeting the percentage phase-in requirements will need to include non-Tier 3 vehicles in the count and include their emissions in the overall calculation of compliance with the hot soak plus diurnal standard and resolve shortfalls in compliance with the emission standard with future reductions, earned allowances, or credits. These non-Tier 3 vehicles would not be subject to leak standard or canister bleed standard requirements. The additional vehicles could only be meeting the Tier 2 hot soak plus diurnal requirements and adding these vehicle families/vehicles into the calculation may result in a credit deficit. A manufacturer could not have an unresolved deficit for more than three model years as discussed below. The deficit would have to be eliminated with positive credits not later than the ABT calculation and credit reconciliation which occurs after the fourth model year.

Resolving this sales percentage shortfall problem becomes a bit more complicated for the 2017 MY 20/20 option because it requires that 20 percent of vehicles meet the Tier 3 evaporative emission requirements and that 20 percent meet the leak standard. These may or may not be the same vehicles. As a means to resolve this potential problem, EPA is requiring that any shortfall of either of the 20 percent values (Tier 3 evaporative or leak standard) for the 2017 MY be covered by allowances or by future sales of vehicles meeting the Tier 3 evaporative emission requirements in excess of the

evaporative emission percentage sales requirement for that MY or some combination of MYs. For example, if a manufacturer was five percentage points short of either the 20 percentage points for the hot soak plus diurnal or the 20 percentage points for the leak standard in the 2017 MY, then it will have to accelerate sales of vehicles meeting Tier 3 evaporative emission requirements in the 2018–2021 MYs to cover the 5 percentage points (e.g., 65 percent in 2018 instead of 60 percent or 63 percent in 2018 MY and 62 percent in the 2019 MY, etc.). These vehicles as Tier 3 vehicles in MY 2018 or later would also have to meet the leak standard.

#### e. Small Volume Manufacturers

As flexibility, we are establishing provisions for small volume manufacturers and for those small business manufacturers and operationally independent small volume manufacturers with average annual nationwide sales of 5,000 units or less.<sup>357</sup> These manufacturers would be permitted to delay meeting the Tier 3 evaporative emission standards, including the requirement to use EPA certification test fuel, until the 2022 MY. See pages 29892 and 29998–29999 of the preamble to the NPRM and Section IV.G.5 below for a discussion of the 5,000 vehicle threshold. This includes the hot soak plus diurnal standards, the canister bleed emission standard, and the leak standard. In the interim, these vehicles must meet the existing evaporative and refueling emission standards. The initial determination of whether a manufacturer is under the 5,000 unit threshold will be based on the three year average of actual nationwide sales for MYs 2012–2014. This allowance would not be affected if a qualifying manufacturer's nationwide sales later exceed that value before 2022. Similarly, new market entrants (not in the market in the 2012 MY) with projected sales of less than 5,000 units could be covered by the small volume manufacturer provisions. However, in this case if actual running average nationwide sales exceed 5,000 units per year in any three consecutive model years they will have to meet the Tier 3 evaporative requirements in the third model year thereafter. For example, if a new market entrant in 2015 projects nationwide production of 4,000 units per year and the average of actual values in 2015–2017 exceeds 5,000 units per year they will have to meet Tier 3

evaporative requirements by the 2020 MY.

#### 3. Technological Feasibility

Evaporative/refueling emission control systems are an integral part of the overall vehicle engine and fuel system. EPA is establishing two revised and three new standards in this rule (2-/3-day hot soak plus diurnal standards, high altitude standards canister bleed standards, fuel rig SHED standard, leak standard) and a new test fuel which applies to these standards as well as the current running loss, refueling, and spit back emission standards.

Hot soak plus diurnal emissions are fuel vapors which arise from the fuel system when it is parked immediately after operation (hot soak) and during daily ambient heating and cooling or by means of permeation when the vehicle is at rest. Control of hot soak plus diurnal emissions is primarily achieved by routing fuel vapors to a canister filled with activated carbon. These vapors are stored on the carbon and purged in the engine during vehicle operation. Hot soak plus diurnal emission rates vary with fuel vapor pressure, temperature, and fuel system design. Permeation emissions have been reduced by improving fuel tank and fuel line materials. Permeation emissions are sensitive to the gasoline ethanol content. While EPA has required ethanol in the fuel used for assessing evaporative system durability since 2004, Tier 3 is the first rule to require the certification test fuel for gasoline-fueled vehicles to include ethanol (E10).

Canister bleed emissions are fuel vapors which diffuse from the canister vent as a result of the normal redistribution of vapors within the activated carbon while the vehicle is at rest. The emission rate depends on the tank volume, its fill quantity, the size and architecture of the canister and the characteristics of the carbon itself. While the biggest effect of this vapor redistribution is a uniform vapor concentration within the canister, it can also cause vapors to escape through the canister vent even without continued canister loading resulting from fuel tank heating.

Vapor leaks in the vehicle fuel/evaporative system can arise from micro-cracks or other flaws in various fuel/evaporative system component structures or welds, problems with component installations, and more generally from connections between components and fuel lines and vapor lines. Control of leaks is especially important to achieving full useful life emission control system performance.

In Tier 3, the emissions test fuel is changing from 9 RVP E0 to 9 RVP E10. EPA does not expect the change in emissions test fuel to affect refueling, spit back, or running loss compliance technology or strategies.

While these elements of the evaporative/refueling program are separate requirements for compliance purposes, the integrated nature of the design and operation of the evaporative/refueling control systems and the vehicle engine/fuel systems often leads to co-benefits when technology is added or upgraded. In some cases technology to meet one of the new or revised evaporative emission requirements will either help in efforts to meet other evaporative type requirements or enhance durability. For example, technology used to address the canister bleed standard will also reduce hot soak plus diurnal emissions and technology to meet the leak standard will reduce hot soak plus diurnal emissions and enhance durability.

Based on review of current certification data and the documentation in current professional literature, there is no doubt that the technology is available to meet the final evaporative emission standards described in this rule.<sup>358</sup> There are at least 50 vehicle models which met the requirements in 2013.<sup>359</sup> There are many technologies manufacturers can consider which will reduce emissions and enhance durability. Manufacturer compliance options and cost considerations are also addressed by the phase-in flexibilities and as the ABT program.

In the NPRM we described a variety of technology approaches and calibrations which manufacturers could use to meet the Tier 3 evaporative emission requirements. No comments were provided on the stringency of the standards, the technologies, the feasibility of the standards, or the costs of compliance. Nonetheless, we updated our technology analysis in light of new certification data and vehicle technology projections. As in the analysis supporting the NPRM, we identified technologies on the basis of their control effectiveness and cost to implement. Not every model will use every technology described below. Rather we expect manufacturers to apply the technologies needed on any given model to meet the compliance target level. The technologies could be broadly grouped into two segments. The

<sup>358</sup> Passavant, G. (December 2013). Assessment of 2013 MY Evaporative Emission Results. Memorandum to the docket.

<sup>359</sup> See Chapter 1 of the RIA for more detail.

<sup>357</sup> See 40 CFR 86.1838–01(d).

first are those expected to see widespread use based on their effectiveness and cost to implement. The second are those which are in relatively widespread use today, but could be optimized if necessary to achieve further reductions. In many cases the reductions available from this second group are relatively small and the costs are slightly higher than for the other strategies. The anticipated control technologies to comply with the hot soak plus diurnal, canister bleed/rig, and leak standards are described briefly below and are grouped in these two basic segments. A more detailed analysis for each vehicle category is found in Chapter 1 of the Regulatory Impact Analysis (RIA).

a. Technologies expected to see widespread use: Engine/fuel system conversion: As projected in our RIA for the 2017–2025 light-duty GHG emissions final rule, EPA projects a significant movement from port fuel injection (PFI) engines to gasoline direct injection (GDI) engines. This ranges from 60–100 percent of products for all categories except gasoline-powered trucks over 14,000 lbs GVWR. This reduces air induction systems emissions by 90 percent.

Air Induction System (AIS) Scrubber: For vehicles/engine models not converted to GDI, EPA projects the use of an AIS scrubber as is now used on some PZEV models. These would reduce air induction system emissions by 85 percent.

Canister honeycomb: This is a lower gasoline working capacity activated carbon device designed to load and purge very easily and quickly. This device reduces canister bleed emissions by 90 percent but also provides control for the hot soak plus diurnal test.

Reduce leaks from connections and improve seals and o-rings: Vapor leaks from connections and the emission rates from these leaks is exacerbated if poor sealing techniques or low grade seal materials are used in connectors such as o-rings. Reducing connections in the fuel and evaporative systems and improving techniques and materials would reduce these emissions by 90 percent. This would reduce hot soak plus diurnal emissions, improve durability, and help to assure compliance with the leak standard.

Move parts into the fuel tank: Another means to reduce leak-related vapor emissions is to move fuel evaporative system parts which are external to the fuel tank to the inside. Emissions from these parts would be completely eliminated. This would reduce hot soak plus diurnal emissions, improve

durability, and help to assure compliance with the leak standard.

OBD evaporative system leak monitoring: Beginning in the 2017 model year, the OBD system will need to be able to find, confirm, and signal a leak in the evaporative system of 0.020 inches cumulative diameter or greater. This is currently done on most vehicles less than 14,000 lbs GVWR as a result of the manufacturers' response to meeting CARB requirements, but will be mandatory under EPA regulations.

b. Technologies expected to be optimized if necessary to achieve further reductions:

In the NPRM, EPA discussed a number of other technologies with the demonstrated potential to further reduce evaporative emissions. These included: (1) Upgrading the activated carbon canister and optimizing purge calibrations (especially for larger displacement engines), (2) upgrading fuel line materials to reduce permeation, (3) improving the fuel tank barrier layer to reduce permeation, (4) improving fuel tank manufacturing processes to reduce tank seam permeation emissions, (5) upgrading the fuel tank fill tube material to reduce permeation, and (6) improving the security of the fill tube connection to the fuel tank. While each of these approaches reduces evaporative emissions, they are to large degrees in use today. Thus their further application may be limited to specific situations. It is worth noting, that the use of these technologies has contributed to the relatively large compliance margins under the existing hot soak plus diurnal standards.

The reductions required and cost of compliance for any given vehicle model will depend on its current certification level and the type of evaporative emission control technology applied. The baseline emission values for 2-day hot soak plus diurnal evaporative emission certification for current models range from 0.42–0.96 grams per test (g/test). Achieving the desired compliance targets (at least 25 percent below the Tier 3 standard) would require reductions ranging from 0.12 g/test for LDT2s to 0.51 g/test for HDGVs.<sup>360</sup> EPA estimates 2025MY costs in the range of \$9–15 per vehicle with a fuel cost savings of about \$2 over the vehicle life. The application of the technologies expected to see widespread use under Tier 3 will create the margins need for compliance and in some cases

create excess reductions which could be used to generate credits for ABT.

#### 4. Heavy-Duty Gasoline Vehicle (HDGV) Requirements

##### a. Background on HDGV

HDGVs are gasoline-powered vehicles with either a GVWR of greater than 8,500 lbs, or a vehicle curb weight of more than 6,000 lbs, or a basic vehicle frontal area in excess of 45 square feet.<sup>361</sup> HDGVs are predominantly but not exclusively commercial vehicles, mostly trucks and other work type vehicles built on a truck chassis. EPA often discusses HDGVs in three basic categories for regulatory purposes according to their GVWR class. These are Class 2b (8,501–10,000 lbs GVWR), Class 3 (10,001–14,000 lbs GVWR), and Class 4 and above (over 14,000 lbs GVWR). These are further sub-categorized into complete and incomplete vehicles.<sup>362</sup> Class 2b HDGVs are mostly produced by the manufacturers as complete vehicles and are very similar to lower GVWR LDTs of the same basic model sold by the manufacturers. Class 3 HDGVs are also built from LDT chassis with fuel system designs that are similar to their Class 2b and LDT counterparts, but these are on some occasions sent to secondary manufacturers as incomplete vehicles to attach a load carrying device or container. EPA estimates that more than 95 percent of Class 2b/3 vehicles are complete when they leave the original equipment manufacturer (OEM). Class 4 and above HDGVs are built on a more traditional heavy-truck chassis and in most cases leave the OEM as an incomplete vehicle. For Class 2b/3 vehicles, it is common to certify the vehicle for emissions purposes (exhaust, evaporative, etc) as a full chassis, while for Class 4 and above the vehicle is certified as a chassis for evaporative emissions while the engine is dynamometer certified for exhaust emissions.

HDGVs have been subject to evaporative emission standards since the mid 1980s. Recently, the timing of the standards has lagged requirements for LDVs and LDTs by several years, but the standards are of comparable stringency when vehicle size and fuel

<sup>361</sup> MDPVs also meet the definition of HDVs, but they are classified separately for evaporative and refueling emission purposes. See 40 CFR 86.1803–01.

<sup>362</sup> Heavy-duty vehicles may be complete or incomplete. A complete HDGV is one that has the primary load carrying device or container (or equivalent equipment) attached, normally by the vehicle OEM. An incomplete vehicle is one that does not have the primary load carrying device or container (or equivalent equipment) when it leaves control of the manufacturer of the engine.

<sup>360</sup> Passavant, G. (December 2013). Assessment of 2013 MY Evaporative Emission Results. Memorandum to the docket.

tank volume are considered. The most recent 2/3 day hot soak plus diurnal standards for HDGVs took effect in 2008. Refueling control requirements apply to complete Class 2b vehicles only. These requirements phased-in over the period from 2004–2006.

#### b. HDGV Evaporative Emission Control Requirements

As discussed above, EPA is including HDGVs within the Tier 3 evaporative emissions program. The hot soak plus diurnal and canister bleed test emission standards that will apply to these HDGVs are presented in Table IV–19 and Table IV–20 and the high altitude standard is presented in Table IV–21. These vehicles will be included in the averaging calculation beginning in the 2018 MY and will be eligible for creating and using allowances and credits.

Furthermore, for the reasons discussed below, EPA is requiring that all complete HDGVs regardless of their GVWR be required to meet the refueling emission standards and use the test procedures currently required for LDVs and LDTs and complete Class 2b vehicles. (See § 86.1813–17). In their comments, manufacturers expressed concern about the amount of gasoline used in the development and certification of refueling emission control systems for HDGVs (due to the larger fuel tanks). To address this concern, EPA will permit manufacturers to certify using two separate processes for vehicles with tanks of 40 gallons or larger. The first will be the engineering evaluation of canister and purge data from lighter weight HDGVs certified in the SHED to show that similar or scaled-up systems on heavier HDGVs have the purge volume and canister working capacity to pass the refueling standard. This could include a comparison of control system design elements such as canister shape, canister internal architecture, total canister volume, and total gasoline working capacity as well as purge air volume over the Federal Test Procedure. This would be subject to the application of good engineering judgment. The second is application of the provisions of 40 CFR 86.153–98 (a) through (b)(1) on a bench set up for a tank of the appropriate volume in lieu of a vehicle test to show the efficacy of the fill neck seal. Such a test could be conducted in a conventional SHED.

The ORVR requirement applies to complete Class 3 vehicles by the 2018MY and all other complete HDGVs by the 2022MY. EPA proposed these requirements for Class 3 HDGVs and asked for comment on extending the requirements to all HDGVs. The

manufacturers expressly commented that HDGV ORVR requirements should be limited to complete HDGVs.<sup>363</sup> There are only four manufacturers of HDGVs. Of these, three offer complete products in the Class 3 weight range and none offer complete products in the Class 4 and above weight range. As mentioned above, Class 3 vehicles have largely the same vehicle chassis and fuel system configurations as Class 2b vehicles. The manufacturers of complete Class 2b vehicles indicated to the CARB and EPA that they carry across their Class 2b fuel evaporative control system designs onto Class 3 and this includes the onboard refueling vapor recovery (ORVR) system used for control of refueling emissions. Thus, applying refueling emission controls to complete Class 3 vehicles adds no cost and has little additional emission reduction benefit. However, it does set a requirement to continue these controls in future model years. There are no complete Class 4 and above HDGVs and neither manufacturer who certifies incomplete HDGVs above 14,000 lbs GVWR objected to establishing an ORVR requirement for complete HDGVs.<sup>364</sup> This sector is made of incomplete HDGV chassis and diesel-powered products. However, setting a requirement for potential future Class 4 and above designs establishes certainty for manufacturers but brings no near term cost burden or emission reductions.

Incomplete HDGVs make up 15–20 percent of all HDGV sales. Of this, approximately 80 percent are Class 2b/3 and 20 percent are Class 4 and above. EPA is not extending the refueling emission control requirement to incomplete HDGVs at this time. The control system designs would be essentially the same as on complete HDGVs, but manufacturers have indicated to EPA that they would have to establish additional measures to ensure that the steps taken to complete the vehicle by the secondary manufacturer do not compromise the integrity and safety of the fuel/evaporative control system (including ORVR) and that the ORVR system continues to perform properly with regard to emissions control. While there are relatively few of these vehicles, their contributions to the inventory are larger than might be expected due to their

<sup>363</sup> See comments of Alliance of Automobile Manufacturers and Association of Global Automakers in the public docket at EPA–HQ–OAR–2011–0135–4451.

<sup>364</sup> Passavant, G., (September 2013). EPA and General Motors Meeting on Issues Related to Tier 3 NPRM and (September 2013). EPA and Ford Meeting on Issues Related to Tier 3 NPRM. Memorandums to the docket.

lower fuel economy. Given these contributions, EPA may consider proposing to apply ORVR to incomplete HDGVs in a future action.

EPA is also including a provision that manufacturers be permitted to comply with the refueling emission standard as early as the 2015 MY to earn on a one-to-one basis allowances which could be used to phase-in the Class 3 refueling emission control requirement or as an allowance on a 2:1 basis under the Tier 3 evaporative emission program. EPA believes this is appropriate since the expected daily average reduction in vehicle refueling emissions for this class of vehicles is large relative to the reduction in evaporative emissions expected under Tier 3. This would also apply to any incomplete HDGV a manufacturer voluntarily certified to the refueling emission standards. Any certifications, including those done early, must use EPA Tier 3 test procedures and certification test fuels or CARB LEV III equivalents.

#### c. Other Program Elements for HDGVs

In the NPRM, EPA sought comment on several provisions related to Tier 3 certification test fuel and evaporative emission control requirements.

First, EPA sought comment on whether heavy-duty gasoline engines (HDGEs) not subject to new Tier 3 exhaust emission standards (those certified for exhaust emissions using an engine dynamometer) which are used in HDGVs subject to Tier 3 evaporative emission standards should certify for exhaust emissions on Tier 3 emissions test fuel.<sup>365</sup> Manufacturers responded by asking that the use of Tier 3 fuel for HDGE exhaust emissions certification be voluntary, but agreed that the use of Tier 3 certification fuel would not change the stringency of the current dynamometer-based emission standards or the costs of compliance. Based on consultations with manufacturers, EPA has decided to require that all HDGEs be certified on Tier 3 fuel by the 2022MY.<sup>366</sup> To provide flexibility for very unique applications or circumstances, EPA will allow up to five percent of a manufacturer's

<sup>365</sup> EPA also sought comment on whether to require HDGVs to use Tier 3 emissions test fuel for evaporative emissions standards even if we did not adopt the proposed Tier 3 evaporative emission standards and whether to allow Class 4 and above HDGVs to earn allowances or credits if EPA did not adopt the Tier 3 standards for these vehicles. These have been superseded by our decision to apply the Tier 3 evaporative emission standards to all HDGVs as described above.

<sup>366</sup> Passavant, G., (September 2013). EPA and General Motors Meeting on Issues Related to Tier 3 NPRM and (September 2013). EPA and Ford Meeting on Issues Related to Tier 3 NPRM. Memorandums to the docket.

dynamometer-certified HDGE sales in any given model year to be certified using Tier 2 certification fuel. This flexibility is limited to certification based on carryover data beginning in the 2022MY.

Second, as discussed in Section IV.F.5 for light-duty vehicles, we are committed to the principle of ensuring that any change in test fuel for heavy-duty gasoline vehicles/engines will not affect the stringency of either the fuel consumption or GHG emissions standards. As part of the separate rulemaking discussed in Section IV.F.5, we expect to establish the appropriate test procedure adjustment for HD engine fuel consumption standards and to determine the need for any test procedure adjustment for GHG emissions standards based on the change in certification test fuels.

Third, to simplify the evaporative emission regulations for HDGVs and to bring them more in line with the current structure of the product offerings in this sector, we are finalizing provisions to permit evaporative emissions certification by engineering analysis for vehicles above 14,000 lbs GVWR (instead of above 26,000 lbs GVWR as permitted in the existing regulations). We are also finalizing regulatory language to clarify how these provisions are to be implemented. This applies to the hot soak plus diurnal, running loss, and canister bleed standards. These HDGVs will remain subject to the emission standards when tested using the specified procedures. This is the same cut point allowed by CARB and will allow for one certification method. Even though it was supported by one commenter, we are not including specific provisions for design-based certification for HDGVs over 14,000 lbs GVWR. EPA believes that the option to certify using engineering analysis and data serves the same purpose.

Fourth, we are finalizing a revised description of evaporative emission families that does not reference sealing methods for carburetors or air cleaners as this technology is now obsolete for HDGEs.

Fifth, EPA is finalizing regulatory language permitting HDGVs over 14,000 lbs GVWR to be grouped with those between 10,001 and 14,000 lbs GVWR for purposes of complying with evaporative and refueling emission control standards and related provisions. In these cases, we require these HDGVs to meet all the requirements applicable to the group in which they are being included (e.g., useful life, OBD, etc.).

Finally, the regulations at 40 CFR part 86, subpart M, describe how to test

heavy-duty vehicles above 14,000 lbs GVWR to demonstrate compliance with evaporative emission standards. Most of these provisions are identical to those that apply under 40 CFR part 86, subpart B. We are eliminating subpart M and replacing it with a simple instruction to test these heavy-duty vehicles using the procedures of subpart B, with a small number of appropriate modifications noted as exceptions to the light-duty test procedures. Relying on references to subpart B instead of largely copying them into subpart M eliminates many pages of unnecessary regulatory text and makes it easier to maintain a consistent set of requirements. Changing a provision in subpart B in the future will automatically apply for evaporative testing of both light-duty and heavy-duty vehicles unless otherwise provided in the particular rulemaking.

In response to comments received, we are specifying that heavy-duty vehicles above 14,000 lbs GVWR must use the same drive schedules and test fuels that apply for light-duty vehicles. Subpart M already allows light-duty drive schedules and certification test fuels as an alternative to using those for heavy-duty vehicles, and most if not all manufacturers of these vehicles already use the light-duty drive schedules, which facilitates testing simplicity and coordination of design parameters with light-duty vehicles. The heavy-duty drive schedule generally involves less driving, which makes this the more stringent test option for designing purge. Omitting this more stringent option therefore does not change the effective stringency of the applicable standards.

With these changes from the proposed rule, there are only two aspects of testing that are different for heavy-duty vehicles above 14,000 lbs GVWR. First, the regulations specify that the exhaust emission measurements are not required for the driving portion of the test between canister pre-conditioning and diurnal testing. Exhaust emission standards in this vehicle size range apply based on engine testing only. Second, wider engine speed tolerances apply. This is captured in part 1066 by specifying wider engine speed tolerances for any testing that does not require exhaust emission measurements since the greater allowance has no effect on emissions measurements. This applies, for example, for pre-conditioning drives for light-duty vehicles, and it also applies for pre-conditioning related to evaporative emissions of heavy-duty vehicles above 14,000 lbs GVWR.

There are some differences in the existing test provisions in subparts B and M that we are not preserving. Some

of these differences arose from changes to subpart B that were inadvertently not carried over to subpart M. In other cases, there may have been an intentional distinction that no longer applies (such as provisions related to slippage on twin-roll dynamometers). Also, we are not retaining distinctions in subpart M related to procedures for determining road load settings and for operating manual or automatic transmissions. Additional differences we are not preserving include gas divider specifications, SHED and dynamometer calibration procedures, and some provisions for alternative canister loading and vehicle pre-conditioning. We are also restoring the content of § 86.1235(b) through (i) related to dynamometer operating procedures, which were inadvertently removed in an earlier rulemaking.

#### 5. Evaporative Emission Requirements for FFVs

A flexible fuel vehicle (FFV) as defined in 40 CFR 86.1301-01 means any motor vehicle engineered and designed to be operated on a petroleum fuel and on a methanol or ethanol fuel or any mixture of the petroleum fuel and methanol or ethanol. Many manufacturers have one or more FFVs in their product offerings. These include many different LDV and LDT vehicle chassis styles including passenger cars, mini-vans, pick-ups, sport utility vehicles and even a few HDGVs.

The EPA regulations implementing the FFV provisions for ethanol FFVs, including those in 40 CFR 86.1811-04 and 86.1811-09, have been applied primarily for FFVs capable of operating on gasoline/ethanol mixtures up to E85. As a matter of policy, EPA has not required certification testing for evaporative and refueling emissions on the full range of E0-E85 fuel blends, but instead has allowed the option to use a blend created when Tier 2 fuel (9 RVP E0) is splash blended with ethanol to a 10 percent gasoline/ethanol blend. This simulates what often occurs in the vehicle fuel tank when Tier 2 fuel (9 RVP E0) is dispensed into a tank containing mostly E85. This yields a blend which has a Reid vapor pressure of about 10 psi. Nearly all manufacturers have certified using this option. The California ARB LEV III program has no special evaporative or refueling emission test fuel requirements for FFVs.

In the Tier 3 NPRM, EPA proposed to revise the certification test fuel for evaporative emissions, to revise the hot soak plus diurnal emission standard, and to add a canister bleed emission standard and a leak standard. These



standards apply to FFVs and non-FFVs. EPA proposed to revise the ethanol content of the certification test fuel for refueling emissions but did not otherwise propose to change the fuel vapor pressure, the level of the refueling emission standard or the test procedure. Furthermore, in the NPRM, EPA sought comment on leaving unchanged the basic approach to FFV certification test fuel for Tier 3 evaporative and refueling emissions, except that the certification test fuel would be 9 RVP E0 splash blended with E15 such that the blend would have a 10 psi vapor pressure, i.e., the RVP of the evaporative emissions test fuel used by nearly all manufacturers. Manufacturers commented that the Tier 3 certification test fuel should be the same for FFVs and non-FFVs and that carryover should be permitted from Tier 2 to Tier 3. EPA met with several manufacturers to clarify their comments and to discuss issues affecting the evaporative and refueling emissions certification fuel for FFVs.<sup>367</sup>

For FFVs, EPA has several factors to consider for evaporative and refueling emission certification test fuel. First, EPA is finalizing a 9 RVP E10 certification test fuel for non-FFVs for evaporative and refueling emissions. This is consistent with our broader policy objective to allow the manufacturers to sell the same vehicles in all 50 states. Second, 10 psi RVP certification test fuel for the Tier 3 evaporative emission standards for FFVs could result in more evaporative emission reductions than a 9 psi RVP test fuel, but this would be counter to the broader policy objective regarding a national program since CARB has no separate FFV evaporative emission standards and likely would affect the stringency of the final evaporative emission standards. Specifically, finalizing 10 psi RVP certification test fuel for the Tier 3 evaporative emission standards as applied to FFVs would increase the stringency of the evaporative emission standards for FFVs both compared to the Tier 3 evaporative emission standards with 9 psi RVP test fuel for non-FFVs and compared to the Tier 2/MSAT evaporative emission standards with 10 psi RVP test fuel for FFVs. Third, we are not changing the level of the refueling emission standard (though we are adding ethanol to the test fuel and extending ORVR to complete Class 3 HDGVs) and we did not examine how a potential change

from the existing 10 psi RVP test fuel for FFV refueling would affect in-use emission reductions or the stringency of the refueling standard for FFVs. A change in the test fuel vapor pressure likely would likely lead to a change in the stringency of the refueling emission standard as they are now applied to FFVs. Retaining the current requirements for refueling emissions for FFVs does not affect the national program since CARB currently follows Federal Test Procedures and test fuels for ORVR.

Balancing all of these factors, EPA is adopting a bifurcated scheme for evaporative and refueling emission certification for Tier 3. Evaporative emission requirements for the hot soak plus diurnal, canister bleed, running loss, spit back, and leak standards will be based on Tier 3 certification fuel (9 RVP E10) for FFVs. This will permit reciprocity between the LEVIII and Tier 3 evaporative emission standards programs and subject the manufacturers to only one set of evaporative emission tests for FFVs and non-FFVs. However, for the refueling emission standard, EPA is retaining the 10 psi certification test fuel requirement for FFVs because the worst case in-use RVP conditions when E0 and E85 are commingled will still be possible. In current systems, the fuel vapor pressure in the refueling emission test drives the total gasoline working capacity of the activated carbon canister that is necessary in the integrated evaporative/refueling control system. Although a 10 psi RVP certification fuel for evaporative emissions control could be viewed as more stringent, we believe that keeping the fuel vapor pressure at 10 psi in the refueling test, which is what was proposed for comment, will help to assure that the in-use emission reduction benefits of current evaporative systems on FFVs are retained. We expect that total canister gasoline working capacities will still be driven by the 10 psi RVP fuel used in the refueling test and therefore the higher in-use RVP conditions which impact evaporative emissions will still be addressed.

EPA is specifying a 10 RVP E10 test fuel specification for FFV refueling emissions certification. However, as a compliance alternative EPA will continue to permit certification based on in vehicle fuel tank blending of two different fuels (i.e., vehicle fuel tank filled to 10 percent of capacity with E85 and then refueled to at least 95 percent of capacity with (9 RVP E0). Either of these approaches will also meet CARB certification test fuel requirements as the test fuel vapor pressure would be higher than with EPA's 9 RVP E10 or

CARB's 7 RVP E10 test fuel. In addition, we are not changing existing requirements that all IUVP testing for evaporative and refueling tests are done on the non-FFV fuel (i.e., Tier 2 IUVP vehicles are tested on 9 RVP E0 and Tier 3 IUVP vehicles are tested on 9 RVP E10).

In their comments on the Tier 3 NPRM, manufacturers asked that EPA allow carryover of certification emission data from Tier 2 to Tier 3. Since the regulatory approach for refueling emissions is basically the same as what is currently being used by the manufacturers, we believe there should be opportunity for carryover of refueling emission data under the current regulatory program. Manufacturers also expressed concern that the refueling emission standard would require them to keep a 10 RVP E10 or 9 RVP E0 test fuel solely for refueling emission standard certification purposes. To help address this concern, in certification testing, EPA would consider approving other refueling test fuel blends with 10 percent ethanol and 10 psi such as a refueling event where a tank is filled initially with 10 percent E85 and during refueling test is filled with 90 percent 9 RVP E0. EPA would also permit manufacturers the option to seek EPA approval to certify by attestation using alternative procedures or through engineering analysis based on similar evaporative/refueling emission system configurations and emission test results and data on similar vehicles showing that the vehicle could pass the refueling emission standard and meet the requirements in use on 10 psi RVP E10 fuel. They would remain subject to confirmatory testing on 10 RVP E10. Both of these options could only be implemented with approval of the Administrator.

## 6. Test Procedures and Certification Test Fuel

### a. Review and Update of Testing Requirements

EPA adopted the current test requirements for controlling evaporative emissions in 1993.<sup>368</sup> Those changes included: (1) Diurnal testing based on heating and cooling the ambient air in the SHED<sup>369</sup> instead of forcing fuel temperatures through a specified temperature excursion; (2) repeated 24-hour diurnal measurements to capture both permeation and diurnal emissions; (3) high-temperature hot soak testing; (4)

<sup>368</sup> 58 FR 16002 (March 24, 1993).

<sup>369</sup> SHED is the **Federal Register** acronym for sealed housing for evaporative determination. The SHED is the enclosure in which the evaporative emissions are captured before measurement.

<sup>367</sup> Passavant, G. (September, 2013). EPA, GM, Ford, and Chrysler Meeting on Tier 3 Certification Fuel for Evaporative and Refueling Emission Standards for FFVs. Memorandum to the docket.

high-temperature running-loss measurements with a separate standard, including controlled fuel temperatures according to a fuel-temperature profile developed for the vehicle; and (5) canister preconditioning to ensure that vehicles could effectively create canister capacity to prepare for several days of non-driving.

These test procedures are generally referred to as “enhanced evap” testing. EPA adopted these “enhanced evap” test procedures in coordination with CARB. The test requirements include two separate test sequences to demonstrate the effectiveness of evaporative emission controls. The “2-day sequence” involves canister loading to two-gram breakthrough, followed by driving for the exhaust test (about 31 minutes), a hot soak test, and two days of cycled ambient temperatures. The “3-day sequence” involves canister loading with 50 percent more vapor than needed to reach breakthrough, followed by driving for the exhaust test, driving for the running loss test (about 97 minutes total), a high-temperature hot-soak test, and three days of cycled ambient temperature.

The 2-day sequence was intended primarily to insure a purge strategy which would create enough canister capacity to capture two days of diurnal emissions after limited driving. The two-day measurement period is also effective for requiring control of permeation and other fugitive emissions. The 3-day sequence was intended to establish a design benchmark for achieving adequate canister storage capacity to allow for several days of parking on hot summer days, in addition to requiring vehicle designs that prevent emissions during high-temperature driving and shutdown conditions.

After adopting these evaporative test procedures, we set new standards for refueling emissions control which called for onboard refueling vapor recovery (ORVR).<sup>370</sup> Manufacturers have typically designed their ORVR systems to be integrated with their evaporative controls, using a single canister and purge strategy to manage all fuel vapors vented from the fuel tank. Due to the magnitude of the refueling emission load and the manner in which the load rates affect activated carbon capture efficiency, it has become clear that ORVR testing with these integrated systems serves as the benchmark for achieving adequate canister storage capacity.

In the nearly 20 years since adopting these test procedures, manufacturers

have made great strides in developing designs and technologies to manage canister loading and purging and to reduce permeation emissions. Except as discussed below, we are not changing the test procedures for demonstrating compliance with the Tier 3 emission standards. As described above, we are adopting a new standard based on measured values over a canister bleed test, and a fuel system rig test. These are intended to measure only fuel vapors which diffuse from the evaporative canister or permeate/leak from a fuel system. CARB developed these procedures as a means for setting standards that are not affected by nonfuel background emissions. The canister bleed test procedure is a variation of the established two-day test sequence. The canister is preconditioned by purging and loading to breakthrough, then attached to an appropriate test vehicle for driving over the duty cycle for the exhaust test. The canister is then attached to a fuel tank for measurement. After a stabilization period, the tank and canister undergo two days of temperature cycling. Canister emissions are measured using a flame ionization detector (FID), with a conventional SHED approach or by collecting emissions in a bag and measuring the mass. Rather than repeating CARB’s regulations, we are incorporating those regulations by reference into the CFR.<sup>371</sup> This will avoid the possibility of complications related to minor differences that may occur with separate test procedures. The fuel system rig test is a bench test where a complete vehicle fuel system (without the vehicle chassis) is constructed in the SHED and evaluated over the 3-day cycle in both a “wet” and “dry” state.<sup>372</sup>

CARB adopted the fuel system “rig test” as an optional approach to demonstrate control of evaporative emissions without the effects of the nonfuel hydrocarbon emissions that are seen in testing the whole vehicle in the SHED. We generally expect manufacturers to comply with the EPA requirements which include the canister bleed test and emission standard instead of CARB LEV III Option 1 which includes the rig test and emission standard. However, since we are

accepting PZEV zero evap and CARB LEV III Option 1 certifications for the 2017–2018 MYs and 2017–2021 MYs, respectively, we are also incorporating by reference CARB’s rig test into the CFR to accommodate those manufacturers that do in fact rely on this approach.

Also, as discussed further below, we are adopting a new leak test procedure which will be used to measure leak rates for the leak standard. The leak test standard test procedure is contained in the regulatory text.

Manufacturers have raised a pair of related concerns regarding the current test procedures. First, hybrid vehicles and new engine designs for meeting fuel economy standards and CO<sub>2</sub> emission standards increase the challenge of maintaining an adequate purge volume to prepare vehicles for the diurnal test. For hybrid vehicles this is related to the amount of time the engine is running. For other technologies this is related to the trend toward decreasing available vacuum in the intake manifold, which is the principal means of drawing purge air through the canister. Second, preconditioning the canister by loading to breakthrough serves as a disincentive for some control strategies that might otherwise be effective at reducing emissions, such as designs involving greater canister capacity or better containment of fuel vapors inside the fuel tank. In addition, we have learned from studying in-use emissions and in-use driving behaviors and usage patterns that it is not uncommon for vehicles to go for an extended period with little or no opportunity to purge the canister.

In the NPRM, we requested comment on an optional adjustment to the test procedure intended to address these three concerns. In this alternative, for designs involving pressurized tanks, manufacturers would determine an alternative vapor load to precondition the canister before the exhaust test. If, for example, a fuel system is designed to stay sealed up to 1 psi and to vent vapors to the canister if rising temperatures trigger a pressure-relief valve, the manufacturer could quantify the actual vapor load to the canister during three consecutive days of cycling through diurnal test temperatures. This three-day vapor load would be the amount of fuel vapor used to precondition the canister (loaded at the established rate of 15 grams per hour). This canister loading may also involve butane instead of fuel vapor, but we would likely require a greater mass of butane to account for the fact that it is easier to remove the butane from the activated carbon in the canister. This

<sup>371</sup> For a description of the canister bleed test procedure (BETP), see pp. III–51 to III–55 of [http://www.arb.ca.gov/db/search/search\\_result.htm?cx=006180681887686055858%3Abew1c4wl8hc&cof=FORID%3A11&q=BETP&siteurl=http%3A%2F%2Fwww.arb.ca.gov%2Fhomepage.htm](http://www.arb.ca.gov/db/search/search_result.htm?cx=006180681887686055858%3Abew1c4wl8hc&cof=FORID%3A11&q=BETP&siteurl=http%3A%2F%2Fwww.arb.ca.gov%2Fhomepage.htm) (last accessed on January 13, 2014).

<sup>372</sup> See <http://www.arb.ca.gov/msprog/mac/mac0503/mac0503.pdf> for a description of the rig test standard and test procedure (last accessed on January 13, 2014).

approach would be flexible to accommodate any design target for pressurizing fuel tanks. Canister preconditioning for the ORVR test (for integrated and nonintegrated systems) would remain unchanged. EPA sees merit in further consideration of such test procedure flexibilities, but auto manufacturers did not provide support these concepts in their comments and we are not adopting the proposed optional adjustment.

#### b. Test Fuel for Certification

EPA is changing the certification test fuel specifications as described in Section IV.F. Here we discuss some implications for evaporative and refueling emissions testing beyond those discussed above for FFVs. We are revising the certification test fuel specification in conjunction with the Tier 3 standards, principally to include ethanol and reduce sulfur such that the test fuel better aligns with the current and projected in-use fuel. Although we received unsolicited comment asking that we set durability test fuel specifications for evaporative and refueling emission control systems to be the same as those for the certification test fuel (9 RVP E10 in this final rule), we are not changing durability fuel specifications in this rule other than to remove minimum sulfur content requirements. In particular, we are not changing the existing requirement that “any mileage accumulation method for evaporative emissions must employ gasoline fuel for the entire mileage accumulation period which contains ethanol in, at least, the highest concentration permissible in gasoline under federal law and that is commercially available in any state in the United States”. See §§ 86.1824–08(f)(1) and 86.113–04(a)(3)(i). EPA believes this is prudent policy to ensure that emission control systems are designed for the fuels with the potential to adversely affect durability and there is no reason to change the existing approach especially since E15 fuel is now legally permissible and commercially available for appropriate vehicles and there is potential for its market penetration to increase in the future. Any bench aging using E15 fuel must simulate the effects of alcohol in-use fuels on evaporative emission system components.

Since there are already vehicles in the market which employ the technology needed to meet the new hot soak plus diurnal requirements, EPA is taking a flexible approach to the phase-in of the certification test fuel. This is summarized in Table IV–22.

To accommodate vehicles already designed to meet CARB PZEV zero evap evaporative emission requirements, EPA’s phase-in provides that PZEV zero evap vehicles which qualify for carryover can use CARB Phase 2 fuel for evaporative emissions (hot soak plus diurnal and running loss standards) and rig test certification for MYs 2015–2019. For CARB PZEV zero evap vehicles, high altitude, refueling, and spit back standard certification may use either EPA Tier 2 or Tier 3 fuel in MYs 2015–2019. For the leak standard in the 2018 and later MYs, they must use Tier 3 test fuel. Beginning in the 2017 MY, the use of PZEV zero evap data is limited to carryover of data from 2015 or 2016 MY certifications.

Those using CARB LEV III Option 1 can use CARB Phase 3 fuel for evaporative emissions (hot soak plus diurnal and running loss standards) and rig test certification for MYs 2015–2021. For CARB Option 1, high altitude, refueling, and spit back standard certification must use Tier 2 or Tier 3 fuel in MYs 2015–2016 but in the 2017 and later MYs all LEV III option 1 certifications for the high altitude, refueling, spit back, and leak standards must use EPA Tier 3 fuel.

CARB LEV III Option 2 evaporative emission vehicles may use CARB Phase 3 fuel to meet evaporative (hot soak plus diurnal and running loss standards) and canister bleed standards beginning in 2015 MY and following. High altitude, refueling, and spit back may use Tier 2 or Tier 3 fuel in model years 2015 and 2016. For 2017 and later model years CARB LEV III option 2 evaporative families must use Tier 3 test fuel for high altitude, refueling, spit back, and leak standard certifications.

Tier 3 evaporative emission vehicles must use Tier 3 fuel to meet evaporative emission (hot soak plus diurnal and running loss standards), high altitude, canister bleed, and refueling/spit back emission standards beginning in the 2015 MY and following. Beginning in the 2018 MY, Tier 3 vehicles must use Tier 3 emission test fuel to demonstrate compliance with the leak standard requirements.<sup>373</sup>

When the program is fully phased-in, any Tier 3 evaporative emission certification will have to use Tier 3 certification test fuel and test procedures or CARB equivalent test procedures and fuels. This could be done as early as the 2015 MY and will

<sup>373</sup> This provision applies in 2017 MY for vehicles meeting the Tier 3 requirements using the 20/20 option and does not apply to HDGVs with a GVWR greater than 14,000 lbs. Incomplete HDGVs have until the 2022 MY to meet the spit back standard.

be required for all vehicle models by the 2022 MY.<sup>374</sup> As indicated above and in Table IV–22, we are further applying the new test fuel at the same time to ORVR testing. Therefore, beginning in the 2017 MY if manufacturers do any new testing to demonstrate compliance with the Tier 3 evaporative emission standards (using Tier 3 or LEV III fuel), they will need to submit test data to demonstrate compliance with the refueling emission standards using the new certification test fuel as well as the leak (when applicable), spit back, canister bleed, running loss, and high altitude emission standards. Any family that is not yet captured within the Tier 3 phase-in percentage may remain on Tier 2 certification fuel through the 2021 MY. By the 2022 MY all evaporative and refueling emission certifications will have to be on EPA test procedures and certification fuels or CARB equivalents as identified in the regulations. Policies regarding test procedures and test fuels for EPA confirmatory and other post certification testing are discussed in Section IV.C.6.e below.

Finally, we are including provisions to allow any vehicle certified to the refueling spit back standard separately (mostly incomplete HDGVs) to continue to do so using Tier 2 current certification fuel until the 2022 MY even if its evaporative emissions are certified on Tier 3 certification fuel. This is reasonable since the fill quality of the vehicle and eliminating spit back are not necessarily related to the ethanol or sulfur content of the gasoline. The manufacturers must meet this requirement through testing, as the engineering evaluation flexibility available for HDGVs over 14,000 lbs GVWR does not apply to this standard.

#### c. Correction for Ethanol Portion of the SHED Measurement

Another issue related to adding ethanol to the certification test fuel relates to the emission measurement in the SHED. Emissions are detected by flame ionization detectors (FID), which are less responsive to ethanol than gasoline. This effect causes under-reporting from the ethanol portion of the fuel vapor. Fuel-related emissions from the vehicle may be slightly more weighted toward ethanol than gasoline, depending on how the different fuel constituents permeate through various fuel-system materials, how they evaporate from the bulk fuel in the tank at varying temperatures, and how they adsorb onto and desorb from the

<sup>374</sup> The only exception here would be if a vehicle uses allowances in the 2022 model year to meet the Tier 3 evaporative emission requirements.

activated carbon in the canister. We proposed to address this issue by the use of a prescribed correction factor. Under this approach manufacturers would simply multiply their SHED measurement results by a fixed value to adjust upward for the difference in the FID response to ethanol. Data available to EPA at the time of the NPRM suggested that a value of approximately 1.1 would be appropriate for E15.<sup>375</sup> For an E10 certification fuel, California ARB finalized a value of 1.08.

In their comments, the manufacturers supported the use of a correction factor, but stipulated that the value put forth by EPA was too large and they should be given the option to measure the ethanol fraction of the vapor in the SHED through procedures and instrumental approaches prescribed in the regulations (see 40 CFR 1065.269, 1065.369, and 1065.805) instead of using a fixed correction value. Two manufacturers provided data based on testing with E10 test fuel which generally showed lower ethanol fractions than represented by the 1.1 value proposed by EPA for hot soak plus diurnal emissions, and uniformly showed very low ethanol fractions for refueling measurements.<sup>376</sup>

EPA has reviewed the data provided by the manufacturers and has considered their comment that they should be given the option to measure the ethanol fraction and adjust the SHED results rather than be required to use a fixed correction factor. Based on these considerations, EPA is establishing the following approach with regard to ethanol corrections. First, EPA will permit measurement or the use of a fixed correction factor on an evaporative family by evaporative family basis. However, once the manufacturer selects an approach for any given evaporative family, that approach must be used in all subsequent testing of all vehicles certified using that data including carry over. For example, if a manufacturer chooses to measure the ethanol fraction for purposes of certification of a test group in a given model year, that same method must be used in any manufacturer confirmatory testing as well as IUVP or IUCP testing of all vehicles in that test group. Alternatively, if a manufacturer uses the fixed correction factor in certification it must also use it for all evaporative emission tests covered by the requirement for a given test group and

for all follow on testing. Second, the decision on measurement or correction factor must be uniform on a test group basis for all evaporative emission standards covered by the correction requirement. In this case this includes hot soak, diurnal, high altitude, running loss, and rig test measurements. Third, in terms of a fixed correction factor, EPA believes that the 1.08 value adopted by California is consistent with the data and is specifying that value for hot soak plus diurnal (low and high altitude), running loss, and rig test measurement corrections for any testing conducted with 10 percent ethanol. Based on the data provided by the manufacturers, EPA is not requiring a fixed correction value or measurement for refueling, spit back, or canister bleed measurements for testing conducted with 10 percent ethanol. This aligns with the expectation that ethanol concentrations will be very low with FID-based measurements and that mass-based measurements will capture any ethanol adequately without a need for correction. Finally, EPA will use the method selected by the manufacturer in any confirmatory or surveillance testing. However, since corrections will always be zero or greater, no correction is needed to make a failure determination if the FID value exceeds the emission standard or FEL. With regard to the 1.08, EPA remains open to future revisions to this value, in coordination with CARB, if a fuller data set representative of various vehicle models, SHED FID ethanol response values, FID designs (analog vs. digital), ethanol calculation approaches (photo acoustic and impinger), and test sites demonstrates that a different value would be technically appropriate and adequately conservative relative to the direct measurement methods permitted in 40 CFR 1065.

For higher ethanol blends (such as E85), the regulation already specifies measurement and calculation procedures to adjust for this effect. We are not making any changes to these procedures.

#### d. Vehicle Preconditioning for Nonfuel Hydrocarbon Emissions for the Tier 3 Evaporative Emission Standards

The Tier 3 hot soak plus diurnal, leak, and canister bleed emission standards taken together are expected to bring about the widespread use of technology which effectively eliminates fuel vapor emissions. The fuel rig, canister bleed, and leak standards are not influenced by nonfuel hydrocarbon emissions from the vehicle. Nonfuel hydrocarbon emissions from the vehicle are measured as part of SHED emission testing, and are

indistinguishable from fuel hydrocarbons when a FID is used to measure the concentration. The level of these nonfuel hydrocarbon emissions vary by vehicle and component design and material. These emissions arise from paint, adhesives, plastics, fuel/vapor lines, tires, and other rubber or polymer components and are generally greater with larger size vehicles. These nonfuel hydrocarbon emissions are usually highest with newly manufactured vehicles and decrease relatively quickly over time.

Currently, manufacturers normally conduct some preconditioning to reduce or eliminate the effects of these nonfuel hydrocarbon emissions on evaporative emissions measurements in the SHED. In the past, this practice has not been addressed through regulatory provisions. However, given the stringent level of the Tier 3 hot soak plus diurnal evaporative emission standards, and that nonfuel hydrocarbon emissions are expected to be a significant portion of the hydrocarbon emissions measured in the SHED, EPA believes that some sort of preconditioning before certification testing is appropriate and that a regulatory provision addressing this practice is warranted. Providing some recognition of and allowance for this practice will help to create the proper balance between necessary and proper preconditioning to address high nonfuel hydrocarbon emissions and excessive preconditioning which could undermine the intent of the hot soak plus diurnal emission standard (~ 50 mg or less of fuel evaporative emissions). EPA believes the goal of evaporative emissions preconditioning should be to get nonfuel hydrocarbon emissions to what we call vehicle background levels. A working definition of vehicle background level might be the level which will occur naturally twelve months after production. A provision in the regulations which addresses preconditioning reduces ambiguity for the manufacturers and could reduce or eliminate any uncertainty in the true meaning of certification test results.

Manufacturer activity with regard to preconditioning often involves two practices. First, manufacturers in some cases "bake" their test vehicles at temperatures of 50 °C or higher for periods of up to ten or more days to accelerate the off-gassing of these nonfuel hydrocarbon emissions before testing is conducted. While this practice is common, there is no standardized method or protocol for this preconditioning prior to new vehicle certification testing. For example, some manufacturers bake for a set period of time in a climate chamber while others

<sup>375</sup> Moulis, C. (2012, January). SHED FID Responses for Ethanol. Memorandum to the docket.

<sup>376</sup> Passavant, G. (2013, October). Manufacturer Data on Ethanol Measurements in the SHED. Memorandum to the docket.

bake in the climate chamber and periodically measure nonfuel background in a SHED until an acceptable or stable level of nonfuel hydrocarbon emissions is achieved. Second, manufacturers often remove, modify, or clean certain components which are the largest source of nonfuel hydrocarbon emissions. Preconditioning could also include measures to eliminate minor fuel drips, spills, or other fuel remnants which occur as a result of vehicle preparation for testing.

We are not specifying standardized pre-conditioning practices or protocols with regard to addressing nonfuel hydrocarbon emissions before evaporative emission certification testing. However, we are finalizing general provisions in four areas. First, we specify in the regulations that preconditioning for the purpose of addressing nonfuel hydrocarbon emissions is permitted. Second, we specify that any preconditioning is voluntary. Third, we specify that if preconditioning is conducted, the details must be specified to EPA before certification testing, (i.e., at the time of the pre-certification planning meeting). The goal of this preconditioning should be to get nonfuel hydrocarbon emissions to vehicle background levels as discussed above. The specifics to be discussed with EPA could include details on vehicle baking practices such as the temperature and time duration in the climate chamber and practices conducted as an alternative or complement to vehicle baking such as installing used tires (drive and spare) on certification vehicles, and allowing the windshield washer tank to be filled only with water. EPA's goal in these discussions is to gain certainty that manufacturers are not preconditioning vehicles so severely that they create a level of nonfuel hydrocarbons that is artificially low and would not occur in use and thereby creating a false additional compliance margin for fuel hydrocarbons in the certification test. Fourth, except as discussed below we are providing in the regulations that no pre-conditioning is permitted for testing of any vehicle aged more than twelve months from its date of manufacture. This restriction for vehicles older than 12 months includes certification, confirmatory and in-use testing for any vehicle certified to the Tier 3 evaporative emission standards. For these vehicles, nonfuel hydrocarbon emissions will presumably be reduced to a stable level due to natural off gassing which begins after the vehicle is manufactured. Emissions from any replacement parts or other vehicle

maintenance will presumably be encompassed within the margin below the standard created by this natural off-gassing.

EPA received several comments concerning the proposed restriction on pre-conditioning of vehicles older than 12 months from the date of manufacture. The Alliance of Automobile Manufacturers and the Association of Global Automakers asked that baking be permitted if such a vehicle is found to have identifiable contamination due to causes such as a fuel spill, refrigerant leak, or washer fluid leak and that the manufacturer be given the option to age the tires (tires only) from any vehicle where the tires are less than twelve months from manufacture as indicated on the sidewall. CARB asked that EPA only allow the use of an aged spare tire in any testing and not spare tire removal. EPA generally agrees with these commenters and is finalizing provisions for limited flexibility subject to EPA approval. Under these provisions manufacturers may be permitted to clean any spills or leaks but not to bake the entire vehicle. Baking of tires less than 12 months old may also be permitted with EPA prior approval. Vehicles must be tested with a spare tire in place since emissions from the spare tire were considered as the standard was developed. Manufacturers may exchange a new spare tire for one that is baked or aged. Finally, one manufacturer indicated that there may be circumstances where the base chassis for a certification vehicle was used in previous certification but that this base chassis was modified for a new model year and cleaned, reconfigured, and recertified with new components which affect background emissions.<sup>377</sup> While EPA believes this would be a rare occurrence, regulatory provisions in this rule allow EPA to approve additional pre-conditioning for vehicles in this situation upon manufacturer request and justification.

#### e. Reciprocity With CARB

Over the past 15 years EPA's "enhanced evap" test procedures have been based on testing with 9 pound per square inch (psi) RVP gasoline with test temperatures representing a summer day with peak temperatures of about 96 °F. CARB adopted the same basic procedures, but specified that testing should occur with 7 psi RVP gasoline at temperatures of up to 105 °F. EPA and

CARB agreed that certification could be based on testing with either EPA or CARB conditions and that these provided equivalent stringency for purposes of evaporative control system design. However, the provision allowing for this equivalence of test data preserved EPA's ability to also test with either EPA or CARB temperature conditions and related test fuels. CARB always specified EPA test conditions for refueling as they were deemed worst case. CARB recently changed their certification test fuel to a 7 RVP gasoline with 10 percent ethanol and as discussed in Section IV.F, we are changing the Federal certification test fuel specification to a 9 RVP gasoline with 10 percent ethanol.

During the development of this FRM we carefully considered the practice of CARB/EPA reciprocity with regard to certification test fuels, hot soak plus diurnal test procedures, running loss test procedures, and emission test results when it comes to evaporative emissions certification. Based on these considerations and the alignment of the ethanol content for the EPA and CARB certification fuels, we have decided to retain our current approach with regard to CARB/EPA reciprocity for evaporative and refueling emissions. EPA and CARB have agreed to continue accepting emission test data on each other's test fuels and temperature conditions for certification such that a uniform national program for certification test fuel will be able to exist. For model years during the evaporative emissions standard phase-in discussed above (ending after the 2021 MY), EPA will conduct any post certification testing on any vehicle in the Tier 3 program manufactured in the 2015–2021 MYs using the fuel and temperatures used by the manufacturer for certification. This approach covers families certified using carry over PZEV evaporative emissions data (through the 2019 MY) and LEV III Option 1 certifications (through the 2021 MY). Our program flexibility in the area of test fuels for hot soak plus diurnal, running loss and SHED rig/canister bleed emission standards is summarized in Table IV–25. After the 2021 model year, EPA will retain the option to test on either set of temperatures/fuels. This applies to all evaporative emission standards (hot soak plus diurnal, running loss, and canister bleed). For the other emission standards (refueling, leak, spit back, and high altitude hot soak plus diurnal) EPA will use the test fuel used by the manufacturer through the 2019 model year. For the 2020 model year and later we may use Tier

<sup>377</sup> See public comment EPA–HQ–OAR–2011–0135–4299 and Passavant, G. (2013, October). VV Email to EPA Regarding Vehicle Preconditioning. Memorandum to the docket.

3 fuel or California Phase 3 if its use is permitted for certification. Please refer to the regulatory text for specific provisions.

EPA will review all Tier 3 program evaporative emissions data. If the data shows that the EPA and CARB based test requirements give fully equivalent

results, in the future we may revise our regulations so that a vehicle is always tested on the fuel used for its initial certification.

TABLE IV–25—TIER 3 EVAPORATIVE EMISSIONS PROGRAM OPTIONS AND TEST FUELS

Vehicle program	Start MY	Program standards	Cert fuel	EPA test fuel for confirmatory, surveillance & IUVP	End MY for use in Tier 3
PZEV zero evap	2015	Hot soak + diurnal, running loss & SHED rig.	CA Ph. 2 ..	Fuel used by the manufacturer .....	After 2019 MY.
LEV III Opt. 1 .....	2015	Hot soak + diurnal, running loss & SHED rig.	CA Ph. 3 ..	CA Phase 3 through 2019 MY, after EPA may use Tier 3 or CA Phase 3.	After 2021 MY.
LEV III Opt. 2 .....	2015	Hot soak + diurnal, running loss & canister bleed.	CA Ph. 3 ..	CA Phase 3 through 2019 MY, after EPA may use Tier 3 or CA Phase 3.	N/A.
Tier 3 .....	2015	Hot soak + diurnal, running loss & canister bleed.	Tier 3 .....	Tier 3 .....	N/A.

As shown in Table IV–22, to qualify as a Tier 3 vehicle for evaporative emission purposes vehicles must meet the hot soak + diurnal, high altitude, rig/canister bleed, running loss, refueling, and spit back standards. The leak standard applies beginning in the 2018 MY and the SHED rig/canister bleed tests are program specific.

Generally, a vehicle test group using Tier 3 certification fuel and test procedures for meeting the various evaporative and refueling emission standards will qualify for inclusion in the Tier 3 evaporative emission standards phase-in. However, EPA recognizes that the California and federal evaporative emission standard programs are starting from different bases and that the transition provisions are different in some ways. For example, the EPA program starts in the 2017 MY but after that has the same basic program construct as CARB in 2018. However, prior to the 2017 MY, CARB has a ZEV program provision which will continue to bring zero evap technology into the fleet before the 2017 MY and CARB also allows early LEV III Option 1 and Option 2 evaporative emission certifications. To capitalize on this technology and to facilitate transition, we are finalizing provisions that any CARB evaporative emission test data from MYs 2015 and 2016 PZEV zero evap certifications (hot soak plus diurnal and running loss) can be used in federal certification for those evaporative families through the 2019 MY. Similarly, we are finalizing provisions that CARB LEV III Option 1 certifications (hot soak plus diurnal and running loss) can be used in federal certification for those evaporative families through the 2021 MY. Assuming the vehicle test groups also meet the Tier 3 high altitude evaporative emission standards, the refueling emission standard, the spit back standard, and the leak standard when applicable, they could be included in the percentage phase-in calculations as Tier 3 vehicles. If the vehicles do not meet the Tier 3 evaporative emission requirements

manufacturers could potentially sell them nationwide, but they could not be included as Tier 3 compliant vehicles in the percentage phase-in calculation. Table IV–22 provides a concise summary of the requirements a vehicle must meet to qualify as a Tier 3 vehicle during the program’s early, transition, and phase-in periods.

EPA proposed a similar provision for a manufacturer who elects to use the CARB test procedures and test fuels to meet the refueling emission standard. However, no manufacturer indicated interest in their comments and we have decided not to include reciprocity for this provision in the Tier 3 program. While experimental data based on field bench testing suggests that the CARB test fuel RVP and dispensed temperature together would give the same results as the EPA test fuel RVP and dispensed temperature there are no vehicle test data in the record at this time. CARB has always accepted refueling and spit back certification on EPA test fuel and will continue to do so in the future. This provision would have added another layer of complexity to the program and was not necessary since the refueling and evaporative tests are done separately.

f. Evaporative and Refueling Emission Standards for Various Fuels

The evaporative and refueling emission standards apply in different ways to different fuels. First, with regard to the evaporative emission standards, Clean Air Act section 202(k) specifies that gasoline-fueled vehicles must be certified to evaporative emission standards. Section 202(a) authorizes EPA to establish evaporative emission standards for other fuels. Today evaporative emission standards

apply to LDVs, LDTs, MDPVs, and HDVs fueled by gasoline methanol, ethanol, natural gas, and liquified petroleum gas (LPG). For the refueling emission standard the situation is quite different. Section 202(a)(6) of the Clean Air Act specifies that the refueling emission standards apply to all LDVs regardless of the fuel used. Section 202(a) of the Clean Air Act authorizes EPA to establish emission standards for other fuels and classes of vehicles. Prior to the Tier 3 final rule, the refueling emission standards applied to all vehicles less than 10,000 lbs GVWR regardless of the fuel used.

In the NPRM, EPA requested comment on applying the refueling standards to all vehicles regardless of fuel used. This would include all volatile fuels.<sup>378</sup> The evaporative standards apply today to all volatile fuels<sup>379</sup> (except for diesel) and we asked for comment on explicitly including dedicated ethanol as well as fuel-cell vehicles, and electric vehicles. EPA also requested comment on applying the refueling and evaporative standards only to vehicles using volatile liquid fuels instead of all volatile fuels.

EPA received four comments on this issue. One commenter expressed the view that evaporative requirements should be expanded to apply to volatile liquid fuels plus liquified petroleum gas (LPG) and liquified natural gas (LNG) while the three other commenters did not see the need to apply the

<sup>378</sup> A volatile fuel is a volatile liquid fuel or any fuel that is a gas at atmospheric pressure; gasoline, methanol, ethanol, natural gas, and LPG are volatile fuels.

<sup>379</sup> A volatile liquid fuel is a fuel that is liquid at atmospheric pressure and has a Reid Vapor Pressure higher than 2.0 pounds per square inch—gasoline, ethanol, and methanol.

requirements to any gaseous fueled vehicle or other vehicle using a non-volatile liquid fuel because these vehicle fuel systems are sealed and rarely vent during normal operation or never vent at all.

As is discussed further in the Summary and Analysis of comments, based on the comments, the fuel properties, and current industry fuel system design practices, EPA has decided to retain the requirement that the evaporative and refueling emission standards apply to vehicles using any volatile fuel. For gaseous fueled vehicles (LPG and LNG/CNG vehicles), only the Tier 3 3-day hot soak plus diurnal and running loss standards apply. For the other volatile fuels all of the Tier 3 evaporative emission standards apply. For the refueling emission standard the requirements apply to all complete vehicles less than 10,000 lbs GVWR regardless of the fuel used. This is not being changed, except that the requirement will not apply to diesel-powered LDTs and HDVs vehicles. For vehicles over 10,000 lbs GVWR, the refueling emission standards will apply only to complete vehicles. This includes LPG, CNG, LNG, and dedicated ethanol or methanol vehicles. While the test procedures for these standards would apply, EPA is including regulatory provisions to permit manufacturers to certify based on related data, engineering analysis, and compliance with published consensus standards. We are not applying these requirements to electric or fuel cell vehicles.

For vehicles equal to or less than 8,500 lbs GVWR, the Tier 3 evaporative and refueling emission standards for alternative fuel vehicles apply to each vehicle of a vehicle evaporative/refueling family as the family is included in the manufacturer's phase-in for the Tier 3 evaporative emission standards. For vehicles over 8,500 lbs GVWR, the application of the Tier 3 evaporative emission standards depends on the Job 1 (first build) date for the vehicle evaporative family. If the Job 1 date for a vehicle model is before the fourth anniversary date of the signature of the rule then the Tier 3 evaporative emission standards do not apply until the next model year. If the Job 1 date is after the fourth anniversary date, the Tier 3 evaporative emission standards apply in that model year. This determines when the vehicle is to be included in the denominator of the percentage phase-in calculation. The refueling emission standard applies only to complete vehicles and we are applying the same phase-in requirements as for complete HDGVs. For complete vehicles between 10,000

and 14,000 lbs GVWR the refueling emission standard applies in the 2018 model year. For complete vehicles with a GVWR in excess of 14,000 lbs GVWR, compliance is required in the 2022 model year. Finally, for all small businesses, the Tier 3 evaporative and refueling emission standards do not apply until the 2022 model year.

#### g. Other Changes and Future Considerations

This rulemaking included consideration of several amendments or clarifications to existing requirements related to evaporative emissions. As part of this process, EPA has concluded that the following provisions warrant adjustment, clarification, or correction:

- Even though the evaporative emission standards in 40 CFR part 86 apply to the same engines and vehicles that must meet exhaust emission standards, we require a separate certificate for complying with evaporative and refueling emission standards. An important related point to note is that the evaporative and refueling emission standards always apply to the vehicle, while the exhaust emission standards may apply to either the engine or the vehicle. Since we plan to apply evaporative/refueling/leak standard and the recently adopted greenhouse gas standards to vehicle manufacturers, we believe it will be advantageous to have the regulations related to their certification requirements written together as much as possible to reduce burden and increase efficiency. Therefore, for 2015 and later model years, we are moving the emission standards and certification requirements for HDGVs from 40 CFR part 86 to the new 40 CFR part 1037, which was originally used for greenhouse gas standards for heavy-duty highway vehicles. This is not intended to change the requirements that apply to these vehicles, except as noted in this section.

- Section 86.1810-01 contains specifications addressing whether diesel fuel vehicles can be waived from demonstrating compliance with the refueling emission standard through testing. In the existing regulation the potential for a waiver from testing depended on the diesel fuel having an RVP equal to or less than 1 psi and the fuel tank having a temperature which does not exceed 130 °F. We have examined this provision and are withdrawing the fuel temperature limit specification. Short of fuel spillage in the SHED, EPA sees no likelihood that a diesel fueled vehicle with RVP less than 1 psi could fail the refueling emission standard even at fuel tank

temperatures above 130 °F. This is due to the inherently low vapor pressure of diesel at these temperatures and the likelihood that vapor shrinkage conditions will occur in the fuel tank during refueling since the dispensed fuel will be much cooler than the tank fuel.

- When adopting the most recent prior set of evaporative emission regulatory changes we did not carry through the changes applying evaporative emission standards to vehicles using methanol-fueled compression-ignition engines. This final rule corrects this oversight.

- We are finalizing provisions to address which standards apply when an auxiliary (nonroad) engine is installed in a motor vehicle, which is currently not directly addressed in the highway regulation. The approach requires testing complete vehicles with any auxiliary engines (and the corresponding fuel-system components). Incomplete vehicles are to be tested without the auxiliary engines, but any such engines and the corresponding fuel-system components will need to meet the standards that apply under our nonroad program as specified in 40 CFR part 1060.

- We are removing the option for secondary vehicle manufacturers to use a larger fuel tank capacity than is specified by the certifying manufacturer without re-certifying the vehicle. Secondary vehicle manufacturers needing a greater fuel tank capacity must either work with the certifying manufacturer to include the larger tank, or go through the effort to re-certify the vehicle. This provision has not been used and is better handled as part of certification rather than managing a separate process. We are including corresponding changes to the emission control information label.

- We are revising the provisions for setting the vehicle air conditioning controls during the running loss portion of the evaporative emissions test cycle to simply reference the specifications for exhaust emission testing described in 40 CFR part 1066. This allows test labs to use a uniform set of test procedures for setting up test vehicles. This change is expected to have no effect on the stringency of the running loss test.

- EPA regulations at § 86.1824-01 permit manufacturers to develop their full-useful life deterioration factors for evaporative and refueling emission standards based on the use of good engineering judgment. These factors are additive in nature, and when added to the "undeteriorated low mileage" test value the sum must be less than the



applicable emission standard or FEL. Manufacturers usually certify such that this summed value falls below the emission standard or FEL enough to provide a margin for in-use compliance and to address variability and other uncertainty. Regulations (at § 86.1824–08) require that evaporative emissions durability assessments must employ gasoline fuel for the entire mileage accumulation period which contains ethanol in, at least, the highest concentration permissible in gasoline under federal law and that is commercially available in any state in the United States (currently E15). In their comments the Alliance of Automobile Manufacturers and the Association of Global Automakers asked to be able to use evaporative emissions deterioration factors from Tier 2/LEV II assessments even if the assessed or measured full life emission value used to determine the deterioration factor from the Tier 2/LEV II 2 testing is above the Tier 3/LEV III emission standard for the vehicle category of interest. (This situation, which is often referred to as line crossing, is not prohibited in the EPA regulation.)<sup>380</sup> Thus, EPA is permitting the use of this data but requires that: (1) The manufacturers use good engineering judgment in the testing used to develop their deterioration factors and the assessment and application of this data in developing deterioration factors, (2) the manufacturers use the evaporative/refueling emissions test fuel as stipulated in the regulations for Tier 3, and (3) the addition of the deterioration factor to the low mileage test result does not result in an exceedance of the emission standard or the FEL cap for that category of vehicles.

#### *D. Improvements to In-Use Performance of Fuel Vapor Control Systems*

##### 1. Reasons for Adding a Leak Test Standard

As emission standards approach zero, as in the “zero evap” standards discussed above, in-use performance becomes critical for vehicles to meet the standards over their useful life periods and provide the expected emission reductions. Fuel vapor control system leaks are not a new problem, in fact it was one of the main reasons for replacing the canister method for assessing evaporative emissions with the enclosure (SHED test) method used

today.<sup>381</sup> However, as emission standards have become more stringent, test procedures have improved, and vehicle lifetimes have increased, any malfunction or deterioration in the system causes significant emissions increases. Even a small leak can cause large amounts of HC vapor. Therefore, the prevalence of leaks in the fleet can have a significant effect on the average evaporative emissions overall.

As discussed in detail in the NPRM, recent laboratory and field data<sup>382</sup> show very high emissions from vehicles with liquid/vapor leaks. Field studies have indicated approximately 10 percent of overall fleet have significantly elevated evaporative emissions. The studies show that this frequency increases as vehicles age. The Coordinating Research Council (CRC) E–77 programs randomly recruited sixteen vehicles and almost half had some type of leak. Emissions related to these leaks grew in magnitude over the course of the program which lasted a few years. In addition, the EPA recently completed a test program to gather information on running loss emissions with implanted leaks of varying sizes, locations and fuel volatility.<sup>383</sup> Data from this study is not included in the modeling analysis for this final rule, but the results show that there are significant emissions from leaks while driving as the fuel tank temperature rises. Therefore the reductions from the future prevention of leaks will be larger than our current estimates. These data led EPA to examine the OBD-based evaporative system leak data available from I/M programs from several states to more accurately gauge the rate of leaks above the 0.020 inch monitoring threshold met by most manufacturers as a result of

<sup>381</sup> Rarick, T., “Evaporative Emission Enclosure (SHED) Procedure Analysis of Surveillance Program Data,” Evap 75–2, June 1975 and “Investigation and Assessment of Light-Duty Vehicle Evaporative Emission Sources and Control,” EPA–460/3–76–014, June, 1976.

<sup>382</sup> CRC E–77 reports: Haskew, H., Liberty, T. (2008). Vehicle Evaporative Emission Mechanisms: A Pilot study, CRC Project E–77; Haskew, H., Liberty, T. (2010). Enhanced Evaporative Emission Vehicles (CRC E–77–2); Haskew, H., Liberty, T. (2010). Evaporative Emissions from In-Use Vehicles: Test Fleet Expansion (CRC E–77–2b); Haskew, H., Liberty, T. (2010). Study to Determine Evaporative Emission Breakdown, Including Permeation Effects and Diurnal Emissions Using E20 Fuels on Aging Enhanced Evaporative Emissions Certified Vehicles, CRC E–77–2c; DeFries, T., Lindner, J., Kishan, S., Palacios, C. (2011). Investigation of Techniques for High Evaporative Emissions Vehicle Detection: Denver Summer 2008 Pilot Study at Lipan Street Station; DeFries, T., Palacios, C., Weatherby, M., Stanard, A., Kishan, S. (2013) Estimated Summer Hot-Soak Distributions for Denver’s Ken Caryl I/M Station Fleet.

<sup>383</sup> Kishan, S., Sabisch, M., Stewart, J., Glinsky, G. (2014) Running Loss Testing with Implanted Leaks.

CARB’s 2004 model year OBD II requirements.<sup>384</sup> These are important data because even a vehicle with a fuel/evaporative system leak as small as 0.020 inches would be expected to fail the Tier 3 evaporative emission standard in a SHED test and in fact emit 4–5 times above the Tier 3 emission standard on a daily basis due to the number of vehicle trips per day.

We examined data for vehicles meeting CARB’s OBDII evaporative emission leak monitoring requirements as well as either the CARB/EPA enhanced evaporative emission or Tier2/LEV II evaporative emission standards. Since the data were gathered by the states under different protocols and time periods, the content of the data sets is not identical. To provide some degree of uniformity in our analysis, we examined the data for model years 2000 and later, but within each state we only looked at calendar years of data beginning after the initial state I/M exemption period had passed (2–6 calendar years depending on the state). Thus the analysis focused on I/M OBD information for calendar years 2004–2012.

Examined together, the data generally indicate the following.

- For all our States analyzed, the trend lines show that between 2–4 percent of the vehicles entering the I/M program (at about 2 years old) have a “not ready” evaporative monitor. The percentage increased to between 8–11 percent as the vehicle aged to 8 years old with a rate increase of approximately 1 percent per year as the vehicle ages.
- The model years and time periods analyzed for the four States shows approximately 0.7–2.5 percent of vehicles overall with a “ready” evap monitor had one or more stored evap DTCs, indicating a potential evaporative emissions-related problem as defined in the OBD regulations.
- A further review of the data shows that, overall, in the three States with an enforced OBD program approximately 0.7–1.6 percent of vehicles with a “ready” evap monitor had one or more stored evaporative emissions related DTCs. The fourth State, which does not enforce the OBD test, had a higher percentage (2.5 percent) of evap monitor “ready” vehicles that had stored evap related DTCs.
- For the same model years and time periods analyzed for the three States with enforced OBD programs, EPA

<sup>384</sup> Weatherby, M., Sabisch, M., Kishan, S. (2014) Analysis of Evaporative On-Board Diagnostic (OBD) Readiness and DTCs Using I/M Data. Note: the data was presented in a docket memo for NPRM and is now part of a peer reviewed report.

<sup>380</sup> Passavant, G. (December 2013) Background Information on Background Information: Carryover of Emissions Data and Line Crossing. Memorandum to the docket.

estimates about 0.5 percent of vehicles with a “ready” evap monitor evaluated at four years old in an I/M program had a stored DTC. This rate increased at a rate of about 0.15 percent per year and was about 1.1 percent for vehicles at 8 years old. For the fourth state, which does not enforce OBD evaporative results, EPA estimates about 1.4 percent of vehicles evaluated at four years old had a stored DTC. This rate increased at a rate of about 0.5 percent per year and was about 3.5 percent for vehicles at 8 years old.

- Analyzing each state’s data for specific evaporative DTCs, over 50 percent of all evaporative codes were for evaporative system leaks. The second most common category (15–20 percent) involved some sort of error in the operation of the purge flow control which could also contribute to evaporative leaks.

- The monitor “ready” rates are relatively uniform for all States analyzed, but the percentage of evaporative emissions related MILs illuminated and the percentage of evaporative system leak related DTCs were larger in the fourth State. EPA believes this is the case because OBD is advisory only in this State’s I/M program, meaning that a vehicle could pass its I/M requirement with a MIL illuminated and not have to repair it.

In considering this information for the fleet as a whole, a few other factors must be considered. First, a vehicle can pass its I/M requirements (based on provisions of individual State I/M programs) with the evaporative emissions monitor “not ready”. Second, the vehicle can pass with a pending DTC. Third, it is not uncommon for vehicle repair related to an OBD MIL to occur just before I/M visits. Based on factors such as these, the values presented above are likely to be conservative on a fleet average basis. Beyond this, as discussed in the NPRM, earlier research conducted by EPA and the state of Colorado indicated that OBD is not designed to catch every evaporative system leak and sometimes misses leaks it should have found but did not for various reasons (some determined and some unknown).<sup>385</sup> This suggests that overall leak prevalence is higher than indicated by the OBD data alone.

Estimating a nationwide fleet average leak rate is possible with the limited data available if some informed assumptions are made. Only about 24.5

percent of vehicles in the U.S. are in I/M areas and of these only 20.8 percentage points (~4/5) are in areas which rely on OBD as part of the pass/fail protocol. There is at present no data on the prevalence of evaporative system leaks for vehicles in areas without I/M. However, based on these data it is reasonable to assume that the rates in these areas are no less than for areas with I/M (where I/M mandates repair) and are likely similar to or larger than those for the one state analyzed where OBD is advisory only. Under those assumptions, the average leak rate across the country is much higher than for I/M areas alone. For example, if one considers data from the eight year age point in the I/M data for states which require repair, the leak prevalence rate is about 1.4 percent and in the state where OBD is advisory it is 3.5 percent. Weighted by the fleet percentages given above, this indicates a leak rate of about 3.0 percent in the fleet for the eight year age point. This is a conservative estimate based on historic evaporative I/M data.<sup>386</sup>

The propensity for leaks in the vehicle fleet has the potential to reduce the benefits of the Tier 3 evaporative emission standards substantially. If on any given day, as few as 3 percent of Tier 3 vehicles have a leak(s) of 0.020 inches or greater this will cause in-use emissions equivalent to essentially all of the projected emission reductions from the Tier 3 evaporative emission standards on that day.<sup>387</sup>

The leak standard we are adopting will help technology to meet the Tier 3 evaporative emission standards and to improve in use durability. These technology measures (see Section IV.C.3) coupled with the upgrade to the OBD evaporative emissions certification and monitoring requirements to signal problems at smaller threshold diameters (discussed in Section IV.E below) and additions to the IUVP program focused on testing a larger sample of vehicles for fuel/evaporative system leaks in IUVP than for evaporative emission standards alone will help to ensure improved in-use performance of evaporative emission control systems.

Based on the above discussion, there needs to be an increased focus on evaporative emissions durability. Nevertheless, there is no question of the value of OBD leak monitoring for evaporative systems, especially when

owners complete needed repairs in response to the DTCs set. The I/M OBD statistics and associated in-use leak values discussed above would be higher without OBD evaporative system leak monitoring. However, these data suggest that EPA OBD regulations in place for 2004 and later model year vehicles will not alone be sufficient to address concerns regarding the emission effects of vapor leaks from the fuel and evaporative control systems.<sup>388</sup>

In the NPRM, EPA included a substantial discussion of the work we conducted on high evaporative emission rates and our rationale for the need for a leak standard to help address these concerns. No commenter challenged the data or the premises for our conclusion that a leak standard was needed. Manufacturers asked that the leak standard be phased-in with the Tier 3 evaporative emission standards and that use of upgraded OBDII evaporative system monitoring capability be included as part of the in-use verification program (IUVP) provisions. Both elements are contained in this final rule. CARB fully supported the proposed leak standard and test procedure and indicated its intent to adopt such provisions after the Tier 3 FRM is adopted.

## 2. Nature, Scope and Timing of Leak Standard

The evaporative emission standards in this FRM will help to promote widespread use of improved technology and materials which will reduce evaporative emissions in-use. The new requirement for a leak standard and test procedure will help to ensure the durability of Tier 3 evaporative emission control systems nationwide. As discussed in the technological feasibility discussion in Section IV.C above, the actions of manufacturers to meet the Tier 3 evaporative emission standards are expected to address fuel/evaporative system design features which currently have a greater propensity for developing leaks and thus improve in-use durability for evaporative control systems compared to vehicles meeting previous evaporative emission standards. The leak standard will provide added assurance that as the manufacturers design for “zero evap” standards they

<sup>388</sup> Existing OBD regulations specify that if the fuel tank volume exceeds 25 gallons then the manufacturer may seek a larger leak detection orifice value. If a manufacturer seeks and is granted a larger value for OBD leak detection purposes, then that same numerical value becomes the leak standard value. We do not expect this value to exceed 0.040 inches.

<sup>385</sup> Eastern Research Group (2013) Evaluation of the Effectiveness of On-Board Diagnostic (OBD) Systems in Identifying Fuel Vapor Losses from Light-Duty Vehicles.

<sup>386</sup> USEPA (2014), “Development of Evaporative Emissions Calculations for Tier 3 FRM” memorandum to the Tier 3 docket.

<sup>387</sup> See EPA memorandum: “Initial Comparison of Emission Rates from Vehicles with Fuel/Vapor System Leaks to Tier 3 Evaporative Emission Reductions, December, 2013.”

also design the systems to avoid leaks over the full useful life.

Based on the information described above concerning evaporative emissions in-use, we believe a leak standard is necessary to ensure that vehicles meeting Tier 3 evaporative emission requirements not have evaporative emissions in excess of the Tier 3 standards for their full useful life. Toward that end, we are finalizing a leak standard to be met both at new vehicle certification and in use for IUVP testing. The leak standard will apply beginning in the 2017 MY to vehicles in the 20/20 option for that year and in the 2018 MY and later model years to any vehicle certified to the Tier 3 evaporative emission standards or a CARB carryover vehicle counted toward the sales percentage phase-in requirements discussed in Section IV.C, including LDVs, LDTs, MDPVs, and complete HDGVs up to 14,000 lbs GVWR. The standard will be applicable for the same useful life period as for the evaporative emission standards that apply to the vehicle. The standard will apply to vehicles using volatile fuel (e.g., gasoline, FFV, and methanol fuel vehicles), but not diesel or CNG vehicles).

To be compatible with CARB OBD requirements being met by most manufacturers and the OBD requirements included in this rule, we are specifying that the leak standard be expressed in the form of a cumulative equivalent orifice diameter. We are finalizing a value of 0.02 inches.<sup>389</sup> The standard basically requires that the cumulative equivalent diameter of any orifices or “leaks” in the system not exceed 0.02 inches. This is consistent with California OBD requirements (and those being finalized in this rule as well) that the OBD system be capable of identifying leaks in the fuel/evaporative system of a cumulative equivalent diameter of 0.020 inches. EPA believes a standard at this level is feasible since earlier testing programs identified vehicles with essentially no leaks and it is essentially equivalent to that required for CARB OBD evaporative system leak monitoring. We are finalizing a leak standard of 0.02 inches which with rounding is a bit less stringent than the 0.020 inch OBD evaporative system leak monitoring requirement. EPA believes this level of precision is sufficient to

<sup>389</sup> Existing OBD regulations specify that if the fuel tank volume exceeds 25 gallons then the manufacturer may seek a larger leak detection orifice value. If a manufacturer seeks and is granted a larger value for OBD leak detection purposes, then that same numerical value becomes the leak standard value. We do not expect this value to exceed 0.040 inches.

accomplish the air quality objective and yet provides some compliance margin between the standard and the monitor requirement such as is reflected through multipliers for the exhaust emission standards established for other OBD monitors. The leak standard will be specified to one significant digit (e.g., 0.02 inches) but will have to be measured and reported to at least two significant digits.

The leak standard will apply at the time of certification as well as during confirmatory and in-use verification program testing. We do not expect that new vehicles being certified will have a leak problem, and since a vehicle with a leak would likely fail the evaporative emissions SHED test, there is little value in mandating a leak test at certification. Thus, EPA will permit a manufacturer to attest to compliance with the leak standard at certification.

To implement the leak standard within the existing regulatory structure a few minor rule changes are being made. First, existing EPA regulations such as those at § 86.098–24, specify criteria for evaporative/refueling emission families. EPA believes this basic structure is appropriate for the leak standard, with the additional criteria that vehicles in the same evaporative/refueling family must use the same basic approach to OBD leak detection. Significantly different volume fuel tanks would likely also be a family determinant, but we believe this is already covered by the evaporative/refueling family criteria. Second, since the leak standard is a pass/fail requirement and not an emission rate, there is no requirement for the application of a deterioration factor. Third, EPA requires that the manufacturers recommend two or more leak test points for each test group. One of these points should be near the canister/purge valve (ideally in the vapor line between the canister/purge valve and the fuel tank) and the other in the gas cap/fill pipe area. Three points are required for vehicles with two separate evaporative and refueling canisters such as non-integrated ORVR systems which employ two activated carbon canisters and four points are required for vehicles with dual fuel tanks and two separate evaporative/refueling control systems.

EPA believes that linking the timing of the leak standard to the beginning of the phase-in of the Tier 3 evaporative emission standards in the 2018 model year provides adequate lead time and is consistent with the technical rationale supporting the feasibility of the Tier 3 evaporative emission standard.

### 3. Leak Standard Test Procedure

The fundamental concepts underlying fuel/evaporative system leak test are not new to the manufacturers. There is already a simple leak check in 40 CFR 86.608–98(a)(1)(xii)(A) and in the past at least three states included a fuel/evaporative system pressure leak test in I/M programs. More importantly, all LDVs, LDTs, MDPVs and HDGVs manufactured today have the onboard capability to run a pressure or vacuum leak based check on the vehicle’s evaporative emission system as part of OBD evaporative system leak monitoring. These systems employ either positive or negative pressure leak detection pumps or operate based on natural vacuum for negative pressure leak detection. EPA is finalizing a test based on a similar concept of placing the system under a slight positive pressure (but from an external source), measuring the flow needed to maintain that pressure in the fuel/evaporative control system, and converting that flow rate to an equivalent orifice diameter. With regard to the test procedure we will first discuss where the leak test can occur in the FTP test sequence. We will then discuss how the test is to be conducted. EPA proposed this test procedure as part of the NPRM and discussed it extensively in the preamble to the proposed rule, and provided a full draft of the Recommended Practice for comment as an Appendix to the RIA. No comments were received. We are finalizing this test procedure as proposed.<sup>390</sup>

First, when conducted, the leak test should be completed immediately following the first two preconditioning steps within the FTP sequence (see Figure B96–10 in 40 CFR 86.130–96). Thus, the vehicle preconditioning steps for the leak test are: (1) Fill the vehicle fuel tank to 40 percent of capacity using the appropriate certification test fuel and then (2) let the vehicle soak for a minimum of a six hour period at a temperature in the range of 68–86 °F. EPA requires that the test be conducted with 9 RVP E10 test fuel for both certification and IUVP.<sup>391</sup> After preconditioning is complete, the leak test is conducted and the test sequence proceeds as prescribed in subpart B or testing is terminated if the purpose is only to conduct leak testing. EPA

<sup>390</sup> Smith, P. and Passavant, G., “Recommended Test Procedure and Supporting Testing Data for the Evaporative Emissions Leak Test”, December 2013.

<sup>391</sup> This is the same preconditioning that is called for in existing 40 CFR 86 subpart B for exhaust, evaporative, and refueling emissions testing. EPA will consider permitting the leak standard to be evaluated using CARB LEV III test fuel if CARB ultimately adopts this requirement.

believes this modest level of preconditioning is sufficient to create standard conditions which enable repeatable and reliable measurement results. Preconditioning cannot include any prescreening for leaks nor will any tightening of fittings or connections be permitted.

After preconditioning is complete, manufacturers then run the leak test. To fully complete testing on a vehicle, two or more test points are required depending on the fuel evaporative system configuration. All points must pass for the vehicle test to be a pass. As discussed above, one of these points should be near the canister/purge valve (ideally in the vapor line between the canister/purge valve and the fuel tank) and the other in the gas cap/fill pipe area. Three points are required for vehicles with two separate evaporative and refueling canisters such as non-integrated ORVR systems which employ two activated carbon canisters and four points are required for vehicles with dual fuel tanks and two separate evaporative/refueling control systems such as dual tank LDTs. If the fuel/evaporative system has an embedded evaporative system test port then that point can be used. Also, a manufacturer can develop a test rig such as a "fill pipe extension" which screws into the fill pipe opening using cap threads at one end and on the other end has threads to screw the fill pipe vehicle cap in place. Within this extension there must be an access port for the leak test equipment to be attached. Thus, the full system could be tested without any direct intrusion or the need for a separate gas cap assessment. The manufacturer must specify the test points at the time of the pre-certification meeting. If the manufacturer selects an entry point which requires the fuel cap to be removed, then the cap will have to undergo a separate test as is now done in many I/M stations.<sup>392</sup> In this case, tests from both points combined must pass the standard. Manufacturers commented that only one test point was needed, but when asked by EPA they offered no data to counter that provided by EPA in the NPRM which showed the potential for different results at different test point locations for the same vehicle.

The procedure is conducted as follows:

- Calibrate the testing apparatus and otherwise verify testing apparatus is ready and able to complete the procedure.

- Seal fuel system so as to pressure test entire system (purge valve, cap, etc.).
- Attach test apparatus to vehicle's fuel system at selected test point.
- Pressurize fuel system with nitrogen or another inert gas to at least 2.4 kilopascals (kPa).
- Allow flow and pressure to stabilize in accordance with specification provided in the regulatory text.
- Calculate effective leak orifice diameter from measured output flow rate and temperature and pressure data or use apparatus with built in computer providing an equivalent digital readout. Calculate to the nearest 0.01 inch.
- Calculated effective orifice diameter must be less than or equal to the standard.
- If leak test is conducted at the fuel cap opening then the manufacturer must also show evidence that the vehicle's fuel cap is performing properly.<sup>393</sup>
- Use two or more separate test points, near the evaporative canister/purge valve and the other near the fuel cap are required. This is especially important if the fuel cap/fill neck area is isolated from the rest of the fuel/evaporative system as a result of the 40 percent fill or if dual tanks are not otherwise connected through vapor lines.
- Tests can be void if the test apparatus fails, becomes disconnected, fails to maintain a stable flow rate or pressure, or the test was stopped before completion due to safety considerations or some other relevant vehicle issue.
- Leak tests at all points (2 or more depending on the fuel tank/evaporative system configuration) must pass for a vehicle to pass. This includes performance within specification for the fuel cap if it is removed for testing.

The test procedure presented above is based on current fuel system designs. In the future, it is reasonable to expect changes in designs of the fuel systems such that the procedure above may need adjustment. EPA will monitor these fuel system changes and modify the test procedure provisions as needed. Furthermore, existing EPA regulations (see § 1065.10(c)) contain provisions which provide the opportunity for manufacturers to seek approval for special or alternate test procedures if from a practical perspective their

<sup>393</sup> Such tests are done routinely in I/M stations using a commercially available apparatus. The gas cap leak rate may be determined by pressure loss measurement, direct flow measurement, or flow comparison methods and shall be compared to a pass/fail flow rate standard of 60 cubic centimeters per minute of air at 30 inches of water column. The flow rate methods are referenced to standard conditions of 70 °F and 1 atm.

systems cannot be evaluated under EPA requirements or they have an approach deemed equivalent or better. Any such special or alternative procedures must be reported under § 86.004–21(b)(9).

#### 4. Certification and Compliance

As part of the Compliance Assistance Program (CAP 2000) in-use verification program (IUV) <sup>394</sup> the manufacturers began testing the evaporative emissions performance of small samples of in-use vehicles owned and used by the public. These regulations can be found at 40 CFR 86 1845–01, and 1845–04. In 2000, EPA extended this requirement to cover chassis-certified HDVs, which for these purposes are basically all HDGVs up to 14,000 lbs GVWR.<sup>395</sup> The in-use testing for evaporative emissions started in 2004 for 2001 MY LDVs, LDTs, and MDPVs and in 2008 for 2007 MY chassis certified HDGVs. Current IUV data for evaporative emissions (including LDVs, LDTs, MDPVs, and HDGVs up to 14,000 lbs GVWR) covers about 1800 vehicle tests. These data show that when evaluated in the laboratory using certification test procedures, the vast majority (over 95 percent) of the vehicles pass the evaporative emission standards to which they were certified. While this information is indicative of good in-use performance, it has limitations. First, the test results are for small sample sizes. For the approximately 150 million LDVs, LDTs, MDPVs, and chassis-certified HDGVs produced between 2001 (the start of the IUV program) and 2010 (latest available data), only about 0.001 percent of vehicles were tested. Second, the IUV regulations place limits on the age/mileage for vehicle testing. Each model year is tested in two "batches," nominally at the one and four year age points. One year old vehicles must have at least 10,000 miles and four year old vehicles must have at least 50,000 miles with at least one within the higher mileage group having an odometer reading of at least 75 percent of useful life (90,000 miles for most Tier 2 vehicles). With the even longer useful life periods under Tier 3, attention to in-use durability for evaporative systems becomes even more important. Including the leak standard within the IUV protocol, as structured in the discussion below, will provide better information to EPA and manufacturers concerning evaporative system performance and help to focus manufacturer efforts on using designs

<sup>394</sup> See 64 FR 23906 (May 4, 1999).

<sup>395</sup> See 65 FR 59922–59924 (October 6, 2000).

<sup>392</sup> For related information see "IM240 & Evap Technical Guidance", EPA 420–R–00–007, April, 2000.

and hardware with full useful life durability in mind.

#### a. In-Use Verification Program (IUVP) Requirements for the Leak Standard

##### i. Introduction

We believe it is important to identify leaks since vehicles with leaks are expected to have daily emission rates above the Tier 3 evaporative emissions standards, and the recent laboratory and field data<sup>382</sup> suggest a propensity for the diameter of vehicle leak orifice to get larger over time and thus to have even higher emissions. This is also important because evaporative leak emissions occur virtually every day whether the vehicle is driven or not. Thus identifying potential leak problems is important to capturing the emission benefits of the Tier 3 evaporative emission requirements.

Toward that end, EPA is including assessment of compliance with the leak standard within the IUVP program. In developing the proposed rule, we considered expanding the evaporative emission testing portion of the IUVP program as a means to assess leaks, but we decided to focus on the leak standard because it is less burdensome than a full evaporative emissions SHED test and is a cost effective step toward assessing many aspects of evaporative emissions performance in-use.

EPA believes adding a leak test requirement does not create an unreasonable burden. The test procedure described above is simple to run, inexpensive to conduct in terms of equipment and labor, and can be completed relatively quickly compared to an evaporative emissions test. However, we are retaining the evaporative emissions testing requirements currently in IUVP to monitor broader evaporative control system effectiveness (e.g., purge, canister control efficiency, permeation).

##### ii. IUVP Test Requirements

We are requiring that the leak test be conducted for each and every vehicle assessed in IUVP for exhaust emissions under 40 CFR 86.1845–04. This will begin for 2017 MY vehicles meeting the leak standard under the 20/20 option and more fully in the 2018 MY certifications for all test groups meeting the new leak standard. The leak test IUVP requirement includes the low and high mileage tests for any exhaust vehicle evaluated for exhaust emissions plus a requirement that there be at least one representative of each evaporative/refueling/leak family evaluated at each mileage/year point. We are finalizing this approach to implementing IUVP for

the leak standard in lieu of creating a new set of requirements which would require another set of vehicles to be procured for testing. We are not including the leak test with any evaporative emissions test in IUVP, since a leak will be evident in the results of the evaporative emissions test.

The existing IUVP regulations at § 86.1845–04, Table S04–07, call for test sample sizes on a sliding scale based on annual vehicle sales by test group. This can vary from zero for very small sales test groups to six vehicles for test groups with sales exceeding 250,000. There are more exhaust emission test groups than there are evaporative/refueling test families and exhaust emission test groups may cover one or more of the same evaporative/refueling/leak families, so we expect to receive multiple leak test results for most evaporative/refueling/leak families. This will expand the amount of IUVP data we receive in this important area and improve our ability to assess the overall leak performance for a given evaporative/refueling/leak family and the fleet as a whole.

As discussed above, EPA believes that the fuel and evaporative control system leaks are heavily influenced by age as well as design and other factors. EPA asked comment on extending the age point for leak testing for IUVP beyond the four year point to better assess this effect. However, in the past, manufacturers have expressed concern about the implications of testing older vehicles and about finding vehicles still within their warranty and recall liability periods. EPA believes further consideration of longer year test points is merited for exhaust, evaporative, refueling and leak tests but because such a change could potentially affect all four tests we have decided to defer that action to a broader IUVP program review. Extending the time point for the leak test alone would create a different programmatic test burden in terms of more vehicle procurements than the program laid out above.

##### iii. Assessment of IUVP Leak Emission Standard Test Results

The existing regulations contain provisions addressing follow-on testing requirements for exhaust emissions for vehicles which fail to meet various performance thresholds within IUVP (see 40 CFR 86.1846–01). As mentioned above, we expect that it will be common to get more than one leak test result over the course of each model year's mileage testing point for each evaporative/refueling/leak family as a result of the requirement to assess leaks with each exhaust IUVP test. However, the leak

standard is basically pass/fail at 0.02 inches and it is difficult to establish a threshold criteria for a pass/fail standard such as has been done for exhaust emissions where there is a multiplier applied to the level of the individual exhaust emission standard.

Given the importance of the leak standard in assuring in-use evaporative emissions control, we are finalizing a set of criteria for assessing leak standard results from IUVP. These criteria can be summarized as follows for each low and high mileage test point for each model year tested:

- If 50 percent or more of all vehicles evaluated in an evaporative/refueling/leak emission family for any given model year pass the leak standard, testing is complete. This applies to cumulative testing for that family throughout the model year for that mileage group. This is consistent with the exhaust emission requirements for IUVP and EPA believes it is reasonable since vehicles are tested in the "as received" condition from consumers.
- If only one representative of the evaporative/refueling/leak family is tested in a mileage group for that model year's vehicles and it passes the leak standard testing is complete. If that vehicle does not pass the leak standard a manufacturer may test an additional vehicle to achieve the 50 percent rate.

• If an evaporative/refueling/leak emission family fails to achieve the 50 percent rate, it is presumed that the family will enter into In-Use Confirmatory Testing Program (IUCP).

Before IUCP begins, the manufacturer may ask for engineering analysis discussions with EPA to evaluate and understand the technical reasons for the testing outcomes and the implications for the broader fleet. Technical information for these discussions could include but will not be limited to detailed system design, calibration, and operating information, technical explanations as to why the individual vehicles tested failed the leak standard, and comparisons to other similar families from the same manufacturer. Relevant information from the manufacturer such as data or other information on owner complaints, technical service bulletins, service campaigns, special policy warranty programs, warranty repair data, state I/M data, and data available from other manufacturer specific programs or initiatives could help inform understanding of implications for the broader fleet. As part of this process a manufacturer could elect to provide evaporative emissions SHED test data on the individual vehicle(s) that did not pass the leak standard during IUVP.

With an adequate technical basis, the outcome of this engineering analysis discussion could result in an EPA decision not to require IUCP testing.

We will operate within the basic structure of the IUCP program in the existing regulations. Prior to commencing IUCP testing the manufacturer, after consultation with EPA submits a written plan describing the details of the vehicle procurement, maintenance, and testing procedures. This plan could include inclusion of a hot soak plus diurnal SHED test to supplement leak test results. EPA must approve this plan before testing begins. As prescribed in the IUCP regulations for exhaust, if five vehicles are tested and all pass the leak standard then testing will be complete. If all five vehicles do not pass, then five more are tested. More vehicles can be tested at the manufacturer's discretion but all testing must be completed within the time period specified in the regulations. EPA and the manufacturer then enter into discussions regarding interpretation, technical understanding, and compliance/enforcement implications of the test results, if any.

#### iv. Optional Test Procedure Approach for IUVP/IUCP

With the implementation of the OBD regulation changes in Section IV.E below regarding evaporative system leak rate monitoring, EPA is finalizing an optional approach to a portion of the leak test procedure. This optional testing approach is included in the IUVP/IUCP testing program for the leak standard, but will not be used for certification testing for the leak standard. EPA can also use this procedure for conducting compliance assessments. Under this optional approach manufacturers will be able to rely upon the operation of their OBD evaporative system leak detection hardware and operating protocols in lieu of running the stand alone in-use leak test to check for the presence of a 0.02 inch leak in the fuel/evaporative system.

Quite simply, if a vehicle is brought in for IUVP or IUCP testing and a scan tool query of the onboard computer indicates that the vehicle has successfully completed a full OBD-based evaporative system leak monitoring check within the last 750 miles and no evaporative system leak problems for any diameter above 0.020 inches are indicated (no pending or confirmed diagnostic trouble code(s) P0440, P0442, P0446, P0455, P0456, or P0457), the vehicle would be deemed to have met and passed the leak standard test requirement. However, if the system

has not successfully completed a full OBD-based evaporative system leak check within 750 miles with no problem indicated then the manufacturer will have the option to run its OBD-based evaporative system leak check in the laboratory after prescribed preconditioning. This OBD-based approach is sometimes used in auto manufacturer dealerships and repair facilities to diagnose and fix evaporative system leaks found by the OBD system. If the vehicle completes the full OBD-based leak test in the laboratory then the vehicle's pass/fail results for the 0.02 inch cumulative equivalent diameter orifice will be based on the OBD test result. This optional protocol can apply to every leak standard test after certification unless not approved by EPA for IUCP under 40 CFR 1846.01(i). Replicate tests will not be required or allowed but void tests could be repeated.

Furthermore, EPA will permit the manufacturer to run the stand alone EPA leak test in several situations. First, manufacturers can conduct the stand alone test to confirm that a problem identified by the OBD-based evaporative system monitoring leak check is a leak and not a problem with the OBD leak monitor itself. Second, a manufacturer can run the stand alone EPA leak test to confirm that the leak value identified by the OBD system is truly above the level of the leak standard. Third, it can be used for vehicles which have not successfully completed a full OBD-based evaporative system leak monitoring check within the last 750 miles. Fourth, it can be used to confirm that a DTC set within the last 750 miles actually indicates the presence of a leak(s) greater than the standard. However, if a manufacturer elects to use only OBD-based evaporative system leak based monitoring in its IUVP testing; these results will be the basis for decisions regarding IUCP. As required in the existing IUVP regulations, all test data whether OBD based or based on EPA's stand alone test procedure must be reported to EPA.

There may be some advantages to this option since it employs a pressure/vacuum approach manufacturers understand and creates positive/negative pressures manufacturers have accommodated within their fuel/evaporative system. One potential downside is that under current designs vehicle engines will have to be operating to create the pressure or vacuum and because the engine is operating this will require the OBD-based leak test to be stand alone after the preconditioning sequence is complete. This will be more challenging

for natural vacuum leak detection systems unless extended driving is involved to create the fuel system heat needed for a natural vacuum event or this is done through a climate chamber or SHED based diurnal heat build.

Allowing for this approach raises at least two implementation questions. The first is related to the value of conducting the OBD-based test for a vehicle with a confirmed or pending leak DTC already set in the computer and/or an MIL indicated. In this case, EPA will permit the manufacturer to run the OBD-based leak test and/or the stand alone EPA leak test or concede that the vehicle will not pass the leak standard and count the result. Second is the question of gas caps. This is among the most common codes found in OBD records and is often related to operator error such as not tightening the gas cap properly. Codes of this nature have no value in this leak assessment, so a manufacturer will be permitted to correct the problem before testing and clear this OBD code before testing or run the stand alone EPA leak test.

#### E. Onboard Diagnostic System Requirements

##### 1. Onboard Diagnostic (OBD) System Regulation Changes—Timing

EPA first adopted OBD requirements for 1994 and later model year LDVs and LDTs. While EPA has extended its requirements from LDVs and LDTs to larger and heavier vehicles,<sup>396</sup> EPA's last broad upgrade to its basic OBD regulation was in the 2005 timeframe. Since that time, CARB has adopted and the manufacturers have implemented a number of additional provisions to enhance the effectiveness of their OBD programs. These provisions include new requirements for OBD evaporative system leak detection as well as provisions to help insure that systems are built and operate as designed over their full useful life, give reliable results (find and signal only true deficiencies), and operate frequently during in use operation. It is permitted in existing EPA regulations and is common practice for the industry to certify their OBD systems with CARB and for EPA to accept CARB OBD certifications as satisfying EPA requirements. EPA is continuing that practice and we are updating our regulations to be

<sup>396</sup> EPA's OBD regulations for LDVs, LDTs, and MDPVs, are found at 40 CFR 86.1806–05. EPA has also adopted OBD requirements for incompletes and heavier vehicles (greater than 14,000 lbs GVWR) (see 74 FR 8324, February 24, 2009 and 40 CFR 86.010–18).

consistent with the latest CARB regulations.

EPA proposed to adopt, with a few adjustments, the CARB regulatory requirements related to OBD II (see California Code of Regulations (CCR) 1968.2 dated May 18, 2010). We received comment from CARB that since our NPRM was issued, they were completing an update of their OBD II regulations and that EPA should adopt these provisions in lieu of the May 18, 2010 provisions.<sup>397</sup> We have reviewed these updates and concur with the commenters, so we are adopting the provisions officially approved by CARB's Office of Administrative Law on July 31, 2013. We are also adding provisions and continuing the exceptions as discussed below. The changes we are adopting do not include any changes to requirements for engines used in vehicles over 14,000 lbs GVWR or to vehicles over 14,000 lbs GVWR, except for HDGVs optionally certified using chassis procedures. To be consistent with the manner in which the Tier 3 exhaust emission standards are being implemented for the heavy-duty vehicles between 8,501 and 14,000 lbs GVWR, the OBD requirements will be based on the Job 1 (first production) date for the vehicle/engine model. If the vehicle/engine model Job 1 date is before the fourth anniversary date of the signature of the Tier 3 rule the requirements will not be mandatory in that model year. If the Job 1 date is on or after the fourth anniversary of the signature date of the Tier 3 rule the OBD requirements will apply in that model year. The Tier 3 OBD requirements will apply to all 8,501–14,000 lb HDVs in the 2020 model year. To be consistent with the manner in which the Tier 3 exhaust emission standards.

We are taking this approach to OBD for three basic reasons. First, this is consistent with the goal of a national program and one vehicle technology for all 50 states. Second, compliance with the current CARB OBDII requirements is now demonstrated technology, compliance with these requirements is common within the industry today, and we expect that to continue in the future with the 2013 CARB changes. Thus, the added burden is minimal since essentially all manufacturers certify their CARB OBD systems nationwide with EPA. Third, the latest OBD systems run frequently on in-use vehicles to identify potential exhaust and evaporative system performance

problems, so adopting these provisions will create the opportunity for OBD to serve a more prominent role in ensuring the Tier 3 emission standards are met in-use.

Alignment with the existing CARB OBD II requirements will be required by the 2017 MY, except as discussed below. Manufacturers requested a phase-in compliance approach in lieu of a fixed compliance date, but no specific justification was provided by the commenters and EPA could not establish a need for this accommodation since the most recent changes to CARB OBDII regulations (2013) did not meaningfully affect provisions regarding vehicles/engines under 14,000 lbs GVWR which have been in place since 2006. LDVs, LDTs, MDPVs and vehicles under 14,000 lbs GVWR already comply with CARB OBDII requirements and use the CARB certification as the basis for EPA certification.

There is an important link between OBD provisions related to evaporative emission control system leak monitoring and the leak standard. They each provide an important incentive to design fuel/evaporative systems with fewer propensities to develop leaks in use but each addresses the issue from a different perspective. The distinction is that the leak standard prohibits leaks of greater than 0.02 inches cumulative equivalent diameter, while the OBD evaporative system leak monitoring provision requires that the OBD system find leaks larger than 0.020 inches cumulative equivalent orifice diameter and notify the owner, but with no explicit requirement to repair the problem. Thus adopting a 0.020 inch cumulative equivalent orifice diameter aligns these two programs and, as discussed above, facilitates the use of OBD evaporative system leak monitoring hardware/strategy as an optional leak detection test procedure for in-use testing.

With regard to OBD evaporative system leak detection, EPA received comment that we should permit a phase-in for compliance with the 0.020 inch evaporative system leak monitoring requirement. Even though the 0.020 inch leak monitoring requirement has been in place since the 2004MY for CARB OBDII, and essentially manufacturers have met it for years, the existing EPA regulation actually only requires monitoring at the 0.040 inch threshold level. After considering the comments received, EPA is permitting a limited and minimal phase-in for the 0.020 inch leak detection criterion for the OBD evaporative system monitoring requirement. We are permitting this phase-in, because a few vehicle models

still only meet the 0.040 inch monitoring threshold in their Federal configuration and complying with the 0.020 inch CARB OBD II requirement entails validating performance in high altitude and cold weather regimes not seen in California. Thus, the 0.020 inch requirement would be new for those few models currently certified only to the EPA evaporative leak monitoring requirement. We are, therefore, implementing the following phase-in provision for the 0.020 inch leak detection criterion for the OBD evaporative system monitoring requirement. First, if a vehicle model meets the 0.020 inch requirement in the 2016 model year it is not eligible for the phase-in provision. No backsliding is permitted. Second, for manufacturers with models not meeting the CARB OBDII evaporative system leak monitoring requirement in the 2016 MY (see 13 CCR 1968.2(e)(4)), they will be permitted to delay product-wide compliance with the 0.020 inch leak provision of the evaporative system monitoring requirements until the 2018 model year by engaging in a voluntary early phase-in. This phase-in would begin in the 2016 model year and conclude in the 2018 model year at a 100 percent implementation rate. For example, a manufacturer could delay attaining 100 percent compliance with the OBD evaporative system leak monitoring requirement until the 2018 model year by complying in the 2016 model year using a percentage which is at least as large as the delay for the 2017 model year (e.g., 40% in 2016 MY, 60% in 2017MY, and 100% in 2018MY).

## 2. Revisions to EPA OBD Regulatory Requirements

As discussed above, we are updating our OBD regulations to be consistent with current California OBD II requirements. We are incorporating by reference section 1968.2 of the California Code of Regulations as adopted July 31, 2013 (13 CCR 1968.2). This includes paragraphs (c) through (j) in their entirety. These paragraphs are entitled: (c) Definitions, (d) General Requirements, (e) Monitoring Requirements for Gasoline/Spark Ignited Engines, (f) Monitoring Requirements for Diesel/Compression Ignition Engines, (g) Standardization Requirements, (h) Monitoring System Demonstration Requirements for Certification, (i) Certification Documentation, (j) Production Vehicle Evaluation Testing. The substance of many of these provisions is already contained in existing EPA OBD requirements for LDVs, LDTs, MDPVs, and complete HDGVs less than 14,000

<sup>397</sup> The latest update of CARB's OBD regulations was adopted on July 31, 2013. See section 1968.2 at <http://www.arb.ca.gov/msprog/obdprog/obdregs.htm/>.



lbs GVWR.<sup>398 399</sup> EPA will continue to accept certifications with CARB OBD requirements as satisfying EPA OBD requirements.

The most noteworthy changes we are finalizing are summarized below. The CCR below is the California Code of Regulations cite for each pertinent provision.

- EPA is adding a 0.020 inch leak detection monitoring threshold upstream of the purge valve for all 4 vehicle categories LDV, LDT, MDPV, and complete HDGVs up to 14,000 lbs GVWR except for those with fuel tanks larger than 25 gallons capacity (see 13 CCR 1968.2(e)). OBD leak monitoring systems will have to identify, store, and if required signal *any* leak(s) equal to or greater than 0.020 inches cumulative equivalent diameter. This will thus include diagnostic trouble codes (DTC) P0440, P0442, P0446, P0455, P0456, and P0457.

- EPA is incorporating by reference the full array of rate based monitoring requirements (see 13 CCR 1968.2 (d)(3)–(6)). Meeting the rate based monitoring requirements will help to insure that, even with enable criteria, the exhaust and evaporative system monitors run frequently enough that on average a problem would be identified and signaled to the owner in operation within two weeks. This will help to improve the fraction of time monitors are ready to find a potential problem.

- EPA is incorporating by reference provisions regarding monitoring system demonstration requirements for certification. We are incorporating by reference CARB provisions in this area and accepting submissions to CARB for purposes of compliance demonstration (see 13 CCR 1968.2(h)). Adopting current CARB monitoring system demonstration requirements assures that monitoring systems operate as designed when installed on certification vehicles.

- EPA is incorporating by reference the CARB production vehicle evaluation data program. This program requires manufacturers to demonstrate that the OBD system functions as designed and certified when installed on production vehicles. (See 13 CCR 1968.2(j)).

In addition, we are adding two new requirements, and retaining three minor exceptions. Each of these actions is described separately below.

- We are adding the requirement that before certification a manufacturer must demonstrate the ability of its OBD leak

monitoring system to detect and report a 0.020 inch leak in the fuel/evaporative system. Current CARB protocols within 13 CCR 1968.2(h)(3) do not require this demonstration as part of certification. This requirement helps to ensure the OBD system's capability to function as designed and the OBD-based evaporative system leak monitoring hardware to be used as an optional test procedure for IUVP testing for the leak standard. This requirement being added for the same vehicles that are subject to monitoring system demonstration requirements for certification under CARB OBD regulations under 1968.2(h)(3).<sup>400</sup> EPA test procedures are contained in 40CFR 86.1806–17(b). In the spirit of aligning CARB and EPA OBD provisions, if CARB ultimately adopts this demonstration requirement and CARB's test procedure provisions fulfill the purpose of the EPA requirement, EPA will strongly consider proposing to adopt the CARB test procedures in lieu of those in 40 CFR 86.1806–17(b).

This requirement applies to any vehicle test group certified to the OBD 0.020 inch evaporative system leak monitoring requirement. Since the regulation requires only a relative few test groups each model year per manufacturer, we will permit the manufacturers either to meet the requirement for the remainder of its test groups on production vehicles of a previous model year which used the identical monitoring hardware and strategies or to certify by attestation that each of their remaining test groups meets the requirement based on development, calibration, and other information. If a manufacturer chooses to certify by attestation for some test groups for a given model year, the regulations are structured such that over several model years a manufacturer would evaluate through testing all test groups as new groups are selected in subsequent model years.

- For the OBD evaporative system leak monitoring requirement, EPA is establishing a requirement for a scan tool readable function (a new InfoType \$14 in Service \$09 of SAE J1979DA) which can be used to obtain the distance traveled since the OBD leak monitoring diagnostic was last completed successfully, i.e., the system passed or failed (identified any leak above 0.020 inches) during that monitoring event (unless it is otherwise already required in other OBD system

modes). The purpose of this requirement is to facilitate implementation of the leak standard within IUVP, by permitting the use of OBD evaporative system monitoring results as a tool to make pass/fail determinations during IUVP. As discussed in section IV.D above, if a vehicle successfully completed an evaporative system leak monitoring within the most recent 750 miles then the manufacturer could use this result for its IUVP requirement for the leak standard. EPA asked for comment on how best to implement this requirement within the OBD system, in what model year(s) it should be required and to which vehicle classes it should apply.

Manufacturers supported this requirement, and suggested a lower cost approach which we are adopting in the final rule. Rather than requiring that the distance and monitoring results be stored in NVRAM to avoid false results based on a user induced code clear or battery disconnect, the manufacturers suggested that the “distance since evap monitoring decision” InfoType be reset to the maximum value (\$FFFF/65,535km) when codes are cleared or after a reprogramming event (e.g., battery disconnect). The InfoType would be reset to zero km when an evaporative monitoring pass/fail decision is later made, allowing the mileage to be read directly at IUVP. In the usual situation where no user induced code clear or reprogramming event (e.g., battery disconnect) occurred, the mileage since the last decision could be read directly. In either circumstance, the presence of an evaporative system leak related DTC (P0440, P0442, P0446, P0455, P0456, and P0457 or manufacturer specific equivalent DTC) will indicate a failure and the lack of such a DTC will indicate a pass. The mileage and the pass/fail results will then be taken together for purposes of the 750 mile option in the IUVP assessment for the leak standard.<sup>401</sup>

This requirement applies to all vehicle categories subject to the leak test including LDVs, LDTs, MDPVs, and complete HDGVs less than 14,000 lbs GVWR. Manufacturers commented that this requirement should apply only to vehicles/test groups meeting the leak standard. Since the leak standard phases-in between 2018 and 2022 model years (2017 for manufacturers using the 20/20 evaporative emission option), a manufacturer may phase-in compliance with this requirement as well.

<sup>398</sup> MDVs in the CARB regulations basically incorporate MDPVs and complete HDGV less than 14,000 lbs GVWR as defined by EPA.

<sup>399</sup> We are not changing the requirement for incompletes and vehicles with a GVWR above 14,000 lbs.

<sup>400</sup> Passavant, G. (January, 2014). “Development of 0.020” Evaporative Leak Monitoring System Demonstration Requirement Test Procedure”. Memorandum to the docket.

<sup>401</sup> Passavant, G. (January, 2014). “Manufacturer Input on Distance Since Last Evaporative Monitoring Decision”. Memorandum to the docket.

• The minor exceptions which are contained in EPA's existing OBD regulations are to be continued. Compliance with 13 CCR 1968.2(d)(1.4), pertaining to tampering protection is not required. Also, the deficiency provisions of 13 CCR 1968.2(k) are not being adopted. In addition, demonstration of compliance with 13 CCR 1968.2(e)(15.2.1)(C), to the extent it applies to the verification of proper alignment between the camshaft and crankshaft, will apply only to vehicles equipped with variable valve timing. For all model years, the deficiency provisions of paragraph (i) of the existing EPA regulations apply only to alternative fuel vehicle/engine manufacturers selecting this paragraph for demonstrating compliance.

These changes, taken together will improve the performance, reliability, general utility, and effectiveness of OBD systems for Tier 3 exhaust and evaporative emission controls. Furthermore, these changes create the opportunity for OBD evaporative system leak monitoring systems to serve a more prominent role in ensuring compliance with the leak standard. EPA believes that they can be implemented for minimal cost since most manufacturers are meeting them today and will have to for LEV III vehicles. The provisions we are incorporating by reference give manufacturers the flexibility to seek a revision to the emission threshold for a malfunction on any diagnostic required if the most reliable monitoring method developed requires a higher threshold to prevent significant errors of commission in detecting a malfunction.<sup>402</sup> Any decision on a potential exception would be preceded by a consultation between EPA and CARB.

As discussed below, the OBD requirements will apply to small entities in the 2022 model year, if they choose to take advantage of one of the revised implementation schedules for small volume manufacturers and small businesses. However, as is the case for larger manufacturers, no backsliding is permitted meaning that if they voluntarily meet the OBD requirements on their Federal configurations in the 2016 model year as a result of compliance with CARB regulations they must continue to meet the requirements on the Federal configurations in the 2017 and later model years. Small alternative fuel converters will still be able to meet the OBD requirements using the provisions of 40 CFR 85, subpart F. Finally, it should be noted that as CARB updates its OBD regulations in the future EPA will

consider these changes and propose to adopt them or incorporate them by reference, if appropriate.

### 3. Provisions for Emergency Vehicles

It is common for emergency vehicles such as law enforcement, medical response, and fire protection vehicles operated by government entities to be derived from similar publicly available vehicle configurations. However, these vehicles often have chassis configurations, auxiliary equipment packages, and performance requirements different from the standard publicly available configurations. These emergency response vehicles typically meet the various EPA emission standards based on the engineering calibrations and emission control hardware used in the publicly available configuration. OBD requirements also apply to these vehicles and occasionally their unique design and/or operating characteristics may prevent them from meeting one or more of the various OBD requirements.

In comments on the NPRM, one manufacturer raised a concern that EPA's proposed adoption of the current CARB OBDII requirements for the 2017 model year would create a compliance problem for two of their law enforcement vehicle configurations. These two vehicle configurations cannot meet one element of the current CARB OBDII requirements (CCR 1968.2(e)(6.2.1)(C)) without compromising the performance expected by law enforcement personnel.<sup>403</sup> To address this issue CARB provided these vehicles an exemption from this provision, by permitting it to meet Federal requirements as permitted by the California Vehicle Code. This solved the problem because the CARB OBD II provision of interest did not exist within the Federal OBD requirements at that time.

This raises both a near term and a broader policy issue related to emergency vehicles. First, we are incorporating a definition for emergency vehicle that is specific to the Tier OBD requirements.<sup>404</sup> Second, with regard to the two law enforcement vehicle configurations identified by the manufacturer, EPA has reviewed the manufacturer's technical information and agrees with CARB's previous

<sup>403</sup> See Ford Motor Company comments on the Tier 3 NPRM at EPA/HQ/OAR/2011/0135/4349.

<sup>404</sup> For the Tier 3 OBD requirements, emergency vehicle means a motor vehicle manufactured primarily for use as an ambulance or combination ambulance-hearse or for use by the United States Government or a State or local government for fire protection or law enforcement.

assessment.<sup>405</sup> Thus, EPA will grant the manufacturer a three model year exemption from the requirement as requested by the manufacturer (MY2017–2019 inclusive). Specifically, we are delaying the need to comply with the requirements of CCR 1968.2(e)(6.2.1)(C)—incorporated by reference by EPA—until the 2020MY for any emergency vehicle which does not meet the requirement in the 2016 model year. This specifically applies to the two test groups identified by the commenter. Second, in a broader context, there is a need to address the potential future need for a deficiency or an exemption for emergency response vehicles. If CARB grants a deficiency for emergency response vehicles under CCR 1968.2(k) we would expect this to be done in consultation with EPA. Furthermore, we are incorporating provisions to address a potential situation where an emergency vehicle needs a deficiency (a temporary or permanent allowance for manufacturers to be non-compliant with a specific requirement of the OBD regulations as long as certain requirements are met) or exemption which is not addressed by CARB under CCR 1968.2(k). EPA is adopting a provision which authorizes us to address these circumstances based on an application from the manufacturer. Under this provision, EPA may approve a request for a deficiency or in extreme circumstances a temporary or potentially permanent exemption from a given OBD requirement. In considering decisions to approve/disapprove this request, EPA will consider the provisions of CCR 1968.2(k)(1) plus engineering information and vehicle emission and performance data provided by the manufacturer which demonstrates significant vehicle engineering or system performance issues (e.g., vehicle speed, acceleration, handling, safety, fuel economy, cost) related to complying with the OBD requirements.

### 4. Future Considerations

EPA and CARB coordinate closely on OBD II requirements. When changes to the requirements occur, CARB provisions often precede those from EPA. Since LEV III begins before Tier 3, EPA expects that CARB will revise any OBD II requirements related to the LEV III before EPA would do so for Tier 3. EPA expects to work with CARB on any potential changes to OBD II requirements related to LEV III and to consider proposing such changes in a

<sup>405</sup> Passavant, G. (January, 2014). Information Related to CARB AFRIM OBD Requirements for Emergency Vehicles. Memorandum to the docket.

<sup>402</sup> See 13 CCR 1968.2(e)(17).

future action since we expect great commonality between Tier 3 and LEV III exhaust and evaporative emission control systems. Two presentations related to CARB's initial thinking for LEV III related OBDII revisions are available in the docket.<sup>406</sup> In the interim, for any Tier 3 exhaust emission bin which does not have a corresponding bin value in the Tier 2 program, the threshold for the exhaust emission malfunction criteria is that of the next higher bin in the Tier 2 regulation as prescribed for the latest model year in CCR 1968.2(e)(1)–(3).

In the NPRM, EPA discussed the basics of evaporative emission control technology and laid out concerns regarding the loss of evaporative and refueling emission control which occurs if a canister is not purged. This can potentially occur if the purge hardware fails or if the flow of purge air through the canister is impeded by foreign matter collecting at the inlet port or on the carbon itself, canister poisoning due to fuel or water intrusion, or activated carbon breakdown from phenomena such as road vibration. Failure of purge hardware is already covered by OBD and a recent study indicates that this is a relatively rare evaporative system problem.<sup>407</sup> Failure of the activated carbon to purge due to problems such as those mentioned above are not covered by OBD. EPA is undertaking a study to better characterize the causes and frequency of such potential problems, and may propose in a future rulemaking an OBD-based monitoring requirement related to activated carbon/canister capture should the study indicate a significant frequency of loss of canister efficiency in-use and loss in emissions control relative to other evaporative system failure modes.

In the NPRM we also asked for comment on several other issues related to the role of OBD in future technology fuel/evaporative control systems. This included pursuing a monitoring threshold less than the 0.020 inches cumulative diameter that we are finalizing in this rule for non-pressurized and pressurized fuel systems. We asked about the feasibility and cost of requiring the OBD leak detection monitoring system to detect and signal the presence of a smaller diameter orifice, such as 0.010 inch upstream of the purge valve for a

pressurized system with a designed in-use operating pressure threshold in excess of 0.36 psi (10 inches water). Also, for the pressurized system, we asked for comment on a potential provision to require that the fuel tank vent to the canister at key off if the OBD system identifies a leak. In their comments manufacturers indicated concerns about the need for such provisions or their value in reducing emissions relative to current requirements. EPA believes both of these provisions merit further investigation, but at the present time we lack the data to assess the feasibility and emission reduction benefits associated with each approach and so are not taking action on them.

Finally, in the NPRM we sought input on whether the operation of a vacuum pump or similar device used to assist or supplement vehicle engine vacuum purge or any device otherwise used to enhance or control purge flows, rates, or schedules should be required to be monitored as part of OBD. In their comments the manufacturers indicated their view that this would be covered by current OBD provisions, and we are not taking further actions.

#### *F. Emissions Test Fuel*

In-use gasoline has changed considerably since EPA last revised specifications for the gasoline used in emissions testing of light- and heavy-duty vehicles. Sulfur and benzene levels have been reduced and, perhaps most importantly, gasoline containing 10 percent ethanol by volume (E10) has replaced non-oxygenated gasoline (E0) across the country. This trend has had second-order effects on other gasoline properties. In-use fuel is projected to continue to change as refiners adjust their gasoline production to reflect the renewable fuel volumes required under the RFS2 program, as well as further sulfur reduction under the Tier 3 rule.<sup>408</sup> As a result, we are updating federal emission test fuel specifications to better match in-use fuel. The revised test fuel specifications apply for exhaust emissions testing, fuel economy/greenhouse gas testing, and emissions testing for non-exhaust emissions (with some exceptions discussed elsewhere in this preamble, e.g., for refueling tests in flex-fuel vehicles). The revised gasoline specifications, found at § 1065.710 and discussed below, apply to emissions testing of light-duty cars and trucks as well as heavy-duty gasoline vehicles certified on the chassis test, where the

vehicles are certified to the Tier 3 standards.<sup>409</sup>

#### 1. Gasoline Emissions Test Fuel: Ethanol Content and Volatility

##### a. Emission Test Fuel Ethanol Content

In the NPRM, EPA proposed that the emissions test gasoline be changed from E0 to E15 as a forward-looking position based on indications following the 2011 E15 waiver decision that the market would move in that direction.<sup>410</sup> Since the time when we developed the proposal, several relevant factors have led EPA to reconsider that position, including limited proliferation on a national scale of stations offering E15 and the complexities E15 test fuel would introduce for long-term harmonization of the Tier 3 vehicle emission regulations with California's LEVIII program (which uses E10 for emissions testing).

We received comments supporting use of E10 as emissions test fuel from the automotive and oil industries, as well as states and NGOs citing the fact that this was most representative of current market conditions. Other stakeholders involved in fuel marketing and distribution cited significant infrastructure cost and liability concerns in making E15 widely available at existing stations. Ethanol industry commenters generally supported E15 certification fuel as proposed, but provided no specific timeline on which this blend level would become representative of in-use fuel. The most recent surveys of the market show that E10 now comprises nearly 100% of in-use gasoline, with very small amounts of E0 and E15 being sold in limited areas where there is specific interest.<sup>411</sup> Based on this information and considering comments, EPA is finalizing

<sup>409</sup> As discussed elsewhere in Section IV, we are also generally requiring the use of Tier 3 test fuel in conducting exhaust, evaporative, and refueling emissions testing of heavy-duty gasoline engines certified on an engine dynamometer. These could include engines installed in incomplete Class 2b and Class 3 vehicles and engines used in vehicles above 14,000 lb GVWR.

<sup>410</sup> EPA issued a waiver allowing E15 to be introduced into commerce for use in MY 2001 and newer light-duty motor vehicles. On July 25, 2011, EPA finalized regulations to mitigate the potential for misfueling of vehicles, engines, and equipment not covered by the E15 waiver, i.e., MY 2000 and older light-duty motor vehicles, all heavy-duty gasoline vehicles and engines, motorcycles, and all gasoline-powered nonroad products (which includes boats).<sup>410</sup> Two of the required mitigation measures are a label for fuel pumps that dispense E15 to alert consumers to the appropriate and lawful use of the fuel and a prohibition on the use of E15 by consumers in vehicles not covered by the waiver, excluding flexible fuel vehicles (FFVs). For more details, see 76 FR 44406 (July 25, 2011).

<sup>411</sup> More detail on fuel survey data is available in Chapter 3 of the Regulatory Impact Analysis.

<sup>406</sup> McCarthy, M., "CARB Light-duty OBD Regulation Update", SAE 2012 Onboard Diagnostics Symposium, Nov 2012 and Remenus, M., "CARB Light-duty OBD Regulation Update", SAE 2013 Onboard Diagnostics Symposium, September 2013.

<sup>407</sup> Weatherby, M., Sabisch, M., Kishan, S. (2014) Analysis of Evaporative On-Board Diagnostic (OBD) Readiness and DTCs Using I/M Data.

<sup>408</sup> See 78 FR 49794 (August 15, 2013) for the latest renewable fuel requirements under the RFS2 program.

E10 as the ethanol blend level in emissions test gasoline for Tier 3 light-duty and heavy-duty gasoline vehicles. We will continue to monitor the in-use gasoline supply and based on such review may initiate rulemaking action to revise the specifications for emissions test fuel to include a higher ethanol blend level.

As discussed above in Sections IV.A.7.d (tailpipe emission testing) and IV.C.5.b (evaporative emission testing), we are requiring all light-duty and chassis-certified heavy-duty gasoline vehicles to be certified to Tier 3 standards on federal E10 test fuel. As described in those sections, EPA will accept emission certification test results performed according to CARB's LEVIII procedures including CARB's E10 test fuel. Confirmatory and in-use exhaust or evaporative testing of vehicles certified on CARB's E10 test fuel will be performed using that same test fuel through MY 2019. After MY 2019, EPA will continue the practice of accepting emission data at certification on the LEVIII test fuel; however confirmatory and in-use testing may be performed using Tier 3 E10 test fuel at the discretion of the Agency.

#### b. Certification Fuel Volatility (RVP) Specification

In deciding to finalize E10 as the emissions test fuel it is appropriate to consider whether a change in the volatility of the test fuel is warranted, typically expressed as in pounds per square inch (psi) Reid Vapor Pressure (RVP) or dry vapor pressure equivalent (DVPE). The Clean Air Act (Section 211(h)(1)) sets a national limit on summertime RVP in northern conventional gasoline areas of 9.0 psi to control ozone pollution. However, Congress included a waiver allowance (Section 211(h)(4)) granting an additional 1 psi RVP to 10% ethanol blends, meaning that E10 could have an RVP up to 10 psi in these conventional gasoline areas unless specifically prohibited by state or local rules. Under Section 211(h)(4), E15 is not covered by the waiver and thus is restricted to 9 psi nationwide.

The automakers submitted comments that recommended leaving the RVP of emissions test fuel at 9 psi on the basis that raising the specification to 10 psi would increase the stringency of the proposed evaporative emission standards significantly. We agree that the resulting increased vapor generation rates during the refueling test would increase emissions (by about 10 percent and during the hot soak, diurnal, canister bleed, and running loss tests by as much as 25 percent in total). While

the likely increase in canister volume in response to higher certification fuel RVP would not be difficult for automakers to accommodate in most cases, there are additional uncertainties regarding cost and feasibility of strategies for removing the larger vapor loads from the canister during vehicle operation (vapor "purging"). Some vehicles have adequate engine vacuum available to accomplish the increased vapor purge, while others may require new or innovative approaches to increase purge volume or efficiency (as discussed in the evaporative emissions technology discussion in Section IV.C.3).

Several other commenters, such as NGOs and environmental groups, supported setting certification gasoline RVP to 10 psi to be representative of the worst-case volatility vehicles may see in the market, making the test procedure more stringent than in the proposed program and further reducing evaporative emissions.

Raising the certification test fuel RVP to 10 psi would also impact the equivalency of CARB and EPA hot soak plus diurnal evaporative emission test procedures. (California requires the use of 7 psi RVP test fuel, which, in conjunction with higher test temperatures, produces equivalent results to the federal test procedures using 9 psi fuel.) If we were to adopt 10 psi test fuel, we would likely need to develop and adopt new test procedure adjustments in order to maintain the equivalency of CARB and EPA evaporative procedures (and allow reciprocal acceptance of test data generated under either agency's program).

In addition, the 1 psi RVP waiver for E10 does not apply to gasoline with higher ethanol levels; for example, under current regulations E15 is subject to an RVP limit of 9 psi. If EPA had adopted 10 psi test fuel in this rule and if gasoline with higher ethanol levels than E10 were to become commonly used nationwide, maintaining alignment with in-use fuel could necessitate a change in emissions test fuel back to 9 psi.

A review of 2011 gasoline batch data submitted to EPA shows that just under half of summertime gasoline was conventional gasoline at 10 psi RVP. An additional third was RFG at approximately 7 psi RVP, with the remainder having intermediate RVPs under local volatility control programs. A volume-weighted average of these data is approximately 8.7 psi RVP. Thus, an emissions test gasoline volatility at 9 psi aligns well with the average nationwide in-use RVP today. In addition, virtually all of the areas that

have elevated summertime ozone levels where excess evaporative VOC emissions would be of greatest concern already control in-use gasoline RVP to levels less than 9 psi. Furthermore, under section 211(a)(5), governors can request that the 1 psi waiver for E10 not apply in their state if it causes an emissions increase that contributes to air pollution. Any state exercising this authority would have in-use E10 RVP levels limited to 9 psi.

After considering these technical and policy issues in the context of the information available and comments received, we conclude that the most appropriate approach is to set an RVP of 9 psi for Tier 3 emissions test fuel.

#### c. Durability Test Fuel

EPA's motor vehicle emissions standards typically require a level of performance over a specified test procedure, with emissions measured while the engine or the vehicle is operated using the specified test fuel and operated in a specified manner. The test fuel specifications typically apply for all emissions testing used to determine compliance with the standard, including emissions testing to obtain a certificate of conformity, as well as compliance testing for newly produced or in-use engines or vehicles. While this test fuel is sometimes referred to as "certification fuel," the test fuel specifications are not limited to certification related emissions testing, but also apply to compliance related emissions testing after the certificate of conformity has been issued. The certification process also typically involves a process to ensure that the emissions controls system is durable over the regulatory useful life of the vehicle or engine. This can involve long-term or accelerated aging of a vehicle or engine prior to emissions testing. The fuel used for such aging is commonly referred to as service accumulation or durability fuel, and in many cases is specified as commercial gasoline that will be generally available through retail outlets (§ 86.113–04(a)(3)), or in some cases may be specified as gasoline which contains ethanol in, at least, the highest concentration permissible in gasoline under federal law and that is commercially available in any state in the United States, such as for durability aging of evaporative emissions system (§ 86.1824–08(f)). EPA is not changing the specifications for fuel used during durability related aging that is part of the certification process. The regulatory changes in this final rule only apply to the test fuel used during emissions

testing, both for purposes of certification and for later compliance related testing.

We are not changing the exhaust or evaporative durability fuel requirements outlined in the provisions of § 86.113–04(a)(3), except to remove the minimum sulfur content (15 ppm) specified at § 86.113–04(a)(3)(i). Those provisions require that “[u]nless otherwise approved by the Administrator, unleaded gasoline representative of commercial gasoline that will be generally available through retail outlets must be used in service accumulation.” We expect that manufacturers will use service accumulation fuels that are generally representative of the national average in-use fuels (or worst case for durability) during the model year which is being certified, including, for example, the ethanol content (for exhaust emissions), sulfur level, and fuel additive package. For exhaust emission bench aging durability programs as allowed under the provisions of § 86.1823–08(d) and (e), the bench aging program should be designed using good engineering judgment to account for the effects of in-use fuels on exhaust emissions, including the effects of future in-use fuels on catalytic converters, oxygen sensors, fuel injectors, and other emission-related components.

For evaporative emissions, durability fuel requirements are the same as for exhaust emissions (as outlined above), plus an additional requirement in the provisions of § 86.1824–08(f), that the service accumulation fuel “contains ethanol in, at least, the highest concentration permissible in gasoline under federal law and that is commercially available in any state in the United States. Unless otherwise approved by the Administrator, the manufacturer must determine the appropriate ethanol concentration by selecting the highest legal concentration commercially available during the calendar year before the one in which the manufacturer begins its mileage accumulation.” Thus, we expect that E15 service accumulation fuel will be used for whole vehicle evaporative durability programs. Similarly, evaporative bench aging durability programs allowed under the provisions of § 86.1824–08(d) and (e), should be designed using good engineering judgment to account for the durability effects of in-use fuels on evaporative emissions, bleed emissions, and leakage emissions.

## 2. Other Gasoline Emissions Test Fuel Specifications

Where possible, we are changing test fuel specifications to be consistent with

CARB’s LEV III gasoline test fuel specifications.<sup>412</sup> In addition to the ethanol and volatility specifications discussed above, below is an overview of some of the key changes. Table IV–26 provides a summary of the new test fuel properties. For more information on how we arrived at the test fuel property ranges and ASTM test methods, refer to Chapter 3 of the RIA.

- *Octane*—lowering gasoline octane to around 87 (R+M)/2 to be representative of in-use fuel, i.e., regular-grade E10 gasoline. Manufacturers can continue to use high-octane gasoline for testing of premium-required<sup>413</sup> vehicles and engines as well as for testing unrelated to exhaust emissions. Historically, the high octane rating of test fuel has not had any real emissions implications. However, as manufacturers begin introducing new advanced vehicle technologies (e.g., turbocharged/downsized), this may no longer be the case. For those vehicles where operation on high-octane gasoline is required by the manufacturer, we are allowing the manufacturer to test on a fuel with a minimum octane rating of 91 (R+M)/2 (in lieu of the 87 (R+M)/2 specified for general test fuel). According to the regulations found at § 1065.710(d), vehicles or engines are considered to require premium fuel if they are designed specifically for operation on high-octane fuel and the manufacturer requires the use of premium gasoline as part of their warranty as indicated in the owner’s manual. Cases where premium gasoline is not required but is recommended to improve performance would not qualify as a vehicle or engine that requires the use of premium fuel. For qualifying vehicles and engines, all emission tests must use the specified high-octane fuel. For vehicles and engines certified on high-octane gasoline, all EPA confirmatory and in-use testing would also be conducted on high-octane gasoline. All other test fuel specifications are the same as those described in Table IV–26.

- *Distillation Temperatures*—adjusting gasoline distillation temperatures to better reflect in-use E10 gasoline. This includes minor T10, T90 and FBP adjustments based on AAM fuel surveys and refinery batch data. These data show that T50 varies widely in in-use fuel, from around 150 °F to 220 °F. Adopting a wide specification range for test fuel may have undesirable effects on consistency of results between

facilities and over time. Therefore, we have chosen a range of 190–210 °F to maintain some overlap with CARB’s specification of 205–215 °F but extending somewhat lower to better capture federal in-use fuel. For more information on how we arrived at the distillation temperatures in Table IV–26, refer to Chapter 3 of the RIA.

- *Sulfur*—lowering the sulfur content of test fuel to 8–11 ppm to be consistent with our new Tier 3 gasoline sulfur standards. The 10 ppm annual average sulfur standard for in-use gasoline standard is expected to result in two-thirds less sulfur nationwide so it is appropriate to lower the gasoline test fuel specification in concert.

- *Benzene*—setting a benzene test fuel specification of 0.5–0.7 volume percent to represent in-use fuel under the MSAT2 regulations.<sup>414</sup> The MSAT2 standards, which took effect January 1, 2011, limit the gasoline pool to 0.62 volume percent benzene on average.

- *Total Aromatics*—lowering the range of aromatics content in the test fuel to better match today’s in-use E10 gasoline, and narrowing the range to limit variability of results. Data from recent gasoline batch data as well as AAM surveys support a specification of 22–26 volume percent.<sup>415</sup>

- *Distribution of Aromatics*—in addition to total aromatics and benzene, the updated test fuel requirements place boundaries on the distribution of aromatics by carbon number (i.e., prescribed volume percent ranges for each of C7, C8, C9, and C10+ hydrocarbons). There is evidence that the heaviest aromatics in gasoline contribute disproportionately to PM emissions, so compliance with emission standards should be demonstrated on fuel with a composition representative of in-use gasoline. For more information on the aromatics specifications, refer to Chapter 3 of the RIA.

- *Olefins*—adjusting the olefins specification to a range of 4–10 volume percent to better match in-use E10 gasoline.

- *Other Specifications*—adding distillation residue, total content of oxygenates other than ethanol, copper corrosion, solvent-washed gum, and oxidation stability specifications to better control other performance properties of test fuel. These specifications are consistent with ASTM’s D4814 gasoline specifications and CARB’s LEV III test fuel requirements.

<sup>412</sup> LEV III test procedures, including a description of test fuel, can be found at 13 CCR 1961.2.

<sup>413</sup> Premium-required defined at § 1065.710(d).

<sup>414</sup> 72 FR 8434 (February 26, 2007).

<sup>415</sup> More details on fuel property analysis are available in Chapter 3 of the RIA.

• *Updates to Gasoline Test Methods*—updating some of the gasoline test methods previously specified in § 86.113 with more appropriate, easier to use, or more precise test methods for

ethanol-blended gasoline. Key changes include replacement of ASTM D323 with ASTM D5191 for measuring vapor pressure; replacement of ASTM D1319 with ASTM D5769 for measuring

aromatics and benzene; and replacement of ASTM D1266 with three alternative ASTM test methods (D2622, D5453 or D7039) for measuring sulfur.

TABLE IV–26—GASOLINE EMISSIONS TEST FUEL PROPERTIES

Property	Unit	Specification			Reference procedure <sup>a</sup>
		General testing	Low-temperature testing	High altitude testing	
Antiknock Index (R+M)/2 .....	.....	87.0–88.4 <sup>b</sup>			ASTM D2699 and D2700.
Sensitivity (R–M) .....	.....	7.5 Minimum			ASTM D2699 and D2700.
Dry Vapor Pressure Equivalent (DVPE) <sup>c, d</sup> .....	kPa (psi) .....	60.0–63.4 (8.7–9.2)	77.2–81.4 (11.2–11.8)	52.4–55.2 (7.6–8.0)	ASTM D5191.
Distillation <sup>e</sup>					
10% evaporated .....	°C (°F) .....	49–60 (120–140)	43–54 (110–130)	49–60 (120–140)	ASTM D86.
50% evaporated .....	°C (°F) .....	88–99 (190–210)			
90% evaporated .....	°C (°F) .....	157–168 (315–335)			
Evaporated final boiling point .....	°C (°F) .....	193–216 (380–420)			
Residue .....	milliliter .....	2.0 Maximum			
Total Aromatic Hydrocarbons .....	volume % .....	21.0–25.0			ASTM D5769.
C6 Aromatics (benzene) .....	volume % .....	0.5–0.7			
C7 Aromatics (toluene) .....	volume % .....	5.2–6.4			
C8 Aromatics .....	volume % .....	5.2–6.4			
C9 Aromatics .....	volume % .....	5.2–6.4			
C10+ Aromatics .....	volume % .....	4.4–5.6			
Olefins <sup>5</sup> .....	mass % .....	4.0–10.0			ASTM D6550.
Ethanol blended .....	volume % .....	9.6–10.0			
Ethanol confirmatory <sup>f</sup> .....	volume % .....	9.4–10.2			ASTM D4815 or D5599.
Total Content of Oxygenates Other than Ethanol <sup>f</sup> .....	volume % .....	0.1 Maximum			
Sulfur .....	mg/kg .....	8.0–11.0			ASTM D2622, D5453 or D7039.
Lead .....	g/liter .....	0.0026 Maximum			ASTM D3237.
Phosphorus .....	g/liter .....	0.0013 Maximum			ASTM D3231.
Copper Corrosion .....	.....	No. 1 Maximum			ASTM D130.
Solvent-Washed Gum Content .....	mg/100 milliliter .....	3.0 Maximum			ASTM D381.
Oxidation Stability .....	minute .....	1000 Minimum			ASTM D525.

<sup>a</sup> ASTM procedures are incorporated by reference in § 1065.1010. See § 1065.701(d) for other allowed procedures.

<sup>b</sup> Octane specifications apply only for testing related to exhaust emissions. For engines or vehicles that require the use of premium fuel, as described in paragraph (d) of this section, the adjusted specification for antiknock index is a minimum value of 91.0; no maximum value applies. All other specifications apply for this high-octane fuel.

<sup>c</sup> Calculate dry vapor pressure equivalent, DVPE, based on the measured total vapor pressure,  $p_T$ , using the following equation:  $DVPE$  (kPa) =  $0.956 \cdot p_T - 2.39$  (or  $DVPE$  (psi) =  $0.956 \cdot p_T - 0.347$ ). DVPE is intended to be equivalent to Reid Vapor Pressure using a different test method.

<sup>d</sup> Parenthetical values are shown for informational purposes only.

<sup>e</sup> The reference procedure prescribes measurement of olefin concentration in mass %. Multiply this result by 0.857 and round to the first decimal place to determine the olefin concentration in volume %.

<sup>f</sup> The reference procedure prescribes concentration measurements for ethanol and other oxygenates in mass %. Convert results to volume % as specified in Section 14.3 of ASTM D4815.

As mentioned earlier, we will continue to allow manufacturers to test vehicles on premium-grade gasoline should the vehicles require it. In addition, since we cannot predict all future changes in gasoline vehicle technologies and in-use fuels, we will allow vehicle manufacturers to specify an alternative test fuel under certain situations. Under this provision, if manufacturers were to design vehicles that required operation on a higher

octane, higher ethanol content gasoline (e.g., dedicated E30 vehicles or FFVs optimized to run on E30 or higher ethanol blends), under 40 CFR 1065.701(c), they can petition the Administrator for approval of a higher octane, higher ethanol content test fuel if they can demonstrate that such a fuel would be used by the operator and would be readily available nationwide, vehicles would not operate appropriately on other available fuels,

and such a fuel would result in equivalent emissions performance. For vehicles certified on high-octane, high-ethanol gasoline, all EPA confirmatory and in-use testing would also be conducted on high-octane, high-ethanol gasoline. This could help manufacturers who wish to raise compression ratios to improve vehicle efficiency as a step toward complying with the 2017 and later light-duty greenhouse gas and CAFE standards. This in turn could help

provide a market incentive to increase ethanol use beyond E10 and enhance the environmental performance of ethanol as a transportation fuel by using it to enable more fuel efficient engines.

We received comments in general support of allowing certification on higher octane fuels if the vehicles require it, although some commenters believe that the criteria EPA is specifying for such an allowance are too severe. We have considered these comments, and as discussed in the Summary and Analysis of Comments document, we continue to believe that our approach is appropriate, and we are finalizing these provisions as proposed.

### 3. Flexible Fuel Vehicle Exhaust Emissions Test Fuel

We are also finalizing specifications for the fuel used in flexible fuel vehicles (FFV) exhaust emissions testing including certification testing. EPA is establishing specifications for FFV test fuel to resolve confusion and inconsistency among FFV manufacturers in carrying out their certification and other testing requirements and to ensure that FFV emissions are appropriately controlled over the range of in-use fuels. The FFV exhaust emissions test fuel specifications will phase in on the same schedule as the E10 standard gasoline test fuel specifications for light- and heavy-duty gasoline vehicles (described in Section IV.F.4). These FFV exhaust emissions test fuel specifications may be used voluntarily prior to when they are required to be used. The base fuel stock used to formulate FFV exhaust emissions test fuel must comply with the specifications finalized today for the standard E10 emissions test fuel as described in preamble Sections IV.F.1 and 2. This practice avoids the need to specify the ranges for a number of fuel parameters as we have done for gasoline test fuel in Table IV-26 and helps to minimize the number of test fuels that a vehicle manufacturer must store. Denatured fuel ethanol (DFE) that meets the specifications discussed in preamble Section V.G. must be blended into this base fuel stock to attain an ethanol content of 80 to 83 volume percent in the finished test fuel. Commercial grade normal butane can be added as a volatility trimmer to meet a 6.0 to 6.5 psi RVP specification for the finished test fuel.<sup>416</sup>

As an alternative to the use of DFE to manufacture FFV test fuel, neat (undenatured) fuel grade ethanol can be used. As an alternative to using a

finished E10 standard gasoline test fuel in the manufacture of FFV test fuel, the gasoline blendstock used by the fuel provider to produce a compliant E10 test fuel can also be used to manufacture the FFV test fuel. This would allow ethanol to be blended only once to produce FFV test fuel. In such cases, a sample of the subject gasoline blendstock must be tested after the addition of ethanol to produce a finished standard E10 gasoline test fuel to demonstrate that the blend meets all of the requirements for standard gasoline test fuel described in Section IV.F.

The public comments were supportive of EPA establishing specifications for FFV exhaust emissions test fuel. However, some commenters stated that the ethanol content and RVP specifications for FFV exhaust emissions test fuel should be based on typical values for in-use E85.<sup>417</sup> Automobile manufacturers commented that EPA should wait to finalize FFV test fuel specifications until a review of in-use E51-83 fuel quality can be completed in later 2013. They stated that this would allow the FFV test fuel specifications to be representative of the change to in-use "E85" composition since ASTM reduced the minimum ethanol concentration from 68 to 51 volume percent.

Substantial publicly available literature exists to demonstrate that the ethanol content of fuel used in FFVs has a significant effect on vehicle emissions. The effect of ethanol content on FFV emissions becomes more pronounced with increasing ethanol concentration. The current ASTM specification for E85 provides that the ethanol content of E85 may vary from 51 to 83 volume percent depending on climactic conditions.<sup>418</sup> Consistent with our long standing policy regarding the exhaust emissions testing of FFVs, we continue to believe that FFVs must comply with all emissions control requirements while using any fuel that they have the potential to operate on in-use. This ensures vehicles are designed and calibrated for emissions performance across the full range of potential in-use fuel formulations. FFVs are required to have exhaust emissions certification

<sup>417</sup> The term "E85" has historically been used to describe an ethanol blend for use in FFVs with a maximum ethanol content of 83 volume percent and satisfying other fuel parameter specifications established by ASTM International. ASTM D5798-13, "Standard Specification for Ethanol Fuel Blends for Flexible-Fuel Automotive Spark-Ignition Engines".

<sup>418</sup> ASTM International D5798-13, "Standard Specification for Ethanol Fuel Blends for Flexible-Fuel Automotive Spark-Ignition Engines".

testing conducted using both E10 and FFV exhaust emissions test fuel to account for the effect on emissions of the full range of potential ethanol blend formulations. To ensure that FFV certification testing adequately accounts for in-use emissions performance, we are finalizing the ethanol content of FFV exhaust emissions test fuel at 81-83 volume percent as proposed. Exhaust emissions testing conducted using a fuel containing 81-83 volume percent ethanol will provide results that represent the effect of ethanol on FFV emissions performance when this effect is most pronounced. The complimentary emissions certification testing required for FFVs on E10 will ensure that the effect on FFV emissions from the full range of potential in-use ethanol concentrations is represented. Given the need to ensure that FFV emissions certification testing is representative of the full range of potential in-use ethanol blends, it would be inappropriate to set the required ethanol concentration for FFV emissions test fuel based on typical in-use levels as suggested by some of the commenters.

Similarly, the RVP of FFV exhaust emissions test fuel must assure emissions performance over the range of in-use fuels. When ethanol and gasoline are blended to produce high level ethanol blends, the RVP can be and often is very low. As a result, ASTM instituted a minimum RVP for E51-83 of 5.5 psi. Given that low volatility fuels can make the control of cold start emissions more challenging, we are finalizing the RVP of FFV exhaust emissions test to be near the minimum RVP that will be encountered in-use. The 6.0 to 6.5 RVP specification finalized today will help to ensure that FFVs are designed and calibrated to maintain their exhaust emissions performance across the range of in-use fuels.

The levels of other fuel parameters for in-use E51-83 are determined by the levels of these parameters present in the gasoline blendstock used as diluted by the addition of ethanol. Therefore, we believe that requiring that the levels of these other fuel parameters present in FFV exhaust emissions test fuel be determined by the dilution of the levels present in standard gasoline emissions test fuel appropriately reflects their potential effect on emissions performance. Given the considerations discussed above in determining the FFV exhaust emissions test fuel specifications finalized today, we do not believe that there would be a substantial benefit in waiting for the completion of the E51-83 fuel quality survey currently

<sup>416</sup> The specifications for commercial grade butane are contained in 40 CFR 80.82.



underway to finalize FFV test fuel specifications.

As discussed in preamble Section V.H., the Agency is also considering finalizing the in-use fuel quality standards for higher level ethanol blends on which we sought comment in the NPRM. These standards included an in-use RVP standard of 9.0 psi matching that of conventional gasoline. They also contained provisions to allow the production of high-level ethanol blends for use in FFVs from natural gasoline and other higher volatility components. Were we to finalize these in-use standards, we would also consider raising the RVP for the FFV exhaust emissions test fuel.

We are revising the definition of “alcohol” in 40 CFR part 600 to align with the change in the ASTM specification for in-use fuels. Under the revised regulation, we consider an alcohol-fueled vehicle to be one that is designed to operate exclusively on a fuel containing 51 percent or more ethanol or other alcohol by volume. This is not intended to change the applicability, procedures, or

requirements for the fuel economy provisions in 40 CFR part 600.

4. Implementation Schedule

As described earlier in this Section IV, we are establishing Tier 3 exhaust and evaporative emission standards. The changes in the specifications for test fuel apply to vehicles certified to these new standards. The program is designed to transition to the new test fuel during the first few years as the Tier 3 standards are phasing in. Testing requirement with the new Tier 3 test fuel starts with light-duty vehicles certified to Tier 3 bin standards at or below Bin 70, and heavy-duty vehicles certified to Tier 3 bin standards at or below Bin 250 (for Class 2b) and Bin 400 (for Class 3). For light-duty vehicles, Table IV–27 below describes the implementation schedule of the new Tier 3 gasoline test fuels for each of the program elements in addition to the all the gasoline test fuel options available during the transition period. Table IV–3 below similarly describes the heavy-duty gasoline vehicle test fuel implementation schedule and gasoline

test fuel options. The new Tier 3 PM requirements for both light-duty vehicles and heavy duty vehicles which phase-in independent of other vehicle exhaust emission requirements must be met using the certification test fuel for meeting the NMOG+NO<sub>x</sub> standards.

Starting with model years 2020 for light-duty and 2022 for heavy-duty, all manufacturers will use the new test fuel for all exhaust emission testing (with the exception of small volume manufacturers and small businesses, which can delay using the new test fuel for all vehicles until model year 2022). Manufacturers also need to comply with cold temperature CO and NMHC standards using the new test fuel for any models that use the new test fuel for meeting the light-duty Tier 3 exhaust emission standards as indicated in the tables below. These same tests will also provide the basis for meeting GHG requirements under 40 CFR part 86 and fuel economy requirements under 40 CFR part 600, as described in the following section.

TABLE IV–27—EXHAUST EMISSIONS GASOLINE TEST FUELS FOR LDVS, LDTs, AND MDPVS

Emission compliance program	Test purpose: demonstration of compliance to the emissions standards:	Test cycles		
		FTP City/HWFE/SFTP	Cold CO and NMHC	High altitude
Tier 2 .....	Certification .....	(1)(2)(3)(4) .....	(1)	(1)
	Confirmatory and In-use .....	Certification fuel and/or (1)* .....	(1)	(1)
Tier 3 Early 2015 to 2017.	Certification .....	(1)**(2)**(3)(4) .....	(1)**(3)	(1)**(3)
	Confirmatory and In-use .....	Certification fuel .....	(1)**(3)	(1)**(3)
Tier 3 phase-in 2017 to 2019.	Certification .....	(1)**(2)**(3)(4) .....	(1)**(3)	(1)**(3)
	Confirmatory and In-use .....	Certification fuel .....	(1)**(3)	(1)**(3)
Tier 3 complete 2020+ ..	Certification .....	(3)(4) .....	(3)	(3)
	Confirmatory and In-use .....	Certification fuel .....	(1)**(3)	(1)**(3)
	Confirmatory and In-use .....	Certification fuel and/or (3)* .....	(3)	(3)

Fuels: (1) Tier 2 (2) LEV II (3) Tier 3 E10 (4) LEV III E10

\*EPA accepts the use of California certification fuels (or Tier 3 E10 for Tier 2 certification) but manufacturer must comply on the program specific Federal fuel. EPA may perform or require manufacturer testing on the Federal fuel.

\*\* Fuel (1) only allowed for Bins 160, 125, 110, 85.

\*\*\* Fuel (2) only allowed for carryover SULEV 150k exhaust.

TABLE IV–28—EXHAUST EMISSIONS GASOLINE TEST FUELS FOR HEAVY DUTY VEHICLES

Emission compliance program	Test purpose: demonstration of compliance to the emissions standards	Test cycles	
		FTP City/HWFE/SFTP	High altitude
Pre-Tier 3 .....	Certification .....	(1)(2)(3)(4) .....	(1)
	Confirmatory and In-use .....	Certification fuel and/or (1)* .....	(1)
Tier 3 Early 2016 to 2017 ....	Certification .....	(1)** (3)(4) .....	(1)**(3)
	Confirmatory and In-use .....	Certification fuel .....	(1)**(3)
Tier 3 phase-in 2018 to 2021	Certification .....	(1)** (3)(4) .....	(1)**(3)
	Confirmatory and In-use .....	Certification fuel .....	(1)**(3)
Tier 3 complete 2022+ .....	Certification .....	(3)(4) .....	(3)
	Confirmatory and In-use .....	Certification fuel and/or (3)* .....	(3)

Fuels: (1) Tier 2 (2) LEV II (3) Tier 3 E10 (4) LEV III E10

\*EPA accepts the use of California certification fuels (or Tier 3 E10 for Tier 2 certification) but manufacturer must comply on the program specific Federal fuel. EPA may perform or require manufacturer testing on the Federal fuel.

\*\* Fuel (1) only allowed for Bins 340, 395, 570, 630.

Additionally, heavy-duty gasoline engines (HDGEs) not subject to new Tier 3 exhaust emission standards (those certified for exhaust emissions using an engine dynamometer) are required to be certified on Tier 3 fuel by MY 2022. Further discussion can be found in Section IV.C.4.c.

For evaporative emission testing, manufacturers will need to use the new test fuel for any models that are to be certified to the Tier 3 evaporative emission standards. To the extent that these models are different than those used for exhaust emission testing with the new test fuel, manufacturers will need to do additional testing to demonstrate compliance with all applicable standards. They may alternatively use the new test fuel earlier than the regulations specify to avoid additional testing. We further require that manufacturers submit certification data based on the new test fuel to demonstrate compliance with refueling emission standards for any vehicles that are certified to the Tier 3 evaporative emission standards.

#### 5. Implications of Emission Test Fuel Changes on CAFE Standards, GHG Standards, and Fuel Economy Labels

##### a. Test Fuel

Under regulations in 40 CFR part 600, vehicles use the same test fuel in emission testing conducted for CAFE standards, greenhouse gas (GHG) emissions, and the fuel economy label as that used for emission testing for criteria pollutants. This includes the test fuel used for testing on all five cycles (FTP, highway fuel economy test (HFET), US06, SC03, and Cold FTP). In the Tier 3 NPRM, EPA proposed a change in emissions test fuel used to determine compliance with criteria pollutant standards and this test fuel change would also apply to CAFE and GHG standards and the fuel economy label such that a common test fuel under 40 CFR part 600 was retained. At the same time, EPA indicated its commitment to the principle that the change in test fuel would not affect the stringency of the CAFE or GHG standards and that the labeling calculations would be updated in a future action to reflect the change in test fuel properties.

The NPRM indicated that more data and time were needed to assess the effects on stringency and implementation of these programs. While EPA's initial review of available data suggested that the change in test fuel would not impact the GHG standards, more time and data were needed to confirm this initial view

regarding the GHG standards and to determine what adjustments if any would need to be made to the CAFE program and fuel economy label calculation procedures to account for the change in test fuel. EPA indicated we would defer action on appropriate adjustments, if any, for the GHG and CAFE programs until data were available to assess how the difference in the fuel properties (Tier 3 fuel compared to Tier 2 fuel) would impact the stringency of the CAFE and GHG standards for Tier 3 technology vehicles and the calculations for the fuel economy label. EPA indicated that any adjustments or changes in the regulatory text would be done through a future action.

Manufacturers commented that EPA should take action on the necessary adjustments to compliance calculations as part of the Tier 3 final rule. The methodologies for addressing some elements of the changes in fuel properties such as the difference in energy density are already addressed in the regulation. One key element, the "R" factor found in the equation of 40 CFR 600.113-12(h)(1) is intended to capture inefficiencies and differences in how vehicles respond to changes in the energy content of the fuel. This factor is empirically based, developed using vehicle test data. This value is presently set at 0.6 and is shown in the denominator of the aforementioned equation. While there has been some data evaluated to assess the impact of changing the emission test fuel on the "R" factor, EPA did not propose a value in the NPRM and specifically stated that we would continue to investigate this issue and if necessary address it as part of a future action, as opposed to changing it in the Tier 3 final rule. Furthermore, as discussed above, there is a need for more data to fully understand how other changes in certification fuel for Tier 3, such as the octane specification, may affect the stringency of the CAFE and GHG standards which were based on Tier 2 emission fuel, as well as any implications for the fuel economy label. These potential effects are best understood using emission data generated on Tier 3/LEV III vehicles tested on both Tier 3 and Tier 2 test fuel.

In addition, the manufacturers commented that even with the use of "analytically derived data" as permitted under current EPA regulations and guidance,<sup>419</sup> EPA should finalize an

<sup>419</sup> See 40 CFR 600.006-08(e) and EPA guidance letter CD 12-03, February 27, 2012 and CCD-04-

appropriate test procedure adjustment in the Tier 3 rulemaking, including adoption of an "R" factor of 1.0, and should allow manufacturers the option of using Tier 2 fuel for CAFE, GHG, and fuel economy labeling at least through MY2019 to provide time for adjusting to the new test fuel.

In the NPRM, EPA indicated that we would not be changing the "R" factor or implementing other adjustments or changes in the regulatory text in the FRM. In follow-up meetings with the manufacturers, we expressed a willingness to consider permitting GHG and CAFE to continue on Tier 2 fuel until the future rulemaking action to address the "R" factor and other potential changes was complete and in effect. The manufacturers responded that under this approach the existing regulations would require a significant amount of additional emission testing for any model certified to the Tier 3/LEVIII exhaust emission standards before the future rulemaking is completed and in effect.<sup>420</sup> This is because Tier 3 test fuels would be used in emission data vehicles (EDVs) evaluated for compliance with Tier 3 criteria pollutant standards, but these same EDVs would also have to be tested on Tier 2 fuel for GHG, fuel economy label, and CAFE program data purposes. Also, while Tier 2 fuel would apply to EDVs and fuel economy data vehicles (FEDVs) evaluated for fuel economy label, CAFE program data values, and compliance with GHG standards, these same FEDVs would have to be retested on Tier 3 fuel to show compliance with the Tier 3 criteria pollutant standards. This additional testing would also extend to in-use verification program (IUV) testing under 40 CFR 86.1845 through 86.1853.

In response to the concerns expressed by the manufacturers, EPA has identified five interim changes to existing regulations to both clarify testing requirements and to provide the manufacturers a reasonable opportunity to continue to test for CAFE, GHG, and labeling purposes on Tier 2 test fuels for each EDV and FEDV until such time as EPA determines appropriate adjustments, if any, related to a change to Tier 3 test fuels. EPA believes these changes can be implemented without impacting the integrity of the testing conducted for the criteria pollutant, CAFE, and GHG standards or values generated for determination of fuel economy labels. It is very important to

06, March 11, 2004, available at <http://iaspub.epa.gov/otaqpub/>.

<sup>420</sup> This could start as early as the 2015 MY when the LEV III program begins to phase-in.

note that the emission test data generated by these early Tier 3/LEVIII vehicles covering both Tier 2 and Tier 3 test fuel will provide data needed to assess the “R” value and the impact of the fuel change on the stringency of the CAFE and GHG standards, and the calculations for the fuel economy labeling program. These data will be instrumental in developing any appropriate adjustments to maintain equivalent stringency for the CAFE and GHG standards and to update the fuel economy labeling calculations, as needed. At the present time, EPA expects to have the needed data in early to mid 2015 and will then be in a position to conduct a thorough assessment of the impacts of different emission test fuels on Tier 3/LEV III vehicles and develop any appropriate adjustments and changes, in consultation and coordination with NHTSA.

These interim changes which are presented below and shown in Table IV–29, apply only to vehicles certified to the Tier 3 and/or LEV III exhaust emission standards in the model years before the future action mentioned above takes effect. These are reflected in 40 CFR 80.600.117.

1. For any given EDV or FEDV, our regulations will require that testing related to CAFE and GHG standards and the fuel economy label must still be done on Tier 2 fuel even if criteria pollutant testing is done on Tier 3 or LEV III fuel. The “R” value used in the fuel economy equation would remain at 0.6 until any change is made in a future rulemaking.

2. The requirement continues that FEDVs are expected to meet the criteria pollutant emission standards. As a flexibility, rather than requiring FEDVs to retest on Tier 3 fuel to show that they pass the criteria pollutant emission standards, we are providing in the regulations that FEDVs may meet these standards using Tier 2 fuel on each of the five cycles (as applicable) or be subject to retesting and passing on Tier 3 fuel if they do not meet requirements on Tier 2 fuel or otherwise do not comply with 40 CFR 86.1835–01(b) and 40 CFR 600.008(b). In these circumstances, assuming a retested vehicle meets criteria pollutant standards on Tier 3 fuel, the emissions results on the Tier 2 fuel will still be used for CAFE, GHG, and fuel economy labeling purposes. Retesting on Tier 3 fuel is only required for those cycles where the FEDV did not meet the criteria pollutant standards on Tier 2 fuel.

3. As a flexibility, if EDV testing is conducted on Tier 3/LEV III fuel for criteria pollutants (all 5 cycles), then we are requiring the EDV testing to be conducted on Tier 2 fuel for only 2 cycles (FTP and HFET) for GHG and CAFE purposes. These emission results on Tier 2 fuel are expected to meet the Tier 3 criteria pollutant standards. Our regulations then require manufacturers to use these EDV Tier 2 fuel test results (FTP and HFET) for the CAFE, and GHG standards. The EDV Tier 2 fuel test results (FTP and HFET) would also be used for fuel economy label calculations except in rare cases where the EDV does not pass the litmus test or if the manufacturer voluntarily elects to use

the vehicle specific 5-cycle method to determine fuel economy label values. In those two cases, the EDV would need to be tested on Tier 2 test fuel on each of the five cycles.

4. As a flexibility, during the interim model years, manufacturers may use either Tier 2 or Tier 3/LEVIII test fuel emission results to conduct the litmus evaluations for fuel economy labeling under 40 CFR 600.115–11. All emission results for the five tests involved used must be from the same test fuel. EPA believes this is appropriate since the litmus evaluation is based on a comparison of the percent differences of 2 and 5 cycle values rather than absolute differences in the values. If a manufacturer chooses to conduct the litmus evaluation using LEVIII fuel, the cold FTP test must still use Tier 3 fuel. In the situation where the manufacturer uses Tier 3/LEV III test fuel for the litmus test the R-factor will be 0.6. EPA will provide guidance on determining the values for the other fuel quality parameters needed for the fuel economy calculations when Tier 3/LEVIII fuel is used.

5. Exhaust emission testing for IUVP for GHGs shall be conducted using the same test fuel as used for criteria pollutant certification, unless the manufacturer uniformly elects to conduct its IUVP GHG testing on Tier 2 fuel. This relieves the need to conduct IUVP testing for criteria pollutants on Tier 3 fuel and GHG testing on Tier 2 fuel. EPA believes this is an acceptable interim regulatory flexibility, since the IUVP testing for GHGs does not involve the IUVP provisions of 40 CFR 86.1846–01.

TABLE IV–29—INTERIM TESTING REQUIREMENTS FOR EDVs AND FEDVs ON TIER 3 AND TIER 2 TEST FUEL

Tests/ cycles	Criteria pollutant (EDVs)	GHG/Label/CAFE (EDVs and FEDVs) (tier 2 fuel)		Litmus calculation	IUVP		
	5-cycle	5-cycle (label)	2-cycle (CAFE/GHG/label)		Criteria pollutant	GHG*	
Test fuel requirements	Tier 3 fuel or other transition option**	Tier 2 fuel	Tier 2 fuel	Tier 3 fuel	Tier 2 or Tier 3 fuel	Tier 3 fuel	Tier 2 fuel
FTP .....	X	X	X	Show criteria pollutant standards are met using Tier 2 fuel or must retest on Tier 3 fuel.	Use 5-cycle Tier 3 fuel or Tier 2 fuel test results.	X	X
HFET .....	X	X	X	.....	.....	X	X
US06 .....	X	X	.....	.....	.....	X	
SC03 .....	X	X					
Cold FTP .....	X	X					

\* Manufacturer may uniformly elect to use Tier 2 fuel results to meet the IUVP GHG requirements or rely on Tier 3 results.

\*\* California Phase 2 fuel is only permitted for GHG/Label/CAFE and Litmus assessments for vehicles certified for criteria pollutants in the Tier 3 program using carryover data from CARB LEV II certifications such as SULEVs and PZEVs.

Manufacturers may use LEVIII fuel (California Phase 3) in lieu of Tier 3 fuel, but any cold FTP testing must be done using Tier 3 Cold FTP fuel. LEV III fuel is 7 RVP E10, Tier 3 fuel is 9 RVP E10, and Tier 2 fuel is 9 RVP E0.

Manufacturers have presented two points of view with regard to when the potential new requirements (including a revised "R" factor and other possible test procedure changes/adjustments related to CAFE, GHG, and fuel economy labeling) should take effect once the future rulemaking action mentioned above is complete. Some have stated that use of the new provisions should be available for use as soon as possible after the rule is completed. This would minimize the need for any future duplicate testing and put manufacturers on course for fully aligning with the new requirements quickly. Others have asked that there be lead time provided before the application of the new requirements becomes mandatory. The manufacturers have expressed concern that the use of the new requirements more quickly by one manufacturer versus another could create a competitive imbalance. At the same time, manufacturers do not necessarily want to be forced to certify all products to the new requirements by a cut-off date (e.g., 2020 model year) without EPA consideration of phase-in or phase-out provisions and data carryover.

EPA understands the manufacturers' various issues and concerns in this area. Based on the information available at this time, EPA is expecting to allow the optional use of any future adjustments for compliance calculation and labeling purposes as soon as the future rule mentioned above becomes effective. Furthermore, we expect that the mandatory use of any such new adjustments with all Tier 3 certifications would be required for the 2020 MY. These initial timing projections are subject to revision based on timing of the completion of the future action and the data and record developed in that future rulemaking.

#### b. Useful Life for GHG Standards

As stated above, EPA is committed to retaining equivalent stringency for GHG emissions compliance beginning in MY 2017. We need more emissions test data to better understand the GHG emission impacts of Tier 3 fuel in Tier 3 technology vehicles. However, we believe that certifying a vehicle to a longer useful life for any emission constituent would have only a beneficial effect on emissions. To address potential concerns about changes in the stringency of the GHG

standards resulting from a longer useful life, we are not requiring a longer useful life for GHG emission standards, although manufacturers can optionally certify GHG emissions to a 150,000 mile, 15 year useful life.

#### 6. Consideration of Test Fuel for Nonroad Engines and Highway Motorcycles

As described earlier in Section IV.F., we are adopting new specifications for the gasoline emissions test fuel used for testing highway vehicles subject to the Tier 3 standards. Earlier in the development of this rulemaking, EPA also considered changing the test fuel specifications for other categories of engines, vehicles, equipment, and fuel system components that use gasoline. These include a wide range of applications, including small nonroad engines used in lawn and garden applications, recreational vehicles such as ATVs and snowmobiles, recreational marine applications, and highway motorcycles. While engines in some of these categories employ advanced technologies similar to light-duty vehicles and trucks, the vast majority of these engines employ much simpler designs, with many of the engines being carbureted with no electronic controls. Because of the lower level of technology, emissions from these engines are potentially much more sensitive to changes in fuel quality.

EPA is not applying the new emissions test fuel specifications to these other categories of engines, vehicles, equipment, and fuel system components. In discussing the potential change in test fuel specifications with the large number of businesses potentially impacted by such a change, many companies supported such a change. However, a number of manufacturers raised concerns about the level of ethanol in the new fuel, the cost of recertifying emission families on the new fuel, the impact on nationwide product offerings, and the cost impact of complying with the existing standards on the new test fuel. EPA believes it is important that the test fuel for these other categories reflect real-world fuel qualities but has elected to defer moving forward now pending additional analysis of the impacts of changing the test fuel specifications for the wide range of engines, vehicles, equipment and fuel system components that could be impacted. These impacts include the impact on the emissions standards, as well as the other issues raised by the manufacturers. EPA plans to explore such a change in a separate future action.

While we are not changing the test fuel specifications for these other types of vehicles and engines, we are updating the reference standards associated with specific parameters and making minor adjustments to calculation methods. For certified engines and vehicles that have already been using the test fuel specified in § 1065.710, we are clarifying that the RVP is calculated using the same equation described above for the new fuel specified for Tier 3 vehicles. We are also taking the opportunity to align and update test methods for the various gasoline test fuels in 40 CFR part 86. Specifically, we are revising §§ 86.113 and 86.213 to (1) use both ASTM D2699 and ASTM D2700 for octane measurements involving both research and motor octane specifications (including octane sensitivity), (2) use ASTM D2622 for all sulfur measurements, which is widely used and provides superior results compared with the methods that have been referenced in the regulations, (3) use ASTM D5191 for measuring fuel volatility, including the calculation described above. We are also updating the regulations to reference a newer version of the following currently referenced procedures: ASTM D86, ASTM D1319, ASTM D2699, ASTM D3231, and ASTM D3237. All these changes and updates align with fuel specifications in 40 CFR part 1065.

#### 7. CNG and LPG Emissions Test Fuel Specifications

There are currently no sulfur specifications for the test fuel used for certifying natural gas (CNG) vehicles. There is also no sulfur specification in 86.113 for the test fuel used for certifying liquefied petroleum gas (LPG) light duty vehicles. The LPG certification test fuel for heavy-duty highway engines and for nonroad engines in 1065.720 includes an 80 ppm maximum sulfur specification. We requested comment on the appropriateness of changing 86.113 to reference 40 CFR part 1065 for all natural gas and LPG test fuels. We further requested comment on amending these specifications to better reflect in-use fuel characteristics, and in particular on the appropriateness of aligning the sulfur specifications with those that apply for gasoline test fuel. We noted that changing the sulfur specifications would depend on establishing that the new specification is consistent with the range of properties expected from in-use fuels.

The Alliance of Automobile Manufacturers (the Alliance) stated that EPA should adopt a 10 ppm maximum sulfur specification for CNG and LPG

vehicle certification test fuels. They also stated that § 86.113 should reference part 1065 for CNG and LPG test fuels (for light and heavy duty vehicles). The American Petroleum Institute (API), the Association of Fuel and Petrochemical Manufacturers (AFPM), and several individual refiners stated that EPA should not establish new sulfur standards for CNG and LPG vehicle certification test fuels until additional data are available on the sulfur content of in-use CNG/LPG fuels. The National Propane Gas Association (NPGA) stated that they are opposed to a change in the sulfur specifications for LPG vehicle certification test fuels given that they are unaware of any issue that would warrant such a change.

As discussed in Section V.J. of today's preamble, additional time is needed for EPA to work with industry to collect data on current CNG/LPG sulfur content, to determine whether additional control of in-use CNG/LPG sulfur content is needed, and to evaluate the feasibility and costs associated with potential additional sulfur controls. Therefore, we are deferring finalizing in-use quality and certification test fuel specifications for CNG and LPG at this time.

#### G. Small Business Provisions

We are adopting special flexibility provisions for small businesses that are subject to the Tier 3 emissions standards. Such businesses are typically vehicle manufacturers, independent commercial importers (ICIs), or alternative fuel vehicle converters. We are also providing Tier 3 flexibility to companies that, though they may not meet the eligibility requirements for small businesses, sell less than 5,000 vehicles per year in the United States, and thus qualify as small volume manufacturers (SVMs). These companies and small businesses typically face similar challenges in implementing new EPA vehicle standards.

As in previous vehicle emissions rulemakings in which we have provided such flexibilities, our reason for doing so is that these entities generally have more implementation difficulty than larger companies. Small companies generally have more limited resources to carry out necessary research and development; they can be a lower priority for emission control technology suppliers than larger companies; they have lower vehicle production volumes over which to spread compliance costs; and they have a limited diversity of product lines, which limits their ability to take advantage of the phase-in and

averaging provisions that are major elements of the Tier 3 program.

We proposed small business provisions largely based on the recommendations of the Small Business Advocacy Review (SBAR) Panel, described in Section XIII.C of the Notice of Proposed Rulemaking (NPRM). We proposed provisions for additional lead time, reduced testing requirements, and opportunities for hardship relief to help small entities to leverage technological developments by others and to spread the availability of needed engineering, supplier, and capital resources. Based on the comments we received, we have improved on the proposed provisions in the final rule as described in detail below.

#### 1. Lead Time and Relaxed Interim Standards

We proposed that small businesses and SVMs be allowed to postpone compliance with the standards and other Tier 3 requirements, including use of the new certification test fuel, until model year (MY) 2022. For MY 2022 and later, they would be subject to the same Tier 3 requirements as other manufacturers, including the declining fleet average NMOG+NO<sub>x</sub> standards and the fully phased in 30 mg/mi FTP standard for MYs 2025 and later. We requested comment on adopting relaxed FTP NMOG+NO<sub>x</sub> standards for small companies in the light-duty market segment, noting that LEV III provides light-duty SVMs with relaxed FTP NMOG+NO<sub>x</sub> standards of 125 and 70 mg/mi in MYs 2022 and 2025, respectively.

We did not receive comments from non-SVM small businesses subject to the Tier 3 vehicle standards about our proposed small entity phase-in provisions. However, we received comments from SVMs, as well as the Alliance of Automobile Manufacturers and the Association of Global Automakers, arguing that the proposed phase-in did not provide adequate lead time relief for SVMs, and that the long-term Tier 3 standards for light-duty vehicles are not technologically feasible for SVMs. They highlighted the ability of large manufacturers to offset high emissions from high-performance, luxury models by averaging with their low-emitting models, while competing SVM products must be designed to actually achieve low emissions while still meeting customers' performance expectations. Their limited production can also result in emission control technology suppliers placing a lower priority on SVM orders than on those of larger, high-volume manufacturers.

Because of these factors, SVMs suggested that their companies meet a slightly more stringent NMOG+NO<sub>x</sub> standard (125 mg/mi) than what we proposed for SVMs in the early years of the program, and a permanently relaxed standard of 51 mg/mi beginning in MY 2022. Ferrari suggested a compliance schedule for SVMs similar to the California LEV III program, with either a permanently relaxed standard (matching the California LEV III 70 mg/mi long-term standard) or a delay until MY 2030 to meet the primary 30 mg/mi Tier 3 standard (when they suggest that SVMs could potentially comply). CARB comments supported Tier 3 adoption of its LEV III provisions for SVMs, including the long-term 70 mg/mi standard beginning in MY 2025. VNG, a natural gas fuel network provider, commented that gaseous-fuel small-volume test groups should be given extended phase-in opportunities identical to those proposed for SVMs, regardless of company size. As justification, VNG pointed to challenges unique to converting vehicles to operate on natural gas: thermal management of direct injection fueling and engine oil systems, adaptation of gasoline direct injection (GDI) controls to natural gas port fuel injection, and improvement of turbocharger response times.

After considering the comments, we agree with SVMs that their unique logistical and technological challenges, especially in the later years of the primary FTP NMOG+NO<sub>x</sub> standards phase-in schedule, warrant a significant period of relaxed standards for these manufacturers. However, we have found no fundamental reason why, given sufficient lead time, all manufacturers, regardless of company size and vehicle characteristics, will not be able to meet the Tier 3 standards. Thus, we are finalizing an optional program for SVMs, available to non-SVM small businesses as well, under which they can choose an alternative 3-stage FTP NMOG+NO<sub>x</sub> fleet average standard phase-in schedule: an initial standard of 125 mg/mi for MYs 2017 through 2021, a more stringent standard of 51 mg/mi for MYs 2022 through 2027, and the final Tier 3 standard of 30 mg/mi thereafter.

Because companies choosing this 3-stage compliance option are certifying to Tier 3 bin standards in MY 2017, we are requiring that other exhaust emissions standards, including SFTP and PM standards, apply for their vehicles as well, to the same degree and on the same schedule as for other manufacturers. Application of evaporative emissions and onboard diagnostics (OBD) standards, on the

other hand, is not affected by choice of the 3-stage compliance option for the FTP NMOG+NO<sub>x</sub> standards, and small companies may separately choose to delay compliance with evaporative emissions and OBD standards (except as noted in Section IV.G.3) until MY 2022, as proposed. In addition, small companies choosing the 3-stage compliance option may delay the longer useful life and new test fuel requirements for exhaust emissions standards until MY 2022 to align these changes with the 3-stage schedule. This option would not preclude use of other applicable small entity flexibility provisions discussed in this subsection.

Although we are adopting this revised implementation schedule for SVMs and small businesses, we believe the proposed approach of allowing postponement of Tier 3 compliance until MY 2022 may be useful for small companies needing more lead time to begin certifying Tier 3 vehicles. Therefore we are finalizing the proposed approach as an additional but separate option for such companies, including SVMs, ICIs, and alternative fuel vehicle converters. Furthermore, because the optional 3-stage SVM implementation schedule, and the record of comments that prompted it, are specific to the light-duty sector, we are not extending it to heavy-duty vehicles and instead are finalizing only the proposed approach of allowing postponement of Tier 3 compliance until MY 2022 for any SVMs and small businesses in the heavy-duty sector.

Companies that take advantage of one of the SVM and small business implementation schedule provisions in either the light-duty or heavy-duty sector are not allowed to generate or use Tier 3 exhaust emissions credits in that sector while or before they are subject to significantly less stringent standards than other manufacturers. That is, they cannot earn or use Tier 3 exhaust emissions credits before MY 2022 under the 3-stage light-duty SVM revised implementation schedule, and they also cannot do so before MY 2022 if they are using the postponed compliance schedule that we proposed, unless they choose to end their use of these SVM implementation options earlier than MY 2022.

We disagree with VNG's assessment that small-volume test groups of large manufacturers should have until 2022 to comply with Tier 3. The technical challenges outlined by VNG have to do with converting gasoline vehicles to run reliably and durably on natural gas. Although these conversion challenges may be exacerbated for the new generation of turbocharged GDI

vehicles, we have no evidence or comments from a vehicle manufacturer indicating that meeting Tier 3 standards is significantly more difficult for natural gas vehicles than for gasoline vehicles. Note that we are providing some relief for small volume test groups in the form of assigned deterioration factors (discussed below), but not because of feasibility concerns. Rather, we believe that assigned deterioration factors provide a sufficient alternative to the extensive process of developing a unique factor for each low-volume vehicle model. We find no justification to delay compliance with Tier 3 standards for larger manufacturers' low-volume models as requested by VNG.

## 2. Assigned Deterioration Factors

In Tier 3 as in past programs, manufacturers must demonstrate compliance with emissions standards throughout the vehicle's useful life. This is generally done by testing vehicles at low mileage and then applying a deterioration factor to the measured emissions levels. The deterioration factors are determined by testing emissions control systems before and after an aging process. In the past we have allowed small entities to use deterioration factors assigned by EPA instead of performing the extended testing, and we proposed to do so again for demonstrating compliance with Tier 3 exhaust and evaporative emissions standards. We did not propose specific assigned deterioration factors, but noted that the proposed delay in the small entity compliance schedule to MY 2022 would allow sufficient deterioration data from large manufacturers to accumulate for timely development of these factors.

We are adopting the assigned deterioration factor provisions for small businesses and SVMs (as well as for small volume test groups), as proposed. Commenters expressed support, and asked that the Agency commit itself to keeping these factors up to date as durability data accumulates. In response, we can state that we are committed to periodically updating and publishing these assigned deterioration factors. Given that SVMs will be allowed to use the revised implementation schedule described above, starting in MY 2017, it becomes necessary to consider assigned deterioration factors in stages. Because there may not be a sufficient base of accumulated durability data on Tier 3 vehicles by MY 2017, we expect that the current set of assigned factors based on Tier 2 vehicles may continue in place for some time, noting that the MY 2017–2021 SVM fleet average of 125 mg/mi is

not too much different from the average of today's Tier 2 vehicle emissions. By MY 2022, when the SVM NMOG+NO<sub>x</sub> fleet average standard drops to 51 mg/mile, we expect to have new assigned factors available. We note that small businesses and SVMs may also, with advance EPA approval, use deterioration factors developed by another manufacturer (40 CFR 86.1826–01(b)).

## 3. Reduced Testing Burden and OBD Requirements

Under our existing regulations, manufacturers must perform in-use testing on their vehicles and demonstrate that their in-use vehicles comply with the emissions standards. These regulations provide for reduced levels of testing for small companies with annual sales under 15,000, and for no in-use testing for those with annual sales up to 5,000. We received no adverse comments on our proposal to continue this approach in Tier 3, and are retaining it.

As described in Sections IV.A and IV.B, we are requiring manufacturers to test for PM emissions from vehicles of all fuel types, a change from previous practice in which non-diesel vehicles could be waived from PM testing. However, we proposed and have decided to continue the PM testing waiver in Tier 3 for small businesses and SVMs. In lieu of testing, these companies are required to make a statement of compliance with the Tier 3 PM standards, and their vehicles are still subject to the standards. We may however measure PM emissions to determine compliance in EPA confirmatory or in-use testing.

We proposed to apply CARB's OBD requirements to Tier 3 vehicles, except that small alternative fuel vehicle converters would be allowed to instead meet our existing OBD requirements (40 CFR 86.1806–05). The natural gas fuel network provider VNG objected that the proposed exception disadvantages larger vehicle manufacturers and should be made equally available to all vehicle manufacturers' small volume test groups. We expect that larger manufacturers wishing to produce alternative fuel vehicles will be familiar with CARB's OBD requirements and well-positioned to implement these requirements in Tier 3. We note that larger OEMs themselves did not request to be covered by an extension of this provision.

We are finalizing the exception to the Tier 3 OBD requirements as proposed. Note that the optional delay in Tier 3 implementation until MY 2022 that is available to small businesses, discussed

above, includes a delay in the Tier 3 OBD requirement to MY 2022, as proposed, except that vehicles already meeting this requirement in MY 2017 must continue to do so in subsequent years. We are also adopting this Tier 3 OBD delay to MY 2022 for small companies taking advantage of the revised light-duty 3-stage implementation schedule discussed above, even though other Tier 3 requirements start for them in MY 2017, in order to avoid overburdening these manufacturers with multiple sets of new OBD design constraints.

#### 4. Hardship Relief

We proposed and are adopting provisions for small businesses and SVMs in hardship situations to apply for additional time to meet the Tier 3 standards. Such appeals will need to include evidence that the noncompliance would occur despite the manufacturer's best efforts to comply, and that severe economic hardship would occur if the relief is not granted, though the company need not show that its solvency will be in jeopardy without the relief. (This showing is required in other EPA programs granting hardship relief under 40 CFR 1068.250.) The duration of relief will be established on a case-by-case basis for Tier 3 and is not being limited by regulation. Commenters supported these proposed provisions, within the context of a revised approach to SVM lead time, discussed above.

#### 5. Eligibility for the Flexibilities

As proposed, we are using the federal Small Business Administration (SBA) criteria to define small businesses eligible for the special provisions. SBA defines small business vehicle manufacturers as those with less than 1,000 employees, and small business ICIs and alternative fuel vehicle converters are evaluated using SBA criteria based on annual revenues. See Section IV.H.3 for a discussion of additional provisions that apply specifically to ICIs. Also, as proposed, we are defining SVMs in 40 CFR 86.1838–01 for purposes of Tier 3 as companies with nationwide annual U.S. sales volumes at or below 5,000 vehicles, though the 15,000 vehicle threshold used in Tier 2 continues to apply in a few regulatory provisions that Tier 3 changes are not impacting. Eligibility will be evaluated using an average of 2012–2014 MY sales. For companies with no 2012 MY sales, projected sales may be used, but their eligibility will be re-evaluated thereafter using a three-year running average.

VNG commented that the proposed 5,000 vehicle threshold could potentially limit the ability (or willingness) of natural gas SVMs to scale up production by forcing a tradeoff between sales and regulatory burden, pointing also to the fact that 15,000 vehicles is only 0.1% of annual light-duty vehicle sales. We do not believe that the SVM relief provisions are so advantageous as to cause self-limiting of sales, except possibly in the unlikely case of a company very near the threshold. Even if this were to happen, moving the threshold to 15,000 would not prevent the same dynamic from happening at that sales level. Furthermore, our use of a three-year average of sales for determining SVM eligibility protects the SVMs from being penalized for having an especially good year not reflective of its long-term growth trend. See the MY 2017 and later light-duty GHG final rule for a discussion of our basis for adopting the 5,000 vehicle threshold (77 FR 62793, October 15, 2012).

We requested comment on extending eligibility for the Tier 3 SVM provisions to small manufacturers that are owned by large manufacturers but are able to demonstrate that they are operationally independent. We established such a provision in the light-duty greenhouse gas (GHG) program, and CARB did so in LEV III. Comments from CARB and Ferrari supported this extension. No commenters opposed it; however, Advanced Biofuels USA recommended caution to avoid advantaging SVMs capable of leveraging parent company resources to drastically increase U.S. market share within 2–3 years. Given the establishment of this provision in our GHG program, and the value of this extension for harmonization with LEV III, we are adopting this change into Tier 3 using the same eligibility criteria as in our GHG program, set forth in 40 CFR 86.1838–01(d). We believe these criteria are sufficiently strict and objective to address the concerns expressed by Advanced Biofuels USA.

To qualify as SVMs in either the light-duty or heavy-duty Tier 3 programs, the company's total sales of vehicles subject to standards under 40 CFR part 86, subpart S count toward the vehicle sales limit, including both light- and heavy-duty vehicles. Companies so qualified may take advantage of SVM provisions in both sectors.

#### H. Compliance Provisions

##### 1. Exhaust Emission Test Procedures

We are finalizing most of the amendments we proposed to 40 CFR part 1066 as part of the effort to migrate

test requirements from 40 CFR part 86. We began this process a couple of years ago when we established part 1066, but we applied these test procedures only to certain vehicles above 14,000 lbs gross vehicle weight rating (GVWR) for the purpose of measuring greenhouse gas emissions (76 FR 57470, September 15, 2011). This final rule extends these procedures, with some amendments, to vehicles at or below 14,000 lbs GVWR for measurement of both criteria pollutants and greenhouse gas emissions. The procedures in part 1066 cover the same requirements that have been included in 40 CFR part 86, but include more detailed specifications for how to measure exhaust emissions using a chassis dynamometer. They also reference large portions of 40 CFR part 1065 to align test specifications that apply equally to engine-based and vehicle-based testing, such as CVS and analyzer specifications, calibrations, test fuels, calculations, and definitions of many terms. Overall, the part 1066 procedures represent a modernization of the part 86 procedures rather than fundamentally different procedures.

Until this rule, testing requirements related to chassis dynamometers have relied on a combination of regulatory provisions, EPA guidance documents, and extensive learning from industry experience that has led to a good understanding of best practices for operating a vehicle in the laboratory to measure emissions. The revisions we are finalizing capture this range of material, integrating and organizing these specifications and procedures to include a complete set of provisions to ensure that emission measurements are accurate and repeatable.

This final rule includes the following revisions to part 1066:

- Clarification of regulatory requirements.
- Migration of mass-based emission calculations from part 86 to part 1066.
- Introduction of a new NMOG calculation.
- Revision of 40 CFR part 1066, subpart B, to increase the specificity with which part 1065 references are made as they pertain to testing equipment, test fluids, test gases, and calibration standards.
- Addition of coastdown procedures for light-duty vehicles.
- Reordering of the test sequence with respect to vehicle preparation and running a test.
- Specifying part 1065 procedures for PM measurement, including certain deviations from part 1065 for chassis testing.



- Insertion of detailed test specifications for vehicles certified under 40 CFR part 86, subpart S.

- Addition of provisions related to testing with four-wheel drive dynamometers, as described below.

- Correction of typographical errors.

We are finalizing the use of part 1065 for PM measurement with slight adjustments to the dilution air temperature, minimum dilution ratio, and background measurement requirements. By controlling the parameters that affect PM formation (dilution air temperature, dilution factor, sample residence time, filter face temperature, and filter face velocity), the procedures will reduce lab-to-lab and test-to-test variability.

The regulations being finalized will provide alternative approaches to sample PM onto different combinations of filters. One option is to collect a sample for phases 1 and 2 of the FTP on a single filter, and collect a sample for phases 2 and 3 of the FTP onto a second filter. Another option is to collect a sample for phases 1, 2, and 3 on a single filter. A final option is to sample PM emissions from two full UDDS cycles; however manufacturers choosing this option must still run a separate three-bag test for evaporative emission testing. We will continue to allow sampling under the traditional FTP methodology of a bag or filter per test phase (3 phases in total) instead of these new methods. We are also finalizing new PM sampling and calculation methods as proposed.

We are revising the chassis dynamometer specifications in part 1066 by removing the maximum roll diameter and by requiring speed and force measurements at a minimum frequency of 10 hertz (Hz). Some manufacturers may be interested in testing with nonstandard dynamometer configurations, such as new flat-track dynamometers or old twin-roll dynamometers. We may approve the use of these and other nonstandard dynamometer configurations as alternative procedures under 40 CFR 1065.10(c)(7).

We proposed that EPA may test vehicles with the capability of all-wheel drive operation with dynamometers operating in either two-wheel drive or four-wheel drive mode, regardless of the type of dynamometer that the manufacturer used for certifying the vehicle. However, the final regulations specify that we will conduct our testing using the same drive mode as the manufacturer. Vehicle manufacturers commented that differences in test results between a vehicle tested on a two-wheel drive and a four-wheel drive dynamometer might be due to

differences in dynamometer characteristics more than in vehicle operation. Results of a government-industry study that tested vehicles on both two-wheel and four-wheel drive dynamometers indicated fuel economy differences in the range of  $\pm 4\%$ , although the study was inconclusive with respect to the cause of the differences.<sup>421</sup> Based on the results of this study, we will continue to test vehicles during confirmatory tests using the manufacturer's dynamometer configuration for that vehicle, and that test will be the official certification result. We are, however, finalizing revisions to 40 CFR 1066.410(g) to clarify that we may also test the manufacturer's vehicle in a different dynamometer configuration than what was used for certification testing for information-gathering purposes. If we decide to perform this testing, we will depend on the manufacturer to cooperate in reconfiguring the test vehicle for our testing. We will continue to investigate the effects of four-wheel drive dynamometers on emission results and will not rule out possible future test procedure changes that might require certification of, or allow EPA to perform confirmatory testing on, any vehicle on a four-wheel drive dynamometer.

In their comments to this rulemaking, vehicle manufacturers stressed the importance to them that EPA use the same test procedures that they used for their certification testing when we perform confirmatory testing on their vehicles. Although the manufacturers did not explain the reasons for their comment, we presume that the manufacturers' concern relates to situations where EPA test procedures would lead to higher emission levels than those resulting from a slightly different test procedure used by a manufacturer. If so, the concern is misplaced. The purpose of EPA's test procedure flexibility provisions is not to allow manufacturers to use test procedures as a tool to enable compliance with the standards—in other words, to demonstrate compliance for engines that in the absence of the regulatory test procedure flexibility would not meet the standard. Rather, the purpose is to reduce the burden of testing. We go through the rulemaking process to establish the specified default test procedures as a means of creating an objective measure of compliance with emission standards. Where we also include alternative procedures, they

generally are not intended to change the conclusions from the rulemaking related to the stringency of the emission standards, or to lead to a different conclusion regarding compliance relative to the specified test procedures. EPA has addressed this issue previously for engine testing in § 1065.10(a), where we note that we condition the allowance to use alternate procedures on the provision that they would “not affect your ability to show that your engines comply with the applicable emission standards.” We note further that this provision “generally requires emission levels to be far enough below the applicable emission standards so that any errors caused by greater imprecision or inaccuracy do not affect your ability to state unconditionally that the engines meet all applicable emission standards.”

In a related context, § 1065.10(c)(1) explains that the intent of the test procedures is “to produce emission measurements equivalent to those that would result from measuring emissions during in-use operation”. This provision, which also applies for vehicle testing, envisions a process in which both the manufacturer and EPA can apply their engineering judgment to improve the representativeness of the testing. It would be appropriate for a manufacturer to ask EPA to modify our test procedures if the manufacturer believed EPA's test procedures would lead to results that were unrepresentative of in-use operation. However, it would not be appropriate to ask us to modify our test procedures to make them less representative of in-use operation.

The proposed rule included discussion of SI units as part of emission measurement procedures. At this time we are not converting emission standards to SI units. Note however that like part 86, part 1066 relies extensively on calculations involving physical parameters to calculate emission rates and perform various calibrations and verifications. As already reflected in part 1066, manufacturers have used a variety of units to perform these calculations. We would expect that dynamometers and other laboratory equipment are all capable of operating in SI units even if current practice in some laboratories is to use other units. Moving toward standardized units for calculations will allow us to more carefully and appropriately specify precision values for various measured and calculated parameters. This will also simplify calculations, facilitate review of results from different laboratories, and help with communications regarding any round robin testing that might occur.

<sup>421</sup> “Four Wheel Drive Dynamometer Meeting with the Alliance of Automobile Manufacturers and the Global Automakers,” EPA Memo from Chris Laroo, November 13, 2013.

As proposed, we will phase in the part 1066 test procedures for certifying all sizes of chassis-tested vehicles. All aspects of part 1066 related to PM testing must be met at the start of MY 2017 for vehicles certified to the PM standards. All other aspects of part 1066 must be met starting with the certification of MY 2022 vehicles. Manufacturers may begin using the part 1066 procedures before these deadlines, including step-wise changes to migrate gradually to part 1066 procedures. The regulations will require that good engineering judgment be used during this transition to ensure that the effective stringency of the standards is not changed. We recognize that individual differences between part 86 and part 1066 test procedures may have a slight upward or downward impact on measured emissions, even though the combined overall impact will be negligible. Thus, during the migration, care must be taken to avoid applying an unbalanced mix of changes that could bias emissions.

As described in Section IV.D, we are finalizing new test fuel specifications for E10 gasoline test fuel in 40 CFR part 1065. The test fuels specified for natural gas and liquefied petroleum gas, while not used for very many engine families, are currently following different specifications under 40 CFR part 86 and part 1065. We intend to revisit these fuel specifications in the future in the hope of adopting single, comprehensive fuel specifications for natural gas and liquefied petroleum gas that properly represent in-use fuels for highway and nonroad applications.

The proposal also included various technical amendments to 40 CFR part 1065, which we are finalizing largely as proposed. See the Summary and Analysis of Comments for a discussion of changes we have made in response to comments. Of particular note is the revision to subpart F specific to preconditioning engines with exhaust aftertreatment devices. We are also adopting test procedures for unregulated pollutants such as semi-volatile compounds (PAHs, etc.). These technical amendments, which have no effect on the stringency of any emission standards, include several minor changes to clarify regulatory requirements, align with chassis-testing procedures where appropriate, and correct typographical errors.

## 2. Reduced Test Burden

We are updating the regulatory provisions that allow manufacturers to omit testing for certification, in-use testing, and selective enforcement audits in certain circumstances.

Sections IV.A.3, IV.B.6, and IV.G.3 describe how this applies for demonstrating that vehicles meet the Tier 3 PM standards. We are also allowing manufacturers to omit PM measurements for fuel economy and GHG emissions testing that goes beyond the testing needed for certifying vehicles to the Tier 3 standards. Requiring such measurement would add a significant burden with very limited additional assurance that vehicles adequately control PM. We are also allowing manufacturers to ask us to omit PM and formaldehyde measurement for selective enforcement audits. If there is a concern that any type of vehicle would not meet the Tier 3 PM or formaldehyde standards, we will not approve a manufacturer's request to omit measurement of these emissions during a selective enforcement audit.

The existing regulations have allowed for waived formaldehyde testing for gasoline- and diesel-fueled vehicles. The Tier 3 NMOG+NO<sub>x</sub> emission standards are stringent enough that it is unlikely that vehicles will comply with the NMOG+NO<sub>x</sub> standards while exceeding the formaldehyde standards. We are therefore continuing this waiver practice, such that manufacturers of Tier 3 vehicles do not need to submit formaldehyde data for certification.

## 3. Miscellaneous Provisions

The following additional certification and compliance provisions are included in the final rule:

- The certification practice for assigned deterioration factors that are available for both small volume manufacturers and small volume test groups has matured significantly since it was first adopted. We are revising § 86.1826 to more carefully reflect the current practice. For example, the existing regulations specified that manufacturers with sales volumes between 300 and 15,000 units per year should propose their own deterioration factors based on engineering analysis of emission data from other families. We believe it is best for EPA to develop a set of assigned deterioration factors that can apply to all small volume manufacturers and small volume test groups. The revised regulation accordingly spells out a process for EPA to use available information to establish assigned deterioration factors that can be used for any number of manufacturers and test groups.

- The regulations in 40 CFR part 86 rely on rounding procedures specified in ASTM E29. This standard is revised periodically. The newer versions are not likely to change in a way that affects the regulation, but the updates make it

difficult to maintain a coordinated reference to the current protocol. We are addressing this by specifying that the rounding protocol described in 40 CFR 1065.20(e) applies, unless specified otherwise. We are not changing all the references in part 86; rather, we are defining "round" in subparts A and S to have the meaning given in 40 CFR part 1065 so that all new regulatory text would rely on this new description. The rounding specifications in 40 CFR part 1065 are intended to be identical to those in the latest versions of ASTM E29 and NIST SP811. For example, this now includes procedures for nonstandard rounding, such as rounding to the nearest 25 units, or the nearest 0.05, where that is appropriate.

- Independent Commercial Importers (ICIs) are companies that import specialized vehicles into the U.S. and are subject to EPA requirements specified in 40 CFR part 85, subpart P. The standards that apply to the imported vehicles depend in part on the vehicle's model year. Therefore, vehicles imported by ICIs in the future will eventually be subject to the Tier 3 standards. Because all existing ICIs are small businesses, the Tier 3 standards generally do not apply until 2022 at the earliest. In addition, the certification practices for ICIs have matured significantly since they were first adopted. EPA is adopting two changes to update how the regulations affect ICIs. First, we are adopting a requirement for ICIs to use electric dynamometers when running exhaust emission tests. Electric dynamometers have been required for many years for vehicle manufacturers, and EPA believes it is time to require that ICIs use such test equipment. In cases where an ICI can demonstrate that they will incur a substantial increase in compliance costs, the regulations include a provision allowing EPA to approve requests on a case-by-case basis to allow testing on other types of dynamometers until the ICI is able to use an electric dynamometer meeting current specifications. Second, we are adopting an allowance for ICIs to use a specific set of reduced testing procedures for up to 300 vehicles each year that have been modified to a U.S.-certified configuration. This has been allowed for ICIs since 1999 and was approved under EPA's authority to establish equivalent alternate test procedures.<sup>422</sup> Instead of running a full set of emission tests, the reduced-testing requirements allow ICIs to run an FTP for exhaust emissions, a highway fuel

<sup>422</sup> See 40 CFR 86.106–96(a) and Enclosure 2 to EPA Guidance letter CCD-02-04, February 6, 2002.

economy test, and the hot soak test and the one-hour diurnal emission test that applied prior to the evaporative emission test procedures that involve 24-hour cycling of ambient temperatures. We do not believe these changes will have any significant cost impacts on ICIs. Most ICIs have electric dynamometers or can upgrade for a relatively small cost. The reduced testing burden provisions keep the cost of testing low, compared to the cost of running a full set of emission tests that would otherwise be required.

- We are adopting CARB's onboard diagnostic requirements for light-duty vehicles, light-duty trucks, and heavy-duty vehicles at or below 14,000 lbs GVWR, as described in Section IV.C.5.d. We currently allow for this as an option, and almost all manufacturers do this already to avoid certifying multiple systems. Now that we are adopting evaporative provisions that are largely based on California's regulatory specifications and we are making efforts to adopt a single, national regulatory program, we believe this is an appropriate step. These changes apply starting in MY 2017 for vehicles subject to Tier 3 standards. In the case of alternative fuel conversions, we continue to apply the requirements of 40 CFR 86.1806–05.

#### 4. Manufacturer In-Use Verification Program (IUV) Requirements

The fuel on which an in-use vehicle will be operated and tested is considered an integral part of the vehicle's emission control system design. The Tier 2 program recognized that to achieve the desired emission reductions, vehicles must operate on the same fuel that the emission control system was originally designed to encounter in-use and during testing. In the Tier 2 program, we acknowledged that during the transition of the in-use fuel from sulfur levels of 300 ppm to 30 ppm average level, vehicles designed for 30 ppm could encounter in-use sulfur levels well above the level for which their emission control systems were designed. To address this issue, we allowed manufacturers, with agency approval, to perform specific preconditioning test procedures during the IUV testing to ensure that potential exposure to high sulfur fuel would not impact the emission test results. These procedures included specific drive cycles or maneuvers not regularly encountered during normal in-use operation that would result in removal of sulfur contamination from the emission control system.

Consistent with the Tier 2 program, EPA continues to recognize the

importance of the fuel to the emission control system design, particularly on Tier 3 vehicles designed to meet the most stringent emission levels of the program (i.e., Bin 70 and cleaner). Under the requirements of this final rule, in-use fuel will transition from an average sulfur level of 30 ppm to a new average level of 10 ppm. These sulfur requirements are average standards. Thus, even after the transition to the 10 ppm average sulfur level, vehicles may still encounter sulfur levels during in-use operation that are above 10 ppm, and as high as the 95 ppm cap, which could adversely impact the emission control system. Tier 3 vehicles tested by manufacturers in IUV that have been exposed to such sulfur levels could experience sulfur-related impacts, which in turn could cause the vehicle to temporarily exceed emission standards.

To address the potential emission impact on Tier 3 vehicles from exposure to higher sulfur levels, we are modifying the IUV testing process based in part on what was allowed under the Tier 2 program. Tier 3 vehicles tested in the IUV are to be tested initially without allowing any sulfur cleanout procedure, such as a US06 test run prior to the FTP or Highway Fuel Economy (HFET) tests. If a vehicle fails the NMOG+NO<sub>x</sub> standard for the FTP or HFET cycle during the initial round of testing, manufacturers may perform a sulfur cleanout procedure before repeating the FTP or HFET, consisting of up to two US06 cycles. The measured US06 cycle and a preconditioning US06 cycle, if performed as part of the initial measured tests would serve as the cleanout procedure and therefore no additional US06 cycles would be allowed. Alternative sulfur cleanout procedures would require EPA approval. Following the sulfur cleanout procedure, the manufacturer will prep and soak the vehicles and then repeat the FTP and HFET tests. Manufacturers choosing to perform the sulfur cleanout procedure would need to submit evidence that the vehicle encountered high sulfur levels in the fuel just prior to emission testing. This would need to include an analysis of a fuel sample from the vehicle fuel system as received from in-use operation just prior to testing. If the fuel sample indicated that the vehicle had been operating on fuel containing 15 ppm or higher sulfur levels, only the emission results of the tests following the cleanout procedure would be used to determine emission compliance and whether to enter the in-use compliance program (IUCP). We intend to monitor the emission results

of in-use testing and sulfur-related test failures to determine if further reductions in the sulfur cap are required to ensure that Tier 3 vehicles are meeting the standards under in-use driving conditions.

The changes to the IUV testing described above apply for light-duty vehicles, light-duty trucks, and MDPVs. These changes are not applicable to heavy-duty vehicles tested in the IUV program. Also, as described in Section IV.D, we are incorporating leak testing into the IUV test protocol.

## V. Fuel Program

Under today's Tier 3 program, we are finalizing reductions in gasoline sulfur levels nationwide. These standards will help reduce current levels of sulfur that contribute to ambient levels of air pollution that endanger public health and welfare. It will also help prevent the significant impairment of the emission control systems expected to be used in Tier 3 technology, significantly improve the efficiency of emissions control systems currently in use, and continue prevention of the substantial adverse effects of sulfur levels on the performance of vehicle emissions control systems.

### A. Overview

#### 1. Background

##### a. History of Gasoline Sulfur Control

Sulfur is naturally occurring in crude oil. Crude oil containing higher concentrations of sulfur (i.e., greater than 0.5 percent) is called "sour" and crude containing lower sulfur concentrations (e.g., West Texas Intermediate) is referred to as "sweet." Regardless of the concentration, because sulfur is naturally occurring in crude oil, it is also naturally occurring in gasoline. As discussed in Section IV.A, sulfur impairs the performance of today's vehicle emission control technologies (i.e., precious metal catalytic converters), reducing the emission benefits of current and advanced vehicles. As explained below, in 2000 EPA took action to reduce gasoline sulfur levels under what is known as the Tier 2 Program<sup>423</sup> and we are taking further action with today's Tier 3 Program.

Tier 2 was a major, comprehensive program designed to reduce emissions from passenger cars, light trucks, and large passenger vehicles (including sport utility vehicles, minivans, vans, and pick-up trucks) and the sulfur content of gasoline. Under this program, automakers were required to

<sup>423</sup> 67 FR 6698 (February 10, 2000).

manufacture low-emission vehicles when operated on low-sulfur gasoline, and refiners were required to produce low-sulfur gasoline nationwide.

Required reductions in gasoline sulfur under the Tier 2 program began in 2004 with refinery and importer caps of 300 ppm and a corporate average cap of 120 ppm. For most refiners and importers, compliance with the final sulfur standards (30 annual average and 80 per-gallon cap) was required beginning in 2006. The Tier 2 program was fully implemented on January 1, 2011 (the ultra-low sulfur diesel program allowed for some extensions of the Tier 2 gasoline program flexibility provisions). The Tier 2 gasoline sulfur program also included an averaging, banking, and trading (ABT) program that allowed companies to generate credits for implementing the required changes earlier than their required start date, and allowed ongoing flexibility to meet the 30 average sulfur standard.

At full implementation, the Tier 2 program (treating vehicles and fuels as a system) required passenger vehicles to be over 77 percent cleaner and gasoline sulfur to be reduced by up to 90 percent from pre-program levels.

#### b. Need for Additional Gasoline Sulfur Control

The authority under which we are lowering the existing gasoline sulfur standards comes from Clean Air Act section 211(c)(1). This is because emission products of gasoline with current levels of sulfur cause or contribute to air pollution which may reasonably be anticipated to endanger public health or welfare, and because emission products of gasoline with current levels of sulfur will impair to a significant degree the emissions control device or systems on the vehicles subject to today's final Tier 3 standards. For more on our legal authority to set gasoline sulfur standards, refer to Section V.M.

As explained in Section IV.A, robust data from many sources show that gasoline sulfur at current levels (i.e., around 30 ppm on average) continues to degrade vehicle catalytic converter performance during normal operation. NO<sub>x</sub> emissions are the most significantly affected by this degradation. The NMOG+NO<sub>x</sub> vehicle emission standards, representing an 80 percent reduction from current Tier 2 standards, will not be possible without the gasoline sulfur controls we are finalizing today. Today's 10 ppm sulfur standard should enable vehicle manufacturers to certify their entire product line of vehicles to the final Tier 3 fleet average standards. Tier 3 vehicles

must achieve essentially zero warmed-up NO<sub>x</sub> emissions to comply and must maintain this performance for up to 150,000 miles. An increase in emissions of only a few milligrams per mile due to sulfur could make compliance impossible for some vehicles. The standards are projected to be especially challenging for larger SUVs and pick-up trucks. Based on testing of these vehicles, as shown in Section IV.A, reducing gasoline sulfur to 10 ppm should enable these vehicles to maintain their emission performance in-use over their useful life. Lowering gasoline sulfur will also help reduce emissions of pollutants that endanger public health and welfare from vehicles already on the road today. As also discussed above in Section IV.A, we have tested a wide range of vehicles to better understand the impact that even lower gasoline sulfur could have on emissions. Our test data showed significant NO<sub>x</sub> and VOC reductions when vehicles were tested on low sulfur gasoline. As also explained in more detail in Section III.B, lowering average gasoline sulfur from 30 to 10 ppm will result in approximately 260,000 less tons of NO<sub>x</sub> and 50,000 less tons of VOC almost immediately as the Tier 3 gasoline sulfur standards take effect.

#### 2. Summary of Final Tier 3 Fuel Program Standards

The major elements of the fuel program being finalized today are summarized below. Please refer to sections V.B through V.J for more discussion on each of the elements summarized here.

##### a. Annual Average Sulfur Standard

Under today's final Tier 3 fuel program, gasoline and any ethanol-gasoline blend will be required to have a sulfur level of 10 ppm or less on an annual average basis beginning January 1, 2017. The 10 ppm average will apply to a refiner or importer's annual gasoline production. Similar to the Tier 2 gasoline program, the Tier 3 program applies to gasoline in the United States and the U.S. territories of Puerto Rico and the Virgin Islands, excluding California. Please see Section V.B for a more detailed discussion of the annual average sulfur standard.

##### b. Per-Gallon Sulfur Caps

Refiners and importers will continue to be subject to refinery gate per-gallon sulfur caps of 80 ppm. Similarly, gasoline downstream of the refinery gate (e.g., at terminals, retail stations, etc.) will continue to be subject to a 95 ppm per-gallon sulfur cap. We are also committing to continue to evaluate if

reductions in the per-gallon sulfur caps are warranted.

A more detailed discussion on our decision to continue the current 80 and 95 ppm per-gallon sulfur caps, and elements of an in-use study, can be found below in Section V.C.

##### c. Small Refiner and Small Volume Refinery Provisions

As described in further detail in Section V.E.1, approved gasoline small refiners and small volume refineries must produce gasoline meeting the 10 ppm annual average sulfur standard beginning January 1, 2020. Small refiners and small volume refineries who meet the 10 ppm sulfur standard prior to this date may generate credits for early Tier 3 program compliance.

##### d. Averaging, Banking, and Trading (ABT) Program

Section V.D discusses our averaging, banking, and trading (ABT) program. Refiners and importers may continue to generate credits for reductions in their gasoline sulfur levels below the current (Tier 2) 30 ppm average gasoline sulfur standard through December 31, 2016; and for reductions below the new 10 ppm average standard beginning January 1, 2017. These credits can be used for compliance with either the Tier 2 standard through 2016 or the Tier 3 standard beginning in 2017. The Tier 3 ABT program will have similar credit use provisions as the Tier 2 ABT program. These provisions include: Five-year credit life from the year of generation; two-trade limit for inter-company trading; and the ability to use credits internally, bank for future use, or trade to other refiners/importers. Although credits generated prior to January 1, 2017 will be valid for five years or until December 31, 2019, whichever is earlier.

##### e. Gasoline Additive Cap

As discussed further in Section V.C., manufacturers of gasoline additives that are used downstream of the refinery at less than 1.0 volume percent will be required to limit the sulfur contribution to the finished gasoline from the use of the additive to less than 3 ppm when the additive is used at the maximum recommended treatment rate. For each batch of additive produced, the manufacturer must retain sulfur test records for 5 years, and must make these records available to EPA upon request.

Parties that introduce additives to gasoline at over 1.0 volume percent will be required to satisfy all of the obligations of a refiner and fuel manufacturer, including demonstration

that the finished blend meets the applicable sulfur specification.

f. Requirements for Denatured Fuel Ethanol and Other Gasoline Oxygenates

Today's rule finalizes a 10 ppm sulfur cap for denatured fuel ethanol (DFE). While DFE is the predominant gasoline oxygenate currently in use, these standards also apply to other gasoline oxygenates. Today's rule finalizes a 3.0 volume percent limit on ethanol denaturant concentration. We are adopting the current ASTM International specifications that only natural gasoline, gasoline blendstocks, or gasoline may be used as denaturants for DFE.<sup>424</sup> As discussed in the Summary and Analysis of Comments, we believe it is not necessary to finalize the proposed additional limits on the potential denaturants that may be used at this time. We are also finalizing regulatory text to state that DFE must be composed solely of carbon, hydrogen, oxygen, and sulfur. Testing, recordkeeping, and reporting obligations are also being finalized to implement these new standards as discussed in Section V.G. Sulfur testing using approved analytical methods or volumetric blending records and denaturant product transfer documents (PTDs) can be used by manufacturers/importers of DFE in demonstrating compliance with the 10 ppm sulfur cap for DFE finalized today.

g. Fuel Used in Flexible Fuel Vehicles

As discussed in Section V.H., we are deferring finalizing additional fuel quality requirements for E16–50 and E51–83 at this time. We continue to believe in the importance of implementing additional fuel quality standards for higher-level ethanol blends and will continue to work with stakeholders in their development following the publication of this final rule.

h. Standards for Butane and Pentane

As discussed further in Section V.I, we are finalizing a 10 ppm sulfur cap for butane blended into gasoline effective January 1, 2017. This is consistent with the Tier 3 10 ppm refinery average sulfur specification finalized today. In addition, as discussed below in Section VI.A.4, we are also finalizing provisions to allow pentane to be blended into gasoline downstream of the refinery. These provisions are similar to the existing provisions for butane blending. This allowance will become effective

June 27, 2014; a 30 ppm sulfur cap will apply to pentane blended into gasoline (consistent with the existing sulfur cap for butane under the Tier 2 program) until December 31, 2016, after which a 10 ppm sulfur cap will apply.

i. CNG/LPG

As discussed below in Section V.J., we are deferring establishing in-use sulfur requirements for compressed natural gas (CNG) and liquid propane gas (LPG) to provide additional time to work with stakeholders to collect data on current CNG/LPG sulfur content; to determine whether additional control of in-use CNG/LPG sulfur content is needed; and to evaluate the feasibility and costs associated with potential additional sulfur controls.

B. Annual Average Sulfur Standard

Under today's final Tier 3 fuel program, gasoline and any ethanol-gasoline blend will be required to have a sulfur level of 10 ppm or less on an annual average basis beginning January 1, 2017. The 10 ppm average will apply to a refiner or importer's annual gasoline production. Similar to the Tier 2 gasoline program, the Tier 3 program applies to gasoline in the United States and the U.S. territories of Puerto Rico and the Virgin Islands, excluding California. We are finalizing the 10 ppm average sulfur standard both to enable the new vehicle fleet to meet the Tier 3 vehicle standards being finalized today pursuant to CAA section 211(c)(1)(B), and to reduce emissions from the existing in-use vehicle fleet that endanger public health and welfare pursuant to section 211(c)(1)(A) of the Clean Air Act (CAA).

We received numerous comments both in support of and against the proposed 10 ppm annual average sulfur standard. Commenters opposing the standard believe that 10 ppm is too low and/or is not needed to enable Tier 3 vehicle technologies. Some commenters suggested that EPA should consider setting a less stringent sulfur standard than the proposed 10 ppm annual average (detailed information regarding the comments can be found in the Summary and Analysis of Comments document, which is located in the docket for this rulemaking). We believe that a 10 ppm annual average standard will help reduce current levels of sulfur that contribute to ambient levels of air pollution that endanger public health and welfare. It will also help prevent the significant impairment of the emission control systems expected to be used in Tier 3 technology, significantly improve the efficiency of emissions control systems currently in use, and continue

prevention of the substantial adverse effects of sulfur levels on the performance of vehicle emissions control systems. This level is also feasible, and is the level that appropriately balances costs with the emission reductions that it provides and enables.

As discussed in Section IV.A.6., and further in Chapter 5 of the RIA, we believe that a standard of 10 ppm is appropriate, and when combined with the advances in emissions control technologies will be sufficient to meet the Tier 3 emissions standards. The feasibility of the 30 mg/mi NMOG+NO<sub>x</sub> fleet average depends on exhaust catalyst systems that require gasoline with average sulfur levels of 10 ppm or less. Further, annual average sulfur levels greater than 10 ppm would significantly impair the emission control technology that we expect will be used to meet the Tier 3 standards and to ensure in-use compliance over a vehicle's useful life. This is particularly a concern for some larger vehicles that will need to reduce NO<sub>x</sub> to near-zero levels, due to greater difficulty in reducing cold-start NMOG, in order to meet a combined NMOG+NO<sub>x</sub> standard. As discussed in Section IV.A.6, increasing gasoline sulfur from 10 ppm to 20 ppm or 30 ppm would make it impossible for vehicle manufacturers to meet the Tier 3 standards. Achieving Tier 3 standards would require offsetting the resultant higher emissions but EPA is not aware of existing technology or developing technology that could address these higher emissions when taking into consideration the entire vehicle fleet. Increasing gasoline sulfur from 10 ppm to 20 ppm or 30 ppm would also forego the very large immediate reductions from the existing fleet.

We also do not believe a sulfur standard lower than 10 ppm is necessary to enable vehicles to meet the Tier 3 standards. As also discussed in Section IV.A, reducing sulfur below 10 ppm would further reduce vehicle emissions and allow the Tier 3 vehicle standards to be achieved more easily. However, we believe that a 10 ppm average standard is sufficient to allow vehicles to meet the Tier 3 standards. Furthermore, as discussed below, there are significant challenges associated with reducing sulfur below 10 ppm.

As explained in Section IV.A, sulfur in fuel oxidizes in the exhaust and coats the sites where chemical reactions can take place on the precious metal catalysts used in vehicles to reduce emissions of VOC, NO<sub>x</sub>, PM, CO, and toxics. Accordingly, any sulfur in gasoline causes vehicle emissions to

<sup>424</sup> ASTM D4806–13a, "Standard Specification for Denatured Fuel Ethanol for Blending with Gasoline for Use as Automotive Spark-Ignition Engine Fuel".

increase. Sulfur can be burned off the catalyst during high-temperature, rich operation of the vehicle (i.e., aggressive driving conditions), but as long as there is any sulfur in the fuel, exhaust emissions will increase. Because any amount of sulfur in the fuel can have this effect, the lower the sulfur the better. Refiners experience the same phenomenon with precious metal catalysts used in the reformer and isomerization units at their refineries.<sup>425</sup> To protect the precious metal catalysts in these units, refiners reduce the sulfur in the feed to these units to 1 ppm or below. Thus, it is technically possible for refiners to reduce their gasoline sulfur levels to virtually zero. While refiners did not have reason to reduce the sulfur in FCC gasoline until Tier 2 required such reductions, some refiners have achieved reductions in this stream at some of their refineries for other reasons such as: (1) Protecting the FCC catalyst from the contaminants in the gas oil feed, (2) reducing stack emissions from the regenerator of the FCC unit, and most importantly (3) increasing gasoline yields from the FCC unit. For most refineries, FCC gasoline accounts for about one-third of gasoline and before Tier 2 was the source of over 95 percent of the sulfur in gasoline. Under Tier 2, most refiners significantly desulfurized FCC gasoline to around 70 to 80 ppm, yet FCC gasoline continues to contribute the majority of sulfur in gasoline today.

An annual average sulfur level of 10 ppm will achieve very large immediate reductions from the existing fleet, as discussed in Sections III and IV. Because any sulfur in gasoline will continue to impair vehicle catalyst performance, reducing sulfur levels to zero would maximize vehicle emission reductions. However, there are two reasons why we believe a 10 ppm average sulfur standard is sufficient and further reductions (e.g., 10 ppm cap or 5 ppm average) are not necessary at this time. First, our analysis shows that a 10 ppm annual average is sufficient to enable vehicles to reach the Tier 3 standards. Consequently, while reducing sulfur levels further would continue to yield reductions from the in-use fleet, they would not be necessary to enable the new Tier 3 vehicle standards to be met. Second, while sulfur levels would continue to reduce emissions from the existing fleet, reducing sulfur further below 10 ppm becomes increasingly difficult and costly. FCC naphtha is very rich in high-

octane olefins. As the severity of desulfurization increases, more olefins are saturated, further sacrificing the octane value of this stream and further increasing hydrogen consumption. Making up for this lost octane represents a significant portion of the sulfur control costs. Furthermore, as desulfurization severity increases, there is an increase in the amount of sulfur removed (in the form of hydrogen sulfide) which recombines with the olefins in the FCC naphtha, thus offsetting the principal desulfurization reactions. There are means to deal with the recombination reactions, but they result in even greater capital investments. In addition, while FCC gasoline contributes the majority of sulfur to the finished gasoline, as the sulfur level drops below 10 ppm, the sulfur level of the various other gasoline streams within the refinery also become important. Any necessary treatment of these additional streams increases both capital and operating costs.

U.S. refineries are currently in different positions, both technically and financially. In general, they are configured to handle the different crude oils they process and turn them into a widely varying product slate to match available markets. Those processing heavier, sour crudes may have a more challenging time reducing gasoline sulfur under the Tier 3 program. Also, those with higher sulfur levels in other refinery streams may have a more difficult time desulfurizing gasoline. Perhaps most important, U.S. refineries vary greatly in size (atmospheric crude capacities range from less than 5,000 to more than 500,000 barrels per day) and thus have different economies of scale for adding capital to their refineries. Therefore, it can be less costly per gallon for some larger refineries to get down to 10 ppm than for smaller refineries, as discussed in Chapter 5 of the RIA. As a result, with a 10 ppm average standard, the flexibility afforded by the ABT program helps those refineries with very high costs. They have the option of staying above 10 ppm if they can acquire credits from other refineries that were able to lower their sulfur level below 10 ppm. However, if the gasoline sulfur standard were lower, this would essentially end the ability of refiners to average sulfur reductions across their refineries. There simply would not be enough opportunity to generate credits at levels much below 10 ppm.

As discussed further in Chapter 5 of the RIA, we assessed the potential costs of an annual average standard lower than 10 ppm (e.g., 5 ppm). Our analysis shows that sulfur control costs for

refineries to meet a standard below 10 ppm could be on the order of two times more costly per ppm-gallon of gasoline sulfur reduced. In addition, a standard below 10 ppm could be cost-prohibitive for more challenged refineries. Further, such a standard would also introduce additional costs to address the contribution to gasoline sulfur from gasoline additives, transmix, ethanol denaturants, and contamination in the distribution system.

Therefore, we believe that the 10 ppm annual average standard will help reduce current levels of sulfur that contribute to ambient levels of air pollution that endanger public health and welfare. It will also help prevent significant impairment of the emission control systems expected to be used in Tier 3 technology, significantly improve the efficiency of emissions control systems currently in use, and continue prevention of the substantial adverse effects of sulfur on the performance of vehicle emissions control systems. The level is also feasible (especially considering its associated ABT provisions, described in Section V.D), and is the point which appropriately balances costs with the emission reductions that it provides and enables.

### C. Per-Gallon Sulfur Caps

#### 1. Standards

The final Tier 3 program is composed of a 10 ppm refinery annual average sulfur standard (discussed above in Section V.B) with an 80 ppm per-gallon cap at the refinery gate and a 95 ppm per-gallon cap downstream; these per-gallon caps currently exist under the Tier 2 program. We believe this is the most prudent approach for lowering in-use sulfur while maintaining flexibility considering cost and other factors. These per-gallon caps are important in the context of an average sulfur standard to provide an upper limit on the sulfur concentration that vehicles must be designed to tolerate. The caps also limit downstream sulfur contamination and enable the enforcement of the gasoline sulfur standard in-use. Our 10 ppm average standard with higher per-gallon caps compares to a 10 ppm cap standard in much of Europe, Japan, and Korea. In addition to the gasoline standards we are finalizing today, we are also finalizing caps on the sulfur content of gasoline additives, to limit their contribution to the overall in-use gasoline sulfur level.

#### a. What We Proposed

We proposed two options for the per-gallon sulfur caps—maintaining the Tier 2 80 ppm refinery gate sulfur and 95

<sup>425</sup> Together, the streams from the reformer and isomerization units account for approximately one-third of gasoline.

ppm downstream sulfur caps and, beginning January 1, 2020, lowering to 50 ppm refinery gate and 65 ppm downstream caps. The 50 ppm refinery gate cap was proposed to take effect on January 1, 2020, as this is the date when the small refiner, small volume refinery, and early credit use provisions would expire; and also to avoid forcing additional refinery investments during the early credit usage period. We also requested comment on lowering the caps to 20 ppm at the refinery gate and 25 ppm downstream.

We received comments on both of the proposed per-gallon cap options of 80/95 ppm and 50/65 ppm, as well as comments on finalizing lower caps of 20/25 ppm and a 20 ppm overall cap. Comments supporting lower caps noted potential environmental benefits, greater certainty that vehicles would see lower and more uniform gasoline sulfur levels, and enabling new vehicle technologies that require very low sulfur levels. Comments in support of maintaining the current Tier 2 caps cited concerns on cost, flexibility for turnarounds/unplanned shut downs (due to refinery fire, natural disaster, etc.), and potential impacts on gasoline supply and pricing. Detailed information regarding the comments we received on the per-gallon sulfur caps is provided in the Summary and Analysis of Comments document, which is available in the rulemaking record.

#### b. Final Refinery Gate Sulfur Cap

In today's action, we are retaining the 80 ppm refinery gate cap. The refinery gate cap provides flexibility for batch-to-batch variability that naturally occurs at a refinery due to the varying types of crude that refineries process, variations in unit operations, and variations in product mix. It further provides for flexibility during unit turnarounds, and unplanned upsets (e.g., refinery fires, natural disasters, etc.), to avoid a complete refinery shutdown. A lower cap could create situations where refiners would need to store more off-spec gasoline for future processing. However, if a refinery does not have adequate tankage for storing this product, and/or if its processing units are not large enough to "catch up" in refining off-spec product, it could result in significant impacts to fuel pricing or supply. For a refiner that produces multiple products, any potential supply impacts could also impact other fuel markets (e.g., diesel, jet fuel, etc.). Additionally, the refinery gate cap is a "hard" limit—a refinery's actual production has to be well below this limit to account for in-use testing tolerances, safety margins, and any

additives that a refiner may need to add prior to the fuel leaving the refinery. An 80 ppm refinery gate cap will provide refiners needed flexibility, and more certainty that they will be able to continue producing and distributing at least some gasoline during turnarounds/upsets to avoid a total shutdown. It will further provide more certainty for transmixture processors, additive manufacturers and other downstream parties.

As described below in Section VII, we believe that most refineries would not have significant costs as a result of the Tier 3 program because they will be able to meet the 10 ppm average sulfur standard largely through revamps and operational changes at their facilities, rather than installing grassroots units. Lowering to a cap of 50 ppm would directionally increase the costs of the Tier 3 program. The American Petroleum Institute (API) provided a detailed study with their comments<sup>426</sup> quantifying the additional costs associated with successively more stringent per-gallon caps. While we do not agree with the study's overall cost analysis, we do agree that with a refinery gate cap of 50 ppm, a number of refiners would incur higher capital costs due to the decreased ability to handle off-spec product with a lower refinery gate cap. As refiners must ensure that they can continue to produce saleable product and meet demand in the event of an upset or an off-spec batch of fuel, the need for installation of additional tankage and/or increased refinery processing capability would be greater with a 50 ppm refinery gate cap. While at the time of the proposal we believed that a cap of 50 ppm would have little cost impact, our more recent analysis shows that a 50 ppm cap would increase the cost of the Tier 3 gasoline sulfur standards by approximately 10 percent (see RIA Chapter 5.2.2.4). At the same time, the more stringent cap with its associated increase in cost would be unlikely to provide significant additional emission benefits nationwide. As discussed previously in Sections III and IV above, the emissions benefits associated with the Tier 3 program are mainly driven by the reduction in the average sulfur content of gasoline from 30 to 10 ppm, since vehicle emissions are proportional to the sulfur content of the fuel. Changes in the cap would not affect this. In the context of the final ABT provisions, a

higher cap does allow for increases in emissions on a temporal basis as one batch of fuel is allowed to have higher sulfur levels. However, this is then offset by reductions in emissions from batches of fuel that are then required to be below the 10 ppm average standard. Similarly, the final ABT provisions allow for the possibility that the fuel from different refineries will cause varying emission reductions as one refinery's higher average sulfur levels would lead to less emission reductions in-use. However, this is then offset by greater reductions in emissions due to the fuel produced by refineries with sulfur levels below the average standard.

Based on our cost analysis, which is discussed below in Section VII.B., we project nearly 40% of the gasoline pool would be at 5 ppm, about 45% at 10 ppm and the remaining approximately 15% at levels higher than 10 ppm. The sulfur level for this 15% in our analysis ranges from 11 ppm all the way up to 70 ppm. However, as discussed in Section VII.B., these high sulfur levels are more a function of the limitations of our analysis where we could only model these refineries as remaining at their current Tier 2 sulfur levels. We anticipate that in most (if not all) cases refineries will make operational changes and/or investments in order to reduce their credit burden and reduce their compliance costs. This anticipation, along with the fact that a 10 ppm average standard by definition limits the amount of gasoline that can remain at higher sulfur levels (regardless of the cap), means that we anticipate most refineries, including those using credits, will still average less than 20 or 30 ppm in their physical gasoline production. Nevertheless, the final ABT program does allow for the possibility (regardless of the cap) that were this higher sulfur fuel to be concentrated in any certain geographical area, it would not receive the full emission reductions from the Tier 3 program. We have considered the potential for areas to consistently receive fuel that might be predominantly higher than the 10 ppm average. Because refineries generating credits and using credits are interspersed across the country, and because most areas receive a considerable portion of their fuel by pipeline, barge, rail, or truck from refineries in other areas, we expect the variation in average sulfur levels across the country to be too limited to warrant lowering the per-gallon cap to 50 ppm. Given the stringency of the 10 ppm average standard, we predict that in-use

<sup>426</sup> "Economic and Supply Impacts of a Reduced Cap on Gasoline Sulfur Content; Prepared for the American Petroleum Institute"; Turner, Mason & Company. Document number: EPA-HQ-OAR-2011-0135-4285; API-APPM Attachment 13.



sulfur levels will generally be well below 50 ppm.

Further reductions in the refinery gate cap are also not needed to enable the vehicle emissions standards, as the vehicle standards are a function of the 10 ppm annual average sulfur standard. While vehicle manufacturers have expressed concerns about the potential impacts on emissions performance if individual vehicles are exposed to gasoline above 10 ppm due to higher per-gallon caps and/or credit usage,<sup>427</sup> we believe that vehicles will see sulfur levels closer to the 10 ppm average rather than the 80 ppm cap due to the fact that the 10 ppm average will drive reductions in gasoline sulfur levels.

Thus, we believe it is prudent at this time to retain an 80 ppm refinery gate cap. However, we are committing to monitor and further evaluate in-use sulfur levels and their impact on vehicle emissions. If it is warranted, we will reassess the sulfur cap level and the need for potential future regulatory action. Such ongoing evaluation will include analyses of: In-use fuel surveys; batch data that refineries are required to submit; and the sulfur credit market. It will also include the evaluation of any issues or concerns that might arise during implementation of the program. Finally, we will also carry out an ongoing evaluation of data submitted by the vehicle manufacturers on the performance of their Tier 3 vehicles in-use.

#### c. Downstream Sulfur Cap

With regard to the downstream sulfur cap, we believe that maintaining a 15 ppm differential between the refinery gate sulfur cap and the downstream sulfur cap will provide pipeline operators, transmix processors, and gasoline additive users the same flexibility as was provided under the Tier 2 program. As was the case under the Tier 2 program, allowing a 15 ppm differential is needed to ensure adequate flexibility in accommodating gasoline produced from transmix, instances of contamination during distribution, and for the use of necessary (sulfur-containing) additives. In rare circumstances when the sulfur contribution from all these sources are coincidentally at their maximum levels, a very limited number of batches of gasoline at the 95 ppm downstream sulfur cap may be present in the distribution system. However, we expect that this will not have a substantial impact on the average sulfur

content of in-use gasoline. Comments received on this issue were generally in support of maintaining the 15 ppm delta.

Pipeline operators are currently allowed to blend limited volumes of transmix into gasoline in their systems provided that the resulting gasoline meets all fuel quality specifications and the endpoint of the blended gasoline does not exceed 437 °F.<sup>428</sup> This enables pipeline operators to avoid the installation of additional transmix storage and loading equipment at a number of remote locations to facilitate shipping small volumes of transmix to processing facilities by truck.

Currently transmix processors must produce gasoline sufficiently below the 95 ppm downstream sulfur cap to accommodate any downstream sulfur increases from the use of gasoline additives and contamination from further distribution. The sulfur content of the gasoline produced by transmix processors is determined by the sulfur content of the transmix they receive, which in turn is primarily a function of the sulfur content of gasoline and jet fuel components in the transmix.<sup>429</sup> Transmix processors do not handle sufficient volumes to support the installation of currently available desulfurization units.<sup>430</sup>

#### d. Accounting for Ethanol Blending in the Determination of Compliance With Gasoline Sulfur Requirements

In demonstrating compliance with the gasoline sulfur standards finalized today, gasoline refiners and importers may adjust the sulfur levels in the gasoline and blendstocks for oxygenate blending (BOBs) that they produce/import to account for the downstream addition of ethanol. We proposed that the sulfur content of denatured fuel ethanol (DFE) used for downstream blending would be assumed to be 10 ppm in making such demonstrations of compliance. Refiners commented that refiners and importers should be allowed to either use the actual sulfur value of the DFE or conduct laboratory

<sup>428</sup> The requirements for transmix blenders are contained in 40 CFR 80.84(d). 437 °F is the maximum endpoint allowed for gasoline in ASTM D4814.

<sup>429</sup> Transmix is a by-product of the multi-product pipeline distribution system. 40 CFR 80.84(a) defines transmix pipeline interface that does not meet the specifications for a fuel that can be used or sold, and that is composed solely of any combination of: Previously certified gasoline (including previously certified gasoline blendstocks that become gasoline solely upon the addition of an oxygenate); distillate fuel; or gasoline blendstocks that are suitable for use as a blendstock without further processing.

<sup>430</sup> Transmix processors produce ~0.1 percent of the gasoline consumed in the U.S.

hand blends of a representative sample of DFE to determine the effect on the sulfur content of the blended fuel from the addition of DFE. We agree that refiners and importers should be allowed to use the actual sulfur content of DFE when a sulfur test result is available and when the refiner can demonstrate that the test result was derived from a representative sample of the DFE that was blended with the gasoline or BOB. The sulfur content of in-use DFE will typically be lower than the 10 ppm sulfur cap finalized today for DFE. We assumed that DFE would have an average sulfur content of 5 ppm in conducting the refinery analysis to support this rule. Therefore, today's final rule requires that in determining their compliance with today's sulfur standards, refiners and importers must either use the actual sulfur content of the DFE established through testing of the DFE actually blended or assume a 5 ppm sulfur content for the DFE added downstream. To prevent potential bias, a refiner or importer must choose to use only one method during each annual compliance period.

#### 2. Requirements for Gasoline Additives

Today's action finalizes the requirement that manufacturers of gasoline additives used downstream of the refinery at less than 1 volume percent must limit the sulfur contribution to the finished gasoline from the use of their additive to no more than 3 ppm when the additive is used at the maximum recommended treatment rate. The additive manufacturer will be required to maintain records of its additive production quality control activities which demonstrate that the sulfur content of additive production batches is such that when the additive is used at its maximum recommended treatment rate it will add no more than 3 ppm to sulfur content of the finished gasoline. We received comments in support of our proposed requirements (these comments can be found in the docket to this rulemaking, and are summarized in the Summary and Analysis of Comments document, which is also located in the docket). An environmental organization commented that the sulfur contribution from additives can have a material effect on emissions performance given the level of vehicle emissions control that is being finalized today. We also received comments from gasoline additive manufacturers were in favor of the proposed controls.

The requirements finalized today are designed to prevent the potential dumping of high sulfur materials into

<sup>427</sup> Alliance of Automobile Manufacturers (2011, October 6). Letter to EPA Administrator, Lisa Jackson.

gasoline under the guise of the addition of gasoline additives. We continue to believe that all current gasoline additives contribute less than 3 ppm to the sulfur content of the finished fuel when used at the maximum recommended treatment rate (with 3 ppm being the extreme). Normal additive production quality control practices already have had to consider the sulfur contribution of the additive to finished gasoline as a result of the Tier 2 gasoline sulfur requirements. The maximum recommended treatment rate is already stated on product transfer document or packaging for the additive. Additive manufacturers are to retain production quality control records for 5 years and make these available to EPA upon request. Therefore, the requirements finalized today will not constrain the use of genuine gasoline additives or result in significant additional costs to gasoline additive manufacturers. Parties that introduce additives to gasoline at over 1.0 volume percent are required to satisfy all of the obligations of a refiner and fuel manufacturer including demonstration that the finished blend meets the applicable sulfur specification.

We also received comments from an environmental organization requesting that EPA promulgate limits on the combined sulfur contribution for all additives blended into a batch of gasoline in addition to controlling the sulfur contribution from individual additives. We believe that such additional controls are not necessary, would add an unwarranted additional compliance burden, and could interfere with the use of necessary downstream additives. Certain additives that provide critical fuel performance characteristics (e.g., corrosion control, demulsifiers) contain sulfur-containing compounds as an essential functional component. Such additives are used to remedy specific instances of gasoline quality problems, and their treatment rate is governed by the desire to limit the added cost from their use.

#### *D. Averaging, Banking, and Trading Program*

In today's rule, we are finalizing an ABT program that will reduce the compliance costs and promote the feasibility of the Tier 3 gasoline sulfur program, because it will allow refiners and importers to choose the most economical compliance strategy (i.e., investment in technology, credits, or both) to meet the 10 ppm average sulfur standard. In response to comments received on our proposal, we have simplified and added flexibility to the ABT program. The ABT program allows

refiners and importers to continue to generate credits for overcompliance with the current Tier 2 30 ppm average gasoline sulfur standard through 2016, and the new 10 ppm average standard beginning in 2017. (Small refiners and small volume refineries have a January 1, 2020 compliance date, as described below.) These credits can be used for compliance with either the Tier 2 standard through 2016 or the Tier 3 standard beginning in 2017. Credits can also be banked for future use or transferred to other refineries for compliance with the average sulfur standard. In addition, we are allowing refiners and importers to also use any valid credits banked from 2012 and 2013 under the Tier 2 program toward compliance with either the Tier 2 or Tier 3 sulfur programs. We believe these provisions will provide a seamless transition from Tier 2 to the Tier 3 program.

#### 1. How will the ABT program assist with compliance?

The Tier 3 ABT program allows refiners and importers the flexibility to: (1) Have varying gasoline sulfur levels for their batches of fuel as long as they meet the 10 ppm average over the course of the year; (2) use credits generated at one of its refineries to offset higher sulfur gasoline produced at another of its refineries; (3) bank generated credits for future use; and (4) participate in trading (via buying and/or selling) of credits from another refiner to help lower costs. The ABT program allows for the generation of credits by refiners and importers for over-compliance with the 10 ppm sulfur standard (on a refinery/facility basis), and for the transfer of these credits to other refiners (for use a refinery) to reduce or eliminate their need to make capital investments to meet the 10 ppm standard. The ABT program will provide refiners and importers with multiple approaches to compliance, and each can choose the approach that best minimizes their costs.

#### 2. ABT Modeling

For the proposed rule, we modeled the effects of an ABT program on refinery compliance. Our modeling determined the lowest cost approach on a refinery-by-refinery basis under two scenarios: The first, in which every refinery has the opportunity to make credit transfers with every other refinery in the nation, and a more limited scenario in which credit transfers would only occur within companies that own more than one refinery.

In developing today's final program, we also analyzed the Tier 2 credit

market and found that, currently, Tier 2 sulfur credits are both transferred within companies (intra-company) and traded between companies (inter-company). As discussed in Chapter 4.3 of the RIA, in 2012 approximately 56% of the Tier 2 credit transactions were inter-company trades. The remaining 44% were intra-company trades. This analysis shows that there is a functioning, well-established gasoline sulfur credit trading market. There does not appear to be any hindrance to credit trading currently or in the future. We anticipate that a significant number of refineries will take advantage of the opportunity to generate or use credits, thus lowering their compliance burden for the Tier 3 program. For a more complete discussion of our analysis of credit trading and the associated cost impacts of the ABT program, refer to Chapter 4.3 of the RIA.

#### 3. Eligibility

Consistent with our proposal, under today's final program, sulfur credits may be generated by both U.S. refiners and importers of gasoline into the U.S. only for gasoline that is subject to the sulfur requirements as described in the regulations at § 80.1603. This excludes gasoline produced or imported for use in California ("California gasoline") and gasoline designated for export, but includes gasoline produced by California refineries for use outside the state. We sought comment in the proposed rule on whether or not to include California. All comments received on this issue were against the inclusion of such gasoline in the ABT program, largely because it would cause additional burden but provide no appreciable credits to the market to justify the additional compliance burden (such as batch reporting). We agree with these comments, and are finalizing the provision that California gasoline and gasoline for export will not be included in the ABT program. In order to exclude exported gasoline and California gasoline, refiners must keep records to demonstrate that the excluded gasoline was designated for export or as California gasoline, and was actually exported or used in California.

While under existing fuel programs (e.g., MSAT2), we precluded importers from generating "early" credits (credits generated before a program start date), we are allowing importers to generate early credits in the Tier 3 ABT program, consistent with our proposal. Importers were previously precluded from generating early credits because they generally did not need additional lead time to comply with our fuel standards (as they most likely would not be

investing in new refining technologies) and we also thought it would be difficult for them to establish representative baselines from which early credits could be generated. However, early credit baselines are not a part of the Tier 3 program, as discussed above. In addition, commenters noted that while importers may not necessarily have to take actions to desulfurize fuel like domestic refiners do, these parties may have to pay premiums on obtaining lower sulfur fuel, thus their efforts to provide lower sulfur fuel should also be able to generate early credits. Thus, we are finalizing provisions allowing importers to generate early credits for sending over-compliant gasoline to the United States prior to January 1, 2017.

We proposed to limit credit generation to refiners and importers. Under the Tier 2 gasoline program, we allow refiners who produce gasoline by combining blendstocks together or adding blendstocks to previously certified gasoline (refiner-blenders) to participate in the in the sulfur ABT program, but do not allow butane blenders who comply with the reduced sampling, testing, and reporting requirements to participate in the sulfur ABT program.<sup>431</sup> We are extending these provisions to butane and pentane blenders under the Tier 3 program.<sup>432</sup> Under today's rule, any refiner who uses the reduced sampling, testing, and reporting provisions for blending butane or pentane into gasoline will not be allowed to generate credits. Refiner-blenders who comply with the full suite of sampling, testing, and reporting requirements will, however, be allowed to generate credits.

We received several comments from ethanol producers and Growth Energy (representing ethanol producers), who commented that DFE should be subject to an annual average sulfur standard and that ethanol producers should be able to participate in the ABT program that is available to refiners and importers of gasoline. These commenters stated that preventing them from participating in the ABT program would provide refiners with pathways to allow delayed adoption of cleaner fuel standards at their expense. Some ethanol producers commented that they should be allowed to participate in the ABT program as a means of offsetting the additional cost of the proposed per-batch sulfur testing and reporting requirements. We also received

comments from refiners stating that credit generation should be permitted only for refiners and importers.

As in existing EPA fuel programs, we continue to believe that it is not appropriate to expand the ABT provisions to cover ethanol producers and oxygenate blenders for several reasons. First, expanding the ABT program beyond refiners and importers could greatly increase the number of parties participating thereby potentially complicating EPA compliance assurance activities while having little overall impact on the sulfur credit pool. Second, the current ABT program under the Tier 2 gasoline sulfur program, which is limited to gasoline refiners and importers, has functioned effectively with few compliance irregularities. Third, experience with the unleaded gasoline program suggests widespread abuse and fraud when credits have been allowed to be generated or sold by parties other than refiners or importers subject to the regulations. Fourth, it would require a considerably more complicated compliance structure, including the application of all refiner responsibilities to ethanol producers and blenders. Fifth, there is no need for DFE producers to generate credits in order to recoup the value for any lower sulfur content of their product. The value of any lower sulfur content will be reflected in the market price of DFE, similar to the octane value to refiners. Sixth, the sulfur ABT provisions were included to ease the burden of compliance for refiners who have to make capital changes to their facilities to meet today's more stringent sulfur standards. In addition to reducing the cost of today's gasoline sulfur program, the ABT provisions allow for an earlier effective date of the sulfur standards than would otherwise be possible. Such considerations are not applicable to ethanol producers since capital expenditures for desulfurization equipment or other equipment will not be needed at their facilities to comply with the sulfur standards finalized today.<sup>433</sup> Finally, overcompliance with the per-gallon sulfur cap for DFE is not a valid basis for credit generation. We expect that in all cases, the DFE sulfur level will be below the cap. To allow credit generation for these parties, we would need to set an additional annual average sulfur standard for DFE at some level below 10 ppm and allow credits to be generated for overcompliance with that standard. Accordingly, we do not believe it is appropriate to allow ethanol producers or blenders to generate sulfur

credits under the Tier 3 gasoline sulfur program, and as such, we are not finalizing such a provision. The Tier 3 rule prohibits any person downstream of the refinery or importer that produced or imported gasoline, CBOB, or RBOB who adds oxygenate to such product from including the volume and sulfur content of the oxygenate in any compliance calculations for credit generation.

#### 4. Credit Generation and Use

Under the Tier 3 ABT program, the credit generation provisions are nearly the same as those under the Tier 2 program. In essence, the Tier 2 program simply continues with a lower standard below which credits are generated. Refiners and importers are allowed to average within and across companies to meet the standard in the most cost-effective manner possible, including generating and using credits. For Tier 3, refiners and importers can generate credits for overcomplying with the 10 ppm standard on a volume-weighted annual average basis beginning January 1, 2017. Credit generation periods remain 12 months long and continue to be synchronized with annual compliance demonstration periods. The final Tier 3 ABT program provisions for approved small refiners and small volume refineries are discussed below in Section V.D.6.

Consistent with our proposal, and to encourage early gasoline desulfurization and give the refining industry flexibility to stagger their investments over time, we are also finalizing provisions to allow refiners and importers to generate credits prior to January 1, 2017 (i.e., early credits).

We proposed an early credit program for overcompliance with the current Tier 2 30 ppm gasoline sulfur standard from January 1, 2014 through December 31, 2016. These early credits were proposed to have a credit life of three years, and could be used through December 31, 2019. We also proposed that refiners and importers who generated early credits would then have to designate them at the end of the compliance year as either Tier 2 credits or Tier 3 early credits, and the credits would have to be used in accordance with the designation.

We received several comments on our early credit provisions. Some commenters stated that the requirement to designate credits as either Tier 2 or Tier 3 would not provide refiners and importers the intended amount of flexibility, as they may not necessarily be able to predict if they will need to use those early credits for either Tier 2 or Tier 3 compliance. Further,

<sup>431</sup> The provisions for butane blenders are located in 40 CFR 80.82.

<sup>432</sup> See Section V.I. for a discussion of the requirements for pentane blenders.

<sup>433</sup> The requirements for ethanol producers finalized today are discussed in Section V.G.4.

commenters were concerned that if more refiners than anticipated opt to bank the credits for possible future use at their own refineries, it could result in less credits being made available to the market. We also received comments both in support of and against the proposed three-year credit life. Some commenters stated that they believed that all credits should have a five-year life to provide maximum flexibility and more certainty on the availability of credits; while other commenters supported the three-year credit life limit, because it would coincide with the end of the small refiner/small refinery provisions thus providing more certainty of the benefits of the Tier 3 program. Finally, while not proposed, we received many comments requesting that EPA clarify what would become of “banked” Tier 2 credits (Tier 2 credits generated in 2012 and/or 2013 that were not used before the end of their five-year credit life and would have expired when the Tier 3 program began, under the terms of the proposed ABT program). Commenters further stated that these credits should not expire, but rather should be allowed to receive their full five-year credit life, as they represent actual reductions in refinery sulfur levels.

As discussed above, we are finalizing a more flexible approach to the ABT program than what we proposed. We believe this will provide for a more seamless transition from the Tier 2 to the Tier 3 credit programs and more certainty on credit availability.

Consistent with our proposal, refiners and importers may begin generating early credits on January 1, 2014, and continue through December 31, 2016. These credits will be generated on an annual average basis, from a demonstration that the refiner or importer’s annual average gasoline sulfur level is below the current Tier 2 30 ppm annual average sulfur standard. We believe this simple early credit approach is possible because U.S. gasoline was averaging around 30 ppm as we started developing the Tier 3 program, based on compliance data. Since refiners and importers would need to continue to comply with the existing Tier 2 sulfur standards during the early credit period, absent Tier 3, they would need to maintain this level of performance on an industry average basis. Accordingly, any additional gasoline sulfur reductions beyond 30 ppm will be attributed to the proposed Tier 3 program.

In response to comments received, we are not requiring that credits be designated as either Tier 2 or Tier 3 and only used for the program for which

they were designated. Refiners and importers may use early credits either for ongoing compliance with the Tier 2 program, or bank them for future compliance with the Tier 3 program (within the limits of the credit life restrictions). Essentially, the Tier 2 credit generation provisions simply continue, and any banked credits generated in 2014 through 2016 that were not used for compliance with the Tier 2 standards would be carried over for use in complying with Tier 3. We believe that this will allow for more certainty of credit availability before refiners must make their Tier 3 investment decisions, thus reducing the cost of the program. It will also avoid any incentive for refiners to use up banked Tier 2 credits prior to 2017 causing increased in-use sulfur levels and emissions.

Based on our analysis of the Tier 2 credit market for 2012, we believe that there will be a balance of 2012 banked credits equivalent to approximately two months of compliance, and we anticipate a similar amount (perhaps more) for 2013. Although we did not propose to allow for banked 2012 and 2013 Tier 2 credits to be used for compliance with the Tier 3 program, we are finalizing this provision for a number of reasons. First, the Tier 2 banked credits represent real reductions—refiners and importers are currently generating these credits for overcompliance with the Tier 2 gasoline sulfur standard. Second, allowing these banked credits to receive their full five-year credit life will provide more assurance of the credit availability for trading for those who need them to comply with Tier 3 without a large capital investment. As previously explained, this will allow for more certainty of credits available far before making Tier 3 investment decisions, thus reducing the cost of the program. A lack of certainty in the credit trading market could lead to refiners banking more credits than usual for their own use rather than allowing these credits to be available in the market for trading. As shown in Chapter 4.3 of the RIA, refiners tend to hold credits as an insurance policy until they approach the end of their credit life. If credit-generating refiners continue with this approach, credits generated in 2012 and 2013 will likely be available for purchase in 2017 and 2018 for those refiners that may want to rely on them for compliance (along with additional early credits generated in 2014 through 2016). Finally, as we anticipate that these credits will be equal to about four months of compliance, the allowance of

2012 and 2013 banked Tier 2 credits makes for a more flexible program by effectively allowing for a small amount of additional lead time without adversely affecting the overall benefits of the Tier 3 program. As discussed previously, this will avoid any incentive for refiners to use up banked Tier 2 credits prior to 2017 causing increased in-use sulfur levels and emissions. We believe these provisions will allow the Tier 3 program to begin on January 1, 2017, with more certainty regarding the availability of credits for those refiners needing (or choosing) to defer investment to better align with their existing turnaround/shutdown schedules.

All credits generated before January 1, 2017 will be valid for five years or until December 31, 2019, whichever is earlier—no early credits may be used for compliance beginning January 1, 2020. Thus, banked Tier 2 credits generated in 2012 and 2013 will receive their full five-year life and will not expire at the start of the Tier 3 program. However, credits generated in 2015 and 2016 that are unused as of December 31, 2019 will expire and become invalid. We believe that structuring the early credit program this way will offer considerable flexibility to refiners phasing in Tier 3 gasoline sulfur controls, while still placing a date at which point the intended sulfur program will be fully implemented and enforceable—January 1, 2020 (the same date small refiners and small refineries must begin complying with the 10 ppm sulfur standard). This will also provide a date certain to give auto manufacturers greater confidence for the design of their vehicles that all vehicles in-use are running on 10 ppm average fuel. Otherwise, it is possible that the greater ease of generating early credits relative to 30 ppm sulfur (as opposed to 10 ppm in 2017 and beyond) would allow higher sulfur levels to continue well beyond 2019.

Consistent with our proposal, all credits generated beginning January 1, 2017 will be for overcompliance with the Tier 3 10 ppm annual average sulfur standard, and will have a five-year credit life. We believe five years will give refiners and importers sufficient time to use credits generated in previous years while still placing limitations on credit life to help with enforcement. Five years is consistent with the Tier 2 ABT program, as well as the current credit life and recordkeeping provisions for other 40 CFR part 80 fuels programs, and coincides with the applicable statute of limitations for violations by parties who generate invalid credits. Credits must be used within five years

from the year they were generated (regardless of when/if they are traded), otherwise they will expire and become invalid. For example, credits generated in 2017 can be applied towards 2018–2022 compliance, as well as 2017 compliance. After March 31, 2023 (when reports for the 2022 annual compliance period will be due), credits generated in 2017 will expire and become invalid. Similarly, credits generated in 2018 can be applied towards 2019–2023 compliance, as well as 2018 compliance. After March 31, 2024, credits generated in 2018 expire, and so on and so forth.

#### 5. Credit Trading Provisions

We are also finalizing provisions for credit trading in Tier 3 that are identical to those under the current Tier 2 program. As in that program, it is possible that sulfur credits could be generated by one party, subsequently transferred or used in good faith by another, and later found to have been calculated or created improperly or otherwise determined to be invalid. As in the current Tier 2 program as well as other 40 CFR part 80 fuel programs, if this occurs, we are requiring that both the seller and purchaser will have to adjust their sulfur calculations to reflect the proper credits and either party (or both) could be determined to be in violation of the standards and other requirements if the adjusted calculations demonstrate noncompliance with the 10 ppm standard.

Sulfur credits must be transferred directly from the refiner or importer generating them to the party using them for compliance purposes. This ensures that the parties purchasing them are better able to assess the likelihood that the credits are valid. As proposed, we are also finalizing an exception for the case where a credit generator transfers credits to a refiner or importer who inadvertently cannot use all the credits. In this case, the credits can be transferred a second time to another refiner or importer. After the second trade, the credits must be used or they will expire. Allowing a maximum of two trades is consistent with other recent fuel programs and we believe it is sufficiently flexible while still preserving adequate means for enforcement. While some commenters stated that they believe the two-trade maximum is not necessary given the fact that credits are only being traded within a small part of industry, we believe that unlimited trading could result in an unenforceable program and potentially lead to problems with invalid credit trading. Given the widespread use of

credit trading between different companies under the Tier 2 program despite this provision, there appears to already be sufficient flexibility in the program. We received comments requesting that we clarify that intra-company trading will continue to be unlimited as it is in the existing Tier 2 ABT program. Intra-company trading will in fact remain unlimited, and we have added language to the final Tier 3 regulations to clarify this.

There are currently no prohibitions against brokers facilitating the transfer of credits from one party to another. Any person can act as a credit broker, regardless of whether such person is a refiner or importer, as long as the title to the credits is transferred directly from the generating refiner or importer to the using refiner or importer. This prohibition on outside parties taking ownership of credits was promulgated in response to problems encountered during implementation of the unleaded gasoline program, and has since been extended to subsequent fuels rulemakings. We continue to believe that maintaining this prohibition will allow for maximum program enforceability and consistency with all of our other ABT programs for mobile sources and their fuels.

#### 6. ABT Provisions for Small Refiners and Small Volume Refineries

Consistent with our proposal, approved small refiners and small volume refineries must comply with the 10 ppm annual average standard by January 1, 2020, which allows for an additional three years for compliance. This is the primary form of relief offered to small refiners and small volume refineries under the Tier 3 gasoline sulfur program (discussed further in Section V.E, below). Approved small refiners and small volume refineries may continue to generate credits for overcomplying with the 30 ppm Tier 2 standard before January 1, 2020. Prior to January 1, 2017, credits generated by small refiners and small volume refineries can be traded/sold to non-small refiners for use by December 31, 2019, and the credit revenues could be used to help offset their Tier 3 investments.

When the Tier 3 program begins on January 1, 2017, small refiners and small volume refineries may continue to generate credits for overcompliance with the 30 ppm sulfur standard (as they will still be subject to the Tier 2 standards through December 1, 2019), or they may generate credits for overcompliance with the Tier 3 10 ppm sulfur standard. We are finalizing that small refiners and small volume

refineries must designate their credits as being generated for either the Tier 2 or Tier 3 ABT program, as proposed. Credits designated and generated as Tier 2 credits may only be traded with other small refiners and small volume refineries (and these credits may only be used for compliance through December 31, 2019). However, credits designated and generated as Tier 3 credits may be traded with non-small refiners as well. Additionally, from January 1, 2017 through December 31, 2019, if a small refiner's annual average sulfur level is below 10 ppm, they may elect to split the designation and generation of credits between both the 10 ppm and 30 ppm standards (without double-counting). For example, in 2017, a small refiner with an annual gasoline sulfur average of 8 ppm could generate 20 ppm-volume Tier 2 credits (30 ppm-10 ppm) that could be used by other small refiners and small volume refineries, or banked by the refinery for future Tier 2 compliance. This small refiner would also generate 2 ppm-volume Tier 3 credits (10 ppm-8 ppm) that could be sold to refiners and importers subject to Tier 3, or banked by the refiner for future Tier 3 compliance.

#### 7. Deficit Carryforward

Under the final Tier 3 sulfur program, we are finalizing deficit carryforward provisions similar to the existing Tier 2 program, whereby an individual refinery that does not meet the 10 ppm standard in a given year may carry a credit deficit forward for 1 year. Under this deficit carryforward allowance, the refinery will have to make up the credit deficit and come into compliance with the Tier 3 sulfur standard the next calendar year. We received comments expressing concern that it will be more challenging for refineries to make up their credit deficit in one year with a 10 ppm sulfur standard, and requesting that the deficit carryforward allowance be extended to two or three years. We disagree with these comments primarily because of concerns with the enforceability of allowing for a deficit beyond one year. In addition, we believe that an extended deficit carryforward will further delay Tier 3 sulfur reductions. While we acknowledge that there might be an increased hurdle for some refiners to make up their own credit shortfall, we believe the ABT program provides ample opportunity to purchase credits from others. However, in recognition of unanticipated circumstances, such as where credits are unavailable or are prohibitively expensive such that the refiner could not make up the deficit in one year, the Tier 3 hardship provisions provide EPA

with the authority to allow for extended deficit carryforward, if a refiner's hardship petition demonstrates that it meets the criteria. Thus, we are finalizing that a refiner could carry a deficit forward for up to 3 years only in cases of hardship situations, as described below in Section V.E.2.

#### *E. Additional Program Flexibilities*

##### 1. Regulatory Flexibility Provisions

###### a. Small Business Regulatory Flexibility Provisions

We are finalizing several regulatory flexibility provisions for small entities in the fuels industry to reduce the burden that the Tier 3 program could have on them. As in previous fuel rulemakings, our justification for including provisions specific to small businesses is that these entities generally have a greater degree of difficulty in complying with the standards compared to other entities.

In developing the Tier 3 gasoline sulfur program, we evaluated the environmental need as well as the technical and financial ability of refiners and others in the fuel industry to meet the sulfur standards as expeditiously as possible. We believe it is necessary and feasible for the vast majority of the program to be implemented in the established time frame to achieve the air quality benefits as soon as possible. Based on information available from small refiners and others (as discussed further in the Regulatory Flexibility Analysis description in Section XII.C), we believe that the category of entities classified as small generally face unique circumstances with regard to compliance with environmental programs, compared to larger entities. Thus, as discussed below, we are finalizing several regulatory flexibility provisions for small refiners to reduce the burden that the Tier 3 program could have on them.

Small entities as a category generally lack the resources that are available to larger companies to raise capital for investing in a new regulatory program, such as shifting of internal funds, securing of financing, or selling of assets. Small entities are also likely to have more difficulty in competing for any needed engineering and construction resources. This is because the magnitude of their projects tends to be both smaller and less profitable for the contracted firms. As such, we are including provisions in today's rule that would provide assistance for small entities in meeting the 10 ppm sulfur standards. This proposed approach would allow the overall program to

begin as early as possible; achieving the air quality benefits of the program as soon as possible, while helping to ensure that small entities have adequate time to raise capital for new fuel desulfurization equipment or to make any other needed changes. We also believe that small business regulatory flexibilities can provide these entities with additional help and/or time to accumulate capital internally or to secure capital financing from lenders, and could spread out the availability of any needed engineering and construction resources in a manner that they are available by the time they are needed.

###### i. Delayed Standards for Small Refiners

We are finalizing a compliance date of January 1, 2020 for small refiners, allowing small refiners to postpone compliance with the Tier 3 program for up to three years. Small refiners will have from January 1, 2017 through December 31, 2019 to continue production of gasoline with an average sulfur level of 30 ppm (per the Tier 2 gasoline sulfur program). This delayed compliance schedule for small refiners is not intended as an opportunity for those refiners to increase their production of gasoline with sulfur levels greater than 10 ppm, but rather will help small refiners with compliance with the program. Since the compliance costs for their competitors may rise during these three years and since their gasoline will be sold into the same fungible market, this delay will not only provide them more lead time, but also financial support towards later compliance. Compliance with the 10 ppm annual average sulfur standard will begin on January 1, 2020 for small refiners. Further, as discussed in greater detail in Section V.D.5, a small refiner would be allowed to continue using Tier 2 gasoline sulfur credits through December 31, 2019 to meet their refinery average 30 ppm sulfur standard.

###### ii. Refinery Gate and Downstream Caps

During the Small Business Regulatory Enforcement Fairness Act (SBREFA) Panel process, small refiners raised the concern that a refinery gate cap of 20 ppm could cause problems during a refinery turnaround or an upset because a cap of this level could result in a refiner not being able to produce saleable gasoline. The Panel likewise had concerns that a downstream cap of 25 ppm may cause problems for small downstream entities such as transmix processors and gasoline additive manufacturers. They stated it would not be feasible for transmix processors to install desulfurization equipment to

produce gasoline that meets a 25 ppm sulfur cap. They also stated that such a low sulfur cap could preclude certain necessary gasoline additives from the market whose activity depends on sulfur containing components. Thus, the Panel recommended that EPA assess and request comment on retaining the current Tier 2 refinery gate and downstream caps of 80 and 95 ppm, respectively, to help provide maximum flexibility and avoid system upsets for the entire refining and distribution system. Further, the Small Business Administration (SBA) and Office of Management and Budget (OMB) Panel members recommended that EPA propose retaining the 80 ppm and 95 ppm caps. The Panel also recommended that, if EPA were to propose caps lower than 80 and 95 ppm, the Agency request comment on additional refinery gate and downstream caps that are above 20/25 ppm but below 80/95 ppm. As discussed above, we proposed options to maintain the current 80/95 ppm caps or to lower them to 50/65 ppm and sought comment on a refinery gate cap of 20 ppm with a downstream cap of 25 ppm. We are retaining the current 80/95 ppm per-gallon sulfur caps in today's final rule. For more information on today's final per-gallon sulfur cap provisions and related comments, refer to Section V.C of this preamble and Chapter 5 of the Summary and Analysis of Comments document.

###### b. Small Volume Refinery Provisions

Consistent with our proposal, we are finalizing a compliance date of January 1, 2020 for small volume refineries. Approved small volume refineries will receive a three-year delay (January 1, 2017 through December 31, 2019) in meeting the 10 ppm average gasoline sulfur standard, similar to the small refiner delay. During the development of the Tier 3 rulemaking and throughout the SBREFA process, it became evident that some refineries may experience higher compliance costs on a per-gallon basis than other refineries, and in some cases considerably higher. These are refineries owned by a refiner/company that would not meet the SBA definition of a small business. In an oversupplied gasoline market, these refineries may have difficulty justifying capital investments to comply with new standards. In recognition of this concern under the RFS program, Congress granted all refineries with a crude oil throughput of less than or equal to 75,000 barrels per calendar day (bpcd) additional time to comply. Consistent with this allowance, we are including delayed Tier 3 sulfur standards for approved small volume refineries.

Overall, we believe that these small refineries are disproportionately impacted when it comes to their cost of compliance and ability to rationalize the investment costs in today's gasoline market. Giving these refineries additional lead time will allow more time to invest in desulfurization technology, take advantage of advancements in technology, develop confidence in a Tier 3 credit market as a means of compliance, and avoid competition for capital, engineering, and construction resources with the larger refineries. Credit generation opportunities for approved small volume refineries are identical to those for small refiners, as described above in Section V.D.

A refiner must apply and be approved for small volume refinery status. We are finalizing a small volume refinery net crude throughput of less than or equal to 75,000 bpcd, based on the highest crude throughput for the 2012 calendar year. We received comment suggesting that a higher crude throughput (e.g., 90,000 bpcd) would be more appropriate, as the refining industry has changed since Congress set the 75,000 bpcd throughput limit for small refineries in the RFS program. In analyzing various crude throughput maximums between 75,000 and 90,000 bpcd, we do not believe it is appropriate or necessary to increase the threshold beyond what was previously set by Congress. The 75,000 bpcd limit set by Congress was to recognize those refineries that would have difficulty with compliance with a rulemaking (from both a cost and feasibility standpoint), raising this limit would go beyond Congress' intent.

## 2. Provisions for Refiners Facing Hardship Situations

We are finalizing hardship provisions that are intended to accommodate a refiner's inability to comply with the 10 ppm sulfur standard at the start of the Tier 3 program, and to deal with unforeseen circumstances that may occur at any point during the program. These provisions, which are similar to those in existing fuels programs, are available to all refiners, small and non-small, though relief will be granted on a case-by-case basis following a showing of certain requirements; primarily that compliance through the use of credits is not feasible. Any hardship waiver granted will not be a total waiver of compliance; rather, a hardship waiver will consist of short-term relief that will allow a refiner facing a hardship situation to, for example, receive additional time to comply. EPA will determine appropriate hardship relief

based on the nature and degree of the hardship, as presented by the refiner in its hardship application, and on our assessment of the credit market at that time. Further, as discussed above in Section V.D.7, hardship waivers could grant relief in the form of additional deficit carryforward for up to three years, depending on the level of hardship and the status of the credit market. A detailed description of the requirements for applying for a hardship waiver is located in the regulations at 40 CFR 80.1625.

We do not anticipate a great need for hardship relief, given the flexibilities offered as part of the Tier 3 program and an expected robust credit trading market. Nevertheless, we are finalizing hardship provisions in this action as a failsafe for unforeseen circumstances, or should credits become scarce or prohibitively expensive.

### a. Temporary Waivers Based on Unforeseen Circumstances

We are finalizing a provision to allow for temporary waivers based on unforeseen circumstances. EPA would, at our discretion, permit a refiner to seek a temporary waiver from the Tier 3 sulfur standards under certain rare circumstances. This waiver provision is intended to provide refiners relief in unanticipated circumstances—such as a refinery fire or a natural disaster (i.e., *force majeure*)—that cannot be reasonably foreseen now or in the near future. Under this provision, a refiner can seek a hardship waiver for relief if it can demonstrate that the magnitude of the impact is so severe as to require such an extension. A refiner would need to show that: (1) The waiver is in the public interest; (2) the nonconformity is unavoidable; (3) it will meet the proposed Tier 3 standards as expeditiously as possible; (4) it will make up the air quality detriment associated with the nonconforming gasoline, where practicable; and (5) it will pay to the U.S. Treasury an amount equal to the economic benefit of the nonconformity less the amount expended to make up the air quality detriment. These conditions are similar to those in existing fuels regulations, and are necessary and appropriate to ensure that any waivers granted would be limited in scope.

Such a request will be based on the refiner's inability to produce compliant gasoline at the affected facility due to extreme and unusual circumstances outside the refiner's control that could not have been avoided through the exercise of due diligence. The hardship request will also need to show that other avenues for mitigating the problem,

such as the purchase of credits toward compliance under the ABT program provisions, have been pursued and yet were insufficient or unavailable. In light of other flexibilities, including the ABT program, we expect that the need for such requests will be rare.

### b. Temporary Waivers Based on Extreme Hardship Circumstances

In addition to the provision for short-term relief in extreme unforeseen circumstances, we are also finalizing a hardship provision where a refiner may receive a hardship waiver based on severe economic or physical lead time limitations of the refinery to comply with the Tier 3 standards at the start of the program. A refiner seeking such hardship relief under this provision must demonstrate that these criteria were met. In addition to showing that unusual circumstances exist that impose extreme hardship in meeting the Tier 3 standards, the refiner will need to show that: (1) It has made best efforts to comply, including through the purchase of credits; (2) the relief granted under this provision is in the public interest; (3) the environmental impact is acceptable; and (4) it has active plans to meet the requirements as expeditiously as possible. We expect that hardship relief requests under this provision will mostly be applicable at the beginning of the Tier 3 program, when refiners are making their investments to comply. If hardship relief under these circumstances is approved, we expect to impose appropriate conditions to ensure that the refiner is making best efforts to achieve compliance offsetting any loss of emission control from the program.

We believe that providing short-term relief to those refiners that need additional time due to hardship circumstances will help to facilitate the adoption of the overall Tier 3 program for the majority of the industry. However, we do not intend for hardship waiver provisions to encourage refiners to delay planning and investments they would otherwise make. Again, because of the flexibilities of the overall Tier 3 program, especially the ABT program, we expect the need for additional relief to be rare.

## F. Compliance Provisions

This section describes the compliance provisions of today's program. For the most part, the Tier 3 sulfur standards simply reflect a lowering of the current Tier 2 sulfur standards. Thus, we are retaining most of the same compliance provisions as the current Tier 2 program, with exceptions as noted. However, we also proposed and sought comment on several fuel program



regulatory streamlining measures, including a broader program redesign to streamline the reformulated gasoline and anti-dumping regulations.<sup>434</sup> As discussed below, some of these streamlining measures will also impact the Tier 3 sulfur compliance provisions.

#### 1. Registration, Reporting, and Recordkeeping Requirements

Registration, recordkeeping, and reporting are necessary to track compliance with the Tier 3 standards and the ABT program.

##### a. Registration Requirements

Refiners, importers, and anyone acting as a refiner (e.g., a terminal with blending or other refining operations) who expects to produce or import gasoline must register each of its facilities with EPA by June 1, 2016, or six months prior to producing gasoline meeting the Tier 3 standards and/or participating in the credit program. Manufacturers of denaturants that are designated as suitable for use in the manufacture of DFE that meets federal requirements must also register each of their facilities with EPA by June 1, 2016, or six months prior to producing denaturant that is so designated.<sup>435</sup> Manufacturers of pentane designated as suitable for use by blenders into previously certified gasoline (PCG) subject to the Tier 2 program must register each of their facilities with EPA prior to manufacturing pentane for such downstream blending.<sup>436</sup> Manufacturers of pentane for use by blenders of pentane into PCG subject to the Tier 3 program must register each of their facilities with EPA by June 1, 2016, or six months prior to producing such pentane. After the Tier 3 program begins on January 1, 2017, any non-registered parties must register at least three months prior to producing gasoline, participating in the credit market, producing denaturant designated as suitable for use in the manufacture of DFE that meets federal requirements, or producing pentane for downstream blending into PCG under the Tier 3 program. Consistent with the existing registration requirements for butane blenders, pentane blenders must comply

with the fuel registration requirements under the fuel and fuel additives registration program of 40 CFR part 79. Most refiners, importers, and ethanol producers and some ethanol denaturant manufacturers are currently registered with EPA under other 40 CFR part 80 fuels programs. All manufacturers of gasoline additives for use in highway vehicles are already required to be registered with EPA under 40 CFR part 79 fuel and fuel additives program. Parties who are already registered do not have to register again.

The same basic forms currently being used for existing fuels programs will be used for Tier 3 registration. These forms are well known in the regulated community and are simple to fill out. Upon receipt of a completed registration form, EPA will issue a unique 4-digit company identification number and a unique 5-digit facility identification number. As with existing fuels programs, these numbers will be required for all reports sent to EPA and for PTDS.

Registrations do not expire and do not have to be renewed; however, registered parties are responsible for notifying us of any change to their company or facility information.

An entity's registration must include a corporate name and address (including the name, telephone number, and email address of a corporate contact person); and, for each facility operated by the entity:

- Type of facility (e.g., refinery, import facility, pipeline, terminal, transmix facility, etc.)
- Facility name
- Physical location
- Name, telephone number, and email address of a corporate contact person

##### b. Reporting Requirements

Refiners and importers must submit annual reports demonstrating their compliance with the Tier 3 standards, and on the generation, use, and transfer of sulfur credits at each of its refineries or import facilities. Similar to our other sulfur programs, refiners and importers must submit data on individual batches of gasoline (including batch volume and sulfur content). Based on our experience with existing gasoline and sulfur-based programs, we believe that requiring annual reports and individual sulfur batch data provides an effective means of monitoring compliance with the standards and the credit program.

Producers and importers of blender grade pentane for use by pentane blenders must also submit annual reports that include data on individual batches demonstrating compliance with

the quality requirements for blender grade pentane and batch volume.

We proposed that producers and importers of DFE and other oxygenates would be required to submit an annual report that includes the total volume of DFE/oxygenate produced and an attestation that all batches met the proposed fuel quality requirements. We continue to believe that such annual reports are important enforcement and compliance assurance mechanism and thus are finalizing the proposed annual reporting requirements for oxygenate producers and importers.

Tier 3 reports will be due annually on March 31, on forms as required by EPA.

##### c. Recordkeeping Requirements

Similar to current EPA fuels programs, refiners and importers must retain all records that demonstrate compliance with the Tier 3 program, including the ABT program.

Manufacturers of DFE and other oxygenates must keep records for five years on individual batches of DFE/oxygenate (including batch volume, denaturant concentration, and sulfur test results or other records to demonstrate compliance with the Tier 3 sulfur requirements as applicable).<sup>437</sup>

Manufacturers of ethanol denaturant that is designated as suitable for use in the manufacture of DFE that meets federal requirements must keep records on individual batches of such denaturant including batch volume, and sulfur content.

Manufacturers of pentane that is designated as suitable for use for blending into PCG must keep records on individual batches of such pentane including batch volume, sulfur content, benzene content, olefin content, aromatic content, C6 and higher hydrocarbon content, and purity as applicable.

Manufacturers of gasoline additives for use in highway vehicles must keep records on individual batches of such additives including batch volume and additive production quality control activities which demonstrate that the sulfur content of additive production batches complies with the Tier 3 sulfur requirements. We expect that such records would include the results of periodic sulfur testing but not necessarily testing on each production batch.

<sup>437</sup> As discussed in section V.G. of this preamble, DFE manufacturers may demonstrate compliance with Tier 3 sulfur requirements either by testing each batch or mathematically using volumetric blend records and product transfer documents from the denaturants used provided such denaturants are from a registered denaturant producer.

<sup>434</sup> For more information on Part 80 regulatory streamlining options, refer to Section VI.

<sup>435</sup> As discussed in section V.I. of this preamble, the use of denaturants that are so designated enables DFE manufacturers to use streamlined provisions to demonstrate compliance with the Tier 3 sulfur requirements for DFE.

<sup>436</sup> The provisions for downstream blending of pentane into gasoline described in section VI.A.3. will become effective 60 days after the publication of this rule and may be used for gasoline subject to the Tier 2 program requirements as well as gasoline subject to the Tier 3 program requirements.

All parties in the gasoline, DFE, ethanol denaturant, pentane, and gasoline additive production and distribution system subject to the Tier 3 sulfur program are also required to keep records of all PTDs and records of any quality assurance programs. Records must be retained for five years. For credit transactions, records must be retained for five years from the usage date. Records must be made available to EPA on request; if electronic records are kept, hard copies must be made available upon request.

Information submitted to EPA may be claimed as confidential business information (CBI). Parties making such a claim must follow all reporting guidance and clearly mark the information being claimed as proprietary. EPA will treat information covered by such a claim in accordance with the regulations at 40 CFR part 2 and other Agency procedures for handling proprietary information.

## 2. Sampling and Testing Requirements

Under the Tier 2 program, a sulfur concentration must be determined for every batch of gasoline. We are retaining this requirement under the Tier 3 program. As with the existing Tier 2 program, this every-batch testing requirement will be required to occur prior to the batch leaving the refinery. We are also retaining the Tier 2 sampling, testing, and sample retention requirements in today's final rule. Additionally, as discussed below in Section VI, we have included performance based measurement standards that will allow refiners to use alternate test methods for measuring sulfur if they so choose.

We proposed that manufacturers of DFE would be required to test each individual batch of DFE for its sulfur content. In response to comments, we are finalizing an alternative means for DFE manufacturers to demonstrate compliance with the Tier 3 sulfur requirements in addition to per batch testing.<sup>438</sup> We anticipate that DFE manufacturers will typically use this alternative means in the place of per batch sulfur testing.

As discussed above, manufacturers of additives for use in highway gasoline vehicles must maintain records of additive production quality control activities which demonstrate that the sulfur content of additive production batches complies with the Tier 3 sulfur requirements. We expect that periodic

sulfur testing will be needed to comply with this requirement but not necessarily testing on each additive production batch. Manufacturers of pentane that is designated as suitable for use by blenders into PCG must test every batch to demonstrate compliance with the requirements sulfur content, benzene content, olefin content, aromatic content, C6 and higher hydrocarbon content, and purity as applicable. Blenders of pentane into gasoline must conduct periodic sampling and testing of the pentane they receive from each separate pentane supplier to demonstrate that the pentane is compliant with the applicable compositional requirements.

## 3. Small Refiner Compliance

To qualify for small refiner status under the Tier 3 program, a refiner must apply by June 1, 2016. As with our other existing EPA fuels programs, we are continuing to use the Small Business Administration definition of a small refiner: 1,500 employees (company-wide). To qualify for small refiner status under Tier 3, a small refiner must also meet the following additional criteria:

- The refiner must have produced gasoline from crude oil during the 2012 calendar year.
- The refiner must have owned and operated the refinery during the period from January 1, 2012 through December 31, 2012. New owners that purchased a refinery after that date will have done so with full knowledge of the proposed Tier 3 regulations, and should have planned to comply along with their purchase decisions. As with existing fuel programs, a refiner that restarts a refinery in the future may be eligible for small refiner status. Thus, a refiner restarting a refinery that was shut down or non-operational during calendar year 2012 can apply for small refiner status. In such cases, we will judge eligibility under the employment and crude oil capacity criteria based on the most recent 12 consecutive months prior to the application, unless we conclude from data provided by the refiner that another period of time is more appropriate. However, this is limited to a company that owned the refinery at the time that it was shut down. New purchasers will not be eligible for small refiner status for the same reasons described above.

- The refiner must have had 1,500 employees or less based on the average number of employees for all pay periods from January 1, 2012 through December 31, 2012 for all subsidiaries, parent companies (i.e., any company or companies with controlling interest), and joint ventures.

- The refiner must have had a crude oil capacity less than or equal to 155,000 bpcd during the 2012 calendar year.

A refiner applying for small refiner status must apply and provide EPA with several types of information, as specified in the regulations, by June 1, 2016. All refiners seeking small refiner status under this program must apply for small refiner status, regardless of whether the refiner has been approved for small refiner status under another fuel program. As with applications for relief under other rules, applications for small refiner status under this final rule that are later found to contain false or inaccurate information will be void *ab initio*.

Requirements for small refiner status applications:

- The total crude oil capacity as reported to the Energy Information Administration (EIA) of the U.S. Department of Energy (DOE) for the most recent 12 months of operation. This includes the capacity of all refineries controlled by a refiner and by all subsidiaries and parent companies and joint ventures. We will presume that the information submitted to EIA is correct. (In cases where a company disagreed with this information, the company may petition EPA with appropriate data to correct the record when the company submitted its application for small refiner status. EPA will accept such alternate data at its discretion.)

- The name and address of each company location where employees worked during the 2012 calendar year; and the number of employees at each location during this time period. This includes the locations and number of employees working at all subsidiaries, parent companies, and joint ventures.

- In the case of a refiner who reactivates a refinery that was either shutdown or non-operational from January 1, 2012 through December 31, 2012, the name and address of each company location where employees worked since the refiner reactivated the refinery and the average number of employees at each location for each calendar year since the refiner reactivated the refinery.

- The type of business activities carried out at each location.
- Contact information for a corporate contact person, including: name, mailing address, phone and fax numbers, email address.

- A letter signed by the president, chief operating officer, or chief executive officer of the company (or a designee) stating that the information contained in the application is true to

<sup>438</sup> The alternative means of demonstrating compliance with the Tier 3 sulfur requirements for DFE manufacturers is discussed in section V.G. of this preamble.

the best of his/her knowledge and that the company owned the refinery as of January 1, 2012.

An approved small refiner that exceeds the employee count or crude capacity criteria due to merger with, acquisition by, or the acquisition of another entity will lose its small refiner status. In situations where a small refiner loses its small refiner status due to merger with a non-small refiner, acquisition of another refiner, or acquisition by another refiner, we are finalizing provisions that are similar to those in our existing fuels programs to allow up to an additional 30 months of lead time to comply with the Tier 3 program after the disqualifying event, but no later than December 31, 2019.<sup>439</sup> This 30 months of additional lead time will only apply to refineries that were previously subject to small refiner relief, as we believe there will be no adverse environmental impact because of the pre-existing relief provisions that applied to the small refiner. A refiner will also lose its small refiner status if it ceases to process crude oil.

Our intent has been, and continues to be, limiting the small refiner relief provisions to a small subset of refineries that are challenged, as discussed above. However, it is also our intent to avoid stifling normal business growth. Therefore, an approved small refiner who exceeds the employee count or crude oil capacity criteria through normal business practices may retain its small refiner status. Further, in the sole case of a merger between two approved small refineries, such refineries will be permitted to retain their individual small refiner status. Additional financial resources would not typically be provided in the case of a merger between two small refineries. Small refiner status for the two entities of the merger would not be affected; hence the original compliance plans of the two refineries should not be impacted. Moreover, no environmental detriment will result from the two small refineries maintaining their small refiner status within the merged entity as they would have likely maintained their small refiner status had the merger not occurred.

#### 4. Small Volume Refinery Compliance

In the case of small volume refineries, the application process for qualification is similar to that of a small refiner. A refiner that is both a small refiner and owns a small volume refinery need not apply for small volume refinery status; the small refiner application is all that is needed. Small refineries must have a

net crude throughput threshold of no more than 75,000 bpcd based on the highest throughput in calendar years 2011 or 2012 as the basis for receiving small volume refinery status.

Refiners must include the following in their applications for small volume refinery status:

- Proof that the refiner produced gasoline from crude oil during the 2012 calendar year.
- Proof that the refiner owned and operated the refinery during the period from January 1, 2012 through December 31, 2012.
- The refinery's total crude throughput as reported to EIA for each of calendar years 2011 and 2012. Again, we will presume that the information submitted to EIA is correct. In cases where a refiner disagrees with this information, the refiner may petition EPA with appropriate data to correct the record when the refiner submits its application for small volume refinery status. EPA will accept such alternate data at its discretion.
- Contact information for a corporate contact person, including: name, mailing address, phone and fax numbers, email address.
- A letter signed by the president, chief operating officer, or chief executive officer of the company (or a designee) stating that the information contained in the application is true to the best of his/her knowledge and that the company owned the refinery as of January 1, 2012.

#### 5. Attest Engagements, Violations, and Penalties

In today's final rule we are retaining the existing Tier 2 requirements for attest engagements for generation of both early and standard credits, use of credits, and compliance with the proposed program, using the procedures currently used in existing EPA fuels programs for attest engagements. The violation and penalty provisions applicable to today's Tier 3 program will be very similar to the provisions currently in effect in other gasoline programs as well.

#### 6. Special Fuel Provisions and Exemptions

The following paragraphs discuss several provisions and exemptions from the Tier 3 gasoline sulfur standards in special circumstances.

##### a. Gasoline Used in Military Applications

In both our diesel fuel program and the Tier 2 gasoline sulfur program, we provided an exemption for fuel used in tactical military vehicles and nonroad

engines and equipment with a national security exemption (NSE) from the vehicle and engine emissions standards. Due to national security considerations, some of EPA's existing regulations allow the military to request and receive NSEs for vehicles, engines, and equipment from emissions regulations if the operational requirements for such vehicles, engines, or equipment warrant such an exemption. Fuel used in these applications is also exempt if it is used in tactical military vehicles, engines, or equipment that are not covered by an NSE but, for national security reasons (such as the need to be ready for immediate deployment overseas), need to be fueled on the same fuel as those with an NSE. We are including this exemption in the Tier 3 gasoline program.

##### b. Gasoline Used in Research, Development, and Testing

Similar to existing EPA fuels programs, we are finalizing provisions to allow for requests for an exemption from the Tier 3 standards for gasoline used for research, development, and testing purposes ("R & D exemption"). We recognize that there may be legitimate research programs that require the use of gasoline with sulfur levels greater than those allowed under the Tier 3 program. Thus, we are including provisions for obtaining an exemption from the prohibition against persons producing, distributing, transporting, storing, selling, or dispensing gasoline that does not meet the Tier 3 gasoline sulfur standards, where such fuel is necessary to conduct a research, development, or testing program.

Parties seeking an R & D exemption must submit an application for exemption to EPA that describes the purpose and scope of the program, and the reasons why the noncompliant gasoline is necessary. Upon presentation of the required information, an exemption may be granted at the discretion of EPA, with the condition that EPA can withdraw the exemption in the event the Agency determines the exemption is not justified. In addition, an exemption based on false or inaccurate information will be considered void *ab initio*. Gasoline subject to an exemption will be exempt from certain provisions of this rule, including the sulfur standards, provided certain requirements are met. These requirements include the segregation of the exempt gasoline from non-exempt gasoline, identification of the exempt gasoline on PTDs, and pump labeling.

<sup>439</sup> See, for example, 69 FR 39051 (June 29, 2004).

### c. Gasoline for Export

Gasoline produced for export, and that is actually exported for use in a foreign country, will be considered exempt from the fuel content standards and other requirements of the Tier 3 gasoline sulfur program. In order to exclude exported gasoline, refiners must retain records to demonstrate that the gasoline was exported. Such gasoline must be designated by the refiner, and the PTD must state that the gasoline is for "export only"; otherwise, the gasoline will be considered as intended for use in the U.S. and subject to the Tier 3 standards. Gasoline intended for export must be segregated from all gasoline intended for use in the U.S. Distributing or dispensing such fuel for domestic use will be illegal.

### d. Other Special Provisions and Exemptions

Additionally, in existing EPA fuels programs we have included exemptions for racing fuel and for fuel used in the U.S. territories of Guam, American Samoa, and the Northern Mariana Islands; we are finalizing such exemptions for the Tier 3 program as well.

### *G. Standards for Oxygenates (Including Denatured Fuel Ethanol) and Certified Ethanol Denaturants*

The following discussion is focused on the standards finalized today for denatured fuel ethanol (DFE) because DFE is the predominant gasoline oxygenate currently in-use.<sup>440</sup> These standards also apply to other gasoline oxygenates.<sup>441</sup>

#### 1. Sulfur Standard

The Tier 2 gasoline requirements include the prohibition on blending gasoline with DFE that has sulfur content higher than 30 ppm.<sup>442</sup> This requirement reflects the 30 ppm refinery gasoline average sulfur requirement under the Tier 2 program. Consistent with the approach under the Tier 2 program and our proposed 10 ppm refinery average sulfur standard for gasoline under the Tier 3 program, we proposed that producers of DFE for use by oxygenate blenders would be required to meet a 10 ppm sulfur cap beginning January 1, 2017. We proposed requiring DFE producers to test each

batch of DFE to demonstrate compliance with the sulfur content standard, and to retain and provide batch reports to EPA.

The Renewable Fuels Association (RFA) commented that if EPA were to accept current industry practices used to assure that DFE is compliant with the state of California's 10 ppm sulfur cap for DFE in place of per-batch sulfur testing and reporting there would be no additional burden to ethanol producers in meeting a 10 ppm sulfur cap.<sup>443</sup> In 2002, RFA conducted an industry survey that demonstrated DFE manufacturers were meeting California's 10 ppm maximum sulfur content requirement. Since then, RFA has recommended to the ethanol industry that all DFE meet this California requirement and indicated that ethanol producers are adhering to this recommendation. Other commenters also stated that DFE manufacturers have been producing DFE that complies with California specifications because of logistical difficulties in segregating ethanol destined for California from other destinations.

An environmental organization commented that the proposed 10 ppm sulfur cap for DFE was necessary to ensure that the Tier 3 program benefits are actually realized. Refiners commented that requiring DFE to meet a 10 ppm sulfur cap was essential to facilitating their compliance with the Tier 3 gasoline sulfur requirements. In demonstrating compliance with the 10 ppm average gasoline sulfur standard finalized today, gasoline refiners and importers may adjust the sulfur levels in the gasoline and BOBs that they produce/import to account for the downstream addition of ethanol.<sup>444</sup> Therefore, the sulfur level of DFE has a direct effect on the extent of the desulfurization measures that a refiner/importer will have to undertake to comply with the gasoline sulfur standards finalized today. A refiner commented that if the sulfur standard for DFE was left at its current level of 30 ppm, greater capital investments would be needed to adjust and lower the sulfur content of other gasoline blending streams to prevent violation of the ultimate 10 ppm annual average standard.

<sup>443</sup> RFA requested regulatory relief from the proposed batch testing and reporting requirements as discussed in preamble Section V.G.4.

<sup>444</sup> Accounting for the effect of oxygenate added downstream of the refinery or import facility in demonstrating compliance with the average gasoline sulfur standard is addressed in regulations finalized today at § 80.1603(d). See Section V.C. in today's preamble regarding the sulfur level in DFE that must be used by refiners and importers in making this compliance determination.

Some ethanol producers and Growth Energy (representing ethanol producers) commented that DFE should be subject to an annual average sulfur standard and be able to participate in the averaging banking and trading (ABT) program that is available to refiners and importers of gasoline. Some ethanol producers commented that they should be allowed to participate in the ABT program as a means of offsetting the additional cost of the proposed per-batch sulfur testing and reporting requirements.

EPA believes that requiring DFE to comply with a 10 ppm sulfur cap is the most appropriate means of ensuring that finished gasoline blends attain the sulfur control goals of the Tier 3 program. Therefore, today's rule finalizes a 10 ppm sulfur cap for DFE. Because essentially all (if not all) DFE already meets California's 10 ppm sulfur standard, EPA believes that the implementation of a federal 10 ppm sulfur cap for DFE would not result in a significant increased burden for ethanol producers.<sup>445</sup> Neat ethanol produced with standard quality control practices should have negligible sulfur content. Denaturants with sufficiently low-sulfur content to facilitate compliance with the 10 ppm sulfur cap for DFE are widely available. Allowing DFE to exceed 10 ppm would result in the use of higher-sulfur denaturants, thereby increasing gasoline refiner capital costs to install desulfurization equipment. As discussed in Section V.D.3 of this preamble, there are several reasons why we do not believe that it is appropriate to expand the ABT provisions to include ethanol producers and importers. Furthermore, as discussed in Section V.G.4, sulfur testing on each batch of DFE will not be required provided that the DFE producer or importer demonstrates compliance with the 10 ppm sulfur cap for DFE with volumetric blending records, whereas an average standard would require testing of every batch. We anticipate that DFE producers and importers will typically choose to demonstrate compliance with the 10 ppm sulfur cap using volumetric blending records rather than per-batch sulfur testing. Therefore, we do not anticipate that DFE producers and importers will need to install additional sulfur testing equipment as a result of today's rule. Hence, there is no need to extend the flexibility of meeting an annual average sulfur standard and participation in the ABT program to

<sup>445</sup> The potential for additional burden associated with demonstrating compliance with a 10 ppm sulfur cap is discussed in Section V.G.4.

<sup>440</sup> An importer of biofuels commented that EPA should clarify that the standards for DFE will apply to importers as well as domestic producers. The regulations finalized today specifically state that the standards for denatured fuel ethanol apply to importers as well as domestic producers of DFE.

<sup>441</sup> Public comments supported our proposal to apply the same standards to all gasoline oxygenates.

<sup>442</sup> 40 CFR 80.385(e).

ethanol producers and importers to help facilitate their compliance as exists for gasoline refiners.<sup>446</sup>

Comments were supportive of the proposed January 1, 2017 implementation date for standards applicable to DFE. Today's action requires that importers and manufacturers of DFE comply with the standards finalized today beginning January 1, 2017.

## 2. Limitation on the Type of Ethanol Denaturant

To limit the variability in DFE composition and the associated potential impact on vehicle emissions, we proposed to allow the use of only certified gasoline, gasoline blendstocks for oxygenate blending (BOBs), and natural gasoline as denaturants. Commenters stated that it would be unnecessary to place additional limits on the types of denaturants that could be used beyond those in the ASTM specification for DFE. Groups representing refiners stated that EPA had not presented data to support that additional limitations on the types of denaturants that can be used (or the allowed concentrations at which they may be used) are needed beyond those adopted by ASTM and the State of California to address concerns about the potential adverse impacts on vehicle emissions performance. The ASTM specification for DFE requires that the only denaturants that can be used are gasoline, gasoline blendstocks, and natural gasoline. The State of California incorporated the ASTM limits on allowable denaturants into its regulations for DFE by reference.<sup>447</sup> Thus, both ASTM and the State of California allow the use of gasoline blendstocks other than BOBs as denaturants. One refiner stated that DFE producers have used refinery gasoline blendstocks such as "light straight run" and "light naphtha" as denaturants and that removing this flexibility would increase DFE production costs. They noted that access to this flexibility could become more important under a 10 ppm sulfur cap for DFE. In addition to needing to preserve the flexibility to use a range of gasoline blendstocks, ethanol manufacturers stated that EPA should consider the possibility of approving denaturants that are not currently allowed under the ASTM specification

<sup>446</sup> See Section V.D.3. of this preamble for additional discussion of why we are not extending the sulfur averaging, banking, and trading program to cover DFE manufacturers.

<sup>447</sup> The California Code of Regulations references ASTM D 4806-99 which limits the allowed denaturants to gasoline, gasoline components, and natural gasoline.

for DFE. One refiner stated that ASTM is the appropriate technical forum for the consideration of adding new allowable denaturants.

EPA continues to believe that it is appropriate to implement additional controls to address the potential impact of fuel components in denaturants other than sulfur on vehicle emissions. However, we agree with the comments that it is not appropriate to implement additional controls on the types of denaturants that may be used beyond those currently adopted by ASTM and the State of California at this time. Therefore, in response to comments, today's rule includes the requirement that only gasoline, gasoline blendstocks, and natural gasoline may be used to denature DFE.<sup>448</sup> This requirement is essentially the same as the current ASTM and State of California specifications for the type of denaturants that may be used. We will continue to monitor the potential need for additional controls on ethanol denaturants, and may revisit this issue in the context of setting in-use quality specifications for E85 in the future.<sup>449</sup> We will also continue to monitor the need for additional denaturants, and when appropriate EPA may undertake a future rulemaking to consider allowing their use.

As discussed in Section V.G.4, in order for DFE producers and importers to take advantage of streamlined provisions for demonstrating compliance with the 10 ppm sulfur cap for DFE, they must only use denaturants from registered producers that have been demonstrated as meeting EPA compositional requirements. Denaturants from unregistered denaturant producers may be used by DFE producers provided that they test each batch of DFE to demonstrate compliance with the 10 ppm sulfur cap for DFE.

## 3. Limitation on Ethanol Denaturant Concentration

To further limit the potential impact on vehicle emissions of fuel parameters in ethanol denaturants other than sulfur, we proposed to limit denaturant concentration in DFE to a maximum of 2 volume percent, which translates to 2.5 volume percent considering rounding. We also requested comment on alternately adopting the additional fuel specifications currently in force for DFE in the State of California. While California allows a maximum

<sup>448</sup> Finished gasoline used as denaturant must be compliant with the applicable EPA requirements.

<sup>449</sup> See Section V.H. for a discussion of potential FFV in-use fuel quality requirements.

denaturant content of 5 volume percent consistent with the industry consensus ASTM International (ASTM) specification for DFE, they also have maximum specifications for benzene, olefins, and aromatics as well as sulfur.<sup>450</sup>

A number of refiners and ethanol manufacturers stated that it was unnecessary to limit denaturant concentration beyond the 5 volume percent specified by ASTM. Ethanol manufacturers stated that the RFS2 program requirement that DFE contain no more than 2 volume percent denaturant for Renewable Identification Number (RIN) generation purposes already provides a strong incentive to keep denaturant concentration under 2 percent.<sup>451</sup> However, they stated that the flexibility to have a slightly higher denaturant content can be important to ethanol producers. One ethanol producer stated that the proposed maximum 2 volume percent cap on denaturant concentration would provide insufficient tolerance given that the Alcohol and Tobacco Tax and Trade Bureau requires a 1.96 percent minimum denaturant concentration.<sup>452</sup> They stated that EPA should provide a more reasonable tolerance to avoid inadvertent compliance issues.

A number of refiners stated that the current 5 volume percent maximum on denaturant concentration established by ASTM would limit concerns regarding components other than sulfur so that they would be unlikely to impact vehicle emissions performance. One refiner stated that EPA should adopt the entire California specifications for DFE in order to address concerns about potential emissions impacts of fuel components in denaturants other than sulfur. They stated that this would not impose an additional burden on DFE producers since logistical difficulties in segregating ethanol destined for California from other destinations has already caused producers to DFE to California specifications.

<sup>450</sup> California Code of Regulations 13 CCR section 2262.9. ASTM International D4806-13a, "Standard Specification for Denatured Fuel Ethanol for Blending with Gasolines for Use as Automotive Spark-Ignition Engine Fuel".

<sup>451</sup> This RFS2 program provision is covered under the definition of renewable fuel/ethanol in 40 CFR 80.1401. The volume of denaturant used in excess of 2 volume percent must be subtracted from the total volume of DFE for RIN generation purposes.

<sup>452</sup> Alcohol and Tobacco Tax and Trade Bureau formulas require a minimum of two parts of approved denaturant to 100 parts of ethanol with a minimum of 195 proof ethanol.: 27 CFR Subpart X, Distilled Spirits for Fuel Use; ASTM International D4806-13a, "Standard Specification for Denatured Fuel Ethanol for Blending with Gasolines for Use as Automotive Spark-Ignition Engine Fuel".

Since we are not finalizing benzene, olefin, or aromatics specifications for ethanol denaturants like California, we continue to believe that it is appropriate to implement a more stringent limit on maximum denaturant concentration to address concerns about the potential impact on vehicle emissions of fuel parameters in ethanol denaturants other than sulfur. Setting a more stringent limit on denaturant concentration will ensure that harmful components such as benzene potentially present in ethanol denaturants are adequately diluted in the finished fuel blend. We agree with comments that it is appropriate to provide additional flexibility for the allowable denaturant levels that may be used. Therefore, we are finalizing a 3.0 volume percent maximum on ethanol denaturant concentration. This approach provides sufficient flexibility to DFE producers while avoiding the need to impose additional testing burdens on denaturant and DFE producers (e.g., for benzene and aromatics). We will consider whether additional controls may be needed for mid-level ethanol blends and E85 in a later action.

#### 4. Demonstration of Compliance With the Sulfur Requirements and Requirements for Certified Ethanol Denaturants

To demonstrate compliance with the 10 ppm sulfur cap finalized today, we proposed that producers and importers of DFE would be required to test the sulfur content of each batch of DFE they produce. We also proposed that DFE producers would be required to provide batch records to EPA on an annual basis. We requested comment on whether to require producers of denaturants for use in DFE to register with EPA and to demonstrate compliance with a maximum sulfur specification based on the anticipated dilution with ethanol.

Refiners stated that producers of DFE should be subject to requirements similar to those for gasoline refiners including batch sampling. However, refiners stated there would be no added value in requiring batch reports from DFE producers. Ethanol producers currently use certificates of sulfur analysis from denaturant producers and volumetric DFE blending records to assure themselves that when a sample of DFE is tested by the State of California that it will be found to be compliant with a 10 ppm sulfur cap.<sup>453</sup> They

<sup>453</sup> The State of California does not rely on industry testing and recordkeeping to help establish compliance with their sulfur requirements for DFE, instead choosing to focus on direct testing that they

stated that EPA should accept such records to demonstrate compliance with the federal 10 ppm sulfur cap for DFE in place of per-batch sulfur testing on DFE. Under this approach, ethanol producers would maintain records regarding the denaturant sulfur content and the calculations used to determine the sulfur content of the finished DFE. Because the sulfur content of neat (undenatured) ethanol manufactured using industry standard quality control practices should be negligible, the sulfur content of DFE is effectively determined by the sulfur content of denaturant used.<sup>454</sup> Ethanol producers stated that they would also perform standard quality assurance activities including sampling incoming shipments of denaturant for sulfur content on a periodic basis.

Ethanol producers stated that many DFE production facilities do not have on site sulfur testing equipment and the installation of such equipment would represent a substantial burden to DFE producers. Ethanol producers stated that they had worked with denaturant producers to ensure access to a low-sulfur stream of denaturants, and that it is common business practice for denaturant producers to provide them with information on the sulfur content of their product. Ethanol producers stated that sulfur test results from the ASTM Inter-laboratory Crosscheck Program (ILCP) for DFE illustrate that batch reporting for DFE is unnecessary. They noted that the ILCP data shows DFE typically has sulfur content of 1 to 5 ppm.

Ethanol producers stated that requiring denaturant manufacturers to register with EPA would limit the number of denaturant suppliers willing to supply the ethanol industry. They stated that it is inappropriate to require a natural gasoline producer to register in order to supply product for DFE, because they are not required to register in order to supply the same product to a gasoline blender.

EPA agrees that it is appropriate to finalize requirements for the demonstration of compliance with the 10 ppm sulfur cap for DFE that are based on current industry practices rather than requiring sulfur testing on each batch of DFE.<sup>455</sup> We agree that that

conduct. EPA relies on the review of industry records including those associated with testing conducted by industry as well as direct testing conducted by EPA for compliance assurance.

<sup>454</sup> Ethanol manufacturers conduct periodic sulfate testing on neat ethanol to ensure that sulfur contamination from the manufacturing process is negligible.

<sup>455</sup> Per-batch sulfur testing for other potential oxygenates will be required to demonstrate

potential contribution to the sulfur content of DFE other than from the addition of denaturants can be adequately addressed by the retention of production quality control records by the ethanol manufacturer. We agree that it is most appropriate to place the primary focus of compliance assurance on the denaturant manufacturers given the denaturant typically contributes the majority of the sulfur to the finished DFE. Therefore, we are finalizing streamlined provisions that DFE producers and importers may use in demonstrating compliance with the 10 ppm sulfur cap for DFE as an alternative to testing each batch of DFE for its sulfur content. These streamlined provisions are based on the use of denaturant batch sulfur testing conducted by denaturant producers who have registered with EPA and certified the denaturant they produce as meeting EPA requirements.<sup>456</sup> Uncertified denaturants from unregistered denaturant producers may be used by DFE producers provided that they test each batch of DFE to demonstrate compliance with the 10 ppm sulfur cap for DFE.<sup>457</sup>

DFE manufacturers that use denaturants that have been certified and designated on the denaturant product transfer document (PTD) as suitable for use in the manufacture of DFE that meets federal requirements will be able to use PTDs for the denaturants used and volumetric blending records which show that the denaturant was added at 3.0 volume percent or less in demonstrating compliance with the 10 ppm sulfur cap for DFE in lieu of per-batch sulfur testing of DFE. The sulfur content of "neat" (i.e. un-denatured) ethanol may be assumed to be negligible for the purposes of demonstration of compliance using volumetric blending records provided that the DFE manufacturer maintains quality control records that demonstrate this assumption is justified. Today's rule also requires that DFE manufacturers conduct quality assurance to demonstrate affirmative defenses to

compliance with the 10 ppm sulfur cap. EPA may consider amending the requirements for other potential oxygenates in a later rulemaking based on additional information that we might receive.

<sup>456</sup> Certified denaturant producers and importers will be required to register with EPA as a certified denaturant producer or importer by November 1, 2016, or 60 days before introducing certified denaturant into commerce, whichever is earlier.

<sup>457</sup> The limitation on the types of denaturants that may be used and the maximum concentration at which a denaturant may be used discussed in Section V.G.2 and 3 would apply regardless of whether a denaturant from a registered or non-registered denaturant manufacture are used.

presumptive liability.<sup>458</sup> Producers and importers of DFE must initiate a PTD to accompany each batch of DFE which states that it meets federal standards.

Denaturant manufacturers are accustomed to providing certificates of sulfur analysis to DFE manufacturers. Therefore, we believe that the requirements finalized today for denaturant manufacturers to conduct per-batch sulfur testing, initiate a product transfer document stating that denaturant is suitable for use in manufacturing DFE that meets federal requirements, retain records, and register with EPA will not represent a substantial new burden. DFE manufacturers who use the mathematical method to demonstrate compliance with DFE sulfur requirements must only use certified denaturants from registered denaturant manufacturers. Registering with EPA will be a one-time act, as will be the necessary modifications to denaturant product transfer documents. Thus, the requirement to register with EPA should not be a serious impediment for a manufacturer to enter the denaturant supply market. We believe that it is necessary to require denaturant manufacturers to register with EPA in order to facilitate compliance oversight. EPA needs to be able to identify all manufacturers of denaturants in order to periodically audit their records, and to recognize potential denaturants in the system that are incorrectly designated as a certified denaturant appropriate for use in manufacturing DFE that meets federal sulfur requirements. Denaturant manufacturers that supply their product to refiners for use in the manufacture of gasoline are not required to register with EPA because, unlike the DFE manufacturers, refiners are responsible for testing the final gasoline they produce.

As is current practice today, we anticipate that ethanol manufacturers will negotiate the specific sulfur level they require from denaturant manufacturers to facilitate compliance with the 10 ppm sulfur cap for DFE taking into consideration what level of compliance margin a given manufacturer feels is necessary. We believe that it is appropriate to allow this practice to continue. We understand that ethanol manufacturers currently require denaturant manufacturers to provide a product with a sulfur content of 120 ppm or less in order to ensure that DFE that contains

5 volume percent denaturant can comply with California's 10 ppm sulfur cap for DFE. Thus, we expect that denaturant manufacturers will not need to change the sulfur content of the denaturant they manufacture in order to comply with the requirements finalized today.

Manufacturers of certified denaturants used by DFE producers that employ the volumetric blending record method in demonstrating compliance with the sulfur requirements for DFE must retain per batch sulfur test data on the denaturants they produce to demonstrate that the sulfur content of the denaturant will not cause the sulfur content of DFE to exceed 10 ppm when added to neat ethanol at 3.0 volume percent. The sulfur content of the certified denaturant must be stated on the PTD and must be no greater than 330 ppm. Any sample of denaturant which is designated as appropriate for use in manufacturing DFE that meets federal requirements, that is found by EPA to have sulfur content above 330 ppm will be deemed to be noncompliant, and the denaturant manufacturer may be liable for the associated penalties. A denaturant with a sulfur content of 330 ppm when used at 3.0 volume percent would result in a sulfur content of the finished DFE of 10 ppm. Certified denaturant manufacturers may represent the denaturant they produce as having a sulfur content of less than 330 ppm on the PTD. In such cases, the denaturant batch must not exceed the sulfur content stated on the PTD.

We continue to believe that annual reports from oxygenate producers are important enforcement and compliance assurance tool. Therefore, we are finalizing the requirement that producers and importers of DFE and other oxygenates must register with EPA as and oxygenate producer or importer and submit annual reports to EPA that include the total volume of DFE/oxygenate produced and an attestation that all batches met the proposed fuel quality requirements.<sup>459</sup>

#### 5. Additional Requirements for Denatured Fuel Ethanol, Ethanol Denaturants, and Other Gasoline Oxygenates

We are finalizing regulatory text to clarify that DFE and other gasoline oxygenates must be composed solely of carbon, hydrogen, oxygen, nitrogen, and sulfur. Manufacturers of denaturants that are designated as suitable for use in

the manufacture of DFE that meets federal requirements will also be required to attest that the denaturant is composed solely of carbon, hydrogen, oxygen, nitrogen, and sulfur.

Producers and importers of gasoline oxygenates, producers and importers of denaturants designated as suitable for manufacturing DFE meeting federal sulfur requirements, fuel distributors, and oxygenate blenders will be required to maintain the applicable records for 5 years and provide them to EPA upon request.

#### H. Standards for Fuel Used in Flexible Fueled Vehicles

Flexible fuel vehicles (FFVs) are vehicles that are capable of operating on both gasoline and gasoline blends containing up to 83 volume percent ethanol. Ethanol fuel blends that contain from 51 and 83 volume percent ethanol (E51–83) have historically been referred to as “E85” in reference to the maximum allowed content of denatured ethanol assuming a 2 percent denaturant concentration.<sup>460</sup> Fuel blends that contain from 16 to 50 percent ethanol (E16–50) are sometimes referred to as mid-level ethanol blends. Both E51–83 and E16–50 are currently used only in FFVs.

Whether FFVs are operating on clear gasoline (E0), E85, or any level of ethanol in between, to maintain emission performance the vehicles still need fuel that meets certain quality specifications, such as the 10 ppm average gasoline sulfur standard finalized today. We anticipate that the use of higher level ethanol blends in FFVs will continue to increase in the future as the RFS program continues to be implemented. Significant public and private initiatives are also currently underway to expand the use of ethanol blender pumps that dispense a variety of ethanol blends for use in FFVs.<sup>461</sup> Therefore it is becoming increasingly important that all fuels used in FFVs, not just gasoline, meet fuel quality standards. The lack of separate fuel quality standards that apply to fuels used in FFVs could act to impede the further expansion of ethanol blended fuels, which is important to satisfying the requirements of the RFS program. For these reasons, we believe it is

<sup>460</sup> Industry consensus standards for E51–83 are described in ASTM International D5798–13, “Standard Specification for Ethanol Fuel Blends for Flexible-Fuel Automotive Spark-Ignition Engines”.

<sup>461</sup> The U.S. Department of Agriculture (USDA) has a program to assist in the funding for the installation of as many as 10,000 ethanol blender pumps over the next 15 years in rural areas. Growth Energy has a “Blend Your Own Ethanol” program to encourage the installation of ethanol blender pumps.

<sup>458</sup> Such quality assurance practices include periodic calibration of the denaturant blending equipment to ensure that denaturants are not added in excess of 3.0 volume percent.

<sup>459</sup> Oxygenate producers and importers will be required to register with EPA as an oxygenate producer or importer by November 1, 2016, or 60 days before introducing certified denaturant into commerce, whichever is earlier.



important that our gasoline quality standards for not just sulfur, but also benzene, Reid Vapor Pressure (RVP), detergency, and compliance with the interpretive rule defining the phrase “substantially similar” in CAA section 211(f)(1)<sup>462</sup> (i.e., contain only carbon, hydrogen, oxygen, nitrogen, and sulfur) apply to any fuel used in an FFV.

Our various standards for gasoline currently apply to any fuel sold for use in motor vehicles, which is commonly or commercially known or sold as gasoline. In the fuel and fuel additive registration program, the gasoline family includes fuels composed of at least 50 percent clear gasoline by volume.<sup>463</sup> As a result, our gasoline standards currently apply to E16–50 ethanol blends. However, additional regulatory provisions could be useful to facilitate compliance assurance if we are to continue to treat such mid-level ethanol blends as gasoline.

The existing requirement that E51–83 must be substantially similar (sub-sim) to the vehicle certification test fuel has provided a limited measure of control over in-use E51–83 fuel quality. The finalization of specifications for FFV exhaust emission test fuel in today’s action will provide improved clarity regarding what constitutes sub-sim for in-use E51–83. However, these specifications are not sufficient to provide clarity as to what is considered sub-sim for E51–83. For example, E51–83 manufactured using only gasoline, gasoline blendstocks for oxygenate blending (BOBs), a limited volume of butane that meets the standards for downstream blending into gasoline, and denatured fuel ethanol that meets the standards finalized today would clearly be sub-sim. However, use of natural gasoline may or may not result in an E51–83 blend that is sub-sim. In addition to the need for additional clarity regarding what constitutes sub-sim for E51–83, standards for sulfur, benzene, and RVP are needed to ensure fuel quality supports the attainment of our environmental goals.

At proposal, we sought comment on appropriate regulatory mechanisms to implement in-use quality standards for E51–83 and E16–50. We requested specific comment on possible approaches, including draft regulations, which were described in detail in a memorandum to the docket.<sup>464</sup> The draft regulations contained fuel quality specifications for E51–83 and two

options that E51–83 manufacturers could use to demonstrate compliance. We sought comment on whether the Agency should continue to treat E16–50 as gasoline and on the need to clarify existing regulations on the meaning of gasoline as any fuel that contains 50 percent or more gasoline. Given that E16–50 can only be used in FFVs, we also sought comment on whether to amend the regulations to treat E16–50 as an alternative fuel. If EPA were to treat E16–50 as an alternative fuel rather than gasoline, we sought comment on whether we should take the same approach for E16–50 as detailed in the draft regulations for E51–83 with respect to sulfur, benzene, RVP standards, and substantially similar requirements under CAA section 211(f).

We received comments in support of and against our proposal. The vast majority of comments supported the need for EPA to promulgate in-use quality standards for these higher level ethanol blends. We also received a number of detailed productive comments on the draft regulations. A number of stakeholders also expressed their willingness to work with EPA to provide supplementary information on issues that were not addressed at proposal and not contained in their comments. At this time, we acknowledge that additional work is needed on some issues and we note that such work could not be accommodated within the timeline for this Tier 3 final rule. Therefore, we are deferring final action on these provisions at this time. We will continue to work with stakeholders in developing in-use fuel quality standards for higher level ethanol blends following the publication of this final rule. Subsequently, we may issue a supplementary proposal prior to issuing a final rule if the additional information we receive from stakeholders warrants such an action.

#### *I. Sulfur Standards for Purity Butane and Purity Pentane Streams Blended into Gasoline*

Under the Tier 2 gasoline program, “purity” butane blended into gasoline downstream of the refinery is subject to a 30 ppm sulfur cap and other specifications regarding its composition.<sup>465</sup> This is consistent with the 30 ppm refinery average sulfur standard under the Tier 2 program. Today’s action finalizes the proposed 10 ppm sulfur cap for purity butane blended into gasoline effective January 1, 2017. This is consistent with the Tier

3 10 ppm refinery average sulfur specification finalized today.

As discussed in Section VI.A.4 in today’s preamble, we are finalizing provisions to allow “purity” pentane to be blended into gasoline downstream of the refinery that are similar to the existing provisions for butane blending. This allowance will become effective June 27, 2014. Until December 31, 2016, a 30 ppm sulfur cap will apply to purity pentane blended into gasoline consistent with the existing sulfur cap for purity butane under the Tier 2 program.<sup>466</sup> Beginning January 1, 2017, a 10 ppm sulfur cap will apply to purity pentane blended into gasoline consistent with the butane sulfur standard finalized today.

Butane blenders commented that a significant fraction of butane and pentane might be expected to have sulfur content in excess of 10 ppm after the Tier 3 gasoline sulfur requirements become effective. To maintain a stable and adequate supply of butane and pentane for downstream RVP trimming, butane blenders requested that EPA adopt a 10 ppm sulfur average cap with a 30 ppm sulfur cap.<sup>467</sup>

Butane and pentane have an inherently low sulfur content that can be made to meet a 10 ppm sulfur cap with relatively mild desulfurization techniques. We anticipate that butane and pentane suppliers will desulfurize these blendstocks to well below 10 ppm sulfur as part of their response to the Tier 3 gasoline sulfur requirements. Therefore, we believe that allowing butane and pentane used for RVP trimming to exceed a 10 ppm sulfur cap would needlessly complicate compliance assurance and defer some of benefits of the Tier 3 sulfur requirements.

#### *J. Standards for CNG and LPG*

The vehicle emissions standards finalized today are fuel neutral (i.e., they are applicable regardless of the type of fuel that the vehicle is designed to use). There currently are no sulfur standards for the fuel used in compressed natural gas (CNG) and liquid propane gas (LPG) vehicles. We requested comment on whether it is necessary for EPA to establish sulfur standards for CNG and LPG to enable them meeting more stringent vehicle

<sup>466</sup> Other requirements regarding the composition of purity pentane will also apply that are similar to those for purity butane.

<sup>467</sup> RVP trimming refers to the practice of adding a limited amount of butane/pentane to previously certified gasoline at a terminal so that the finished gasoline is closer to the maximum applicable volatility standard (summer or winter) than can be attained at the refinery level.

<sup>462</sup> 73 FR 22277, 22281 (April 25, 2008).

<sup>463</sup> 40 CFR 79.56(e)(1)(i).

<sup>464</sup> Possible Approach to Fuel Quality Standards for Fuel Used in Flexible-Fuel Automotive Spark-Ignition Vehicles (FFVs), Memorandum to the docket, Jeff Herzog, April 2013.

<sup>465</sup> 40 CFR 80.82.

emissions standards, and whether a 15 ppm sulfur cap similar to that established for highway diesel fuel would be appropriate. Comment was also requested on whether and how to address the sulfur contribution from odorants and other additives used in CNG and LPG.

We received comments in support of and against EPA establishing sulfur standards for CNG and LPG and whether such standards are necessary to enable CNG and LPG vehicles to meet the vehicle emissions standards finalized today.<sup>468</sup> In addition, some commenters stated that EPA should not establish new sulfur standards for in-use CNG and LPG fuels until additional data is available on current sulfur levels, and the feasibility/costs associated with potential additional sulfur controls have been evaluated.

EPA is deferring finalizing in-use sulfur requirements for CNG/LPG in this final rule to provide additional time to work with stakeholders to collect data on current CNG/LPG sulfur content, to determine whether additional control of in-use CNG/LPG sulfur content is needed, and to evaluate the feasibility and costs associated with potential additional sulfur controls. Given that the information currently available suggests already low sulfur levels in CNG/LPG, the vehicle emissions standards finalized today will apply to CNG/LPG vehicles in addition to vehicles fueled on gasoline, diesel fuel, or any other fuel.<sup>469</sup>

#### *K. Refinery Air Permitting Interactions*

EPA recognized when it proposed the Tier 3 fuel program that it is important to the success of the Tier 3 fuel program that refineries be able to obtain air permits, if needed, in time to complete the modifications necessary to comply with the proposed gasoline sulfur program. Accordingly, to help inform the public and obtain comment on this topic, a section of the preamble to the proposed rule presented background information on air permitting requirements and programs. That information is not repeated in full here. Based on our preliminary assessment of the proposed rule's implications for needed refinery modifications, we estimated at the time of our proposal that only a small percentage of refineries would likely need to make modifications that would trigger a requirement to obtain air permits.

Moreover, we anticipated that these permit applications would be processed quickly enough that air permitting would not be a significant obstacle to timely compliance with the proposed gasoline sulfur program. We continue to anticipate that there will be no such obstacle.

Based on our final assessment, which takes into consideration updated information on current refinery configurations and operations and refineries' future plans as well as the requirements and flexibilities in the final Tier 3 fuel program, we believe that under the final Tier 3 gasoline sulfur standard from a low of four to a high of nine refineries would need major source NSR permits, which includes nonattainment New Source Review (NSR) and/or Prevention of Significant Deterioration (PSD) permits. This estimate equates to approximately four to eight percent of the 108 refineries projected to sell gasoline that will be subject to the Tier 3 standards. The number of refineries needing major source NSR permits could be even lower if refineries apply emission controls to reduce emissions increases below the significance levels applicable to affected pollutants or if they "net out" of NSR for the affected pollutants. As stated above, EPA continues to anticipate that permit applications associated with refinery changes needed to comply with the Tier 3 fuel program will be processed quickly enough that air permitting will not be a significant obstacle to timely compliance with the gasoline sulfur program.

#### 1. Proposal

In the proposed rule, we stated our anticipation that the types of changes (both physical and operational) that would occur at most refineries would not result in sufficient emissions increases to require major NSR permits as a prerequisite for completing the needed changes for several reasons: because the emissions increase or the net emissions increase is naturally less than the significant level, because the refinery installs control technologies on project-affected units to further limit the emissions increase, and/or because the refinery "nets out" all or part of the emissions increase.

However, we anticipated that a small number of refineries had the potential to experience emissions increases to meet the proposed gasoline sulfur standard that are large enough to trigger major NSR (Nonattainment NSR and/or PSD). This small number of refineries would have to obtain a major NSR preconstruction permit prior to making these necessary process changes. For

any required major NSR permits, the associated control technology requirements (BACT and/or LAER) would apply only to new or modified units associated with the project and not to units at the refinery that are not affected by the project. We did not anticipate that the time frames required for the small number of affected refineries to obtain any needed NSR and/or PSD permits would present an obstacle to timely compliance with the proposed Tier 3 gasoline sulfur requirements.

In the proposal we also discussed a number of concepts that might facilitate more expeditious permitting where it is required as a result of refinery changes needed to meet the new requirements. That discussion was based primarily on concepts that had arisen during the earlier Tier 2 fuel program. That discussion is not repeated here. We invited public comment on those concepts.

#### 2. Updated Assessment of Tier 3 Refinery Changes and Permitting Implications

EPA has updated our refinery-by-refinery assessment of the physical and operational changes that are likely to be needed to allow each active refinery in the U.S. to produce gasoline that complies with the final Tier 3 fuel specifications. We have also assessed the likely effects of those changes on refinery emissions. This updated assessment is described in more detail in the final RIA. Using this updated assessment, we were able to update our understanding of the potential scope of the major NSR permitting requirements refineries might face under the final Tier 3 program. In general, our assessment indicates that only a small number of refineries will likely need to make modifications of a type and size that would trigger the need for a PSD or nonattainment NSR permit.

In our updated analysis, we adjusted the analysis to reflect the existence of a nationwide average, banking, and trading (ABT) program and refined our estimates regarding the physical and operational changes that will be required at each refinery (as described in the final RIA). The modifications at a given refinery could include revamps to existing FCC pre- or post-treatment unit(s) or the installation of a new grassroots post-treatment unit for sulfur reduction. Based on the updated projections of refinery-specific changes, we re-estimated the increased demand for energy (i.e., fuel to generate process heat, steam, and electricity), hydrogen, and sulfur recovery associated with meeting the final Tier 3 standards.

<sup>468</sup> See Chapter 5.8. in the Summary and Analysis of Comments Document that accompanies this rule.

<sup>469</sup> Several commenters provided information on CNG and LPG sulfur levels as discussed in the Summary and Analysis of Comments associated with this rule.

Having received no comments suggesting that they should be changed, we re-applied the representative industry emission factors for NAAQS pollutants, their precursors, and GHGs for each emitting process and combined them with estimates of incremental activity to estimate the emissions changes at each equipment unit (or group of similar units) at each refinery.

We determined upper and lower bounds for emissions increases resulting from changes necessary to meet the final Tier 3 gasoline sulfur specification. We did not have sufficient detailed information to predict which refineries would find it most profitable to generate additional electrical power and hydrogen on site rather than purchasing these inputs from external suppliers. If a refinery generates these additional inputs internally on site, the additional emissions would count towards the significant emissions rates and could affect the need for a major NSR permit. To account for these variables, we evaluated a high and a low case for each identified scenario. Under the high case, we assumed 100 percent internal generation of the additional electrical power and hydrogen, and under the low case, 100 percent external generation of the same. We expect refineries to actually be somewhere between these two extreme cases in the future. For the identified high and low cases, we compared the emissions increase for each pollutant at each refinery to the significant emissions increase threshold for that pollutant, taking into consideration the current attainment status for each pollutant where the refinery is located.

An important aspect of our analysis is that we assumed that refineries would not install new emission controls on affected units for the purpose of staying below the significant emissions increase threshold and thereby not triggering major NSR. In particular, we did not assume that selective catalytic reduction (SCR) to control NO<sub>x</sub> emissions would be applied to new or modified fuel combustion units. This is an important assumption that tends to result in overestimates of the number of major NSR permits needed for NAAQS-related pollutants. In reality, applying new emission controls would be an option that refineries may employ to legally avoid major NSR permitting. We also did not assume that refineries would “net out” of NSR by taking credit for any emissions reductions occurring within a contemporaneous timeframe, including any new emissions reduction projects initiated specifically for the purpose of “netting out.” This analysis resulted in a prediction of whether a

PSD and/or a Nonattainment NSR permit would be needed for each refinery and the pollutants that would have to be addressed in those permits, under each of the two scenarios. Only the results for the high case are presented here. More detailed results as well as the underlying methodology used in the permitting analysis are described in the final RIA for this rulemaking. In general terms, we found that for the low case only about one-half the number of refineries were estimated to trigger major NSR as were estimated for the high case.

We found that under the high case, nine refineries appeared likely to have significant emissions increases for one or more pollutants and thus would trigger major NSR.<sup>470</sup> This estimate equates to approximately eight percent of the 108 refineries projected to sell gasoline that will be subject to the Tier 3 standards. Of these nine refineries, we predicted that three refineries would need major source permits for NAAQS-related pollutants and their precursors (PSD and/or Nonattainment NSR) and for GHGs (results for GHG are discussed below). Thus, we believe that under the final Tier 3 program only about three refineries may need major NSR air permits to address NAAQS pollutants. This number could be lower if those refineries apply pollution controls, such as SCR for NO<sub>x</sub>, to sufficiently reduce the emissions increases to levels that are below the applicable pollutant significance level, or if the refineries can achieve emissions reductions elsewhere at the facility to “net out” of major NSR. For refineries that are required to obtain a major NSR permit for NAAQS pollutants, the permitting process is expected to normally take about 9 to 12 months once the permitting authority has received a complete application.

All three refineries just described as potentially needing NSR permits for NAAQS pollutants are also projected to need PSD permits for GHGs. In addition to these three refineries, we estimated that six other refineries may require a PSD permit addressing only GHG emissions from new or modified equipment that is part of the project. For these nine refineries, BACT would have to be applied for GHG emissions, which we expect in most cases would mean that new or modified fuel-burning equipment would have to be designed for good energy efficiency. We expect that the types of equipment and process

technologies that refineries are likely to modify or add to meet the final Tier 3 standards will generally be sufficient to satisfy BACT requirements for GHG emissions in terms of achievability, cost-effectiveness, and energy-efficiency even absent the requirement to obtain a permit, meaning that having to demonstrate that BACT is in place would not necessitate any shift in project design or cause increased costs. This expectation is based on the fact that there are strong economic incentives for refineries to design and purchase the most energy-efficient process equipment to minimize the cost of production. For example, some of the new or modified equipment expected to be involved in refinery projects designed to meet the final Tier 3 standards are fuel combustion units (e.g., process heaters). Because fuel cost (direct cost in the case of purchased natural gas and opportunity cost in the case of refinery-generated fuel gas) represents a significant component of total operating cost for such units, refineries will strive to maximize energy efficiency based on available technologies as part of their project design.

In 2010, EPA issued a white paper on available and emerging technologies for reducing GHGs from the petroleum refining industry.<sup>471</sup> This white paper addresses the types of equipment expected to be involved in projects designed to meet the final Tier 3 fuel standards, including process heaters/boilers, hydrogen plants, and sulfur recovery units. The identified GHG control technologies for these types of units predominately involve opportunities for energy efficiency. Consistent with the findings reported in the white paper, our experience to date with GHG permitting at refineries and other similar sources supports the application of energy efficient design and operation of affected units for meeting BACT requirements, and we do not expect that in the time frame associated with Tier 3-related projects, add-on controls would be required.

For EPA-issued permits and permits issued by state or local agencies under delegation, consultation with other federal agencies under the Endangered Species Act and consideration of environmental justice will also be required. Significantly, no air quality modeling of GHGs will be required, and thus there would be no need to obtain extensive input information on

<sup>470</sup> Because state requirements regarding minor NSR permitting vary and we do not expect minor NSR permitting programs to be a significant challenge for refinery modification projects, we did not attempt to estimate how many of the remaining refineries might need to obtain minor NSR permits.

<sup>471</sup> See “Available and Emerging Technologies for Reducing Greenhouse Gas Emissions from the Petroleum Refining Industry,” October 2010, available at <http://www.epa.gov/nsr/ghgpermitting.html>.

meteorology and emissions from other nearby sources. Given these differences, we expect that the timeline for obtaining a permit only for GHG emissions should be shorter by several months than the timeline for a permit that addresses NAAQS pollutants.

On March 22, 2012, the President issued Executive Order 13604 (EO 13604), Improving Performance of Federal Permitting and Review of Infrastructure Projects. EO 13604 states that federal permitting and review processes must provide a transparent, consistent, and predictable path for both project sponsors and affected communities, and that a number of described elements must be incorporated into routine agency practices to provide improvements in the performance of federal permitting processes.

Under the EO, EPA has adopted a plan identifying the permitting and review processes that EPA views as most critical to significantly reduce the aggregate time required to make permitting and review decisions on infrastructure projects while improving outcomes for communities and the environment, and describing specific and measurable actions the agency will take to improve these processes.<sup>472</sup> With regard to permitting under the Clean Air Act, this plan stated EPA's intention to issue a guidance memorandum by the end of 2012 to apply to PSD permits issued by EPA and by state or local agencies with delegated authority from EPA, aimed at clarifying expectations and responsibilities regarding the timely processing of permit applications by an EPA Regional Office or delegated agency. This memorandum was subsequently issued on October 15, 2012.<sup>473</sup> EPA Regional Offices serving as the permitting authorities for refineries making modifications as part of the Tier 3 program will be guided by the memorandum. The memorandum also recommends that other permitting authorities consider following the approaches outlined in the memorandum where applicable.

### 3. Comments and Responses

Several oil industry commenters expressed doubt about whether EPA's prediction of the small number of refineries that would need GHG permits

was realistic. Commenters generally stated that permits for the modifications needed to comply with the Tier 3 requirements should be issued expeditiously. Some industry commenters expressed doubt that this would be the case, noting what they characterized as the slow pace at which GHG permits have been issued since the requirement for GHG permitting became effective. One oil industry commenter suggested that Tier 3-related modifications be completely exempt from permitting if they would not increase refinery capacity by more than 10 percent. No other specific suggestions for streamlining were submitted. Environmental groups commented that any efforts to streamline permitting should not relax the substantive requirements to get a permit.

The final rule does not establish any new flexibilities or exceptions to current permitting regulations. On an ongoing basis, EPA continues to consider ways to streamline the permitting process consistent with CAA requirements and goals. EPA has concluded that only a small number of refineries appear to have the potential of triggering major source permitting as a result of modifications needed to meet the Tier 3 fuel program, given the flexibilities provided by the final program in terms of when modifications must be in place in order to achieve compliance. There were no industry comments that demonstrated a specific reason for concern about permitting implications on a broad scale.

The Response to Comment Document includes a fuller summary of the comments on refinery permitting implications and the EPA responses to these comments.

#### *L. Refinery Feasibility*

While evaluating the merits of a national gasoline sulfur program to reduce emissions and enable future vehicle technologies, we also considered the refining industry's ability to reduce sulfur to 10 ppm on average by January 1, 2017 and the associated costs (for more on fuel costs, refer to Section VII.B). Based on information gathered from numerous stakeholder meetings and discussions with vendor companies that provide the gasoline desulfurization technologies both before and after the proposal, as well as the results from our refinery-by-refinery modeling, we believe it is technologically feasible at a reasonable cost for refiners to meet the sulfur standards in the lead time provided. A summary of our feasibility analysis is presented below. For more on our

feasibility and cost assessments and the refinery modeling that supports them, refer to Chapters 4 and 5 of the RIA.

#### 1. Comments Received

We received a number of comments on the proposed rule regarding feasibility and lead time. Commenters in the refining industry generally stated that they believe that the amount of lead time proposed is not sufficient. These commenters noted concerns that the short lead time proposed would drive up costs as there would be unscheduled shut-downs to install and/or revamp equipment to meet the Tier 3 sulfur standard, and would not provide enough time for the permitting process. These commenters requested at least five years of lead time, and noted that EPA has historically provided at least four years of lead time in previous fuels rulemakings. Commenters in the auto industry, as well as states and non-governmental organizations (NGOs), encouraged us to finalize the rule as soon as possible and to retain the January 1, 2017 start date to harmonize our program with California's LEVIII program and to enable Tier 3 benefits as soon as possible. As discussed in more detail below, we believe the amount of lead time provided is sufficient, especially given the flexibilities being provided. A complete discussion on the comments received with regard to lead time can be found in Chapter 5 of the Summary and Analysis of Comments document.

#### 2. Is it feasible for refiners to comply with a 10 ppm average sulfur standard?

Gasoline desulfurization technologies are well known and are readily available. Many technologies were demonstrated under Tier 2 and have been further demonstrated by current fuel programs in California, Japan, and Europe. Under California's Phase 3 Reformulated Gasoline program (CaRFG3), gasoline sulfur is limited to 15 ppm on average with a 20 ppm per-gallon cap.<sup>474</sup> California reduced their per-gallon cap in phases from 60 ppm effective December 31, 2003, to 30 ppm effective December 31, 2005, to 20 ppm effective December 31, 2011. Actual in-use gasoline sulfur levels, however, have been largely constrained by the Predictive Model that California refiners are using to demonstrate compliance. As a result, gasoline sulfur levels are lower than the CaRFG3 limits. Based on the

<sup>472</sup> The U.S. EPA Plan for Modernizing Federal Permitting and Review Pursuant to EO 13604, August 9, 2012. <http://www.epa.gov/epainnov/pdf/ea-infrastructure-epa-final-plan.pdf>

<sup>473</sup> Timely Processing of Prevention of Significant Deterioration (PSD) Permits when EPA or a PSD-Delegated Air Agency Issues the Permit, Stephen D. Page to Regional Air Division Directors, October 15, 2012. <http://www.epa.gov/region07/air/nsr/nsrmemos/timely.pdf>

<sup>474</sup> California Air Resources Board. (2008, August 29). *The California Reformulated Gasoline Regulations*, Title 13, California Code of Regulations, Sections 2250–2273.5. Retrieved from [http://www.arb.ca.gov/fuels/gasoline/082908CaRFG\\_regs.pdf](http://www.arb.ca.gov/fuels/gasoline/082908CaRFG_regs.pdf).

Predictive Model, California gasoline contained approximately 10 ppm sulfur on average in 2010 (9 ppm in the summer and 11 ppm in the winter).

Japan currently has a 10 ppm gasoline sulfur cap that took effect in January 2008. Europe also has a 10 ppm sulfur cap that has been adopted by the 30 Member States that comprise the European Union (EU) and the European Free Trade Association (EFTA) as well as Albania and Bosnia-Herzegovina.<sup>475</sup> Beijing, China also recently introduced a 10 ppm sulfur limit for gasoline.<sup>476</sup> These standards are considerably more stringent than the 10 ppm annual average standard being finalized today because each batch of gasoline produced at every refinery must meet the 10 ppm cap. As a result, every refinery must be designed to meet this cap regardless of changes in crude oil supply, operation conditions, or product mix. We note, however, that many oil refineries outside of the United States operate differently from their U.S. counterparts. U.S. refiners have invested more heavily in fluidized catalytic cracker (FCC) units than the rest of the world to maximize gasoline production. Because the FCC unit is responsible for nearly all the sulfur that ends up in gasoline, many U.S. refineries may face a bigger challenge in achieving 10 ppm gasoline sulfur levels. Even in the U.S., however, the picture is changing. The Annual Energy Outlook for 2013 produced by the Energy Information Administration supports the view that the U.S. demand for diesel fuel is increasing while the demand for gasoline is decreasing, starting the process that will make the U.S. more like Europe. Thus, U.S. refiners seem to be beginning to move away from relying on the FCC unit as the most important refinery unit. For

this reason, the challenge of complying with more stringent gasoline sulfur control will decrease over time, and we discuss this more at the end of this section.

The review of gasoline sulfur control in California and elsewhere and the future trend for gasoline demand support that achieving 10 ppm is feasible. The Tier 3 requirements are less demanding than those of Europe or Japan. This is because the Tier 3 sulfur standard is an average standard instead of a cap standard. The accompanying Tier 3 cap standard is 80 ppm, which is much higher than the average standard, allows individual gasoline batches to vary in sulfur level throughout the year. Complying with Tier 3 is also made easier, as compared to California, Europe and Japan, by the ABT program which allows refineries with an easy path to compliance with Tier 3 to reduce their gasoline sulfur to less than 10 ppm sulfur and generate and sell those credits to refineries, which are more challenged by Tier 3.

### 3. Can refiners meet the January 1, 2017 start date?

An adequate amount of lead time is required for the implementation of any rulemaking. Depending on the level of effort required to comply, more or less lead time is also required. In the case of Tier 3, refiners need time to select the technology and the vendor that will provide the technology needed for compliance with the fuels standard. Next, they need time to arrange an engineering and construction (E & C) contractor which will design and oversee the construction of the refinery unit and the time needed to obtain the necessary permits and procure the necessary hardware. Next, refiners need time to construct the unit. Finally, the refiner needs time to make the necessary unit tie-ins of the unit with the rest of the refinery and then startup the unit.

This section, along with detailed analysis provided in the RIA, explains that when taking into account the time

to revamp existing FCC posttreater units or build grassroots posttreater units, tie-in the new or revamped units with the rest of the refinery and considering the flexibility offered by the ABT program, refiners will be able to comply with the Tier 3 program within the lead time provided.

#### a. Time Required To Install Grassroots Units and Revamp Existing Units

The technologies for complying with Tier 3 are well known and well proven. Refiners which complied with Tier 2 using FCC naphtha desulfurization technologies installed the following units: Axens Prime G+, CDTech's CDHydro and CDHDS, UOP's ISAL Sinopec's S-Zorb and Exxon's Scanning. Refiners shopped around and chose among these various technologies which were largely untested at the time, which required us to provide more lead time for Tier 2. Since the Tier 2 sulfur standard began to be phased in, nine years have elapsed, and we believe that refiners now have direct experience with the installation and operation of these technologies and the vendor companies that license them and continue to support their installations onsite. We therefore believe that refiners will be able to reach a decision very quickly when complying with Tier 3, particularly, because in most cases the refiners will be revamping the units already installed for Tier 2 when complying with Tier 3.

Based on our conversations with refiners, construction companies, vendor companies and from published literature, we estimated the time it takes to revamp existing posttreater and install grassroots posttreater. To revamp an existing posttreater it is expected to require up to two years. Installing a grassroots posttreater is estimated to require three years. Figure A reflects these project completion times showing the various major intermediate steps for completing the projects.

<sup>475</sup> Hart Energy Consulting. (2011). International Fuel Quality Center: 2011 Worldwide Fuel Specifications

<sup>476</sup> Article from China.org.cn entitled "Beijing to implement stricter fuel standards", May 19, 2012, retrieved from [http://www.china.org.cn/environment/2012-05/19/content\\_25422404.htm](http://www.china.org.cn/environment/2012-05/19/content_25422404.htm)

**Figure V.L-1. Estimated Project Lead Time for Revamps and Grassroots Units**

		0-6	6-9	9-12	12-15	15-18	18-21	21-24	24-27	27-30	30-33	33-36
Revamp Pre- & Posttreaters	Scoping Studies	█										
	Process Design		█									
	Permitting			█								
	Detailed Engineering				█							
	Field Construction						█					
	Start-up / Shakedown							█				
Grassroots Posttreater	Scoping Studies	█										
	Process Design		█									
	Permitting			█								
	Detailed Engineering				█							
	Field Construction										█	
	Start-up / Shakedown											█

Since many of the Tier 3 revamps are expected to be very modest (e.g., change out a reboiler or heat exchanger), we believe that the revamping of posttreaters could take less time than what we estimate in Figure V.L-1. Following EPA held discussions with many refiners in 2011 about EPA’s plan to pursue additional sulfur control post-Tier 2 (Tier 3), refiners began the process of assessing how they would comply. The Tier 3 proposal was delayed for about a year and it is our understanding from recent discussions with vendor companies and some refiners that, during this time, many refiners began assessing how they intended to comply with Tier 3. Thus, many refiners likely have completed the scoping studies, which involves technology selection, and in the case of grassroots units, vendor selection as well (refiners with a particular posttreater technology in most cases are expected to simply revamp the same vendor’s technology, so there is no need to select a vendor). If refiners have already completed their scoping studies, we estimate that installation of the revamps or grassroots units would be about 3 months shorter than the 2 and 3 years, respectively, than we estimate in Figure V.L-1.

We believe that these project timelines are reasonable in light of past industry experiences which show FCC posttreaters being installed in refineries in less time than what we estimate. At the Motiva refinery in Port Arthur, TX, a grassroots CDTech posttreater was designed, constructed and started up in less than 2 years. At two refineries in Germany, two Prime G+ units were designed, constructed and started up—one of them in two years, and the other in 18 months. As an extreme example, the \$3.6 billion dollar, 180 kbbl/day crude oil expansion at Marathon’s Garyville, LA refinery was designed, constructed and started up in 4 years. This project involved construction of 10 major refinery units. Since these may be best case examples, we continue to believe the projections provided above in Figure V.L-1 are reasonable. In contrast, EPA received comments and feedback during meetings from the refining industry suggesting that many of the steps outlined in Figure V.L-1 could take considerably longer. For example, they stated that permits could take 2 years and procurement of vessels, pumps, compressors and heaters could take 2 years as well, extending the time needed to complete their projects. However, even if this may be true in

some situations, the examples above highlight that this is not true in all situations. Furthermore, most refineries, as discussed in section V.K. will not need to go through any extensive permitting process and as discussed below, not all refineries will need to undertake extensive revamps of existing units or installation of grassroots units. So once again, we believe the timeline shown is reasonable for the vast majority of refineries. Many can complete these actions faster. For those that may require a longer timeline, the program flexibilities discussed below allow for this within the lead time provided.

**b. Program Flexibility That Extends Lead Time**

As discussed in Section V.D, the final Tier 3 program includes an ABT program that significantly helps refiners comply with the January 1, 2017 start date. There are several provisions of the ABT program that help with respect to any leadtime constraints.

The ABT program allows for ongoing intra-company and inter-company trading nationwide. This will allow some refineries to over-comply with the 10 ppm gasoline sulfur standard (in our analysis, we modeled these refineries

bringing their gasoline down to 5 ppm), allowing other refineries that would otherwise need to install grassroots units to not invest and purchase credits instead. This aspect of the ABT program is very important because our analysis estimates that only one refinery would need to install a grassroots hydrotreater whereas without the ABT provisions, there could be as many as 20 grassroots units. This one aspect has huge implications for leadtime because as discussed in the previous subsection, revamps require two years or less whereas grassroots FCC posttreater units require approximately three years to install. We are convinced that this aspect of the ABT program will be utilized to the maximum extent possible because refineries revamping their posttreaters in lieu of installing grassroots posttreaters results in the most cost-effective mechanism for meeting the 10 ppm annual average standard.

An important issue to consider is that in order for refiners to opt not to invest in a grassroots unit they would have to trust that credits will be available to them. For the proposal, we conservatively assumed that refiners would only rely on credits if they could generate them internally. However, for the final rule analysis, we have assessed how the sulfur credits were being traded under Tier 2 and found that over half the sulfur credits were freely traded between companies (as opposed to only being used within companies), and many single-refinery companies had sulfur levels above 30 ppm (single-refinery companies must purchase credits from other companies). Because credits have a 5-year life, we also see in the Tier 2 data that refiners tend to sell credits rather than let them simply expire. Refiners may hold them as a contingency, but then sell them prior to their expiration. For example, in 2012, 40 percent of the credits traded were generated in 2007 and were set to expire at the end of 2012. This one quality of the Tier 2 program ensures the free access to credits. We designed the Tier 3 credit trading program to work just like the Tier 2 credit trading program, thus we are confident that there will be widespread trading within and between refining companies.

A second aspect of the ABT program that helps with leadtime is the provision for generating early sulfur credits and banking them for later use. As discussed in Section V.D above, this provision allows refineries to reduce their gasoline sulfur to less than 30 ppm prior to January 1, 2017 and bank the credits for later use. Based on comments that we received on the proposed rule, we are allowing Tier 2 credits which are

generated during the years 2012 and 2013 to also be used to show compliance for Tier 3. This effectively extends the early credit generation period for Tier 3 to encompass the years 2012 to 2016, which is 5 years. Analyzing the 2012 gasoline quality data that refiners reported to EPA, we found that gasoline sulfur levels in the U.S. averaged about 26.7 ppm. Thus, refiners have already begun overcomplying with Tier 2 by 3.3 ppm, and are therefore already generating early credits that can be used for Tier 3. If refiners do nothing more but continue to overcomply with Tier 2 by 3.3 ppm over the 5 years of early credit generation, refiners will have generated enough credits to delay the completion of their capital projects by roughly a year. Furthermore since those credits generated in 2012 and 2013 will expire in 2017 and 2018 respectively, refiners will have an incentive to either use them themselves or trade them in 2017 and 2018. Thus refiners that may need to count on them to delay their capital investment are likely to be able to have access to them.

When the extent of the flexibility afforded by the final ABT provisions is fully understood by refiners, we believe that refiners will generate a lot more early credits with their existing gasoline sulfur control units than the 3.3 ppm we observed in 2012. As we discussed in our cost analysis, to produce more diesel fuel in response to a greater demand for diesel fuel relative to gasoline, refiners are undercutting the swingcut portion of FCC naphtha at their refineries.<sup>477</sup> This action to shift what historically was blended into the gasoline pool to the diesel fuel pool, actually also dramatically reduces the sulfur content of the gasoline pool. If the entire swingcut portion of FCC naphtha is undercut to the diesel fuel pool, the amount of sulfur in the gasoline pool is reduced by about 50 percent. Our cost analysis estimates that at almost one quarter of U.S. refineries, refiners are fully undercutting the FCC naphtha to diesel fuel today. At many other refineries, refiners are only partially undercutting their FCC naphtha. These refineries will be able to reduce the sulfur of their gasoline well below their current levels and generate a large number of early credits for Tier 3. Even for the subset of refineries at which the FCC naphtha is not being undercut, refiners can assess how much activity or

catalyst life is left in its FCC posttreater catalyst and compare this time with the time to the next turnaround when the FCC posttreater catalyst is scheduled to be replaced. If there is spare catalyst life, the refiner could elect to “turn up” their posttreaters to reduce their gasoline sulfur levels to under 30 ppm. With this strategy, the refiner would generate early sulfur credits. Also, when the refiner replaces the catalyst in its Tier 2 posttreater, it can elect to do so with a more active catalyst which would allow the refinery to produce gasoline at sulfur levels below 30 ppm and generate more early credits for Tier 3.

Based on the early actions refiners are already taking, or could take, to reduce their gasoline sulfur levels, we believe that refiners would be able to reduce their gasoline sulfur to as low as 20 ppm, on average. By averaging 20 ppm for 2.5 years prior to 2017, refiners would be able to delay completion of all capital investments for Tier 3 until mid 2019. If we add the 3.3 ppm of credits during 2012, 2013 and first part of 2014, refiners would be able to delay completion of all capital investments in Tier 3 until 2020. Thus, the early credit provisions will, in-effect, provide nearly 6 years of leadtime for full compliance with the fuels program. This will allow ample time for refiners to complete their investment and schedule their tie-ins during normal shutdown activities. It effectively provides even more lead time than the 5 years that the refining industry requested in their comments. The delay in the program implementation will also help to distribute the demand on the E & C industry over more years ensuring that the E & C industry won't be overwhelmed.

We are also finalizing a compliance deadline of January 1, 2020 for small refiners and small volume refineries (i.e., refineries processing less than or equal to 75,000 net barrels per day of crude oil). This will provide approximately 36 of the 108 affected refineries with nearly 6 years of lead time; again more than the 5 years that the refining industry requested in their comments. We believe that these refineries and refineries are disproportionately impacted when it comes to their cost of compliance and ability to rationalize investment costs in today's gasoline market. Giving these refineries and refineries additional lead time provides more time to invest in desulfurization technology, take advantage of advancements in technology, develop confidence in a Tier 3 credit market as a means of compliance, and avoid competition for capital, engineering, and construction

<sup>477</sup> The term swingcut means that this portion of the FCC product pool can be blended into gasoline or diesel fuel while still meeting the fuel quality specifications for either fuel regardless of where this swingcut is blended.



resources with the larger refineries. Due to the January 1, 2020 compliance deadline for small refiners and small volume refineries we estimate that of the 64 refineries that will ultimately need to revamp (63) their existing hydrotreaters or add a grassroots hydrotreater (1) over the course of implementing the Tier 3 program 15 refineries could wait to take such actions until 2020. Further, as discussed in more detail in Section V.E.1, small refiners and small volume refineries can generate early credits (from January 1, 2017 through December 31, 2019) relative to 30 ppm for sale to other small refiners/small volume refineries, and relative to 10 ppm for sale to non-small refiners. This could provide another pool of early credits for Tier 3 prior to January 1, 2017 and ongoing credits during the years of 2017, 2018 and 2019.

Despite the flexibility afforded by the ABT program, some refiners have expressed concern that should they want or need to rely on credits for compliance, they may not be able to do so if they cannot be assured that they will be able to acquire the necessary credits from other parties when the time comes. This could force them into making relatively costly investments that they would otherwise be able to avoid. We recognize that this may be a concern, particularly prior to 2020 when the market will be in a state of transition. While we cannot guarantee credit availability, and we are confident that the program as designed provides ample opportunity for credit generation, we do believe that providing the market with at least some basic information on credit availability may provide some added assurance and aid in credit market liquidity. Consequently, we pledge to work with the refining industry on ways to make information on the sulfur credit market more transparent over the period leading up to 2020, balancing their need for information with the resource constraints of the Agency. In doing so, to protect confidentiality, we will not be able to identify individual company credit balances or deficits, but would intend to provide an aggregated level of information, such as total credit balances for each vintage year, on an annual basis leading up to 2020. Because industry has already shown the ability to identify and establish the necessary trading relationships under the Tier 2 program, we anticipate that they will be able to continue to do so under Tier 3.

In summary, we believe that the ABT program we are finalizing today provides ample flexibility for complying with Tier 3. The averaging provisions

will allow refiners that only need to revamp their Tier 2 posttreaters to generate credits by overcomplying with the 10 ppm standard, and in turn allow refineries that otherwise need to install grassroots units to comply solely through the purchase of credits. The banking provisions also allow refiners to generate early credits, effectively delaying investments for compliance to potentially as late as 2020. Finally, the small refiner and small refinery provisions delay compliance for approximately 36 refineries until 2020, as well as generate and trade early credits. We believe that all of these provisions effectively address any leadtime concerns. Furthermore, there are additional options available to refineries to avoid a noncompliance situation should all these program flexibilities prove insufficient. Refineries are permitted to carry a credit deficit for one year as long as they make it up the following year, and the final rule allows refiners to apply for hardship waivers if necessary. In addition, refineries with access to export markets can always choose to export fuel until such time as they can bring their desulfurization capacity online. There is a large and growing gasoline export market from the U.S. already. Such exports of higher sulfur gasoline could be offset through imports of compliant gasoline such as historically occurred from Europe, which has a 10 ppm sulfur cap on gasoline.

#### c. Impact of Turnaround Timing

We received numerous comments on the proposed January 1, 2017 compliance deadline. In their comments to the proposed Tier 3 rulemaking, the oil industry stated that EPA must consider and include the time it takes to tie-in the revamps and grassroots units in the proposed leadtime. The oil industry urged EPA increase the leadtime for Tier 3 to 5 years to allow for refiners to make their investments needed to comply with Tier 3 and tie-in those new investments. In today's action we are finalizing a compliance deadline of January 1, 2017. As previously explained above, various provisions of the ABT program effectively provide nearly 6 years of leadtime to complete capital projects. We also note that the capital projects do not have to be completed prior to installing the necessary tie-ins. We do agree, however, that the need to make tie-ins must be considered when assessing the feasibility of leadtime, and in doing so, our analysis shows that refiners can comply with Tier 3 within the leadtime provided. This is true not

only because the final rule effectively provides nearly 6 years of leadtime to complete capital projects, as described above, but also because the capital projects do not have to be completed prior to installing the necessary tie-ins.

When a refiner builds a grassroots unit or some sort of revamp which involves new reactor volume or perhaps by adding a splitter, this new capital must be "tied-in" to the rest of the refinery. The tie in usually involves connecting a pipe from the existing unit to the new capital installed for complying with Tier 3. However, a pipe cannot simply be added while the refinery is operating. Instead, the refiner will add the necessary pipe for making the tie-in when the refinery is shutdown for regular maintenance. The revamp or grassroots unit does not have to be started up at that time. Instead, the connection pipe just needs to be added and blocked off with a sealing-type valve and a blind flange (essentially a flat piece of steel) is bolted on as a precaution against a leaky valve. Once this piping has been added, the refiner can restart its refinery. Then when the refiner is ready to complete the tie-in to the completed Tier 3 revamp or grassroots unit, the refiner would remove the blind flange and connect a pipe which connects the existing part of the refinery to the newly installed grassroots posttreaters unit or revamp posttreaters subunit. This last step can either occur when the refinery is shutdown or still operating. At that point the refiner would only need to open the block valve to complete the tie-in of the grassroots unit or revamp to the existing refinery.

On its Web page, the American Petroleum Institute (API) reports that the average time between turnarounds is 4 years when the U.S. refineries perform maintenance on the FCC unit.<sup>478</sup> This means that on average, 25% of U.S. refineries shutdown to perform maintenance on its FCC units each year. Most often, refiners conduct maintenance turnarounds on their refineries during the spring when the demand for gasoline and diesel fuel is at their lowest. Thus, refiners will have the years of 2014, 2015 and 2016 to make their tie-ins during a regularly scheduled refinery turnaround to be able to comply by January 1, 2017, thus roughly three-quarters of the tie-ins could occur before the January 1, 2017

<sup>478</sup> Fact Sheet entitled "Refinery Turnarounds," American Petroleum Institute (API) Web page: <http://www.api.org/oil-and-natural-gas-overview/fuels-and-refining/refineries/refinery-turnarounds/>; downloaded June 21, 2013.

compliance date.<sup>479</sup> If we superimpose the tie-in issue with the types of investments we project will be made for Tier 3, we project that for three-quarters of the revamps, refiners will be able to make their tie-ins prior to the January 1, 2017 start date, while the other refineries will require until the spring of 2017 to make their tie-ins. As a worse-case scenario, if refiners don't even try to begin making their tie-ins until the spring of 2015, they would need the spring of 2015 to the spring of 2018 to complete their tie-ins.

However, regardless of whether we assume that tie-ins begin to occur in 2014 or 2015, the flexibility afforded by the ABT program will readily enable refiners to complete their capital investments and tie-ins and comply with Tier 3 within the lead time provided. A more detailed discussion and analysis of Tier 3 compliance considering unit construction time, the tie-ins of revamps and grassroots units and availability of credits is contained in Chapter 4 of the RIA.

d. Hardship

While we project that there will be plenty of credits available to allow refiners to complete their capital investments and tie in the new or revamped unit to the rest of their refinery, we are providing another option to refiners as a safety valve in case there is a shortfall of credits. Consistent with our proposal, today's rule contains provisions for a refiner to apply for a hardship waiver. Thus, where a refiner cannot complete its project by January 1, 2017 and credits are not available or are prohibitively

expensive, the refiner may file a hardship waiver. Details of our hardship provisions can be found in Section V.E.2.

e. Impact on the Engineering and Construction Industry

As in prior rules, we also evaluated the capability of E&C industries to design and build gasoline hydrotreaters as well as performing routine maintenance. Two areas where it is important to consider the impact of the fuel sulfur standards are: (1) Refiners' ability to procure design and construction services, and (2) refiners' ability to obtain the capital necessary for the construction of new equipment required to meet the new gasoline quality specification. We evaluated the requirement for engineering design and construction personnel in a manner consistent with the Tier 2 analysis, particularly for three types of workers needed to implement the refinery changes: front-end designers, detailed designers, and construction workers. We developed estimates of the maximum number of each of these types of workers needed throughout the design and construction process and compared those figures to the number of personnel currently employed in these areas.

The number of job hours necessary to design and build individual pieces of refinery equipment and the job hours per piece of equipment were taken from Moncrief and Ragsdale.<sup>480</sup> Their paper summarizes analyses performed in support of a National Petroleum Council study of gasoline desulfurization, as well as other potential fuel quality changes. The design and construction

factors for desulfurization equipment are summarized in Table V-1.

TABLE V-1—DESIGN AND CONSTRUCTION FACTORS

<i>Gasoline Refiners</i>	
Number of New Pieces of Equipment per Refinery .....	60
Number of Revamped Pieces of Equipment per Refinery .....	15
<i>Job Hours Per Piece of New Equipment<sup>a</sup></i>	
Front End Design .....	300
Detailed Design .....	1,200
Direct and Indirect Construction ...	9,150

<sup>a</sup> Revamped equipment estimated to require half as many hours per piece of equipment

Refinery projects will differ in complexity and scope. Even if all refiners desired to complete their project by the same date, their projects would inevitably begin over a range of months. Thus, two projects scheduled to start up at exactly the same time are not likely to proceed through each step of the design and construction process at the same time. Second, the design and construction industries will likely provide refiners with economic incentives to avoid temporary peaks in the demand for personnel.

Applying the above factors, we projected the maximum number of personnel needed in any given month for each type of job. The results are shown in Table V-2. In addition to total personnel required, the percentage of the U.S. workforce in these areas is also shown, assuming that half of all projects occur in the Gulf Coast.

TABLE V-2—MAXIMUM MONTHLY DEMAND FOR PERSONNEL

	Front-end design	Detailed engineering	Construction
<i>Tier 3 Gasoline Sulfur Program</i>			
Number of Workers .....	202	809	6,012
Percentage of Current Workforce <sup>a</sup> .....	11%	9%	4%

<sup>a</sup> Based on current employment in the U.S. Gulf Coast assuming half of all projects occur in the Gulf Coast

To meet the Tier 3 sulfur standards, refiners are expected to invest \$2.0 billion between 2014 and 2019 and utilize approximately 250 front-end design and engineering jobs and 1,500 construction jobs. The number of estimated jobs required is small relative

to overall number available in the U.S. job market. As such, we believe that three years, plus the additional flexibilities provided, is adequate lead time for refineries to obtain necessary permits, secure E&C resources, install new desulfurization equipment, and

make all necessary retrofits to meet the Tier 3 sulfur standards. For an in-depth assessment of stationary source implications, refer to Section V.K. For more on our E&C assessment, refer to Chapter 4 of the RIA.

<sup>479</sup> Since most refiners have already completed their scoping studies with the vendor companies which license the desulfurization technologies, they likely already understand what steps would need to be taken to tie-in their revamps and grassroots units with their existing refinery. For this reason, we

believe that refiners can begin making their tie-ins as soon as the spring of 2014, and perhaps even earlier than that. One refiner who owns a number of refineries shared with us that they prepared the tie-ins for Tier 3 when they installed their Tier 2 units.

<sup>480</sup> Moncrief, Philip & Ragsdale, Ralph. (2000). *Can the U.S. E&C Industry Meet the EPA's Low Sulfur Timetable?* Paper presented at NPRA Annual Meeting, March 26-28, 2000. Paper No. AM-00-57.

### M. Statutory Authority for Tier 3 Fuel Controls

Consistent with our proposal, we are adopting gasoline sulfur controls under our authority in section 211(c)(1) of the Clean Air Act. This section gives us the authority to “control or prohibit the manufacture, introduction into commerce, offering for sale, or sale” of any fuel or fuel additive for use in a motor vehicle, motor vehicle engine, or nonroad engine or nonroad vehicle (1) whose emission products, in the judgment of the Administrator, cause or contribute to air pollution which may reasonably be anticipated to endanger the public health or welfare [section 211(c)(1)(A)] or (2) whose emission products will impair to a significant degree the performance of any emission control device or system which is in general use, or which the Administrator finds has been developed to a point where in a reasonable time it would be in general use were the fuel control or prohibition adopted [section 211(c)(1)(B)]. Consistent with our proposal, we are finalizing controls on gasoline sulfur levels based on both of the Clean Air Act criteria, as described in more detail below.

#### 1. Section 211(c)(1)(A)

Under the first criterion, we believe that emission products of gasoline with current levels of sulfur contribute to ambient levels of ozone, particulate matter (PM), nitrogen dioxide (NO<sub>2</sub>), sulfur dioxide (SO<sub>2</sub>) and carbon monoxide (CO), which are all pollutants for which EPA has established National Ambient Air Quality Standards (NAAQS). These pollutants are linked with respiratory and/or cardiovascular problems and other adverse health impacts leading to increased medication use, hospital admissions, emergency department visits, and premature mortality. Approximately 149 million people currently live in counties exceeding a NAAQS.<sup>481</sup> Motor vehicles also emit air toxics, and the majority of Americans continue to be exposed to ambient concentrations of air toxics at levels which have the potential to cause adverse health effects, including cancer, immune system damage, and neurological, reproductive, developmental, respiratory, and other health problems.<sup>482</sup> A more detailed discussion of the health and

environmental effects of these pollutants is included in Section II.B. As discussed there, emissions of these pollutants cause or contribute to ambient levels of air pollution that are reasonably anticipated to endanger public health and welfare. Control of gasoline sulfur to 10 ppm will lead to significant reductions in emissions of these pollutants, with the benefits to public health and welfare significantly outweighing the costs.

EPA has evaluated the technical feasibility of achieving these sulfur levels, including the cost of the reductions. We have concluded that these reductions are feasible in the lead time provided. For more on the feasibility of the fuel standards, refer to Section V.L above and Chapter 4 of the RIA.

As discussed in Section III, and further supported by the discussion in Section IV.A.6, EPA also evaluated the emissions reductions from pre-Tier 3 vehicles that will be achieved by controlling gasoline sulfur level to 10 ppm on average. The 10 ppm sulfur standard will provide significant reductions in harmful emissions independent of the vehicle standards and these reductions are significant and contribute to the total monetized health benefits. Already in 2018, when the emission reductions are almost entirely due to the sulfur standards, the Tier 3 program will provide significant benefits. We continue to believe that the Tier 3 program will produce benefits to public health and welfare whose value significantly outweighs the costs. These reductions can be achieved in a manner that is technologically feasible. In sum, EPA concludes that the entire body of evidence strongly supports the view that controlling gasoline sulfur to 10 ppm is quite reasonable in light of the emissions reductions and benefits achieved, taking costs into consideration. For more detail on the costs and benefits of the Tier 3 program, refer to Chapter 5 of the RIA.

Section 211(c)(2)(A) requires that, prior to adopting a fuel control based on a finding that the fuel’s emission products contribute to air pollution that can reasonably be anticipated to endanger public health or welfare, EPA must consider “all relevant medical and scientific evidence available, including consideration of other technologically or economically feasible means of achieving emission standards under [section 202 of the Act].” EPA’s analysis of the medical and scientific evidence relating to the emissions impact from motor vehicle engines, which are impacted by gasoline sulfur, is described in more detail in Chapter 6 of

the RIA. EPA has also satisfied the statutory requirement to consider “other technologically or economically feasible means of achieving emission standards under section [202 of the Act].” This provision has been interpreted as requiring consideration of establishing emission standards under section 202 prior to establishing controls or prohibitions on fuels or fuel additives under section 211(c)(1)(A). See *Ethyl Corp. v. EPA*, 541 F.2d. 1, 31–32 (D.C. Cir. 1976). In *Ethyl*, the court stated that section 211(c)(2)(A) calls for good faith consideration of the evidence and options, not for mandatory deference to regulation under section 202 compared to fuel controls. *Id.* at 32, n.66. EPA is also adopting Tier 3 emissions standards for motor vehicles under section 202. These standards could not achieve any emission reductions for vehicles already in use, while reducing fuel sulfur will achieve large emission reductions for vehicles already in use. For new vehicles, the use of 10 ppm average sulfur fuel is an essential part of achieving Tier 3 levels while applying an array of advancements in emissions control technology to the light-duty fleet. As shown in Section IV.A, we believe that achieving the Tier 3 exhaust emission standards will require technological improvements such as very careful control of the exhaust chemistry and exhaust temperatures to ensure high catalyst efficiency. These technology improvements, which are described in greater detail in the RIA (Chapter 1)—improving warm-up and catalyst light-off after cold starts and maintaining very high catalyst efficiency—all rely on 10 ppm sulfur average fuel to achieve the very significant emissions reductions required for the fleet to achieve Tier 3 emissions levels.

Achieving Tier 3 emissions standards without a reduction in sulfur to 10 ppm levels would only be possible if there were technology improvements significantly above and beyond even those mentioned above. EPA cannot identify technology improvements that could provide such a large additional increase in emissions control effectiveness, across the fleet, above and beyond that provided by the major improvements in technology discussed above, without any additional gasoline sulfur control. As discussed in Section IV.A.3, the Tier 3 fleet average exhaust emissions standards of 30 mg/mi NMOG+NO<sub>x</sub> will require large reductions of emissions across a broad range of light-duty vehicles and trucks with differing degrees of utility. Specifically, achieving Tier 3 emissions

<sup>481</sup> Data come from Summary Nonattainment Area Population Exposure Report, current as of July 20, 2012 at: <http://www.epa.gov/oar/oaqps/greenbk/popexp.html> and contained in Docket EPA–HQ–OAR–2011–0135.

<sup>482</sup> U.S. EPA. (2011) Summary of Results for the 2005 National-Scale Assessment. [www.epa.gov/ttn/atw/nata2005/05pdf/sum\\_results.pdf](http://www.epa.gov/ttn/atw/nata2005/05pdf/sum_results.pdf).

standards as an average across the fleet will require fleet wide reductions of approximately 80%. We believe this means significant reductions from all sectors, with the result that there is a need for major reductions from all types of vehicles in the light-duty fleet, including those above as well as most vehicles that are already near, at, or below the Tier 3 Bin 30 fleet average standard.

Achieving these reductions presents a major technology challenge and EPA is not aware of technology improvements that could provide such large additional increases in emissions control effectiveness, across the fleet, above and beyond that provided by the major improvements in control technologies expected for use in meeting today's Tier 3 standards. Rather, as available test data indicates, in addition to lower gasoline sulfur levels, the required reductions are of a magnitude that EPA expects manufacturers to employ advances in technology in all of the relevant areas of emissions control—exhaust catalyst technologies, (such as reducing the time to catalyst light off, improving exhaust catalyst durability at 120,000 or 150,000 miles and improving efficiency of fully warmed up exhaust catalysts), reducing engine out emissions, power train calibration primarily focused on reducing cold-start NMOG emissions, and on reducing both cold-start and warmed-up (running) NO<sub>x</sub> emissions.

The impact of sulfur reduction on the effectiveness of the available technology improvements plays such a large role in achieving the Tier 3 emissions standards that it is clearly unrealistic to expect that technology would be available, at the 30 ppm sulfur standard, to fill the emission control gap left from no sulfur reduction, and still achieve the very significant fleet wide reductions needed to meet the Tier 3 fleet average. In effect reducing sulfur from 30 ppm to 10 ppm has such a large impact on the ability of the technology improvements to achieve Tier 3 emissions levels that absent these sulfur reductions there is not a suite of technology advancements available to fill the resulting gap in emissions reductions. As also discussed in Section IV.A.6, testing of Tier 2 and Tier 3 type vehicles, as well as other information, shows that sulfur has a very large impact on the effectiveness of the control technologies expected to be used in Tier 3 vehicles. Without the reduction in sulfur to a 10 ppm average, the major technology improvements projected under Tier 3 would only result in a limited portion of the emissions reductions needed to achieve

Tier 3 levels. For example, without the reduction in sulfur from a 30 ppm to 10 ppm average, the technology improvements would not come close to achieving Tier 3 levels. In some cases this may result in the same effectiveness as the current Tier 2 technology and achieve only approximately Tier 2 levels of exhaust emissions control.

As earlier explained, EPA has not identified technology that would achieve the average Tier 3 emissions standards, across the fleet, with sulfur at 30 ppm levels, and as a result Tier 3 emissions standards would not be technically feasible and achievable. This is also the case for levels in-between 30 and 10 ppm, e.g., 20 ppm. The required emissions reductions are so large and widespread across the fleet, and the technology challenges are high enough, especially for heavier vehicles, that the large increase in emissions that would occur even from a higher average sulfur level compared to 10 ppm average would lead to an inability for the technology to widely achieve the Tier 3 fleet wide average emissions standards.

Further, as also explained in Section IV.A.6, larger vehicles (the largest LDVs and LDT3s, LDT4s and MDPVs) will have greater difficulty achieving cold-start NMOG emissions control as a result of today's emissions standards. (Certifying to a useful life of 150,000 miles versus the current 120,000 miles will further add to manufacturers' compliance challenge for large light trucks; see Section IV.A.7.c for the useful life requirements.) This is based in part on the impact on NMOG emissions of the larger engine surface-to-volume ratio and resultant heat conduction from the combustion chamber during warm-up. There are also tradeoffs between some cold-start NMOG controls and cold-start NO<sub>x</sub> control. For example, secondary air injection and/or leaner fueling strategies improve catalyst light-off for NMOG after a cold-start but also place OSC components in an oxidation state that limits potential for NO<sub>x</sub> reduction and thus often result in higher cold-start NO<sub>x</sub> emissions. Some applications achieve lower NMOG+NO<sub>x</sub> emissions without the use of secondary air injection by careful calibration, changes to the catalyst formulation and balancing of catalyst HC and NO<sub>x</sub> activity. The EPA Prototype Silverado and the developmental Ford Explorer discussed in Section IV.A.6.c are specific examples of this approach. Thus, as a result of today's emissions standards these larger vehicles, in addition to needing to reduce NO<sub>x</sub> emissions to near-zero levels (as is generally the case for all Tier 3 vehicles,

as discussed below), these trucks may also have additional NMOG reduction challenge.

## 2. Section 211(c)(1)(B)

Under the second criterion, we believe that sulfur in gasoline will significantly impair the emission-control systems expected to be in general use in motor vehicle engines designed to meet the Tier 3 emission standards. The Tier 3 fuel sulfur standards will restrict gasoline sulfur content to an annual average of 10 ppm beginning in 2017, to enable compliance with new emission standards based on the use of advanced emission control technology that will be available to Tier 3 vehicles.

Section IV describes the substantial adverse effect of high gasoline sulfur levels on the emission-control devices or systems for vehicles and engines meeting the Tier 3 emission standards. As discussed in Section IV.A.6, sulfur in gasoline inhibits the emissions control performance of modern three-way exhaust catalyst systems by selectively binding with, and in some instances reacting with active sites and coating materials. The amount of sulfur retained by the catalyst is primarily a function of its operating temperature, the active materials and coatings used within the catalyst, the concentration of sulfur oxides in the incoming exhaust gases, and air-to-fuel ratio feedback and control by the engine management system. In addition to its interaction with catalyst materials, sulfur can also react with the wash-coating itself to form alumina sulfate, which in turn can block coating pores and reduce gaseous diffusion to active materials below the coating surface. Sulfur also interferes with the ability of OSC components to reduce NO<sub>x</sub> emissions. Water-gas-shift reactions, which are also important for NO<sub>x</sub> reduction over catalysts combining Pd and ceria, can be blocked by sulfur poisoning and may be responsible for observations of reduced NO<sub>x</sub> activity over Pd/ceria catalysts even with exposure to fairly low levels of sulfur (equivalent to 15 ppm in gasoline).

Operating the catalyst at a sufficiently high temperature under net reducing conditions (e.g., air-to-fuel equivalence that is net fuel-rich of stoichiometry) can effectively release the sulfur oxides from the catalyst components. Thus, regular operation at sufficiently high temperatures at rich air-to-fuel ratios can minimize the effects of fuel sulfur levels on catalyst active materials and catalyst efficiency. As discussed in Section IV.A.6, however, it cannot completely eliminate the effects of sulfur poisoning. In current vehicles,

desulfurization conditions occur typically at high loads when there is a degree of commanded enrichment (i.e., fuel enrichment commanded by the engine management system primarily for protection of engine and/or exhaust system components). A study of Tier 2 vehicles in the in-use fleet recently completed by EPA shows that emission levels immediately following high speed/load operation is still a function of fuel sulfur level, suggesting that lower gasoline sulfur levels will bring emission benefits unachievable by catalyst desulfurization procedures alone.<sup>483</sup> For example, if a vehicle operates on gasoline with less than 10 ppm sulfur, exhaust emissions stabilize over repeat FTP tests at emissions near those of the first FTP that follows the high speed/load operation and catalyst desulfurization. Continued operation on gasoline with 10 ppm average sulfur content or lower is necessary after catalyst desulfurization in order to achieve emissions reductions with the current in-use fleet.<sup>484</sup> As also discussed in Section IV.A.6, the emission effects study performed by SGS also suggests that negative effects of exposure to a somewhat higher sulfur level (80 ppm in this case) are largely reversible for Tier 2 vehicles, and thus, suggests that reducing fuel sulfur levels nationwide will bring significant immediate benefits by reducing emissions of the existing fleet. Finally, to the extent such conditions do not occur today as part of normal driving for vehicles in the in-use fleet, there is no practical way to modify such existing vehicles to do so. Thus, reducing fuel sulfur levels has been the primary regulatory mechanism to minimize sulfur contamination of the catalyst and ensure optimum emissions performance over the useful life of a vehicle and is the only effective means for the in-use fleet.

For Tier 3 vehicles, there are several reasons why regular operation at the high exhaust temperatures and rich air-to-fuel ratios necessary for catalyst desulfurization is not desirable and may not be possible. The temperatures necessary to release sulfur oxides are high enough to lead to thermal degradation of the catalyst over time through thermal sintering of active materials. Sintering reduces the surface area available to participate in reactions. Additionally, it is not always possible to maintain these catalyst temperatures (because of cold weather, idle

conditions, light load operation). Also, the rich air-to-fuel ratios necessary for sulfur removal can result in increased PM, NMOG and CO emissions.

The impact of gasoline sulfur has become even more important as vehicle emission standards have become more stringent. Some studies have suggested an increase in catalyst sensitivity to sulfur when standards increase in stringency and emissions levels decrease.<sup>485 486</sup> Emission standards under the programs that preceded the Tier 2 program (Tier 0, Tier 1 and National LEV, or NLEV) were high enough that the impact of sulfur was considered negligible. The Tier 2 program recognized the importance of sulfur and reduced the sulfur levels in the fuel from around 300 ppm to 30 ppm in conjunction with the new emission standards. At that time, very little work had been done to evaluate the effect of further reductions in fuel sulfur—especially on in-use vehicles that may have some degree of catalyst deterioration due to real-world operation. As also shown in Section IV.A.6, there are currently available data from various studies and testing on Tier 2 vehicles that indicate that emissions performance is sensitive to sulfur levels in gasoline. Specifically, the MSAT studies of Tier 2 vehicles showed the emission reduction potential of lower sulfur fuel on Tier 2 and later technology vehicles over the FTP cycle. For instance, there was a 48 percent increase in NO<sub>x</sub> over the FTP when gasoline sulfur was increased from 6 ppm to 32 ppm. Further, emissions data from testing conducted by EPA on a representative subset of vehicles (after clean-out procedures) on 28 ppm and 5 ppm fuel with accumulated mileage, showed Bag 2 NO<sub>x</sub> emissions were 47 percent lower on the 5 ppm fuel as compared to 28 ppm fuel. The reductions found in these studies are also consistent with the MSAT and Umicore studies on Tier 2 vehicles in terms of the magnitude of NO<sub>x</sub> and HC reductions when switching from 28 ppm to 5 ppm fuel. The results of the emission effects study performed by SGS and included with API's comments on the Tier 3 proposal are also consistent with the findings of EPA's Tier 2 in-use study, namely that emissions performance is sensitive to fuel sulfur level. In sum, these studies

confirm our view that reducing sulfur levels in gasoline from current levels to levels in the range of today's final gasoline sulfur standards will be expected to achieve significant reductions in emissions of NO<sub>x</sub>, hydrocarbons, and other pollutants of interest from the in-use fleet.

The importance of lower sulfur gasoline is also demonstrated by the fact that vehicles certified to California SULEV typically certify to higher bins for the federal Tier 2 program. Light-duty vehicles certified to SULEV under LEV II are more typically certified federally to Tier 2 Bin 3, Bin 4 or Bin 5. In particular, non-hybrid vehicles certified to California SULEV are not certified to federal Tier 2 Bin 2 emissions standards even though the numeric limits for NO<sub>x</sub> and NMOG are shared between the California LEV II and federal Tier 2 programs for SULEV and Bin 2. Confidential business information shared by the auto companies indicate that the primary reason is an inability to demonstrate compliance with SULEV/Bin 2 emission standards after vehicles have operated in-use on gasoline with greater than 10 ppm sulfur and with exposure to the higher sulfur gasoline sold nationwide. While vehicles certified to the SULEV and Tier 2 Bin 2 standards both demonstrate compliance using certification gasoline with 15–40 ppm sulfur content, in-use compliance of SULEV vehicles in California occurs after significant, sustained operation on gasoline with an average of 10 ppm sulfur and a maximum cap of 20 ppm sulfur while federally certified vehicles operate on gasoline with an average of 30 ppm sulfur and a maximum cap of 80 ppm sulfur. Although the SULEV and Tier 2 Bin 2 standards are numerically equivalent, the increased sulfur exposure of in-use vehicles certified under the federal Tier 2 program results in a need for a higher emissions compliance margin to take into account the impact of in-use gasoline sulfur on full useful life vehicle emissions.

As further discussed in Section IV.A.6.d, available studies and testing also confirm that there is significantly increased sensitivity of exhaust emissions to gasoline sulfur by vehicles with exhaust emission control technologies that we expect to be used with vehicles complying with today's Tier 3 emissions studies. Specifically, available test data from the Ford Motor Company developmental heavy-light-duty truck and the Umicore Autocat 2009 Chevrolet Malibu PZEV show more increases in NO<sub>x</sub> and NMOG+NO<sub>x</sub> emissions with increased gasoline sulfur

<sup>483</sup> The Effects of Ultra-Low Sulfur Gasoline on Emissions from Tier 2 Vehicles in the In-Use Fleet, EPA-420-R-14-002.

<sup>484</sup> See Preamble Section IV.A.6.c and Chapter 1 of the RIA (Section 1.2.3.2) for more details on this study and its results.

<sup>485</sup> Takei, Y., Kungasa, Y., Okada, M., Tanaka, T., Fujimoto, Y. (2000). Fuel Property Requirement for Advanced Technology Engines. SAE Technical Paper 2000-01-2019.

<sup>486</sup> Ball, D., Clark, D., Moser, D. (2011). Effects of Fuel Sulfur on FTP NO<sub>x</sub> Emissions from a PZEV 4 Cylinder Application. SAE Technical Paper 2011-01-0300.

than was observed for Tier 2 vehicles. Similarly, test data from the EPA Tier 3 prototype 2012 Chevrolet Silverado heavy-light duty pickup also showed increased NMOG+NO<sub>x</sub> emissions and one exceedance of today's final Bin 30 exhaust emissions standards. In sum, available test data indicate that increasing gasoline sulfur levels from 10 ppm to 30 ppm on vehicles meeting Tier 3 standards essentially negated the entire benefit of the advances in emissions control technology that were applied to meet Tier 3 developmental goals. Because of the resulting need to reach near-zero NO<sub>x</sub> levels to offset NMOG emissions, any significant degradation in NO<sub>x</sub> emissions control over the useful life of the vehicle will likely prevent some if not most larger vehicles from reaching a combined NMOG+NO<sub>x</sub> level low enough to comply with the 30 mg/mi fleet-average standard. Any degradation in catalyst performance due to gasoline sulfur will also reduce or eliminate the margin necessary to ensure in-use compliance with the Tier 3 emissions standards. Thus, the impact of gasoline sulfur poisoning on exhaust catalyst performance and the relative stringency of the Tier 3 exhaust emissions standards, particularly for larger vehicles and trucks, when considered together make a compelling argument for the virtual elimination of sulfur from gasoline.

As discussed in Section V.B, the average 10 ppm gasoline sulfur standard is feasible and is the level that appropriately balances costs with the emission reductions that it provides and enables. Not only will a 10 ppm sulfur standard enable vehicle manufacturers to certify their entire product line of vehicles to the Tier 3 fleet average standards, but reducing gasoline sulfur to 10 ppm will better enable these vehicles to maintain their emission performance in-use over their full useful life. Higher sulfur levels would make it impossible for vehicle manufacturers to meet the Tier 3 standards, and would forego the very large immediate reductions from the existing fleet. Reducing the sulfur level below 10 ppm would further reduce vehicle emissions and allow the Tier 3 vehicle standards to be achieved more easily. However, we believe that a 10 ppm average standard is sufficient to allow vehicles to meet the Tier 3 standards. Further, as discussed in Sections V.B and IX.B there are significant challenges associated with reducing sulfur below 10 ppm.

### 3. Section 211(c)(2)(B)

Section 211(c)(2)(B) requires that, prior to adopting a fuel control based on a significant impairment to vehicle emission-control systems, EPA consider available scientific and economic data, including a cost benefit analysis comparing emission-control devices or systems which are or will be in general use that require the proposed fuel control with such devices or systems which are or will be in general use that do not require the proposed fuel control. As described above and in the RIA (Chapter 1), we conclude that the emissions control technology expected to be used to meet Tier 3 standards would be significantly impaired by operation on gasoline with annual average sulfur levels greater than 10 ppm. Our analysis of the available scientific and economic data can be found below in Section VII. The RIA includes a detailed analysis of the environmental benefits of the emission standards (Chapters 6 and 8), an analysis of the technological feasibility and cost of controlling sulfur to the levels established in the final rule (Chapters 4 and 5), and a cost analysis of the sulfur control and motor vehicle and engine emission standards (Chapter 9). Under section 211(c)(2)(B), as just noted, EPA is also required to compare the costs and benefits of achieving emission standards through emission-control systems that would not be sulfur-sensitive, if any such systems are or will be in general use. We have determined that there are not (and will not be in the foreseeable future) emission control devices available for general use in motor vehicles that can meet the emission standards and would not be significantly impaired by gasoline with current gasoline sulfur levels. Emissions cannot be reduced anywhere near the magnitude contemplated by the emission standards without the application of the kind of emissions control technology discussed in this final rule.

### 4. Section 211(c)(2)(C)

Section 211(c)(2)(C) of the Clean Air Act requires that prior to prohibiting a fuel or fuel additive, EPA establish that such prohibition will not cause the use of another fuel or fuel additive "which will produce emissions which endanger the public health or welfare to the same or greater degree" than the prohibited fuel or additive. This finding is required by the Act only prior to prohibiting a fuel or additive, not prior to controlling a fuel or additive. Since EPA is not prohibiting use of gasoline sulfur, but rather is controlling the level of sulfur

in these fuels, this finding is not required for this rulemaking. However, EPA does not believe that the gasoline sulfur controls will result in the use of any other fuel or additive that will produce emissions that will endanger public health or welfare to the same or greater degree as the emissions produced by gasoline with current sulfur levels. Unlike the case of unleaded gasoline in the past, where lead performed a primary function by providing the necessary octane for the vehicles to function properly, sulfur does not serve any useful function in gasoline. It is not added to gasoline, but occurs naturally in the crude oil into which gasoline is processed. Were it not for the expense of sulfur removal, it would likely have been removed from gasoline years ago in order to improve the maintenance and durability characteristics of motor vehicle engines.

We are also adopting the various controls for DFE, other oxygenates, butane and pentane blended into gasoline, and gasoline additives, under our authority in section 211(c)(1). As explained above, these controls are necessary to prevent emissions products that may endanger the public health or welfare or impair to a significant degree the performance of any emission control device or system. This action basically extends various controls on gasoline to DFE, other oxygenates, butane, and gasoline additives. The reasons for adopting the controls for gasoline apply as well to adopt the controls for DFE, other oxygenates, butane, and gasoline additives.

## VI. Technical Amendments and Regulatory Streamlining

In addition to adopting new Tier 3 vehicle standards and new gasoline sulfur standards, we are also finalizing a range of technical amendments and regulatory streamlining actions as part of the Regulatory Review initiative. Some of these may have some bearing on implementation of the Tier 3 vehicle and fuel standards, while others deal with other aspects of EPA's existing fuel and vehicle regulations.

EPA is also synchronizing several different reporting deadlines under various regulations affecting transportation and motor vehicle fuels and fuel additives. This action will reduce regulatory burdens by aligning reporting deadlines across several programs and lays the foundation for the overall goal of combining various fuels reports together into a single, simplified electronic format in the near future.

A. Fuel Program Amendments

The following sections discuss the changes being finalized today to the fuels regulations in 40 CFR parts 79 and 80. Some of these changes are technical amendments to correct minor errors or inconsistencies in the regulations; others are to address areas in the regulations that needed clarification and/or streamlining; still others are to provide additional flexibility.

With regard to regulatory streamlining, the majority of these items involve providing additional clarity, removing or updating outdated provisions, and decreasing the frequency and/or volume of reporting burden where data are either no longer needed or are redundant in light of other EPA fuels programs. In general, we believe that these changes are straightforward and will reduce burden on industry with no expected environmental impact.

We are also finalizing regulations to adopt a performance-based measurement systems approach to fuel parameter testing as discussed in Section VI.A.2, to expand the downstream butane blending provisions to allow for pentane blending as discussed in Section VI.A.3, and to accept Top Tier test data under the gasoline deposit control program as discussed in Section VI.A.4. We may undertake additional regulatory streamlining in a future action following additional stakeholder interactions, as discussed in Section VI.A.5.

Below is a table listing the provisions that we are amending in today's action. We have provided additional explanation for those amendments that warrant additional explanation in the following sections.

TABLE VI-1—SUMMARY OF REGULATORY STREAMLINING AND TECHNICAL AMENDMENTS

Section	Description
Varied	Various sections amended to update references to test methods (see Section VI.A.1.a.iii).
79.5	Revised periodic reporting requirements.
80.2	Revised and added definitions.
80.8	Amended to update sampling test methods, and to state to which fuels § 80.8 applies.
80.46	Revised measurement of RFG fuel parameters.
80.47	Added Performance-Based Test Method Approach.

TABLE VI-1—SUMMARY OF REGULATORY STREAMLINING AND TECHNICAL AMENDMENTS—Continued

Section	Description
80.65	Amended to reduce complex model test parameters and reporting and to accommodate RVP adjustment when blender grade pentane is blended into gasoline downstream of the refinery.
80.65(f)(5)	Added to allow for designation of an alternative lab.
80.66(f)	Amended to delete references to appendices that no longer exist.
80.74	Amended to reflect the recordkeeping requirements for entities in the blender grade pentane distribution system.
80.75	Revised RFG reporting requirements. Added reporting requirements for producers and importers of blender grade pentane.
80.77	Amended to reflect the product transfer document requirements for entities in the distribution system for blender grade pentane.
80.80	Amended to reflect the potential penalties requirements for entities in the distribution system for blender grade pentane.
80.82	Amended to apply butane blending provisions to entire part 80 and to revise RVP test method.
80.85	Added the requirements for downstream pentane blending.
80.86	Added the requirements for producers and importers of blender grade pentane.
80.87	Added the controls and prohibitions for entities in the blender grade pentane distribution system.
80.101	Revised measurement of conventional gasoline fuel parameters.
80.105	Amended to require identification of test methods used in refiner reports, and to add reporting requirements for butane blenders.
80.161(b)(1)(ii)(A)(2).	Amended to specify the requirements for certification of an additive under the new alternative gasoline deposit control certification option.
80.161(b)(1)(ii)(A)(3).	Added to specify the requirements for certification of an additive under all gasoline deposit control options other than the alternative certification option.

TABLE VI-1—SUMMARY OF REGULATORY STREAMLINING AND TECHNICAL AMENDMENTS—Continued

Section	Description
80.161(b)(2)	Amended to address the submission of gasoline deposit control additive samples under the alternative gasoline detergent certification option.
80.161(b)(3)(ii)(C).	Amended to reflect that documentation of the fuel injector deposit demonstration test will be required under the alternative gasoline deposit control certification option.
80.161(b)(3)(v).	Amended to state that the results of the intake valve and fuel injector deposit demonstration test must be submitted to EPA as part of the certification letter under the alternative gasoline deposit control certification option.
80.161(b)(3)(viii).	Amended to change "PFID test" to "fuel injector test".
80.161(d)(1)	Amended to reflect the availability of the alternative gasoline deposit control certification option.
80.163(a)(1)(iii).	Amended to specify that gasoline deposit control additives may be certified under the new alternative certification option.
80.164(a)	Amended to reference the test fuel requirements under the alternative gasoline deposit control certification option.
80.165	Amended to accommodate the alternative deposit control test procedures and standards under the alternative gasoline deposit control certification option.
80.167(a)	Amended to specify how confirmatory testing will be conducted for additives certified under the alternative gasoline deposit control certification option.
80.176	Added to specify the certification test procedures and standards under the alternative gasoline deposit control certification option.
80.177	Added to specify the certification test fuels under the alternative gasoline deposit control certification option.
80.178	Added to incorporate standards and test methods by reference.
80.330	Revised sampling and testing requirements.
80.340	Amended to add standards for gasoline produced by blending pentane into previously certified gasoline.



TABLE VI-1—SUMMARY OF REGULATORY STREAMLINING AND TECHNICAL AMENDMENTS—Continued

Section	Description
80.370 .....	Amended to require identification of test method used and revises reporting requirements.
80.511 .....	Revised per-gallon and marker requirements.
80.572 .....	Revised labeling requirements. Amended to remove the requirement for 15 ppm highway diesel fuel pump labels beginning November 30, 2014, and to amend the title to reflect that the section includes labeling requirements for dispensers of motor vehicle diesel fuel.
80.573 .....	Revised labeling requirements.
80.574 .....	Revised labeling requirements.
80.580 .....	Incorporated test methods by reference.
80.584(b)(3)(i)	Amended to correct typographical error (“notc” to “not”).
80.585 .....	Revised test method approval process.
80.604 .....	Revised reporting requirements.
80.1235(a)(6)	Amended to allow refiners and importers who are blending blendstock into previously certified gasoline (PCG) an alternative to directly test the blendstock for benzene.
80.1235(a)(5)	Amended to clarify that refiners and importers may use either approach for blendstocks that are blended into either conventional gasoline or reformulated gasoline.
80.1235(b)(2)	Amended to clarify EPA’s intent (per § 80.1238(b)) to allow refiners and importers to include oxygenate blended downstream of a refinery or import facility in their annual average benzene calculation, and to make the section consistent with § 80.1238(b).
80.1238 .....	Revised benzene determination.
80.1347(a)(5)	Amended to require that a negative annual average must be reported as zero, and that a refiner must comply with § 80.65(i) when producing RBOB or RFG and § 80.101(g)(9) when producing conventional gasoline.

TABLE VI-1—SUMMARY OF REGULATORY STREAMLINING AND TECHNICAL AMENDMENTS—Continued

Section	Description
80.1347(a)(6)	Added to allow refiners and importers who are blending blendstock into previously certified gasoline (PCG) an alternative to directly test the blendstock for benzene.
80.1348 .....	Revised sample retention requirements.
80.1349 .....	Added to allow importers who import gasoline into the U.S. by truck to use the sampling and testing requirements in 40 CFR part 80 subpart E as an alternative to the sampling and testing requirements in subpart L.
80.1354 .....	Revised reporting requirements for gasoline benzene program.
80.1407 .....	Amended to reflect that pentane blenders incur a renewable volume obligation (RVO) for the blender grade pentane they add to previously certified gasoline (PCG).
80.1451 .....	Revised RFS reporting requirements.
80.1640(d) .....	Added to allow refiners who blend only blender-grade pentane into PCG to meet the sampling and testing requirements for sulfur by using sulfur test results pursuant to § 80.85.

1. Fuels Program Regulatory Streamlining  
a. Amendments Related to Reduction of Testing and Reporting of Complex Model Gasoline Parameters

In §§ 80.65 and 80.75, we are streamlining and reducing the reformulated gasoline (RFG) and conventional gasoline (CG) testing and reporting burden of gasoline refiners and importers by reducing the testing and reporting requirements of certain fuel parameters associated with the complex model. Currently, for RFG, every batch must be tested for every parameter listed in § 80.65. No monthly compositing of batch samples is allowed for any parameter. For CG, monthly compositing and batch reporting based on those monthly composites is allowed for all parameters except sulfur and benzene. With the phasing out of complex model standards<sup>487</sup>, reduced

<sup>487</sup> Per § 80.41(e) and (f), and § 80.101(c), applicable NO<sub>x</sub> and toxics emissions requirements are superseded by the Tier 2 gasoline sulfur

testing and reporting is appropriate, particularly for RFG. In cases where a refiner is subject to only benzene, RVP, and sulfur standards, certain parameters no longer need to be tested and reported on an every-batch basis. However, the full slate of complex model parameters will still be needed in some cases. Specifically, refiners producing RFG during the summer volatile organic compound (VOC) control season will still need to use the complex model to determine VOC performance, and thus must still measure and report the relevant complex model fuel parameters. In addition, small refiners that are subject to the delayed compliance option for the 0.62 volume percent benzene standard will have to use the complex model (and thus measure all complex model parameters) until 2015 for CG MSAT1 compliance.<sup>488</sup>

Currently, there are 17 complex model parameters on the RFG/anti-dumping batch report. We are reducing testing and reporting requirements for some of these parameters for RFG, CG or both. For both RFG and CG, we are eliminating testing and reporting of American Petroleum Institute (API) gravity. In addition, we are finalizing that oxygenates need not be reported unless the refiner’s gasoline includes oxygenates or the refiner is including downstream added oxygenate in its compliance calculations. Apart from being necessary for use in the complex model, these parameters have little use for program compliance. Commenters agreed with the elimination of testing of API gravity and oxygenates.

For winter RFG, we are eliminating the requirement to test and report aromatics, distillations and olefins on an every batch basis and instead will allow testing and reporting of monthly composites. Commenters from the refining industry strongly suggested that we eliminate testing of these parameters altogether, since they are not needed, and their elimination would further reduce the burden on regulated parties. While we agree that a reduction in burden would occur if refiners were not required to test, even on a monthly composite basis, for these parameters, the many interconnected aspects of the RFG program make any seemingly innocuous change potentially fraught with unintended consequences. Thus, we are deferring the consideration of any action to completely eliminate the testing of these parameters to any future

standards and MSAT2 benzene standards, respectively.

<sup>488</sup> 61 FR 17230 (March 29, 2001).

fuel program restructuring, as discussed in Section VI.A.5.

Sulfur and benzene will continue to be tested and reported on an every batch basis as these values are necessary for the Tier 2 and Tier 3 gasoline sulfur and MSAT2 benzene programs. All summer complex model parameters will still be required to be tested and reported on an every batch basis because of the summer VOC requirement for RFG. For CG, only benzene, sulfur, and any oxygenates that are actually included in the gasoline batch must be tested and reported on an every-batch basis (except for refiners that are still subject to a complex model toxics standard; they must test all parameters but may use monthly composite testing and reporting except for sulfur and benzene, and oxygenate, where applicable). In the proposal, we stated “. . . values for aromatics, olefins, and distillation terms may continue to be determined from monthly composites.” Some commenters thought the term “may” in that sentence meant that reporting on those parameters at all is optional. That is an incorrect interpretation. In this final rule, we are finalizing requirements for use of either monthly composites or batch testing. The parameters must still be measured and reported. Commenters in the refining industry do not think these parameters need to be measured at all for parties subject to the MSAT2 benzene standard, as compliance with that standard is not dependent on aromatic, olefin, or distillation values. As mentioned earlier, there are several areas of the RFG and/or anti-dumping programs where testing and reporting burden could likely be reduced; however, we have not fully evaluated the implications of changing the current requirements, and thus we are leaving consideration of such changes to the broader program restructuring discussed in Section VI.A.5. Nonetheless, the changes that are finalized today will substantially reduce the testing and reporting burden on regulated parties.

#### b. Amendments Related to Reporting Dates

EPA is amending various provisions in 40 CFR parts 79 and 80 to reduce the number of different reporting deadlines that regulated parties must meet and to enable the future use of a unified and simplified reporting form. Currently under 40 CFR parts 79 and 80, there are ten separate cyclical reporting dates each year (eleven in a leap year). Streamlining reporting deadlines will allow EPA to develop a single, user-friendly, electronic form that will collect all required data, maximizing the

capability of electronic reporting to provide reuse of data and avoid duplicate data submission. EPA's goal is to simplify reporting and reduce the number of hours parties spend preparing and submitting reports while simultaneously improving data received from stakeholders. This overall effort responds to Executive Orders 13563 and 13610, which direct government agencies to simplify rules and to achieve reductions in paperwork and reporting burdens, and is part of EPA's agency-wide effort to streamline regulatory reporting requirements.

We are amending these deadlines so that all affected programs use the same four reporting deadlines. Programs that will be affected by this change include:

- The fuels and fuel additives registration program (40 CFR part 79, subpart A);
- the Reformulated Gasoline and Anti-Dumping program (40 CFR part 80, subparts D and E);
- the Gasoline Sulfur program (40 CFR part 80 subpart H);
- the Motor Vehicle, Nonroad, Locomotive, and Marine Diesel program (40 CFR part 80 subpart I);
- the Gasoline Benzene program (40 CFR part 80 subpart L);
- the Renewable Fuel Standard program (40 CFR part 80 subparts K and M); and
- the Tier 3 program being finalized today (40 CFR part 80 subpart O).

We are finalizing that reporting deadlines will be standardized as follows: June 1, for all reports covering quarter 1 of the compliance year (January through March); September 1, for quarter 2 (April through June); December 1, for quarter 3 (July through September); and March 31 for quarter 4 (October through December). End-of-year compliance reports will also be due on March 31. These changes will either delay or maintain current deadlines for nearly all required reports. Deadlines for all other annual reports will either be maintained if they matched the new quarterly deadline, or extended to match the new quarterly deadline. It should be noted that even with the changes finalized today, respondents will still have the option to report earlier than any given deadline. Commenters generally agreed with the proposed date changes. Some commenters in the refining industry suggested eliminating all quarterly reporting for RFG if winter aromatics, olefins and distillation are no longer required to be reported as they suggested. These values are normally reported in the 1st and 4th quarters. As one commenter stated, “In addition, there is no point in splitting up summer

RFG/RBOB reporting between the 2nd and 3rd quarters.” As noted above, winter aromatics, olefins and distillation are still required to be reported, albeit on a monthly composite basis. Thus, the need for quarterly reporting remains. However, we expect that the need for quarterly reports will be evaluated as part of the broader program restructuring discussed in Section VI.A.5.

EPA proposed not to include “Attest Engagements” (currently due May 31 of the following year) or reporting related to specific events under the Fuels Program, such as trading Renewable Identification Numbers (RINs) in EPA's Moderated Transaction System (EMTS), in the reporting revisions described above. Rather, all reporting deadlines for Attest Engagements and reporting specific events will remain the same. Some commenters communicated that if the annual and fourth quarter reporting deadlines were to be extended to March 31 of each year, then the attest engagement date should also be shifted one month from May 31 to June 30 to allow sufficient time for the significant data-gathering and communications required to complete those engagements. EPA is not changing the compliance period associated with the new extended reporting date, but rather, is simply allowing additional time for data review, preparation and reporting. EPA does not believe that extending the attest engagement date is necessary because companies have the flexibility to use the extra reporting time to begin preparation for the attest engagement if they prefer. As stated previously, the extension to reporting deadlines does not preclude stakeholders from reporting before the deadline. EPA is not extending the date for attest engagements from May 31 to June 30. That said, EPA is streamlining reporting dates to aid in our development of a single electronic reporting format and is updating the due date for attest engagements found in part 80 from May 31 to June 1. This change will not affect compliance or increase burden of reporting entities. Rather, the purpose of streamlining various reporting deadlines is to ease reporting burden and help aid EPA in the development and implementation of a single electronic reporting format.

We are also correcting a typographical error in 40 CFR 80.1451(f)(2) and clarifying that reports are to be signed by the “responsible corporate officer.” One commenter suggested that EPA revise the instances when a “responsible corporate officer” signature is required, and when perhaps someone else in the company can sign.

The example given in the comment was that a phone number change should not require a “responsible corporate officer” signature, as getting this level of signature can be burdensome, and the company can have appropriate delegations in place when someone other than the “responsible corporate officer” is the signatory. While we understand the concern expressed, EPA does not believe a regulatory action is necessary to address this concern but rather believes this issue is best addressed via administrative procedures. EPA plans to further evaluate this specific concern and similar “responsible corporate officer” issues and address the concerns in the future, outside of the regulatory framework.

Finally, we are addressing a typographical error in the regulatory text. Specifically, incorrect references under 40 CFR 79.5(a)(2) and 79.5(b) are being addressed as well as clarification being added.

#### c. Amendments To Update Fuel Parameter Test Methods

Refiners, importers and oxygenate blenders producing gasoline and diesel motor vehicle fuel are required to test RFG, CG and diesel fuel for various fuel parameters including aromatics, benzene, distillation, olefins, oxygenate content, RVP, and sulfur. As stated in the proposal, a number of relevant regulatory provisions had references to test methods that have been revised and updated. Several comments were received indicating that since the time of the proposal, some of the proposed updates have been further revised and updated and the desire was expressed for the regulated community to have the opportunity to use the most current version of each of these test methods. Today, we are updating those test methods to reflect current test methods in order to ensure that all test methods are readily available to the regulated community. ASTM International (ASTM) test method D2622 is currently the designated test method for measuring sulfur, in gasoline and diesel fuel at the 500 ppm sulfur standard. (§§ 80.46(a)(1), 80.580(b)(2).) ASTM test methods D5453, D6920, D3120 and D7039 are currently alternative test methods for measuring sulfur in gasoline. (§§ 80.46(a)(3)(i), 80.46(a)(3)(ii), 80.46(a)(3)(iii), 80.46(a)(3)(iv).) ASTM test method

D5453 is also an alternative test method for measuring sulfur in diesel fuel at the 500 ppm sulfur standard, as well as ASTM test method D4294. (§ 80.580(c)(2).) ASTM test method D6667 is currently the designated test method for measuring sulfur in butane. (§ 80.46 (a)(2).) ASTM test methods D4468 and D3246 are currently alternative test methods for measuring the sulfur content in butane. (§§ 80.46(a)(4)(i), 80.46(a)(4)(ii).) ASTM D1319 is currently the designated test method for measuring olefins in gasoline and aromatics in diesel fuel and is also allowed as an alternative test method for measuring aromatics in gasoline. (§§ 80.46(b), 80.2(z), and 80.46(f)(3), respectively.) ASTM D6550 is currently an alternative test method for measuring olefins in gasoline. (§ 80.46(b)(2)(i).) ASTM test method D5599 is currently the designated test method for measuring oxygenates in gasoline. (§ 80.46(g)(1).) ASTM test method D4815 is currently an alternative test method for measuring oxygenates in gasoline. (§ 80.46(g)(2).) ASTM test method D5769 is currently the designated test method for measuring aromatics in gasoline. (§ 80.46(f)(1).) ASTM test method D3606 is currently the designated test method for measuring benzene in gasoline. (§ 80.46(e).) ASTM test method D86 is currently the designated test method for measuring the distillation of gasoline. (§ 80.46(d).) ASTM test method D5191 is currently the designated test method for measuring the RVP of gasoline. (§ 80.46(c).) ASTM test method D976 is currently the designated test method for measuring the Cetane Index of diesel fuel. (§ 80.2(w).) ASTM standard practice D4057 is currently the manual sampling standard practice for petroleum and petroleum products. (§ 80.8(a).) ASTM standard practice D4177 is currently the automatic sampling standard practice for petroleum and petroleum products. (§ 80.8(b).) ASTM standard practice D5842 is currently the RVP sampling standard practice for fuels. (§ 80.8(c).) ASTM standard practice D5854 is currently the composite sampling standard practice for petroleum and petroleum products. (§ 80.8(a).)

Table VI-2 lists the designated analytical test methods and alternative analytical test methods for RFG, CG and diesel fuel that we are updating in today’s action. The Agency has

reviewed these updated ASTM test methods and believes that the revisions contained in them will result in improvements in the utilization of these test methods for the regulated industry. We also believe that our revisions to these test methods will not result in significant changes that would cause a user of an older version of the same method to incur increased compliance costs. Moreover, all of the revisions were deemed necessary by ASTM so that improvements in the test method’s procedures would ensure better operation for the user of the test method. Thus, EPA is today updating the regulations for the following ASTM test methods: (1) ASTM D2622-10, the designated test method for measuring sulfur in RFG, CG, and alternative test method for diesel fuel at the 500 ppm sulfur standard; (2) ASTM D3120-08, alternative test method for sulfur in gasoline; (3) ASTM D4294-10, alternative test method for sulfur in diesel fuel at the 500 ppm sulfur standard; (4) ASTM D5453-12, alternative test method for sulfur in gasoline and diesel fuel at the 500 ppm sulfur standard; (5) ASTM D6667-10, designated test method for sulfur in butane; (6) ASTM D4468-85(Reapproved 2011), alternative test method for sulfur in butane; (7) ASTM D3246-11, alternative test method for sulfur in butane; (8) ASTM D1319-13, designated test method for measuring olefins in gasoline and aromatics in diesel fuel, as well as the alternative test method for measuring aromatics in gasoline; (9) ASTM D6550-10, alternative test method for measuring olefin content in gasoline; (10) ASTM D4815-13, alternative test method for measuring oxygenate content in gasoline; (11) ASTM D5599-00 (2010), the designated test method for measuring oxygen content in gasoline; (12) ASTM D5769-10, the designated test method for measuring aromatics in gasoline; (13) ASTM D3606-10, the designated test method for measuring benzene in gasoline; (14) ASTM D86-12, the designated test method for measuring distillation properties of gasoline; (15) ASTM D5191-12, the designated test method for measuring the RVP of gasoline; (16) ASTM D976-06(2011), the designated test method for measuring the Cetane Index of diesel fuel; and (17) ASTM D7039-13, alternative test method for measuring sulfur in gasoline.

TABLE VI-2—DESIGNATED &amp; ALTERNATIVE ASTM INTERNATIONAL ANALYTICAL TEST METHODS UNDER RFG, CG &amp; DIESEL MOTOR VEHICLE FUEL PROGRAMS

Fuel parameter	ASTM Analytical test method
Sulfur (designated test method for gasoline) .....	ASTM D2622-10, entitled "Standard Test Method for Sulfur in Petroleum Products by Wavelength Dispersive X-Ray Fluorescence Spectrometry".
Sulfur (designated test method for 500 ppm sulfur diesel).	ASTM D2622-10, entitled "Standard Test Method for Sulfur in Petroleum Products by Wavelength Dispersive X-Ray Fluorescence Spectrometry".
Sulfur (alternative test method for gasoline) .....	ASTM D3120-08, entitled, "Standard Test Method for Trace Quantities of Sulfur in Light Petroleum Hydrocarbons by Oxidative Microcoulometry".
Sulfur (alternative test method for 500 ppm sulfur diesel).	ASTM D4294-10, entitled, "Standard Test Method for Sulfur in Petroleum Products by Energy Dispersive X-ray Fluorescence Spectrometry".
Sulfur (alternative test method for gasoline) .....	ASTM D5453-12, entitled, "Standard Test Method for Determination of Total Sulfur in Light Hydrocarbons, Spark Ignition Engine Fuel, Diesel Engine Fuel, and Engine Oil by Ultraviolet Fluorescence".
Sulfur (alternative test method for 500 ppm sulfur diesel).	ASTM D5453-12, entitled, "Standard Test Method for Determination of Total Sulfur in Light Hydrocarbons, Spark Ignition Engine Fuel, Diesel Engine Fuel, and Engine Oil by Ultraviolet Fluorescence".
Sulfur (designated test method for butane) .....	ASTM D6667-10, entitled, "Standard Test Method for Determination of Total Volatile Sulfur in Gaseous Hydrocarbons and Liquefied Petroleum Gases by Ultraviolet Fluorescence".
Sulfur (alternative test method for butane) .....	ASTM D4468-85(Reapproved 2011), entitled, "Standard Test Method for Total Sulfur in Gaseous Fuels by Hydrogenolysis and Rateometric Colorimetry".
Sulfur (alternative test method for butane) .....	ASTM D3246-11, entitled, "Standard Test Method for Sulfur in Petroleum Gas by Oxidative Microcoulometry".
Olefins (designated test method for gasoline) .....	ASTM D1319-13, entitled "Standard Test Method for Hydrocarbon Types in Liquid Petroleum Products by Fluorescent Indicator Adsorption".
Aromatics (alternative test method for gasoline and designated test method for diesel).	ASTM D1319-13, entitled "Standard Test Method for Hydrocarbon Types in Liquid Petroleum Products by Fluorescent Indicator Adsorption," for diesel fuel, this method is the designated test method; for gasoline, this method is an alternative test method and if used as an alternative method, its results must be correlated to ASTM D5769.
Olefins (alternative test method for gasoline) .....	ASTM D6550-10, entitled, "Standard Test Method for the Determination of Olefin Content of Gasolines by Supercritical-Fluid Chromatography".
Oxygen content (designated test method for gasoline) ..	ASTM D5599-00 (2010), entitled, "Standard Test Method for Determination of Oxygenates in Gasoline by Gas Chromatography and Oxygen Selective Flame Ionization Detection".
Oxygen content (alternative test method for gasoline) ...	ASTM D4815-13, entitled "Standard Test Method for Determination of MTBE, ETBE, TAME, DIPE, tertiary-Amyl Alcohol and C <sub>1</sub> to C <sub>4</sub> Alcohols in Gasoline by Gas Chromatography".
Aromatics (designated test method for gasoline) .....	ASTM D5769-10, entitled, "Standard Test Method for Determination of Benzene, Toluene, and Total Aromatics in Finished Gasolines by Gas Chromatography/Mass Spectrometry".
Benzene (designated test method for gasoline) .....	ASTM D3606-10, entitled, "Standard Test Method for Determination of Benzene and Toluene in Finished Motor and Aviation Gasoline by Gas Chromatography".
Distillation (designated test method for gasoline) .....	ASTM D86-12, entitled, "Standard Test Method for Distillation of Petroleum Products at Atmospheric Pressure".
Reid Vapor Pressure (designated test method for gasoline).	ASTM D5191-12, entitled, "Standard Test Method for Vapor Pressure of Petroleum Products (Mini-Method)".
Cetane Index (designated test method for diesel) .....	ASTM D976-06(2011), entitled, "Standard Test Method for Calculated Cetane Index of Distillate Fuels".
Sulfur (alternative test method for gasoline) .....	ASTM D7039-13, entitled, "Standard Test Method for Sulfur in Gasoline, Diesel Fuel, Jet Fuel, Kerosine, Biodiesel, Biodiesel Blends, and Gasoline Ethanol Blends by Monochromatic Wavelength Dispersive X-ray Fluorescence Spectrometry".

d. Amendments Related to Downstream Blending and Upstream Refiner/Importer Compliance Determination

Today's rule also clarifies the list of products that are not to be included in a refinery's or importer's compliance determination under § 80.1240. Refiners and importers are currently required under § 80.1235(b)(2) to exclude oxygenate added to finished gasoline, RBOB or CBOB downstream of either the refinery that produced the gasoline or the import facility where the gasoline was imported. This conflicts with EPA's intended approach in § 80.1238(b), which allows refiners and importers to

include oxygenate blended downstream of a refinery or import facility in their annual average benzene calculation, provided the refiner or importer meets certain requirements. We are finalizing changes that will allow refiners and importers to include oxygenate blended downstream of their facility and that will make these related sections consistent. EPA received significant support for this action from commenters.

e. Amendments Regarding Previously Certified Gasoline

For compliance with the MSAT2 regulations, for blendstock that is

blended into previously certified gasoline (PCG), we are providing flexibility for refiners and importers by providing an alternative allowing them to directly sample and test each batch of blendstock, and treat the blendstock as a produced batch. We are adding § 80.1347(a)(6) to reflect this alternative. This practice is already allowed under the Tier 2 sulfur program (at § 80.340(a)(2)). Refiners and importers are currently required to determine the benzene content of the PCG before the addition of blendstock, determine the benzene content of the combined blend of PCG and blendstock, and calculate the properties of the blendstock by

treating the PCG as a negative volume batch and treating the blended product as a positive batch. Due to variability in the benzene test method, the PCG approach can sometimes result in calculated blendstock benzene concentrations that are negative, which is physically impossible. We are amending the regulations at § 80.1235(a)(6) (and adding § 80.1347(a)(6), as mentioned) to allow refiners and importers who blend blendstock into PCG to directly test the blendstock for benzene. We expect that this method will improve accuracy and ensure a positive benzene test result. Also, today's action will clarify that regardless of the approach used, a negative sulfur or benzene result cannot be reported; rather, any negative result must be rounded to zero. Similarly, no negative annual average result can be reported. We are also amending the regulations at § 80.1235(a)(5) to clarify that refiners and importers may use either approach for blendstocks that are blended into either conventional gasoline or reformulated gasoline.

Lastly, we are allowing importers who import gasoline into the United States by truck to use the sampling and testing requirements in subpart E for truck importers as an alternative to the sampling and testing requirements in subpart L. EPA provided these alternative requirements in subpart E to eliminate the need to test every truckload of imported conventional gasoline for all complex model parameters, including benzene.<sup>489</sup> Since subpart L also requires importers to test every truckload of imported gasoline for benzene, EPA believes it is appropriate to allow truck importers of gasoline to use the sampling and testing requirements in subpart E as an alternative. We are amending the regulations to provide this alternative by adding a new § 80.1349. EPA received significant support for this action from commenters.

#### f. Amendments Related to Designation of an Alternative Lab

Refiners have indicated to EPA that significant problems are created when a facility's designated lab is nonoperational and testing cannot be performed at the lab during that time period. We are thus finalizing (at § 80.65(f)(5)) that a facility will have the ability to designate a back-up or alternative lab for testing during such times. In no case could this alternative lab be used to select the best test result, rather it may only be used on those occasions where operational necessity

causes a need for it (e.g., the normal lab is closed, the apparatus for certain test methods are down, or independent lab personnel are not available). EPA received significant support for this action from commenters.

#### g. Amendments Related to De Minimis Reporting Changes

We proposed that parties who submit batch reports would not be required to correct inconsequential errors in reporting batch volumes under certain conditions, the primary condition being that the discrepancy met the definition of "de minimis", which as proposed, was an amount no greater than the smaller of 500 gallons or one (1) percent of the true batch volume. Under the proposal, regulated parties would no longer be required to provide a complete resubmission of a compliance report when a minor discrepancy of a few barrels was uncovered. We proposed that this new provision would apply to reporting for RFG, anti-dumping, gasoline and diesel sulfur, and MSAT2. We proposed that it would also apply to the RFS renewable volume obligation (RVO), but would only apply to the volume of fuels produced or exported that result in a RVO for obligated parties.

We received comments on this proposed change, many of which generally agreed with our concept. However, commenters who agreed with the concept stated that they believe the proposed levels are so small that they are of little practical value, and that a de minimis volume of 500 gallons will almost always be less than 1 percent of the true batch volume. In examples provided, commenters stated that pipeline batch volumes are approximately 25,000 barrels, and that a 500 gallon difference equates to a 0.05% difference; 500 gallons on a 250,000 gallon refinery production batch equates to 0.005%. Thus, according to the commenters, the 500 gallon limit—which is clearly less than 1% in the two examples—would fail to provide the intended relief and would not prevent a party from having to make inconsequential volume corrections. These commenters suggested that a de minimis threshold value of 0.5 percent be applied regardless of batch size. Several commenters also recommended that we delete the proposed regulatory text at § 80.10 (c) and (d), as the application of a de minimis threshold implies that small volume errors in batch reporting are truly inconsequential and do not have an impact on compliance with fuel standards, so no separate demonstration of material impact should be required.

One commenter stated that it opposes the de minimis provision with respect to the RFS program. According to the commenter, EPA did not provide sufficient legal or factual basis for the proposal in order for the public to provide meaningful comment. In addition, according to the commenter, the proposed de minimis change, if finalized, would allow obligated parties to under report their volume, thereby reducing their RVO. The commenter also stated that EPA cannot finalize the proposed provision based on other comments it receives because, according to the commenter, EPA would still not be satisfying notice and comment requirements.

We have decided not to finalize the proposed de minimis provisions at this time. One of the primary motivations for proposing the de minimis provision was to avoid the need for inconsequential corrections to production volumes that would have no impact on compliance with standards that rely on production volumes (e.g., average standards and RFS). Late changes to production volumes for whatever reason can necessitate simultaneous changes to compliance calculations that, if de minimis, would have no meaningful impact on compliance. However, as comments highlight, it is has proven difficult to come up with an acceptable de minimis threshold that can apply across all potential situations. Furthermore, the proposed provision focused only on volume corrections, but in reality our experience suggests that corrections often take place for other purposes such as data entry, coding, formatting or other typographical errors—not only minor corrections to reported volume. We believe that adjusting reports for inconsistencies will become less burdensome, as EPA intends to transition all reporting to electronic reporting in the future. In addition, EPA received input from the regulated community about a de minimis provision specifically as it related to the RFS program. As discussed below in Section VI.A.1.h, we are finalizing a one-month delay in the RFS reporting deadline, which we believe will provide obligated parties with more time to review and correct their records and reports, and help to minimize the need for late corrections. We will revisit the need for a de minimis threshold in the future if these changes prove insufficient.

#### h. Amendments Related to RFS2 Annual Report Date

EPA is finalizing the proposed changes to the RFS2 annual report date from the last day of February to March

<sup>489</sup> 70 FR 74561 (December 15, 2005).

31. EPA intended the change would 1) alleviate staffing problems for regulated entities because the regulatory requirements are often handled by the same personnel and 2) provide relief from the urgent need to obtain RINs when small discrepancies in gasoline production or import volumes are realized. Another reason for proposing a change to the reporting deadline from the last day in February to March 31 was described in Section VI.A.1.b. (Amendments Related to Reporting Dates). Streamlining reporting dates will allow EPA to develop a single, user-friendly, electronic form that will collect all required data, maximizing the capability of electronic reporting to provide reuse of data and avoid duplicate data submission. Commenters generally agreed with the proposed date change. One commenter pointed out that the staffing issue described would not be addressed by the change date because EPA is changing both RFG and Anti-dumping compliance deadlines to March 31—same as the RFS2 annual reporting. EPA understands the point made but nonetheless, believes that delaying the RFS reporting date will give reporting entities additional time and flexibility to review data and will have no impact on emissions, air quality, or compliance with the standard. EPA also believes that the overarching goal of streamlining reporting dates to develop a single electronic reporting format, in and of itself, will provide general relief to regulated parties. Comments received generally support this view.

EPA requested comment on whether or not the same date extension from the last day of February to March 31 should apply to those transferring RINs in EMTS for satisfying RVOs under the previous compliance year. Some commenters wanted to have RIN trading through the new deadline (March 31), while others wanted trading to end on the last day of February to allow time for data cleanup which could improve compliance and reporting accuracy. One commenter also pointed out that changing the RIN trading deadline

might have an unforeseen impact on the RIN market and suggested EPA carefully consider this possibility before making a decision on extending the RIN trading date. EPA agrees that providing enough time for data cleanup is important to ensure reporting accuracy and meet compliance goals. In addition, EPA understands stakeholders' concerns about how such a change in RIN trading could conceivably impact the RIN trading market dynamics. As such, RIN transfers in EMTS for satisfying RVOs under the previous compliance year will continue to end on the last day of February.

i. Amendments to the Highway Diesel Pump Label Requirements

We are removing the requirement for diesel fuel pump labels for 15 ppm highway diesel fuel. Beginning December 1, 2010, all highway diesel fuel was required to be 15 ppm or less; thus, highway diesel fuel labels are no longer needed to distinguish it from 500 ppm highway diesel fuel. However, we do recognize that it may confuse consumers who are accustomed to seeing the highway diesel fuel pump labels if those labels were to disappear, thus, retail and wholesale purchaser-consumer facilities will be free to continue labeling to eliminate confusion if they so choose. The elimination of this requirement from the regulations does not preclude retail and wholesale purchaser-consumer facilities from keeping 15 ppm highway diesel fuel labels, it only eliminates the EPA requirement that such labels must be present.

Comments from parties in the fuels industry expressed support for this proposal. Additionally, we received a comment suggesting that the requirement of vehicle labeling for 15 ppm highway diesel fuel (ultra low sulfur diesel fuel, or "ULSD") should also be removed in conjunction with this change, as the vehicle labels would be unnecessary for the same reasons noted for the pump labels. We note that this change was in fact made for vehicles under 14,000 lbs GVWR in a

previous rulemaking for MY 2014 and later vehicles (see 40 CFR 86.1807–01(h)). Further, in today's action, we are discontinuing the ULSD labels for MY 2014 and later vehicles above 14,000 lbs GVWR at 40 CFR 86.007–35(c).

2. Performance-Based Measurement Systems (PBMS)

Today we are finalizing a performance-based measurement system (PBMS) for chemical and physical properties of fuels regulated by EPA's motor vehicle and engine fuel programs. Specifically, they are gasoline properties at § 80.46, gasoline sulfur at § 80.195, and diesel fuel properties at § 80.2(z). At proposal, we explained that PBMS would set forth procedures and criteria for those laboratories making measurements to demonstrate compliance with fuels regulations to qualify alternative analytical test methods. We also explained that it would set minimum statistical quality control (SQC) requirements, based on standard industry practices, and that laboratories must maintain and document the precision and accuracy of analytical methods used in the context of this program. We further explained that EPA envisioned that PBMS would provide additional flexibility to the regulated industry in choosing test methods and foster innovation and improvement in the precision and accuracy of the measurement of motor vehicle and engine fuel properties while not reducing the emission benefits that result from these fuel programs. We reasoned that PBMS should also provide cost savings to the regulated industry by providing rapid access to newly-developed test methods with superior speed and ease of analysis. This is because some of these newer methods use less-expensive easier to automate instrumentation and smaller quantities of consumables, thus, reducing both operating costs and environmental impact (78 FR 29953). Table VI–3 below lists fuel parameters and their corresponding designated test methods that we proposed to update.

TABLE VI–3—DESIGNATED ANALYTICAL TEST METHODS FOR GASOLINE AND DIESEL FUEL

Fuel parameter	Designated analytical method
Sulfur in gasoline .....	ASTM D 2622–10.
Sulfur in butane .....	ASTM D 6667–10.
500 ppm Sulfur Diesel Fuel .....	ASTM D 2622–10.
Olefins in gasoline .....	ASTM 1319–10.
Reid vapor pressure (RVP) in gasoline.	ASTM D5191–10b, with the following correlation equation: RVP psi = (0.956 * X) – 0.347. RVP kPa = (0.956 * X) – 2.39. where: X = total measured vapor pressure in psi or kPa.
Distillation in gasoline .....	ASTM D86–11a.

TABLE VI-3—DESIGNATED ANALYTICAL TEST METHODS FOR GASOLINE AND DIESEL FUEL—Continued

Fuel parameter	Designated analytical method
Benzene in gasoline .....	ASTM D 3606-10, except that instrument parameters shall be adjusted to ensure complete resolution of benzene, ethanol, and methanol peaks.
Aromatics in gasoline .....	ASTM D 5769-10, except that sample chilling requirements in section 8 of this standard are optional.
Oxygen and oxygenate content in gasoline.	ASTM D5599-00 (2010).
Aromatics in diesel fuel .....	ASTM D1319-10.

a. Overview of Proposed Program Requirements

As explained at proposal, in a June 29, 2004 rulemaking, EPA specified a performance-based approach for measuring diesel sulfur at 15 ppm and 500 ppm and removed previous requirements that had specified particular designated and alternative methods for 15ppm diesel sulfur.<sup>490</sup> We decided, in that rulemaking, to offer two options for test methods for diesel sulfur at the 500 ppm level. The first option required use of either the designated test method or specific alternative test methods.<sup>491</sup> The second option was for a test method to meet performance based requirements similar to those adopted for 15 ppm diesel sulfur.<sup>492</sup> We proposed extending the performance-based approach to method selection and qualification to other parameters besides diesel sulfur, with modifications appropriate to accommodate the differences among fuel parameters. Today, consistent with our proposal, we are finalizing requirements for PBMS subject to a few revisions of certain requirements that we are making in response to comments on our proposal.

Specifically, in today's action we are setting forth requirements that laboratories should use to demonstrate the precision<sup>493</sup> and accuracy<sup>494</sup> of chosen fuel parameter measurement methods. As also explained at proposal, PBMS as finalized would: (1) Require individual laboratories to demonstrate

adequate measurement quality, (2) allow laboratories to choose methods that meet their own needs, provided they can meet quality criteria, (3) prescribe criteria rather than specific methods<sup>495</sup>, and (4) require all laboratories making regulatory measurements to establish and maintain a statistical quality control program (72 FR 29955). EPA continues to believe that PBMS will not compromise on either precision or accuracy relative to the system that exists under current regulations. We have also incorporated the standards and practices of Voluntary Consensus Standard Based (VCSB) organizations wherever feasible.

Today's requirements apply to the qualification of analytical test instrumentation and methods used to measure various characteristics of individual fuel samples. Consistent with our proposal, it does not apply to sampling methods or in-line blending methods. The Agency received several comments asking to extend PBMS to in-line blending methodologies expeditiously. As earlier explained, today's final action does not extend to sampling methods or in-line blending methods. This is because, in-line blending already has a certification process that sets forth qualification criteria that take into account the unique combinations of sampling, control, and analysis that are involved with in-line blending. See 40 CFR 80.65(f).

b. How can we establish the accuracy of the measurement system (all qualified methods/installations) for each parameter?

We proposed grouping the gasoline and diesel fuel parameters that must be measured (e.g., aromatics, sulfur, etc.), into two categories, depending upon whether it is practically feasible to construct and use gravimetric

standards<sup>496</sup> for defining the parameter and thus, for determining the accuracy of a measurement method. To establish the accuracy of methods measuring each parameter for which gravimetric standards are not feasible, we proposed retaining an EPA-prescribed reference method or designated method that would, in effect, define the parameter—as in “parameter X is, for federal regulatory purposes, whatever method Z measures.” We explained that parameters that require such treatment would be described as “method-defined” parameters. We also explained that anchoring the accuracy of a method intended to measure such a parameter would be accomplished by relating its measurements on a particular set of test fuels to measurements made on the same fuels by a laboratory operating the designated method. We further explained that this approach is often referred to as “correlating” the new method with the designated method. Such a correlative approach to qualification is dependent for its workability upon the test fuels used to establish the correlation. They must be sufficiently varied along all important dimensions so that day-to-day production laboratory operations are very unlikely to turn up some unusual fuels (or a new class of fuels produced, say, by some new refining process) for which the correlation equation derived earlier does not hold true and where the predictions of the designated method's results are quite erratic and inaccurate.

As also explained at proposal, our classification of parameters into the absolute or method-defined categories is not entirely straightforward. Of the parameters subject to our proposal, only those with sulfur as the analyte seem to fall unambiguously into the absolute category. We additionally explained that sulfur is a single element rather than a

<sup>496</sup> Gravimetric standards are test materials made by adding a carefully weighed (hence “gravimetric”) quantity of the analyte of interest to a measured quantity of another substance known not to contain any of the analyte. The result is a solution with a very accurately known concentration of the analyte. The accuracy of gravimetric standard reference materials can be closely controlled and is not dependent on an analytical test method.

<sup>490</sup> See 40 CFR 80.584 and 80.545.

<sup>491</sup> See 40 CFR 80.580(c)(2).

<sup>492</sup> See 40 CFR 80.584(a)(2), 40 CFR 80.584(b)(2)(i) through 40 CFR 80.584(b)(2)(iii), and 40 CFR 80.585.

<sup>493</sup> Precision—the amount of consistency in a set of measurements performed on the same material. ASTM repeatability and reproducibility are examples of measures of precision. ASTM Repeatability (“r”)—the difference between successive test results obtained by the same operator with the same apparatus under constant operating conditions on identical test material. ASTM Reproducibility (“R”)—the difference between two single and independent test results obtained by different operators working in different laboratories on identical test material using the same method.

<sup>494</sup> Accuracy—the closeness of a single measurement to its true value of what is being measured.

<sup>495</sup> For some parameters the criteria will be based on the laboratory's chosen method's ability to closely predict the measurements made by EPA's chosen or “designated” method. This approach is made necessary by the “method-dependent” definition of some of the parameters to be measured.



compound (or, worse, a class of compounds with numerous members) and thus lends itself to the construction of gravimetric standards. We further explained that the methods that are currently used to measure sulfur in gasoline and diesel fuel have been subject to intensive recent development work and are largely free of matrix effects. Sulfur in butane is, arguably, even more amenable to the absolute approach, since the matrix, butane, is a single compound rather than a constantly varying mixture of many compounds. We noted that the diesel sulfur rule used the absolute approach. We therefore proposed to treat gasoline sulfur and sulfur in butane as absolute parameters. For a complete discussion of our classification scheme see 78 FR 29955–29956.

Given logical and practical difficulties with using a gravimetric approach to qualifying methods for parameters other than sulfur, EPA proposed and sought comment on classification of parameters into either the absolute category to be used for sulfur or method defined or correlative category to be used for all parameters other than sulfur. All comments received were in support of this approach. Therefore, today, EPA is adopting a classification of fuel parameters where the absolute category will be used for sulfur in gasoline and butane, and a method defined category will be used for all other gasoline and diesel fuel parameters.

c. How would analytic methods be evaluated for qualification?

i. General Provisions: to which methods and which parties do the proposed requirements apply?

We proposed and requested comments on requiring laboratories to qualify all methods used in measurements for regulatory purposes. We explained that EPA did not believe that a relatively simple qualification test would ensure continued measurement quality, but rather that these requirements would greatly reduce the likelihood of a laboratory undertaking important measurements without some assurance that an instrument is in working order, that at least one operator<sup>497</sup> in the laboratory

<sup>497</sup> The intent behind the qualification process is to demonstrate the facility's capability with the method. Accordingly we did not propose that each instrument used to implement a particular method be required to qualify (some labs may have several instruments implementing a single method) or that each operator be so required. We recommend, but did not propose to require, that a laboratory rotate operators during the testing required for qualification, thereby both improving and testing the skills of all operators for a given method and strengthening its quality program.

understands the method for its use, and that it can be made to perform to meet acceptable criteria. We received comments that were supportive of these requirements.

ii. How would Laboratories demonstrate the precision and accuracy of methods for measuring “absolute” parameters and thus qualify the methods for use?

As explained at proposal, test methods typically used for gasoline sulfur are also frequently used for diesel sulfur. We also noted that the ASTM test method designations for both are the same. At proposal, we explained that examination of test method descriptions, however, pointed toward substantial differences in how these test methods are used in the different matrices. Thus, while we considered the possibility of allowing the diesel sulfur qualifications to be used also for gasoline sulfur, we believed differences between a diesel fuel matrix and gasoline fuel matrix were likely too great to permit such a sweeping exemption from qualification requirements. We reasoned that reworking test methods to measure gasoline sulfur would, in many cases, generate most of the data needed for qualification, and thus would not represent a major additional effort. So, despite VCSB-sponsored gasoline sulfur test methods bearing the same organizational designations as their diesel counterparts, we proposed to require that these test methods qualify separately for use in measuring gasoline sulfur (78 FR 29956). No negative comments were received on our proposal to require test methods that have already been qualified for diesel fuel to qualify separately for gasoline. Thus, consistent with our proposal, we are finalizing requirements for test facilities that have already qualified a method for measuring sulfur in diesel fuel to qualify test methods for measuring sulfur in gasoline.

*Operational Description:* We proposed requiring applications for qualification to include a complete operational description of the test method in question. For methods published by organizations such as ASTM International, we explained that the test method designation number and title would satisfy this requirement. We also proposed requiring the description to include the scope of the test method, a summary, discussion of interferences that are expected, apparatus needed, reagents, sampling and specimen preparation, calibration, test method procedure, calculations, and any test method-specific quality control (78 FR 29956). We received comments in

support of these requirements as well as comments indicating that the regulations should explicitly state that the test method designation number and title of the test method would meet the operational description requirement for VCSB test methods. The Agency agrees with this comment and has modified the final regulations as suggested. In today's action we are also finalizing all other operational description requirements as proposed.

*Precision Qualification:* We proposed and sought comments on requirements for precision qualification that were similar to requirements set forth in the non-road diesel sulfur rule. As explained at proposal that rule imposed a maximum value for the standard deviation<sup>498</sup> of a series of at least 20 measurements over at least 20 days on a single fuel under site precision conditions. Specifically, the diesel rule used 1.5 times the repeatability standard deviation (ASTM “r”/2.77) of what was the least precise of the then-allowed methods. We explained that the factor of 1.5, expands the allowable variability from that of back-to-back tests (as in ASTM's definition of repeatability) to account for the sources of greater variability that find their way into a longer series of tests on the same material. We explained that in the qualification process for ultra-low sulfur diesel testing, the factor of 1.5 proved to be neither so tight that most laboratories were unable to meet it, nor so loose as to not be challenging at all. Thus, we considered it to be reasonable, as well as having proven to be workable in practice, and therefore proposed that the precision qualification for diesel fuel be applied to both absolute and method defined fuel parameters.

Comments were supportive of our proposed precision criteria for the absolute fuel parameters of sulfur in gasoline and sulfur in butane. We also received comments that were against the extrapolation of precision qualification for absolute fuel parameters based on published method repeatability (r) to method defined parameters. These comments will be addressed in more detail below under the discussion of precision criterion for method defined fuel parameters.

*Gasoline Sulfur Precision Criteria:* We proposed and sought comments on the use of the repeatability for ASTM D7039–07 (i.e., 1.76 ppm at 10 ppm) to set the precision criterion for sulfur in gasoline. We reasoned that the maximum allowable standard deviation

<sup>498</sup> Where the standard deviation is estimated from a sample of the population (formula uses “N–1” in the denominator).

of the twenty test results on a 10 ppm gasoline would be 0.95 ppm.<sup>499</sup> We did not propose to prescribe the parameter level for the fuel used for these precision tests, because we believed that this maximum limit will vary depending upon the repeatability number that the ASTM D7039–07 test method's repeatability formula yields, given the parameter value of the test fuel chosen. We also explained that if a laboratory selected a 5 ppm fuel to test instead of a 10 ppm fuel, the maximum limit for the standard deviation would be 0.67 ppm (78 FR 29956–29957). Comments provided were in support of this requirement. Thus the Agency is finalizing the precision criterion for sulfur in gasoline that is based on the repeatability of ASTM D7039–07. This would require dividing it by 2.77 to obtain the underlying standard deviation, and multiplying the result by 1.5 to get the applicable precision criterion based on the concentration of sulfur in gasoline.

*Sulfur in Butane Precision Criteria:*

We proposed a precision criterion based on the repeatability of ASTM D6667–10. We explained that this test method's repeatability at the 10 ppm level would be 1.15 ppm, and that calculations for sulfur yielded an upper limit for the standard deviation of the 20 tests for sulfur in butane of 0.62 ppm (78 FR 29957). Most of the comments we received were in support of our proposal. We also received one comment from the Independent Fuel Terminal Operators Association (IFTOA), a trade association for fuel terminal operators, which provided comments on behalf of its members. IFTOA expressed concerns over the repeatability calculation we provided at proposal for 10 ppm sulfur in butane. IFTOA explained that reduced sulfur levels would inhibit butane blending due to reduced availability of butane with very low sulfur. IFTOA requested additional flexibility and noted the difficulty and expense involved in finding butane with sulfur content of 10 ppm or below. Therefore, IFTOA urged the Agency to consider focusing on the sulfur content of the final blend and not the sulfur content of the butane component. IFTOA further provided comments urging the Agency to allow blenders downstream of the refinery and importer gate to add butane that meets the downstream per gallon cap so long

as the butane blending operation does not cause the blender's finished gasoline to have annual average sulfur content above 10 ppm.

The Agency disagrees with IFTOA's reading of the example calculation provided in the proposed preamble and regulations, which utilized the repeatability of ASTM D6667–10 as the basis for the precision criterion when the sulfur level of butane was at 10 ppm. The intent of this example was not to provide a cap on sulfur in butane at 10 ppm, but rather only intended to be an example explaining that the precision criterion for sulfur in butane would be 0.62 ppm if the sulfur level in butane was 10 ppm. The Agency agrees with IFTOA that blenders downstream of the refinery and importer gate should be permitted to add butane that meets the downstream per gallon cap of 80 ppm so long as the butane blending operation does not cause the blender's finished gasoline to have an annual average sulfur content above 10 ppm. Accordingly, today's final regulations include examples if sulfur in butane is at the 80 ppm cap, instead of the 10 ppm sulfur average. We are also finalizing precision criteria for sulfur in butane that is based on the repeatability of ASTM D6777–10, consistent with our proposal.

*Temporal Distribution of Precision*

*Tests:* With regard to spacing of the required 20 precision tests, we proposed and sought comments on requiring 7 or fewer tests per week and 2 or fewer tests per day. We also sought comments on the following two options: (1) A requirement that 23 or more hours must elapse between tests (this option requires either testing on weekends or an extension of the 20 days); and (2) tests arranged into no fewer than five batches of five or fewer tests each, with only one such batch allowed per day over 20 days (78 FR 29957). We received comments in support of option 2, (i.e., arranging tests into no fewer than five batches or fewer tests each, with only one such batch allowed per day over the minimum of 20 days) because, according to commenters, it would provide the most flexibility and be easier to implement. Today's rule includes requirements for testing that are consistent with our proposed option 2.

*Accuracy Qualification:* We proposed and sought comments on accuracy criteria for absolute fuel parameters that are similar to the criteria for sulfur in diesel fuel. We proposed that applicants for qualification would be required to select two commercially available gravimetric standard reference materials (SRM), and then show that their

laboratory and method are capable of getting an average of ten consecutive results that are very close to the Accepted Reference Value (ARV), for each SRM. We proposed to use 0.75 times the precision criterion described above, which is the same value for sulfur in diesel. We explained that in the case of gasoline sulfur, for a gravimetric standard with ARV = 10 ppm, this would be 0.75 times 0.95 ppm or 0.71 ppm. The corresponding numbers for sulfur in butane at the 10 ppm level would be 0.75 times 1.15 or 0.47 ppm. For other parameters that might eventually fall into the absolute category, we proposed that the precision and accuracy criteria would be determined as a function of the ASTM repeatability of one of the methods (selected by EPA) available for measuring that parameter (78 FR 29957).<sup>500</sup> Comments were supportive of our proposed requirements for determining accuracy criteria for absolute fuel parameters. Thus, the Agency is finalizing the accuracy qualification criteria as proposed.

iii. How would laboratories demonstrate the precision and accuracy of methods for measuring "method-defined" parameters and qualify the methods for use?

*Operational Description:* We proposed the same operational description requirements for both method defined and absolute parameters. We explained that publication of a test method by a VCSB organization, such as ASTM, where the test method number and title is cited, would meet this criterion. We also explained that a non-VCSB test method would require additional information because non-VCSB test methods have not been fully vetted by a VCSB. We explained that the underlying scientific measurement principles must be thoroughly explained and the apparatus described well enough that a trained outsider could successfully implement the non-VCSB test method and replicate the applicant's results (78 FR 29957). In addition, for non-VCSB test method we proposed that the description must

<sup>499</sup> This number was determined by using the repeatability equation for "r" from ASTM D7039–07 for a 10 ppm sulfur gasoline to get 1.76 ppm, dividing the "r" in ppm by 2.77 to obtain the underlying standard deviation of 1.39 ppm, and multiplying the result by 1.5 (criterion used in diesel sulfur rule) to get 0.95 ppm.

<sup>500</sup> It is important to understand that the numerical examples presented in the text are entirely hypothetical, because use of precision testing material or gravimetric standards at levels other than those used in the examples would change all of the numbers. Use of a gasoline sulfur gravimetric standard at 5 ppm (instead of the 10 ppm used in the example) would require computing the repeatability of the method at 5 ppm using the equation given in the method description, dividing it by 2.77, multiplying the result by 1.5, and then multiplying that result by 0.75. As a short-cut, the accuracy criterion could be determined by multiplying the ASTM repeatability of the method at the level in question by 0.4061.

include the scope of the test method, a summary, discussion of any interferences that are expected, apparatus needed, reagents, sampling and specimen preparation, calibration, test method procedure, calculations, and any test method-specific quality control. As previously discussed in Section VI.A.3.c.ii, we received comments in support of these requirements as well as comments indicating that the regulations should explicitly state that the test method designation number and title of the test method would meet the operational description requirement for VCSB test methods. The Agency agrees with this comment and has modified the final regulations as suggested. In today's action we are also finalizing all other operational description requirements as proposed.

*Precision Qualification Specifics:* We proposed the same precision qualification criteria for both method defined and absolute parameters. For reference installations, we proposed additional requirements that the instrument must be shown to be in statistical control, as provided for in ASTM D6299–10<sup>e1</sup> (and the proposed SQC procedures) and that the applicant must submit control charts showing a record of in-control operation for at least five months. At proposal we acknowledged that while these requirements would likely result in a delay between instrument setup and the ability to qualify a reference installation, we believed that any delay was necessary to demonstrate the stability of these critically important installations. We reasoned that EPA expected no lack of laboratories that are capable of meeting these standards considering the number of long-established installations of these designated test methods (78 FR 29957).

The Agency received several comments from the American Petroleum Institute, the Association of Fuel and Fuel Petrochemical Manufacturers, Chevron Products Company, and Marathon Petroleum Company LP that were against extrapolating the same precision qualification criteria for

absolute fuel parameters, which is based on the published method's repeatability (r), to the precision qualification criterion of method defined fuel parameters. Specifically, according to the commenters, precision criteria for method defined fuel parameters are sensitive to the matrix making up the fuel material that is to be analyzed. This degree of sensitivity to the fuel matrix is different for different test methods, techniques, and instrumentation that measure the same method defined fuel property. Commenters recommended instead that the precision standard deviation qualification criterion be based on the Test Performance Index (TPI), as described in ASTM D6792.<sup>501</sup> The commenters further explained that the TPI in ASTM D6792 sets minimum site precision performance criteria based on test method reproducibility (R) and the Precision Ratio (PR) of the published test method. Also, commenters noted that using the TPI as outlined ASTM D6792 would be consistent with OMB Circular 119, which directs agencies to use voluntary consensus standards in lieu of government unique standard except where inconsistent with law or otherwise impractical.

The Agency has evaluated ASTM D6792 and agrees that it would be appropriate to base the precision qualification criterion for method defined parameters on the TPI as described in ASTM D6792. We also agree that method-defined test methods are subject to fuel matrix effects, and therefore, that the degree of sensitivity to the fuel matrix is different for different test methods, techniques, and instrumentation that measure the same method defined fuel property. Therefore, in a change from proposal, and in response to comments, we are requiring that the precision qualification criterion for method defined parameters be based on the Test Performance Index (TPI) as described in ASTM D6792.

*Olefins in Gasoline Criterion:* We had proposed to base the precision qualification for olefins in gasoline on the repeatability of ASTM D1319–10. Thus, we explained that for a test fuel with olefins at, say, 9 volume percent

(Vol.%), the repeatability would be 0.972, the underlying standard deviation would be  $0.972/2.77=0.351$ , and the precision criterion would be 1.5 times that or 0.53 Vol.%. We had proposed that a laboratory's standard deviation for the 20 tests could not exceed that value and still qualify for precision (78 FR 29957–29958). Several commenters including the American Petroleum Institute, the Association of Fuel and Fuel Petrochemical Manufacturers, Chevron Products Company, and Marathon Petroleum Company LP, argued that that the precision standard deviation criterion for method-defined parameters should be based on the TPI described in ASTM D6792–07.<sup>502</sup> Also, both API and AFPM stated that using the TPI as outlined in ASTM D6792 is consistent with OMB Circular 119, which directs agencies to use voluntary consensus standards in lieu of government unique standards except where either inconsistent with law or otherwise impractical.

As previously explained, the Agency has evaluated and agrees with the comment that the TPI, in ASTM D6792, should be used because it sets minimum site precision performance criteria based on test method reproducibility (R) and the Precision Ratio (PR) of the published test method. The Agency is therefore, finalizing the requirement that precision criteria for olefins in gasoline will be based on the TPI in ASTM D6792. Additionally, consistent with our proposal to afford the regulated community the use of the most current version of test methods, we are also updating the olefin in gasoline test method ASTM D1319 to the 2013 year version, as discussed in Section VI.A.1.a.iii above. We are also finalizing requirements that the reproducibility of ASTM D1319–13 be utilized in setting the precision criterion. For example, the reproducibility is 3.06, and the precision criterion is 0.3 times 3.06 or 0.92 volume percent (Vol. %), for a test fuel with olefins at 9 Vol. %.

Table VI–4 provides the TPI in ASTM D6792 for setting the olefin precision criterion.

TABLE VI–4—METHOD-DEFINED PRECISION CRITERION FOR OLEFINS IN GASOLINE

ASTM method	Property	Precision ratio (R/r)	ASTM D6792 minimum TPI = (r/R')	Maximum acceptable site precision (R')	Site precision standard deviation qualification = R'/2.77
D1319–13	Olefins	3.2	1.2	0.83R	0.3R

<sup>501</sup> ASTM D6792–07, entitled, "Standard Practice for Quality System in Petroleum Products and Lubricants Testing Laboratories".

<sup>502</sup> ASTM D6792–07, Standard Practice for Quality System in Petroleum Products and Lubricants Testing Laboratories<sup>1</sup>.

*Aromatics in Gasoline Criterion:* We proposed use of the repeatability standard deviation for D1319–10 to set the precision criteria for aromatics in gasoline (78 FR 29958). As previously explained, in response to comments received on proposed requirements for precision criteria for method-defined parameters, such as olefins in gasoline, the Agency is finalizing regulations for the use of the TPI in ASTM D6792 because we believe that it sets minimum site precision performance criteria based

on test method reproducibility (R) and the Precision Ratio (PR) of the published test method. Additionally, as also previously explained, consistent with our proposal to afford the regulated community the use of the most current version of test methods, we are updating the aromatic in gasoline test method ASTM D1319 to the 2013 year version, as discussed in Section VI.A.1.a.iii. Thus, the reproducibility of ASTM D1319–13 should be utilized in setting the precision criterion. In today's action,

the Agency is finalizing precision criteria for aromatics in gasoline that is based on the TPI in ASTM D6792 TPI. Thus, for example, the reproducibility is 3.7, and the precision criterion is 0.3 times 3.7 or 1.11 Vol. % for a test fuel with aromatics at 32 Vol. %.

Table VI–5 provides the TPI in ASTM D6792 TPI for setting the aromatics precision criterion along with the use of ASTM D1319–13's reproducibility.

TABLE VI–5—METHOD-DEFINED PRECISION CRITERION FOR AROMATICS IN GASOLINE

ASTM method	Property	Precision ratio (R/r)	ASTM D6792 minimum TPI = (r/R')	Maximum acceptable site precision (R')	Site precision standard deviation qualification = R'/2.77
D1319–13 .....	Aromatics .....	2.8	1.2	0.83R	0.3R

*Oxygen and Oxygenates in Gasoline Criterion:* We proposed use of the repeatability for D5599–00 (2010) to determine the precision criterion for oxygen and oxygenates in gasoline. We explained that for a test gasoline with 3 mass% total oxygen, the repeatability would be 0.083 mass% and the criterion

for precision in this example to be 0.045 mass% (78 FR 29958). As previously explained, in response to comments we received on our proposed precision criteria for method-defined parameters, the Agency is finalizing the use of the TPI in ASTM D6792 for setting precision criteria for method defined

parameters. Thus, for a test fuel with total oxygenate content at 3 mass % total oxygen, the reproducibility would be 0.32, and the precision criterion is 0.3 times 0.32 or 0.10 mass % total oxygen. Table VI–6 provides the TPI in D6792for setting oxygen and oxygenates precision criterion.

TABLE VI–6—METHOD-DEFINED PRECISION CRITERION FOR OXYGENATES IN GASOLINE

ASTM method	Property	Precision ratio (R/r)	ASTM D6792 minimum TPI = (r/R')	Maximum acceptable site precision (R')	Site precision standard deviation qualification = R'/2.77
D5599–00 (2010) .....	Oxygenates .....	6.8	2.4	0.42R	0.15R

For each method defined fuel parameter that lacked alternative test methods we proposed a precision criterion of 1.5 times the repeatability for the designated test method divided by 2.77. We had proposed that a laboratory's standard deviation for the 20 tests could not exceed that value and

still qualify for precision (Table VI–6, 78 FR 29958). As explained above, as it relates to the Agency's response to the proposed precision criterion for method defined fuel parameters, the Agency today is finalizing precision criterion as provided in Table VI–7 for the various method defined fuel parameters lacking

alternatives to the designated test method using the ASTM D6792 TPI approach, except for distillation. The distillation method defined fuel parameter is discussed in further detail below.

TABLE VI–7—METHOD-DEFINED PRECISION CRITERION FOR FUEL PARAMETERS LACKING ALTERNATIVES TO THE DESIGNATED TEST METHOD

Test method	Property	Precision ratio (R/r)	ASTM D6792 minimum TPI = (R/R')	Maximum acceptable site precision (R')	Site precision standard deviation qualification = R'/2.77
D5191–12 .....	RVP .....	1.9	1.2	0.83R	0.3R
D3606–10 .....	Benzene .....	4.6	2.4	0.42R	0.15R
D1319–13 .....	Aromatics in Diesel .....	2.8	1.2	0/83R	0.3R

With regard to distillation properties, (which is one of the parameters lacking alternatives to designated test methods), several commenters, including API and AFPM, recommended the use of ASTM D86–07 for setting the precision

criterion for distillation properties. According to these commenters, the precision criterion as published in later year versions of ASTM D86 is not consistently supportable by actual ASTM ILCC program data. As support,

they referenced Note 31 of the current ASTM D86 test method.<sup>503</sup> They

<sup>503</sup> Note 31 of the current ASTM D86 test method reads "NOTE 31— A new inter laboratory study is being planned to address concerns that laboratories

commented that a plausible explanation for this is that the interlaboratory study (ILS) used to derive the current precision criteria required several runs on the ILS material to select heating profile, and hence does not reflect how the method is actually conducted in a routine production environment. In addition, the ILS study sample set may not adequately cover the range of available real world production gasoline. They also stated that there is general consensus that the precision of this test method is sensitive to the slope of the boiling curve; hence, a constant precision as articulated in the cited

ASTM D86–11, a method may not be appropriate as a one-size-fits-all measure for gasolines with different matrices and volatility properties for winter as compared to summer fuels. According to commenters, directionally, and based on on-going discussions with ASTM, it would appear that the ASTM test method precision may revert to a boiling curve slope based approach, similar to ASTM D86–07. They further commented that for gasoline containing ten volume percent ethanol (E10), the boiling curve slope and hence precision is impacted by the location of the azeotrope point relative to the

distillation points of interest (T<sub>10</sub>, T<sub>50</sub> and T<sub>90</sub>).<sup>504</sup> Both API and AFPM also commented that the precision function as stated in ASTM D86–07 is a more realistic representation for E–10 gasoline precision with different fuel matrices. Finally, API and AFPM expressed concerns on the use of ASTM D86–11a precision criteria and the proposed precision qualification of 1.5r/2.77, which they described as too restrictive. Both API and AFRPM provided fuel producer control chart data as an example, which is reproduced in Table VI–10.<sup>505</sup>

TABLE VI–8—API & AFPM EXAMPLE OF ASTM D86–11a FUEL PRODUCER CONTROL CHART DATA

	IBP	E10	E50	E90	FBP
Avg F .....	103.65	151.32	224.88	351.44	417.16
Stdev F .....	1.93	1.66	1.36	1.22	2.66
Avg C .....	39.81	66.29	107.16	177.47	213.98
StDev C .....	1.07	0.92	0.75	0.68	1.48
EPA precision criteria .....	1.54	0.72	0.40	0.97	1.80

After reviewing these comments and especially data set out in Table VI–8, we agree that our proposed distillation precision criterion would likely be too restrictive, especially for the distillation point of E50. Accordingly, in a change from proposal and in response to these comments and additional data, the Agency is finalizing precision criterion for the gasoline distillation parameter based on 0.3 times the automated reproducibility of ASTM D86–07 instead of ASTM D86–11a. Table VI–9 provides the precision criterion for the gasoline distillation method defined fuel parameter.

TABLE VI–9—METHOD-DEFINED PRECISION CRITERION FOR GASOLINE DISTILLATION BASED ON 0.3 TIMES THE AUTOMATED REPRODUCIBILITY OF ASTM D86–07—Continued

Percent Evaporated Point	0.3* Reproducibility (°C)
	Where S <sub>c</sub> is the average slope (or rate change) of the gasoline distillation curve as calculated in accordance with Section 13.5 of ASTM D86–07.

average measurement of the fuel closest to the applicable standards (or to the average value for the fuel type in the complex model) and the robust mean for that fuel obtained by all of the non-outlier labs in the program. We further proposed that this difference would be standardized by expressing it in robust standard deviation units. These standardized ILCC differences would be put into a moving average with a span of, say, 5 months. We proposed to set the standard so that the instrument's moving average would be within the central 50% of the distribution of participating designated method labs. We also reasoned that because a robust standard deviation is used by the ILCC program this percentage will have to be approximate (78 FR 29958).

TABLE VI–9—METHOD-DEFINED PRECISION CRITERION FOR GASOLINE DISTILLATION BASED ON 0.3 TIMES THE AUTOMATED REPRODUCIBILITY OF ASTM D86–07

Percent Evaporated Point	0.3* Reproducibility (°C)
Initial Boiling Point ....	0.3 * 8.5.
10 Percent Evaporated.	0.3 *(3.0 +2.64*S <sub>c</sub> ).
50 Percent Evaporated.	0.3*(2.9+3.97*S <sub>c</sub> ).
90 Percent Evaporated.	0.3*(2.0+2.53*S <sub>c</sub> ).
Final Boiling Point .....	0.3*10.5.

*Accuracy Qualification:* At proposal, we also explained that test methods used to measure method-defined parameters would likely fall into three separate tracks: reference installations of designated methods intended for use in qualifying alternative methods; designated method installations intended for ordinary production measurements; and non-designated methods. We proposed and sought comments on requirements that reference instruments must be shown to have been near the middle of the distribution of the industry monthly inter-laboratory crosscheck program (ILCC) for at least five months prior to application. We also proposed that laboratories would specifically compute the difference between the instrument's

Several commenters, including API and AFPM commented on the proposed requirements for reference installations of method defined fuel parameters used to qualify other method defined test methods. These comments and our response to these comments are discussed in further detail below.

At proposal we discussed the role of Voluntary Consensus Bodies in qualifying alternative analytical test methods as well as the use of reference materials in qualifying and maintaining such test methods. We requested comments on the appropriateness of using three types of standard reference materials for accuracy and on their

are not able to meet the precision for percent evaporated temperature at fifty percent.”

<sup>504</sup> The azeotrope point is a function of the base stock gasoline composition, and therefore can vary with different fuel matrices.

<sup>505</sup> The raw data supporting the control data is supplied by API and AFPM in docket EPA–HQ–OAR–2011–0135.

applicability in the qualification process and statistical quality control process of analytical test methods. Specifically, we proposed use of the following: (1) Gravimetric standards, (2) Consensus named fuels (e.g., gasoline or diesel fuels), and (3) Locally named standards. For a complete discussion of these issues see 78 FR 29958–29960. All comments received were in support of the use of these kinds of reference materials in the qualification process and statistical control program.

d. Qualification criteria for designated method installations used to qualify method-defined parameter instruments

We proposed the following requirements for designated test method installations (also known as are reference installations) that would be used to qualify method-defined parameter instruments. We explained that these reference installations would be used to evaluate the accuracy of other alternative test methods and to establish correlation equations, and as such that we believed that they should be held to higher standards.

First, we proposed that reference instruments must meet precision qualification requirements that are similar to the criteria set forth in the non-road diesel sulfur rule. As explained earlier, that rule imposed a maximum value for the standard deviation<sup>506</sup> of a series of at least 20 measurements over at least 20 days on a single fuel under site precision conditions. Specifically, the diesel rule used 1.5 times the repeatability standard deviation (ASTM “ $r$ ”/2.77) of what was the least precise of the then-allowed methods. We proposed that for those method-defined parameters, shown in Table VI–6 of the proposed preamble, lacking currently allowed alternatives to their designated methods, the precision criteria would be based on the fuel parameter’s designated test method. At proposal, we also explained that in each case the precision criterion is determined by (“ $r$ ”/2.77) times 1.5 where “ $r$ ” is the ASTM repeatability determined for the particular fuel that is being used for the purpose of demonstrating the test method’s precision (79 FR 29960).

As previously discussed, the Agency received comments that were not in support of extrapolating the same precision qualification criteria for absolute fuel parameters, which is based on published method repeatability ( $r$ ) of the applicable fuel parameter times 1.5

<sup>506</sup> Where the standard deviation is estimated from a sample of the population (formula uses “ $N-1$ ” in the denominator).

and dividing by 2.77, to precision criterion of method defined parameters. As previously explained, these commenters stated that the precision criteria of method defined parameters are sensitive to the matrix of the fuel. This degree of sensitivity to fuel matrix effects is different for different test methods, techniques, and instrumentation that claim to measure the same method defined fuel property. Also, commenters recommended that the precision standard deviation qualification criterion for method defined parameters be based on a TPI as described in ASTM D6792.<sup>507</sup> As previously explained, the Agency has evaluated ASTM D6792 and agrees that the precision qualification criterion for method defined parameters be based on a TPI as described in ASTM D6792. Thus, in a change from proposal, we are finalizing requirements for reference instruments to meet precision qualification requirements as discussed above for their respective fuel parameter in Table VI–4 through Table VI–9 of this preamble.

Second, we proposed that reference instruments must be shown to be near the middle of the distribution of the ILCC program for at least the five months prior to application.<sup>508</sup> We proposed requiring laboratories to specifically compute the difference between the instrument’s average measurement of the fuel closest to the applicable standards (or to the average value for the fuel type in the complex model) and the robust mean for that fuel obtained by all of the non-outlier labs in the program. We further proposed that this difference be standardized by expressing it in robust standard deviation units. We also proposed that these standardized ILCC differences would be put into a moving average with a span of, say, 5 months. We proposed to set the standard such that the instrument’s moving average would be within the central 50% of the distribution of participating designated method labs. We explained that because a robust standard deviation is used by the ILCC program this percentage would have to be approximate. We further explained that such lab-specific qualification would be outside of the normal qualification of a lab for making regulatory measurements for certifying

<sup>507</sup> ASTM D6792–07, entitled, “Standard Practice for Quality System in Petroleum Products and Lubricants Testing Laboratories”.

<sup>508</sup> There may be an alternative to this measure to be had from the D6299–10<sup>01</sup> calculations, so that we could require that the instrument be doing SQC and having a certain quality of performance. This could reduce the burden of calculations and align this requirement better with the NTTAA.

fuel and would pertain only to use of the instrument in certifying other methods. In essence, these designated method installations would serve as surrogates for the gravimetric standards that cannot be used in qualifying alternative methods for method-defined parameters (79 FR 29960).

Both API and AFPM stated that this requirement would be feasible for a single entity wishing to qualify alternate test methods under ASTM D6708 by using a single reference installation; however, they described the requirement as overly restrictive in other instances. Based on a workup, provided as a separate attachment to their comments<sup>509</sup>, of the proposed requirements using ASTM D5599 Total Oxygen results on eleven RFG distributions, RFG1205 through RFG1303, they showed that less than fifteen percent of the participants met the proposed EPA requirement of staying within the central 50 percent for 5 successive exchanges. Therefore, they suggested a requirement of 3 out of 5 successive exchanges staying within the middle 50 percent of the distribution of measurements on the ILCC program would be more realistically achieved in practice. After reviewing these comments and data, the Agency agrees that setting a requirement of 3 out of 5 successive exchanges to stay within the middle 50% of the distribution of measurements of the industry monthly ILCC program for at least five months is more appropriate and achievable as compared to 5 out of 5 successive exchanges staying within the middle 50% of the distribution of measurements of the ILCC for at least five months. Another commenter recommended the option of using other crosscheck programs besides those from ASTM, and suggested that EPA revise criteria for the reference installations at 40 CFR 80.47(k)(2) to also refer to use of commercially available monthly ILCC. The Agency agrees that the regulated community should be able to use both commercially available and industry monthly ILCC, and has made this change to 40 CFR 80.47(k) to afford this flexibility. Therefore, in a change from proposal, and in response to these comments, the Agency is setting a requirement that a reference installation of the designated test method must be shown to be within the middle 50% of the distribution of measurements for 3 out of 5 exchanges of either the industry

<sup>509</sup> For a description of workup and spreadsheet associated with these comments, see attachment No. 4 in Docket number EPA–HQ–OAR–2011–0135–4276–A5.pdf and attachment No. 5 in EPA–HQ–OAR–2011–0135–4276–A6.pdf.

or commercially available monthly ILCC program for at least five months.

Another commenter suggested that EPA should require applicants to submit control charts showing a record of in-control operation for at least five months provided that: (1) Regular maintenance and/or re-calibration conducted during the 5 month in-control qualification period is considered as part of in-control normal operation, and (2) the clock for the 5 month period does not re-start (in other words the system is still considered to be in-control) if an assignable cause for out of control is found, mitigated, and the system is brought back in-control during the period that the reference installation is attempting to meet the 5 month in-statistical-control requirement. The Agency agrees with these two conditions and in a change from our proposal, we are finalizing regulations that would allow systems meeting these two conditions to be in-control with respect to the 5 month in-statistical-control requirement. Finally, for reference installations, we proposed that the reference instrument must be shown to be in statistical control, as provided for in ASTM D6299–10<sup>e1</sup>, comply with applicable SQC procedures as well as have control charts showing a record of in-control operation for at least five months. We explained that while these requirements would likely impose a delay between instrument setup and the ability to qualify as a reference installation we believed that any delay would be necessary to demonstrate the stability of these critically important installations. We also reasoned that we expected no lack of facilities capable of meeting these standards considering the number of long-established installations of these designated methods.

API and AFPM disagreed with this requirement and stated that summary statistics (mean and standard error = standard deviation/square root [no. of results]) from ILCC program data can be used as is, i.e., without imposing the reference installation criteria to conduct an ASTM D6708 assessment on VCSB alternate test methods, provided that the number of non-outlying results is greater than 16 for both designated and alternate methods. According to both commenters, this is the current de facto methodology for determination of ARV of check standards as specified in ASTM D6299, clause 6.2.2.1 and Note 7. Both commenters also suggested that using ASTM D6299 for establishing ARV would be consistent with OMB Circular 119. They noted also that ASTM ILCC program data for the

method-defined parameters of interest exceeds this number (16) significantly.

API and AFPM also commented that it is neither necessary nor statistically justified to apply the reference installation precision and middle 50 percent criteria to the ILCC program data for designated test method because the relevant ILCC program statistics are calculated using outlier-free data, and the number of data points is large, hence providing a better statistical sample of the laboratory population. According to them, the mean calculated using the full ILCC program outlier-free data set is a more accurate representation of the population parameter ( $\mu$ ) than the mean calculated using only the middle 50 percent. They noted the standard error for the arithmetic mean calculated using the full ILCC program data set is significantly reduced due to the square root [number of non-outlying results] term in the denominator for calculation of standard error. Both API and AFPM also urged EPA to clearly state that the use of ILCC program data as described above is suitable for an ASTM D6708 assessment of VCSB alternate test methods. EPA agrees that the use of ASTM ILCC program data is suitable for an ASTM D6708 assessment of VCSB alternative test methods, provided that the number of non-outlying results is greater than 16 for both designated and alternate methods. In these situations where VCSB ILCP data is utilized during an ASTM D6708 assessment, the reference installation criteria provided in the regulations will not apply, rather a VCSB will have the flexibility of utilizing the VCSB ILCC program data to conduct an ASTM D6708 assessment. The Agency has made these changes in the final regulations to reflect these comments.

Finally, API and AFPM noted that the current “robust” outlier treatment methodology for the ASTM CS92 ILCP program will be replaced with a statistically more rigorous approach using the Generalized Extreme Studentized Deviation (GESD) technique. Thus, they suggested that EPA remove the term “robust” from the preamble and regulations wording. EPA agrees with the comment and has removed “robust” from the final regulations wording.

#### e. Qualification Criteria for Designated Test Method Installations that are “Method-Defined” Parameters Instruments and Not Used To Qualify Other “Method-Defined” Methods

At proposal, we explained that refiners, importers and oxygenate blenders producing gasoline and diesel fuel are required to test these fuels to

determine the levels of various specified parameters. A designated test method is associated with each parameter to be tested (except for sulfur concentration in ultra-low sulfur diesel fuel, which must meet performance-based requirements)<sup>510</sup> in 40 CFR part 80. Table VI–5 of the proposed rule preamble listed the fuel parameters and their corresponding designated test methods. We proposed that installations of designated methods must maintain records and meet certain statistical quality control requirements. We explained that requiring all installations of all methods, including existing designated method installations, to implement statistical quality control, would likely suffice to homogenize and improve measurement quality in these already-stable and standardized methods (78 FR 29961).

#### f. Qualification Criteria for Method Defined Parameter Instruments Other Than Designated Test Methods

With regard to method-defined parameters, the Agency today is finalizing two options for qualification of alternative test methods. The first option, known as the VCSB approach, allows for qualifying methods that have been sponsored and published by a voluntary consensus standards body, such as ASTM International. The second option, known as the non-VCSB approach, involves qualification for a laboratory that has developed its own analytical test method but has decided not to offer it for evaluation and establishment through a VCSB-based organizational process. At proposal, we explained that both options would require the candidate method to have a precision criterion that is at least equal to that of the designated analytical test method (though not defined in precisely the same way). We also proposed to require that the alternative method must also be capable of close correlation with the designated method for the parameter such that the refiner may use the alternative method results to produce predicted designated method results that it can subsequently use in demonstrating compliance with the applicable fuel composition or performance standards (78 FR 29961).

Consistent with our proposal, we are finalizing the following criteria for both the VCSB and non-VCSB approaches to qualify method-defined instruments that are discussed in further detail below.

<sup>510</sup> See 40 CFR 80.580, 40 CFR 80.584 and 40 CFR 80.585.



i. Qualification Criteria for VCSB Method-Defined Parameter Test Methods

For methods that have been sponsored and published by a VCSB, such as ASTM, we expect that at a minimum, the VCSB must have fully described the analytical test method, so that it is replicable in many different laboratories and its operation may be understood by a technician. (We continue to consider publication of a method by a VCSB organization such as ASTM as meeting this criterion.) The VCSB must have tested the candidate method in a round robin program against the designated method, must have published a determination that the method meets the criteria specified in the discussion below, and must have published the information necessary to correlate the alternative method to the designated method. Consistent with our proposal, a VCSB-based candidate alternative analytical test method need not be qualified separately in each laboratory that adopts it. This is because by the time such a test method has been through the extensive development process typically required by a VCSB, the method's procedures would have been exhaustively described. At this point there will be little uncertainty about how the analytical test method is to be applied, and it will have been implemented in a variety of different laboratories and used on a variety of different types of fuels. Therefore, we continue to believe that the VCSB-based process gives EPA some confidence that the analytical test method is likely to be stable in use and can be implemented with very little ambiguity regarding instrumentation, materials, and procedures. Moreover, VCSB method evaluation protocols have been established; including a protocol for comparing methods provide means for establishing a VCSB alternative method's precision parity with the designated method for the parameter and for determining whether the alternative method can be adequately correlated with the designated method.<sup>511</sup> Further, consistent with our proposal, VCSB method-defined test methods must utilize ASTM D6708 to determine if a correlation equation is necessary.

<sup>511</sup> ASTM D 6708–08, entitled, Standard Practice for Statistical Assessment and Improvement of Expected Agreement Between Two Test Methods that Purport to Measure the Same Property of a Material.

ii. Qualification Criteria for non-VCSB Method-Defined Parameter Test Methods

Consistent with our proposal, a candidate method that follows the non-VCSB-based route for qualification must be qualified independently by each analytical laboratory that wishes to adopt the method. We proposed the following seven qualification criteria for non-VCSB method-defined parameter test methods.

First, the Agency proposed to require a complete operational description of the non-VCSB test method, as described above in Section VI.A.2.c.iii of this preamble. We explained that the operational description must be thorough enough that a person lacking expertise in the operation of the test instrument would be able to replicate its results.

Second, the Agency proposed that the candidate non-VCSB test method be tested on a range of fuels<sup>512</sup> and by a qualified reference installation of the applicable designated test method.

Third, the Agency proposed that the specific laboratory using the candidate non-VCSB test method must statistically establish through application of ASTM D6708–08 that the candidate method measures the same aspect of samples as the applicable designated test method.

Fourth, the Agency proposed to disqualify non-VCSB test methods with important sample-specific biases (matrix effects) that cannot be considered as random as determined by ASTM D6708–08. We explained that it was possible that a non-VCSB test method suspected by the applicant of being highly matrix-sensitive may be qualified on a narrowly circumscribed range of fuels (which must, meet the D6708 statistical variability criteria). In this situation, types of fuels used for qualification and the method that is to be approved must be specified in the method description. Fuels outside of this scope would have to be analyzed for regulatory purposes by some other method. The Agency believes that any restriction on the scope of fuels to be used in qualifying a method must be accompanied by a discussion of how the applicant plans to screen samples for conformity to the scope.

Fifth, the Agency proposed that precision qualification be conducted in the form of cross-method reproducibility of the candidate and applicable designated test method,

<sup>512</sup> Fuels, either consensus named fuels or locally named reference materials, used must be typical of those to be analyzed by the facility in practice and must meet the data requirements (variability, etc.) of ASTM D6708–08.

where the “cross-method reproducibility” must be equal to or less than 70 percent of the published reproducibility of the applicable designated test method.

We explained that the Agency believes that when ASTM D6708–08 is used in this manner (without joint round robin data) the cross-method reproducibility (Rcm) output by the program is not really a reproducibility in the usual sense, but rather indicates the expected value with uncertainty of the differences between the designated method and qualification candidate method. We believe that when used this way, Rcm from ASTM D6708–08 is more analogous to a site precision than to an inter-laboratory reproducibility. For a detailed description of cross-method reproducibility (Rcm) see 78 FR 29962.

Sixth, the Agency proposed that the applicant would demonstrate, through the use of ASTM D6708–08, whether a correlation to the designated test method is necessary. We explained that ASTM D6708–08 could also be used to determine whether the candidate methods results are either null compared to the designated test method and thus, needs no adjustment or correlation, or whether some correction or correlation equation is required so the candidate method may predict designated method results. We proposed the use of ASTM 6708–08 for corrections, if it is determined that the candidate method requires such a correction to predict designated test method results. The Agency proposed that the correction would be applied to the candidate instruments output to obtain measurements results for regulatory purposes.

Finally, we proposed to require that applicants for non-VCSB test methods secure an independent third party oversight and audit review of the data generated and used to qualify non-VCSB test methods. We proposed that the independent third party would provide an overall assessment of the analytical technique and methodology and discuss any limitations in the scope of the method, as well as attest that all requirements for non-VCSB test method qualification have been satisfied. The Agency explained that this requirement would provide additional assurance that a non-VCSB test method is found to be adequate in use for compliance (78 FR 29961–29962).

We received comments in support of the proposed qualification criterion for non-VCSB Method-Defined Parameters. One commenter recommended allowing third-party oversight service providers that have good working knowledge of

ASTM D6708 and ASTM D6299 in addition to degrees in Chemistry or Statistics. Further, they believed that limiting the third party oversight qualification to only U.S. degree holders would exclude non-U.S. degreed subject matter experts with equivalent knowledge and qualification. They suggested that rule language be expanded to include non-U.S. equivalent degreed or industry recognized subject matter experts. Another commenter recommended professional chemical engineers with demonstrated experience in analytical techniques as an option to chemists and statisticians because, according to the commenter, chemical engineers have a strong background in chemistry, and based on trends within industry they would also have experience in statistical process control. The Agency agrees with these comments and has amended the final regulations to include chemical engineers and non-U.S. degreed subject matter experts with equivalent knowledge and qualifications as third party oversight service providers. Rule revisions have also been made to reflect the recommendation that all of these candidates should also have a good working knowledge of ASTM D6708 and ASTM D6299.

Consistent with our proposal, the Agency today is finalizing the qualification criteria for non-VCSB method defined fuel parameters with the few changes in response to comments as discussed above.

g. Statistical quality control: how can we ensure that test methods continue to deliver quality measurement in practice?

Today's final action also includes a statistical quality control (SQC) program that must be applied to any analytical test method used in the regulatory programs covered by this final action. Consistent with our proposal, every laboratory that uses test instruments to measure fuel parameters to satisfy EPA's reporting or recordkeeping requirements must implement and maintain a basic SQC program. Unlike the qualification criteria requirements, where only one set of essentially identical instruments implementing the same method in a laboratory must qualify, every laboratory must have a separate SQC program for each instrument used to make measurements for reporting or recordkeeping purposes.<sup>513</sup>

<sup>513</sup> Such SQC programs are already an established part of VCSB protocols for analytical laboratory operation (as indicated by such practices as ASTM's D6299-10<sup>e1</sup>) and are likely to be part of most laboratories' "standard operating procedures." Thus, such a requirement very likely adds little or nothing

Consistent with our proposal, we are also finalizing requirements that provide implementation of a SQC program by a laboratory as a defense in any subsequent enforcement actions where measurements are in issue. Today's requirements also reflect our proposal to adopt a subset of SQC procedures that are already widely in use from ASTM D6299-10<sup>e1</sup>. We continue to anticipate that the measures we are finalizing would not require the generation of much additional data by the laboratory that employs them and that the SQC program would improve the quality of measurement among those laboratories that adopt such measures. These SQC procedures used by laboratories would ensure that the test methods they have qualified and the instruments on which the methods are run yield results with appropriate accuracy and precision, e.g., that the results from a particular instrument does not drift over time to yield unacceptable values. The finalized minimum specific SQC requirements for laboratories for absolute parameters, VCSB-approved methods used to measure method-defined parameters, and non-VCSB proprietary methods used to measure method-defined parameters are discussed in further detail below.

We proposed similar precision and accuracy SQC requirements for each instrument used to measure absolute and VCSB-approved and non-VCSB proprietary methods for measuring method-defined parameters in the laboratory. We proposed that every instrument would test a quality control (QC) material<sup>514</sup> either once per 20 production tests or once per week and maintain both an "I" chart<sup>515</sup> and an "MR" chart.<sup>516</sup> We proposed that any violation of the control limit would be investigated by laboratory personnel, corrective action taken as required, and records kept of the incident for a period of 5 years. We also proposed allowing used of ASTM D6299-10<sup>e1</sup> procedures for transitioning from one batch of QC material to another.

in the way of burden for most laboratories. Laboratories that lack such programs and would have to expend significant effort to create them are those most at risk for poor measurements and for which the effort is most easily justified.

<sup>514</sup> See ASTM D6299-10<sup>e1</sup>, paragraph 3.2.3 for a definition and Section 6 for guidance, selection, construction, handling, storage and use of reference material samples.

<sup>515</sup> See ASTM D6299-10<sup>e1</sup>, section 7 and Section A1.5.1 for chart construction and usage, including criteria for deciding upon corrective action.

<sup>516</sup> See ASTM D6299-10<sup>e1</sup>, Section A1.5.2 for chart construction and usage. Any exceedance of the control limit should be investigated.

We also proposed use of Annex A1.9, entitled "Q-Procedure", of ASTM D6299-10<sup>e1</sup> for validating new QC material. We proposed that when QC material is soon-to-be-depleted, that a new batch of QC material would be prepared and its value compared to the old QC material on a chart. We explained that the new batch of QC material would be tested concurrently with the soon-to-be-depleted old QC material. And the results would be plotted from the "old" and "new" QC materials on respective charts, and if no special-cause signals are noted, then the result for the new material would be considered valid (78 FR 29963-64).<sup>517</sup>

We received comments in support of all these requirements with the exception of requirements for both QC verification and validation of new QC materials. One commenter recommended that test facilities conduct verification of new QC material three times a year rather than on a quarterly basis so that this requirement is aligned with ASTM International ILCC program sample cycle frequency. The Agency agrees with this comment and has made rule language changes to reflect that test facilities can conduct verification of new QC material three times a year in order to align this requirement with ASTM ILCC program sample cycle frequency. Additionally, the Agency envisions this change will help encourage the participation of ASTM Subcommittees in the PBATM approach for their respective alternative test methods.

One commenter noted that the Q-procedure in ASTM D6299, which relates to the handling of QC material batch transition, is intended to be an alternative approach to the concurrent testing (overlap) protocol. They suggested the option of using either one of the two procedures, and not both the Q-Procedure and I-procedure as we had proposed. According to the commenter, the Q-procedure is technically equivalent to the I-procedure. They also suggested that for sites opting to use the Q-procedure, the very first run on the new QC batch should be validated by either an overlap in-control result of the old batch, or by a single execution of an accompanying SRM. Then the new result would be considered validated if the single result of the SRM is within the established site precision (R') of the ARV of the SRM. The Agency agrees that the Q-procedure is functionally equivalent to the I-procedure and that

<sup>517</sup> See ASTM D6299-10<sup>e1</sup>, Annex A1.9 Q-Procedure. Procedures differ depending whether an I-chart, MR chart, EWMA chart, Q-chart or a combination of these charts are utilized by the laboratory.

laboratories should be given the flexibility to use either of these two procedures instead of both procedures, as proposed. The Agency also agrees that for sites opting to use the Q-procedure, the very first run on the new QC batch should be validated by either an overlap in-control result of the old batch, or by a single execution of an accompanying SRM. The new result would be considered validated if the single result of the SRM is within the established site precision (R) of the ARV of the SRM. In response to these comments, we have revised our proposed regulations to reflect these suggested changes.

We proposed requiring every instrument to test a commercially available gravimetric "SRM" ("check standard" as defined in ASTM D6299–10<sup>e1</sup>) on a quarterly basis. We explained that the absolute difference between the mean of multiple back-to-back tests of the SRM and the ARV of the SRM that is greater than 0.75 times the published reproducibility of the test method must be investigated by laboratory personnel, appropriate action taken, and records kept of the incident and investigation. We proposed to require that records of the SRM measurements and investigations into any exceedance of these proposed criteria must be kept for a period of 5 years. Additionally, we proposed to require laboratories to pre-treat and assess results from the check standard testing after at least 15 testing occasions,<sup>518</sup> construct "MR" and "I" charts<sup>519</sup> with control lines, and maintain control charts, logging, investigating, and correcting underlying causes of any control limit violations as discussed in ASTM D6299–10<sup>e1</sup>. We proposed to require that records of such incidents and the underlying control charts must be kept by the facility for a period of 5 years. (78 FR 29963.)

One commenter suggested that the expanded uncertainty of the ARV should be incorporated into the accuracy qualification criterion as follows: Accuracy qualification criterion = square root [(0.75R)<sup>2</sup> + (0.75R) <sup>2</sup>/L], where L = the number of single results obtained from different labs used to calculate the consensus ARV. According to the commenter, this is because the standard error of the ARV in the consensus-named fuels may not in all

cases be negligible when compared to 0.75R. The Agency agrees with this comment and has incorporated the standard error of the ARV in the consensus-named fuel into the accuracy qualification criteria for determining when appropriate action should be taken during an SQC investigation.

Today, the Agency is also finalizing the Statistical Quality Control requirements for absolute fuel parameters, and VCSB-approved and non-VCSB proprietary methods that are used for measuring method defined parameters, as proposed. Consistent with our proposal, the Agency is also finalizing requirements allowing use of either the "I" chart or Q-procedure for validation of new check standards, and the incorporation of the standard error of the ARV in the consensus-named fuel into the accuracy qualification criteria for determining when appropriate action should be taken during an SQC investigation.

#### h. Agency Approval Options

We proposed to require qualification of only proprietary analytical test methods, i.e., non-VCSB test methods for fuel parameters. We also sought comment on whether we should require qualification of all analytical test methods for fuel parameters. The following section contains a discussion of our proposal, as well as our final decision based on the comments received on our proposal.

At proposal, we explained that the approach to performance-based qualification of test methods would go considerably beyond the minimum requirements of the National Technology Transfer and Advancement Act of 1995 in providing flexibility of method choice, and accomplish performance-based qualification without compromising measurement quality. We also reasoned that the primary tools for achieving the latter objective are laboratory-specific qualification of method installations and a requirement for across-the-board SQC. We also explained that while EPA would benefit from PBMS, when finalized, by no longer having to evaluate new alternative measurement methodologies, this benefit would likely not offset the substantial and unpredictable resource costs involved in administering a qualification process and providing infrastructural support for laboratories' SQC programs (78 FR 29964–29965).

We proposed qualification requirements for only non-VCSB test methods for fuel parameters. We also proposed excluding designated test methods that have been in operation 6

months prior to finalizing this rule, as well as test methods that are developed by VCSBs, like ASTM International or the International Organization for Standards (ISO) from qualification requirements. We had also proposed subjecting laboratories that develop test methods but decide not to offer them for evaluation and establishment through a VCSB-based organizational process to qualification requirements.<sup>520</sup> We proposed that all test methods subject to qualification requirements must be qualified independently by each analytical laboratory that wishes to adopt the test method. We explained that this is because such a test method would not have been shown to be capable of accurately measuring the fuel parameter in different laboratories and across a variety of fuel matrices. We also explained that the precision for the candidate analytical test method must be established by a medium-term series of measurements on production fuels, the workability of the test method must be verified by at least on other laboratory, and its accuracy must be demonstrated by direct correlation to the designated analytical test method for the particular fuel parameter.

For test methods that have been sponsored and published by a VCSB such as ASTM or ISO, we proposed that the test method must be fully described so that it is replicable in many different laboratories and so that its operation may be understood by a technician. We also proposed that the VCSB must have tested the candidate test method in a round robin program against the designated test method, must have published a determination that the test method meets the performance criteria as discussed, and must have published the information necessary to correlate the alternative test method to the designated test method.<sup>521</sup>

We also proposed that a VCSB-based alternative test method need not be qualified separately in each laboratory that adopts it. We explained that this is because the test method's procedures would have been exhaustively described by the time the VCSB-based candidate alternative test method has been

<sup>520</sup> Reasons for not submitting a local method for VCSB evaluation may include the proprietary nature of software or apparatus or the fact that the method is highly matrix-sensitive and not likely to perform consistently when used to analyze fuels with widely varying properties. EPA recognizes that matrix sensitivities may be subtle and methods with such characteristics may have been sponsored and published by VCSB's.

<sup>521</sup> This first approach assumes that a single such equation can be used for all labs using the method, an assumption that may not always hold true. The more detailed discussion of the two approaches that follows this introduction explores this problem.

<sup>518</sup> See ASTM D6299–10<sup>e1</sup>, Section 8.2 (pretreatment) and Section 8.4 (assessment). Procedures differ depending upon whether a single check standard is used for multiple testing occasions or multiple check standards must be used.

<sup>519</sup> See ASTM D6299–10<sup>e1</sup>, Section 8.4 and appropriate Annex sections for chart construction and guidance.

through the extensive development process typically required by a VCSB. We also reasoned that at this point there would be little uncertainty about how the analytical test method is to be applied, and it would have been implemented in a variety of different laboratories and used on a variety of different types of fuels. We continue to believe that the VCSB-based process gives some confidence that the analytical test method is likely to be stable in use and can be implemented with very little ambiguity regarding instrumentation, materials, and procedures. As also explained at proposal, VCSB method evaluation protocols have been established, including a recently developed protocol for comparing methods, which provide means for establishing a proposed VCSB alternative method's precision parity with the designated method for the parameter<sup>522</sup> and for determining whether the alternative test method can be adequately correlated with the designated test method.<sup>523</sup>

We also recognized that imposing qualification requirements on existing test methods developed by a VCSB without adequate lead time may be problematic. We thus proposed to give methods published and in operation upon publication of the Tier 3 proposed rule (May 21, 2013) a grace period of one year from the effective date of a final rule to comply with today's requirements.

We also proposed to exempt existing (i.e., in use for six months prior to publication of the proposal) installations of designated test methods that are method-defined parameters from the qualification requirement. We reasoned that these installations were stable and capable methods in relatively experienced hands because they are already being used to certify fuels, and that requiring their qualification could be disruptive and burdensome to both their operators and to whomever manages the qualification process. We further reasoned that such installations would not benefit tangibly from this rule (as by obtaining access to a desired new method), but would nevertheless bear a newly-imposed burden.

We also proposed record keeping and retention requirements for both VCSB

alternative and non-VCSB test methods. Parties would need to maintain qualification records for demonstrating compliance for a period of 5 years after they cease use of the particular test method. Parties must also maintain a complete description of the test method and data with statistical analysis that supports its qualification.

We also sought comment on whether the Agency should require qualification of all analytical test method for the fuel parameters of 40 CFR part 80. This would include each designated test method, all alternative test method currently allowed by our regulations, as well as any other analytical test method regardless of whether the test method was developed by a voluntary consensus standards based organization, like ASTM, or if it is a proprietary analytical test method, that is, non-VCSB test method.

We recognized that imposing the qualification requirement on existing and operational installations of all methods without adequate lead time may be problematic. We thus proposed to give laboratories (i.e., those in operation when the proposal was published (May 21, 2013)) a grace period of one year from the effective date of the final rule prior to complying with the requirements being finalized in today's rule. We explained that we believed that a year should be enough time to determine whether an existing test method is likely to qualify or to adopt and qualify a replacement test method if it should fall short. New installations of previously accepted methods, including alternatives, would be required to qualify their laboratory before being put into service just like all other installations of new test methods in a laboratory (78 FR 29964–29965).

All comments received were in support of our proposal to require qualification of only non-VCSB test methods for fuel parameters. We also received several comments requesting a compliance period of 18 months from the effective date of this rule rather than one year. According to commenters, this period of time was needed by the regulated community to help ensure adequate lead time to implement this new performance based measurement system program especially because there of expected modifications based on comments that were received on the proposed PBMS requirements. Thus, there will be a need for further clarification and implementation guidance beyond what was proposed and finalized today. Some commenters noted the discrepancy between the preamble and regulatory text as it related to the proposed exemption for

installations of designated test methods of method-defined parameters that were in use six months prior to publication of the proposed rule. Consistent with our proposal, the Agency today is finalizing requirements for qualification of only non-VCB test methods for fuel parameters, as proposed. We are also finalizing as proposed the exemption of existing (i.e., in use for six months prior to May 21, 2013) installations of designated test methods from today's qualification requirements. Further, in response to comments and in a change from our proposal, we are now providing a compliance period of 18 months from the effective date of this final rule for when these performance based analytical test methods measurement system requirements at 40 CFR 80.47 will be effective.

### 3. Downstream Pentane Blending

Today's action finalizes provisions to allow blender grade pentane to be blended into previously certified gasoline (PCG) downstream of a crude oil refinery.<sup>524</sup> These provisions will become effective June 27, 2014. These provisions that are being finalized today are similar to the long standing provisions for blending butane into gasoline at 40 CFR 80.82, with additional provisions to provide adequate compliance assurance.

Refiners are not able to produce gasoline or BOBs that are as close to the applicable maximum volatility (RVP) standard in a given area as what can be achieved at a terminal through RVP trimming due to spatial and temporal considerations regarding the shipment of gasoline to terminals. Butane is currently blended into PCG downstream of the refinery in order to trim RVP levels closer to the applicable maximum RVP specifications. Butane blenders are required to test the finished gasoline they produce to demonstrate compliance with the maximum RVP requirements. Testing for RVP is quick, and requires relatively inexpensive and easy to operate equipment. Hence, RVP testing can be accommodated at a terminal where small (tank truck sized) batches are continually produced by blending for delivery to retail stations. Testing for other fuel parameters such as sulfur and benzene content requires more costly and technically demanding equipment that cannot readily be accommodated at a terminal. Such testing can also not be completed in a

<sup>522</sup> ASTM D6708–08, entitled, Standard Practice for Statistical Assessment and Improvement of Expected Agreement Between Two Test Methods that Purport to Measure the Same Property of a Material.

<sup>523</sup> ASTM D6708–08, entitled, Standard Practice for Statistical Assessment and Improvement of Expected Agreement Between Two Test Methods that Purport to Measure the Same Property of a Material.

<sup>524</sup> Blender grade pentane refers to pentane that meets the specifications for either commercial grade or non-commercial grade pentane discussed below and as such may be added to previously certified gasoline by pentane blenders meeting the requirements finalized today.

time frame that is compatible with the need for terminals to quickly move product to retailers in order to maintain adequate supply for consumers. These considerations informed the Agency's prior decision to allow butane blenders to primarily rely on testing conducted by the butane supplier (and the producer of the PCG) to demonstrate compliance with gasoline fuel quality requirements other than maximum RVP.<sup>525</sup> The same considerations exist today regarding blending pentane into PCG. Therefore, we are finalizing provisions to allow pentane blenders to also primarily rely on testing conducted by the pentane producer or importer and the producer of the PCG to demonstrate compliance with gasoline fuel quality requirements other than maximum RVP. We are requiring that the test results on the pentane be generated by the producer or importer of the pentane because we believe that it is necessary to identify a specific party that must register with EPA and be responsible for the pentane quality requirements.

The fuels regulations place primary responsibility for sampling, testing, reporting and assuring that gasoline meets applicable fuel standards on refiners. The flexibility that this rule provides to butane blenders and pentane blenders does not shift this primary compliance obligation. The rule does, however, provide a limited flexibility for refiners who add these blendstocks to previously certified gasoline. The agency has provided this limited flexibility because of the unique nature of these blendstocks, and because of additional compliance requirements that are imposed on the manufacturers of these blendstocks and the refiners who use these blendstocks. Refiners who use the special allowance for butane and pentane blending will remain liable for any fuel quality violations, but will be able to rely on sampling and testing from the butane and pentane manufacturer, if all of the requirements of the regulations are met. All other refiners, including blender-refiners, must comply with all of the applicable sampling, testing, reporting recordkeeping and fuel quality standards, and may not rely on test results from blendstock suppliers.

As discussed in Section V.C. of today's preamble, the current butane sulfur cap will also apply to blender grade pentane blended into gasoline by until the implementation of today's Tier

3 sulfur requirements, when a 10 ppm sulfur cap will apply to both butane and pentane blended into gasoline. The benzene, olefins, and aromatics specifications for "commercial grade" and "non commercial grade" blender grade pentane discussed below are similar to the requirements for butane.

We received comments in favor of our proposal to allow pentane blending into PCG. During our discussions with stakeholders following the proposal and from the review of public comments, we became aware of additional potential issues associated with assuring the quality of pentane for gasoline blending beyond those that exist for butane.<sup>526</sup> In response to comments and to further limit variability in pentane quality, C6 and higher hydrocarbons in pentane blended into gasoline must be limited to 5 volume percent or less. We were also made aware of the possibility that parties that handle natural gasoline liquids (NGL) might misinterpret the pentane blending provisions finalized today to apply to natural gas liquids. A pentane stream for gasoline blending does not currently exist, and there are currently varying definitions of NGL, which is sometimes referred to pentanes-plus. There is also concern about potential contamination if the same equipment is used to transport blender grade and NGL. Today's rule finalizes the following additional requirements, that will preclude potential confusion of NGL with blender grade pentane, help ensure that the quality of blender grade pentane is maintained throughout the distribution system, and facilitate EPA enforcement and compliance assurance of the quality requirements for blender grade pentane.

First, producers and importers of pentane for gasoline blending must register with EPA. Such registrations must include sufficient information to demonstrate that the producer or importer will be capable of producing or importing blender grade pentane meeting today's quality specifications and that contamination during distribution to the pentane blender can be adequately limited. Second, producers and importers of pentane for gasoline blending must test each batch of blender grade pentane to demonstrate that the quality requirements are met. Third, producers and importers of pentane for gasoline blending must submit an annual report to EPA that includes batch test data and information on the volume produced or imported. These requirements will enable EPA to

perform effective oversight of entities that produce pentane for use by pentane blenders.

Fourth, pentane blenders must use only blender grade pentane from registered producers or importers. We believe that this requirement will provide additional assurance that pentane blenders are obtaining product only from legitimate producers. Fifth, pentane blenders must conduct periodic quality assurance testing on both the commercial grade pentane and the non-commercial grade pentane that they receive. Sixth, we are requiring a more frequent sampling frequency than is required for butane. For commercial-grade pentane, pentane blenders must sample and test once for every 350,000 gallons of pentane received, or once every three months, whichever is more frequent. For non-commercial-grade pentane, pentane blenders must sample and test once for every 250,000 gallons of pentane received, or once every three months, whichever is more frequent. We believe that the heightened level of concern regarding assuring the quality of pentane used by downstream blenders warrants these additional requirements.

Finally, we are finalizing specific product transfer document and recordkeeping requirements for parties that produce and take custody of pentane for gasoline blending. Entities in the distribution chain for blender grade pentane must maintain records of their quality assurance activities to manage contamination while blender grade pentane is in their custody. We proposed amendments to 40 CFR 80.79 to address the liability and prohibited activities for entities in the blender-grade pentane distribution system. During our review of the regulations finalized today, we noted that such provisions are already covered under existing regulations that pertain to entities in the distribution system for butane used by downstream butane blenders as well as other parties. Therefore, we are not finalizing the proposed amendments to 40 CFR 80.79.

A party that blends pentane into gasoline is a refiner, similar to butane blenders. Similar to the butane blending provisions, pentane blending will not be allowed into RFG or RBOB from April 1 through September 30, or into any RFG or RBOB that is designated as VOC-controlled. Like butane blenders, pentane blenders must test the finished gasoline to ensure that the applicable volatility requirements are met. Consistent with the requirements for butane blenders, pentane blenders will not be subject to other sampling and testing requirements that would

<sup>525</sup> Regulation of Fuels and Fuel Additives: Modifications to Standards and Requirements for Reformulated and Conventional Gasoline Including Butane Blenders and Attest Engagements; Final Rule, December 15, 2005, 70 FR 74552.

<sup>526</sup> See the Summary and Analysis of Comments for this rule for a detailed response to comments on the pentane blending provisions finalized today.

otherwise apply to a refiner, provided that they use blender grade pentane that meets today's specifications and conduct today's specified quality assurance practices.

Testing to demonstrate compliance with gasoline compositional requirements other than maximum RVP will not be required for pentane blender provided that the blender has product transfer documents from the supplier that demonstrate the pentane is "commercial grade". Until December 31, 2016, commercial grade pentane is defined as pentane that test results demonstrate is 95 percent pure and has the following properties: Sulfur  $\leq$  30 ppm, benzene  $\leq$  0.03 volume percent, olefins  $\leq$  1.0 volume percent, aromatics  $\leq$  2.0 volume percent, and C6 and higher hydrocarbon content  $\leq$  5.0 volume percent. Beginning January 1, 2017, a sulfur standard of  $\leq$  10ppm will apply while the other specifications for commercial grade pentane will remain unchanged. Product transfer documents from the supplier demonstrating the pentane is "non-commercial grade" may also be used to demonstrate compliance with gasoline quality requirements other than volatility. Until December 31, 2016, non-commercial grade pentane is pentane that test results demonstrate as having the following properties: sulfur  $\leq$  30 ppm, benzene  $\leq$  0.03 volume percent, olefins  $\leq$  10.0 volume percent, aromatics  $\leq$  2.0 volume percent, and C6 and higher hydrocarbon content  $\leq$  5.0 volume percent. Beginning January 1, 2017, a sulfur standard of  $\leq$  10ppm will apply while the other specifications for non-commercial grade pentane will remain unchanged. As discussed above, producers and importers of pentane for gasoline blending must test each batch of finished gasoline to demonstrate compliance with these quality requirements.

The pentane parameter testing that is required of pentane producer/importers and pentane blenders must be conducted using test procedures that have been approved by the Administrator. No such test procedures are currently approved. As part of their registration requirements, pentane producers and importers must specify the test procedures that they will use to demonstrate compliance with the pentane quality requirements finalized today. EPA will continue to work with industry in establishing test procedures for use in meeting pentane testing requirements.

We believe that the butane blending provisions have reduced the burden of compliance with EPA gasoline quality requirements. We anticipate that expanding these provisions to allow

pentane to be blended into gasoline will further reduce the burden of compliance. The requirement that final blends must comply with maximum gasoline volatility requirements will ensure that the flexibility to conduct downstream RVP trimming will not reduce the environmental benefits of EPA's gasoline quality requirements. Due to its lower volatility compared to butane, larger volumes of pentane than butane can be blended into gasoline while still meeting the gasoline RVP standards. Thus, allowing pentane to be blended into gasoline downstream of the refinery may displace butane blending. Since pentanes have a lower boiling point than butane, this could result in some environmental benefit from reduced vehicle evaporative emissions. A prominent butane blender stated that allowing pentane blending would provide an opportunity to increase domestic gasoline supply which in turn could help reduce gasoline prices.

One commenter requested that the blending flexibility for pentane be extended to other gasoline range hydrocarbons such as heavy naphtha. We disagree. We are not expanding today's provisions beyond pentane. Pentane is a clean burning alkane like butane. The only concern with respect to the effect of downstream pentane and butane blending on vehicle emissions can be addressed through compliance with gasoline maximum volatility requirements. Less is known about the potential impacts on vehicle emissions of the downstream blending of blendstocks other than butane and pentane. We note that such blendstocks can still be utilized by refiners.

Allowing blending of heavier boiling range hydrocarbons, such as heavy naphtha, would also likely raise additional compliance assurance issues. Similar to butane, blender grade pentane requires special pressure vessels for transport, storage, and blending into gasoline due to its relatively high vapor pressure/boiling point.<sup>527</sup> These special equipment and handling needs present a significant barrier to entry into the pentane blending market, thereby limiting the potential number of parties engaged in the market. The substantial investments needed for such special equipment also provides assurance that parties engaged in the pentane blending market will be motivated to comply with EPA requirements. These factors make us confident that the compliance assurance requirements finalized today are

<sup>527</sup> The boiling point of pentane is  $\sim$  97 °F and butane is  $\sim$  30 °F.

sufficient to support provisions for pentane blending. On the other hand, in the case of heavier hydrocarbons that are liquid under ambient conditions, gasoline handling equipment could be used. This would greatly multiply the number of potential parties that could supply product to downstream blenders, thereby substantially increasing compliance assurance concerns. Therefore, we are not finalizing provisions for downstream blending other than those for pentane at this time.

#### 4. Acceptance of Top Tier Deposit Control Test Data

Today's action finalizes the proposed amendments to EPA's gasoline deposit control regulations to accept test data collected for the industry-based "Top-Tier" deposit control program as demonstration of compliance with EPA's intake valve deposit (IVD) and fuel injector deposit (FID) control requirements. The "Top Tier" deposit control gasoline standards developed by four major automakers are based on the premise that a more robust level of the control of vehicle engine and fuel systems beyond that provided by the EPA deposit control requirements is desirable and necessary for current vehicle technology.<sup>528</sup> Several major gasoline marketers have adopted Top Tier for their gasoline. It is widely accepted that conformance with the Top Tier IVD and FID control testing requirements is more challenging than complying with the standard EPA IVD and FID testing requirements. Accepting IVD/FID test data that complies with the Top Tier requirements in place of the standard EPA IVD/FID testing requirements will provide significant savings to industry from reduced deposit control testing while maintaining the emissions benefits of EPA's gasoline deposit control program. These changes are being codified in the regulations at §§ 80.161(b), 80.163(a)(1)(iii), 80.164(a), 80.165, 80.167(a), 80.176, and 80.177.

The comments we received were in favor of the proposal to accept test data that demonstrates compliance with the Top Tier program as alternative compliance data under EPA's deposit control program. Chevron stated that their extensive experience with deposit control and related vehicle/engine performance testing, combined with the vast body of technical literature on the subject, shows that compliance with Top Tier IVD/FID requirements provides improvements in emissions

<sup>528</sup> The industry-based Top Tier deposit control program is discussed at <http://www.toptiergas.com/>.

and performance compared to fuels with deposit control additive levels that merely meet EPA's deposit control requirements. Chevron identified a typographical error in the proposed regulations to codify the Top Tier testing requirements at § 80.177(b)(1)(iv). The proposed regulations stated that test fuel used in IVD testing must contain no less than 240 ppm sulfur. This error is corrected in the regulations finalized today to state that test fuel used in IVD testing must contain no less than 24 ppm sulfur, consistent with the Top Tier deposit control standard.

#### 5. Potential Broader Regulatory Streamlining Through Program Restructuring

The current set of fuel regulations is the result of programs that have been established over the years to reduce emissions from mobile sources. These programs include gasoline volatility (RVP), reformulated gasoline and anti-dumping, sulfur control (which today's Tier 3 program will revise), mobile source air toxics (MSAT1), benzene control (MSAT2), and the renewable fuel standards (RFS). Most of these regulations have been amended numerous times.

The RFG and anti-dumping regulations in particular contain some of the more extensive requirements on sampling, testing, and reporting. They also have some of the more stringent restrictions on gasoline use (e.g., restricting where fuel produced can be sold, what it may be commingled with, etc.). EPA used the RFG and anti-dumping rules as the foundation for many aspects of subsequently developed fuel regulatory programs. However, the subsequent rules, considered as a whole, have supplanted most of the RFG and anti-dumping standards. For this reason, we proposed to streamline the regulations in several places as described above. Initial discussions with fuel industry representatives have indicated that a comprehensive review of the complete set of fuel regulations contained in 40 CFR parts 79 and 80 ("Registration of Fuels and Fuel Additives" and "Regulation of Fuels and Fuel Additives," respectively) of the Code of Federal Regulations could lead to further streamlining of the regulations beyond the streamlining provisions being finalized today. EPA expects that further streamlining would result in more efficient and less costly compliance determinations for affected parties while maintaining the environmental benefits of the programs. However, in many cases such changes

could require not just the removal or streamlining of existing provisions but also the replacement of several provisions with new, less onerous ones that require further development, notice and comment. We intend to continue to seek comment in future actions on potential areas in the fuel regulations that may benefit from such a more comprehensive streamlining effort. For example, it may be possible for the RFG VOC standard to be met if a sufficiently stringent RVP level is attained. Under this scenario, sampling and testing requirements at the refinery would be reduced. Another potential scenario could involve consolidation of some RFG and anti-dumping rules; for example, a single set of rules governing the treatment of downstream ethanol blending and in-use surveys could provide greater efficiency and flexibility regarding fuel distribution.

We received a number of comments supporting the concept of further streamlining in 40 CFR parts 79 and 80, including suggestions for additional areas of the regulations to consider in the future.

#### B. Engine, Vehicle and Equipment Programs Amendments

We are amending several regulatory requirements for motor vehicles and other types of vehicles and engines. These changes are intended to align with the Tier 3 standards and to make various adjustments and corrections to the regulations. We are also removing large portions of obsolete regulatory text and updating cross references accordingly.

##### 1. Fuel Economy Labeling

EPA adopted updated fuel economy labeling requirements in 40 CFR part 600 on July 6, 2011.<sup>529</sup> The label displays a smog rating based on relative emission rates for certified vehicles. With new Tier 3 standards, this rating scale becomes less useful, since the Tier 3 standards disallow certification to half of the existing smog ratings. We are therefore adopting a new transitional smog rating scale starting in model year 2018. Manufacturers choosing to transition to the Tier 3 NMOG+NO<sub>x</sub> standards based on a percentage phase-in may continue to meet Tier 2 standards for the "phase-out" fraction of the fleet through model year 2020, but must use a new smog rating scale that lines up, to the extent possible, the Tier 2 standards with the new Tier 3 scale. We believe it is appropriate to shift to the new transitional smog rating scale in model year 2018 to reflect the start of

Tier 3 program for the majority of vehicles.

The smog rating scale ranges from 1 to 10. The federal Tier 3 program comprises seven different NMOG+NO<sub>x</sub> emission certification levels. In addition, the California ZEV program for 2018 and later model years includes a unique TZEV category, which falls between a ZEV (Bin 0) and a SULEV20 (Bin 20), resulting in a total of eight emission standards.<sup>530</sup> EPA received comment asking that we develop appropriate ratings that account for both the exhaust certification and all-electric range of TZEV vehicles. EPA plans to develop guidance for smog ratings for TZEV vehicles in its annual fuel economy guidance letter. Therefore we are not finalizing a smog rating for California TZEV vehicles at this time. As proposed, we are omitting rankings 2 and 4 to help convey the larger absolute differences in the g/mile standards between Bins 70 and 125 and Bins 125 and 160.

We are also adjusting the scale again in model year 2025, once the Tier 3 standards are fully implemented, so that, the middle of the scale (a smog rating of 5 or 6) is equivalent to the fleet average standard of 0.030 g/mile for NMOG+NO<sub>x</sub>, consistent with the fuel economy and greenhouse gas rating.

We revised the regulations slightly after the proposal to accommodate the presence of LEV III vehicles in 2017 and earlier model years.

##### 2. Removing Obsolete Regulatory Text

EPA regulations for highway and nonroad engines, vehicles, and equipment in many cases apply for a range of model years before being replaced by a new set of standards, requirements, and other provisions for implementing a program that changes to reflect technological innovation, changing environmental needs, new business dynamics, and other factors.

We are taking steps in this rulemaking to remove substantial portions of regulatory text that no longer have any regulatory significance, generally because they have been superseded by newer provisions. In many cases, this simply involves removing paragraphs or sections related to certifying products that no longer apply to 2004 or newer model years. In other cases, we can remove whole subparts that apply only to engines and vehicles that have reached the end of their useful lives for the purpose of regulation. For example, the in-use regulations from 40 CFR part 86, subpart H, applied only for 1993

<sup>529</sup> 76 FR 39478 (July 6, 2011).

<sup>530</sup> <http://www.arb.ca.gov/regact/2012/zev2012/fro2rev.pdf>.



through 2003 model year light-duty vehicles, light-duty trucks, and medium-duty passenger vehicles. Also, the National LEV standards in 40 CFR part 86, subpart R (and in Appendix XIII through XVIII of part 86), applied only for 1999 through 2003 model years. These subparts, and references to that content, can be removed from the CFR.

Similarly, the provisions of 40 CFR part 86, subpart A, applied to light-duty vehicles only through model year 2000 for light-duty vehicles and model year 2004 for light-duty trucks and chassis-certified heavy-duty vehicles. Much of that subpart continues to apply for heavy-duty engines, so the obsolete portions must be removed more selectively. We are removing substantial portions of 40 CFR part 86, subpart A, to omit text that applies only for light-duty vehicles or light-duty trucks, and additional portions that do not apply for any 2004 or newer model years.

There are also instances where we are streamlining the organization of regulatory sections in 40 CFR part 86. For those places where there is a new section for a given model year where all the old provisions continue to apply, and the new section introduces a narrow additional provision, we are copying the new paragraph into the section for the older model-year provisions, with descriptive language in place to say when the new provision applies as appropriate. This consolidation allows us to take out numerous sections that can lead to confusion for the reader.

The following sections describe additional changes to remove material.

#### a. Certification Short Test and I/M Provisions

Inspection and maintenance (I/M) programs have been implemented by state and local governments for many years. These programs have been effective at identifying vehicles that need some kind of repair to restore the performance of a vehicle's emission control system. In that context, they have also provided useful information to facilitate warranty coverage where defective components or systems were still covered by the manufacturer's warranty, as required by section 207 of the Clean Air Act. In 1993, EPA adopted a requirement for the certification short test ("CST" or "cert short test").<sup>531</sup> The purpose of the cert short test was to correlate the vehicle manufacturer's certification and I/M testing. Under this approach, the vehicle manufacturer certifies that a properly maintained and operated vehicle will pass I/M testing.

When such a vehicle fails I/M during the warranty period, the manufacturer is responsible for the cost of repairs necessary to correct the problem so the vehicle can pass the I/M test.

EPA adopted requirements in 1993 for manufacturers to design and build their vehicles with OBD, which provides performance feedback for evaluating whether emission control systems are functioning properly. This rule, combined with fleet turnover, has resulted in vehicles subject to I/M being equipped with OBD. The standard protocol for I/M programs now depends on the OBD system instead of tailpipe tests to determine which vehicles need maintenance. Since vehicle manufacturers have to certify the performance of OBD systems as part of the certification process, the use of OBD for I/M testing also provides a basis for determining that emission repairs are covered by the manufacturer's warranty, when necessary. For many years, manufacturers have submitted a compliance statement for certification instead of submitting data to demonstrate that they meet the standards associated with the cert short test. Since emission measurements are no longer part of any standardized I/M testing, it has become clear that OBD systems have completely replaced the cert short test as the means of making warranty determinations for I/M testing. We are therefore entirely removing the cert short test standards and test procedures from 40 CFR part 86, subparts O and S, and similarly removing the emission measurement procedures from 40 CFR part 85, subpart W.

The remaining regulatory text in 40 CFR part 85, subpart W, relates only to the role of OBD testing in the determination of manufacturers' warranty obligations resulting from I/M testing. In addition to removing material that no longer applies based on model years, we are updating this remaining text in two ways. First, we are expanding the scope to include medium-duty passenger vehicles since these vehicles are now subject to both OBD certification requirements and I/M testing. Second, we are replacing all citations to SAE reference procedures with a cross-reference to 40 CFR 86.1806, which accounts for the relevant OBD reference procedures. This avoids the possibility of changing the certification procedures in a way that departs from the I/M and warranty provisions. Since these programs are paired, there will never be a need to specify different reference procedures for the two programs.

#### b. Testing for Heavy-Duty Highway Engines

We recently completed the migration of test procedures for heavy-duty highway engines from 40 CFR part 86, subpart N, to 40 CFR part 1065. Now that these manufacturers are all relying on the new test procedures, we are eliminating the regulatory provisions that no longer apply. This involves large portions of text in 40 CFR part 86, subpart N, that have been superseded by analogous material in 40 CFR part 1065, such as analyzer specifications, calibration procedures, calculation methods, and fuel specifications. The obsolete text also included several references to 40 CFR part 86, subpart D, which we will also no longer print in the CFR.

We are keeping regulatory provisions in 40 CFR part 86, subpart N, that serve as the "standard-setting part" for matters related to testing, such as the duty cycles and not-to-exceed test procedures. These provisions are unique to heavy-duty highway engines and are therefore not suitable for the general test specifications in 40 CFR part 1065. We will eventually migrate these remaining provisions to 40 CFR part 1036, where we already describe the greenhouse gas emission standards and certification requirements for heavy-duty highway engines.

In the case of testing in-use engines that were originally certified using the procedures in 40 CFR part 86, subpart N, we are including a regulatory provision to allow EPA and manufacturers to continue to use the original certification procedures as a pre-approved alternate procedure.

#### c. Testing for Heavy-Duty Highway Vehicles

The regulations at 40 CFR part 86, subpart M, describe how to test heavy-duty vehicles above 14,000 lbs GVWR to demonstrate compliance with evaporative emission standards. Most of these provisions are identical to those that apply under 40 CFR part 86, subpart B. As described in Section IV.C, we are eliminating subpart M and replacing it with a simple instruction to test these heavy-duty vehicles using the procedures of subpart B, with a small number of appropriate modifications noted as exceptions to the light-duty test procedures.

#### d. Service Information Requirements for Light-Duty Vehicles

The service information regulations were originally adopted for light-duty motor vehicles 40 CFR 86.038–96. These requirements applied for 1996 and later

<sup>531</sup> 58 FR 58382 (November 1, 1993).

model year vehicles. Starting with the 2001 model year, these same requirements were copied into § 86.1808–01. These two sets of requirements are identical except for the model year applicability and a variety of very minor stylistic differences. We are revising the service information regulations in § 86.1808–01 to apply also to 1996 through 2000 model year vehicles, and to correct several typographical and formatting errors. These changes should have no practical significance, since the requirements are the same in both regulatory sections.

### 3. Motorcycle Driving Schedules

The CFR includes two separate driving schedules for motorcycles. The first, for motorcycles at or above 170 cubic centimeters (cc), is identical to that used for light-duty vehicles except that the speeds are converted to kilometers per hour. The second driving schedule, for smaller motorcycles, is also identical except for a period of about three minutes of reduced-speed operation. To simplify this arrangement, and to better incorporate the new LA–92 driving schedule described in Section IV.B for heavy-duty vehicles, we are eliminating the identical portions of these drive schedules. This revised approach involves referencing the driving schedule for light-duty vehicles with instructions to convert to kilometers per hour and round the resulting speeds to the nearest 0.1 kilometers per hour, instead of repeating the driving schedule just to publish the same speed trace in different units. The unique portion of the driving schedule is laid out, with reference to the light-duty driving schedule for the portions that are unchanged. This is not intended to cause any change in the current requirements or practices for certifying motorcycles.

### 4. Updating Reference Procedures

The regulations in 40 CFR part 1065 depend on a large number of reference procedures and technical standards from ASTM, SAE International, and ISO, among others. These reference procedures and technical standards are updated periodically to keep them current with ongoing developments in the field. Many times these changes include only minor corrections or clarifications. In other cases the updates incorporate new test methods, accommodate changing engine technologies, or other more substantive changes. Whether the updated reference documents involve major changes or not, it is important for the regulations to rely on documents that are readily available. Toward that end, we are

updating § 1065.1010 with the latest versions of all the reference procedures and technical standards that we were able to identify.

In areas of the regulations other than part 1065, we are generally updating the regulation to rely on the latest reference documents where we are changing or adding a provision that depends on one of these reference documents, but we are not making broad or universal changes to these references in other parts of the regulation.

One particular area of interest relates to rounding. As described in Section IV.H.3, we are defining “round” for 40 CFR part 86 to have the meaning we give in 40 CFR 1065.20, which spells out a detailed rounding protocol that is consistent with ASTM E29 and NIST SP811. This definition of “round” will defer to existing references in part 86 so that the part 1065 protocol will apply only where we do not specifically refer to ASTM E29. This is not intended to change the policy for calculating or reporting numerical quantities, but rather to clarify the protocol and avoid the administrative complication of referencing multiple versions of the ASTM document. We expect to eventually remove all mandatory references to ASTM E29 and NIST SP811 and rely exclusively on § 1065.20 as the method for rounding numerical quantities.

### VII. What are the cost impacts of the rule?

We have estimated the costs for both the vehicle standards described in Section IV and the fuel standards described in Section V. This section summarizes these costs, while further information on the methodology we used to develop these costs can be found in Chapters 2 and 5 of the RIA.

Section VII.C provides a summary of total costs for the final vehicle and fuel programs together. For a comparison of the program costs to the monetized health and welfare benefits, see Section VIII.

#### A. Estimated Costs of the Vehicle Standards

To determine the cost for vehicles, we first determined which technologies were most likely to be applied by vehicle manufacturers to meet the standards. These technologies were then combined into technology packages which reflected vehicle design attributes that directly contribute to a vehicle’s emissions performance. The attributes considered included vehicle type (car or truck), number of cylinders, engine displacement, and the type of fuel used (gasoline or diesel). We also created

separate packages for light-duty and heavy-duty trucks and vans. In estimating both cost and technology application, we have relied on publicly available information (such as that developed by California or submitted as comments on the proposal), confidential information supplied by individual manufacturers and suppliers, and the results of our own in-house testing. The technology packages that we developed represent what we consider to be the most likely average emissions control solution for each vehicle type.

In general, we expect that the majority of vehicles will be able to comply with the Tier 3 standards which we are adopting through refinements of current emissions control components and systems. Some vehicles may require additional emission controls, such as large trucks with large displacement engines (in particular, LDT3s and LDT4s). Overall, smaller, lighter-weight vehicles will require less extensive improvements than larger vehicles and trucks. Specifically, we anticipate a combination of technology upgrades including:

- Catalyst Platinum Group Metal (PGM) Loading. Increased catalyst application of precious metals.
- Optimized Close-Coupled Catalyst: Improvements to the catalyst system design, structure, and packaging to reduce light-off time.
- Optimized Thermal Management: Overall thermal management of the emissions control system to shorten the time it takes for the catalyst to light-off.
- Secondary Air Injection: Increased application of secondary air injection for some 6-cylinder and larger engines.
- Engine Calibration: Engine control and calibration modifications to improve air and fuel mixtures, particularly at cold start and/or to control secondary air and hydrocarbon adsorbers.
- Hydrocarbon Adsorber: Limited application of hydrocarbon adsorbers to trap hydrocarbons during cold start and release the hydrocarbons after the catalyst lights off.
- Evaporative Emissions Controls: Improved evaporative emissions systems, including canister scrubbers, more permeation-resistant materials, and improved system integration.

#### 1. What changes have been made to vehicle program costs since proposal?

Chapter 2 of the final RIA contains details about what changes have been made since the proposal and why we have made those changes. We have made several changes since the proposal, but two changes have significant impacts on the final rule

vehicle costs and help to explain the large reduction in cost estimates between proposal and final rule. The first of these significant changes involves the catalyst platinum group metal (PGM) loading costs. As commenters pointed out, the cost estimates in the proposal have become dated, as they were based largely on four-year-old estimates of the CARB LEVIII program. For this final rule, we have developed a more robust catalyst loading cost estimate using a methodology suggested by one commenter.<sup>532</sup> This more robust estimate results in lower costs than estimated in the proposal.

The second significant contributor to reduced final rule cost estimates is the use of the MY 2017–2025 fleet mix projected to result from the most recent GHG and fuel economy rules. That projected fleet mix shows a large percentage of four-cylinder engines (generally these are inline engines, or I4), which are less costly to modify to achieve Tier 3 compliance than the proposal's projected MY 2012–2016 fleet mix, which included many more V-configuration six-cylinder (V6) and eight-cylinder (V8) engines. We mentioned in the preamble to the proposal our intention to use the projected MY 2017–2025 fleet for our final rule cost analysis (see 78 FR 29970).

We have made many other updates to the analysis for this final rule. For example, we reviewed the MY2013 certification database to evaluate the certified emission levels of the fleet. We found that many vehicles are already being certified with emission levels that would meet final Tier 3 standards. Further, many vehicles have certified emission levels that are 70% of the 0.30 g/mi NO<sub>x</sub>+NMOG standard, meaning that sufficient compliance margin exists for those vehicles to comply with Tier 3 without any additional costs.<sup>533</sup> Our final rule estimates no exhaust emission-related Tier 3 costs for these

<sup>532</sup> ICCT Comments in Response to the Tier 3 Proposed Rulemaking, Docket ID No. EPA-HQ-OAR-2011-0135-4304; Posada, Francisco, et. al., "Estimated Cost of Emission Control Technologies for Light-Duty Vehicles Part 1—Gasoline," SAE 2013-01-0534, 4/8/2013.

<sup>533</sup> As discussed in Section IV, we expect manufacturers to target 60–80% of the standard, or 20–40% compliance margins under Tier 3.

vehicles (evaporative emission-related costs are discussed below).

We have also concluded that active HC adsorbers are not expected on any vehicles and, instead, a passive HC adsorber will be used. The passive HC adsorber is considerably less costly. We base this on comments from MECA and ICCT and on confidential business information (CBI) provided by Tier 1 suppliers after the proposal.<sup>534</sup> We have also decreased our evaporative emission control costs, in part because of the high penetration of gasoline engines with direct injection as projected by the MY 2017–2025 GHG and fuel economy rules. Direct injection removes a large source of evaporative emissions and, thus, means fewer vehicles need to add certain evaporative control technologies. We have also decreased the penetration rates of secondary air injection in the later years of the program, for reasons described below. Lastly, we have modified very slightly our indirect cost markups to account for the fact that most of the research and development efforts required of auto makers are in response to CARB's LEVIII rule and need not be conducted again for Tier 3 compliance.

We have made some changes that have increased costs, although the cost increases are smaller in magnitude than the cost decreases from other changes so, on net, estimated vehicle-level costs are lower than in the proposal. One such change was to increase the engine calibration costs (from roughly \$2/vehicle to \$5/vehicle), to cover expected calibration efforts associated with PM control on direct injected gasoline engines. We have also increased the penetration rates of the technology we term "optimized thermal management" for some vehicle classes. This was done to ensure that all vehicles adding technology include costs for either optimized close-coupled catalysts or optimized thermal management by setting the combined phase-in rate in each vehicle category to 100%. Another change was to update all costs from 2010 dollars to 2011 dollars.<sup>535</sup>

<sup>534</sup> See ICCT, Docket ID No. EPA-HQ-OAR-2011-0135-4304, at page 11 of 21; see MECA, Docket ID No. EPA-HQ-OAR-2011-0135-4675, at page 3 of 7.

<sup>535</sup> We have updated 2010 dollars to 2011 dollars using the Gross Domestic Product (GDP) price

deflator as reported by the Bureau of Economic Analysis on May 30, 2013. The factor used, taken from Line 1 of Table 1.1.4 Price Indexes for Gross Domestic Product, was 1.035 to convert from 2009\$ and 1.021 to convert from 2010\$. For example, to convert from 2010\$ to 2011\$, we calculated the (value in 2010\$) × 1.021 = (value in 2011\$).

With respect to total program costs, the significant change since proposal was to exclude costs incurred on vehicles sold in all states (California and elsewhere) that have adopted the California LEVIII program. As a result, our estimated costs per vehicle are applied to millions fewer vehicles in the final rule, thus making the total program costs considerably lower. And finally, we have included operating savings (fuel savings) associated with avoiding the loss of fuel that would have otherwise evaporated absent the new Tier 3 controls. The otherwise evaporated fuel is ultimately used to propel the vehicle, thus providing a savings to the consumer.

## 2. Summary of Vehicle Program Costs

As in the proposal, we have developed our costs with respect to a given vehicle type and the type of engine with which it is equipped. The final cost per vehicle is the result of not only the cost per technology, but also the application rate of that technology for each vehicle type. For example, while the \$119 (2017 cost in 2011\$) cost of secondary air injection is the same for both a 6-cylinder (V6) and 8-cylinder (V8) application, we anticipate that only 25 percent of the V6 and 75 percent of the V8 passenger car applications will require it in MY2017. In the same way, we anticipate that light truck applications will not add that technology until MY2018, again at a 25%/75% penetration rate for V6/V8 applications, respectively. Table VII–1 below shows our estimate of the cost of each of the emission control technologies for the gasoline vehicles affected by this final rule. Table VII–2 provides the anticipated application rate of the technology by vehicle type. Note that all of the costs shown in this section are in 2011 dollars and are marked-up by an Indirect Cost Multiplier (ICM) so they include both direct and indirect costs. (For details of regarding ICMs and their application refer to Chapter 2 of the RIA.)

deflator as reported by the Bureau of Economic Analysis on May 30, 2013. The factor used, taken from Line 1 of Table 1.1.4 Price Indexes for Gross Domestic Product, was 1.035 to convert from 2009\$ and 1.021 to convert from 2010\$. For example, to convert from 2010\$ to 2011\$, we calculated the (value in 2010\$) × 1.021 = (value in 2011\$).

TABLE VII-1—MY2017 TECHNOLOGY COSTS BY GASOLINE ENGINE TYPE  
[2011\$]<sup>a</sup>

Technology	PC I4	PC V6	PC V8	LT I4	LT V6	LT V8	HD <sup>c</sup> Class 2b	HD Class 3	>14K HD <sup>d</sup>
Catalyst Loading .....	\$43	\$68	\$101	\$50	\$75	\$108	\$59	\$59	N/R
Optimized Close-coupled Catalyst .....	24	48	71	24	48	71	N/R	N/R	N/R
Optimized Thermal Management .....	36	36	36	36	36	36	36	36	N/R
Secondary Air Injection .....	<sup>b</sup> N/R	119	119	N/R	119	119	N/R	N/R	N/R
Engine Calibration .....	5	5	5	5	5	5	5	5	N/R
Hydrocarbon Adsorber .....	N/R	N/R	20	N/R	N/R	20	N/R	N/R	N/R
Evaporative Emissions Controls ..	15	15	15	14	14	14	11	17	17

<sup>a</sup> PC = passenger car; LT = light truck; I4 = In-line 4-cylinder; V6 = 6-cylinder, V8 = 8-cylinder.  
<sup>b</sup> N/R—Not Required.  
<sup>c</sup> Heavy-duty.  
<sup>d</sup> Gasoline only.

TABLE VII-2—TECHNOLOGY APPLICATION RATES FOR GASOLINE VEHICLES

Technology	PC I4 <sup>a</sup> (percent)	PC V6 <sup>a</sup> (percent)	PC V8 <sup>a</sup> (percent)	LT I4 <sup>b</sup> (percent)	LT V6 <sup>b</sup> (percent)	LT V8 <sup>b</sup> (percent)	Class 2b & 3 <sup>b</sup> (percent)	>14K HD <sup>c</sup> (percent)
Catalyst Loading .....	100	100	100	100	100	100	100	0
Optimized Close-coupled Catalyst .....	50	60	75	50	60	75	0	0
Optimized Thermal Management .....	50	40	25	50	40	25	25	0
Secondary Air Injection <sup>d</sup> ..	0	25	75	0	25	75	0	0
Engine Calibration .....	100	100	100	100	100	100	100	0
Hydrocarbon Adsorber .....	0	0	15	0	0	15	0	0
Evaporative Emissions Controls .....	100	100	100	100	100	100	100	100

<sup>a</sup> MY2017 and later.  
<sup>b</sup> MY2018 and later (Note that, for the vehicle cost analysis, LDT1/2/3/4 are treated collectively as light trucks.)  
<sup>c</sup> Gasoline only.  
<sup>d</sup> Secondary air injection penetration rates ramp down from values shown here as follows: Passenger car and light truck V6 gasoline: 25/25/25/15/15/5/5/5/5% beginning in 2017 except for light trucks which have a 0% penetration in MY2017; Passenger car and light truck V8: 75/75/75/65/65/55/55/45/45% beginning in 2017 except for light trucks which have a 0% penetration in MY2017.

Note the footnote to Table VII-2 describing the penetration rates used for secondary air injection systems in V6 and V8 gasoline vehicles. In the proposal, we did not use a ramped down penetration rate like that being used in this final rule for this technology. We have revised the penetration rates in this final rule because of the historical pattern by which secondary air injection has been implemented in the light-duty fleet. Generally, secondary air makes an appearance in the early implementation stages and then is slowly phased out as auto makers learn more about and become more comfortable with their ability to meet any new emission standards with a lower degree of reliance on secondary air. Presumably, this technology is added in the early stages because it provides effective and relatively easily implemented cold temperature control for difficult applications in which auto makers tend to consider every technique at their disposal to ensure full useful life compliance. Then, as experience is gained, the secondary air injection

systems slowly disappear from the new light-duty fleet due to its relatively high cost. We expect a similar implementation pattern in response to Tier 3. This position is corroborated by ICCT in their comments where they say, in the context of LEV II vehicles meeting the LEV III standards, “In some cases it was easier and cheaper for manufacturers to add existing hardware (i.e., secondary air injection) than to invest the engineering resources to fully optimize precise air/fuel control and fast light-off strategies, or to develop new hardware” (emphasis added).<sup>536</sup> Medium Duty Passenger Vehicles (MDPVs) were included in the light-duty fleet as part of Tier 2. Given their current certification requirements for criteria pollutants, we have included the costs for MDPVs to meet the Tier 3 standards with the light truck cost estimates. We do not expect that the technologies required to meet the Tier 3 standards for MDPVs will be different from those applied to light trucks (with V8 engines), as in many cases there are

<sup>536</sup> See EPA-HQ-OAR-2011-0135-4304 at page 11 of 21.

identical powertrains and chassis between the large light truck and MDPV platforms.

We also expect that some manufacturers may continue to build and sell light-duty diesel vehicles and certify those vehicles to Tier 3. All light-duty diesel vehicles currently being sold in the federal fleet are equipped with some means of controlling NO<sub>x</sub> emissions, either a Lean NO<sub>x</sub> Trap (LNT) or selective catalytic reduction (SCR) system. As these systems are already very effective in controlling NO<sub>x</sub> emissions, we expect that they will remain the primary emissions control systems to meet Tier 3. Similar to gasoline engines, diesel powertrains may be required to improve the effectiveness of their emission control systems during cold start. Therefore, we have developed our costs for diesels with the expectation that the incremental costs will be realized to improve LNT and SCR systems during cold start. The improvements have been categorized as general SCR optimization, which include packaging changes to the SCR system to allow

faster light off; optimized thermal management, to reduce the thermal mass of the system and allow more of

the combustion heat to reach the SCR system sooner; and the calibration work associated with both of these changes.

Table VII–3 below describes both the cost of the technologies as well as their anticipated application rates.

TABLE VII–3—MY2017 TECHNOLOGY COSTS AND APPLICATION RATES FOR DIESEL ENGINES [2011\$]

Technology	Diesel engine costs (all types)	Light-duty and heavy-duty application rate
Optimized Thermal Management .....	\$36	25%
Engine Calibration <sup>a</sup> .....	2	100
SCR Optimization .....	59	100

<sup>a</sup> These engine calibration costs are the same as the proposal since the increased calibration costs associated with gasoline direct injection do not apply for diesels.

We also estimated costs for HDVs between 8,501 and 14,000 lbs GVWR and for gasoline HDVs above 14,000 lbs. Vehicles in this range are often referred to as Class 2b (8,5001–10,000 lbs), Class 3 (10,001–14,000 lbs) and Class 4 and above (>14,000 lbs) vehicles and are typically full-size pickup truck and work vans. We applied the same process to the heavy-duty vehicles as we did to the light-duty vehicles. Heavy-duty costs and application rates are included in Table VII–1, Table VII–2, and Table VII–3 above.

We have also considered the impacts of manufacturer “learning-by-doing” on the technology cost estimates. We reflect the phenomenon of volume-based learning curve cost reductions in our modeling using two algorithms, depending on where in the learning cycle (i.e., on what portion of the learning curve) we consider a technology to be: The “steep” portion of the curve for newer technologies and “flat” portion of the curve for more mature technologies. We have made no changes to the application of learning curve cost reductions relative to the proposal. For details surrounding learning-by-doing, please refer to Chapter 2 of the final RIA.

The evaporative emissions standards that we are adopting will impose relatively small cost impacts. We estimate the cost of system improvements, including indirect costs, to be less than \$17 (MY2017 cost in

2011\$) per vehicle, for all vehicle classes. This incremental cost reflects the cost of moving to low-permeability materials, reduced number of fuel-system connections, longer contiguous lengths of plumbing, and low-permeation connectors. We believe that learning is also appropriate for evaporative emissions control systems as described above and in more detail in Chapter 2 of the RIA.

We have used the individual technology costs discussed briefly here and in more detail in Chapter 2 of the RIA to estimate package costs for each of the different gasoline and diesel engine types in the fleet (i.e., I4 passenger car, V6 passenger car, etc.). We have then multiplied these package costs by the projected sales estimates for the years 2017 and later. The projected sales estimates used, as noted earlier, represent the future fleet mix rather than today’s fleet mix. That fleet mix is discussed in more detail in Chapter 2 of the RIA. With these total annual costs, we then determined the sales-weighted average cost increase for all passenger cars, light trucks and heavy-duty vehicles. Table VII–4 below provides our estimates of the incremental cost per vehicle by model year for both tailpipe and evaporative emissions standards. These values reflect the total direct and indirect manufacturing costs as well as the appropriate learning-by-doing effects. As stated above, a large portion

of the cost is incurred in the initial model years. Costs then continue to rise as the percentage of vehicles complying with the final standards increases through MY 2025.

We have estimated costs consistent with the fact that manufacturers would be required to start the phase-in of Tier 3 standards in MY2017 for vehicles under 6,000 lbs GVWR and the expectation that MY2018 will begin the phase-in for vehicles greater than 6,000 lbs GVWR. Based on the declining fleet averages for cars and trucks, we have apportioned our estimates for full compliance across the phase-in years as a percentage of the final standard. Manufacturers will be required to move from a Tier 2 Bin 5 fleet average in MY2017 (for vehicles <6,000 lbs GVW). This results in a significant step in stringency. As a result, a large portion of the costs are expected to be incurred in the initial model years. Finally, manufacturers have the opportunity in MY2015 and MY2016 to earn Tier 3 credits by producing a fleet that is cleaner than the current Tier 2 requirements. While we expect that most manufacturers will earn credits, either by selling California vehicles as 50-state vehicles or by certifying existing vehicles to lower Tier 2 bins, we have not reflected these credits in our cost analysis. In that way, we believe that our cost estimates are conservative.

TABLE VII–4—PER VEHICLE TECHNOLOGY COSTS BY MODEL YEAR [2011\$]<sup>a</sup>

Model year	2017	2018	2019	2020	2021	2022	2023	2024	2025
Passenger car .....	\$46	\$51	\$53	\$57	\$59	\$63	\$63	\$64	\$65
Light truck .....	0	73	78	82	86	88	87	87	86
Light-duty Combined .....	29	59	62	66	68	72	71	72	72
Class 2b .....	0	44	51	60	66	75	71	70	69
Class 3 .....	0	33	41	49	57	65	62	61	60
>14,000 pound HD .....	0	10	10	13	13	16	15	15	15

<sup>a</sup> Costs shown include costs for the Tier 3 standards on vehicles sold outside California and other states that have adopted LEVIII.

Total annual costs are shown below in Table VII-5. This table includes all costs associated with the final Tier 3 vehicle standards, i.e., both exhaust and evaporative emission standards. Also included are facility-related costs associated with the final requirements to conduct more PM testing on gasoline vehicles. (Additional detail regarding the PM facility costs are described in section 2.6 of the final RIA.) We show the facility costs in the year 2016 even though the program does not begin until 2017. These costs represent the construction costs that would be

incurred before the first year of the standards in preparation for the testing efforts that would be required. We have not made any changes to the costs per facility upgrade relative to the proposal, and we present the details supporting our estimates in Chapter 2 of the final RIA.

Lastly, as noted above, we have included the impact on operating costs associated with the new evaporative emission controls. Because the evaporative emissions that would have been emitted absent the new standards will ultimately be used to propel the vehicle, the avoided evaporative

emissions represent a savings to the consumer. While these savings are small on a per-vehicle basis—generally less than \$2/vehicle over its lifetime—they are notable on a fleetwide basis where, in calendar year 2025, they result in \$11 million in pre-tax savings. We also considered other operating costs, such as maintenance costs and repair costs, but concluded that the nature of the Tier 3 compliance technologies will not result in any increases or decreases in existing operating costs. We present the details about these operating savings in Chapter 2 of the final RIA.

TABLE VII-5—ANNUAL COSTS OF THE TIER 3 VEHICLE PROGRAM

[Millions of 2011 dollars]<sup>a</sup>

Year	Exhaust			Evap			Operating <sup>b</sup>			Facilities	Total
	LD	HD	All	LD	HD	All	LD	HD	All		
2016 .....	\$0	\$0	\$0	\$0	\$0	\$0	\$0	\$0	\$0	\$21.4	\$21.4
2017 .....	268	0	268	25.5	0	25.5	0	0	0	3.52	297
2018 .....	519	20.2	539	70.2	3.24	73.4	-1.17	-0.047	-1.22	3.52	615
2019 .....	555	24.2	579	69.2	3.18	72.4	-2.03	-0.094	-2.12	3.52	653
2020 .....	571	27.8	599	94.3	4.12	98.4	-3.22	-0.160	-3.38	3.52	697
2021 .....	598	31.5	630	92.8	4.04	96.8	-4.44	-0.226	-4.67	3.52	725
2022 .....	605	34.8	640	116	4.93	121	-5.96	-0.309	-6.27	3.52	758
2023 .....	606	33.3	639	111	4.73	116	-7.45	-0.390	-7.84	3.52	751
2024 .....	620	33.1	653	109	4.70	114	-8.95	-0.472	-9.42	3.52	761
2025 .....	635	32.8	668	108	4.66	113	-10.4	-0.553	-11.0	3.52	773
2030 .....	632	31.8	664	108	4.56	113	-18.0	-0.959	-19.0	3.52	761

<sup>a</sup>Costs shown include costs for the Tier 3 standards on vehicles sold outside California and other states that have adopted LEVIII.

<sup>b</sup>Operating costs use pre-tax fuel prices; negative cost values denote savings.

*B. Estimated Costs of the Fuel Program*

The sulfur control program we are adopting is expected to result in many refiners further investing in sulfur control hardware and changing the operations in their refineries to reduce their gasoline sulfur levels. The final sulfur control program requires refiners and importers to reduce their gasoline sulfur levels on average down to 10 ppm. The ABT provisions being adopted along with the 10 ppm average sulfur control standard will allow refiners that reduce their gasoline sulfur levels below 10 ppm to earn credits and trade those credits to other refiners who would find it more expensive to reduce their sulfur levels down to the average standard. The ABT program will allow refiners to optimize their investments, which we believe will result in achieving the average sulfur control standard nationwide at lower costs. We are maintaining the current 80 ppm sulfur cap at the refinery gate. We estimate that the national average refinery costs incurred to comply with the fully phased-in Tier 3 sulfur control program with ABT program will be 0.65 cents per gallon, averaged over all gasoline. This estimate includes the

capital costs, which are amortized over the volume of gasoline produced.

In this section we summarize the methodology used to estimate the costs of Tier 3 sulfur control and our estimated costs for the program. A detailed discussion of all of these analyses is found in Chapter 5 of the RIA.

1. Overview

The basic methodology we used to estimate the cost of sulfur control for the final rule is similar to that for other rulemakings. Using a refinery-by-refinery cost model that we developed for this rulemaking, we projected the sulfur control technology expected to be used by each refinery, and the cost of each refinery's sulfur control step, to estimate compliance with the final sulfur control program. We aggregated the individual refinery costs to develop a national average cost estimate for the final sulfur control program. We modeled costs assuming an in-use average of 10 ppm and assuming refiners take full advantage of the ABT provisions and minimize overcompliance based on experience for

the Tier 2 program demonstrating this today.

Refinery-by-refinery cost models are useful when individual refineries are expected to respond to program requirements in different ways and/or have significantly different process capabilities. Furthermore, as is the case with sulfur control, such approaches are possible when the refinery changes required are primarily “add-ons” that do not impact the fundamental operation at the refinery. Thus, in the case of modeling potential gasoline sulfur control programs, we needed a model that could accurately simulate the variety of decisions refiners will make at different refineries, especially in the context of a nationwide ABT program. For this and other related reasons, we developed a refinery-by-refinery cost model to evaluate the costs and other impacts of the final sulfur control program.

Refinery-by-refinery cost models have been used in the past by both EPA and the oil industry for such programs as the Mobile Source Air Toxics gasoline

benzene control,<sup>537</sup> highway and nonroad diesel fuel sulfur standards. They are a proven means for estimating the cost of compliance for fuel control programs. While they will never precisely model and predict individual refinery operations and impacts, they provide both a good assessment of the overall market impacts and of the variation of impacts across the refineries. Refinery-by-refinery models are also very useful when estimating the cost impacts of ABT programs.

We used a linear program (LP) cost model to estimate a cost for recovering the octane lost when refiners further desulfurize their gasoline to comply with the 10 ppm sulfur standard. Our refinery modeling run for estimating octane cost assumed E10 with a small amount of E85. This cost is a key input into the refinery-by-refinery cost model. The octane cost we developed from the LP model is \$0.31 octane number-barrel. We also used the LP refinery model to estimate the change in gasoline qualities that occurs when refiners make up for the lost octane that were used as inputs into the emissions impacts analysis discussed in Section III.

## 2. Methodology

The way that the refinery-by-refinery cost model works can be subdivided into two primary steps. First, the model attempts to model how refiners blend up gasoline at each of their refineries. This is an important step because the fluidized catalytic cracker (FCC) naphtha, a product from FCC units, is responsible for almost all the sulfur in gasoline, even after complying with Tier 2. To help our understanding of how refiners blend up their gasoline, we used refinery unit throughput data which tell us how refiners are using their refinery units. The per-gallon cost is calculated over all the gasoline pool, while the desulfurization cost is incurred by desulfurizing FCC naphtha; thus, the relative volume of FCC naphtha to the rest of the gasoline pool is important.

The second primary step of the refinery-by-refinery cost model is to project how refiners would comply with the Tier 3 10 ppm average sulfur standard taking into consideration how they complied with the 30 ppm Tier 2 gasoline sulfur standard. To determine how refiners would comply with Tier 3, we contacted the vendors which provided the technology to refiners for complying with Tier 2 and continued to provide onsite support. Vendors provided information to us for installing

grassroots units or revamping existing FCC posttreaters sufficient to reduce the gasoline pool down to 10 and 5 ppm. We also evaluated the need and cost to refiners to reduce the sulfur levels of other refinery streams and included costs for those refineries to hydrotreat the light straight run naphtha stream where such additional control appeared warranted. Finally, we assessed the cost for complying with Tier 3 assuming that refiners take advantage of an ABT program. To assess the costs for the Tier 3 program that included an ABT program, we organized the estimated sulfur reduction costs for each refinery for achieving both 5 and 10 ppm from lowest to highest to determine the set of investments for Tier 3 which minimized the cost of the Tier 3 program.

We made a number of modifications to the refinery-by-refinery model for the final rule cost analysis. Based on a review of credit trading occurring for Tier 2, which revealed that credits are freely traded between refining companies, we changed our cost analysis to assume nationwide credit trading instead of restricting it to intra-company trading, as we did for the Tier 3 proposal's cost analysis. We incorporated refinery unit throughput data that we obtained from EPA's Office of Air Quality Planning and Standards (OAQPS). The refinery model we used for this final rule estimated sulfur reduction cost for each refinery based on actual starting sulfur levels, instead of assuming that each refinery was desulfurizing their gasoline from 30 ppm to 10 or 5 ppm. We further refined our assessment for treating light straight run naphtha, but did not include any costs for treating butane since we found out from a vendor that butane is routinely treated today. We requested and received additional desulfurization cost data from vendor companies that we applied in our cost analysis. In response to comments from peer reviewers and other information that we obtained, we applied a higher offsite factor and a higher contingency factor to the capital costs. Additional changes that were made for the final rule cost analysis are discussed in Chapter 5 of the RIA.

Our refinery-by-refinery sulfur cost model incorporates data on throughput volumes for each of the major refinery units in each refinery, including the crude unit, FCC unit, coker, hydrocracker, alkylation unit, reformer, isomerization unit, naphtha hydrotreater and aromatics plant. Unlike the unit capacity data used for the NPRM analysis, throughput volumes are a much more robust set of data because they eliminate the need to try

to estimate how that refinery is operating that unit, or whether the unit is shutdown. We also used purchase and sales information for each refinery such as purchases of natural gas liquids, naphtha and sales of propylene. The propylene sales data were used to estimate whether a refinery is operating its FCC unit in propylene maximization mode. If a refinery is operating in propylene maximization mode, some of the volume of FCC naphtha is cracked to produce increased volume of propylene for sales to the chemicals industry, but these refineries are producing a smaller volume of FCC naphtha. While the increased use of refinery-specific data has improved the ability of the refinery-by-refinery model to represent the operations of each refinery, there still is uncertainty about how each refinery is being operated.

To assess how well our refinery model estimates the gasoline production for each refinery, we compared the gasoline production volume estimated by the refinery-by-refinery model for each individual refinery to the 2011 gasoline volumes reported by refiners to EPA. Despite the use of very robust throughput data, there was still an overproduction of gasoline by quite a few refineries. In trying to address this overproduction of gasoline volume by our refinery model, we spoke to refiners, vendors and peer reviewers and also reviewed the results of our LP refinery modeling runs. This led us to conclude that this volumetric difference in the refinery model was due in many cases to not accounting for the undercutting of heavy gasoline into the jet and diesel fuel pools. We further discuss the implications of undercutting in Section VII.B.3. Overall, after we made some adjustments by assuming that certain refiners are undercutting heavy gasoline to distillate, we were satisfied with the model's volumetric estimates. To set up the refinery model, the model was updated with a projection of refined product volumes, and of input and output prices, from the Energy Information Administration's Annual Energy Outlook (AEO) 2013 for the year 2018.

For this refinery-by-refinery sulfur cost model, we conducted two sets of independent peer reviews. One set of peer reviews was conducted for the version of the refinery-by-refinery model we developed for estimating the costs for the NPRM. We reviewed the peer review comments and decided that the impact on the estimated costs would be small, so we deferred making changes to address those peer review comments until the final rule. We developed another version of the

<sup>537</sup> "Control of Hazardous Air Pollutants From Mobile Sources," 72 FR 8428, February 26, 2007.



refinery-by-refinery cost model which addressed the comments we received from the first set of peer reviews, as well as included additional improvements to the refinery model based on new information that we received after we conducted the cost analysis for the NPRM. We submitted the final rule version of the refinery cost model for a second round of peer review. The peer review comments as well as our responses to these comments are contained in the docket. We addressed many of the comments made by the peer reviewers in the final version of the cost model. The oil industry has also conducted a similar analysis using a refinery-by-refinery cost model, and we discuss the results of its analysis at the end of this chapter.

Our assessment of how refiners will comply with Tier 3 has not changed since we conducted our cost analysis for the NPRM. The refinery unit responsible for the greatest contribution of sulfur to gasoline is the FCC. The FCC processes a very heavy feedstock which contains high levels of sulfur.<sup>538</sup> When the FCC cracks this heavy, sour feedstock, a portion of the sulfur in the feed to the FCC ends up in the FCC naphtha, an important gasoline blendstock stream.<sup>539</sup> Before the Tier 2 sulfur control program was implemented, FCC naphtha contributed over 95 percent of the sulfur to a refinery's gasoline, and now that Tier 2 has been fully implemented it still contributes roughly 80 to 90 percent of the sulfur in refiner's gasoline for those refineries with FCC units. To comply with the Tier 2 sulfur control program, most refiners installed FCC naphtha hydrotreaters (FCC posttreaters) and some refiners installed FCC feed hydrotreaters (FCC pretreater) to reduce that unit's sulfur contribution to their gasoline pool. The technologies installed include Axens Prime G+, Exxon-Mobil Scanning, CDTech's CDHydro and CDHDS, Sinopec's S-Zorb and UOP's ISAL (UOP now offers a posttreating technology named Selectfining). Despite the much lower sulfur contribution to the gasoline pool by the FCC after complying with Tier 2, the vendors which supplied sulfur control technology for complying with the Tier 2 sulfur control program have informed us that to comply with a more stringent sulfur standard, refiners are expected to further reduce the sulfur in the FCC naphtha. We contacted each of

those technology vendors, and some of them provided information useful to estimate the cost of lowering the sulfur in the FCC naphtha to allow each refinery to reduce the sulfur in its gasoline to 10 ppm. We also reviewed literature that is available on the Web to further understand what would be involved to achieve a 10 ppm sulfur standard using posttreating (see Chapter 4 of the RIA). We were able to obtain some additional sulfur cost information from the vendors since we conducted our cost analysis for the proposed rule, and this was incorporated into our cost analysis.

Gasoline desulfurization vendors were pessimistic that the operations of FCC pretreaters could be adjusted to enable those refineries which relied on those units to comply with the Tier 2 sulfur standard to meet a 10 ppm sulfur standard. Many of those FCC pretreater units have marginal (less than two years) turnaround times today and they would either require a major revamp or suffer even shorter turnaround times if they were to simply be turned up. For the refineries solely relying on FCC pretreaters to comply with Tier 2, desulfurization vendors project that most refineries in this situation will put in grassroots FCC posttreaters to allow those refineries to comply with a 10 ppm gasoline sulfur standard. However, since adding grassroots FCC posttreaters is relatively expensive for the amount of sulfur reduction obtained, the ABT analysis we conducted avoided many of these types of investments. Instead, the refiners with refineries in this situation are projected to acquire credits from refiners capable of reducing sulfur levels below 10 ppm at a lower cost.

In addition to addressing the sulfur in the FCC naphtha, we believe that some refineries may need to reduce the sulfur in the light straight run (LSR) naphtha. Most refiners hydrotreat the LSR before sending that stream to an isomerization unit, and therefore that stream is very low in sulfur. Other refiners use a sweet crude oil, and once the LSR is treated by using an extraction desulfurization technology, the sulfur level of the LSR is likely to be very low (under 10 ppm). However, some refineries that refine a more sour crude oil slate and do not have isomerization units could have fairly high sulfur levels in their LSR, even after using extraction desulfurization. For these refineries, we conducted an assessment to determine whether these refineries have sufficient hydrotreating capacity to hydrotreat the LSR. We believe that refiners that do not currently desulfurize their LSR, but may need to do so because their crude oil is not sweet, could do so by either feeding

it to their naphtha hydrotreater (the hydrotreater which desulfurizes the feed to the isomerization and reformer units), or perhaps even to the FCC posttreater; we added a cost for this. Because LSR does not contain any olefins, it is an easy stream to hydrotreat and actually improves the hydrotreating conditions within the FCC naphtha hydrotreater.

### 3. Fuel Program Costs

We used the refinery-by-refinery cost model to estimate the costs of the 10 ppm average standard being adopted in this final rule. The Tier 3 fuels program maintains the 80 ppm cap sulfur control standard that was put in place under the Tier 2 sulfur program. In general, the cost model indicates that further desulfurizing the FCC naphtha will be the most cost-effective means for achieving sulfur control. We accounted for additional costs to refiners for desulfurizing their LSR naphtha, for those refineries where we estimate that the LSR naphtha is not being desulfurized today and found that it likely needs to be.

As described in Section V.A.4, we are also adopting an ABT program that is designed to ease the overall burden on the industry while still achieving the 10 ppm annual average sulfur standard for the nation as a whole. Under the ABT program, refineries that can reduce sulfur below 10 ppm at a relatively low cost can generate credits which can then be acquired by refineries for whom the cost of attaining the 10 ppm sulfur standard would be higher. These credits can be traded among refineries within the same company, or between refiners and importers nationwide. The net effect of this credit trading would be to reduce the overall cost of the program. The extent to which the ABT provisions reduce the cost of the Tier 3 program depends on the extent that the ABT program is used by refiners. As summarized in the alternatives section (Section IX), the cost of the 10 ppm Tier 3 sulfur program is 0.65 c/gal assuming widespread nationwide credit trading, while if we assume that no credit averaging or trading between any individual refinery occurs, the Tier 3 program cost increases to 0.88 c/gal, a 35% increase. In between those two scenarios is the case that sulfur credits are only used for averaging within companies (not traded between refineries owned by different companies), and we estimated the cost for that scenario at 0.75 c/gal. Since we were not sure about the extent that credits were traded under Tier 2 when we conducted the cost analysis for the NPRM, we conservatively assumed for the NPRM cost analysis that refiners

<sup>538</sup> A hydrocarbon stream which contains large amounts of sulfur is also referred to as being sour. In general, the heavier the hydrocarbon portion of crude oil, the higher the natural sulfur content.

<sup>539</sup> On average, the fluidized catalytic cracker supplies about 35 percent of a refiner's gasoline output.

would only volume-average sulfur levels among their refineries, and not trade credits between refining companies. However, for the final rule cost analysis we evaluated the credit trading that was occurring under Tier 2. We found that 56% of credits were in fact being traded between refining companies under Tier 2, with the balance being used within refining companies. This demonstrated that credit trading was freely occurring between refining companies, supporting the conclusion that credit trading would occur nationwide among refineries under Tier 3. We therefore assumed nationwide credit trading for our final rule.

To estimate the impact that the ABT program could have on nationwide average fuel costs, we began with the refinery-by-refinery costs described in Section VII.B.2.b for sulfur reductions down to either 10 ppm or 5 ppm. We then determined the lowest cost option among three alternatives for each refinery:

1. The refinery reduces its sulfur to 10 ppm.
2. The refinery reduces its sulfur to 5 ppm and generates credits for the increment between 10 ppm and 5 ppm.
3. The refinery does not lower sulfur, but instead relies on the purchase of credits to comply with the 10 ppm standard.

A fourth category applied to refineries whose average gasoline sulfur levels are already below 10 ppm (their refineries do not have FCC units). All such refineries were assumed to generate credits for the increment between 10 ppm and their current sulfur level.

Our methodology was unable to consider a fifth category where a refinery may utilize less expensive capital and operational changes to reduce their sulfur levels partially below Tier 2 levels and rely on purchasing credits only for the remainder. Such opportunities are likely to exist at most refineries, but such refinery specific information is not available to us. As a result, refineries in the third category are modeled to simply remain at Tier 2 sulfur levels and incur no capital or operating cost.

To simplify the modeling of how an ABT program might operate, we focused on the circumstances that refineries would face in the longer term, specifically after 2020. This approach meant that the ABT program modeling did not consider the impact on gasoline sulfur levels of delayed compliance for small refiners and small volume refineries, nor did it consider the generation and use of any early sulfur credits. Moreover, our ABT modeling

considered only gasoline sold for use outside of California, and only gasoline produced by domestic refineries (not importers).

Our final rule cost analysis is based on a nationwide credit trading scenario. Under Tier 2 today, a significant fraction of Tier 2 sulfur credits are bought and sold between companies and we believe that this practice will continue (see Section V.D for details about the ABT program). To model this phenomenon, we first establish an estimated cost for each refinery for reducing its gasoline sulfur down to 10 ppm and to 5 ppm. Next we ranked the sulfur control strategies for all the refineries in order from lowest to highest sulfur control cost per gallon of gasoline and estimated the impact of their projected sulfur control strategies on refinery sulfur levels using only one cost (either 10 or 5 ppm) for any one refinery. The model then follows this ranking, starting with the lowest-cost refineries, and adds refineries and their associated control technologies one-by-one until the projected national average gasoline sulfur level reaches 10 ppm. This modeling strategy projects the sulfur control technology that will be used by each refinery, as well as identifies those refineries that are expected to generate credits and those that are expected to use credits in lieu of investing in sulfur control. The sum of the costs of the refineries expected to invest in further sulfur control provides the projected overall cost of the program.

Based on the results of our cost analysis, we estimate that for the U.S. refining industry to achieve a 10 ppm average level with the full benefit of nationwide credit trading, the final sulfur control program would cost on average 0.65 cents per gallon when it is fully phased in, assuming that capital investments are amortized at a seven percent return on investment before taxes and expressed in 2011 dollars. Refiners would be expected to make \$2.025 billion in capital investments to achieve this sulfur reduction. These capital investments are expected to be made over the 6 years that the Tier 3 program is expected to be phased in, which would spread out the capital costs to average about \$330 million per year.

Our cost assessment is likely conservative (i.e., overestimates costs). The capital cost estimate is based on vendor data which assumes that refiners are hydrotreating full range FCC naphtha. If refiners are indeed undercutting their FCC naphtha at many refineries (and more will be doing so in the future), many refiners would likely

not need to make any capital changes. This is because the FCC posttreaters were designed when refiners were maximizing their gasoline production and hydrotreating full range FCC naphtha. When undercutting the FCC naphtha to the diesel pool, refiners cut out about 16% of the FCC naphtha volume and about half of the sulfur. Thus, if a refiner was able to produce 30 ppm gasoline, after fully undercutting their FCC naphtha into the diesel pool, they would likely be able to produce 15 ppm sulfur gasoline using their existing Tier 2 posttreaters. They could then use a more active catalyst which likely would enable the refinery to achieve 10 ppm gasoline without any capital changes to their FCC posttreaters. If all refiners were undercutting their FCC naphtha and are able to comply with Tier 3 without any capital additions to their FCC posttreaters, the cost of the program would decrease to around 0.4 c/gal.

Another way that our modeling could be conservative is that refiners are slowly converting their FCC pretreaters over to mild hydrocrackers to produce more diesel fuel, which is in higher demand. We do not know the extent that this is happening, and our current analysis assumes that none of the FCC pretreaters have been converted over to mild hydrocrackers. However, a cost sensitivity analysis that we conducted with our refinery model estimates that if all the FCC pretreaters were converted over to mild hydrocrackers, costs of the Tier 3 program would decrease to 0.55 c/gal, assuming nationwide credit trading. If we combined the cost reduction of undercutting with the mild hydrocracking, the Tier 3 costs would be lower than either of two cost sensitivities which were conducted independently.

We also received some comments by API and two of the peer reviewers about our octane costs. We will not include all the discussion here about octane costs because we do so in detail in the response to peer review comments and in Chapter 5 of the RIA. While we are comfortable with the octane costs that we used, we did conduct a sensitivity at a higher octane cost (\$0.5/per octane number barrel instead of \$0.31/octane number-barrel that we used). At the higher octane cost of \$0.5/octane number barrel, the Tier 3 sulfur control costs increases from 0.65 c/gal to 0.73 c/gal.

We also estimated annual aggregate costs, including the amortized capital costs, associated with the new fuel standard. When the 10 ppm gasoline sulfur standard is fully phased in 2020, we estimate that the sulfur standard

would cost \$790 million in that year. Figure VII-1 shows the distribution of refinery costs over the accumulated

gasoline volume for the fully phased in 10 ppm sulfur standard.

**Figure VII-1 Tier 3 Sulfur Control Costs**

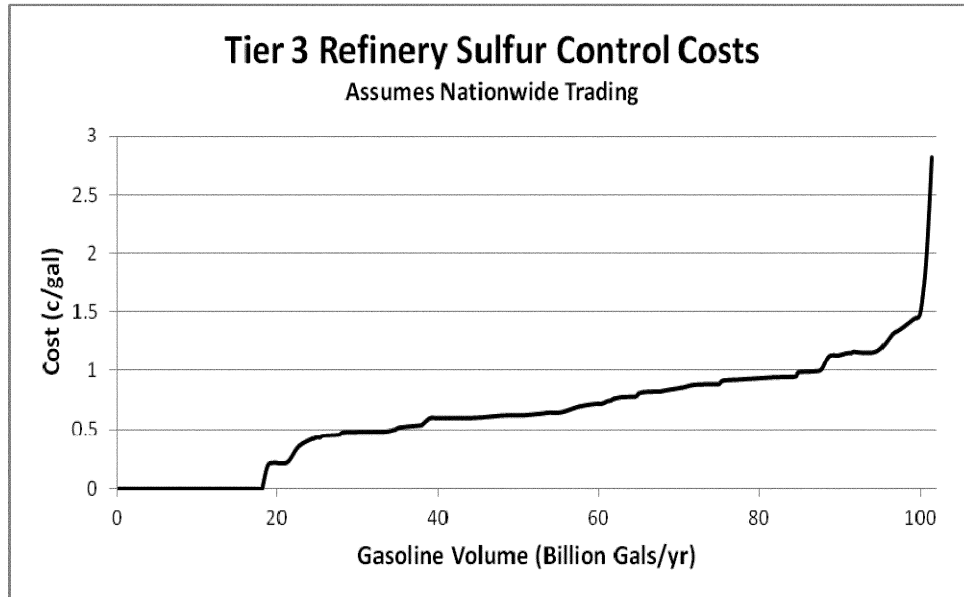

Figure VII-1 shows that for almost 20 percent of the gasoline pool, refineries will not incur any cost under Tier 3, either because these refineries are already very low in sulfur because they do not have FCC units, or because the refineries are purchasing credits.<sup>540</sup> For another 10 percent of the gasoline pool, the refinery costs are in the 0–0.5 cent/

gal range. For the next 55 percent of the gasoline pool, the refinery costs are in the 0.5–1.0 c/gal range. For the last 15 percent of the gasoline pool, the refinery costs range from 1.0 to 2.1 c/gal for revamps, with the exception of one refinery at 2.8 c/gal representing the cost for the sole grassroots unit which our modeling estimates would need to

be installed. All other refiners that may otherwise need to install a grassroots hydrotreater were able to comply more cheaply through the purchase of credits.

Figure VII-2 summarizes our estimated U.S. gasoline sulfur levels over the accumulated gasoline volume post Tier 3.

<sup>540</sup> Refineries purchasing credits will incur a cost for the purchase of the credit, but since we do not

know what the price of a credit will be, we allocate all the cost for complying with Tier 3 solely on the

refineries adding capital and incurring operating costs to comply with Tier 3.

Figure VII-2 Estimated U.S. Gasoline Sulfur Levels Post Tier 3

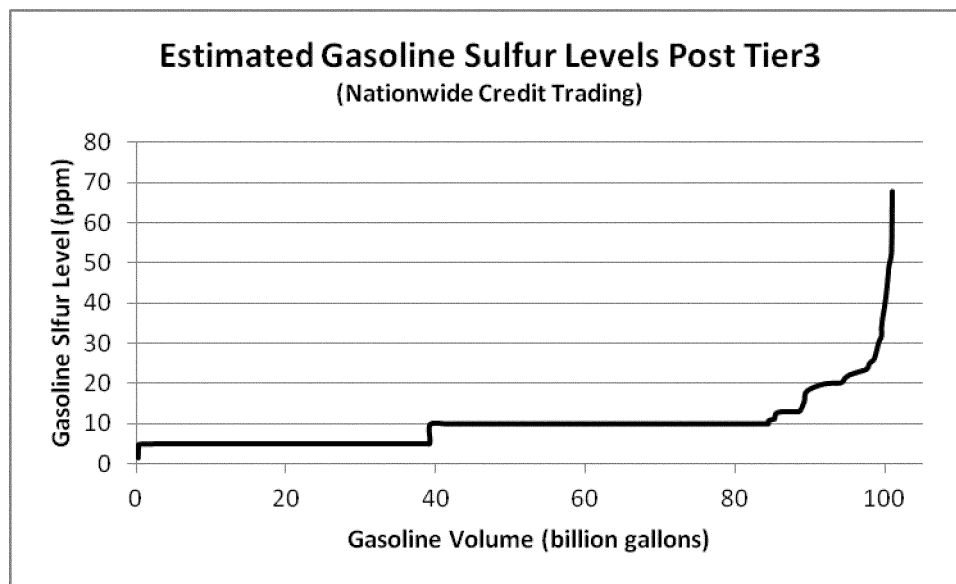

Figure VII-2 shows that over 80 percent of the gasoline pool would predominately be either 5 or 10 ppm representing the two sulfur levels to which we assumed that refiners would desulfurize their gasoline pool. For the rest of the gasoline pool, the refineries are clearly purchasing credits and their sulfur levels range from 10 to nearly 70 ppm. As discussed earlier, lacking more detailed refinery-specific information, for these refineries we assumed that they take no action to reduce their gasoline sulfur below their Tier 2 levels. In reality these refineries are likely to take some very cost-effective steps to partially reduce their gasoline sulfur and not rely solely on credits to demonstrate compliance with Tier 3. Were we able to model such refinery changes, it would only serve to further lower our projected costs.

#### 4. Other Cost Estimates

Three other cost studies were conducted to estimate the cost of additional reduction in gasoline sulfur. All of these studies show average costs of less than 2 cents per gallon.

One of these studies was conducted in October 2011 by the International Council for Clean Transportation (ICCT).<sup>541</sup> ICCT retained Mathpro for this analysis. ICCT had Mathpro analyze a 10 ppm average gasoline sulfur standard in PADDs 1-4 (generally

speaking, PADDs 1-4 represents the part of the U.S. east of, and including, the Rocky Mountain states). The cost presented by ICCT is that complying with a 10 ppm average sulfur standard would cost refiners on average 0.8 cents per gallon. This cost was calculated based on a before-tax 7 percent return on investment, the same capital amortization basis that we use for our cost analysis. The cost of a 10 ppm average gasoline sulfur control standard estimated by ICCT is very close to our cost estimate.

API retained Baker and O'Brien to study the cost of additional sulfur control using a refinery-by-refinery cost approach with Baker and O'Brien's Prism model.<sup>542</sup> API studied a 10 ppm average gasoline sulfur standard, however, API included a very stringent 20 ppm cap standard which did not allow for an ABT program to optimize refinery investments and minimize overall costs (an estimate of the impact of the 20 ppm cap standard using API information is presented below).

API made a series of conclusions based on the study. Perhaps the most important conclusion is that no refinery would shut down as a result of the 10 ppm gasoline sulfur control standard, even though API did not study the flexibilities of an ABT program and used excessively high capital costs for a grassroots FCC posttreater (see below). API did not report average costs, but

reported the marginal costs for the cost study. Marginal costs reflect the cost of the program to the refinery or refineries which would incur the highest costs, assuming that the highest cost refineries would set the price (or in this case, the price increase) of gasoline. Since they assumed a 20 ppm cap precluding refiners from utilizing the ABT program, it required virtually all refiners to incur capital costs thereby driving up marginal costs. The report concluded that marginal costs after the imposition of a 10 ppm gasoline sulfur program would increase the price of gasoline by 6 to 9 cents per gallon in most markets. API did not define how its statement "in most markets" would apply to the U.S. gasoline supply. API also did not provide any justification why it assumed that the refineries that would experience the highest desulfurization cost under Tier 3 would also be the same refineries which set the gasoline price in the gasoline market today.

Although API did not provide an average gasoline desulfurization cost in its report, we could calculate an average cost based on the gasoline volume and total annual costs provided. The total cost reported in the report for the 10 ppm average gasoline sulfur standard is \$2390MM/yr and the non-California gasoline volume is 7343 thousand barrels per day. This results in an average per-gallon desulfurization cost of \$0.89/bbl or 2.12 c/gal. The difference between the average cost and marginal cost (price increase) that API is projecting is profit. Thus, API's analysis would suggest that the oil industry would profit from 10 ppm low sulfur

<sup>541</sup> Mathpro (October 2011). Refining Economics of a National Low Sulfur, Low RVP Gasoline Standard, Performed for The International Council for Clean Transportation. Available at: [http://www.theicct.org/sites/default/files/publications/ICCT04\\_Tier3\\_Report\\_Final\\_v4\\_All.pdf](http://www.theicct.org/sites/default/files/publications/ICCT04_Tier3_Report_Final_v4_All.pdf). Accessed December 12, 2011.

<sup>542</sup> Baker and O'Brien, Addendum to Potential Supply and Cost Impacts of Lower Sulfur, Lower RVP Gasoline; prepared for The American Petroleum Institute. March 2012. Available at: [http://www.api.org/Newsroom/upload/110715\\_LowerSulfur\\_LowerRVP\\_Final.pdf](http://www.api.org/Newsroom/upload/110715_LowerSulfur_LowerRVP_Final.pdf).

standard by roughly 4 to 7 cents per gallon, or roughly \$4 to \$8 billion dollars per year as a result of gasoline sulfur control.

The average cost of the 10 ppm average gasoline sulfur standard described above was calculated using API's methodology for amortizing capital investments. To assess the costs consistent with OMB's guidance for our rulemakings and to allow a direct comparison between the API cost study and our cost study, we adjusted the API costs to be on a similar basis as our costs. We adjusted the API costs to reflect a before-tax 7 percent return on investment (ROI) for capital invested for the hydrotreaters and hydrogen plants instead of the after-tax 10 percent ROI used by API. This lowered the API estimated costs from 2.12 c/gal to 1.58 c/gal. API's 1.58 cents per gallon cost is still higher than our 0.65 c/gal cost with an ABT program that assumes nationwide trading of credits, and higher than our 0.86 c/gal for the case which assumes no ABT program. The remaining difference between our estimated costs and those by API are driven by API's assumptions for the capital costs that would be incurred for adding grassroots FCC posttreaters, or revamping existing ones.

While little detail is provided by API about what hardware comprises their desulfurization units, the inside battery limits (ISBL) and total capital costs for the FCC posttreaters and FCC pretreaters are provided in API's report. API's FCC pretreaters capital costs are consistent with the capital costs that we have used for this unit. However, the FCC posttreater costs used by API are much higher than what we used and have been used in the past by others. API's capital cost for a grassroots FCC posttreater is \$228 million for a 35,000 bbl/day unit, or \$6540 per/bbl per day. API's capital cost includes the outside battery limit (OSBL) costs.

We were able to obtain a document which shed some light on the methodology that API used to develop its FCC posttreater capital costs.<sup>543</sup> When the proposed rule was being reviewed by the Office of Management Budget (OMB) at the end of 2012, API provided to OMB a document which provided answers to questions that EPA and EIA posed to API and Baker and O'Brien back in mid-2011 when API was about to release its study of gasoline sulfur control costs. According to the document, API collected investment cost information for 5 FCC naphtha

hydrotreater projects that were apparently completed by refiners to comply with Tier 2, and not the low severity capital projects that refiners would use to comply with Tier 3. No specific information was provided for any of those projects to determine whether each of those projects was typical, or if they included atypical costs add-ons for other refinery upgrades, which is common when refiners make changes in response to an environmental regulation. API adjusted the capital cost to be on a 35kbbbl/day basis and the capital costs were inflated from the year that the project was constructed in the 2003 to 2005 timeframe, to mid-2009 dollars using the Nelson-Farrar Refinery Construction Index. API then reviewed the final capital investment costs for FCC posttreaters with several other members that had recently installed FCC posttreaters. One refiner which had presented an itemized list of capital costs for a recent FCC posttreater installation stated that the costs for their recent FCC posttreater installation were two times higher than the Nelson-Farrar adjusted costs, so API doubled the costs. The information provided did not state whether these later installations used to double the estimated posttreater costs were in the U.S. where engineering and construction are readily available or overseas where most recent FCC posttreater installations have been occurring and where the installation costs could be much higher.

In contrast, the ISBL capital cost that we used for a grassroots FCC posttreater is \$1500/bbl-day for a 30,000 bbl/day grassroots unit, which increases to \$2430/bbl/day when the offsite and contingency costs are added on. Thus, the API capital costs of \$6540 are about 2 and one half times higher than the capital costs that we are using for a grassroots FCC posttreater. To check our capital costs, we found other capital cost estimates to which we could compare our costs, including the capital costs used by the National Petroleum Council when it studied the cost of gasoline desulfurization prior to Tier 2. Compared to the average of the rest of the capital cost estimates, the API capital cost for FCC posttreater is about four times higher. Compared to the next highest cost estimate, which is the FCC posttreater capital cost from the Jacobs data base in the Haverly refinery cost model that we use,<sup>544</sup> the API capital costs are almost two times higher.

As alluded to earlier, an important distinction must be made with respect to the severity of desulfurization for the capital cost comparison made for complying with Tier 2 versus Tier 3. For complying with the Tier 2 gasoline sulfur standard (Jacobs and NPC costs), a typical refinery would have installed an FCC posttreater to desulfurize the FCC naphtha from about 800 ppm down to about 75 ppm, a 725 ppm, or a 91 percent sulfur reduction. In the case of a grassroots posttreater that would be installed for Tier 3, the posttreater would treat FCC naphtha already low in sulfur due to the pretreater installed before the FCC unit (these refineries are currently complying with Tier 2 using an FCC pretreater). Thus, the new grassroots FCC posttreater would only have to reduce the FCC naphtha from 100 ppm to 25 ppm, a much smaller 75 ppm or 75 percent sulfur reduction. A grassroots FCC posttreater installed for Tier 2 would typically remove 10 times more sulfur than one installed for Tier 3. This is important because a significant portion of the FCC posttreater capital cost is devoted to avoiding the recombination reactions which occur when hydrogen sulfide concentrations are high and react with the olefins contained in the FCC naphtha. Thus, a grassroots FCC posttreater installed for Tier 3 would be expected to be significantly lower in capital cost compared to a Tier 2 FCC posttreater. When API presented the costs, they stated that their grassroots capital costs were based on an actual installation for the Tier 2 program. This is likely one important reason why the capital costs used by API for its cost study of the Tier 3 program are so high. Another way to assess the API capital cost for the FCC posttreaters is to compare it to the FCC pretreater cost that API is using. FCC pretreaters are much higher pressure units and use more expensive metallurgy than FCC posttreaters and, for these two reasons, are much more expensive than FCC posttreaters on a per-barrel basis. However, API's FCC posttreater capital costs are about 50 percent more expensive than its own FCC pretreater capital costs, which is inconsistent with the design requirements of the units.

API's estimated range of capital cost for revamping an FCC posttreater is also higher than our range of capital cost for revamping an FCC posttreater, when assessing the revamped costs as a percentage of the capital cost for a grassroots unit. API estimates that revamping an FCC posttreater would cost

<sup>543</sup> Document entitled "Follow-up Questions from EPA-EIA" (no other information provided on the document).

<sup>544</sup> The installed capital cost for an FCC posttreater from the Jacobs data base was adjusted to current year dollars. This estimated installed capital cost is

several years old and may not represent Jacobs current cost estimate for a FCC posttreater.

30 to 70 percent of the capital cost for a grassroots FCC unit. Our capital cost estimate for revamping an FCC naphtha posttreaters range from 17 to 50 percent of the capital cost for a grassroots FCC posttreater, however, most of the revamps are estimated to cost at the lower end of that range.

As discussed above, an important reason why API's projected capital costs for complying with Tier 3 are so high is that API assumed a 20 ppm cap standard in addition to the 10 ppm average standard that it studied. The 20 ppm cap standard eliminates the possibility of realizing the cost savings of an ABT program. After we proposed the Tier 3 rule, API presented to EPA, in its comments on the proposed rulemaking, its estimate for the cost of finalizing a more stringent cap standard. The study, which was contracted to the Turner, Mason & Company, estimated that a 20 ppm cap standard would increase the capital cost of complying with a 10 ppm average standard by \$6.1 billion. If we subtract the \$6.1 billion in capital costs attributed to the 20 ppm cap standard from the \$9.8 billion in total capital costs from API's Addendum report which estimated the cost of complying with Tier 3, and adjust the fixed operating costs accordingly, the API estimated average cost (not marginal cost) for complying with Tier 3 decreases to 0.97 c/gal. In addition to the questionable capital costs assumed for FCC posttreaters as discussed above, this information from API on its estimated cost of complying with a 20 ppm cap standard helps to answer an important question of why API estimated average cost was still higher than the other studies after other cost adjustments were made. This final adjustment to the API costs makes the estimated API costs for complying with Tier 3 right in line with the other cost studies. This adjusted API cost,

however, still does include the cost saving aspects of credit averaging and trading since the API analysis assumed that each refinery meets the 10 ppm average sulfur standard. Thus, to compare this most recent cost adjustment of API costs to our cost study, our 0.87 c/gal cost for no ABT program would be the most appropriate cost for comparison (see Chapter IX for alternative costs). The adjusted API cost and our cost are only 0.1 c/gal different.

Our assessment of the API study is supported by work performed by The Emissions Control Technology Association (ECTA) which retained personnel within Navigant Economics. That study assessed the costs of a 10 ppm average gasoline sulfur standard and also evaluated the ICCT and API cost studies.<sup>545</sup> The authors made a number of conclusions. After reviewing both the ICCT and API studies, the authors found that a primary difference in estimated costs between the two studies was the capital costs. The authors contacted vendor companies that license FCC posttreater technologies and surveyed the companies to find out what the capital costs are for a FCC posttreater. As a result of the survey, the report authors concluded that API's capital costs were too high, and those used in the ICCT study were about right. The authors found that Baker and O'Brien has a history of exaggerating the economic impacts of EPA rules, citing the costs and other impacts of its analysis of the 2007 on-highway heavy-duty proposed rulemaking. The authors concluded that the impact of a 10 ppm gasoline sulfur standard on the average refining cost would likely be closer to the 1 cent per gallon estimate by the ICCT study. Furthermore, the report's authors also pointed out that the marginal cost analysis conducted by API did not consider the averaging banking and trading (ABT) program that we

adopted, which would reduce the marginal costs of the Tier 3 final rule.

### C. Summary of Program Costs

While the estimated costs for the separate vehicle and fuel programs are presented in Sections VII.A and VII.B, respectively, it is useful to present the combined cost estimates representing the full Tier 3 program.

We have chosen to use an annual cost format to represent the combined vehicle and program costs because this approach provides the most straightforward means for comparing vehicle costs to fuel costs, and for demonstrating the total cost impact of our final program. This approach to combined costs also provides a basis for comparing the program costs to the projected benefits as described more fully in Section VIII.

Table VII-6 below shows our estimated program costs by year. The total program costs for the final rule are lower than those projected for the proposal due to several reasons. First, the vehicle program costs are lower due in part to applying the per vehicle costs to vehicles excluding those sold in California and the states that have adopted the LEV III program. A complete discussion of the differences in vehicle costs between the proposal and final rule are outlined above in Section VII.A.1. Second, the fuel program costs are also lower than the values projected for the proposal due to lower refinery cost estimates, as discussed above in Section VII.B. In addition, the annual fuel consumption projections are lower in the final rule because they reflect the inclusion of the Light-Duty Greenhouse Gas and Fuel Economy Standards for 2017-2025 model years. Complete details of this analysis can be found in the RIA Chapter 8.

TABLE VII-6 TOTAL ANNUAL VEHICLE AND FUEL CONTROL COSTS, 2011\$<sup>a</sup>

Year	Vehicle exhaust emission control costs (\$million)	Vehicle evaporative emission control costs (\$million)	Vehicle operating costs (\$million)	Facility costs (\$million)	Fuel sulfur control costs (\$million)	Total program costs (\$million)
2016 .....	\$0	\$0	\$0	\$21	\$0	\$21
2017 .....	268	26	0	4	804	1,101
2018 .....	539	73	-1	4	799	1,414
2019 .....	579	72	-2	4	794	1,447
2020 .....	599	98	-3	4	787	1,484
2021 .....	630	97	-5	4	778	1,503
2022 .....	640	121	-6	4	768	1,526
2023 .....	639	116	-8	4	758	1,509
2024 .....	653	114	-9	4	748	1,509
2025 .....	668	113	-11	4	737	1,510

<sup>545</sup> Schink, George R., Singer, Hal J., Economic Analysis of the Implications of Implementing EPA's

Tier 3 Rules, prepared for the Emissions Control Technology Association, June 14, 2012.

TABLE VII—6 TOTAL ANNUAL VEHICLE AND FUEL CONTROL COSTS, 2011\$<sup>a</sup>—Continued

Year	Vehicle exhaust emission control costs (\$million)	Vehicle evaporative emission control costs (\$million)	Vehicle operating costs (\$million)	Facility costs (\$million)	Fuel sulfur control costs (\$million)	Total program costs (\$million)
2030 .....	664	113	-19	4	696	1,457

<sup>a</sup> These estimates include costs associated with: (a) The Tier 3 vehicle standards in all states except California and the states that have adopted the LEV III program; and, (b) the Tier 3 fuel standards in all states except California.

### VIII. What are the estimated benefits of the rule?

This section presents EPA's analysis of the criteria pollutant-related health and environmental impacts that will occur as a result of the final Tier 3 standards. The vehicles and fuels subject to the standards are significant sources of mobile source air pollution such as direct PM, NO<sub>x</sub>, SO<sub>x</sub>, VOCs and air toxics. The standards will reduce exhaust and evaporative emissions of these pollutants from vehicles. Emissions of NO<sub>x</sub> (a precursor to ozone formation and secondarily-formed PM<sub>2.5</sub>), SO<sub>x</sub> (a precursor to secondarily-formed PM<sub>2.5</sub>), VOCs (a precursor to ozone formation and, to a lesser degree, secondarily-formed PM<sub>2.5</sub>) and directly-emitted PM<sub>2.5</sub> contribute to ambient concentrations of PM<sub>2.5</sub> and ozone. Exposure to ozone, PM<sub>2.5</sub>, and air toxics is linked to adverse human health impacts such as premature deaths as well as other important public health and environmental effects.

For the final rulemaking, we have estimated the health and environmental impacts in 2030, representing projected impacts associated with a year when the program is fully implemented and when most of the fleet is turned over. Overall, we estimate that the standards will lead to a net decrease in PM<sub>2.5</sub>- and ozone-related health impacts. The estimated decrease in population-weighted national average PM<sub>2.5</sub> exposure results in a net decrease in adverse PM-related human health impacts (the decrease in national population-weighted annual average PM<sub>2.5</sub> is 0.04 µg/m<sup>3</sup> in 2030). The estimated decrease in population-weighted national average ozone exposure results in a net decrease in ozone-related health impacts (population-weighted maximum 8-hour average ozone decreases by 0.32 ppb in 2030).<sup>546</sup>

<sup>546</sup> Note that the national, population-weighted PM<sub>2.5</sub> and ozone air quality metrics presented in this Section represent an average for the entire, gridded U.S. CMAQ domain. These are different than the population-weighted PM<sub>2.5</sub> and ozone design value metrics presented in Chapter 7, which represent the average for areas with a current air quality monitor.

Using the lower end of EPA's range of preferred premature mortality estimates (Krewski et al., 2009 for PM<sub>2.5</sub> and Bell et al., 2004 for ozone),<sup>547 548</sup> we estimate that by 2030, implementation of the standards will reduce approximately 770 premature mortalities annually and will yield between 6.7 and 7.4 billion in total annual benefits, depending on the discount rate used.<sup>549</sup> The upper end of the range of avoided premature mortality estimates associated with the standards (based on Lepeule et al., 2012 for PM<sub>2.5</sub> and Levy et al., 2005 for ozone)<sup>550 551</sup> results in approximately 2,000 premature mortalities avoided in 2030 and will yield between 18 and 19 billion in total benefits. Thus, even using the lower end of the range of premature mortality estimates, the health impacts of the final standards presented in this rule are projected to be substantial.

We note that of necessity, decisions on the emissions and other elements used in the air quality modeling were made early in the analytical process for the final rulemaking. For this reason, the modeled changes in emissions used to support the air quality and benefits

<sup>547</sup> Krewski, D., M. Jerret, R.T. Burnett, R. Ma, E. Hughes, Y. Shi, et al. (2009). Extended follow-up and spatial analysis of the American Cancer Society study linking particulate air pollution and mortality. *HEI Research Report, 140*, Health Effects Institute, Boston, MA.

<sup>548</sup> Bell, M.L., et al. (2004). Ozone and short-term mortality in 95 U.S. urban communities, 1987–2000. *Journal of the American Medical Association, 292(19)*, 2372–2378.

<sup>549</sup> The monetized value of PM<sub>2.5</sub>-related mortality accounts for a twenty-year segmented cessation lag. To discount the value of premature mortality that occurs at different points in the future, we apply both a 3 and 7 percent discount rate. We also use both a 3 and 7 percent discount rate to value PM-related nonfatal heart attacks (myocardial infarctions). Nonfatal myocardial infarctions (MI) are valued using age-specific cost-of-illness values that reflect lost earnings and direct medical costs over a 5-year period following a nonfatal MI.

<sup>550</sup> Lepeule J, Laden F, Dockery D, Schwartz J (2012). *Chronic Exposure to Fine Particles and Mortality: An Extended Follow-Up of the Harvard Six Cities Study from 1974 to 2009*. *Environ Health Perspect.* Jul;120(7):965–70.

<sup>551</sup> Levy, J.I., S.M. Chemerynski, and J.A. Sarnat. (2005). Ozone exposure and mortality: an empiric bayes metaregression analysis. *Epidemiology. 16(4)*, 458–68.

analyses are slightly different than those used to represent the final emissions impacts of the Tier 3 standards. The magnitude of the differences is small, however, and for that reason we do not expect these differences to materially impact our cost-benefit conclusions. See Chapter 7.2.1.1 of the RIA for more details.

#### A. Overview

We base our analysis of the program's impact on human health on peer-reviewed studies of air quality and human health effects.<sup>552 553</sup> These methods are described in more detail in Chapter 8 of the RIA. Our benefits methods are consistent with the RIA that accompanied the final revisions to the National Ambient Air Quality Standards (NAAQS) for Particulate Matter and the final ozone NAAQS. To model the ozone and PM air quality impacts of the final standards, we used the Community Multiscale Air Quality (CMAQ) model (see Chapter 7.2.2 of the RIA that accompanies this preamble). The modeled ambient air quality data serves as an input to the Environmental Benefits Mapping and Analysis Program version 4.065 (BenMAP).<sup>554</sup> BenMAP is a computer program developed by the U.S. EPA that integrates a number of the modeling elements used in previous analyses (e.g., interpolation functions, population projections, health impact functions, valuation functions, analysis and pooling methods) to translate modeled air concentration estimates into health effects incidence estimates and monetized benefits estimates.

The range of total monetized ozone- and PM-related health impacts projected

<sup>552</sup> U.S. Environmental Protection Agency. (2012). *Regulatory Impact Analysis for the Final Revisions to the National Ambient Air Quality Standards for Particulate Matter*. Prepared by: Office of Air and Radiation, EPA-452/R-12-005. Retrieved August 14, 2013 at <http://www.epa.gov/ttn/ecas/ria.html>.

<sup>553</sup> U.S. Environmental Protection Agency. (2008). *Final Ozone NAAQS Regulatory Impact Analysis*. Prepared by: Office of Air and Radiation, Office of Air Quality Planning and Standards. Retrieved August 14, 2013 at <http://www.epa.gov/ttn/ecas/ria.html>.

<sup>554</sup> Information on BenMAP, including downloads of the software, can be found at <http://www.epa.gov/ttn/ecas/benmodels.html>.



in 2030 is presented in Table VIII–1. We present total benefits based on the PM- and ozone-related premature mortality

function used. The benefits ranges therefore reflect the addition of each estimate of ozone-related premature

mortality (each with its own row in Table VIII–1) to estimates of PM-related premature mortality.

TABLE VIII–1—ESTIMATED 2030 MONETIZED PM- AND OZONE-RELATED HEALTH BENEFITS  
2030 Total ozone and PM benefits—PM mortality derived from American Cancer Society analysis and six-cities analysis<sup>a</sup>

Premature ozone mortality function	Reference	Total benefits (billions, 2011\$, 3% discount rate) <sup>b,c</sup>	Total benefits (billions, 2011\$, 7% discount rate) <sup>b,c</sup>
Multi-city analyses .....	Bell et al., 2004 .....	Total: \$7.4–\$15 .....	Total: \$6.7–\$14.
		PM: \$6.0–\$14 .....	PM: \$5.4–\$12.
		Ozone: \$1.1 .....	Ozone: \$1.1.
	Huang et al., 2005 .....	Total: \$7.9–\$16 .....	Total: \$7.3–\$14.
		PM: \$6.0–\$14. ....	PM: \$5.4–\$12.
		Ozone: \$1.7 .....	Ozone: \$1.7.
	Schwartz, 2005 .....	Total: \$8.0–\$16 .....	Total: \$7.3–\$14.
		PM: \$6.0–\$14 .....	PM: \$5.4–\$12.
		Ozone: \$1.7 .....	Ozone: \$1.7.
Meta-analyses .....	Bell et al., 2005 .....	Total: \$9.8–\$18 .....	Total: \$9.2–\$16.
		PM: \$6.0–\$14 .....	PM: \$5.4–\$12.
		Ozone: \$3.6 .....	Ozone: \$3.6.
	Ito et al., 2005 .....	Total: \$11–\$19 .....	Total: \$11–\$18.
		PM: \$6.0–\$14 .....	PM: \$5.4–\$12.
		Ozone: \$4.9 .....	Ozone: \$4.9.
	Levy et al., 2005 .....	Total: \$11–\$19 .....	Total: \$11–\$18.
		PM: \$6.0–\$14 .....	PM: \$5.4–\$12.
		Ozone: \$5.0 .....	Ozone: \$5.0.

<sup>a</sup> Total includes premature mortality-related and morbidity-related ozone and PM<sub>2.5</sub> estimated benefits. Range was developed by adding the estimate from the ozone premature mortality function to the estimate of PM<sub>2.5</sub>-related premature mortality derived from either the ACS study (Krewski et al., 2009) or the Six-Cities study (Lepeule et al., 2012). Range also reflects alternative estimates of non-fatal heart attacks avoided based on either Peters et al. (2001) or a pooled estimate of four studies.

<sup>b</sup> Note that total benefits presented here do not include a number of unquantified benefits categories. A detailed listing of unquantified health and welfare effects is provided in Table VIII–2.

<sup>c</sup> Results reflect the use of both a 3 and 7 percent discount rate, as recommended by EPA’s Guidelines for Preparing Economic Analyses and OMB Circular A–4. Results are rounded to two significant digits for ease of presentation and computation. Totals may not sum due to rounding.

The benefits analysis presented in this chapter incorporates an array of policy and technical changes that the Agency has adopted since the Tier 3 proposal’s draft RIA. These changes reflect EPA’s work to update PM-related benefits reflected in the most recent PM NAAQS.<sup>555</sup> Below we note the aspects of this analysis that differ from the Tier 3 proposal’s draft RIA:<sup>556</sup>

1. *Incorporation of the newest American Cancer Society (ACS) mortality study and newest Harvard Six Cities mortality study.* In 2012, Lepeule et al. published an extended analysis of the Six Cities cohort.<sup>557</sup> Compared to the study it replaces (Laden et al.,

2006),<sup>558</sup> this new analysis follows the cohort for a longer time and includes more years of PM<sub>2.5</sub> monitoring data. The all-cause PM<sub>2.5</sub> mortality risk coefficient drawn from Lepeule et al. is roughly similar to the Laden et al. risk coefficient applied in the EPA’s recent analyses of long-term PM<sub>2.5</sub> mortality and has narrower confidence intervals.

In 2009, the Health Effects Institute published an extended analysis of the ACS cohort (Krewski et al., 2009).<sup>559</sup> Compared to the study it replaces (Pope et al., 2002),<sup>560</sup> this new analysis incorporates a number of methodological improvements.<sup>561</sup> The

all-cause PM<sub>2.5</sub> mortality risk estimate drawn from Krewski et al. (2009) is identical to the Pope et al. (2002) risk estimate applied in recent EPA analyses of long-term PM<sub>2.5</sub> mortality but has narrower confidence intervals.

2. *Updated health endpoints.* We have removed the quantification of chronic bronchitis from our main analysis. This change is consistent with the findings of the PM Integrated Science Assessment (ISA) that the evidence for an association between long-term exposure to PM<sub>2.5</sub> and respiratory effects is more tenuous.<sup>562</sup>

3. *Updated demographic data.* We updated the population demographic data in BenMAP to reflect the 2010 Census and future projections based on economic forecasting models developed by Woods and Poole, Inc.<sup>563</sup> These data replace the earlier demographic

<sup>555</sup> U.S. Environmental Protection Agency. (2012). Regulatory Impact Analysis for the Final Revisions to the National Ambient Air Quality Standards for Particulate Matter. Prepared by: Office of Air and Radiation, EPA–452/R–12–005. Retrieved August 14, 2013 at <http://www.epa.gov/ttn/ecas/ria.html>.

<sup>556</sup> U.S. Environmental Protection Agency. (2013). Draft Regulatory Impact Analysis: Tier 3 Motor Vehicle Emission and Fuel Standards. Prepared by: Office of Air and Radiation. EPA–420–D–13–002. Retrieved October 18, 2013 at <http://www.epa.gov/otaq/documents/tier3/420d13002.pdf>.

<sup>557</sup> Lepeule J., Laden F., Dockery D., Schwartz J. 2012. *Chronic Exposure to Fine Particles and Mortality: An Extended Follow-Up of the Harvard Six Cities Study from 1974 to 2009.* Environ Health Perspect. Jul;120(7):965–70.

<sup>558</sup> Laden, F., J. Schwartz, F.E. Speizer, and D.W. Dockery. 2006. “Reduction in Fine Particulate Air Pollution and Mortality.” *American Journal of Respiratory and Critical Care Medicine* 173:667–672.

<sup>559</sup> Krewski, D., M. Jerret, R.T. Burnett, R. Ma, E. Hughes, Y. Shi, et al. (2009). Extended follow-up and spatial analysis of the American Cancer Society study linking particulate air pollution and mortality. *HEI Research Report, 140*, Health Effects Institute, Boston, MA.

<sup>560</sup> Pope, C.A., III, R.T. Burnett, M.J. Thun, E.E. Calle, D. Krewski, K. Ito, and G.D. Thurston. 2002. “Lung Cancer, Cardiopulmonary Mortality, and Long-term Exposure to Fine Particulate Air Pollution.” *Journal of the American Medical Association* 287:1132–1141.

<sup>561</sup> Refer to the 2012 PM NAAQS RIA for more detail regarding the studies themselves.

<sup>562</sup> U.S. Environmental Protection Agency (U.S. EPA). 2009. Integrated Science Assessment for Particulate Matter (Final Report). EPA–600–R–08–139F. National Center for Environmental Assessment—RTP Division. December. Available on the Internet at <http://cfpub.epa.gov/ncea/cfm/recordisplay.cfm?deid=216546>.

<sup>563</sup> Woods & Poole Economics Inc. 2012. Population by Single Year of Age. CD–ROM. Woods & Poole Economics, Inc. Washington, DC.

projection data from Woods and Poole (2011).<sup>564</sup>

4. *Incorporation of new morbidity studies.* Since the publication of the 2004 Criteria Document for Particulate Matter,<sup>565</sup> the publication of the more recent PM ISA,<sup>566</sup> and the Provisional Assessment of Recent Studies on Health Effects of Particulate Matter Exposure (“Provisional Assessment”),<sup>567</sup> the epidemiological literature has produced several new studies examining the association between short-term PM<sub>2.5</sub> exposure and acute myocardial infarctions, respiratory and cardiovascular hospitalizations, respiratory and cardiovascular emergency department visits, acute respiratory symptoms and exacerbation of asthma, respiratory and cardiovascular hospitalizations. Upon careful evaluation of this new literature, we added several new studies to our health impact assessment; in many cases we have replaced older single-city

time-series studies with newer multi-city time-series analyses.

5. *Updated the survival rates for non-fatal acute myocardial infarctions.* Based on recent data from Agency for Healthcare Research and Quality’s Healthcare Utilization Project National Inpatient Sample database,<sup>568</sup> we identified death rates for adults hospitalized with acute myocardial infarction stratified by age. These rates replace the survival rates from Rosamond et al. (1999).<sup>569</sup>

6. *Updated hospital cost-of-illness (COI), including median wage data.* In previous benefits analyses, estimates of hospital charges and lengths of hospital stays were based on discharge statistics provided by the Agency for Healthcare Research and Quality’s Healthcare Utilization Project National Inpatient Sample (NIS) database for 2000.<sup>570</sup> The version of BenMAP (version 4.0.65) used in this analysis updated this information to use the 2007 database.

The data source for the updated median annual income is the 2007 American Community Survey.

The benefits in Table VIII–1 include all of the estimated human health impacts we are able to quantify and monetize at this time. However, the full complement of human health effects associated with PM, ozone and other criteria pollutants remain unquantified because of current limitations in methods and/or available data. We have not quantified a number of known or suspected health effects linked with these pollutants for which appropriate health impact functions are not available or which do not provide easily interpretable outcomes (e.g., changes in heart rate variability). These are listed in Table VIII–2. As a result of these omissions, the health benefits quantified in this section are likely underestimates of the total benefits attributable to the final standards.

TABLE VIII–2—ESTIMATED QUANTIFIED AND UNQUANTIFIED HEALTH EFFECTS

Benefits category	Specific effect	Effect has been quantified	Effect has been monetized	More information
<b>Improved Human Health</b>				
Reduced incidence of premature mortality and morbidity from exposure to PM <sub>2.5</sub> .	Adult premature mortality based on cohort study estimates and expert elicitation estimates (age >25 or age >30).	✓	✓	PM NAAQS RIA, Section 5.6.
	Infant mortality (age <1) .....	✓	✓	PM NAAQS RIA, Section 5.6.
	Non-fatal heart attacks (age >18) .....	✓	✓	PM NAAQS RIA, Section 5.6.
	Hospital admissions—respiratory (all ages).	✓	✓	PM NAAQS RIA, Section 5.6.
	Hospital admissions—cardiovascular (age >20).	✓	✓	PM NAAQS RIA, Section 5.6.
	Emergency department visits for asthma (all ages).	✓	✓	PM NAAQS RIA, Section 5.6.
	Acute bronchitis (age 8–12) .....	✓	✓	PM NAAQS RIA, Section 5.6.
	Lower respiratory symptoms (age 7–14).	✓	✓	PM NAAQS RIA, Section 5.6.
	Upper respiratory symptoms (asthmatics age 9–11).	✓	✓	PM NAAQS RIA, Section 5.6.
	Asthma exacerbation (asthmatics age 6–18).	✓	✓	PM NAAQS RIA, Section 5.6.
	Lost work days (age 18–65) .....	✓	✓	PM NAAQS RIA, Section 5.6.
	Minor restricted-activity days (age 18–65).	✓	✓	PM NAAQS RIA, Section 5.6.
	Chronic Bronchitis (age >26) .....	.....	.....	PM NAAQS RIA, Section 5.6. <sup>c</sup>
Emergency department visits for cardiovascular effects (all ages).	.....	.....	PM NAAQS RIA, Section 5.6. <sup>c</sup>	

<sup>564</sup> Woods & Poole Economics, Inc. (2011). 2012 Complete Economic and Demographic Data Source (CEDDS).

<sup>565</sup> U.S. Environmental Protection Agency (U.S. EPA). 2004. Air Quality Criteria for Particulate Matter. National Center for Environmental Assessment, Office of Research and Development, U.S. Environmental Protection Agency, Research Triangle Park, NC EPA/600/P-99/002bF. Available on the Internet at <<http://cfpub.epa.gov/ncea/cfm/recordisplay.cfm?deid=87903>>.

<sup>566</sup> U.S. Environmental Protection Agency (U.S. EPA). 2009. Integrated Science Assessment for Particulate Matter (Final Report). EPA-600-R-08-

139F. National Center for Environmental Assessment—RTP Division. December. Available on the Internet at <<http://cfpub.epa.gov/ncea/cfm/recordisplay.cfm?deid=216546>>.

<sup>567</sup> U.S. Environmental Protection Agency (U.S. EPA). 2012. Provisional Assessment of Recent Studies on Health Effects of Particulate Matter Exposure. EPA/600/R-12/056A. National Center for Environmental Assessment—RTP Division. December.

<sup>568</sup> Agency for Healthcare Research and Quality (AHRQ). 2009. HCUPnet, Healthcare Cost and Utilization Project. Rockville, MD. Available on the Internet at <<http://hcupnet.ahrq.gov>>. American

Lung Association (ALA). 1999. Chronic Bronchitis. Available on the Internet at <<http://www.lungusa.org/diseases/lungchronic.html>>.

<sup>569</sup> Rosamond, W., G. Broda, E. Kawalec, S. Rywik, A. Pajak, L. Cooper, and L. Chambless. 1999. “Comparison of Medical Care and Survival of Hospitalized Patients with Acute Myocardial Infarction in Poland and the United States.” American Journal of Cardiology 83:1180–1185.

<sup>570</sup> Agency for Healthcare Research and Quality (AHRQ). 2000. HCUPnet, Healthcare Cost and Utilization Project. Rockville, MD. Available on the Internet at <<http://hcupnet.ahrq.gov>>.

TABLE VIII-2—ESTIMATED QUANTIFIED AND UNQUANTIFIED HEALTH EFFECTS—Continued

Benefits category	Specific effect	Effect has been quantified	Effect has been monetized	More information
Reduced incidence of premature mortality and morbidity from exposure to ozone.	Strokes and cerebrovascular disease (age 50–79).	.....	.....	PM NAAQS RIA, Section 5.6. <sup>c</sup>
	Other cardiovascular effects (e.g., other ages).	.....	.....	PM ISA. <sup>a</sup>
	Other respiratory effects (e.g., pulmonary function, non-asthma ER visits, non-bronchitis chronic diseases, other ages and populations).	.....	.....	PM ISA. <sup>a</sup>
	Reproductive and developmental effects (e.g., low birth weight, pre-term births, etc.).	.....	.....	PM ISA. <sup>a,b</sup>
	Cancer, mutagenicity, and genotoxicity effects.	.....	.....	PM ISA. <sup>a,b</sup>
	Premature mortality based on short-term study estimates (all ages).	✓	✓	Ozone ISA. Ozone ISA. <sup>c</sup>
	Premature mortality based on long-term study estimates (age 30–99).	.....	.....	
	Hospital admissions—respiratory causes (age >65).	✓	✓	Ozone ISA.
	Hospital admissions—respiratory causes (age <2).	✓	✓	Ozone ISA.
	Emergency department visits for asthma (all ages).	✓	✓	Ozone ISA.
	Minor restricted-activity days (age 18–65).	✓	✓	Ozone ISA.
	School absence days (age 5–17) .....	✓	✓	Ozone ISA.
	Decreased outdoor worker productivity (age 18–65).	✓	✓	Ozone ISA.
	Reduced incidence of morbidity from exposure to air toxics.	Other respiratory effects (e.g., premature aging of lungs).	.....	.....
	Cardiovascular and nervous system effects.	.....	.....	Ozone ISA. <sup>b</sup>
	Reproductive and developmental effects.	.....	.....	Ozone ISA. <sup>b</sup>
	Cancer (benzene, 1,3-butadiene, formaldehyde, acetaldehyde), Anemia (benzene), Disruption of production of blood components (benzene), Reduction in the number of blood platelets (benzene), Excessive bone marrow formation (benzene), Depression of lymphocyte counts (benzene), Reproductive and developmental effects (1,3-butadiene), Irritation of eyes and mucus membranes (formaldehyde), Respiratory irritation (formaldehyde), Asthma attacks in asthmatics (formaldehyde), Asthma-like symptoms in non-asthmatics (formaldehyde), Irritation of the eyes, skin, and respiratory tract (acetaldehyde), Upper respiratory tract irritation and congestion (acrolein).	.....	.....	IRIS. <sup>a,b</sup>

<sup>a</sup> We assess these benefits qualitatively because we do not have sufficient confidence in available data or methods.

<sup>b</sup> We assess these benefits qualitatively because current evidence is only suggestive of causality or there are other significant concerns over the strength of the association.

<sup>c</sup> We assess these benefits qualitatively due to time and resource limitations for this analysis.

While there would be impacts associated with reductions in air toxic pollutant emissions that result from the final standards, we do not attempt to quantify and monetize those impacts (Section III presents the estimated emission reductions associated with the final standards). This is primarily

because currently available tools and methods to assess air toxics risk from mobile sources at the national scale are not adequate for extrapolation to incidence estimations or benefits assessment. The best suite of tools and methods currently available for assessment at the national scale are

those used in the National-Scale Air Toxics Assessment (NATA). The EPA Science Advisory Board specifically commented in their review of the 1996 NATA that these tools were not yet ready for use in a national-scale benefits analysis, because they did not consider the full distribution of exposure and

risk, or address sub-chronic health effects.<sup>571</sup> While EPA has since improved these tools, there remain critical limitations for estimating incidence and assessing benefits of reducing mobile source air toxics.

As part of the second prospective analysis of the benefits and costs of the Clean Air Act,<sup>572</sup> EPA conducted a case study analysis of the estimated health effects associated with reducing exposure to benzene in Houston from implementation of the Clean Air Act. While reviewing the draft report, EPA's Advisory Council on Clean Air Compliance Analysis concluded that "the challenges for assessing progress in health improvement as a result of reductions in emissions of hazardous air pollutants (HAPs) are daunting . . . due to a lack of exposure-response functions, uncertainties in emissions inventories and background levels, the difficulty of extrapolating risk estimates to low doses and the challenges of tracking health progress for diseases, such as cancer, that have long latency periods."<sup>573</sup> EPA continues to work to address these limitations; however, we did not have the methods and tools available for national-scale application in time for the analysis of the final standards.<sup>574</sup>

The reduction in air pollution emissions that will result from the final program also is projected to have "welfare" co-benefits in addition to human health benefits, including changes in visibility, materials damage, ecological effects from PM deposition, ecological effects from nitrogen and sulfur emissions, vegetation effects from ozone exposure, and climate effects.<sup>575</sup>

Despite our goal to quantify and monetize as many of the benefits as possible for the final rulemaking, the welfare co-benefits of the Tier 3 standards remain unquantified and non-monetized due to data, methodology, and resource limitations. As a result, the benefits quantified in this analysis are likely underestimates of the total benefits attributable to the final program. We refer the reader to Chapter 6 of the PM NAAQS RIA for a complete discussion of these welfare co-benefits.<sup>576</sup>

We received many comments from the public and interested stakeholders, many of which were supportive of the benefits analysis conducted in support of the rulemaking and some that were adverse. Several commenters (primarily associated with the fuels industry) were critical of a number of EPA assumptions and other aspects of the analysis.

As described more fully in the Summary and Analysis of Comments document that accompanies this rulemaking, EPA disagrees with the claims of these commenters. We base our analysis of the program's impact on human health and the environment on peer-reviewed studies of air quality and human health effects.<sup>577 578</sup> Our benefits methods are consistent with the RIA that accompanied the final revisions to the National Ambient Air Quality Standards (NAAQS) for Particulate Matter and the final ozone NAAQS. Our methods also undergo rigorous review by many independent expert panels, including the Science Advisory Board and the National Research Council. Our methods and assumptions reflect their guidance, review, and

recommendations. As a result, we believe our analysis reflects the state of the science for health impacts and benefits assessment.

The Agency also received many comments supportive of the benefits that the Tier 3 standards will achieve. This includes broad support from many non-governmental institutions, state and local governments, and private citizens.

*B. Quantified Human Health Impacts*

Table VIII-3 and Table VIII-4 present the core estimates of annual PM<sub>2.5</sub> and ozone health impacts, respectively, in the 48 contiguous U.S. states associated with the final standards for 2030. For each endpoint presented in Table VIII-3 and Table VIII-4, we provide both the mean estimate and the 90 percent confidence interval.

Using EPA's preferred estimates, based on the American Cancer Society (ACS) and Six-Cities studies and no threshold assumption in the model of mortality, we estimate that the final standards would result in between 660 and 1,500 cases of avoided PM<sub>2.5</sub>-related premature mortalities annually in 2030. A sensitivity analysis was also conducted to understand the impact of alternative concentration response functions suggested by experts in the field. When the range of expert opinion is used, we estimate between 130 and 2,200 fewer premature mortalities in 2030 (see Table 8.8 in the RIA that accompanies this action). For ozone-related premature mortality in 2030, we estimate a range of between 110 to 500 fewer premature mortalities.

TABLE VIII-3—ESTIMATED PM<sub>2.5</sub>-RELATED HEALTH IMPACTS<sup>a</sup>

Health effect	2030 Annual reduction in incidence (5th%–95th%ile)
Premature Mortality—Derived from epidemiology literature <sup>b</sup>	
Adult, age 30+, ACS Cohort Study (Krewski et al., 2009) .....	660 (480–840)
Adult, age 25+, Six-Cities Study (Lepeule et al., 2012) .....	1,500 (860–2,100)

<sup>571</sup> Science Advisory Board. (2001). NATA—Evaluating the National-Scale Air Toxics Assessment for 1996—an SAB Advisory. <http://www.epa.gov/ttn/atw/sab/sabrev.html>.

<sup>572</sup> U.S. Environmental Protection Agency (U.S. EPA). (2011). *The Benefits and Costs of the Clean Air Act from 1990 to 2020*. Office of Air and Radiation, Washington, DC. March. Available on the Internet at <<http://www.epa.gov/air/sect812/feb11/fullreport.pdf>>.

<sup>573</sup> U.S. Environmental Protection Agency—Science Advisory Board (U.S. EPA—SAB). (2008). *Benefits of Reducing Benzene Emissions in Houston, 1990–2020*. EPA—COUNCIL—08—001. July. Available at <[http://yosemite.epa.gov/sab/sabproduct.nsf/D4D7EC9DAEDA8A548525748600728A83/\\$File/EPA-COUNCIL-08-001-unsigned.pdf](http://yosemite.epa.gov/sab/sabproduct.nsf/D4D7EC9DAEDA8A548525748600728A83/$File/EPA-COUNCIL-08-001-unsigned.pdf)>.

<sup>574</sup> In April, 2009, EPA hosted a workshop on estimating the benefits or reducing hazardous air

pollutants. This workshop built upon the work accomplished in the June 2000 Science Advisory Board/EPA Workshop on the Benefits of Reductions in Exposure to Hazardous Air Pollutants, which generated thoughtful discussion on approaches to estimating human health benefits from reductions in air toxics exposure, but no consensus was reached on methods that could be implemented in the near term for a broad selection of air toxics. Please visit <http://epa.gov/air/toxicair/2009workshop.html> for more information about the workshop and its associated materials.

<sup>575</sup> We project that the Tier 3 vehicle and fuel standards will reduce nitrous oxide (N<sub>2</sub>O) and methane (CH<sub>4</sub>) emissions from vehicles. The reductions in these potent greenhouse gases will be offset to some degree by the increase in CO<sub>2</sub> emissions from refineries. The combined impact is a net decrease on a CO<sub>2</sub>-equivalent basis and would

yield a net benefit if these reductions were monetized.

<sup>576</sup> U.S. Environmental Protection Agency. (2012). *Regulatory Impact Analysis for the Final Revisions to the National Ambient Air Quality Standards for Particulate Matter*. Prepared by: Office of Air and Radiation, EPA-452/R-12-005. Retrieved August 14, 2013 at <http://www.epa.gov/ttn/ecas/ria.html>.

<sup>577</sup> U.S. Environmental Protection Agency. (2012). *Regulatory Impact Analysis for the Final Revisions to the National Ambient Air Quality Standards for Particulate Matter*. Prepared by: Office of Air and Radiation, EPA-452/R-12-005. Retrieved August 14, 2013 at <http://www.epa.gov/ttn/ecas/ria.html>.

<sup>578</sup> U.S. Environmental Protection Agency. (2008). *Final Ozone NAAQS Regulatory Impact Analysis*. Prepared by: Office of Air and Radiation, Office of Air Quality Planning and Standards. Retrieved March, 26, 2009 at <http://www.epa.gov/ttn/ecas/ria.html>. EPA-HQ-OAR-2009-0472-0238.

TABLE VIII-3—ESTIMATED PM<sub>2.5</sub>-RELATED HEALTH IMPACTS<sup>a</sup>—Continued

Health effect	2030 Annual reduction in incidence (5th%–95th%ile)
Infant, age <1 year (Woodruff et al., 1997)	
Non-fatal myocardial infarction (adult, age 18 and over)	
Peters et al. (2001) .....	790 (290–1,300)
Pooled estimate of 4 studies .....	85 (42–190)
Hospital admissions—respiratory (all ages) <sup>c,e</sup> .....	210 (–38–380)
Hospital admissions—cardiovascular (adults, age >18) <sup>d</sup> .....	250 (130–440)
Emergency room visits for asthma (age 18 years and younger) <sup>e</sup> .....	340 (–58–660)
Acute bronchitis, (children, age 8–12) <sup>e</sup> .....	980 (–35–2,000)
Lower respiratory symptoms (children, age 7–14) .....	13,000 (6,000–19,000)
Upper respiratory symptoms (asthmatic children, age 9–18) .....	18,000 (5,600–30,000)
Asthma exacerbation (asthmatic children, age 6–18) .....	19,000 (2,300–37,000)
Work loss days .....	81,000 (70,000–91,000)
Minor restricted activity days (adults age 18–65) .....	480,000 (400,000–550,000)

<sup>a</sup> Incidence is rounded to two significant digits. Estimates represent incidence within the 48 contiguous United States.

<sup>b</sup> PM-related adult mortality based upon the most recent American Cancer Society (ACS) Cohort Study (Krewski et al., 2009) and the most recent Six-Cities Study (Lepeule et al., 2012). Note that these are two alternative estimates of adult mortality and should not be summed. PM-related infant mortality based upon a study by Woodruff, Grillo, and Schoendorf, (1997).<sup>579</sup>

<sup>c</sup> Respiratory hospital admissions for PM include admissions for chronic obstructive pulmonary disease (COPD), pneumonia and asthma.

<sup>d</sup> Cardiovascular hospital admissions for PM include total cardiovascular and subcategories for ischemic heart disease, dysrhythmias, and heart failure.

<sup>e</sup> The negative estimates at the 5th percentile confidence estimates for these morbidity endpoints reflect the statistical power of the study used to calculate these health impacts. These results do not suggest that reducing air pollution results in additional health impacts.

TABLE VIII-4—ESTIMATED OZONE-RELATED HEALTH IMPACTS<sup>a</sup>

Health effect	2030 Annual reduction in incidence (5th%–95th%ile)
Premature Mortality, All ages <sup>b</sup>	
Multi-City Analyses	
Bell et al. (2004)—Non-accidental .....	110 (46–170)
Huang et al. (2005)—Cardiopulmonary .....	160 (74–250)
Schwartz (2005)—Non-accidental .....	170 (68–270)
Meta-analyses:	
Bell et al. (2005)—All cause .....	350 (190–510)
Ito et al. (2005)—Non-accidental .....	490 (320–660)
Levy et al. (2005)—All cause .....	500 (360–630)
Hospital admissions—respiratory causes (adult, 65 and older) <sup>c</sup> .....	740 (87–1,400)
Hospital admissions—respiratory causes (children, under 2) .....	310 (160–450)
Emergency room visit for asthma (all ages) <sup>d</sup> .....	330 (–8–990)
Minor restricted activity days (adults, age 18–65) .....	600,000 (290,000–910,000)
School absence days .....	210,000 (92,000–300,000)

<sup>a</sup> Incidence is rounded to two significant digits. Estimates represent incidence within the 48 contiguous U.S.

<sup>b</sup> Estimates of ozone-related premature mortality are based upon incidence estimates derived from several alternative studies: Bell et al. (2004); Huang et al. (2005); Schwartz (2005); Bell et al. (2005); Ito et al. (2005); Levy et al. (2005). The estimates of ozone-related premature mortality should therefore not be summed.

<sup>c</sup> Respiratory hospital admissions for ozone include admissions for all respiratory causes and subcategories for COPD and pneumonia.

<sup>d</sup> The negative estimate at the 5th percentile confidence estimate for this morbidity endpoint reflects the statistical power of the study used to calculate this health impact. This result does not suggest that reducing air pollution results in additional health impacts.

C. Monetized Benefits

Table VIII-5 presents the estimated monetary value of changes in the incidence of ozone and PM<sub>2.5</sub>-related health effects. All monetized estimates are stated in 2011 dollars. These estimates account for growth in real

gross domestic product (GDP) per capita between the present and 2030. Our estimate of total monetized benefits in 2030 for the program, using the ACS and Six-Cities PM mortality studies and the range of ozone mortality assumptions, is between \$7.4 and \$19

billion, assuming a 3 percent discount rate, or between \$6.7 and \$18 billion, assuming a 7 percent discount rate. This represents the health benefits of the Tier 3 program anticipated to occur annually when the program is fully implemented and most of the fleet turned over.

<sup>579</sup> Woodruff, T.J., J. Grillo, and K.C. Schoendorf. (1997). The Relationship Between Selected Causes

of Postneonatal Infant Mortality and Particulate Air

Pollution in the United States. *Environmental Health Perspectives* 105(6):608–612.

TABLE VIII-5—ESTIMATED MONETARY VALUE OF CHANGES IN INCIDENCE OF HEALTH AND WELFARE EFFECTS IN 2030  
[Millions of 2011\$]<sup>a</sup>

Health Endpoints	2030 (5th and 95th percentile)
<b>PM<sub>2.5</sub>-Related Health Effects</b>	
Premature Mortality—Derived from Epidemiology Studies: <sup>b,c</sup>	
Adult, age 30+—ACS study (Krewski et al., 2009)	
3% discount rate .....	\$6,100 (\$910–\$14,000)
7% discount rate .....	\$5,500 (\$820–\$13,000)
Adult, age 25+—Six-Cities study (Lepeule et al., 2012)	
3% discount rate .....	\$14,000 (\$2,000–\$33,000)
7% discount rate .....	\$12,000 (\$1,800–\$30,000)
Infant Mortality, <1 year—(Woodruff et al. 1997) .....	\$13 (\$1.8–\$32)
Non-fatal acute myocardial infarctions (Peters et al., 2001):	
3% discount rate .....	\$96 (\$21–\$230)
7% discount rate .....	\$93 (\$19–\$220)
Pooled estimate of 4 studies:	
3% discount rate .....	\$10 (\$2.6–\$27)
7% discount rate .....	\$10 (\$2.4–\$27)
Hospital admissions for respiratory causes <sup>d</sup> .....	\$5.9 (–\$1.6–\$11)
Hospital admissions for cardiovascular causes .....	\$9.9 (\$5.0–\$17)
Emergency room visits for asthma <sup>d</sup> .....	\$0.15 (–\$0.02–\$0.29)
Acute bronchitis (children, age 8–12) <sup>d</sup> .....	\$0.49 (–\$0.02–\$1.2)
Lower respiratory symptoms (children, 7–14) .....	\$0.27 (\$0.11–\$0.51)
Upper respiratory symptoms (asthma, 9–11) .....	\$0.62 (\$0.18–\$1.4)
Asthma exacerbations .....	\$1.1 (\$0.14–\$2.7)
Work loss days .....	\$12 (\$11–\$14)
Minor restricted-activity days (MRADs) .....	\$34 (\$20–\$49)
<b>Ozone-Related Health Effects</b>	
Premature Mortality, All ages—Derived from Multi-city analyses:	
Bell et al., 2004 .....	\$1,100 (\$150–\$2,800)
Huang et al., 2005 .....	\$1,600 (\$220–\$4,100)
Schwartz, 2005 .....	\$1,700 (\$220–\$4,400)
Premature Mortality, All ages—Derived from Meta-analyses:	
Bell et al., 2005 .....	\$3,600 (\$510–\$8,800)
Ito et al., 2005 .....	\$5,000 (\$740–\$12,000)
Levy et al., 2005 .....	\$5,100 (\$760–\$12,000)
Hospital admissions—respiratory causes (adult, 65 and older) .....	\$21 (\$2.5–\$39)
Hospital admissions—respiratory causes (children, under 2) .....	\$3.7 (\$1.9–\$5.4)
Emergency room visit for asthma (all ages) .....	\$0.14 (–\$0.003–\$0.41)
Minor restricted activity days (adults, age 18–65) .....	\$43 (\$19–\$73)
School absence days .....	\$21 (\$9.3–\$31)

<sup>a</sup> Monetary benefits are rounded to two significant digits for ease of presentation and computation. PM and ozone benefits are nationwide.  
<sup>b</sup> Monetary benefits adjusted to account for growth in real GDP per capita between 1990 and the analysis year (2030).  
<sup>c</sup> Valuation assumes discounting over the SAB recommended 20 year segmented lag structure. Results reflect the use of 3 percent and 7 percent discount rates consistent with EPA and OMB guidelines for preparing economic analyses.  
<sup>d</sup> The negative estimate at the 5th percentile confidence estimate for this morbidity endpoint reflects the statistical power of the study used to calculate this health impact. This result does not suggest that reducing air pollution results in additional health impacts.

*D. What are the limitations of the benefits analysis?*

Every benefit-cost analysis examining the potential effects of a change in environmental protection requirements is limited to some extent by data gaps, limitations in model capabilities (such as geographic coverage), and uncertainties in the underlying scientific and economic studies used to configure the benefit and cost models. Limitations of the scientific literature often result in the inability to estimate quantitative changes in health and environmental effects, such as potential decreases in premature mortality associated with decreased exposure to carbon monoxide. Deficiencies in the

economics literature often result in the inability to assign economic values even to those health and environmental outcomes which can be quantified. These general uncertainties in the underlying scientific and economics literature, which can lead to valuations that are higher or lower, are discussed in detail in the RIA and its supporting references. Key uncertainties that have a bearing on the results of the benefit-cost analysis of the final standards include the following:

- The exclusion of potentially significant and unquantified benefit categories (such as health, odor, and ecological benefits of reduction in air toxics, ozone, and PM);

- Errors in measurement and projection for variables such as population growth;
- Uncertainties in the estimation of future year emissions inventories and air quality (including future year climate uncertainty);
- Uncertainty in the estimated relationships of health and welfare effects to changes in pollutant concentrations including the shape of the concentration-response function, the size of the effect estimates, and the relative toxicity of the many components of the PM mixture;
- Uncertainties in exposure estimation; and

• Uncertainties associated with the effect of potential future actions to limit emissions.

As Table VIII–5 indicates, total benefit estimates are driven primarily by the reduction in premature mortalities each year. Some key assumptions underlying the premature mortality estimates include the following, which may also contribute to uncertainty:

- We assume that all fine particles, regardless of their chemical composition, are equally potent in causing premature mortality. This is an important assumption, because PM<sub>2.5</sub> varies considerably in composition across sources, but the scientific evidence is not yet sufficient to allow differential effects estimates by particle type. The 2009 PM ISA, which was twice reviewed by EPA’s Science Advisory Board Clean Air Science Advisory Committee (SAB–CASAC), concluded that “many constituents of PM<sub>2.5</sub> can be linked with multiple health effects, and the evidence is not yet sufficient to allow differentiation of those constituents or sources that are more closely related to specific outcomes.”<sup>580</sup>

- We assume that the health impact function for fine particles is log-linear without a threshold in this analysis. Thus, the estimates include health benefits from reducing fine particles in areas with varied concentrations of PM<sub>2.5</sub>, including both areas that do not meet the fine particle standard and those areas that are in attainment, down to the lowest modeled concentrations.

- We assume that there is a “cessation” lag between the change in

PM exposures and the total realization of changes in mortality effects. Specifically, we assume that some of the incidences of premature mortality related to PM<sub>2.5</sub> exposures occur in a distributed fashion over the 20 years following exposure based on the advice of EPA’s Science Advisory Board Health Effects Subcommittee (SAB–HES),<sup>581</sup> which affects the valuation of mortality benefits at different discount rates.

- There is uncertainty in the magnitude of the association between ozone and premature mortality. The range of ozone benefits associated with the final standards is estimated based on the risk of several sources of ozone-related mortality effect estimates. In a report on the estimation of ozone-related premature mortality published by the National Research Council, a panel of experts and reviewers concluded that short-term exposure to ambient ozone is likely to contribute to premature deaths and that ozone-related mortality should be included in estimates of the health benefits of reducing ozone exposure.<sup>582</sup>

Despite the uncertainties described above, we believe this analysis provides a conservative estimate of the estimated criteria pollutant-related health and environmental benefits of the standards in future years because of the exclusion of potentially significant benefit categories that are not quantifiable at this time. Acknowledging benefits omissions and uncertainties, we present a best estimate of the total benefits based on our interpretation of the best available scientific literature and

methods supported by EPA’s technical peer review panel, the Science Advisory Board’s Health Effects Subcommittee (SAB–HES). The National Academies of Science (NRC, 2002) has also reviewed EPA’s methodology for analyzing the health benefits of measures taken to reduce air pollution. EPA addressed many of these comments in the analysis of the final PM NAAQS.<sup>583 584</sup> This analysis incorporates this work to the extent possible.

*E. Illustrative Analysis of Estimated Monetized Impacts Associated With the Rule in 2018*

For illustrative purposes, this section presents the total estimated monetized benefits associated with the final standards in 2018. As presented in Section III.B, the emissions impacts of the final standards in 2018 are primarily due to the effects of sulfur on the existing (pre-Tier 3) fleet.

Table VIII–6 presents total aggregate monetized benefits of the program in 2018. Monetized estimates are presented in 2011\$. Our estimate of total monetized benefits associated with the final standards in 2018, using the ACS and Six-Cities PM mortality studies and the range of ozone mortality assumptions, is between \$2.1 and \$5.6 billion, assuming a 3 percent discount rate, or between \$1.9 and \$5.3 billion, assuming a 7 percent discount rate. For a more detailed presentation of the quantified and monetized impacts of the final standards in 2018, please refer to Chapter 8 of the RIA that accompanies this preamble.

TABLE VIII–6—TOTAL ESTIMATED MONETIZED OZONE AND PM-RELATED BENEFITS ASSOCIATED WITH THE FINAL STANDARDS IN 2018<sup>a</sup>

Total Ozone and PM Benefits (billions, 2011\$)—PM Mortality Derived From the ACS and Six-Cities Studies					
3% Discount rate			7% Discount rate		
Ozone mortality function	Reference	Mean total benefits	Ozone mortality function	Reference	Mean total benefits
Multi-city .....	Bell et al., 2004 .....	\$2.1–\$4.1	Multi-city .....	Bell et al., 2004 .....	\$1.9–\$3.7
	Huang et al., 2005 .....	\$2.3–\$4.2		Huang et al., 2005 .....	\$2.1–\$3.9
	Schwartz, 2005 .....	\$2.3–\$4.3		Schwartz, 2005 .....	\$2.1–\$3.9
Meta-analysis .....	Bell et al., 2005 .....	\$3.1–\$5.0	Meta-analysis .....	Bell et al., 2005 .....	\$2.9–\$4.7
	Ito et al., 2005 .....	\$3.6–\$5.6		Ito et al., 2005 .....	\$3.4–\$5.2
	Levy et al., 2005 .....	\$3.6–\$5.6		Levy et al., 2005 .....	\$3.5–\$5.3

<sup>580</sup> U.S. Environmental Protection Agency (U.S. EPA). 2009. Integrated Science Assessment for Particulate Matter (Final Report). EPA–600–R–08–139F. National Center for Environmental Assessment—RTP Division. December. Available on the Internet at <<http://cfpub.epa.gov/ncea/cfm/recordisplay.cfm?deid=216546>>.

<sup>581</sup> U.S. Environmental Protection Agency—Science Advisory Board (U.S. EPA–SAB). 2004. Advisory Council on Clean Air Compliance

Analysis Response to Agency Request on Cessation Lag. EPA–COUNCIL–LTR–05–001. December. Available on the Internet at <[http://yosemite.epa.gov/sab/sabproduct.nsf/0/39F44B098DB49F3C85257170005293E0/\\$File/council\\_ltr\\_05\\_001.pdf](http://yosemite.epa.gov/sab/sabproduct.nsf/0/39F44B098DB49F3C85257170005293E0/$File/council_ltr_05_001.pdf)>.

<sup>582</sup> National Research Council (NRC), (2008). Estimating Mortality Risk Reduction and Economic Benefits from Controlling Ozone Air Pollution. The National Academies Press: Washington, DC.

<sup>583</sup> National Research Council (NRC). (2002). Estimating the Public Health Benefits of Proposed Air Pollution Regulations. The National Academies Press: Washington, DC.

<sup>584</sup> U.S. Environmental Protection Agency. (2012). Regulatory Impact Analysis for the Final Revisions to the National Ambient Air Quality Standards for Particulate Matter. Prepared by: Office of Air and Radiation, EPA–452/R–12–005. Retrieved August 14, 2013 at <http://www.epa.gov/ttn/ecas/ria.html>.



**Total Ozone and PM Benefits (billions, 2010\$)—PM Mortality Derived From Expert Elicitation (Lowest and Highest Estimate)**

3% Discount rate			7% Discount rate		
Ozone mortality function	Reference	Mean total benefits	Ozone mortality function	Reference	Mean total benefits
Multi-city .....	Bell et al., 2004 .....	\$0.81–\$5.8	Multi-city .....	Bell et al., 2004 .....	\$0.78–\$5.3
	Huang et al., 2005 .....	\$1.0–\$6.0		Huang et al., 2005 .....	\$0.98–\$5.5
	Schwartz, 2005 .....	\$1.0–\$6.0		Schwartz, 2005 .....	\$1.0–\$5.5
Meta-analysis .....	Bell et al., 2005 .....	\$1.8–\$6.8	Meta-analysis .....	Bell et al., 2005 .....	\$1.8–\$6.3
	Ito et al., 2005 .....	\$2.3–\$7.3		Ito et al., 2005 .....	\$2.3–\$6.8
	Levy et al., 2005 .....	\$2.4–\$7.4		Levy et al., 2005 .....	\$2.4–\$6.8

<sup>a</sup> Total includes estimated premature mortality-related and morbidity-related ozone and PM<sub>2.5</sub> benefits. Range was developed by adding the estimate from the ozone premature mortality function to the estimate of PM<sub>2.5</sub>-related premature mortality derived from either the ACS study (Krewski et al., 2009) or the Six-Cities study (Lepeule et al., 2012) or the lowest and highest mortality estimate across the range derived from the expert elicitation. Range also reflects alternative estimates of non-fatal heart attacks avoided based on either Peters et al. (2001) or a pooled estimate of four studies.

**IX. Alternatives Analysis**

As described throughout this preamble, we have considered a number of regulatory alternatives in the development of this final rule, including alternatives related to timing and stringency of the standards, as well as alternative program design elements (e.g., averaging, banking, and trading). This section summarizes alternatives we have considered for both vehicle emission and fuel standards.

**A. Vehicle Emission Standards**

The federal vehicle emission standards we are adopting are the most stringent feasible considering anticipated developments in motor vehicle emissions control technology. Consideration of alternatives focused less on the level of the fleet-average and per-vehicle standards themselves and more on the phase-in schedule for the standards, which can have an important influence on the cost of the standards. Phase-in schedules directly impact costs depending on how they are aligned with other light-duty rules and product design cycles, especially those of the California LEV III criteria emissions program and the EPA greenhouse gas (GHG) rules. In addition, phase-in schedules can impact the cost of available resources, specifically design, development and testing resources within vehicle manufacturers and emission control suppliers.<sup>585</sup>

As we considered options for the Tier 3 vehicle standards, one of the important factors we considered was the degree of harmonization that would result between Tier 3 and the CARB LEV III program. As discussed earlier in this preamble, the auto manufacturing industry stressed throughout the

development of the Tier 3 rule and in their comments on the proposed rule—both as individual companies and through their trade associations—the need for harmonization of the two programs as completely and as soon as possible.

Another factor in our consideration of program options has been how the timing of the Tier 3 program aligns with the federal light-duty vehicle GHG rules. We believe that both programs will be more efficient and less costly if manufacturers have greater ability to coordinate their product planning to respond to the various regulatory requirements they face.

For these reasons, we have focused on program alternatives that generally achieve close harmony with the California programs in the earliest appropriate time frame, and on a schedule matching those of the GHG rules as much as possible. The following paragraphs describe the major alternatives we have considered.

**1. Shorter NMOG+NO<sub>x</sub> Standard Phase-In**

We originally considered requiring full implementation of the NMOG+NO<sub>x</sub> final fleet average standard by MY 2022. However, we determined that this would have disrupted the manufacturer’s normal product design cycles,<sup>586</sup> and it would not have allowed manufacturers to use consistent product design cycles for both the Tier 3 standards and the 2017 LD GHG standards, which reach full implementation in MY 2025. We are adopting a phase-in schedule that gradually increases the stringency of the standards until MY 2025, as with the GHG program, in order to allow vehicle manufacturers to better integrate the

compliance with Tier 3 into their product design cycles as well as to take advantage of additional learning to reduce costs. We believe this implementation schedule for the Tier 3 NMOG+NO<sub>x</sub> standards allows us to achieve the environmental objectives of the program without imposing unnecessary costs and burden on the industry.

**2. NMOG+NO<sub>x</sub> Standards Phase-In and Early Tier 3 Credits**

The key agency goals in designing the structure of the Tier 3 program are to facilitate the step-down in fleet average stringency in the initial model years and to create a program that is of equivalent stringency and aligned with LEV III as early as possible. We considered allowing manufacturers to generate early credits against the current Tier 2 Bin 5 fleet average and to use generated early credits without limitation for the first five years of the Tier 3 program. CARB, along with some vehicle manufacturers, noted that if a manufacturer were to substantially over-comply with the Tier 2 Bin 5 fleet average, these early credits might delay achievement of the Tier 3 emission levels and also delay harmonization between the Tier 3 and LEV III programs for several years. Based on the fact that manufacturers are selling many vehicles today that are already cleaner than the existing Tier 2 Bin 5 fleet average, we believe that there is a strong potential for them to generate an excessive amount of credits. Also, most manufacturers will already have begun to sell vehicles that meet the LEV III standards (and thus the Tier 3 standards). The use of such a “windfall” of credits would likely result in a substantial delay in achieving alignment between the LEV III and Tier 3 programs.

To avoid this potential misalignment, we are finalizing as proposed a provision that any early credits

<sup>585</sup> We note that the Tier 3 program includes additional phase-in flexibility through the alternative phase-in schedules for light-duty exhaust emissions standards, heavy-duty exhaust emissions standards, and light- and heavy-duty evaporative emissions standards.

<sup>586</sup> A light-duty vehicle product design cycle is the number of years between major redesigns of a vehicle. Typically, major redesigns are completed every 5 to 6 years.

generated be capped starting in MY 2018 at the number of a manufacturer's LEV III credits, but adjusted by the ratio of California and other LEV III sales nationwide. (See Section IV.A.7.a for more detail on these early credit provisions.) This approach balances the need for meaningful transition flexibility to avoid unnecessary costs, while still ensuring expeditious harmonization with LEV III and achievement of the environmental benefits of the Tier 3 standards.

### 3. NMOG+NO<sub>x</sub> Standards

We believe that the fleet-average NMOG+NO<sub>x</sub> standards that we are finalizing reflect the greatest degree of emission reduction achievable considering cost, developments in technology, and gasoline sulfur levels as required by this rule. We also believe the implementation schedule for the NMOG+NO<sub>x</sub> standards is as short as practicable, as explained above. We believe that more stringent or less stringent standards are not justified based on the information currently available, including comments received. Therefore, and consistent with our goal of harmonizing the Tier 3 program with LEV III as much as possible, we are finalizing the declining FTP and SFTP NMOG+NO<sub>x</sub> standards and phase-in schedules as proposed, as discussed in Section IV.A.3 and IV.A.4 above.

### 4. PM Standards

The FTP and SFTP (US06) PM standards that we are adopting are the most stringent technically feasible standards within their implementation timeframe and meet the EPA goal of bringing all vehicles to the FTP and US06 PM emission levels demonstrated by most vehicles today.

We considered adopting for Tier 3 the 1 mg/mi FTP PM standard that the LEV III program will begin phasing-in in MY 2025. However, as explained in the proposal and in Section IV.A.3.b above, and upon further review of current test procedures and the public comments, we concluded that 3 mg/mi is the most stringent technologically feasible FTP PM standard. We will continue to work closely with CARB in this area. Specifically, our agencies will continue our parallel evaluations of how improved gravimetric PM measurement methods can reduce PM mass measurement variability at very low PM levels, and how this relates to the evolving technological capabilities of automakers to reach very low PM levels with sufficient compliance margins.

As discussed in Section IV.A.4, we are finalizing numerically lower US06 standards than those we proposed. More

recent test data shows that the levels of the final US06 standards better meet EPA's goal of capping US06 PM emissions at levels already being demonstrated by most vehicles in the current light-duty fleet. We proposed a 10 mg/mi US06 PM standard for cars, and 20 mg/mi for trucks. Like the FTP PM standards, the US06 PM standards are per-vehicle caps and not fleet averages. The comments we received ranged from suggesting a numerically lower standard to maintaining the standards as proposed. CARB and other stakeholders recommended a standard of 4 mg/mi, and the International Council on Clean Transportation recommended that the standards be no higher than 6 mg/mi. The Alliance and Global Automakers supported the proposed standards. We considered all of the comments suggesting various levels for these standards, and we are finalizing standards of 10 mg/mi through MY 2021 and of 6 mg/mi for 2022 and later model years, for both lighter and heavier vehicles, because they reflect the current US06 PM performance of most vehicles. We believe these standards will address current poor performing vehicles and ensure that future vehicles with future technologies will perform, at a minimum, at or near the level of PM emissions that is being demonstrated by current vehicles.

Because the final standards maintain the same stringency relative to emission levels achieved currently, as we describe our goal for these standards in the proposal, there is no difference in the projected costs and benefits associated with the proposed and final US06 PM standard levels. The costs associated with meeting the final PM standards are driven by the vehicle performance over the FTP. That is, the 3 mg/mi FTP standard is the primary controlling factor in a vehicle's overall PM performance and manufacturer compliance strategies. The US06 PM standard is intended to supplement the FTP PM standard in that any additional level of PM control required to meet the US06 PM standard is expected to be accomplished through calibration and not through the use of additional hardware.

### 5. Higher Ethanol Content of Emissions Test Fuel

We proposed and considered a change in the required ethanol content of emissions test fuel, from the current zero percent (E0) specification to a 15 percent ethanol (E15) specification. However, as discussed in Section IV.F above, the market fuel shift toward higher ethanol content has not

materialized, and we are finalizing E10 as the Tier 3 gasoline test fuel to better match in-use fuels expected in the implementation timeframe of the Tier 3 standards. The adoption of E10 in lieu of E15 not only creates a federal test fuel that more closely reflects the ethanol content of in-use fuel currently and in the foreseeable future, but also more closely aligns with California's LEV III test fuel.

### B. Fuel Sulfur Standards

#### 1. Annual Average Sulfur Standard

As explained in Section V.B., we believe that a 10 ppm annual average standard is required to enable the vehicle fleet to meet the final Tier 3 standards and appropriately balances feasibility with costs. Other countries and California have also reduced the sulfur content of their gasoline; California's gasoline is already meeting our proposed 10 ppm average sulfur level, and Europe and Japan have a cap on the sulfur content of gasoline at 10 ppm. During the development of the proposed rule, we considered imposing a 10 ppm cap (i.e., no averaging, banking and trading), similar to the standard in Europe and Japan, as well as an average standard lower than 10 ppm average, because vehicle emission performance improves as sulfur is reduced.

However, by allowing averaging to meet 10 ppm, we believe that the most challenged refiners would be able to avoid what could be cost-prohibitive investments, while still meeting 10 ppm across the fuel pool. As discussed in Section VII.B., we estimate that allowing averaging would reduce nationwide control costs by nearly 26 percent, and would still be sufficient to enable vehicles to meet the proposed Tier 3 standards.

We also considered an even lower sulfur standard of 5 ppm. Based upon the results of our test programs and associated modeling, a sulfur standard of 5 ppm could reduce VOC+NO<sub>x</sub> emissions from the existing fleet by an additional 65,000 tons in 2018.

However, we believe a 5 ppm standard would significantly increase both capital and operating costs. Such a standard would require: (1) More severe treatment of FCC gasoline; (2) treatment of additional (non-FCC) gasoline blendstocks; (3) essentially all refineries to reduce sulfur to 5 ppm, thereby eliminating much of the benefit of the ABT provisions; and potentially (4) more overcapacity and storage for reprocessing off-specification product. A 5 ppm standard would also warrant consideration of controlling the

contribution to gasoline sulfur from gasoline additives, transmix, ethanol denaturants, and contamination in the distribution system.

In our analysis of the 10 ppm average standard and refineries that might reduce sulfur to 5 ppm in order to generate credits, we estimated that the sulfur control costs to achieve 5 ppm would be about twice that for our final 10 ppm standard. This is 60 percent

higher on a cost per ppm-gallon basis. The much higher cost is because a 5 ppm standard eliminates the practical ability for refineries to trade credits. That is, there would not be enough refineries overcomplying to generate credits and support a viable trading program. As a result, it could become prohibitively expensive for the more challenged refineries to comply, creating potential financial hardship

situations. Because the costs and other economic impacts rise dramatically as sulfur is reduced below 10 ppm, we believe that a 10 ppm sulfur standard is the most stringent feasible standard considering technology and cost.

Table IX–1 below summarizes the various alternative gasoline sulfur programs that we assessed and our estimated costs for those alternative programs.

TABLE IX–1—SUMMARY OF COSTS FOR ALTERNATIVE FUEL PROGRAMS

	Sulfur level	Credit trading	Per-gallon cost (c/gal)	Capital cost (\$MM)
Final Rule Case .....	10	Nationwide .....	0.65	2025
NPRM Case .....	10	Intra-company Only .....	0.75	2195
No ABT Case .....	10	None .....	0.87	2990
Stringent Case .....	5	None .....	1.27	3805

Table IX–1 demonstrates that the ABT program has a profound impact on the cost of sulfur control. The estimated per-gallon cost and the capital costs for the case without an ABT program are 35 percent and 47 percent higher, respectively, than the final rule case which assumes nationwide credit trading. The stringent sulfur control case, which modeled a 5 ppm average standard and assumes no ABT program, is estimated to cost about twice that of the final rule case. The final rule case, which provides a very flexible ABT program, achieves a 10 ppm average sulfur standard at the lowest cost and therefore is the most cost-effective of the various options that we studied.

Additionally, as discussed in Sections IV.A and V.B a standard above 10 ppm would not be sufficiently low to meet the Tier 3 emissions standards. The feasibility of the 30 mg/mi NMOG+NO<sub>x</sub> fleet average depends on exhaust catalyst systems that require gasoline with average sulfur levels of 10 ppm or less. Further, annual average sulfur levels greater than 10 ppm would significantly impair the emission control technology that we expect will be used to meet the Tier 3 standards and to ensure in-use compliance over a vehicle’s useful life. This is particularly a concern for some larger vehicles that will need to reduce NO<sub>x</sub> to near-zero levels, due to greater difficulty in reducing cold-start NMOG, in order to meet a combined NMOG+NO<sub>x</sub> standard. As discussed in Section IV.A.6, increasing gasoline sulfur to 20 or 30 ppm would make it impossible for vehicle manufacturers to meet the Tier 3 standards. Achieving Tier 3 standards would require offsetting the resultant higher emissions, but EPA is not aware of existing or developing technology

that could address these higher emissions when taking into consideration the entire vehicle fleet.

Thus, we believe that a standard of 10 ppm is appropriate. When combined with the advances in emissions control technologies, a 10 ppm average sulfur standard is sufficient to allow vehicles meet the Tier 3 emissions standards at the lowest cost.

2. Refinery Gate Sulfur Cap

In addition to lower average sulfur standards, we also considered lowering the per-gallon cap standards. As discussed in Section V.C, we are maintaining the current per-gallon caps of 80 ppm at the refinery gate and 95 ppm downstream. We co-proposed refinery gate per-gallon cap standards of 50 ppm and 80 ppm (with downstream caps of 65 and 95, respectively), and we requested comment on a refinery gate cap of 20 ppm.

In assessing the potential of a lower refinery gate cap of 50 ppm, we found that it would directionally increase the costs of the Tier 3 program. Our analysis shows that a 50 ppm cap would increase the cost of the Tier 3 gasoline sulfur standards by approximately 10 percent (see RIA Chapter 5). A cap at this level would result in higher capital costs for a number of refiners due to the decreased ability to handle off-spec product with a lower refinery gate cap. The need for installation of additional tankage and/or increased refinery processing capability would also be greater, as refiners must ensure that they can continue to produce saleable product and meet demand in the event of an upset or an off-spec batch of fuel.

Additionally, the more stringent cap would unlikely provide significant additional emission benefits

nationwide. As discussed previously in Sections III through V, the emissions benefits associated with the Tier 3 program are mainly associated with the reduction in the average sulfur content of gasoline from 30 to 10 ppm, since vehicle emissions are proportional to the sulfur content of the fuel; changes in the cap would not affect this. We anticipate that in most (if not all) cases refineries will make operational changes and/or investments in order to reduce their credit burden and reduce their compliance costs; thus, we anticipate that most refineries, including those using credits, will still average less than 20 or 30 ppm in their physical gasoline production. While there will certainly be some variations above and below 10 ppm (just as there are today relative to the 30 ppm standard under the current Tier 2 program), it is not possible for us to predict them in a way that we could quantify the associated emissions and air quality impacts. As a result, we cannot currently estimate the potential benefits of a 50 ppm cap. However, during the implementation of the program we will be monitoring in-use sulfur levels and further evaluating in-use sulfur levels and their impact on vehicle emissions. This will provide us additional information with which to evaluate the potential benefits of a lower sulfur cap, if warranted.

C. Program Start Date

We are finalizing the Tier 3 vehicle emissions and fuel standards with a 2017 start date, considering the vehicle and its fuel together as an integrated system. As described in Section IX.A.1 and 2, we considered different phase-ins for the vehicle program. We have also considered the comments requesting additional lead time for the fuel

program. As discussed in Section V.L.3, we believe that the lead time provided is sufficient to meet a January 1, 2017, start date for the fuel sulfur standard, especially coupled with the flexibilities being offered as part of the program and the fact that only a few refineries will need to install grassroots equipment to meet the Tier 3 standards. As discussed in Section V.D, we did consider and are finalizing, in response to comments, a provision allowing refiners to carry over credits from Tier 2.

Given that the lead time and associated programmatic flexibility we are finalizing is sufficient to allow industry to readily comply; we do not expect that a delay in the start date of the fuel standards would change the cost of compliance; any further delay in the program start date would simply delay the actions to comply. Furthermore, delaying the start of the program would forego significant emissions, air quality, and health benefits. Sections III and VIII describe the impacts of the Tier 3 standards in the year 2018. The majority of these impacts result from the effects of the fuel sulfur standard on the existing fleet, because there will be limited penetration of Tier 3 vehicles in 2018, and even those vehicles will not yet be meeting fully phased-in standards. Thus, the 2018 estimates of emission reductions, air quality improvements, and health benefits are an approximation of the benefits that would be foregone for each year that the program is delayed. Because we believe the start of the Tier 3 program is feasible and appropriate, and its delay would forego significant benefits, we are finalizing, as proposed, fuel sulfur standards that take effect January 1, 2017.

## X. Economic Impact Analysis

### A. Introduction

The rule will affect two sectors directly: Vehicle manufacturing and petroleum refining. For these two regulated sectors, the economic impact analysis discusses the market impacts from the rule: Changes in price and quantity sold. In addition, although analysis of employment impacts is not part of a benefit-cost analysis (except to the extent that labor costs contribute to costs), employment impacts of federal rules are of particular concern in the current economic climate of sizeable unemployment. Executive Order 13563, "Improving Regulation and Regulatory Review" (January 18, 2011), states, "Our regulatory system must protect public health, welfare, safety, and our environment while promoting economic

growth, innovation, competitiveness, and *job creation*" (emphasis added). For this reason, we are examining the effects of this rule on employment in the regulated sectors.

Some commenters suggest that the overall effects of Tier 3 on the economy are likely to be positive, because the standards encourage innovation and reduce emissions. In addition, they suggest that Tier 3 will lead to greater employment to develop the emissions control technologies and to upgrade refineries. As discussed further below, other commenters suggest negative impacts, especially due to the fuel standards. The Motor and Equipment Manufacturers Association asks that the regulations "be based on sound science and data and balance the public interest objectives with economic realities of manufacturers." EPA has used the best available information in developing these standards (including the use of peer reviewed literature, peer reviewed models, public comments received, etc.), and has documented its final estimates of the economic impacts from these standards in the RIA.

### B. Vehicle Sales Impacts

This rule takes effect from MY 2017–2025. In the intervening years, it is possible that the assumptions underlying a quantitative analysis, as well as market conditions, might change. For this reason, we present a qualitative discussion of the effects on vehicle sales of the standards at the aggregate market level. Vehicle manufacturers are expected to comply with the standards primarily through technological changes to vehicles. These changes to vehicle design and manufacturing are expected to increase manufacturers' costs of vehicle production.

Section VII.A estimates the increase in vehicle costs due to the standards. These costs differ across years and range from \$46 to \$65 for cars, \$73 to \$88 for trucks and \$33 to \$75 for Class 2b/3 vehicles (see Section VII.A). These costs are small relative to the cost of a vehicle. In a fully competitive industry, these costs would be entirely passed through to consumers. However in an oligopolistic industry such as the automotive sector, these increases in cost may not fully pass through to the purchase price, and the consumers may face an increase in price that is less than the increased manufacturers' costs of vehicle production.<sup>587</sup> We do not

<sup>587</sup> See, for instance, Gron, A., and Swenson, D. (2000), Cost Pass-Through in the U.S. Automobile Market. *Review of Economics and Statistics* 82, 316–324 (Docket EPA–HQ–OAR–2011–0135–0056),

quantify the expected level of cost pass-through or the ultimate vehicle price increase consumers are expected to face, apart from noting that prices are expected to increase by an amount up to the increase in manufacturers' costs.

This increase in price is expected to lower the quantity of vehicles sold. Given that we expect that vehicle prices will not change by more than the cost increase, we expect that the decrease in vehicle sales will be negligible.

The effect of this rule on the use and scrappage of older vehicles is related to its effects on new vehicle prices and the total sales of new vehicles. The increase in price is likely to cause the "turnover" of the vehicle fleet (i.e., the retirement of used vehicles and their replacement by new models) to slow slightly, thus reducing the anticipated effect of the rule on fleet-wide emissions. Because we do not estimate the effect of the rule on new vehicle price changes nor do we have a good estimate of the effect of new vehicle price changes on vehicle turnover, we have not attempted to estimate explicitly the effects of the rule on scrappage of older vehicles and the turnover of the vehicle fleet.

Commenters note that the incentives to go beyond the 8-year/80,000-mile warranty could improve vehicle reliability and lower costs, in addition to improving air quality. Other commenters suggest that harmonizing standards across the whole U.S. will benefit the economy. EPA agrees that harmonized standards will simplify manufacturing and marketing decisions for automakers. The Manufacturers of Emission Controls Association points out that many SULEV- and PZEV-compliant vehicles have already been sold in the U.S. Commenters did not raise other concerns with the qualitative vehicle sales analysis.

### C. Impacts on Petroleum Refinery Sector Production

The key change for refiners from the standards is more stringent sulfur requirements. This change to fuels is expected to increase manufacturers' costs of gasoline production by about 0.65 cents per gallon (see Section VII.B).

Some commenters raise concerns about the economic burdens to refineries and to consumers who must buy more expensive gasoline, in part based on estimates of the costs of the

who found significantly less than full-cost pass-through using data from 1984–1994. Using full-cost pass-through overstates costs and thus contributes to lower vehicle sales than using a lower estimate. To the extent that the auto industry has become more competitive over time, full-cost pass-through may be more appropriate than a result based on this older study.

standards as high as 6–9 cents per gallon. As discussed in Section VII.B of this preamble, EPA has considered the costs to refineries and has estimated that the additional cost of gasoline will be about 0.65 cents per gallon. Though some refineries may face costs of up to 2.1 cents per gallon, and one refinery up to 2.8 cents per gallon, most will face much lower costs, as the averaging, banking, and trading provisions of the standards significantly ease the challenge of refineries to meet the standards.

In a perfectly competitive industry, this cost would be passed along completely to consumers. In an imperfectly competitive industry, as noted above, full cost pass-through is not necessary: Firms may choose to reduce impacts on sales by not passing along full costs. In 2004, the Federal Trade Commission reported that “concentration for most levels of the petroleum industry has remained low to moderate.”<sup>588</sup> Thus the assumption of competitive markets has some foundation in this industry. We estimate that the price increase that consumers are likely to face should be positive and up to the increase in manufacturers’ costs of gasoline production.

The Emissions Control Technology Association (ECTA) and Northeast States for Coordinated Air Use Management (NESCAUM) note that previous Tier 2 standards, which required greater reductions in absolute magnitude, do not appear to have had measurable adverse impacts on refineries. ECTA cites a study by Navigant Economics that found no measurable impact on gasoline price from Tier 2. NESCAUM notes that refineries used a number of technologies and facility improvements to achieve the standards in a cost-effective manner, and notes that the North American refining industry is making significant new investments in response to favorable long-term conditions. Small increases in gasoline price due to standards may be very difficult to identify, because of the natural volatility of gasoline prices.

The effect of higher gasoline prices on gasoline sales is expected to be different over the short and long term. In the long run, in response to the increase in fuel costs, consumers can more easily change their driving habits, including

where they live or what vehicles they use. Because of this, we expect that gasoline sales will decrease more in the long run compared to the short run as a result of the price increase due to the rule. However, because manufacturers’ costs are expected to increase less than one cent per gallon, we expect that the decrease in gasoline sales will be negligible over all time horizons.

#### D. Employment Impacts

This section discusses changes in employment due to the rule. We focus on the auto manufacturing sector and the refinery sector because they are directly regulated, and because they are likely to bear a substantial share of changes in employment due to this rule. We partially quantify impacts in the auto sector, providing a mix of qualitative and quantitative discussion, following the methods used in the Final Rulemaking for 2017–2025 Model Year Light-Duty Vehicle Greenhouse Gas Emissions and Corporate Average Fuel Economy Standards.<sup>589</sup> For the refinery sector we provide a qualitative analysis. We also include discussion of effects on the motor vehicle parts manufacturing sector because the auto manufacturing sector can either produce parts internally or buy them from an external supplier, and we do not have estimates of the likely breakdown of effort between the two sectors. For the same reasons, we discuss effects on producers of equipment that refiners will use to comply with the standards.

Chevron Products Company states that we did not consider the economic context of the time when discussing our impacts. As we stated in the NPRM, we recognize the importance of context. When the economy is at full employment, an environmental regulation is unlikely to have much impact on net overall U.S. employment; instead, labor would primarily be shifted from one sector to another. These shifts in employment impose an opportunity cost on society, approximated by the wages of the employees, as regulation diverts workers from other activities in the economy. In this situation, any effects on net employment are likely to be transitory as workers change jobs (e.g., some workers may need to be retrained or require time to search for new jobs, while shortages in some sectors or regions could bid up wages to attract workers).

On the other hand, if a regulation comes into effect during a period of high unemployment, a change in labor demand due to regulation may affect net

overall U.S. employment because the labor market is not in equilibrium. Schmalensee and Stavins point out that net positive employment effects are possible in the near term when the economy is at less than full employment due to the potential hiring of idle labor resources by the regulated sector to meet new requirements (e.g., to install new equipment) and new economic activity in sectors related to the regulated sector.<sup>590</sup> In the longer run, the net effect on employment is more difficult to predict and will depend on the way in which the related industries respond to the regulatory requirements. As Schmalensee and Stavins note, it is possible that the magnitude of the effect on employment could vary over time, region, and sector, and positive effects on employment in some regions or sectors could be offset by negative effects in other regions or sectors. For this reason, they urge caution in reporting partial employment effects since it can “paint an inaccurate picture of net employment impacts if not placed in the broader economic context.”

A number of commenters (including unions, environmentalists, investor organizations, Medical Advocates for Health Air, NESCAUM, and the National Association of Clean Air Agencies) argue that the standards will increase employment, by stimulating auto companies and refiners to invest in pollution abatement equipment. As will be discussed further below, EPA agrees that the standards are likely to lead to more employment to provide abatement equipment, but employment due to production may also be reduced (although by very small amounts) due to incrementally higher prices for vehicles and fuel; we expect the net impact on employment in the regulated sectors to be small.

Chevron Products Company states that we do not account for the hardship on local and regional economies due to the increase in refinery costs. Because we do not consider employment impacts to be large, even at local and regional scale, we do not expect large impacts on the economies at that scale.

ECTA argues that job impacts will be not only positive in the auto and auto parts sectors, but substantially more positive than EPA states, based on Regional Input-Output Modeling System (RIMS) multipliers that find increases of 5.9 jobs for every \$1 million investment in new auto parts. Multiplier impacts trace the entire chain of job impacts

<sup>588</sup> Federal Trade Commission, Bureau of Economics. (2004). *The Petroleum Industry: Mergers, Structural Change, and Antitrust Enforcement*. Retrieved August 16, 2011 from Federal Trade Commission Web site: <http://www.ftc.gov/os/2004/08/040813mergersinpetrolberpt.pdf> (Docket EPA–HQ–OAR–2011–0135–0055).

<sup>589</sup> 77 FR 62623 (October 15, 2012).

<sup>590</sup> Schmalensee, R., & Stavins, R. (2011). *A Guide to Economic and Policy Analysis of EPA’s Transport Rule*. White paper commissioned by Excelon Corporation (Docket EPA–HQ–OAR–2011–0135–0054).

associated with an expenditure, including factors such as changes in employment in retail establishments due to changes in workers in the auto sector. Because the expenditures will occur when unemployment is still high, ECTA argues, it is important to consider the multiplier effects of the expenditures that are embedded in the RIMS multipliers. As discussed above, the multiplier impacts of expenditures depend heavily on the state of the macroeconomy. Because of uncertainty over the state of the economy when the increased expenditures will occur, EPA has not quantified the multiplier impacts due to changes in employment associated with these standards. As discussed again below, some expenditures, perhaps especially in the refinery sector, will occur before the standards take effect, to get the manufacturing processes in place to meet the standards. These near-term expenditures may have some multiplier effects, because they are more likely to have their impacts during the current period of above-average unemployment. In contrast, the ongoing costs of complying with the standards, which contribute most directly to price increases, are likely to come in future years, when it is expected that unemployment rates will be lower.

The Mercatus Center at George Mason University recommended that we “acknowledge that both jobs gained and jobs destroyed are costs of the proposed regulation. Ideally, compliance jobs should be minimized, not viewed as a benefit of a regulation.” This assertion is confusing, in that it implies that any effect on employment, positive or negative, is costly. Marathon Petroleum Company and the American Petroleum Institute with the Association of Fuel and Petroleum Manufacturers argue that employment impacts should not be counted as benefits. Our analysis of the employment impacts of the standards is intended to identify additional ways that these standards will affect the public. Employment clearly provides benefits to the people who are employed, and reducing unemployment is considered a desirable outcome in times of high unemployment. EPA disagrees that minimizing compliance jobs should be an independent objective of this rulemaking. The objective of the program is to improve air quality through reductions in vehicle emissions; we provide information concerning employment impacts as part of our overall analysis of economic impacts from the rule.<sup>591</sup>

<sup>591</sup> We note that employment shows up in the benefit-cost analysis through labor costs, which are

The Mercatus Center also requests that we consider the long-term effects of unemployment on workers who may lose jobs, and that we acknowledge that those who lose jobs may not be the same people who gain jobs. We recognize there are costs to workers who shift from one job to another,<sup>592</sup> but we also note, as discussed further below, that we expect very small employment impacts from the standards.

After reviewing these comments, we conclude they have not identified any specific reason to depart from the approach to employment analysis that was used in the NPRM, though we here use a slightly modified theoretical framework. In the NPRM, we followed the theoretical structure in a study by Morgenstern, Pizer, and Shih (2002)<sup>593</sup> of the impacts of regulation in employment in the regulated sectors. We here shift to a very similar framework by Berman and Bui,<sup>594</sup> RIA Chapter 9.1 provides additional background on this framework. In Berman and Bui’s (2001, p. 274–75) theoretical model, the change in a firm’s labor demand arising from a change in regulation is decomposed into two main components: Output and substitution effects.<sup>595</sup>

- The output effect describes how, if labor-intensity of production is held constant, a decrease in output generally leads to a decrease in labor demand. However, as noted by Berman and Bui, although it is often assumed that regulation increases marginal cost, and thereby reduces output, it need not be the case. A regulation could induce a firm to upgrade to less polluting, and

included in the costs of achieving the standards; any increases in employment are part of the increased expenditures due to the standards, and decreases in employment reduce expenditures.

<sup>592</sup> E.g., Jacobson, Louis S., Robert J. LaLonde, and Daniel G. Sullivan, “Earnings Losses of Displaced Workers.” *American Economic Review* 83(4) (1993): 685–709 (Docket EPA–HQ–OAR–2011–0135).

<sup>593</sup> Morgenstern, R., Pizer, W., & Shih, J. (2002). Jobs Versus the Environment: An Industry-Level Perspective. *Journal of Environmental Economics and Management* 43, 412–436 (Docket EPA–HQ–OAR–2011–0135–0057).

<sup>594</sup> Berman, E. and L. T. M. Bui (2001). “Environmental Regulation and Labor Demand: Evidence from the South Coast Air Basin.” *Journal of Public Economics* 79(2): 265–295 (Docket EPA–HQ–OAR–2011–0135).

<sup>595</sup> The authors also discuss a third component, the impact of regulation on factor prices, but conclude that this effect is unlikely to be important for large competitive factor markets, such as labor and capital. Morgenstern, Pizer and Shih (2002) use a very similar model, but they break the employment effect into three parts: (1) The demand effect; (2) the cost effect; and (3) the factor-shift effect. See Morgenstern, Richard D., William A. Pizer, and Jih-Shyang Shih. “Jobs Versus the Environment: An Industry-Level Perspective.” *Journal of Environmental Economics and Management* 43 (2002): 412–436 (Docket EPA–HQ–OAR–2011–0135–0057).

more efficient equipment that lowers marginal production costs, for example. In such a case, output could theoretically increase.

- The substitution effect describes how, holding output constant, regulation affects the labor-intensity of production. Although increased environmental regulation generally results in higher utilization of production factors such as pollution control equipment and energy to operate that equipment, the resulting impact on labor demand is ambiguous. For example, equipment inspection requirements, specialized waste handling, or pollution technologies that are added to the production process may affect the number of workers necessary to produce a unit of output. Berman and Bui (2001) model the substitution effect as the effect of regulation on pollution control equipment and expenditures that are required by the regulation and the corresponding change in labor-intensity of production.

In summary, as the output and substitution effects may be both positive, both negative or some combination, standard neoclassical theory alone does not point to a definitive net effect of regulation on labor demand at regulated firms.

## 1. Employment Impacts in the Auto Sector

Following the Berman and Bui (2001) framework, we consider two effects for the auto sector: The output effect and the substitution effect.

### a. The Output Effect

The output effect depends on the effects of this rule on vehicle sales. If vehicle sales decrease, employment associated with these activities will decrease. As discussed in Section X.B, we do not make a quantitative estimate on the effect of the rule on vehicle sales but we note that the decrease in vehicle sales is expected to be negligible. Thus we expect any decrease in employment in the auto sector through the output effect to be small as well.

### b. The Substitution Effect

The output effect, above, measures the effect due to new vehicle sales only. The substitution effect measures the impacts due to the changes in technologies needed for vehicles to meet the standards, separate from the effect on output (that is, as though holding output constant). This effect includes both changes in employment due to incorporation of abatement technologies and overall changes in the labor intensity of manufacturing. We estimate

the substitution effect by multiplying the ratio of workers to each \$1 million of expenditures in the auto sector by the cost estimates for complying with the rule. This approach estimates the effects of increased expenditures while holding constant the labor intensity of manufacturing; it does not take into account changes in labor intensity due to changes in the nature of production. This latter effect could either increase or decrease the employment impacts estimated here.<sup>596</sup>

Some of the costs of this rule will be spent directly in the auto manufacturing sector, but it is also likely that some of the costs will be spent in the auto parts manufacturing sector. We separately present the ratios for both the auto manufacturing sector and the auto parts manufacturing sector.

There are several public sources for estimates of employment per \$1 million expenditures. As discussed in the RIA, EPA examines several sources for these estimates: The U.S. Bureau of Labor Statistics (BLS)'s Employment Requirements Matrix (ERM),<sup>597</sup> the Census Bureau's Annual Survey of Manufactures<sup>598</sup> (ASM), and its Economic Census. The use of these ratios has both advantages and limitations. It is often possible to estimate these ratios for quite specific sectors of the economy: For instance, it is possible to estimate the average number of workers in the light-duty

vehicle manufacturing sector per \$1 million spent in the sector, rather than use the ratio from another, more aggregated sector, such as motor vehicle manufacturing. As a result, it is not necessary to extrapolate employment ratios from possibly unrelated sectors. On the other hand, these estimates are averages for the sectors, covering all the activities in those sectors; they may not be representative of the labor required when expenditures are required on specific activities, or when manufacturing processes change sufficiently that labor intensity changes. For instance, the ratio for the motor vehicle manufacturing sector represents the ratio for all vehicle manufacturing, not just for emissions reductions associated with compliance activities. In addition, these estimates do not include changes in sectors that supply these sectors, such as steel or electronics producers. They thus may best be viewed as the effects on employment in the specific sectors due to the changes in expenditures in those sectors, rather than as an assessment of all employment changes due to these changes in expenditures.

The values used here are adjusted to remove the employment effects of imports through use of a ratio of domestic production to domestic sales of 0.667.<sup>599</sup> As discussed in the RIA, trends in the BLS ERM are used to

estimate productivity improvements over time that are used to adjust these ratios over time.

Table X-1 provides estimates of the substitution effect of this rule on employment. Chapter 2.1 of the RIA discusses the vehicle cost estimates developed for this rule, discussed in Section VII.A, presented in the second column. The maximum value for employment impacts per \$1 million (2011\$) (before adjustments for changes in productivity, after accounting for the share of domestic production) is 1.771 if all the additional costs are in the parts sector; the minimum value is 0.389, if all the additional costs are in the light-duty vehicle manufacturing sector. Increased costs of vehicles and parts will, by itself, and holding labor intensity constant, be expected to increase employment between 2017 and 2025 by some hundreds of jobs each year.

While we estimate employment impacts, measured in job-years, beginning with program implementation, some of these employment gains may occur earlier as auto manufacturers and parts suppliers hire staff in anticipation of compliance with the standard. A job-year is a way to calculate the amount of work needed to complete a specific task. For example, a job-year is one year of work for one person.

TABLE X-1—EMPLOYMENT EFFECTS DUE TO INCREASED COSTS OF VEHICLES AND PARTS, IN JOB-YEARS

Year	Costs (Millions of 2010\$)	Maximum employment effect (if all expenditures are in the parts sector)	Minimum employment effect (if all expenditures are in the light duty vehicle mfg sector)
2016 .....	\$21	0	0
2017 .....	297	400	100
2018 .....	615	800	200
2019 .....	653	800	200
2020 .....	697	800	200
2021 .....	725	800	200
2022 .....	758	800	200
2023 .....	751	800	200
2024 .....	761	800	200
2025 .....	773	700	200

c. Summary of Employment Effects in the Auto Sector

The overall effect of the standards on auto sector employment depends on the relative magnitude of the output effect and the substitution effect. Because we do not have quantitative estimates of the

output effect, and only a partial estimate of the substitution effect, we cannot reach a quantitative estimate of the overall employment effects of the standards on auto sector employment or even whether the total effect will be positive or negative. However, given

that the expected increase in production costs to the auto manufacturers is relatively small, we expect that the magnitudes of all these effects will be small as well.

Additionally, the standards are not expected to provide incentives for

<sup>596</sup> As noted above, Morgenstern et al. (2002) separate the effect of holding output constant into two effects: The cost effect, which holds labor intensity constant, and the factor shift effect, which estimates those changes in labor intensity.

<sup>597</sup> Bureau of Labor Statistics. *Employment Requirements Matrix*. [http://www.bls.gov/emp/ep\\_](http://www.bls.gov/emp/ep_)

[data\\_emp\\_requirements.htm](http://www.bls.gov/emp/ep_data_emp_requirements.htm) (Docket EPA-HQ-OAR-2011-0135).

<sup>598</sup> U.S. Census Bureau. *Annual Survey of Manufactures*. <http://www.census.gov/manufacturing/asm/index.html> (Docket EPA-HQ-OAR-2011-0135).

<sup>599</sup> To estimate the proportion of domestic production affected by the change in sales, we use data from Ward's Automotive Group for total car and truck production in the U.S. compared to total car and truck sales in the U.S. For the period 2001-2010, the proportion is 66.7 percent (Docket EPA-HQ-OAR-2011-0135-0333).



manufacturers to shift employment between domestic and foreign production. This is because the increased standards of the rule will apply to vehicles sold in the U.S. regardless of where they are produced. If foreign manufacturers already have increased expertise in satisfying the requirements of the rule, there may be some initial incentive for foreign production, but the opportunity for domestic manufacturers to sell in other markets might increase. To the extent that the requirements of this rule might lead to installation and use of technologies that other countries may seek now or in the future, developing this capacity for domestic production now may provide some additional ability to serve those markets. This potential benefit for domestic production will not apply if other countries are not likely to have similar standards.

## 2. Refinery Employment Impacts

The Berman and Bui (2001) framework of output and substitution effects can also be applied to the impact of the rule on employment in the refinery sector. Here we use a fully qualitative approach. A qualitative discussion allows for a wider incorporation of additional considerations, such as timing of impacts and the effects of the rule on imports and exports. Because the discussion is qualitative, we do not sum the net effects on employment.

The output effect on refining sector employment is expected to be negative. The discussion in Section X.C above suggested that the standards will cause a small decrease in the quantity of gasoline demanded due to higher production costs being passed through to consumers. This slightly reduced level of sales will likely have a negative impact on employment in the refining sector. While we do not quantify the level of job losses that could be expected here, recall that the quantity of gasoline sold as a result of these standards is expected to decrease by only a very small amount over any time horizon.

The substitution effect of the standards on employment in the refining sector can be either positive or negative in the Berman and Bui framework; here, we expect a small, possibly positive impact. In order to satisfy the requirements of the rule, firms in the refining industry are expected to perform additional work that will require hiring more employees, especially perhaps in the short run. Section V.L.2.e discusses the expected employment needed to reduce the sulfur

content of fuels; as noted there, to meet the Tier 3 sulfur standards, refiners are expected to invest \$2 billion between 2012 and 2019 and utilize approximately 250 front-end design and engineering jobs and 1,500 construction jobs. As the petroleum sector employed approximately 71,000 workers in 2011, this temporary increase in employment will be small when compared to 2011 levels.

Chevron Products Company states that we have not considered global competitive forces in our assessment. As we discussed in the NPRM, this rule is not expected to provide incentives to shift employment between domestic and foreign production. First, the standards will apply to gasoline sold in the U.S. regardless of where it has been produced. U.S. gasoline demand is projected to continue to decline for the foreseeable future in response to higher gasoline prices, more stringent vehicle and engine greenhouse gas and fuel economy standards as well as increased use of renewable fuels. As a result, this analysis of incentives to shift employment between domestic and foreign production focuses on investments for existing capacity instead of expanding capacity.<sup>600</sup> In this case, what is relevant is whether the necessary modifications to comply with Tier 3 will be significantly cheaper overseas than in the U.S.

The main impacts on capital and operating costs to comply with Tier 3 associated with adding hydrotreating capacity are likely to be similar overseas as in the U.S. This is particularly true when analyzing likely sources of U.S. imports. The majority of gasoline imported to the U.S. today comes into the East Coast and is sourced out of either Europe or refineries in Canada or the Caribbean that exist almost solely to supply the U.S. market. These Canadian and Caribbean refineries, by virtue of their focus on the U.S. market, are very similar to U.S. based refineries and would be expected to have to incur similar capital and operating costs as their U.S. based competitors meeting the 10 ppm standard. Furthermore, the European refineries are already producing gasoline to a 10 ppm sulfur cap for Europe. To the extent they have refinery streams that are more difficult to hydrotreat, the U.S. market currently serves as an outlet for their higher sulfur gasoline streams. As a result, they may incur capital and operating costs on a per gallon basis at least as high as for

<sup>600</sup> While refinery capacity has been increasing around the world in recent years, it has been designed primarily to supply foreign markets other than the U.S. (e.g., increasing demand in China and India).

their U.S. based competitors for these remaining higher sulfur gasoline streams. Alternatively, they may instead choose to find markets outside the U.S., opening the way for increased U.S. based refinery demand.

Finally, despite refining industry projections that previously imposed diesel rules would lead to greater U.S. reliance on imports through major negative impacts on domestic refining, the reverse has actually occurred. Over the last 8 years, imports of gasoline and diesel fuel have continued to be the marginal supply, and have even dropped precipitously so that the U.S. is now a net exporter of diesel fuel and is importing half the gasoline that it did at its peak in 2006. With the projected decline in future gasoline demand in the U.S. as vehicle fuel efficiency improves, gasoline imports are expected to continue to decline.

Thus it is expected that for the refining sector, the output effect will lower employment, and the substitution effect will raise employment. As a whole then, it is not evident whether the standards will increase or decrease employment in the refining sector. However, given the small anticipated reduction in quantity sold, it appears that the standards will not have major employment consequences for this sector.

The petroleum refining industry is one of the manufacturing industries studied by Berman and Bui (2001) when they looked at the effect of environmental expenditures on employment. They found that "Employment effects are very small, generally positive, but not statistically different from zero." (p. 281) [Berman and Bui, Table 3]. Berman and Bui also state that the estimates rule out large negative effects (p. 282). Because most of the abatement cost of the regulations they analyze is incurred by refineries, in their sample, they report separate employment effects for refineries and non-refineries "which are also all small." (p. 282). Berman and Bui suggest some explanations for the zero or small estimates, particularly for oil refineries: they are capital-intensive industries with relatively little employment when compared to other manufacturing; they face relatively inelastic demand because they sell output in local markets and/or because there are no unregulated refineries to compete with; and, finally, regulations may have been associated with productivity gains in petroleum refineries. We note that the regulations that these estimates are derived from are not directly comparable to the current rule; they are based on the costs of

reductions in refinery air pollution emissions instead of changing fuel properties, and therefore may not be applicable for these standards. The American Petroleum Institute requested that we delete reference to use of analysis by Morgenstern et al. (2002) because it is based on temporary construction jobs and a single study. We had presented that figure not as a conclusive estimate, but rather as one estimate that we too consider of unclear applicability to the standards; we have substituted Berman and Bui's results. Several commenters cite a study by Navigant Economics that estimates 24,500 installation jobs during the first three years of the program, and 5,300 permanent jobs, associated with the refinery standards. These estimates include employment not just in the refinery sector, but also multiplier effects (discussed above) for suppliers, which EPA does not estimate. As noted above, EPA estimates approximately 250 front-end design and engineering jobs and 1,500 construction jobs.

Section 5.3 of the RIA contains some historical discussion regarding the impact on refineries and refining capacity of earlier rules which resulted in higher costs for refiners. Over the period 2003–2011, when a number of rules were being implemented, EIA data show a net of two refinery closures on its Web site. Meanwhile, over this same period the average size of U.S. refineries increased from 113,000 barrels per day to 123,000 barrels per day, and total U.S. refining capacity increased by six percent. Thus, historically during a time when rules with much larger expected impacts were being implemented (the 2003 ultra-low sulfur nonroad diesel proposal alone was expected to have a cost impact on refineries more than five times greater than the current rule), U.S. refining capacity increased even as the number of U.S. refineries slightly fell. While closing refineries has a negative effect on industry employment, it is likely that the increased refining capacity at many of the remaining plants had a positive effect on industry employment.

The standards are also likely to have a positive impact on employment among producers of equipment that refiners will use to comply with the standards. Section V.A.2.c notes that some refiners are expected to need to revamp their current treatment units, and others will need to add additional treatment units. Producers of this equipment will be expected to hire additional labor to meet this increased demand. We also note that the employment effects may be different in the immediate implementation phase

than in the ongoing compliance phase. It is expected that the employment increases through the substitution effect from revamping old equipment and installing additional equipment should occur in the near term, when current unemployment levels are high, and the opportunity cost of workers is relatively low. Meanwhile, the employment decreases in the refining sector from the output effect will not start until 2017, when compliance will be required, and when unemployment is expected to be reduced; in a time of full employment, any changes in employment levels in the regulated sector are mostly expected to be offset by changes in employment in other sectors.

#### **XI. Public Participation**

Many interested parties participated in the rulemaking process that culminates with this final rule. This process provided opportunity for submitting written public comments following the proposal that we published on May 21, 2013 (78 FR 29816), and we considered these comments in developing the final rule. In addition, we held public hearings on the proposed rulemaking on April 24 and 29, 2013, and we have considered comments presented at the hearing.

Throughout the rulemaking process, EPA met with stakeholders including representatives from various industries (vehicle manufacturers, fuel refiners, fuel distributors, suppliers, engine manufacturers, etc.), states, non-governmental organizations, and others.

We have prepared a detailed Summary and Analysis of Comments document, which describes the comments we received on the proposal and our responses. The Summary and Analysis of Comments is available in the docket for this rule at the Internet address listed under **ADDRESSES**, as well as on the Office of Transportation and Air Quality Web site (<http://www.epa.gov/tier3.htm>). In addition, comments and responses for key issues are included throughout this preamble.

#### **XII. Statutory and Executive Order Reviews**

##### *A. Executive Order 12866: Regulatory Planning and Review and Executive Order 13563: Improving Regulation and Regulatory Review*

Under section 3(f)(1) of Executive Order 12866 (58 FR 51735, October 4, 1993), this action is an “economically significant regulatory action” because it is likely to have an annual effect on the economy of \$100 million or more. Accordingly, EPA submitted this action to the Office of Management and Budget

(OMB) for review under Executive Orders 12866 and 13563 (76 FR 3821, January 21, 2011) and any changes made in response to OMB recommendations have been documented in the docket for this action.

In addition, EPA prepared an analysis of the potential costs and benefits associated with this action. This analysis is contained in Sections VII and VIII of this preamble and in Chapter 8 of the RIA. A copy of the analysis is available in the docket for this action.

##### *B. Paperwork Reduction Act*

This action is continuing existing information collection from the Tier 2 program, with additional changes as noted below. The Office of Management and Budget (OMB) has previously approved the information collection requirements contained in the existing the existing Tier 2 gasoline rule (65 FR 6698, February 10, 2000), under the provisions of the Paperwork Reduction Act, 44 U.S.C. 3501 et seq. The ICRs were assigned OMB Control Numbers 2060–0437 (fuels), 2060–0104 (light-duty vehicles), 2060–0287 (heavy-duty vehicles), and 2060–0086 (in-use verification program). The ICRs are being revised to reflect the changes being finalized today. The additional information collection requirements in this rule will be submitted for approval to OMB under the *Paperwork Reduction Act*. The information collection requirements are not enforceable until OMB approves them.

This rule contains reporting and recordkeeping requirements to implement EPA's motor vehicle certification program and the manufacturers' in-use verification program (IUVP). Existing regulations require manufacturers to submit emissions information to EPA in conjunction with these two programs. Manufacturers must submit an application for emission certification prior to production. The application describes the major aspects of the product line, technical details of the emission control systems, and the results of tests to indicate compliance with the emissions limitations. The application and supporting test results are reviewed and, if appropriate, a certificate of conformity is issued. Subsequently, low- and high-mileage vehicles in use are tested for emissions by manufacturers and the results of those tests reported to EPA. EPA estimates the total number of respondents to be 55, the total burden hours to be 73,567, and the total cost to respondents to be \$7,690,934.

As a result of the change in certification test fuel from 9 RVP E0 to

9 RVP E10, EPA must assess the need to make test procedure adjustments related to fuel economy testing such that the change in test fuel quality does not impact the stringency of the CAFE standards. EPA recognized that this action was needed in the proposed rule, but deferred proposing a specific adjustment or set of adjustments because the data needed to determine the value(s) for the adjustments was not available. Historically, manufacturers have used criteria pollutant emission information from the exhaust emission testing for certification as part of the data needed to determine fuel economy values. The final rule sets a process in motion for EPA to gather the information need to develop any test procedure adjustments. While the basic data will likely be available in late 2015 or early 2016, any rule to enact potential test procedure adjustments will take additional time. During this interim period, any LEV III or early Tier 3 vehicles using E10 test fuel for exhaust emission certifications will have to be tested for fuel economy values on E0. EPA has studied the expected phase-in rates for these vehicles in LEV III and estimates that for the 2015–2017 model years there will an average about 35 additional tests per year for the industry with an hour burden of about 30 hours per test. Thus, over this three-year period, the added hour burden is 1050 hours and the sum of the cost of testing and the hour burden is \$402,150.

This rule also contains reporting, recordkeeping, and Product Transfer Document (PTD) requirements for refiners and importers of motor vehicle gasoline. This rule contains registration, reporting, recordkeeping, and PTD requirements for producers and importers of denatured fuel ethanol (DFE) and other oxygenates. This rule also contains registration, recordkeeping, and PTD requirements for producers of certified ethanol denaturants. This rule also contains recordkeeping and PTD requirements for producers of gasoline additives. The reporting, recordkeeping, and PTD

requirements for refiners and importers of motor vehicle gasoline are the same requirements that exist under the Tier 2 sulfur program.<sup>601</sup> The registration and reporting requirements for DFE producers and importers are new as are the registration requirements for producers and importers of certified ethanol denaturants. The recordkeeping and PTD requirements for gasoline additive producers, DFE manufacturers, ethanol denaturant manufacturers, and downstream parties under the Tier 3 program are new but should be minimal since we expect that they are already followed as part of normal business practices. EPA estimates the total number of respondents to be 2,675, the total burden hours to be 84,000 and the total cost to respondents to be \$6,300,000.

Finally, this rule also contains provisions for qualifications of laboratories on test methods. We have adopted recordkeeping and reporting requirements that would apply to fuel testing laboratories. The collected data will permit EPA to: (1) Qualify laboratories to use test methods based upon accuracy and precision criteria supported by industry; and (2) Ensure that various fuels meet the standards required under the regulations at 40 CFR part 80 and that the associated benefits to human health and the environment are realized. We estimate that 750 laboratories may be subject to the information collection. This estimate is based upon our experience with qualification of laboratories under the existing diesel sulfur program. We estimate an annual reporting burden of 95 hours per respondent and an annual recordkeeping burden of 104 hours, yielding a total of 199 hours. For those laboratories that elect to be reference installations, the annual reporting burden would be 95 hours and the annual recordkeeping burden would be 128 hours. Burden is defined at 5 CFR 1320.3(b).

The ICR supporting statements can be found in Docket ID number EPA–HQ–OAR–2011–0135.

An agency may not conduct or sponsor, and a person is not required to respond to a collection of information unless it displays a currently valid OMB control number. The OMB control numbers for EPA's regulations in 40 CFR are listed in 40 CFR part 9. When the ICRs are approved by OMB, the Agency will publish a technical amendment to 40 CFR part 9 in the **Federal Register** to display the OMB control numbers for the approved information collection requirements contained in this final rule.

We did not receive any specific comments on the ICR; comments received regarding compliance-related provisions are discussed above in Sections IV and V.

### C. Regulatory Flexibility Act

#### 1. Overview

The Regulatory Flexibility Act (RFA) generally requires an agency to prepare a regulatory flexibility analysis of any rule subject to notice and comment rulemaking requirements under the Administrative Procedure Act or any other statute unless the agency certifies that the rule will not have a significant economic impact on a substantial number of small entities. Small entities include small businesses, small organizations, and small governmental jurisdictions.

For purposes of assessing the impacts of today's rule on small entities, small entity is defined as: (1) A small business as defined by the Small Business Administration's (SBA) regulations at 13 CFR 121.201 (see table below); (2) a small governmental jurisdiction that is a government of a city, county, town, school district or special district with a population of less than 50,000; and (3) a small organization that is any not-for-profit enterprise which is independently owned and operated and is not dominant in its field.

The following table provides an overview of the primary SBA small business categories potentially affected by this regulation:

Industry	NAICS <sup>a</sup> Code (2007)	Defined as small entity by SBA if less than or equal to
Gasoline fuel refiners and importers .....	324110 .....	1,500 employees.
Ethanol producers .....	325193 .....	1,000 employees.
Gasoline additive manufacturers .....	325199 .....	1,000 employees.
	325998 .....	500 employees.
	424690 .....	100 employees.
Transmix processors .....	Varied .....	1,500 employees.
Petroleum bulk stations and terminals .....	424710 .....	100 employees.
Other warehousing and storage-bulk petroleum storage .....	493190 .....	\$25.5 million (annual receipts).
Light-duty vehicle and light-duty truck manufacturers .....	336111, 336112 .....	1,000 employees.

<sup>601</sup> 65 FR 6698, February 10, 2000; OMB Control Number: 2060–0437; EPA ICR 1907.05.

Industry	NAICS <sup>a</sup> Code (2007)	Defined as small entity by SBA if less than or equal to
Independent commercial importers .....	811111, 811112 , 811198 .....	\$7 million (annual receipts).
Alternative fuel converters .....	335312 .....	1,000 employees.
	336312 .....	750 employees.
	336322 .....	"
	336399 .....	"
	811198 .....	\$7 million (annual receipts).
On-highway heavy-duty engine & vehicle (>8,500 lbs GVWR) manufacturers.	333618 .....	1,000 employees.
	336120 .....	"
	336211 .....	"
	336312 .....	750 employees.

**Note:** <sup>a</sup> North American Industrial Classification System.

2. Background

EPA’s Tier 2 Vehicle and Gasoline Sulfur Program, which was finalized in February 2000, took a systems-based approach to motor vehicle pollution by setting standards for both passenger vehicles and their fuel (gasoline). The program set stricter tailpipe and evaporative emissions standards for criteria pollutants from vehicles beginning with model year (MY) 2004 and phasing in through 2009. The program also lowered the sulfur content of gasoline, to a 30 ppm refinery average, 80 ppm per-gallon cap, and 95 ppm downstream cap; beginning in 2004 and phasing in through 2008. The potential to extend the phase-in for small refiners and approved Gasoline Phase-In Area (GPA) refiners through the end of 2010 was provided in the Highway Diesel Rule<sup>602</sup> in exchange for early compliance with the diesel program. Similar to the Tier 2 rule, the Tier 3 program is a comprehensive, systems-based approach to address the impact of light-duty vehicles and certain heavy-duty vehicles on air quality and health.

Pursuant to section 603 of the RFA, EPA prepared an initial regulatory flexibility analysis (IRFA) for the proposed rule and convened a Small Business Advocacy Review Panel to obtain advice and recommendations of representatives of the regulated small entities (see 78 FR 29816, May 21, 2013). A detailed discussion of the Panel’s advice and recommendations is found in the Panel Report, located in the rulemaking docket (document number: EPA-HQ-OAR-2011-0135-0423). A summary of the Panel’s recommendations is presented at 78 FR 29994 (May 21, 2013).

As required by section 604 of the RFA, we also prepared a final regulatory flexibility analysis (FRFA) for today’s final rule. The FRFA addresses the issues raised by public comments on the

IRFA, which was part of the proposal of this rule. The FRFA is available for review in the docket (see Chapter 10 of the RIA) and is summarized below.

3. Reason for Today’s Rule

This rule establishes more stringent vehicle emissions standards and reduces the sulfur content of gasoline beginning in 2017, as part of a systems approach in addressing the impacts of motor vehicles and fuels on air quality and public health. The gasoline sulfur standards will make emission control systems more effective and enable more stringent vehicle emissions standards, and the vehicle standards will reduce vehicle tailpipe and evaporative emissions. This will result in significant reductions in pollutants such as ozone, particulate matter, and air toxics. For a more detailed discussion of the reasoning for today’s rule, please see Sections II and III of this preamble. The vehicle and fuel programs are further discussed in Sections IV and V, respectively.

4. Legal Basis for Agency Action

The Clean Air Act (CAA) authorizes EPA to establish emissions standards for motor vehicles to address air pollution that may reasonably be anticipated to endanger public health or welfare. EPA also has authority to establish fuel controls to address such air pollution. The authority for the vehicle emission standards comes from CAA section 202(a), Section 202(k) provides EPA with authority to issue and revise regulations applicable to evaporative emissions of hydrocarbons from gasoline-fueled motor vehicles, and section 206(d) authorizes EPA to establish methods and procedures for testing whether a motor vehicle or motor vehicle engine conforms with section 202 requirements. The authority for the fuel standards comes from section 211(c).

For more detailed information on our legal authority for today’s proposal,

please see Sections II.A and V.M of this preamble.

5. Summary of Potentially Affected Small Entities

The table above lists industries/sectors potentially affected by the Tier 3 rule. For businesses potentially impacted by the Tier 3 vehicle standards, this includes vehicle manufacturers, alternative fuel converters, and independent commercial importers. For businesses potentially impacted by the Tier 3 gasoline sulfur standards, this includes gasoline refiners and importers, distributors, fuel additive manufacturers, transmix processors, and ethanol producers.

EPA used a variety of sources to identify which entities are appropriately considered “small.” EPA used the criteria for small entities developed by the Small Business Administration under the North American Industry Classification System (NAICS) as a guide. Information about these entities comes from sources including the Energy Information Administration (EIA) within the U.S. Department of Energy, oil industry literature, EPA’s certification data, and previous rulemakings that have affected these industries. EPA then found employment information for these companies using the business information database Hoover’s Online (a subsidiary of Dun and Bradstreet). These entities fall under the categories listed in the table.

6. Reporting, Recordkeeping, and Compliance

For any emission control program, EPA must have assurances that the regulated products will meet the standards. The program that EPA is finalizing for manufacturers subject to this rule will include testing, reporting, and recordkeeping requirements for manufacturers of vehicles covered by the Tier 3 regulations. Testing requirements for these manufacturers will include certification emission

<sup>602</sup> 66 FR 5136 (January 18, 2001).

(including deterioration factor) testing, in-use testing, and production line testing. Reporting requirements will include emission test data and technical data on the vehicles. Manufacturers must keep records of this information.

Similarly for any fuel control program, EPA must have the assurance that fuel produced, distributed, sold and used meets the applicable standard. The recordkeeping, reporting, and compliance provisions of this rule are consistent with those in place today for other fuel programs. Further, we will use existing registration and reporting systems that parties in the fuel production and distribution industry are already familiar with.

#### 7. Related Federal Rules

The primary federal rules that are related to this final rule are: The Tier 2 Vehicle/Gasoline Sulfur rulemaking (65 FR 6698, February 10, 2000), the 2017 Light-duty Greenhouse Gas (LD GHG) rule (77 FR 62623), and the Greenhouse Gas Emissions Standards and Fuel Efficiency Standards for Medium- and Heavy-Duty Engines and Vehicles (HD GHG) rule (76 FR 57106).

The LD GHG and HD GHG rules are coordinated efforts by EPA and the National Highway Traffic Safety Administration (NHTSA) taking steps to reduce GHG emissions and improve fuel efficiency from on-road vehicles and engines.

#### 8. Steps Taken To Minimize the Economic Impact on Small Entities

##### a. Significant Panel Findings

The Small Business Advocacy Review Panel (SBAR Panel, or the Panel) considered regulatory options and flexibilities to help mitigate potential adverse effects on small businesses as a result of this rule. During the SBREFA Panel process, the Panel sought out and received comments on the regulatory options and flexibilities that were presented to SERs and Panel members. As described below, much of the Panel's recommendations were proposed, and many of those flexibilities are being finalized today. (The recommendations of the Panel are also located in Section 9 of the SBREFA Final Panel Report, which is available in the public docket.)

In today's action we are also finalizing some additional flexibilities that were not discussed during the Panel process.

##### b. Outreach With Small Entities and the Panel Process

As required by section 609(b) of the RFA, as amended by SBREFA, we conducted outreach to small entities and convened an SBAR Panel on August 4, 2011 to obtain advice and

recommendations of representatives of the small entities that would be subject to the Tier 3 requirements.

As part of the SBAR Panel process, we conducted outreach with representatives of small businesses that would be affected by the rule. We met with these SERs to discuss the potential rulemaking approaches and flexibility options to decrease the impact of the rulemaking on their industries. The SERs provided written comments to the Panel, specifically on regulatory alternatives that could help to minimize the rule's impact on small businesses.

The Panel's findings and discussions were based on the information that was available during the term of the Panel and issues that were raised by the SERs during the outreach meetings and in their comments. It was agreed that EPA should consider the issues raised by the SERs and discussions had by the Panel itself, and that EPA should consider comments on flexibility alternatives that would help to mitigate negative impacts on small businesses to the extent legally allowable by the Clean Air Act.

Alternatives discussed throughout the Panel process included those offered in previous or current EPA rulemakings, as well as alternatives suggested by SERs and Panel members. A full discussion of the regulatory alternatives and hardship provisions discussed and recommended by the Panel can be found in the SBREFA Final Panel Report, located in the rulemaking docket. A summary of the Panel's recommendations, what the Agency proposed, and what is being finalized today is discussed below. (A more detailed discussion of the final provisions for small entities can be found in Sections IV.G and V.E.)

It should be noted that during the Panel process, two additional issues were discussed with SERs. EPA was considering extending the new certification fuel specifications to all regulatory categories of engines, vehicles, equipment, and fuel system components that use gasoline. This would have included a wide range of additional applications, including small nonroad engines used in lawn and garden applications, recreational vehicles such as ATVs and snowmobiles, recreational marine applications, on-highway motorcycles, and heavy-duty gasoline engines. In addition, EPA considered new volatility (Reid Vapor Pressure, or RVP) standards for in-use gasoline. Neither of these issues was proposed, thus the discussion of Panel recommendations below does not address these issues, however they are addressed in the Final Panel Report.

c. Panel Recommendations, Proposed Provisions, and Provisions Being Finalized Today

##### i. Tier 3 Fuels

###### (1) Lead Time—Sulfur

The Panel recommended that EPA allow small refiners to postpone their compliance with the Tier 3 program for up to three years. EPA proposed, and is finalizing, this provision. Approved small refiners will have from January 1, 2017 through December 31, 2019 to continue production of gasoline with an average sulfur level of 30 ppm (per the Tier 2 gasoline sulfur program). Compliance with the 10 ppm annual average sulfur standard will begin on January 1, 2020. As discussed further in Section V.D.6, small refiners may continue to generate sulfur credits relative to the 30 ppm sulfur standard through December 31, 2019. Comments received on the small refiner provisions were generally supportive of the proposed three-year delay. However, commenters did not agree with EPA's proposal that small refiners could only generate early credits relative to the 10 ppm sulfur standard beginning January 1, 2017, and requested an early credit generation period for small refiners relative to the 30 ppm sulfur standard.

As small refiners will still be subject to the 30 ppm sulfur standard when the Tier 3 program begins on January 1, 2017, we are finalizing that small refiners may continue to generate credits relative to 30 ppm through December 31, 2019. Additionally, from January 1, 2017 through December 1, 2019, small refiners may split their credit generation between both the 10 ppm and 30 ppm standards (without double-counting). For example, during this time period, a small refiner with an average gasoline sulfur level of 8 ppm could generate 20 ppm-volume credits (30–10 ppm, relative to the 30 ppm Tier 2 sulfur standard) plus 2 ppm-volume credits (10–8 ppm, relative to the 10 ppm Tier 3 sulfur standard).

###### (2) Provisions for Additive Manufacturers

During the SBREFA Panel process, different requirements than those proposed (and being finalized today) were discussed for additive manufacturers. Thus, the provisions recommended by the Panel were not applicable to the provisions proposed and now finalized for these parties. More information on the Panel's recommendations for gasoline additive manufacturers can be found in the Final Panel Report, located in the rulemaking docket.

We proposed that parties introducing additives to gasoline greater than 1.0 volume percent would be required to satisfy all of the obligations of a fuel manufacturer, including demonstration that the finished blend meets the applicable sulfur specification. We also proposed a maximum sulfur contribution of 3 ppm from the use of a gasoline additive added downstream of the refinery at less than 1.0 volume percent (when added at the maximum recommended treatment rate). Lastly, we proposed that additive manufacturers would need to maintain records of their additive production quality control activities for five years.

As discussed further in Section V.C., we are finalizing the requirement that manufacturers of gasoline additives used downstream of the refinery at less than 1.0 volume percent must limit the sulfur contribution to the finished gasoline from the use of the additive to less than 3 ppm when the additive is used at the maximum recommended treatment rate. For each batch of additive produced, the manufacturer must retain sulfur test records for five years, and must make these records available to EPA upon request. Parties that introduce additives to gasoline at over 1.0 volume percent will be required to satisfy all of the obligations of a fuel manufacturer, including demonstration that the finished blend meets the applicable sulfur specification.

### (3) Refinery Gate and Downstream Caps

The Panel recommended that EPA assess and request comment on retaining the current Tier 2 refinery gate and downstream caps of 80 and 95 ppm, respectively, to help provide maximum flexibility and avoid system upsets for the entire refining and distribution system. The Panel also recommended that EPA request comment on additional refinery gate and downstream caps above 20/25 ppm but below 80/95 ppm. The Panel expressed concern with a refinery gate cap as low as 20 ppm, because such a standard could cause operational problems for small refiners during a refinery turnaround or an upset—a cap of this level could result in a refiner not being able to produce gasoline. The Panel likewise expressed concerns that a downstream cap of 25 ppm could cause problems for small downstream entities, such as transmix processors, because they may not be able to reprocess finished gasoline down to this level.

In the proposal, EPA co-proposed caps of 80/95 ppm and 50/65 ppm and took comment on caps at 20/25 ppm. However, as discussed above in Section

V.C, we are finalizing retaining the Tier 2 80 and 95 ppm caps. Since we are retaining the same caps from the Tier 2 program that entities in the fuel industry are currently complying with, we do not believe that additional flexibilities with respect to the refinery gate and downstream sulfur caps are needed.

### (4) Hardship Provisions

The Panel recommended that EPA propose hardship provisions for all gasoline refiners and importers, similar to those in prior EPA fuels programs: (a) The extreme unforeseen circumstances hardship provision, and (b) the extreme hardship provision. The Panel also recommended that if EPA were to propose lower refinery gate and downstream caps, EPA should also consider hardship relief in the form of long-term relief on the sulfur cap if the circumstances both warrant it and can be structured in a way to allow for it. EPA proposed, and is finalizing, both the extreme unforeseen circumstances and extreme hardship provisions for all gasoline refiners and importers. As described in Section V.E.2, hardship relief will be granted on a case-by-case basis following a showing that compliance (especially through the use of credits) is not feasible. If a hardship waiver is granted, EPA will determine appropriate hardship relief based on the refiner's hardship application and an assessment of the credit market at that time.

#### ii. Tier 3 Vehicles

As discussed in Section 5 of the Panel Report, in addition to vehicle manufacturers, two categories that include small businesses are covered by the new vehicle standards: Independent commercial importers (ICIs), and alternative fuel vehicle converters. As discussed below, EPA's expectation at the time of the Panel process was to propose a set of flexibilities that would be available to all small entities in these three business categories as well as to small volume manufacturers (SVMs) that sell less than 5,000 vehicles per year. The Panel identified a number of entities covered by the vehicle standards that qualify as small businesses under the SBA definition. Six of these companies participated as SERs.

The Panel and SERs discussed several regulatory flexibility alternatives for small businesses that certify vehicles subject to the proposed Tier 3 emission standards. As described in Appendix A of the Panel Report, EPA sought comment from the SERs on allowing small entities to skip the Tier 3 phase-

in and instead implement Tier 3 requirements for all of their vehicles following the phase-in period. In addition, EPA sought comment on the following flexibilities: (1) A hardship relief provision that would allow these businesses to apply for additional time to meet the requirements, (2) use of assigned deterioration factors for certification purposes, and (3) reduction in the number of tests required in the manufacturer in-use verification testing program. SERs were generally supportive of these flexibility provisions. However, one SER requested that EPA consider providing relaxed standards for exhaust emissions in addition to the delay, and another SER requested that we consider eliminating some of the evaporative emissions testing requirements.

The recommendations made by the Panel on these approaches are discussed in detail in Section XII.C of the NPRM. We consequently proposed small business and small volume manufacturer provisions based on these recommendations, as summarized in Section IV.G above. These proposed provisions consisted of additional lead time, reduced testing requirements, and opportunities for hardship relief, that would help small entities to leverage technological developments by others and to spread the availability of needed engineering, supplier, and capital resources. Based on the comments we subsequently received during the public comment period, we have improved on the proposed provisions and are finalizing Tier 3 vehicle provisions for small businesses and SVMs as described in detail in Section IV.G above, consisting of:

- An alternative NMOG+NO<sub>x</sub> light-duty fleet average standard phase-in schedule for small businesses and SVMs: 125 mg/mi for MYs 2017–2021, 51 mg/mi for MYs 2022–2027, and 30 mg/mi thereafter;
- An optional delay of Tier 3 requirements until MY 2022 for small businesses and SVMs;
- EPA-assigned deterioration factors for small businesses and SVMs (as well as for small volume test groups);
- Reduced in-use testing requirements for SVMs with annual sales under 15,000, including no required testing for those with annual sales under 5,000;
- A PM testing waiver for small businesses and SVMs;
- An allowance for small alternative fuel vehicle converters to meet existing OBD requirements (40 CFR 86.1806–05) instead of new Tier 3 requirements;
- A provision for small businesses and SVMs in hardship situations to

apply for additional time to meet the Tier 3 standards;

- An extension of eligibility for the Tier 3 SVM provisions to small manufacturers that are owned by large manufacturers but are able to demonstrate that they are operationally independent.

As required by section 212 of SBREFA, EPA also is preparing a Small Entity Compliance Guide to help small entities comply with this rule. The Small Entity Compliance Guide will be available on EPA's Office of Policy's Small Entity Web site at: <http://www.epa.gov/rfa/compliance-guides.html>, and on the Tier 3 Web site (<http://www.epa.gov/otaq/tier3.htm>) 60 days after publication of the final rule in the **Federal Register**.

#### *D. Unfunded Mandates Reform Act*

Title II of the Unfunded Mandates Reform Act of 1995 (UMRA), 2 U.S.C. 1531–1538, requires Federal agencies, unless otherwise prohibited by law, to assess the effects of their regulatory actions on State, local, and tribal governments and the private sector. This rule contains a Federal mandate that may result in expenditures of \$100 million or more for State, local, and tribal governments, in the aggregate, or the private sector in any one year. Accordingly, EPA has prepared under section 202 of the UMRA a written statement of the cost-benefit analysis, which can be found in Section VIII of this preamble, and in Chapter 8 of the RIA.

Consistent with section 205, EPA has identified and considered a reasonable number of regulatory alternatives. These alternatives are described above in Sections IV, V, and IX of this preamble.

This rule is not subject to the requirements of section 203 of UMRA because it contains no regulatory requirements that might significantly or uniquely affect small governments. The rule imposes no enforceable duty on any State, local or tribal governments. EPA has determined that this rule contains no regulatory requirements that might significantly or uniquely affect small governments. EPA has determined that this rule contains a Federal mandate that may result in expenditures of \$100 million or more for the private sector in any one year, however EPA believes that the program being finalized today represents the least costly, and least burdensome approach to achieve the statutory requirements of the rule. The costs and benefits associated with this rule are discussed above in Section VIII of this preamble, and in Chapter 8 of the RIA, as required by section 202 of the UMRA.

#### *E. Executive Order 13132: Federalism*

This action does not have federalism implications. It will not have substantial direct effects on the States, on the relationship between the national government and the States, or on the distribution of power and responsibilities among the various levels of government, as specified in Executive Order 13132. Thus, Executive Order 13132 does not apply to this action. Although Executive Order 13132 does not apply to this rule, EPA did consult with representatives of various State and local governments in developing the rule. EPA also consulted with representatives from the National Association of Clean Air Agencies (NACAA, representing state and local air pollution officials), Northeast States for Coordinated Air Use Management (NESCAUM, the Clean Air Association of the Northeast States), and the Ozone Transport Commission (OTC, a multi-state organization created under the CAA responsible for advising EPA on transport issues and for developing and implementing regional solutions to the ground-level ozone problem in the Northeast and Mid-Atlantic regions).

In the spirit of Executive Order 13132, and consistent with EPA policy to promote communications between EPA and State and local governments, EPA specifically solicited comment on the proposed action from State and local officials. These comments are in the rulemaking docket and are summarized in the Summary and Analysis of Comments document.

#### *F. Executive Order 13175: Consultation and Coordination With Indian Tribal Governments*

This action does not have tribal implications, as specified in Executive Order 13175 (65 FR 67249, November 9, 2000). This rule will be implemented at the Federal level and will impose compliance costs only on those in the gasoline production, distribution, and additive industry and in the engine and vehicle manufacturing industries. Tribal governments will be affected only to the extent they purchase and use regulated fuels, vehicles, and equipment. Thus, Executive Order 13175 does not apply to this action.

Although Executive Order 13175 does not apply to this action, EPA specifically solicited additional comment from tribal officials in developing this action (however we did not receive any comments).

#### *G. Executive Order 13045: Protection of Children From Environmental Health Risks and Safety Risks*

This action is subject to EO 13045 (62 FR 19885, April 23, 1997) because it is an economically significant regulatory action as defined by EO 12866, and EPA believes that the environmental health or safety risk addressed by this action may have a disproportionate effect on children. Accordingly, we have evaluated the environmental health or safety effects of air pollutants affected by the Tier 3 program on children. The results of this evaluation are contained in Section II.B and associated references.

Children are more susceptible than adults to many air pollutants because of differences in physiology, higher per body weight breathing rates and consumption, rapid development of the brain and bodily systems, and behaviors that increase chances for exposure. Even before birth, the developing fetus may be exposed to air pollutants through the mother that affect development and permanently harm the individual.

Infants and children breathe at much higher rates per body weight than adults, with infants under one year of age having a breathing rate up to five times that of adults.<sup>603</sup> In addition, children breathe through their mouths more than adults and their nasal passages are less effective at removing pollutants, which leads to a higher deposition fraction in their lungs.<sup>604</sup>

Certain motor vehicle emissions present greater risks to children as well. Early lifestages (e.g., children) are thought to be more susceptible to tumor development than adults when exposed to carcinogenic chemicals that act through a mutagenic mode of action.<sup>605</sup> Exposure at a young age to these carcinogens could lead to a higher risk of developing cancer later in life.

The adverse effects of individual air pollutants may be more severe for children, particularly the youngest age groups, than adults. The Integrated Science Assessments and Criteria

<sup>603</sup> U.S. Environmental Protection Agency. (2009). Metabolically-derived ventilation rates: a revised approach based upon oxygen consumption rates. Washington, DC: Office of Research and Development. EPA/600/R-06/129F. <http://cfpub.epa.gov/ncea/cfm/recordisplay.cfm?deid=202543>.

<sup>604</sup> Foos, B.; Marty, M.; Schwartz, J.; Bennet, W.; Moya, J.; Jarabek, A.M.; Salmon, A.G. (2008) Focusing on children's inhalation dosimetry and health effects for risk assessment: an introduction. *J Toxicol Environ Health* 71A: 149–165.

<sup>605</sup> U.S. Environmental Protection Agency. (2005). Supplemental guidance for assessing susceptibility from early-life exposure to carcinogens. Washington, DC: Risk Assessment Forum. EPA/630/R-03/003F. [http://www.epa.gov/raf/publications/pdfs/childrens\\_supplement\\_final.pdf](http://www.epa.gov/raf/publications/pdfs/childrens_supplement_final.pdf).



Documents for a number of pollutants affected by this rule, including those for NO<sub>2</sub>, SO<sub>2</sub>, PM, ozone and CO, describe children as a group with greater susceptibility. Section II.B.6 discusses a number of childhood health outcomes associated with proximity to roadways, including evidence for exacerbation of asthma symptoms and suggestive evidence for new onset asthma. In general, these studies do not identify the specific contaminants associated with adverse effects, instead addressing the near-roadway environment as one containing numerous exposures potentially associated with adverse health effects.

There is substantial evidence that people who live or attend school near major roadways are more likely to be of a minority race, Hispanic ethnicity, and/or low SES. Within these highly exposed groups, children's exposure and susceptibility to health effects is greater than adults due to school-related and seasonal activities, behavior, and physiological factors.

Section III.C describes the ambient air quality changes resulting from the proposed standards, which represent levels to which the general population is exposed. Children are not expected to experience greater ambient concentrations of air pollutants than the general population. However, because of their greater susceptibility to air pollution and their increased time spent outdoors, it is likely that the proposed standards would have particular benefits for children's health.

#### *H. Executive Order 13211: Actions Concerning Regulations That Significantly Affect Energy Supply, Distribution, or Use*

Executive Order 13211, "Actions Concerning Regulations That Significantly Affect Energy Supply, Distribution, or Use" (66 FR 28355 (May 22, 2001)), requires EPA to prepare and submit a Statement of Energy Effects to the Administrator of the Office of Information and Regulatory Affairs, Office of Management and Budget, for certain actions identified as "significant energy actions." Section 4(b) of Executive Order 13211 defines "significant energy actions" as "any action by an agency (normally published in the **Federal Register**) that promulgates or is expected to lead to the promulgation of a final rule or regulation, including notices of inquiry, advance notices of proposed rulemaking, and notices of proposed

rulemaking: (1)(i) That is a significant regulatory action under Executive Order 12866 or any successor order, and (ii) is likely to have a significant adverse effect on the supply, distribution, or use of energy; or (2) that is designated by the Administrator of the Office of Information and Regulatory Affairs as a significant energy action." Given the flexibilities being finalized for entities in the gasoline production and distribution system, we believe that these mitigate any potential adverse effects on gasoline supply and distribution. Although EPA does not expect this rule to have significant adverse effects on the supply or distribution of gasoline, we have prepared a Statement of Energy Effects for this action as follows.

This rule's potential effects on energy supply, distribution, or use have been analyzed and are further discussed above in:

- Section V—fuel provisions of the rule and flexibilities, including hardship provisions.
- Section VII.B—estimated costs of the fuel program.
- Section X—economic impacts (specifically, Section X.C for fuel economic impacts, and Section X.D on employment impacts).

Given the estimated costs and impacts of the Tier 3 program, as discussed in this preamble and in the RIA, we do not expect this rule to have an adverse effect on the supply or distribution of gasoline. This judgment is based on a comparison of the estimated impacts of the Tier 3 program to those required for the Tier 2 program, and a review of gasoline supply during the phase-in of the Tier 2 gasoline sulfur program from 2003 through 2011. As the Tier 2 program reduced gasoline sulfur from levels as high as 450 ppm to a 30 ppm annual average, significant capital investments were required of many refineries to meet the 30 ppm sulfur standard. Both during and at the end of the Tier 2 phase-in, the U.S. gasoline markets did not experience a loss in gasoline supply as refiners utilized the flexibilities offered by the Tier 2 program to stagger investments and unit turnarounds/shutdowns to limit supply impacts. As discussed further in Chapter 5 of the RIA, we do not believe that the Tier 3 program will significantly affect U.S. gasoline supply and/or distribution. Comments received on the proposal estimating the impacts of an even more stringent program than Tier 3 support this conclusion.<sup>606</sup>

Further, we do not believe that there are any reasonable alternatives to the control of sulfur in gasoline which would provide the level of reduction of emissions, considering our cost-benefit analyses, given by the sulfur reduction being finalized in this rule.

#### *I. National Technology Transfer and Advancement Act*

Section 12(d) of the National Technology Transfer and Advancement Act of 1995 ("NTTAA"), Public Law 104-113 (15 U.S.C. 272 note) directs EPA to use voluntary consensus standards in its regulatory activities unless to do so would be inconsistent with applicable law or otherwise impractical. Voluntary consensus standards are technical standards (e.g., materials specifications, test methods, sampling procedures, and business practices) that are developed or adopted by voluntary consensus standards bodies. NTTAA directs EPA to provide Congress, through OMB, explanations when the Agency decides not to use available and applicable voluntary consensus standards.

This rulemaking involves technical standards. EPA has decided to update a number of regulations which already contain voluntary consensus standards to more recent versions of these standards. EPA is finalizing use of the ASTM International (ASTM) standards listed in Table XII-1 below. The standards may be obtained through the ASTM Web site ([www.astm.org](http://www.astm.org)) or by calling ASTM at (610) 832-9585.

This rulemaking also involves environmental monitoring or measurement. Consistent with the Agency's Performance Based Measurement System ("PBMS"), EPA has decided not to require the use of specific, prescribed analytic methods. Rather, the rule will allow the use of any method that meets the prescribed performance criteria. The PBMS approach is intended to be more flexible and cost-effective for the regulated community; it is also intended to encourage innovation in analytical technology and improved data quality. EPA is not precluding the use of any method, whether it constitutes a voluntary consensus standard or not, as long as it meets the performance criteria specified. Comments received on this approach are discussed in Section VI and in the Summary and Analysis of Comments document.

<sup>606</sup> EPA-HQ-OAR-2011-0135-4276; Attachment 7.

TABLE XII-1—DESIGNATED ANALYTICAL TEST METHODS FOR GASOLINE AND DIESEL FUEL

Fuel parameter	Designated analytical method
Sulfur in gasoline .....	ASTM D2622-10.
Sulfur in butane .....	ASTM D6667-10.
500 ppm Sulfur Diesel Fuel .....	ASTM D2622-10.
Olefins in gasoline .....	ASTM D1319-13.
Reid vapor pressure (RVP) in gasoline .....	ASTM D5191-12, with the following correlation equation: RVP psi = (0.956 * X) - 0.347 RVP kPa = (0.956 * X) - 2.39 where: X = total measured vapor pressure in psi or kPa.
Distillation in gasoline .....	ASTM D86-12.
Benzene in gasoline .....	ASTM D3606-10, except that instrument parameters shall be adjusted to ensure complete resolution of benzene, ethanol, and methanol peaks.
Aromatics in gasoline .....	ASTM D5769-10, except that sample chilling requirements in section 8 of this standard are optional.
Oxygen and oxygenate content in gasoline .....	ASTM D5599-00 (2010).
Aromatics in diesel fuel .....	ASTM D1319-13.

*J. Executive Order 12898: Federal Actions To Address Environmental Justice in Minority Populations and Low-Income Populations*

Executive Order (EO) 12898 (59 FR 7629 (Feb. 16, 1994)) establishes federal executive policy on environmental justice. Its main provision directs federal agencies, to the greatest extent practicable and permitted by law, to make environmental justice part of their mission by identifying and addressing, as appropriate, disproportionately high and adverse human health or environmental effects of their programs, policies, and activities on minority populations and low-income populations in the United States.

EPA has determined that this final rule will not have disproportionately high and adverse human health or environmental effects on minority or low-income populations because it increases the level of environmental protection for all affected populations without having any disproportionately high and adverse human health or environmental effects on any population, including any minority or low-income population.

This final rule will reduce emissions from vehicles across the nation, both new vehicles (beginning in model year 2017, when the vehicle standards start to apply) and existing vehicles (as soon as the lower-sulfur gasoline becomes available in 2017). As a result, this rule increases the level of environmental protection for all populations. As discussed in Section III.C.7, there is evidence that minority populations and low-income populations live disproportionately near high-traffic roadways, where concentrations of many air pollutants are elevated. We expect this final rule to increase the

level of environmental protection for these populations.

Thus, this final rule will not have a disproportionately high adverse human health or environmental effect on minority or low-income populations.

*K. Congressional Review Act*

The Congressional Review Act, 5 U.S.C. 801 et seq., as added by the Small Business Regulatory Enforcement Fairness Act of 1996, generally provides that before a rule may take effect, the agency promulgating the rule must submit a rule report, which includes a copy of the rule, to each House of the Congress and to the Comptroller General of the United States. EPA will submit a report containing this rule and other required information to the U.S. Senate, the U.S. House of Representatives, and the Comptroller General of the United States prior to publication of the rule in the **Federal Register**. A major rule cannot take effect until 60 days after it is published in the **Federal Register**. This action is a "major rule" as defined by 5 U.S.C. 804(2). This rule will be effective on June 27, 2014.

**XIII. Statutory Provisions and Legal Authority**

Statutory authority for this action comes from sections 202, 203-209, 211, 213, 216, and 301 of the Clean Air Act, 42 U.S.C. sections 7414, 7521, 7522-7525, 7541, 7542, 7543, 7545, 7547, 7550, and 7601. Additional support for the procedural and compliance related aspects of this proposal, including the proposed recordkeeping requirements, comes from sections 114, 208, and 301(a) of the Clean Air Act, 42 U.S.C. sections 7414, 7542, and 7601(a).

**List of Subjects**

*40 CFR Part 79*

Environmental protection, Administrative practice and procedure, Air pollution control, Confidential business information, Diesel fuel, Energy, Fuel additives, Gasoline, Motor vehicle pollution, Penalties, Petroleum, Reporting and recordkeeping requirements.

*40 CFR Part 80*

Environmental protection, Administrative practice and procedure, Air pollution control, Confidential Business Information, Diesel fuel, Fuel additives, Gasoline, Imports, Incorporation by reference, Labeling, Motor vehicle pollution, Penalties, Petroleum, Reporting and recordkeeping requirements.

*40 CFR Part 85*

Environmental protection, Administrative practice and procedure, Air pollution control, Confidential Business Information, Imports, Labeling, Motor vehicle pollution, Reporting and recordkeeping requirements, Research, Warranties.

*40 CFR Part 86*

Environmental protection, Administrative practice and procedure, Air pollution control, Confidential Business Information, Imports, Incorporation by reference, Labeling, Motor vehicle pollution, Reporting and recordkeeping requirements, Warranties.

*40 CFR Part 600*

Administrative practice and procedure, Electric power, Fuel economy, Incorporation by reference, Labeling, Reporting and recordkeeping requirements.

40 CFR Parts 1036 and 1037

Administrative practice and procedure, Air pollution control, Confidential business information, Environmental protection, Labeling, Motor vehicle pollution, Reporting and recordkeeping requirements, Warranties.

40 CFR Part 1039

Environmental protection, Administrative practice and procedure, Air pollution control, Confidential business information, Imports, Labeling, Penalties, Reporting and recordkeeping requirements, Warranties.

40 CFR Part 1042

Environmental protection, Administrative practice and procedure, Air pollution control, Confidential business information, Imports, Labeling, Penalties, Vessels, Reporting and recordkeeping requirements, Warranties.

40 CFR Part 1048

Environmental protection, Administrative practice and procedure,

Air pollution control, Confidential business information, Imports, Labeling, Penalties, Reporting and recordkeeping requirements, Warranties.

40 CFR Part 1054

Environmental protection, Administrative practice and procedure, Air pollution control, Confidential business information, Imports, Labeling, Penalties, Reporting and recordkeeping requirements, Warranties.

40 CFR Parts 1065 and 1066

Environmental protection, Administrative practice and procedure, Incorporation by reference, Reporting and recordkeeping requirements, Research.

Dated: March 3, 2014

Gina McCarthy, Administrator.

For the reasons set forth in the preamble, title 40, chapter I of the Code of Federal Regulations is amended as follows:

PART 79—REGISTRATION OF FUEL AND FUEL ADDITIVES

1. The authority citation for part 79 continues to read as follows:

Authority: 42 U.S.C. 7414, 7524, 7545, and 7601.

2. Section 79.5 is amended by revising paragraphs (a) and (b) introductory text to read as follows:

§ 79.5 Periodic reporting requirements.

(a) Fuel manufacturers. (1) For each calendar quarter (January through March, April through June, July through September, October through December) commencing after the date prescribed for a particular fuel in subpart D of this part, fuel manufacturers shall submit to the Administrator a report for each registered fuel showing the range of concentration of each additive reported under § 79.11(a) and the volume of such fuel produced in the quarter. Reports shall be submitted by the required deadline as shown in the following table:

TABLE 1 TO § 79.5—QUARTERLY REPORTING DEADLINES

Table with 3 columns: Calendar quarter, Time period covered, and Quarterly report deadline. Rows include Quarter 1 (Jan-Mar), Quarter 2 (Apr-Jun), Quarter 3 (Jul-Sep), and Quarter 4 (Oct-Dec).

(2) Fuel manufacturers shall submit to the Administrator a report annually for each registered fuel providing additional data and information as specified in §§ 79.32(c) and (d) and 79.33(c) and (d) in the designation of the fuel in subpart D of this part. Reports shall be submitted by March 31 for the preceding year, or part thereof, on forms supplied by the Administrator upon request. If the date prescribed for a particular fuel in subpart D of this part, or the later registration of a fuel is between October 1 and December 31, no report will be required for the period to the end of that year.

(b) Additive manufacturers. Additive manufacturers shall submit to the Administrator a report annually for each registered additive providing additional data and information as specified in § 79.31(c) and (d) in the designation of the additive in subpart D of this part. Additive manufacturers shall also report annually the volume of each additive produced. Reports shall be submitted by March 31 for the preceding year, or part thereof, on forms supplied by the Administrator upon request. If the date

prescribed for a particular additive in subpart D of this part, or the later registration of an additive is between October 1 and December 31, no report will be required for the period to the end of that year. These periodic reports shall not, however, be required for any additive that is:

\* \* \* \* \*

PART 80—REGULATION OF FUEL AND FUEL ADDITIVES

3. The authority citation for part 80 continues to read as follows:

Authority: 42 U.S.C. 7414, 7521(l), 7545, and 7601(a).

Subpart A—[Amended]

- 4. Section 80.2 is amended by:
a. Revising the introductory text and paragraphs (d), (w), (z), and (fff).
b. Adding paragraphs (vvv), (www), (xxx), (yyy), (zzz), (aaaa), (bbbb), (cccc), (dddd), (eeee), (fff), (gggg), (hhhh), (iiii), and (kkkk).
c. Adding and reserving paragraph (jjjj).

§ 80.2 Definitions.

Definitions apply in this part as described in this section.

\* \* \* \* \*

(d) Previously certified gasoline, or PCG, means conventional gasoline, reformulated gasoline, RBOB, or CBOB that previously has been included in a batch for purposes of complying with the standards of 40 CFR part 80 that apply to refiners and importers.

\* \* \* \* \*

(w) Cetane index or "Calculated cetane index" is a number representing the ignition properties of diesel fuel oils from API gravity and mid-boiling point, as determined by ASTM D976.

\* \* \* \* \*

(z) Aromatic content of diesel fuel is the aromatic hydrocarbon content in volume percent as follows:

(1) Through December 31, 2015, determine aromatic content of diesel fuel by ASTM D1319.

(2) Beginning January 1, 2016, determine aromatic content of diesel fuel by a test method approved under § 80.47.

\* \* \* \* \*

(fff) #1D means the distillate fuel classification relating to “No. 1–D” diesel fuels as described in ASTM D975.

\* \* \* \* \*

(vvv) *Denatured fuel ethanol (DFE)* means an alcohol of the chemical formula  $C_2H_6O$  which contains a denaturant to make it unfit for human consumption, that is produced or imported for use in motor gasoline, and that meets the requirements of § 80.1610.

(www) *Oxygenate producer* means any person who owns, leases, operates, controls, or supervises an oxygenate production facility.

(xxx) *Oxygenate production facility* means any facility where oxygenate including DFE designated as transportation fuel is produced.

(yyy) *Oxygenate importer* means a person who imports oxygenate from a foreign country into the United States (including the Commonwealth of Puerto Rico, the Virgin Islands, Guam, American Samoa, and the Northern Mariana Islands).

(zzz) *Oxygenate import facility* means any facility where oxygenate including DFE designated as transportation fuel is imported into the United States.

(aaaa) *CBOB* means gasoline blendstock that could become conventional gasoline solely upon the addition of oxygenate.

(bbbb) *Natural gas liquids (NGL)* means the components of natural gas (primarily propane, butane, pentane, hexane, and heptane) that are separated from the gas state in the form of liquids in facilities such as a natural gas production facility, a gas processing plant, a natural gas pipeline, or a refinery or similar facility. The higher temperature boiling components of NGL are sometimes referred to as “natural gasoline”.

(cccc) *Natural gas* means a mixture of hydrocarbon gases that occurs with petroleum deposits, principally methane together with varying quantities of ethane, propane, butane, and other gases.

(dddd) *Butane blender* means a refiner or refinery that produces gasoline by blending butane that meets the quality specifications in § 80.82 with conventional gasoline, CBOB, reformulated gasoline, or RBOB, and that uses the streamlined provisions in § 80.82 to meet some of the applicable sampling and testing requirements.

(eeee) *Pentane blender* means a refiner or refinery that produces gasoline by blending pentane that meets the quality specifications in § 80.86 with conventional gasoline, CBOB, reformulated gasoline, or RBOB, and

that uses the streamlined provisions in § 80.85 to meet some of the applicable sampling and testing requirements.

(ffff) *Blender-commercial grade pentane* means pentane that meets the requirements in § 80.86(a)(3) for pentane for use by a pentane blender pursuant to the requirements of § 80.85.

(gggg) *Blender-non-commercial grade pentane* means pentane that meets the requirements in § 80.86(a)(4) for pentane for use by a pentane blender pursuant to the requirements of § 80.85.

(hhhh) *Blender-grade pentane* means pentane that meets the requirements for commercial grade pentane or non-commercial grade pentane pursuant to the requirements of § 80.86.

(iiii) *Ethanol denaturant* means previously certified gasoline (including previously certified blendstocks for oxygenate blending), gasoline blendstocks, or natural gasoline liquids that are added to neat (un-denatured) ethanol to make it unfit for human consumption in accordance with the requirements of the Alcohol and Tobacco Tax and Trade Bureau of the U.S. Treasury Department.

(jjjj) [Reserved]

(kkkk) *Materials incorporated by reference*. The published materials identified in this section are incorporated by reference into this section with the approval of the Director of the Federal Register under 5 U.S.C. 552(a) and 1 CFR part 51. To enforce any edition other than that specified in this section, a document must be published in the **Federal Register** and the material must be available to the public. All approved materials are available for inspection at the Air and Radiation Docket and Information Center (Air Docket) in the EPA Docket Center (EPA/DC) at Rm. 3334, EPA West Bldg., 1301 Constitution Ave. NW., Washington, DC. The EPA/DC Public Reading Room hours of operation are 8:30 a.m. to 4:30 p.m., Monday through Friday, excluding legal holidays. The telephone number of the EPA/DC Public Reading Room is (202) 566–1744, and the telephone number for the Air Docket is (202) 566–1742. These approved materials are also available for inspection at the National Archives and Records Administration (NARA). For information on the availability of this material at NARA, call (202) 741–6030 or go to [http://www.archives.gov/federal\\_register/code\\_of\\_federal\\_regulations/ibr\\_locations.html](http://www.archives.gov/federal_register/code_of_federal_regulations/ibr_locations.html). In addition, these materials are available from the sources listed below.

(1) *ASTM International material*. The following standards are available from ASTM International, 100 Barr Harbor Dr., P.O. Box C700, West

Conshohocken, PA 19428–2959, (877) 909–ASTM, or <http://www.astm.org>:

(i) ASTM D975–13a, Standard Specification for Diesel Fuel Oils, approved December 1, 2013.

(ii) ASTM D976–06 (Reapproved 2011), Standard Test Method for Calculated Cetane Index of Distillate Fuels, approved October 1, 2011.

(iii) ASTM D1319–13, Standard Test Method for Hydrocarbon Types in Liquid Petroleum Products by Fluorescent Indicator Adsorption, approved May 1, 2013.

(2) [Reserved]

■ 5. Section 80.8 is revised to read as follows:

**§ 80.8 Sampling methods for gasoline, diesel fuel, fuel additives, and renewable fuels.**

The sampling methods specified in this section shall be used to collect samples of gasoline, diesel fuel, blendstocks, fuel additives and renewable fuels for purposes of determining compliance with the requirements of this part.

(a) *Manual sampling*. Manual sampling of tanks and pipelines shall be performed according to the applicable procedures specified in ASTM D4057.

(b) *Automatic sampling*. Automatic sampling of petroleum products in pipelines shall be performed according to the applicable procedures specified in ASTM D4177.

(c) *Sampling and sample handling for volatility measurement*. Samples to be analyzed for Reid Vapor Pressure (RVP) shall be collected and handled according to the applicable procedures specified in ASTM D5842.

(d) *Sample compositing*. Composite samples shall be prepared using the applicable procedures specified in ASTM D5854.

(e) *Materials incorporated by reference*. The published materials identified in this section are incorporated by reference into this section with the approval of the Director of the Federal Register under 5 U.S.C. 552(a) and 1 CFR part 51. To enforce any edition other than that specified in this section, a document must be published in the **Federal Register** and the material must be available to the public. All approved materials are available for inspection at the Air and Radiation Docket and Information Center (Air Docket) in the EPA Docket Center (EPA/DC) at Rm. 3334, EPA West Bldg., 1301 Constitution Ave. NW., Washington, DC. The EPA/DC Public Reading Room hours of operation are 8:30 a.m. to 4:30 p.m., Monday through Friday, excluding legal holidays. The telephone number of the EPA/DC Public

Reading Room is (202) 566-1744, and the telephone number for the Air Docket is (202) 566-1742. These approved materials are also available for inspection at the National Archives and Records Administration (NARA). For information on the availability of this material at NARA, call (202) 741-6030 or go to [http://www.archives.gov/federal-register/code-of-federal-regulations/ibr\\_locations.html](http://www.archives.gov/federal-register/code-of-federal-regulations/ibr_locations.html). In addition, these materials are available from the sources listed below.

(1) *ASTM International material*. The following standards are available from ASTM International, 100 Barr Harbor Dr., P.O. Box C700, West Conshohocken, PA 19428-2959, (877) 909-ASTM, or <http://www.astm.org>:

(i) ASTM D4057-12, Standard Practice for Manual Sampling of Petroleum and Petroleum Products, approved December 1, 2012.

(ii) ASTM D4177-95 (Reapproved 2010), Standard Practice for Automatic Sampling of Petroleum and Petroleum Products, approved May 1, 2010.

(iii) ASTM D5842-04 (Reapproved 2009), Standard Practice for Sampling and Handling of Fuels for Volatility Measurement, approved July 1, 2009.

(iv) ASTM D5854-96 (Reapproved 2010), Standard Practice for Mixing and Handling of Liquid Samples of Petroleum and Petroleum Products, approved May 1, 2010.

(2) [Reserved]

#### Subpart D—[Amended]

■ 6. Section 80.46 is amended by revising the section heading and paragraphs (a), (b), (c), (d), (e), (f)(1), (f)(3), (g), and (h) to read as follows:

#### § 80.46 Measurement of reformulated gasoline and conventional gasoline fuel parameters.

(a) *Sulfur*. Sulfur content of gasoline and butane must be determined by use of the following methods:

(1) Through December 31, 2015, the sulfur content of gasoline must be determined by ASTM D2622 or by one of the alternative test methods specified in paragraph (a)(3) of this section. Beginning January 1, 2016, the sulfur content of gasoline must be determined by a test method approved under § 80.47.

(2) Through December 31, 2015, the sulfur content of butane must be determined by ASTM D6667 or by one of the alternative test methods specified in paragraph (a)(4) of this section.

(3) Through December 31, 2015, any refiner or importer may use ASTM D3120, ASTM D5453, ASTM D6920, or ASTM D7039 for determining the sulfur

content of gasoline provided the refiner or importer test result is correlated with the method specified in paragraph (a)(1) of this section:

(4) Beginning January 1, 2016, the sulfur content of butane must be determined by a test method approved under § 80.47. Through December 31, 2015, any refiner or importer may determine the sulfur content of butane using ASTM D4468 or ASTM D3246; provided the refiner or importer test result is correlated with the method specified in paragraph (a)(2) of this section.

(b) *Olefins*. Olefin content must be determined by use of the following methods:

(1) Through December 31, 2015, olefin content must be determined using ASTM D1319. Beginning January 1, 2016, the olefin content of gasoline may be determined by a test method approved under § 80.47.

(2) Through December 31, 2015, any refiner or importer may determine olefin content using ASTM D6550 for purposes of meeting any testing requirements involving olefin content, provided that the refiner or importer test result is correlated with the method specified in paragraph (b)(1) of this section on a site-specific basis, in order to achieve an unbiased prediction of the result in volume percent, for the method specified in paragraph (b)(1) of this section.

(c) *Reid Vapor Pressure (RVP)*. (1) Through December 31, 2015, Reid Vapor Pressure must be determined using ASTM D5191, except the following correction equation must be used:

$$\begin{aligned} \text{RVP psi} &= (0.956 * X) - 0.347 \\ \text{RVP kPa} &= (0.956 * X) - 2.39 \end{aligned}$$

Where:

X = Total measured vapor pressure, in psi or kPa.

(2) Beginning January 1, 2016, RVP may be determined by a test method approved under § 80.47, except as provided in paragraph (c)(2)(i) of this section.

(i) For reporting purposes, the RVP test result computed from § 80.47 must continue to utilize the RVP correction equation in paragraph (c)(1) of this section.

(ii) [Reserved]

(d) *Distillation*. Through December 31, 2015, distillation parameters must be determined using ASTM D86. Beginning January 1, 2016, the distillation parameters may be determined by a test method approved under § 80.47.

(e) *Benzene*. Through December 31, 2015, benzene content must be determined using ASTM D3606, except that instrument parameters shall be

adjusted to ensure complete resolution of the benzene, ethanol and methanol peaks because ethanol and methanol may cause interference with ASTM D3606 when present. Beginning January 1, 2016, the benzene content may be determined by a test method approved under § 80.47.

(f)(1) Through December 31, 2015, aromatic content must be determined using ASTM D5769, except the sample chilling requirements in section 8 of this standard method are optional. Beginning January 1, 2016, the aromatic content may be determined by a test method approved under § 80.47.

(3) Through December 31, 2015, any refiner or importer may determine aromatics content using ASTM D1319 for the purposes of meeting any test requirement involving aromatic content; provided that the refiner or importer test result is correlated with the method specified in paragraph (f)(1) of this section.

(g) *Oxygen and oxygenate content analysis*. (1) Through December 31, 2015, oxygen and oxygenate content must be determined using ASTM D5599. Beginning January 1, 2016, oxygen and oxygenate content may be determined by a test method approved under § 80.47.

(2) Through December 31, 2015, when oxygenates present are limited to MTBE, ETBE, TAME, DIPE, tertiary-amyl alcohol and C1 to C4 alcohols, any refiner, importer, or oxygenate blender may determine oxygen and oxygen content using ASTM D4815 for purposes of meeting any testing requirement; provided that the refiner or importer test result is correlated with the method specified in paragraph (g)(1) of this section.

(h) *Materials incorporated by reference*. The published materials identified in this section are incorporated by reference into this section with the approval of the Director of the Federal Register under 5 U.S.C. 552(a) and 1 CFR part 51. To enforce any edition other than that specified in this section, a document must be published in the **Federal Register** and the material must be available to the public. All approved materials are available for inspection at the Air and Radiation Docket and Information Center (Air Docket) in the EPA Docket Center (EPA/DC) at Rm. 3334, EPA West Bldg., 1301 Constitution Ave. NW., Washington, DC. The EPA/DC Public Reading Room hours of operation are 8:30 a.m. to 4:30 p.m., Monday through Friday, excluding legal holidays. The

telephone number of the EPA/DC Public Reading Room is (202) 566-1744, and the telephone number for the Air Docket is (202) 566-1742. These approved materials are also available for inspection at the National Archives and Records Administration (NARA). For information on the availability of this material at NARA, call (202) 741-6030 or go to [http://www.archives.gov/federal-register/code\\_of\\_federal\\_regulations/ibr\\_locations.html](http://www.archives.gov/federal-register/code_of_federal_regulations/ibr_locations.html). In addition, these materials are available from the sources listed below.

(1) *ASTM International material*. The following standards are available from ASTM International, 100 Barr Harbor Dr., P.O. Box C700, West Conshohocken, PA 19428-2959, (877) 909-ASTM, or <http://www.astm.org>:

(i) ASTM D86-12, Standard Test Method for Distillation of Petroleum Products at Atmospheric Pressure, approved December 1, 2012.

(ii) ASTM D1319-13, Standard Test Method for Hydrocarbon Types in Liquid Petroleum Products by Fluorescent Indicator Adsorption, approved May 1, 2013.

(iii) ASTM D2622-10, Standard Test Method for Sulfur in Petroleum Products by Wavelength Dispersive X-ray Fluorescence Spectrometry, approved February 15, 2010.

(iv) ASTM D3120-08, Standard Test Method for Trace Quantities of Sulfur in Light Liquid Petroleum Hydrocarbons by Oxidative Microcoulometry, approved December 15, 2008.

(v) ASTM D3246-11, Standard Test Method for Sulfur in Petroleum Gas by Oxidative Microcoulometry, approved June 1, 2011.

(vi) ASTM D3606-10, Standard Test Method for Determination of Benzene and Toluene in Finished Motor and Aviation Gasoline by Gas Chromatography, approved October 1, 2010.

(vii) ASTM D4468-85 (Reapproved 2011), Standard Test Method for Total Sulfur in Gaseous Fuels by Hydrogenolysis and Rateometric Colorimetry, approved November 1, 2011.

(viii) ASTM D4815-13, Standard Test Method for Determination of MTBE, ETBE, TAME, DIPE, tertiary-Amyl Alcohol and C<sub>1</sub> to C<sub>4</sub> Alcohols in Gasoline by Gas Chromatography, approved October 1, 2013.

(ix) ASTM D5191-13, Standard Test Method for Vapor Pressure of Petroleum Products (Mini Method), approved December 1, 2013.

(x) ASTM D5453-12, Standard Test Method for Determination of Total Sulfur in Light Hydrocarbons, Spark Ignition Engine Fuel, Diesel Engine

Fuel, and Engine Oil by Ultraviolet Fluorescence, approved November 1, 2012.

(xi) ASTM D5599-00 (Reapproved 2010), Standard Test Method for Determination of Oxygenates in Gasoline by Gas Chromatography and Oxygen Selective Flame Ionization Detection, approved October 1, 2010.

(xii) ASTM D5769-10, Standard Test Method for Determination of Benzene, Toluene, and Total Aromatics in Finished Gasolines by Gas Chromatography/Mass Spectrometry, approved May 1, 2010.

(xiii) ASTM D6550-10, Standard Test Method for Determination of Olefin Content of Gasolines by Supercritical-Fluid Chromatography, approved October 1, 2010.

(xiv) ASTM D6667-10, Standard Test Method for Determination of Total Volatile Sulfur in Gaseous Hydrocarbons and Liquefied Petroleum Gases by Ultraviolet Fluorescence, approved October 1, 2010.

(xv) ASTM D6920-13, Standard Test Method for Total Sulfur in Naphthas, Distillates, Reformulated Gasolines, Diesels, Biodiesels, and Motor Fuels by Oxidative Combustion and Electrochemical Detection, approved September 15, 2013.

(xvi) ASTM D7039-13, Standard Test Method for Sulfur in Gasoline, Diesel Fuel, Jet Fuel, Kerosine, Biodiesel, Biodiesel Blends, and Gasoline-Ethanol Blends by Monochromatic Wavelength Dispersive X-ray Fluorescence Spectrometry, approved September 15, 2013.

(2) [Reserved]

■ 7. Section 80.47 is added to read as follows:

**§ 80.47 Performance-based Analytical Test Method Approach.**

All sample handling, testing procedures, and tests must be conducted using good laboratory practices.

(a) *Definitions*. As used in this subpart D:

(1) *Performance-based Analytical Test Method Approach* means a measurement system based upon established performance criteria for accuracy and precision with use of analytical test methods. As used in this subpart, this is a measurement system used by laboratories to demonstrate that a particular analytical test method is acceptable for demonstrating compliance.

(2) *Accuracy* means the closeness of agreement between an observed value from a single test measurement and an accepted reference value.

(3) *Precision* means the degree of agreement in a set of measurements performed on the same property of identical test material.

(4) *Absolute fuel parameter* means a fuel parameter for which a gravimetric standard is practical to construct and use. Sulfur content of gasoline, butane, or diesel fuel are examples of an absolute fuel parameter.

(5) *Gravimetric standard* means a test material made by adding a carefully weighed quantity of the analyte to a measured quantity of another substance known not to contain any of the analyte, resulting in a solution with an accurately known concentrate of the analyte.

(6) *Consensus named fuels* are homogeneous quantities of fuel that have been analyzed by a number of different laboratories (by sending around small samples). The average concentration of some parameter of interest across all of the different laboratories is then used as the "consensus name" for that material.

(7) *Locally-named reference materials* are gasoline or diesel fuels that are usually from the regular production of the facility where they are used in laboratory quality control efforts and have been analyzed using the designated method (either by the facility's lab or by a referee lab) to obtain an estimate of their concentration.

(8) *Method-defined fuel parameter* means a fuel parameter for which an EPA-prescribed primary test method or designated method defines the regulatory standard. Examples of method-defined fuel parameters include olefin content in gasoline, Reid vapor pressure (RVP) of gasoline, distillation parameters of gasoline, benzene content of gasoline, aromatic content of gasoline and diesel fuel, and oxygen/oxygenates content of gasoline.

(9) *Reference installations* are designated test method installations that are used to qualify the accuracy of other method-defined parameter instruments. Reference installations of the designated test method will be used to evaluate the accuracy of other method-defined alternative test methods and to establish correlation equations if necessary.

(10) *Correlation equation* is a correction equation as determined by the use of ASTM D6708. This standard practice determines whether the comparison between the alternative test method and the designated test method is a null result. If the comparison is not null, then the standard practice provides for a correlation equation that predicts designated test method results

from the applicable method-defined alternative test method.

(11) *Statistical quality control (SQC)* means a planned system of activities whose purpose is to provide a level of quality that meets the needs of compliance with the standards of this part. This subpart prescribes specific SQC requirements for both absolute and method driven fuel parameters for both voluntary and non-voluntary consensus-based standards bodies.

(12) *Voluntary consensus-based standards body (VCSB)* means a domestic or international organization that plans, develops, establishes, or coordinates voluntary consensus standards using agreed-upon procedures and which possesses the attributes of openness, balance of interest, due process, and consensus, as explained in OMB Circular A-119 and the National Technology Transfer and Advancement Act of 1995, P.L. 104-113, sec. 12(d).

(13) *Non-voluntary consensus-based standards body (non-VCSB)* means a domestic or international regulated party that has developed a proprietary analytical test method that has not been adopted by a VCSB organization.

(b) *Precision and accuracy criteria for approval for the absolute fuel parameter of gasoline sulfur.* (1) *Precision.* Beginning January 1, 2016, for motor vehicle gasoline, gasoline blendstock, and gasoline fuel additives subject to the gasoline sulfur standard at §§ 80.195 and § 80.1603, the maximum allowable standard deviation computed from the results of a minimum of 20 tests made over 20 days (seven or fewer tests per week and two or fewer tests per day) on samples using good laboratory practices taken from a single homogeneous commercially available gasoline must be less than or equal to 1.5 times the repeatability “r” divided by 2.77, where “r” equals the ASTM repeatability of ASTM D7039 (Example: A 10 ppm sulfur gasoline sample: Maximum allowable standard deviation of 20 tests  $\leq 1.5 * (1.75 \text{ ppm} / 2.77) = 0.95 \text{ ppm}$ ). The 20 results must be a series of tests with a sequential record of analysis and no emissions. A laboratory facility may exclude a given sample or test result only if the exclusion is for a valid reason under good laboratory practices and it maintains records regarding the sample and test results and the reason for excluding them.

(2) *Accuracy.* Beginning January 1, 2016, for motor vehicle gasoline, gasoline blendstock, and gasoline fuel additives subject to the gasoline sulfur standard at §§ 80.195 and 80.1603:

(i) The arithmetic average of a continuous series of at least 10 tests performed using good laboratory

practices on a commercially available gravimetric sulfur standard in the range of 1–10 ppm shall not differ from the accepted reference value (ARV) of the standard by more than 0.71 ppm sulfur;

(ii) The arithmetic average of a continuous series of at least 10 tests performed using good laboratory practices on a commercially available gravimetric sulfur standard in the range of 10–20 ppm shall not differ from the ARV of the standard by more than 1.00 ppm sulfur; and

(iii) In applying the tests of paragraphs (b)(2)(i) and (ii) of this section, individual test results shall be compensated for any known chemical interferences using good laboratory practices.

(3) The test method specified at § 80.46(a)(1) and in use prior to October 28, 2013 is exempt from the requirements of paragraphs (b)(1) and (2) of this section.

(c) *Precision and accuracy criteria for approval of the absolute fuel parameter of sulfur in butane.* (1) *Precision.*

Beginning January 1, 2016, for butane subject to the butane sulfur standard at §§ 80.82, 80.195, 80.340(b) and 80.1603, the maximum allowable standard deviation computed from the results of a minimum of 20 tests made over 20 days (tests into no fewer than five batches or fewer tests each, with only one such batch allowed per day over the minimum of 20 days) on samples using good laboratory practices taken from a single homogeneous commercially available butane must be less than or equal to 1.5 times the repeatability (r) divided by 2.77, where “r” equals the ASTM repeatability of ASTM D6667 (Example: A 80 ppm sulfur butane sample: Maximum allowable standard deviation of 20 tests  $\leq 1.5 * (9.22 \text{ ppm} / 2.77) = 4.99 \text{ ppm}$ ). The 20 results must be a series of tests with a sequential record of analysis and no emissions. A laboratory facility may exclude a given sample or test result only if the exclusion is for a valid reason under good laboratory practices and it maintains records regarding the sample and test results and the reason for excluding them.

(2) *Accuracy.* Beginning January 1, 2016, for butane subject to the butane sulfur standard at §§ 80.82, 80.195, 80.340(b) and 80.1603—

(i) The arithmetic average of a continuous series of at least 10 tests performed using good laboratory practices on a commercially available gravimetric sulfur standard in the range of 70–80 ppm, say 75 ppm, shall not differ from the accepted reference value (ARV) of the standard by more than 4.68 ppm sulfur;

(ii) The arithmetic average of a continuous series of at least 10 tests performed using good laboratory practices on a commercially available gravimetric sulfur standard in the range of 80–90 ppm, say 85 ppm, shall not differ from the accepted reference value (ARV) of the standard by more than 5.31 ppm sulfur; and

(iii) In applying the tests of paragraphs (c)(2)(i) and (ii) of this section, individual test results shall be compensated for any known chemical interferences using good laboratory practices.

(3) The test method specified at § 80.46(a)(2) and in use prior to October 28, 2013 is exempt from the requirements of paragraphs (c)(1) and (2) of this section.

(d) *Precision criteria for approval of the method defined fuel parameter of olefins in gasoline.* (1) *Precision.* Beginning January 1, 2016, for motor vehicle gasoline, gasoline blendstock, and gasoline fuel additives subject to the gasoline standards of this part, the maximum allowable standard deviation computed from the results of a minimum of 20 tests made over 20 days (tests may be arranged into no fewer than five batches or fewer tests each, with only one such batch allowed per day over the minimum of 20 days) on samples using good laboratory practices taken from a single homogeneous commercially available gasoline must be less than or equal to 0.3 times the reproducibility (R), where “R” equals the ASTM reproducibility of ASTM D1319 (Example: A gasoline containing 9 Vol% olefins: maximum allowable standard deviation of 20 tests  $\leq 0.3 * (3.06 \text{ Vol}%) = 0.92 \text{ Vol}%$ ). The 20 results must be a series of tests with a sequential record of analysis and no emissions. A laboratory facility may exclude a given sample or test result only if the exclusion is for a valid reason under good laboratory practices and it maintains records regarding the sample and test results and the reason for excluding them.

(2) The test method specified at § 80.46(b)(1) and in use prior to October 28, 2013 is exempt from the requirements of paragraph (d)(1) of this section.

(e) *Precision criteria for approval of the method defined fuel parameter of aromatics in gasoline.* (1) *Precision.* Beginning January 1, 2016, for motor vehicle gasoline, gasoline blendstock, and gasoline fuel additives subject to the gasoline standards of this part, the maximum allowable standard deviation computed from the results of a minimum of 20 tests made over 20 days (tests may be arranged into no fewer



than five batches or fewer tests each, with only one such batch allowed per day over the minimum of 20 days) on samples using good laboratory practices taken from a single homogeneous commercially available gasoline must be less than or equal to 0.3 times the reproducibility (R), where "R" equals the ASTM reproducibility of ASTM D1319 (Example: A gasoline containing 32Vol% aromatics: maximum allowable standard deviation of 20 tests  $\leq 0.3 * (3.7 \text{ Vol}\%) = 1.11 \text{ Vol}\%$ ). The 20 results must be a series of tests with a sequential record of analysis and no emissions. A laboratory facility may exclude a given sample or test result only if the exclusion is for a valid reason under good laboratory practices and it maintains records regarding the sample and test results and the reason for excluding them.

(2) The test method specified at § 80.46(f)(1) and in use prior to October 28, 2013 is exempt from the requirements of paragraph (e)(1) of this section.

(f) *Precision criteria for approval of the method defined fuel parameter of oxygen and oxygenate content in gasoline.* (1) *Precision.* Beginning January 1, 2016, for motor vehicle gasoline, gasoline blendstock, and gasoline fuel additives subject to the gasoline standards of this part, the maximum allowable standard deviation computed from the results of a minimum of 20 tests made over 20 days (tests may be arranged into no fewer than five batches or fewer tests each, with only one such batch allowed per day over the minimum of 20 days) on samples using good laboratory practices taken from a single homogeneous commercially available gasoline must be less than or equal to 0.3 times the reproducibility (R), where "R" equals the ASTM reproducibility of ASTM D5599 (Example: A gasoline containing 3Mass% total oxygen: maximum allowable standard deviation of 20 tests  $\leq 0.3 * (0.32 \text{ Mass}\%) = 0.10 \text{ Mass}\%$ ). The 20 results must be a series of tests with a sequential record of analysis and no emissions. A laboratory facility may exclude a given sample or test result only if the exclusion is for a valid reason under good laboratory practices and it maintains records regarding the sample and test results and the reason for excluding them.

(2) The test method specified at § 80.46(g)(1) and in use prior to October 28, 2013 is exempt from the requirements of paragraph (f)(1) of this section.

(g) *Precision criteria for approval of the method defined fuel parameter of Reid Vapor Pressure (RVP) in gasoline.*

(1) *Precision.* Beginning January 1, 2016, for motor vehicle gasoline, gasoline blendstock, and gasoline fuel additives subject to the gasoline standards of this part and volatility standards at § 80.27, the maximum allowable standard deviation computed from the results of a minimum of 20 tests made over 20 days (tests may be arranged into no fewer than five batches or fewer tests each, with only one such batch allowed per day over the minimum of 20 days) on samples using good laboratory practices taken from a single homogeneous commercially available gasoline must be less than or equal to 0.3 times the reproducibility (R), where "R" equals the ASTM reproducibility of ASTM D5191 (Example: A gasoline having a RVP of 6.8psi: Maximum allowable standard deviation of 20 tests  $\leq 0.3 * (0.40 \text{ psi}) = 0.12 \text{ psi}$ ). The 20 results must be a series of tests with a sequential record of analysis and no emissions. A laboratory facility may exclude a given sample or test result only if the exclusion is for a valid reason under good laboratory practices and it maintains records regarding the sample and test results and the reason for excluding them.

(2) The test method specified at § 80.46(c)(1) and in use prior to October 28, 2013 is exempt from the requirements of paragraph (g)(1) of this section.

(h) *Precision criteria for approval of the method defined fuel parameter of gasoline distillation.* (1) *Precision.* Beginning January 1, 2016, for motor vehicle gasoline, gasoline blendstock, and gasoline fuel additives subject to the gasoline standards of this part, the maximum allowable standard deviation computed from the results of a minimum of 20 tests made over 20 days (tests may be arranged into no fewer than five batches or fewer tests each, with only one such batch allowed per day over the minimum of 20 days) on samples using good laboratory practices taken from a single homogeneous commercially available gasoline must be less than or equal to 0.3 times the reproducibility (R), where "R" equals the ASTM reproducibility of ASTM D86 for the initial boiling point, E10, E50, E90 and final boiling point. (Example: A gasoline having an initial boiling point of 26 °C and a final boiling point of 215 °C: maximum allowable standard deviation of 20 tests for initial boiling point  $\leq 0.3 * (8.5 \text{ °C}) = 2.55 \text{ °C}$ , maximum allowable standard deviation of 20 tests for E10  $\leq 0.3 * (3.0 + 2.64 * Sc) \text{ °C}$ , maximum allowable standard deviation of 20 tests for E50  $\leq 0.3 * (2.9 + 3.97 * Sc) \text{ °C}$ , maximum allowable standard deviation of 20 tests for E90t

$\leq 0.3 * (2.0 + 2.53 * Sc) \text{ °C}$ , and maximum allowable standard deviation of 20 tests for final boiling point  $\leq 0.3 * (10.5 \text{ °C}) = 3.15 \text{ °C}$ ), where Sc is the average slope (or rate of change) of the gasoline distillation curve as calculated in accordance with section 13.5 of ASTM D86. The 20 results must be a series of tests with a sequential record of analysis and no emissions. A laboratory facility may exclude a given sample or test result only if the exclusion is for a valid reason under good laboratory practices and it maintains records regarding the sample and test results and the reason for excluding them.

(2) The test method specified at § 80.46(d)(1) and in use prior to October 28, 2013 is exempt from the requirements of paragraph (h)(1) of this section.

(i) *Precision criteria for approval of the method defined fuel parameter of benzene in gasoline.* (1) *Precision.* Beginning January 1, 2016, for motor vehicle gasoline, gasoline blendstock, and gasoline fuel additives subject to the gasoline standards of this part and MSAT2 standards at §§ 80.41, 80.101, 80.1230, the maximum allowable standard deviation computed from the results of a minimum of 20 tests made over 20 days (tests may be arranged into no fewer than five batches or fewer tests each, with only one such batch allowed per day over the minimum of 20 days) on samples using good laboratory practices taken from a single homogeneous commercially available gasoline must be less than or equal to 0.3 times the reproducibility (R), where "R" equals the ASTM reproducibility of ASTM D3606 (Example: A gasoline having a 1Vol% benzene: Maximum allowable standard deviation of 20 tests  $\leq 0.3 * (0.18 \text{ Vol}\%) = 0.054 \text{ Vol}\%$ ). The 20 results must be a series of tests with a sequential record of analysis and no emissions. A laboratory facility may exclude a given sample or test result only if the exclusion is for a valid reason under good laboratory practices and it maintains records regarding the sample and test results and the reason for excluding them.

(2) The test method specified at § 80.46(e)(1) and in use prior to October 28, 2013 is exempt from the requirements of paragraph (i)(1) of this section.

(j) *Precision criteria for approval of the method defined fuel parameter of aromatics in diesel.* (1) *Precision.* Beginning January 1, 2016, for motor vehicle gasoline, gasoline blendstock, and gasoline fuel additives subject to the motor vehicle diesel standards at § 80.520, the maximum allowable standard deviation computed from the

results of a minimum of 20 tests made over 20 days (tests may be arranged into no fewer than five batches or fewer tests each, with only one such batch allowed per day over the minimum of 20 days) on samples using good laboratory practices taken from a single homogeneous commercially available gasoline must be less than or equal to 0.3 times the reproducibility (R), where "R" equals the ASTM reproducibility of ASTM D1319 (Example: A diesel fuel containing 35 Vol% aromatics: maximum allowable standard deviation of 20 tests  $\leq 0.3 \times (3.7 \text{ Vol}\%) = 1.11 \text{ Vol}\%$ ). The 20 results must be a series of tests with a sequential record of analysis and no emissions. A laboratory facility may exclude a given sample or test result only if the exclusion is for a valid reason under good laboratory practices and it maintains records regarding the sample and test results and the reason for excluding them.

(2) The test method specified at § 80.2(z) and in use prior to October 28, 2013 is exempt from the requirements of paragraph (j)(1) of this section.

(k) *Criteria for designated test method reference installations used to qualify the accuracy of other method-defined parameter instruments.* (1) Beginning January 1, 2016, for a single laboratory test facility qualifying a method defined alternative test method, the reference installation of the method-defined fuel parameter for the applicable designated test method must have precision equal to 0.3 times the reproducibility (R) of the method-defined fuel parameter's designated test method, where "R" is the reproducibility of the designated test method.

(i) For olefins in gasoline, see paragraph (d)(1) of this section.

(ii) For aromatics in gasoline, see paragraph (e)(1) of this section.

(iii) For oxygen and oxygenate content of gasoline, see paragraph (f)(1) of this section.

(iv) For Reid Vapor Pressure (RVP) of gasoline, see paragraph (g)(1) of this section.

(v) For gasoline distillation, see paragraph (h)(1) of this section.

(vi) For benzene in gasoline, see paragraph (i)(1) of this section.

(vii) For aromatics in diesel fuel, see paragraph (j)(1) of this section.

(2) The reference installation of the method-defined fuel parameter for the applicable designated test method must be shown to stay within the middle 50% of the distribution of an industry or commercially available monthly inter-laboratory crosscheck program for 3 out of 5 successive exchanges for at least a period of five months using good laboratory practices. Specifically,

compute the difference between the instrument's average measurement of the fuel closest to the applicable fuel standard (or to the average value for the fuel parameter in the complex model) and the mean for that fuel obtained by all of the non-outlier labs in the monthly inter-laboratory crosscheck program. Standardize this difference by expressing it in standard deviation units. These standardized inter-laboratory crosscheck differences should be placed in a moving average with a minimum span of five months. The instrument's moving average in standard deviation units cannot be outside the central 50% of the distribution of all laboratories that participated in the inter-laboratory crosscheck program.

(3) The reference installation of the method-defined fuel parameter for the applicable designated test method must be shown to be in statistical quality control as specified in ASTM D6299 for a minimum period of five months using good laboratory practices. The system is still considered to be in statistical quality control and the five month time period will not re-start if—

(i) Regular maintenance and/or re-calibration conducted during the five months in SQC qualification time period is considered as part of in-control normal operation, and/or;

(ii) If an assignable cause for 'out of control' is found, mitigated, and the system is brought back in statistical quality control during the five month time period that the reference installation is attempting to meet the five month in-statistical-control requirement, the five month time period does not re-start and the system is still considered to be 'in-control'.

(4) For a voluntary consensus standards body, such as ASTM, or for a commercially available industry crosscheck program, the summary statistics (mean and standard error = standard deviation/square root [number of results]) from the VCSB or commercially available inter-laboratory cross-check program (ILCP) data may be used as is without imposing the reference installations requirements of this section, provided that the number of non-outlying results is greater than 16 for both the designated and alternative test methods. The determination of ARV of check standards as specified in ASTM D6299, clause 6.2.2.1 and Note 7 shall be followed for the inter-laboratory crosscheck program. The use of VCSB or commercially available ILCP data as described above is deemed suitable for an ASTM D6708 assessment of VCSB alternative test methods.

(1) *Qualification criteria for Voluntary Consensus Standard Based (VCSB) Method-Defined Parameter Test Methods.* (1) Beginning January 1, 2016, include full test method documentation by the Voluntary Consensus Standard Based (VCSB) organization, including a description of the technology and/or instrumentation that makes the method functional.

(2) Include information reported in the test method that demonstrates the test method meets the applicable precision information for the method-defined fuel parameter as described in this section.

(3) Include information reported in the test method that demonstrates the test method has been evaluated using ASTM D6708 and whether the comparison is a "null" result or whether a correlation equation needs to be applied that predicts designated test method results from the applicable method-defined alternative test method.

(4) The test methods specified at §§ 80.2(w) and 80.46(a)(1), (a)(2), (b)(1), (c)(1), (d)(1), (e)(1), (f)(1), and (g)(1) and in use prior to October 28, 2013 are exempt from the requirements of paragraphs (l)(1) through (3) of this section.

(m) *Qualification criteria for Non-Voluntary Consensus Standard Based (non-VCSB) Method-Defined Parameter Test Methods.* For a non-VCSB method to be approved, the following information must be submitted to the Administrator by each test facility for each method that it wishes to have approved.

(1) Beginning January 1, 2016, full and thorough test method documentation, including a description of the technology and/or instrumentation that makes the method functional so a person lacking experience with the test instrument would be able to replicate its results.

(2) Information reported in the test method that demonstrates the test method meets the applicable precision information using good laboratory practices for the method-defined fuel parameter as described in this section.

(3) Both the candidate method-defined Non-VCSB test method and its respective designated test method must be tested on a range of consensus named fuels or locally-named reference materials that are typical of those analyzed by the facility in practice using good laboratory practices and must meet the data requirements for variability as required in ASTM D6708.

(4) The facility using the candidate method-defined non-VCSB test method must statistically establish through application of ASTM D6708 that the

candidate method measures the same aspect of samples as applicable to its respective designated test method using good laboratory practices.

(5) If the use of ASTM D6708 reveals that the candidate method-defined non-VCSB test method has sample-specific biases due to matrix effects that cannot be determined as random the method is disqualified. If however, it is determined that the candidate method-defined non-VCSB test method can be qualified on a narrow circumscribed range of fuels while still meeting the data requirements for variability as required in ASTM D6708 (see paragraph (m)(3) of this section), then the types of fuels on which the qualification was achieved and for which the method is to be approved must be specified in the candidate method-defined non-VCSB test method description. If there is any restriction on the scope of fuels for which the candidate method-defined non-VCSB test method is to be qualified, the applicant must include a discussion of how the facility plans to screen sample for conformity to the scope. If the candidate method-defined test method is found to have minimal matrix effects, a statement to this effect must be included by the applicant in its application.

(6) The candidate method-defined non-VCSB test method precision qualification must be conducted in the form of "cross-method reproducibility" (Rcm) of the candidate method and applicable designated test method as required in ASTM D6708, where the Rcm must be equal to or less than 70 percent of the published reproducibility of the applicable designated test method using good laboratory practices.

(7) The applicant of the candidate method-defined non-VCSB test method must demonstrate through the use of ASTM D6708 whether a correlation to applicable designated test method is necessary. If it is determined through the use of this practice that the candidate method-defined non-VCSB test method requires a correlation equation in order to predict designated test method results, then this correlation equation must be applied to the candidate instruments output to obtain measurement results for regulatory purposes using good laboratory practices.

(8) Any additional information requested by the Administrator and necessary to render a decision as to approval of the test method.

(9) Samples used for precision and accuracy determination must be retained for 90 days.

(10) Within 90 days of the receipt of materials required to be submitted

under paragraphs (m)(1) through (9) of this section, the Administrator shall determine whether the test method is approved under this section.

(11) If the Administrator denies approval of the test method, within 90 days of receipt of all materials required to be submitted in paragraphs (m)(1) through (9) of this section, the Administrator will notify the applicant of the reasons for not approving the method. If the Administrator does not notify the applicant within 90 days of receipt of the application, then the test method shall be deemed approved.

(12) The Administrator may revoke approval of a test method under this section for cause, including, but not limited to, a determination by the Administrator that the approved test method has proved to be inadequate in practice.

(13) An independent third-party scientific review and written report and verification of the information provided pursuant to paragraphs (m)(1) through (9) of this section. The report and verification shall be based upon a site visit and review of relevant documents and shall separately identify each item required by paragraphs (m)(1) through (9) of this section, describe how the independent third-party evaluated the accuracy of the information provided, state whether the independent third-party agrees with the information provided, and identify any exceptions between the independent third-party's findings and the information provided.

(i) The information required under this section must be conducted by an independent third party who is a professional chemist and statistician, or who is a chemical engineer, with the following qualifications:

(A) For a refiner, importer, oxygenate producer, and oxygenate blender, the independent third party must have at least a bachelor's degree in chemistry and statistics, or at least a bachelor's degree in chemical engineering, from an accredited college in the United States, or the independent third party must be a subject matter expert with equivalent knowledge and qualification, with professional work experience in the petroleum or oxygenate field, especially with a demonstrated good working knowledge of ASTM D6708 and ASTM D6299.

(B) [Reserved]

(ii) To be considered an independent third-party under this paragraph (m)(13):

(A) The third-party shall not be employed by the refiner, importer, oxygenate producer, or oxygenate blender, or any subsidiary or employee

of the refiner, import facility, oxygenate producing facility, or oxygenate blender.

(B) The third party shall be free from any interest in the refiner's, importer's, oxygenate producer's, or oxygenate blender's business.

(C) The refiner, importer, oxygenate producer, or oxygenate blender shall be free from any interest in the third-party's business.

(D) Use of a third-party that is debarred, suspended, or proposed for debarment pursuant to the Government-wide Debarment and Suspension regulations, 40 CFR part 32, or the Debarment, Suspension and Ineligibility provisions of the Federal Acquisition Regulations, 48 CFR part 9 subpart 9.4, shall be deemed in noncompliance with the requirements of this section.

(iii) The independent third-party shall retain all records pertaining to the verification required under this section for a period of five years from the date of creation and shall deliver such records to the Administrator upon request.

(iv) The independent third party must provide EPA documentation of his or her qualifications as described in this paragraph (m) as part of the scientific review.

(14) If the Administrator finds that an individual test facility has provided false or inaccurate information under this section, upon notice from the Administrator the approval shall be void ab initio.

(n) *Accuracy and Precision Statistical Quality Control (SQC) Requirements for the Absolute Fuel Parameters.*

Beginning January 1, 2016, a test shall not be considered a test using an approved test method unless the following quality control procedures are performed separately for each instrument used to make measurements:

(1) Every facility shall conduct tests on every instrument with a commercially available gravimetric reference material, or check standard as defined in the ASTM D6299 at least three times a year using good laboratory practices. The facility must pre-treat and assess results from the check standard testing after at least 15 testing occasions as described in section 8.2 of this standard practice. The facility must construct "MR" and "I" charts with control lines as described in section 8.4 and appropriate Annex sections of this standard practice. In circumstances where the absolute difference between the mean of multiple back-to-back tests of the standard reference material and the accepted reference value of the standard reference material is greater than 0.75 times the published reproducibility of the test method must

be investigated by the facility. Records of the standard reference materials measurements as well as any investigations into any exceedance of these criteria must be kept for a period of five years.

(2)(i) *Precision SQC*. Every facility shall conduct tests on every instrument with a quality control material as defined in paragraph 3.2.3 in ASTM D6299 either once per week or once per every 20 productions tests, whichever is more frequent. The facility must construct and maintain an "I" chart as described in section 7 and section A1.5.1 and a "MR" chart as described in section A1.5.2. Any violations of control limit(s) should be investigated by personnel of the facility and records kept for a period of five years.

(ii) *Validation of New QC Material*. When a test facility is making a transition from one batch of QC material to the next batch of QC material, the facility will either construct an "I" chart as described in section 7 and section A1.5.1 of ASTM D6299, or follow the "Q-Procedure" in Annex 1.9 of ASTM D6299. In following the Q-Procedure if the plot of results from the "old" and "new" QC materials on its respective chart shows no special-cause signals, then the result of the "new" QC material will be considered valid.

(iii) For test facilities opting to use the Q-procedure, the first run on the new QC batch should be validated by either an overlap in-control result of the old batch, or by a single execution of an accompanying standard reference material. The new QC material result would be considered validated if the single result of the standard reference material is within the established site precision (R') of the Accepted Reference Value of the standard reference material, as determined by ASTM D6792.

(iv) The expanded uncertainty of the accepted reference value of consensus named fuels shall have the following accuracy qualification criterion: Accuracy qualification criterion = square root  $[(0.75R)^2 + (0.75R)^2/L]$ , where L = the number of single results obtained from different labs used to calculate the consensus ARV.

(v) These records must be kept by the facility for a period of five years.

(o) *Accuracy and Precision Statistical Quality Control (SQC) Requirements for the Voluntary Consensus Standard Based (VCSB) Method-Defined Fuel Parameters*. Beginning January 1, 2016, a test shall not be considered a test using an approved test method unless the following quality control procedures are performed separately for each instrument used to make measurements:

(1) *Accuracy SQC*. Every facility shall conduct tests of every instrument with a commercially available check standard as defined in the ASTM D6299 at least three times a year using good laboratory practices. The check standard must be an ordinary fuel with levels of the fuel parameter of interest close to either the applicable regulatory standard or the average level of use for the facility. The Accepted Reference Value of the check standard must be determined by the respective designated test method for the fuel parameter following the guidelines of ASTM D6299. The facility must pre-treat and assess results from the check standard testing after at least 15 testing occasions as described in section 8.2 of this standard practice. The facility must construct "MR" and "I" charts with control lines as described in section 8.4 and appropriate Annex sections of this standard practice. In circumstances where the absolute difference between the mean of multiple back-to-back tests of the standard reference material and the accepted reference value of the standard reference material is greater than 0.75 times the published reproducibility of the test method must be investigated by the facility. Records of the standard reference materials measurements as well as any investigations into any exceedance of these criteria must be kept for a period of five years.

(2)(i) *Precision SQC*. Every facility shall conduct tests of every instrument with a quality control material as defined in paragraph 3.2.3 in ASTM D6299 either once per week or once per every 20 productions tests, whichever is more frequent. The facility must construct and maintain an "I" chart as described in section 7 and section A1.5.1 and a "MR" chart as described in section A1.5.2. Any violations of control limit(s) should be investigated by personnel of the facility and records kept for a period of five years.

(ii) *Validation of New QC Material*. When a test facility is making a transition from one batch of QC material to the next batch of QC material, the facility will either construct an "I" chart as described in section 7 and section A1.5.1 of ASTM D6299, or follow the "Q-Procedure" in Annex 1.9 of ASTM D6299. In following the Q-Procedure if the plot of results from the "old" and "new" QC materials on its respective chart shows no special-cause signals, then the result of the "new" QC material will be considered valid.

(iii) For test facilities opting to use the Q-procedure, the first run on the new QC batch should be validated by either an overlap in-control result of the old batch, or by a single execution of an

accompanying standard reference material. The new QC material result would be considered validated if the single result of the standard reference material is within the established site precision (R') of the Accepted Reference Value of the standard reference material, as determined by ASTM D6792.

(iv) The expanded uncertainty of the accepted reference value of consensus named fuels shall have the following accuracy qualification criterion: Accuracy qualification criterion = square root  $[(0.75R)^2 + (0.75R)^2/L]$ , where L = the number of single results obtained from different labs used to calculate the consensus ARV.

(v) These records must be kept by the facility for a period of five years.

(p) *Accuracy and Precision Statistical Quality Control (SQC) Requirements for the Non-Voluntary Consensus Standard Based (Non-VCSB) Method-Defined Fuel Parameters*. Beginning January 1, 2016, a test shall not be considered a test using an approved test method unless the following quality control procedures are performed separately for each instrument used to make measurements:

(1) *Accuracy SQC for Non-VCSB Method-Defined test methods with minimal matrix effects*. Every facility shall conduct tests on every instrument with a commercially available check standard as defined in the ASTM D6299 at least three times a year using good laboratory practices.. The check standard must be an ordinary fuel with levels of the fuel parameter of interest close to either the applicable regulatory standard or the average level of use for the facility. The Accepted Reference Value of the check standard must be determined by the respective designated test method for the fuel parameter following the guidelines of ASTM D6299. The facility must pre-treat and assess results from the check standard testing after at least 15 testing occasions as described in section 8.2 of this standard practice. The facility must construct "MR" and "I" charts with control lines as described in section 8.4 and appropriate Annex sections of this standard practice. In circumstances where the absolute difference between the mean of multiple back-to-back tests of the standard reference material and the accepted reference value of the standard reference material is greater than 0.75 times the published reproducibility of the test method must be investigated by the facility. Records of the standard reference materials measurements as well as any investigations into any exceedance of these criteria must be kept for a period of five years.

(2)(i) *Accuracy SQC for Non-VCSB Method-Defined test methods with high sensitivity to matrix effects.* Every facility shall conduct tests on every instrument with a production fuel on at least a quarterly basis using good laboratory practices. The production fuel must be representative of the production fuels that are routinely analyzed by the facility. The Accepted Reference Value of the production fuel must be determined by the respective reference installation of the designated test method for the fuel parameter following the guidelines of ASTM D6299. The facility must pre-treat and assess results from the check standard testing after at least 15 testing occasions as described in section 8.2 of this standard practice. The facility must construct “MR” and “I” charts with control lines as described in section 8.4 and appropriate Annex sections of this standard practice. In circumstances where the absolute difference between the mean of multiple back-to-back tests of the standard reference material and the accepted reference value of the standard reference material is greater than 0.75 times the published reproducibility of the test method must be investigated by the facility. Documentation on the identity of the reference installation and its control status must be maintained on the premises of the method-defined alternative test method. Records of the standard reference materials measurements as well as any investigations into any exceedances of this criterion must be kept for a period of five years.

(ii) Each facility is required to send every 20th production batch of gasoline or diesel fuel to EPA’s laboratory, along with the facility’s measurement result used to certify the batch using the respective method-defined non-VCSB test method. The EPA retains the right to return such sample on a blind basis for a required reanalysis on the respective method-defined non-VCSB test method within 180 days upon receipt of such sample.

(3)(i) *Precision SQC.* Every facility shall conduct tests on every instrument with a quality control material as defined in paragraph 3.2.3 in ASTM D6299 either once per week or once per every 20 productions tests, whichever is more frequent. The facility must construct and maintain an “I” chart as described in section 7 and section A1.5.1 and a “MR” chart as described in section A1.5.2. Any violations of control limit(s) should be investigated by personnel of the facility and records kept for a period of five years.

(ii) *Validation of New QC Material.* When a test facility is making a transition from one batch of QC material to the next batch of QC material, the facility will either construct an “I” chart as described in section 7 and section A1.5.1 of ASTM D6299, or follow the “Q-Procedure” in Annex 1.9 of ASTM D6299. In following the Q-Procedure if the plot of results from the “old” and “new” QC materials on its respective chart shows no special-cause signals, then the result of the “new” QC material will be considered valid.

(iii) For test facilities opting to use the Q-procedure, the first run on the new QC batch should be validated by either an overlap in-control result of the old batch, or by a single execution of an accompanying standard reference material. The new QC material result would be considered validated if the single result of the standard reference material is within the established site precision (R’) of the Accepted Reference Value of the standard reference material, as determined by ASTM D6792.

(iv) The expanded uncertainty of the accepted reference value of consensus named fuels shall have the following accuracy qualification criterion: Accuracy qualification criterion = square root  $[(0.75R)^2 + (0.75R)^2/L]$ , where L = the number of single results obtained from different labs used to calculate the consensus ARV.

(v) These records must be kept by the facility for a period of five years.

(q) *Record retention requirements for the test methods approved under this subpart.* Each individual test facility must retain records related to the establishment of accuracy and precision values, all test method documentation, and any statistical quality control testing and analysis under this section using good laboratory practices for a period of five years.

(r) *Materials incorporated by reference.* The published materials identified in this section are incorporated by reference into this section with the approval of the Director of the Federal Register under 5 U.S.C. 552(a) and 1 CFR part 51. To enforce any edition other than that specified in this section, a document must be published in the **Federal Register** and the material must be available to the public. All approved materials are available for inspection at the Air and Radiation Docket and Information Center (Air Docket) in the EPA Docket Center (EPA/DC) at Rm. 3334, EPA West Bldg., 1301 Constitution Ave. NW., Washington, DC. The EPA/DC Public Reading Room hours of operation are 8:30 a.m. to 4:30 p.m., Monday through Friday, excluding legal holidays. The

telephone number of the EPA/DC Public Reading Room is (202) 566–1744, and the telephone number for the Air Docket is (202) 566–1742. These approved materials are also available for inspection at the National Archives and Records Administration (NARA). For information on the availability of this material at NARA, call (202) 741–6030 or go to [http://www.archives.gov/federal-register/code\\_of\\_federal\\_regulations/ibr\\_locations.html](http://www.archives.gov/federal-register/code_of_federal_regulations/ibr_locations.html). In addition, these materials are available from the sources listed below.

(1) *ASTM International material.* The following standards are available from ASTM International, 100 Barr Harbor Dr., P.O. Box C700, West Conshohocken, PA 19428–2959, (877) 909–ASTM, or <http://www.astm.org>:

(i) ASTM D86–12, Standard Test Method for Distillation of Petroleum Products at Atmospheric Pressure, approved December 1, 2012.

(ii) ASTM D1319–13, Standard Test Method for Hydrocarbon Types in Liquid Petroleum Products by Fluorescent Indicator Adsorption, approved May 1, 2013.

(iii) ASTM D3606–10, Standard Test Method for Determination of Benzene and Toluene in Finished Motor and Aviation Gasoline by Gas Chromatography, approved October 1, 2010.

(iv) ASTM D5191–13, Standard Test Method for Vapor Pressure of Petroleum Products (Mini Method), approved December 1, 2013.

(v) ASTM D5599–00 (Reapproved 2010), Standard Test Method for Determination of Oxygenates in Gasoline by Gas Chromatography and Oxygen Selective Flame Ionization Detection, approved October 1, 2010.

(vi) ASTM D6299–13, Standard Practice for Applying Statistical Quality Assurance and Control Charting Techniques to Evaluate Analytical Measurement System Performance, approved October 1, 2013.

(vii) ASTM D6667–10, Standard Test Method for Determination of Total Volatile Sulfur in Gaseous Hydrocarbons and Liquefied Petroleum Gases by Ultraviolet Fluorescence, approved October 1, 2010.

(viii) ASTM D6708–13, Standard Practice for Statistical Assessment and Improvement of Expected Agreement Between Two Test Methods that Purport to Measure the Same Property of a Material, approved May 1, 2013.

(ix) ASTM D6792–13, Standard Practice for Quality System in Petroleum Products and Lubricants Testing Laboratories, approved May 15, 2013.

(x) ASTM D7039–13, Standard Test Method for Sulfur in Gasoline, Diesel Fuel, Jet Fuel, Kerosine, Biodiesel, Biodiesel Blends, and Gasoline-Ethanol Blends by Monochromatic Wavelength Dispersive X-ray Fluorescence Spectrometry, approved September 15, 2013, approved September 15, 2013.

(2) [Reserved]

- 8. Section 80.65 is amended by:
- a. Revising paragraph (d)(1).
- b. Removing and reserving paragraph (d)(2)(iv).
- c. Revising paragraph (d)(2)(v).
- d. Revising paragraph (d)(3).
- e. Revising paragraphs (e)(1) introductory text, (e)(1)(i), and (e)(2) introductory text.
- f. Adding paragraphs (e)(3) and (e)(4).
- g. Revising paragraphs (f)(1)(i) and (f)(3)(iii)(A).
- h. Adding a new paragraph (f)(5).
- i. Revising paragraph (i) introductory text.
- j. Revising paragraphs (i)(1)(ii) and (i)(1)(iii).
- k. Revising paragraphs (i)(4)(ii) introductory text and (i)(4)(ii)(A).
- l. Revising paragraph (i)(6)(i).

**§ 80.65 General requirements for refiners and importers.**

\* \* \* \* \*

(d) \* \* \*

(1) All gasoline produced or imported shall be properly designated as reformulated gasoline, conventional gasoline, RBOB, or CBOB.

(2) \* \* \*

(iv) [Reserved]

(v) For each of the following parameters, either gasoline or RBOB which meets the standard applicable to that parameter on a per-gallon basis or on average—

(A) Toxics emissions performance;

(B) NO<sub>x</sub> emissions performance in the case of gasoline certified using the complex model.

(C) Benzene content; and

(D) In the case of VOC-controlled gasoline or RBOB certified using the complex model, VOC emissions performance; and

\* \* \* \* \*

(3) Every batch of reformulated gasoline, conventional gasoline, RBOB, or CBOB produced or imported at each refinery or import facility shall be assigned a number (the “batch number”), consisting of the EPA-assigned refiner or importer registration number, the EPA facility registration number, the last two digits of the year in which the batch was produced, and a unique number for the batch, beginning with the number one for the first batch produced or imported each calendar year and each subsequent

batch during the calendar year being assigned the next sequential number (e.g., 4321–54321–95–000001, 4321–54321–95–000002, etc.).

(e) \* \* \*

(1) Except as provided in paragraphs (e)(3) and (4) of this section, each refiner or importer shall, for each batch of reformulated gasoline or RBOB produced or imported, determine the volume and the value of each of the properties specified in paragraph (e)(2)(i) of this section, except that the value for RVP must be determined only in the case of reformulated gasoline or RBOB that is VOC-controlled. These determinations shall—

(i) Be based on a representative sample of the reformulated gasoline or RBOB that is analyzed using the methodologies specified in § 80.46 through December 31, 2015, or, beginning January 1, 2016, in either § 80.46 or § 80.47;

\* \* \* \* \*

(2) In the event that the value of any of these properties is determined by the refiner or importer and by an independent laboratory in conformance with the requirements of paragraph (f) of this section—

\* \* \* \* \*

(3) Beginning January 1, 2013, API Gravity is not required to be measured or reported for the purpose of batch certification.

(4) For the purposes of meeting the requirements of this paragraph (e) for any winter fuel parameter except benzene, oxygenate, RVP and sulfur, any refiner or importer may, prior to analysis, combine samples of gasoline collected from more than one batch of gasoline or blendstock (“composite sample”), and treat such composite sample as one batch of gasoline or blendstock provided that the refiner or importer meets all the following requirements:

(i) Samples must be from a single reporting year, must be limited to non-VOC gasoline, and must be of a single grade of gasoline or of a single type of batch-produced blendstock.

(ii) Combines samples of gasoline that are produced or imported over a period no longer than one month. Blendstock samples of a single blendstock type obtained from continuous processes over a calendar month may be mixed together to form one blendstock sample and the sample subsequently analyzed for the required fuel parameters.

(iii)(A) Samples shall have been collected and stored using good laboratory practices in order to prevent change in product composition with regard to baseline properties and to

minimize loss of volatile fractions of the sample.

(B) Properties of the retained samples shall be adjusted for loss of butane or pentane by comparing the RVP measured immediately after blending with the RVP determined at the time that the supplemental properties are measured.

(C) The volume of each batch or shipment sampled, to the nearest gallon, shall have been noted and the sum of the volumes, in gallons, calculated.

(iv) For each batch or shipment sampled, the ratio of its volume to the total volume determined in paragraph (e)(4)(iii)(C) of this section shall be determined to three decimal places. This shall be the volumetric fraction of the shipment in the mixture.

(v) The total minimum volume required to perform duplicate analyses to obtain values of all of the required fuel parameters shall be determined.

(vi) The volumetric fraction determined in paragraph (e)(4)(iv) of this section for each batch or shipment shall be multiplied by the value determined in paragraph (e)(4)(v) of this section.

(vii) The resulting value determined in paragraph (e)(4)(vi) of this section for each batch or shipment shall be the volume of each batch or shipment’s sample to be added to the mixture. This volume shall be determined to the nearest milliliter.

(viii) The appropriate volumes of each shipment’s sample shall be thoroughly mixed and the solution analyzed per the methods required under § 80.46 or § 80.47, as applicable.

(ix) Uses the total of the volumes of the batches of gasoline that comprise the composite sample, and the results of the analyses of the composite sample, for purposes of compliance calculations under this paragraph (e).

(f) \* \* \*

(1) \* \* \*

(i) *Option 1.* The refiner or importer shall, for each batch of reformulated gasoline or RBOB that is produced or imported, have the value for each property specified in paragraph (e)(2)(i) of this section determined by an independent laboratory that collects and analyzes a representative sample from the batch using the methodologies specified in § 80.46 through December 31, 2015, and the methodologies specified in § 80.47 beginning January 1, 2016.

\* \* \* \* \*

(3) \* \* \*

(iii) \* \* \*

(A) For each compliance year beginning with the 2014 compliance

year, a single annual report for calendar year January through December may be submitted by the following March 31.

\* \* \* \* \*

(5) A refiner or importer may designate one alternate independent laboratory to perform testing required for compliance if all the following conditions are met:

(i) The alternate independent laboratory meets all provisions of this section for designated independent laboratories.

(ii) The alternate laboratory is used only when the designated independent laboratory per paragraph (f)(2) of this section is unavailable and cannot perform testing required for compliance, for example, when the primary designated laboratory is closed, the apparatus for certain test methods are down, or independent laboratory personnel are not available.

(iii) The alternate independent laboratory is not used to select a preferred test result.

\* \* \* \* \*

(i) *Exclusion of previously certified gasoline.* Any refiner who uses previously certified reformulated gasoline, conventional gasoline, RBOB, or CBOB to produce reformulated gasoline or RBOB must exclude the previously certified gasoline for purposes of demonstrating compliance with the standards under § 80.41. This exclusion must be accomplished by the refiner as follows:

(1) \* \* \*

(ii) In the case of previously certified reformulated gasoline or RBOB determine the emissions performances for toxics and NO<sub>x</sub>, except as provided in § 80.41(e) and (f), and VOC for VOC-controlled gasoline, and the designations for VOC control.

(iii) In the case of previously certified conventional gasoline or CBOB, determine the exhaust toxics and NO<sub>x</sub> emissions performances, except as provided in § 80.101(c)(3) and (4).

\* \* \* \* \*

(4) \* \* \*

(ii) Where a refiner uses previously certified conventional gasoline or CBOB to produce reformulated gasoline or RBOB—

(A) The refiner must include the volume and properties of any batch of previously certified conventional gasoline or CBOB as a negative batch in the refiner's anti-dumping compliance calculations under § 80.101(g) for the refinery, or where applicable, the refiner's aggregation under § 80.101(h); and

\* \* \* \* \*

(6)(i) Any refiner may use the procedures specified in this paragraph (i) to combine previously certified conventional gasoline or CBOB with reformulated gasoline or RBOB, to reclassify conventional gasoline or CBOB into reformulated gasoline or RBOB, or to change the designations of reformulated gasoline or RBOB with regard to VOC control.

\* \* \* \* \*

■ 9. Section 80.66 is amended by revising paragraph (f) to read as follows:

**§ 80.66 Calculation of reformulated gasoline properties.**

\* \* \* \* \*

(f) Per-gallon RVP shall be determined based upon the measurement of RVP of a representative sample of a batch of gasoline. The total RVP value associated with a batch of gasoline (in RVP-gallons) is calculated by multiplying the RVP times the volume.

\* \* \* \* \*

■ 10. Section 80.74 is amended by:

■ a. Revising the introductory text.

■ b. Revising paragraphs (a) introductory text and (a)(1).

■ c. Adding paragraphs (a)(3) and (a)(4).

■ d. Revising paragraph (b)(8).

**§ 80.74 Recordkeeping requirements.**

All parties in the gasoline distribution network and the distribution network for pentane for use by pentane blenders under § 80.86, shall maintain records containing the information as required in this section. These records shall be retained for a period of five years from the date of creation, and shall be delivered to the Administrator of EPA or to the Administrator's authorized representative upon request.

(a) *All regulated parties.* Any refiner, gasoline importer, oxygenate blender, producer of pentane for use by pentane blenders, importer of pentane for use by pentane blenders, carrier, distributor, reseller, retailer, or wholesale-purchaser-consumer who sells, offers for sale, dispenses, supplies, offers for supply, stores, blends, transports, or causes the transportation of any reformulated gasoline, RBOB, or pentane for use by pentane blenders shall maintain records containing the following information:

(1) The product transfer documentation for all reformulated gasoline, RBOB, or pentane for use by pentane blenders for which the party is the transferor or transferee; and

\* \* \* \* \*

(3) For producers and importers of pentane for use by pentane blenders, in addition to the records specified in paragraph (a)(1) of this section, records

demonstrating that each batch of such pentane is compliant with the standards in § 80.86.

(4) For records specified in paragraph (a)(1) of this section, records demonstrating compliance quality assurance program requirements in § 80.85.

(b) \* \* \*

(8) In the case of butane or pentane blended into reformulated gasoline or RBOB under § 80.82 or § 80.85, documentation of all the following:

(i) The volume of butane added.

(ii) The volume of the pentane added.

(iii) The volume of reformulated gasoline or RBOB both prior to and subsequent to the butane or pentane blending.

(iv) The purity and properties of the butane specified in § 80.82(c) and (d), as appropriate.

(v) The purity and properties of the pentane specified in § 80.85(c) and (d), as appropriate.

(vi) Compliance with the requirements of §§ 80.82 and 80.85; and

\* \* \* \* \*

■ 11. Section 80.75 is amended by:

■ a. Revising the introductory text.

■ b. Revising paragraph (a).

■ c. Removing and reserving paragraph (b).

■ d. Revising paragraph (c)(1) introductory text.

■ e. Revising paragraph (d).

■ f. Adding paragraph (e) introductory text and revising paragraph (e)(1).

■ g. Adding paragraph (g) introductory text.

■ h. Revising paragraph (h) introductory text.

■ i. Revising paragraph (i).

■ j. Removing and reserving paragraph (k).

■ k. Revising paragraph (l).

■ l. Revising paragraph (m).

■ m. Revising paragraph (o).

■ n. Adding paragraph (p).

**§ 80.75 Reporting requirements.**

Any refiner, gasoline importer, producer of pentane for use by a pentane blender, and importer of pentane for use by a pentane blender shall report as specified in this section, and shall report such other information as the Administrator may require.

(a) *Quarterly reports for reformulated gasoline.* Any refiner or importer that produces or imports any reformulated gasoline or RBOB shall submit quarterly reports to the Administrator for each refinery at which such reformulated gasoline or RBOB was produced and for all such reformulated gasoline or RBOB imported by each importer.



(1) The quarterly reports shall be for all such reformulated gasoline or RBOB produced or imported during the following time periods:

(i) The first quarterly report shall include information for reformulated gasoline or RBOB produced or imported from January 1 through March 31, and shall be submitted by June 1 of each year.

(ii) The second quarterly report shall include information for reformulated gasoline or RBOB produced or imported from April 1 through June 30, and shall be submitted by September 1 of each year.

(iii) The third quarterly report shall include information for reformulated gasoline or RBOB produced or imported from July 1 through September 30, and shall be submitted by December 1 of each year.

(iv) The fourth quarterly report shall include information for reformulated gasoline or RBOB produced or imported from October 1 through December 31, and shall be submitted by March 31 of each year.

(2) All the following information shall be included in each quarterly report for each batch of reformulated gasoline or RBOB which is included under paragraph (a)(1) of this section:

- (i) The batch number.
- (ii) The date of production.
- (iii) The volume of the batch.
- (iv) The grade of gasoline produced (i.e., premium, mid-grade, or regular).
- (v) For any refiner or importer, all the following:

- (A) Each designation of the gasoline, pursuant to § 80.65.
- (B) The properties, along with identification of the test method used to measure those properties, pursuant to §§ 80.65(e) and 80.66.

(vi) For any importer, the PADD in which the import facility is located.

(vii) [Reserved]

(viii) In the case of any previously certified gasoline used in a refinery operation under the terms of § 80.65(i), all the following information relative to the previously certified gasoline when received at the refinery:

- (A) Identification of the previously certified gasoline as such.
- (B) The batch number assigned by the receiving refinery.
- (C) The date of receipt.
- (D) The volume, properties (along with identification of the test method used to measure those properties), and designation of the batch.

(ix) In the case of butane blended with reformulated gasoline or RBOB under § 80.82, all the following:

(A) Identification of the butane batch as complying with the provisions of § 80.82.

(B) Identification of the butane batch as commercial or non-commercial grade butane.

(C) The batch number of the butane.

(D) The date of production of the gasoline produced using the butane batch.

(E) The volume of the butane batch.

(F) The properties of the butane batch specified by the butane supplier, or the properties specified in § 80.82(c) or (d), as appropriate, along with the identification of the test method used to measure those properties.

(G) The volume of the gasoline batch subsequent to the butane blending.

(x) In the case of any imported GTAB, identification of the gasoline as GTAB.

(xi) In the case of pentane blended with reformulated gasoline or RBOB under § 80.85, all the following:

(A) Identification of the pentane batch as complying with the provisions of § 80.85.

(B) Identification of the pentane batch as commercial or non-commercial grade pentane.

(C) The batch number of the pentane.

(D) The company and facility identification numbers of the supplier of the pentane batch.

(E) The date of production of the gasoline produced using the pentane batch.

(F) The volume of the pentane batch.

(G) The properties of the pentane batch specified by the pentane supplier, or the properties specified in § 80.82(c) or (d), as appropriate along with the test method used to measure these properties.

(H) The volume of the gasoline batch subsequent to the pentane blending.

(3) Information pertaining to gasoline produced or imported during 1994 shall be included in the first quarterly report in 1995.

(b) [Reserved]

(c) \* \* \*

(1) Any refiner or importer that produced or imported any reformulated gasoline or RBOB under the complex model that was to meet the VOC emissions performance standards on average (“averaged reformulated gasoline”) shall submit to the Administrator, with the third quarterly report, a report for each refinery or importer for such averaged reformulated gasoline produced or imported during the previous VOC averaging period. Beginning January 1, 2014, the information required by this paragraph (c) shall be submitted with the fourth quarter report pursuant to § 80.75(a)(1)(iv). This information shall be reported separately for the following categories:

\* \* \* \* \*

(d) *Benzene content averaging reports.* Pursuant to § 80.41(f)(3), for any refiner, refinery or importer not subject to the applicable standards at § 80.41(f)(1), the report required by this paragraph (d) is not required beginning January 1, 2014, or beginning January 1, 2016 for all other refiners.

(1) Any refiner or importer that produced or imported any reformulated gasoline or RBOB that was to meet the benzene content standards on average (“averaged reformulated gasoline”) shall submit to the Administrator, with the fourth quarterly report, a report for each refinery or importer for such averaged reformulated gasoline that was produced or imported during the previous toxics averaging period.

(2) All the following information shall be reported:

- (i) The volume of averaged reformulated gasoline or RBOB in gallons.
- (ii) The compliance total content of benzene.
- (iii) The actual total content of benzene, along with identification of the test methods used to measure the content of benzene.
- (iv) The number of benzene credits generated as a result of actual total benzene being less than compliance total benzene.
- (v) The number of benzene credits required as a result of actual total benzene being greater than compliance total benzene.
- (vi) The number of benzene credits transferred to another refinery or importer.
- (vii) The number of benzene credits obtained from another refinery or importer.

(e) *Toxics emissions performance averaging reports.* Pursuant to § 80.41(f)(3), for any refiner, refinery or importer not subject to the applicable standards at § 80.41(f)(1), the report required by this paragraph (e) is not required beginning January 1, 2014, or beginning January 1, 2016 for all other refiners.

(1) Any refiner or importer that produced or imported any reformulated gasoline or RBOB that was to meet the toxics emissions performance standards on average (“averaged reformulated gasoline”) shall submit to the Administrator, with the fourth quarterly report, a report for each refinery or importer for such averaged reformulated gasoline that was produced or imported during the previous toxics averaging period.

\* \* \* \* \*

(g) *NOx emissions performance averaging reports.* Pursuant to

§ 80.41(f)(2), for any refiner, refinery or importer not subject to the applicable standards at § 80.41(f)(1), the report required by this paragraph (g) is not required beginning January 1, 2014.

\* \* \* \* \*

(h) *Credit transfer reports.* As an additional part of the fourth quarterly report required by this section, any refiner or importer shall, for each refinery or importer, supply the following information for any benzene credits that are transferred from or to another refinery or importer:

\* \* \* \* \*

(i) *Covered areas of gasoline use report.* Any refiner that produced any reformulated gasoline that was to meet any reformulated gasoline standard on average ("averaged reformulated gasoline") shall, for each refinery at which such averaged reformulated gasoline was produced, submit to the Administrator, with the fourth quarterly report, a report that contains the identity of each covered area that was supplied with any averaged reformulated gasoline produced at each refinery during the previous year.

\* \* \* \* \*

(k) [Reserved]

(l) *Reports for per-gallon compliance gasoline.* In the case of reformulated gasoline or RBOB for which compliance with each of the standards set forth in § 80.41 is achieved on a per-gallon basis, the refiner or importer shall submit to the Administrator, by March 31 of each year, a report of the volume of each designated reformulated gasoline or RBOB produced or imported during the previous calendar year for which compliance is achieved on a per-gallon basis, and a statement that each gallon of this reformulated gasoline or RBOB met the applicable standards.

(m) *Reports of compliance audits.* Any refiner or importer shall submit the report of the compliance audit required by § 80.65(h) to the Administrator by June 1 of each year.

\* \* \* \* \*

(o) *Additional reporting requirements for refiners that blend butane or pentane with reformulated gasoline or RBOB.*

For refiners that blend any butane or pentane with reformulated gasoline or RBOB under § 80.82 or § 80.85, the refiner shall submit to the Administrator, by March 31 of each year, a report for the refinery which includes all the following information for the previous calendar year:

(1) The total volume of butane and the total volume of pentane blended with reformulated gasoline or RBOB at the refinery, separately for reformulated gasoline and RBOB.

(2) The total volume of reformulated gasoline or RBOB produced using butane and the total volume of reformulated gasoline or RBOB produced using pentane, separately for reformulated gasoline and RBOB.

(3) A statement that each gallon of reformulated gasoline or RBOB produced using butane or pentane met the applicable per-gallon standards under § 80.41.

(4) A statement that all butane and pentane blended with reformulated gasoline or RBOB at the refinery is included in the volume reported in paragraph (o)(2) of this section.

(p) *Reporting requirements for producers and importers of pentane for use by pentane blenders.* Any producer of pentane for use by pentane blenders, or importer of pentane for use by a pentane blender that produces or imports any pentane for use by a pentane blender pursuant to the requirements of § 80.86 shall submit annual reports to the Administrator for each facility at which pentane for use by pentane blenders was produced and for all such pentane imported by each importer.

(1) All the following information shall be included in each annual report for each batch of pentane for use by pentane blenders which is produced or imported from January 1 to December 31 of each year:

(i) The batch number.

(ii) The date of production.

(iii) The volume of the batch.

(iv) Whether the batch was produced to the standards for blender-commercial grade pentane pursuant to § 80.86(a)(3) or blender non-commercial grade pentane pursuant to § 80.86(a)(4).

(v) The properties, pursuant to the testing requirements of § 80.86(a)(3) or (a)(4) as applicable.

(vi) A statement that the batch of pentane is composed solely of carbon, hydrogen, oxygen, nitrogen, and sulfur.

(vii) For any importer, the PADD in which the import facility is located.

(2) Each annual report shall include the total volume of blender commercial grade pentane pursuant to § 80.86(a)(3) or blender non-commercial grade pentane pursuant to § 80.86(a)(4) for the reporting period.

(3) Annual reports shall be submitted by March 31 of each year.

■ 12. Section 80.77 is amended by revising the introductory text and paragraphs (c), (d), and (f) to read as follows:

**§ 80.77 Product transfer documentation.**

On each occasion when any person transfers custody or title to any reformulated gasoline, RBOB, or

pentane for use by a pentane blender other than when gasoline is sold or dispensed for use in motor vehicles at a retail outlet or wholesaler-purchaser-consumer facility, the transferor shall provide to the transferee documents which include the following information:

\* \* \* \* \*

(c) The volume of gasoline, RBOB, or pentane for use by a pentane blender which is being transferred;

(d) The location of the gasoline or pentane for use by a pentane blender at the time of the transfer;

\* \* \* \* \*

(f) The proper identification of the product as reformulated gasoline, RBOB, or pentane for use by a pentane blender; and

\* \* \* \* \*

■ 13. Section 80.80 is amended by revising paragraphs (b) and (d) to read as follows:

**§ 80.80 Penalties.**

\* \* \* \* \*

(b) Any violation of a standard for average compliance during any averaging period, or for per-gallon compliance for any batch of gasoline or blender grade pentane, shall constitute a separate violation for each and every standard that is violated.

\* \* \* \* \*

(d)(1) Any violation of any per-gallon standard or of any per-gallon minimum or per-gallon maximum, other than the standards specified in paragraph (e) of this section, shall constitute a separate day of violation for each and every day such gasoline or blender grade pentane giving rise to such violations remains any place in the gasoline or blender grade pentane distribution system, beginning on the day that the gasoline or blender grade pentane that violates such per-gallon standard is produced or imported and distributed and/or offered for sale, and ending on the last day that any such gasoline or blender grade pentane is offered for sale or is dispensed to any ultimate consumer for use in any motor vehicle; unless the violation is corrected by altering the properties and characteristics of the gasoline or blender grade pentane giving rise to the violations and any mixture of gasolines or blender grade pentane that contains any of the gasoline or blender grade pentane giving rise to the violations such that said gasoline or mixture of gasolines or said blender grade pentane or mixture of blender grade pentanes has the properties and characteristics that would have existed if the gasoline or blender grade pentane giving rise to the violations had been

produced or imported in compliance with all per-gallon standards.

(2) For the purposes of this paragraph (d), the length of time the gasoline or blender grade pentane in question remained in the gasoline or blender grade pentane distribution system shall be deemed to be twenty-five days; unless the respective party or EPA demonstrates by reasonably specific showings, by direct or circumstantial evidence, that the gasoline or blender grade pentane giving rise to the violations remained any place in the gasoline or blender grade pentane distribution system for fewer than or more than twenty-five days.

\* \* \* \* \*

■ 14. Section 80.82 is revised to read as follows:

**§ 80.82 Butane blending.**

A refiner for any refinery that produces gasoline by blending butane with previously certified gasoline (PCG) may meet the sampling and testing requirements for this part as follows:

(a) Except as provided in paragraphs (e) and (i) of this section, any refinery that blends butane for which the refinery has documents from the butane supplier which demonstrate that the butane is commercial grade, as defined in paragraph (c) of this section, may demonstrate compliance with the standards in this part based on the properties specified in paragraph (c) of this section, or the properties specified by the butane supplier.

(b)(1) Except as provided in paragraphs (e) and (i) of this section, any refiner that blends butane for which the refiner has documents from the butane supplier which demonstrate that the butane is non-commercial grade, as defined in paragraph (d) of this section, may demonstrate compliance with the standards in this part based on the properties specified in paragraph (d) of this section, or the properties specified by the butane supplier, provided that the refinery—

(i) Conducts a quality assurance program of sampling and testing the butane obtained from each separate butane supplier which demonstrates that the butane has the properties specified in paragraph (d) of this section; and

(ii) The frequency of sampling and testing for the butane received from each butane supplier must be one sample for every 500,000 gallons of butane received, or one sample every three months, whichever is more frequent.

(2) Where test results indicate the butane does not meet the requirements

in paragraph (b)(1) of this section, the refiner may—

(i) Blend the butane with conventional gasoline, or reformulated gasoline that has been downgraded to conventional gasoline, provided the equivalent emissions performance of the butane batch, as determined using the provisions in § 80.101(g)(3), meets the refinery's standards under § 80.101 and the refiner meets all of the standards and requirements applicable to refiners of conventional gasoline under this part;

(ii) Blend the butane with reformulated gasoline or RBOB, provided that the final batch of butane blended with reformulated gasoline or RBOB meets the applicable per-gallon standards in § 80.41(e), as determined using the test methods in § 80.46 or § 80.47, as applicable.

(c) Commercial grade butane is defined as butane for which test results demonstrate that the butane is 95% pure and has all the following properties:

- (1) Olefins  $\leq 1.0$  vol%.
- (2) Aromatics  $\leq 2.0$  vol%.
- (3) Benzene  $\leq 0.03$  vol%.

(4) Sulfur  $\leq 30$  ppm from January 1, 2005 through December 31, 2016;  $\leq 10$  ppm beginning January 1, 2017 and thereafter.

(d) Non-commercial grade butane is defined as butane for which test results demonstrate the butane has all the following properties:

- (1) Olefins  $\leq 10.0$  vol%.
- (2) Aromatics  $\leq 2.0$  vol%.
- (3) Benzene  $\leq 0.03$  vol%.

(4) Sulfur  $\leq 30$  ppm beginning January 1, 2005 through December 31, 2016;  $\leq 10$  ppm beginning January 1, 2017 and thereafter.

(e)(1) When butane is blended with conventional gasoline under this section during the period May 1 through September 15, the refiner shall demonstrate through sampling and testing, using the test method for Reid vapor pressure in § 80.46 or § 80.47, as applicable, that each batch of conventional gasoline blended with butane meets the volatility standards specified in § 80.27.

(2) Butane may not be blended with any reformulated gasoline or RBOB during the period April 1 through September 30, or with any reformulated gasoline or RBOB designated as VOC-controlled, under this section.

(f) When butane is blended with previously certified gasoline under this section, product transfer documents which accompany the gasoline blended with butane must comply with all of the requirements of § 80.77 or § 80.106, as appropriate.

(g) Butane blended with previously certified gasoline during a period of up

to one month may be included in a single batch for purposes of reporting to EPA, however, commercial grade butane and non-commercial grade butane must be reported as separate batches.

(h) Where a refiner chooses to include butane blended with gasoline in the refinery's annual average compliance calculations—

(1) In the case of butane blended with conventional gasoline, the equivalent emissions performance of the butane must be calculated in accordance with the provisions of § 80.101(g)(3). For purposes of this paragraph (h)(1), the property values in § 80.82(c) or (d), as appropriate, may be used;

(2) In the case of butane blended with reformulated gasoline or RBOB, compliance with the reformulated gasoline standards may not be demonstrated using the provisions of this section;

(3) All butane blended into gasoline during the annual averaging period must be included in annual average compliance calculations for the refinery.

(i) A refiner who only blends commercial grade or non-commercial grade butane into PCG may meet the sampling and testing requirements of this part by meeting the requirements of paragraphs (a) through (f) and (h)(3) of this section and all the following additional requirements:

(1) The per-gallon sulfur content of every batch of butane must not exceed 30 ppm from January 1, 2005 through December 31, 2016, and 10 ppm beginning January 1, 2017 and thereafter.

(2) The refiner obtains test results from the butane supplier that demonstrate that the sulfur content of each load does not exceed the applicable per-gallon sulfur standard under paragraph (i)(1) of this section through test results of samples of butane contained in the storage tank from which the butane blender is supplied.

(i) Sampling and testing for the sulfur content of the butane by the supplier must be subsequent to each receipt of butane into the supplier's storage tank or the sampling and testing must be immediately before transfer of butane to the butane blender.

(ii) The testing must be performed in accord with the provisions of § 80.46, § 80.47, or other test methods as approved by the Administrator as applicable.

(iii) The butane blender must obtain a copy of the butane supplier's test results at the time of each transfer of butane to the butane blender.

(3) The sulfur content and volume of each batch of gasoline produced is that of the butane that the refiner blends into

PCG for the purposes of calculating compliance with the applicable per-gallon sulfur standard.

(4) The requirements of paragraphs (i)(1) through (3) of this section apply regardless of whether the butane is commercial grade or non-commercial grade.

(5) The quality assurance testing requirement of paragraph (b)(1) of this section applies regardless of whether the butane is commercial grade or non-commercial grade.

(6) If any of the requirements of this paragraph (i) are not met, in whole or in part for any butane blended into gasoline, that butane is deemed in violation of the gasoline standards in § 80.1603(a).

(j) The PCG procedures of § 80.1640 may be used to meet the sampling and testing requirements of subpart O of this part.

■ 15. A new § 80.85 is added to subpart D to read as follows:

**§ 80.85 Pentane blending.**

A refiner for any refinery where gasoline is produced by adding blender-commercial grade pentane or blender-non-commercial grade pentane meeting the requirements of § 80.86 to previously certified gasoline (PCG) may meet the sampling and testing requirements for this part as follows:

(a) Any refinery that blends pentane for which the refinery has product transfer documents from a registered pentane supplier which demonstrate that the pentane is blender-commercial grade, as defined in § 80.86(a)(3), may demonstrate compliance with the standards in this part based on the properties specified in § 80.86(a)(3), or the properties specified by the pentane supplier, provided that the refinery does all the following:

(1) Obtains a copy of the pentane supplier's test results at the time of each transfer of pentane to the pentane blender that indicates that the blender-commercial grade pentane complies with the requirements of § 80.86(a)(3).

(2) Conducts a quality assurance program of sampling and testing the pentane obtained from each separate pentane supplier using test procedures that have been approved by the Administrator which demonstrates that the pentane has the properties specified in § 80.86(a)(3). Samples and tests the pentane received from each pentane supplier at a frequency of one sample for every 350,000 gallons of pentane received, or one sample every three months, whichever is more frequent.

(3) Enters into a contract with all parties who transport or store blender-commercial grade pentane for use by the

refiner to assure that an adequate quality assurance program is implemented to ensure that blender-commercial grade pentane will not be contaminated in transit to the refinery.

(b) Any refiner that blends pentane for which the refiner has product transfer documents from a registered pentane supplier which demonstrate that the pentane is blender-non-commercial grade, as defined in § 80.86(a)(4), may demonstrate compliance with the standards in this part based on the properties specified in § 80.86(a)(4), or the properties specified by the pentane supplier, provided that the refinery does all the following:

(1) Obtains a copy of the pentane supplier's test results at the time of each transfer of pentane to the pentane blender that indicates that the blender-non-commercial grade pentane complies with the requirements of § 80.86(a)(4).

(2) Conducts a quality assurance program of sampling and testing the pentane obtained from each separate pentane supplier using test procedures that have been approved by the Administrator which demonstrates that the pentane has the properties specified in § 80.86(a)(4). Samples and tests the pentane received from each pentane supplier at a frequency of one sample for every 250,000 gallons of pentane received, or one sample every three months, whichever is more frequent.

(3) Enters into a contract with all parties who transport or store blender-non-commercial grade pentane for use by the refiner to assure that an adequate quality assurance program is implemented to ensure that blender-non-commercial grade pentane will not be contaminated in transit to the refinery.

(c) When pentane is blended with conventional gasoline under this section during the period May 1 through September 15, the refiner shall demonstrate through sampling and testing, using the test method for Reid vapor pressure in § 80.46 or § 80.47 as applicable, that each batch of conventional gasoline blended with pentane meets the volatility standards specified in § 80.27, and in any EPA approved SIP.

(d) When pentane is blended with conventional gasoline, CBOB, reformulated gasoline, or RBOB under this section, product transfer documents which accompany the gasoline blended with pentane must comply with all of the requirements of § 80.77 or § 80.106, as appropriate.

(e) Pentane blended with conventional gasoline, CBOB, reformulated gasoline, or RBOB during a period of up to one month may be

included in a single batch for purposes of reporting to EPA, if the refiner meets the sample compositing requirements in § 80.91(d)(4)(iii), and reports blender-commercial grade and blender-non-commercial grade pentane as separate batches.

(f) The provisions of this section may not be used for any pentane blended with any reformulated gasoline or RBOB during the period April 1 through September 30, or with any reformulated gasoline or RBOB designated as VOC-controlled.

(g) All pentane blended into gasoline during the annual averaging period must be included in annual average compliance calculations for the refinery.

(h) If any of the requirements of this section are not met, in whole or in part for any pentane blended into gasoline, that pentane is deemed in violation of the gasoline standards in § 80.1603(a).

(i) If a refiner does not fully implement the requirements of this section, they may not rely on test results from the pentane producer, and may only blend pentane with gasoline if they fully comply with all applicable requirements of this part 80, including the sampling and testing requirements applicable to refiners who produce gasoline by adding blendstocks to PCG.

■ 16. A new § 80.86 is added to subpart D to read as follows:

**§ 80.86 Requirements for producers and importers of pentane used by pentane blenders.**

Producers and importers of pentane may designate batches of pentane as blender-commercial grade pentane or blender-non-commercial grade pentane suitable for use by pentane blenders pursuant to the requirements in this section.

(a) *Standards.* (1) The pentane must be composed solely of carbon, hydrogen, oxygen, nitrogen, and sulfur.

(2) The pentane must meet the standards for blender-commercial grade pentane or blender-non-commercial grade pentane.

(3) For blender commercial grade pentane, the producer or importer must conduct analytical testing to on each production batch to demonstrate compliance with the following standards using sampling and testing procedures that have been approved by the Administrator:

(i) Pentane  $\geq$  95 vol%.

(ii) Olefins  $\leq$  1.0 vol%.

(iii) Aromatics  $\leq$  2.0 vol%.

(iv) Benzene  $\leq$  0.03 vol%.

(v) C6 and higher carbon number hydrocarbons  $\leq$  5.0 vol%.

(vi) Sulfur  $\leq$  30 ppm from January 1, 2005 through December 31, 2016;  $\leq$  10

ppm beginning January 1, 2017 and thereafter.

(4) For blender-non-commercial grade pentane, the producer or importer must conduct analytical testing on each production batch to demonstrate compliance with the following standards using sampling and testing procedures that have been approved by the Administrator:

- (i) Olefins  $\leq 10.0$  vol%.
- (ii) Aromatics  $\leq 2.0$  vol%.
- (iii) Benzene  $\leq 0.03$  vol%.
- (iv) C6 and higher carbon number hydrocarbons  $\leq 5.0$  vol%.
- (v) Sulfur  $\leq 30$  ppm beginning January 1, 2005 through December 31, 2016;  $\leq 10$  ppm beginning January 1, 2017 and thereafter.

(b) *Registration.* The producer or importer of pentane for use by pentane blenders must register with EPA pursuant to the following requirements:

(1) *Registration dates.* Any producer or importer of pentane for use by pentane blenders must register with EPA at least thirty days in advance of the first date that such person will produce or import pentane for use by pentane blenders.

(2) *Registration for producers of pentane for use by pentane blenders.* Registration shall be on forms and following procedures prescribed by the Administrator, and shall include all the following information:

- (i) The name, business address, contact name, email address, and telephone number of the producer of pentane for use by pentane blenders.
- (ii) For each separate facility that will produce pentane for use by pentane blenders, the facility name, physical location, contact name, telephone number, and type of facility.
- (iii) For each separate facility that will produce pentane for use by pentane blenders—

(A) Whether records are kept on-site or off-site of the refinery.

(B) If records are kept off-site, the primary off-site storage facility name, physical location, contact name, and telephone number.

(iv) A description of the production facility which demonstrates that the facility is capable of producing pentane that is compliant with the requirements of this section without significant modifications to the existing facility.

(v) A description of the means pentane will be shipped from the production facility to the pentane blender(s) and the associated quality assurance practices which demonstrate that contamination during distribution can be adequately controlled so as not to cause the pentane to be in violation of the standards in this section.

(vi) A description of the sampling and testing procedures that will be used pursuant to the requirements of paragraphs (a)(3) and (4) of this section.

(vii) EPA will supply a company registration number to each producer of pentane for use by pentane blenders, and a facility registration number for each production facility that is identified. These registration numbers shall be used in all reports to the Administrator.

(viii) Any producer of pentane for use by pentane blenders shall submit updated registration information to the Administrator within thirty days of any occasion when the registration information previously supplied becomes incomplete or inaccurate.

(3) *Registration for importers of pentane for use by pentane blenders.* Registration shall be on forms and following procedures prescribed by the Administrator, and shall include all the following information:

(i) The name, business address, contact name, and email address, telephone number of the importer.

(ii) For each importer's operations in a single PADD—

(A) Whether records are kept on-site at the registered address or off-site.

(B) If records are kept off-site, the primary off-site storage facility name, physical location, contact name, email address, and telephone number.

(iii) A description of the importer's operating facility which demonstrates that the importer is capable of providing pentane that is compliant with the requirements of this section without significant modifications to the existing facility.

(iv) A description of the means pentane will be shipped from the importer's facility to the pentane blender(s) and the associated quality assurance practices which demonstrate that contamination during distribution can be adequately controlled so as not to cause the pentane to be in violation of the standards in this section.

(v) A description of the sampling and testing procedures that will be used pursuant to the requirements of paragraphs (a)(3) and (4) of this section.

(vi) EPA will supply a company registration number to each importer. This registration number shall be used in all reports to the Administrator.

(vii) Any importer of pentane for use by pentane blenders shall submit updated registration information to the Administrator within thirty days of any occasion when the registration information previously supplied becomes incomplete or inaccurate.

(c) *PTDs.* The producer or importer of pentane for use by pentane blenders

must initiate a PTD for each batch that it ships from its facility which contains the statement in paragraph (c)(1) or (c)(2) of this section, as applicable.

(1) "Blender commercial grade pentane for use by pentane blenders".

(2) "Blender non-commercial grade pentane for use by pentane blenders".

(3) PTDs that are compliant with the requirements in paragraph (c) of this section must be transferred from each party transferring pentane for use by pentane blenders to each party that receives pentane for use by pentane blenders through to the pentane blender.

(4) Alternative PTD language to that specified in paragraphs (c)(1) and (c)(2) of this section may be used as approved by EPA.

(d) *Batch numbers.* Every batch of pentane for use by pentane blenders that is produced or imported at a pentane production or import facility shall be assigned a number (the "batch number"), consisting of the EPA-assigned registration number, the EPA facility registration number, the last two digits of the year in which the batch was produced, and a unique number for the batch, beginning with the number one for the first batch produced or imported each calendar year and each subsequent batch during the calendar year being assigned the next sequential number (e.g., 4321-54321-95-000001, 4321-54321-95-000002, etc.).

■ 17. A new § 80.87 is added to subpart D to read as follows:

**§ 80.87 Controls and prohibitions for producers, importers, and distributors of pentane for use by pentane blenders.**

(a) *Prohibited acts.* No person shall—

(1) Produce, import, sell, distribute, offer for sale or distribution, blend, supply, offer for supply, store, transport, or cause the transportation of any product designated as pentane for use by pentane blenders unless—

(i) Each gallon of such pentane for use by pentane blenders meets the applicable standards specified in § 80.86; and

(ii) The product transfer documentation for such pentane for use by pentane blenders complies with the requirements in §§ 80.77 and 80.86(c).

(2) Produce or import pentane for use by pentane blenders unless the producer or importer complies with the recordkeeping requirements of § 80.74, the reporting requirements of § 80.75, and the requirements of § 80.86.

(3) Fail to meet any other requirements of § 80.86.

(4) Cause another person to commit an act in violation of this paragraph (a).

(b) *Persons liable.* The following persons are liable for violations of

prohibited acts in paragraph (a) of this section:

(1) Any person who manufactures, imports, sells, distributes, offers for sale or distribution, blends, supplies, offers for supply, stores, transports, or causes the transportation of any product designated as pentane for use by pentane blenders that violates § 80.86 is liable for the violation.

(2) Any person that causes another party to violate paragraph (a) of this section is liable for a violation of this paragraph (b).

(3) Any parent corporation is liable for any violations of this section that are committed by any of its wholly-owned subsidiaries.

(4) Each partner to a joint venture, or each owner of a facility owned by two or more owners, is jointly and severally liable for any violation of this subpart that occurs at the joint venture facility or a facility that is owned by the joint owners, or a facility that is committed by the joint venture operation or any of the joint owners of the facility.

(c) Any person who violates this section is liable for the violation.

(d) *Determination of compliance.* EPA may establish noncompliance with standards using any information, including the results of testing using methods that are not included in § 80.46.

(e) *Dates controls and prohibitions begin.* The controls and prohibitions specified in paragraph (a) of this section apply at any location on or after June 27, 2014.

(f) *Penalties.* (1) Any person liable for a violation under this section is subject to civil penalties as specified in sections 205 and 211(d) of the Clean Air Act (42 U.S.C. 7524 and 7545(d)) for every day of each such violation and the amount of economic benefit or savings resulting from each violation.

(2) Any person liable under this section for a violation of an applicable standards or causing another person to violate the requirements is subject to a separate day of violation for each and every day the non-complying pentane or gasoline remains any place in the pentane or gasoline distribution system.

(3) For purposes of paragraph (c) of this section, the length of time the pentane or gasoline in question remained in the pentane or gasoline distribution system is deemed to be twenty-five days, unless a person subject to liability or EPA demonstrates by reasonably specific showings, by direct or circumstantial evidence, that the non-complying pentane or gasoline remained in the distribution system for fewer than or more than twenty-five days.

(g) Any person liable under this section for failure to meet, or causing a failure to meet, a provision of this subpart is liable for a separate day of violation for each and every day such provision remains unfulfilled.

#### Subpart E—[Amended]

■ 18. Section 80.101 is amended by:

■ a. Revising paragraph (i)(1)(i)(A).

■ b. Revising paragraph (i)(3)(i)(C).

■ c. Revising paragraph (i)(3)(ii)(C).

#### § 80.101 Standards applicable to refiners and importers.

\* \* \* \* \*

(i) \* \* \*

(1) \* \* \*

(i)(A) Through December 31, 2015, determine the value of each of the properties required for determining compliance with the standards that are applicable to the refiner or importer, by collecting and analyzing a representative sample of gasoline or blendstock from the batch, using methodologies specified in § 80.46; beginning January 1, 2016, determine the value of each of the properties required for determining compliance with the standards that are applicable to the refiner or importer, by collecting and analyzing a representative sample of gasoline or blendstock from the batch, using methodologies specified in § 80.47; except that—

\* \* \* \* \*

(3) \* \* \*

(i) \* \* \*

(C) The testing must be for each applicable parameter specified under § 80.65(e)(2)(i), using the test methods specified under § 80.46 through December 31, 2015, or under § 80.47 beginning January 1, 2016.

\* \* \* \* \*

(ii) \* \* \*

(C) The testing must be for each applicable parameter specified under § 80.65(e)(2)(i), using the test methods specified under § 80.46 through December 31, 2015, or under § 80.47 beginning January 1, 2016.

\* \* \* \* \*

■ 19. Section 80.105 is amended by:

■ a. Revising paragraph (a)(5).

■ b. Revising paragraph (a)(7).

■ c. Revising paragraph (c).

■ d. Revising paragraph (d)(2).

#### § 80.105 Reporting requirements.

(a) \* \* \*

(5) All the following information for each batch of conventional gasoline or batch of blendstock included under paragraph (a) of this section:

(i) The batch number.

(ii) The date of production.

(iii) The volume of the batch.

(iv) The grade of gasoline produced (i.e., premium, mid-grade, or regular).

(v) The properties, along with identification of the test method used to measure those properties, pursuant to § 80.101(i).

(vi) In the case of any previously certified gasoline used in a refinery operation under the terms of § 80.101(g)(9), all the following information relative to the previously certified gasoline when received at the refinery:

(A) Identification of the previously certified gasoline as such.

(B) The batch number assigned by the receiving refinery.

(C) The date of receipt.

(D) The volume, properties (along with identification of the test method used to measure those properties), and designation of the batch.

(vii) In the case of butane blended with conventional gasoline under § 80.82, all the following:

(A) Identification of the butane batch as complying with the provisions of § 80.82.

(B) Identification of the butane batch as commercial or non-commercial grade butane.

(C) The batch number of the butane.

(D) The date of production of the gasoline produced using the butane.

(E) The volume of the butane batch.

(F) The properties of the butane batch specified by the butane supplier, along with identification of the test method used to measure those properties, or the properties specified in § 80.82(c) or (d), as appropriate.

(G) Where butane is blended with conventional gasoline during the period May 1 through September 15, the Reid vapor pressure, along with identification of the test method used to measure Reid vapor pressure (per § 80.46 through December 31, 2015 and § 80.47 beginning January 1, 2016);

(viii) In the case of pentane blended with conventional gasoline under § 80.85, all the following:

(A) Identification of the pentane batch as complying with the provisions of §§ 80.85 and 80.86.

(B) Identification of the pentane batch as blender-commercial grade or blender-non-commercial grade pentane.

(C) The batch number of the pentane.

(D) The date of production of the gasoline produced using the pentane.

(E) The volume of the pentane batch.

(F) The properties of the pentane batch specified by the pentane supplier, or the properties specified in § 80.85(c) or (d), as appropriate.

(G) Where pentane is blended with conventional gasoline during the period

May 1 through September 15, the Reid vapor pressure, as measured using the appropriate test method in § 80.46 or § 80.47, as applicable.

(ix) In the case of any imported GTAB, identification of the gasoline as GTAB.

\* \* \* \* \*

(7) For refiners that blend any butane with conventional gasoline under § 80.82, or any pentane with conventional gasoline under the report required under § 80.85, the report described in paragraph (a) of this section must include all the following information for the annual averaging period:

(i) The total volume of butane blended with conventional gasoline.

(ii) The total volume of conventional gasoline produced using butane.

(iii) A statement that the gasoline produced using butane meets all applicable downstream standards that apply to conventional gasoline under this subpart E, along with the test methods used to determine compliance with the downstream standards that apply to conventional gasoline under this subpart E.

(iv) A statement that all butane blended with conventional gasoline at the refinery is included in the volume under paragraph (a)(7)(i) of this section, or a statement that all butane blended with conventional gasoline is included in the refinery's annual average compliance calculations under § 80.101.

(v) The total volume of pentane blended with conventional gasoline.

(vi) The total volume of conventional gasoline produced using pentane.

(vii) A statement that the gasoline produced using pentane meets all applicable downstream standards that apply to conventional gasoline under this subpart E.

(viii) A statement that all pentane blended with conventional gasoline at the refinery is included in the volume under paragraph (a)(7)(v) of this section, or a statement that all pentane blended with conventional gasoline is included in the refinery's annual average compliance calculations under § 80.101.

\* \* \* \* \*

(c) For each averaging period, each refiner for each refinery and importer shall submit to the Administrator of EPA, by June 1 of each year, a report in accordance with the requirements for the Attest Engagements of § 80.125 through § 80.131.

(d) \* \* \*

(2) Submitted to EPA by March 31 each year for the prior calendar year averaging period; and

\* \* \* \* \*

**Subpart G—[Amended]**

- 20. Section 80.161 is amended by:
  - a. Revising paragraph (b)(1)(ii)(A)(2) and adding paragraph (b)(1)(ii)(A)(3).
  - b. Revising paragraph (b)(2) introductory text.
  - c. Revising paragraphs (b)(3)(ii)(C), (b)(3)(v), and (b)(3)(viii).
  - d. Revising paragraph (d)(1).

**§ 80.161 Detergent additive certification program.**

\* \* \* \* \*

- (b) \* \* \*
- (1) \* \* \*
- (ii) \* \* \*
- (A) \* \* \*

(2) In the case of the alternative national generic certification option pursuant to § 80.163(a)(1)(iii), the minimum recommended concentration must equal or exceed the amount mixed into the associated test fuel specified in § 80.177, which was shown to satisfy the fuel injector deposit control and intake valve deposit control performance tests and standards specified in § 80.176.

(3) In the case of any other detergent certification option, the minimum recommended concentration must equal or exceed the amount mixed into the associated test fuel specified in § 80.164, which was shown to satisfy the fuel injector deposit control and intake valve deposit control performance tests and standards specified in § 80.165.

\* \* \* \* \*

(2) The detergent additive manufacturer (or other certifying party) must submit to EPA a sample of the actual detergent additive package which was used in the certification test fuels specified in § 80.164 or § 80.177 or, if such sample is not available, then a sample which has the same composition as the package used in certification testing.

\* \* \* \* \*

- (3) \* \* \*
- (ii) \* \* \*

(C) Complete documentation of the test fuel formulation, IVD demonstration procedures, fuel injector deposit demonstration procedure if applicable, detergent performance test procedures, and test results are available for EPA's inspection upon request.

\* \* \* \* \*

(v) In the case of a national or PADD certification (pursuant to § 80.163(a)(1) or (b)) for which the test fuel was specially formulated from refinery blend stocks, the results of the IVD demonstration test, pursuant to § 80.164(b)(3). In the case of an alternative national generic certification

(pursuant to § 80.163(a)(1)(iii)), the results of the IVD demonstration test and fuel injector deposit demonstration test (pursuant to § 80.177).

\* \* \* \* \*

(viii) The test concentration(s) of the subject detergent additive in each test fuel, and the corresponding test results (percent flow restriction demonstrated in the fuel injector test and milligrams of deposit per valve demonstrated in the IVD test).

\* \* \* \* \*

(d) \* \* \*

(1) If a detergent blender possesses deposit control performance test results as specified in § 80.165, § 80.166, or § 80.176 which show that the minimum treat rate recommended by the manufacturer of a detergent additive product exceeds the amount of that detergent actually required for effective deposit control, then, upon informing EPA in writing of these circumstances, the detergent blender may use the detergent at the lower concentration substantiated by these test results.

\* \* \* \* \*

■ 21. Section 80.163 is amended by adding a new paragraph (a)(1)(iii) to read as follows:

**§ 80.163 Detergent certification options.**

\* \* \* \* \*

- (a) \* \* \*
- (1) \* \* \*

(iii) *Alternative national generic certification option.* To be certified under this option, a candidate detergent must meet the deposit control performance test requirements and standards specified in § 80.176 using test fuels that conform to the requirements in § 80.177. A detergent certified under this option is eligible to be used at a conforming LAC in any grade of gasoline, with or without an oxygenate component.

\* \* \* \* \*

■ 22. Section 80.164 is amended by revising paragraph (a) introductory text to read as follows:

**§ 80.164 Certification test fuels.**

(a) *General requirements.* This section provides specifications for the test fuels required in conjunction with the certification options described in §§ 80.163(a)(1) and 80.163(b) through (d). For each such certification option, the associated test fuel must meet or exceed the levels of four basic fuel parameters (aromatics, fuel sulfur, olefins, and T-90) prescribed here and may also contain specified oxygenate compounds. In addition, pursuant to paragraph (b)(3) of this section, some fuels must undergo an IVD



demonstration test before they are eligible to be used as test fuels under this certification program. Test fuel characteristics must be reported to EPA in the detergent certification letter required pursuant to § 80.161(b)(3). The specifications for the test fuels required in conjunction with the alternative national generic certification option in § 80.163(a)(1)(iii) are contained in § 80.177.

\* \* \* \* \*

■ 23. Section 80.165 is revised to read as follows:

**§ 80.165 Certification test procedures and standards.**

This section specifies the deposit control test requirements and performance standards which must be met in order to certify detergent additives for use in unleaded gasoline, pursuant to § 80.161(b)(1)(ii)(A)(3). These standards must be met in the context of the specific test procedures identified in paragraphs (a) and (b) of this section, except as provided in paragraph (c) of this section. The testing must be conducted and the performance standards met when the subject detergent additive is mixed in a test fuel meeting all relevant requirements of § 80.164, including the deposit-forming tendency demonstration specified in § 80.164(b)(3), if applicable. Complete test documentation must be submitted by the certifying party within 30 days of receipt of a written request from EPA for such records. The certification test procedures and standards associated with the alternative national generic certification option in § 80.163(a)(1)(iii) are contained in § 80.176.

(a) *Fuel injector deposit control testing.* The required test fuel must produce no more than 5% flow restriction in any one injector when tested in accordance with ASTM D5598. At the option of the certifier, fuel injector flow may be measured at intervals during the 10,000 mile test cycle described in ASTM D5598, in addition to the flow measurements required at the completion of the test cycle, but not more than every 1,000 miles.

(b) *Intake valve deposit control testing.* The required test fuel must produce the accumulation of less than 100 mg of intake valve deposits on average when tested in accordance with ASTM D5500.

(c) *Materials incorporated by reference.* The published materials identified in this section are incorporated by reference into this section with the approval of the Director of the Federal Register under 5 U.S.C. 552(a) and 1 CFR part 51. To enforce

any edition other than that specified in this section, a document must be published in the **Federal Register** and the material must be available to the public. All approved materials are available for inspection at the Air and Radiation Docket and Information Center (Air Docket) in the EPA Docket Center (EPA/DC) at Rm. 3334, EPA West Bldg., 1301 Constitution Ave. NW., Washington, DC. The EPA/DC Public Reading Room hours of operation are 8:30 a.m. to 4:30 p.m., Monday through Friday, excluding legal holidays. The telephone number of the EPA/DC Public Reading Room is (202) 566-1744, and the telephone number for the Air Docket is (202) 566-1742. These approved materials are also available for inspection at the National Archives and Records Administration (NARA). For information on the availability of this material at NARA, call (202) 741-6030 or go to [http://www.archives.gov/federal\\_register/code\\_of\\_federal\\_regulations/ibr\\_locations.html](http://www.archives.gov/federal_register/code_of_federal_regulations/ibr_locations.html). In addition, these materials are available from the sources listed below.

(1) *ASTM International material.* The following standards are available from ASTM International, 100 Barr Harbor Dr., P.O. Box C700, West Conshohocken, PA 19428-2959, (877) 909-ASTM, or <http://www.astm.org>:

(i) ASTM D5500-98 (Reapproved 2008), Standard Test Method for Vehicle Evaluation of Unleaded Automotive Spark-Ignition Engine Fuel for Intake Valve Deposit Formation, approved July 1, 2008.

(ii) ASTM D5598-01 (Reapproved 2012), Standard Test Method for Evaluating Unleaded Automotive Spark-Ignition Engine Fuel for Electronic Port Fuel Injector Fouling, approved November 1, 2012.

(2) [Reserved]

■ 24. Section 80.167 is amended by revising paragraph (a) to read as follows:

**§ 80.167 Confirmatory testing.**

\* \* \* \* \*

(a) Confirmatory testing conducted to evaluate the validity of detergent certifications under the national, PADD, or fuel-specific options under §§ 80.163(a)(1) and 80.163(b) through (d) will generally entail a single vehicle test using the procedures detailed in § 80.165. The test fuel(s) used in conducting such confirmatory certification testing will contain the specified fuel parameters at or below the minimum levels specified in § 80.164, and will otherwise conform to the applicable certification test fuel specifications therein. Confirmatory testing conducted to evaluate the validity of detergent certifications under

the alternative national generic certification option in § 80.163(a)(1)(iii) will generally entail a single test using the procedures detailed in § 80.177. The test fuel(s) used in conducting such confirmatory certification testing will contain the specified fuel parameters at or below the minimum levels specified in § 80.177, and will otherwise conform to the applicable certification test fuel specifications therein.

\* \* \* \* \*

■ 25. A new § 80.175 is added to subpart G and reserved as follows:

**§ 80.175 [Reserved]**

■ 26. A new § 80.176 is added to subpart G to read as follows:

**§ 80.176 Alternative certification test procedures and standards.**

This section specifies the deposit control test requirements and performance standards which must be met in order to certify detergent additives for use in unleaded gasoline pursuant to § 80.161(b)(1)(ii)(A)(2). These standards must be met in the context of the specific test procedures identified in paragraphs (a) and (b) of this section. Testing must be conducted and the performance standards met when the subject detergent additive is mixed in a test fuels meeting all relevant requirements of § 80.177. Complete test documentation must be submitted by the certifying party within 30 days of receipt of a written request from EPA for such records.

(a) *Fuel injector deposit control testing.* The required test fuel must produce no more than one inoperative injector when tested in accordance with the fuel injector deposit test procedure specified in paragraph (c) of this section.

(b) *Intake valve deposit control testing.* The required test fuel must produce the accumulation of less than 50 mg of intake valve deposits on average when tested in accordance with ASTM D6201. ASTM D6201-04 (Reapproved 2009), "Standard Test Method for Dynamometer Evaluation of Unleaded Spark-Ignition Engine Fuel for Intake Valve Deposit Formation," approved June 1, 2009, is incorporated by reference into this section with the approval of the Director of the Federal Register under 5 U.S.C. 552(a) and 1 CFR part 51. To enforce any edition other than that specified in this section, a document must be published in the **Federal Register** and the material must be available to the public. Copies are available from ASTM International, 100 Barr Harbor Dr., P.O. Box C700, West Conshohocken, PA 19428-2959, (877) 909-ASTM, <http://www.astm.org>. The

document is also available for inspection at the Air and Radiation Docket and Information Center (Air Docket) in the EPA Docket Center (EPA/DC) at Rm. 3334, EPA West Bldg., 1301 Constitution Ave. NW., Washington, DC. The EPA/DC Public Reading Room hours of operation are 8:30 a.m. to 4:30 p.m., Monday through Friday, excluding legal holidays. The telephone number of the EPA/DC Public Reading Room is (202) 566-1744, and the telephone number for the Air Docket is (202) 566-1742. The document is also available for inspection at the National Archives and Records Administration (NARA). For information on the availability of this material at NARA, call 202-741-6030 or go to: [http://www.archives.gov/federal-register/code\\_of\\_federal\\_regulations/ibr\\_locations.html](http://www.archives.gov/federal-register/code_of_federal_regulations/ibr_locations.html).

(1) Tests conducted for the intake valve deposit demonstration test pursuant to § 80.177(b)(4) and to demonstrate compliance with the intake valve deposit control standards in this section must be conducted using the same engine block and cylinder head.

(2) All results must be derived from operationally valid tests in accordance with the test validation criteria of ASTM D6201.

(3) Test results shall be reported for individual intake valves and as an average of all intake valves.

(c) *Fuel injector deposit test procedure.* (1) *Summary of test procedure.* After flushing the vehicle fuel system with the fuel to be tested and installing new injectors, an automatic starter control system starts the vehicle and lets it idle for five minutes. The engine is then shut off and allowed to soak for 25 minutes. This cycle is repeated for a total of 192 cycles (96 hours). During this time, the engine is kept at operating temperature with block heaters. After the 96 hours of start/soak cycles, the engine is allowed to hot-soak for 48 hours, during which time the engine is not started but is maintained at operating temperature. At the end of the 48-hour hot soak, the block heaters are turned off and the engine is allowed to cool naturally to room temperature. At the end of this 48-hour ambient temperature soak, an injector balance test is conducted to determine whether any poppet nozzles are stuck closed.

(2) *Facilities and equipment—(i) Location.* A temperature-controlled garage or large room is needed. A dynamometer is not needed, since this test is an idle test. The room temperature shall be maintained in the range of 68–75 °F. The room shall be equipped with an exhaust system that connects to the vehicle tail pipe to

remove the exhaust gases from the building. It is recommended that an interlock be provided so that if the building exhaust system fails, the vehicle test will shut down.

(ii) *Electrical power.* Two 110-volt, 15-amp circuits are needed (20-amp circuits are recommended) to operate the four block heaters and a battery charger.

(iii) *Fuel drain facility.* A facility is required to drain the fuel from the vehicle between tests. The fuel is drained from the service port on the fuel rail, near the back of the engine. A commercial cart equipped with a tank and a suction pump is recommended for this operation.

(iv) *Vehicle.* A Chevrolet Astro or GMC Safari van, model year 1998–2001, shall be used for the test. Either two-wheel drive or all-wheel drive is satisfactory, although the former allows easier installation of the block heaters.

(v) *Injectors.* New injectors, General Motors part number 17091432, shall be used for each test.

(vi) *Block heaters.* Four block heaters, General Motors part number 12371293, are needed for each vehicle. Two heaters shall be installed on each side of the engine, in the freeze plug locations.

(vii) *Battery charger.* Because of the large number of starts and the very short engine running time, a battery charger is needed. It is recommended that the charger be installed permanently on the vehicle and remain plugged in while the test is in progress.

(viii) *Starter controller.* A system is needed to start the engine automatically and then shut it off after exactly five minutes of running. A commercial aftermarket remote starting system connected to a timer or computer can be used, or a one-of-a-kind system can be designed and built.

(ix) *Tech 2 analyzer.* A General Motors Tech 2 analyzer, part number GM3000094, available from Kent-Moore, shall be used to conduct the injector balance test.

(x) *Fuel pressure gauge.* A fuel pressure gauge capable of measuring fuel system pressure to the nearest 1 psi over the range of 45 to 65 psi, shall be used with the Tech 2 analyzer when conducting the injector balance test. A pressure transducer shall not be used.

(xi) *Gaskets.* The upper intake manifold gasket and injector body gasket will need to be replaced from time to time as they crack, tear, or wear out from frequent handling during injector replacement.

(3) *Initial vehicle preparation—(i) Diagnostics.* To help determine whether a vehicle is satisfactory for use in this

injector test procedure, a thorough inspection and engine diagnostic test shall be conducted as described in the service manual. Check the cooling system to be sure the coolant looks clean and there are no signs of rust.

(ii) *Block heaters.* Install four electric block heaters, General Motors part number 12371293, in the coolant passages of the engine block, two on each side of the block. The heaters will be plugged into a heater control unit. Two of the heaters will remain on at all times during the first 144 hours of the injector fouling test, while the other two heaters will be turned on and off by the controller as needed to maintain an engine temperature of about 100–102 °C during the soak periods of the test. (The temperature will drop while the engine is running, as the coolant from the radiator circulates through the engine. The temperature should recover to 100–102 °C within about 20 minutes after the engine shuts off.)

(iii) *Thermocouples.* Install a 1/16-inch Type K thermocouple in a threaded bolt hole on the rear of the right cylinder head. This thermocouple provides the feedback signal to the controller to turn two block heaters on and off. Install another thermocouple in the other hole near the first thermocouple. This second thermocouple provides a signal to an over-temperature safety shut-off on the heater controller. If the engine temperature reaches the set point (110 °C recommended), the heater controller will signal the starter controller to shut down the test.

(iv) *Fuel system flush.* Drain the fuel from the fuel system through the service port on the fuel rail at the back of the engine. Refuel with a non-detergent gasoline containing between 5 and 10 percent ethanol. Drive the vehicle for approximately 100 miles to thoroughly expose all parts of the fuel system to the fuel. The fuel pump and fuel filters should not be replaced unless there is a problem with them or if the vehicle history suggests that replacement would be prudent. If replacement is necessary, the new parts should first be conditioned by recirculating a 10% ethanol-gasoline blend (without deposit control additive) through them for one week.

(v) *Oil change.* Change the engine oil and oil filter, using oil that meets the manufacturer's recommended service classification and viscosity grade.

(vi) *Battery charger.* Install a battery charger in the vehicle so that it can be plugged in during the test and keep the battery at full charge.

(vii) *Radiator.* Install cardboard or other suitable material on the front of

the radiator to block the flow of air through the radiator while the engine is running. This will help minimize the drop in coolant temperature.

(viii) *Starter controller.* Make the necessary changes to the vehicle electrical system so that the engine can be started and stopped automatically on a programmed schedule. Install a starter controller or computer and program it to do the following:

(A) Start the engine and let it run for 5 minutes, and then shut it off and let it hot-soak for 25 minutes.

(B) Repeat the 5/25 cycle for a total of 192 cycles.

(C) Allow a 48-hr hot soak during which the engine is not run but the engine temperature is maintained at 100–102 °C.

(D) Turn off the heaters for 48 hours.

(E) Continuously count and display the number of cycles that have been completed throughout the test.

(4) *Test procedure.* The steps described in paragraphs (c)(3)(i) through (vi) of this section must be performed by the action described in paragraph (c)(3)(vii) of this section so that the new injectors are exposed only to the new test fuel. Take the following additional steps:

(i) Drain the fuel from the vehicle.

(ii) Add approximately 2 gallons of the fuel to be tested.

(iii) Drive the vehicle for approximately 20 miles at speeds up to approximately 50–60 mph. Approximately every 5 miles, stop the vehicle and moderately accelerate. If the radiator covering is still in place, watch the temperature gauge during the driving and avoid overheating the engine. This step not only flushes the fuel system but also helps remove carbon (if any) from the spark plugs and water from the exhaust system.

(iv) Drain the fuel from the vehicle and add approximately 1 to 2 gallons of the fuel to be tested.

(v) Drive the vehicle for approximately 5 miles. Watch the temperature gauge and avoid overheating the engine.

(vi) Drain the fuel from the vehicle and add approximately 10 gallons of the fuel to be tested. (The test consumes about 7.5 gallons of fuel.)

(vii) Remove the fuel injectors and install new injectors. Run the engine for a few minutes to be sure it runs properly.

(viii) Park the vehicle in the location where the test will be run.

(ix) Connect the vehicle tail pipe to the building exhaust system.

(x) Depending on the design of the starter control system, remove fuses and relays as necessary and connect the

wires from the controller to the vehicle fuse box. Close the hood.

(xi) Turn on the vehicle ignition switch and the security bypass switch if so equipped.

(xii) Turn on the heater controller and be sure that it is working.

(xiii) Turn on the starter controller and the vehicle should start.

(xiv) Monitor the engine temperature for the first few cycles to be sure it is increasing.

(xv) At the end of the 192-hour (8-day) test, turn off the ignition switch, starter controller, and heater controller. Return the fuses, relays, and wires to their standard configuration for normal operation of the vehicle.

(xvi) Connect the Tech 2 analyzer to the ALDL connector under the instrument panel, and connect the fuel pressure gauge to the service port on the fuel rail at the back of the engine.

(xvii) Conduct the injector balance test by following the instructions on the Tech 2. The injector balance test checks each injector individually to determine whether the poppet nozzle is stuck closed. First, the Tech 2 turns on the fuel pump momentarily to pressurize the fuel system. Then it pulses the injector for a preset interval. If the injector and poppet nozzle are working properly, the fuel system pressure will decrease gradually and smoothly by about 8 to 10 psi during the pulsing. If the pressure does not decrease, or decreases very suddenly but then stops decreasing before the pulsing is done, the poppet is stuck closed. This procedure, beginning with pressurizing the fuel system, is carried out for each injector.

■ 27. A new § 80.177 is added to subpart G to read as follows:

**§ 80.177 Certification test fuels for use with the alternative test procedures and standards.**

(a) *General requirements.* This section provides specifications for the test fuels required in conjunction with the alternative national generic certification option described in § 80.163(a)(1)(iii).

(1) The test fuel characteristics detailed in this section must be reported to EPA in the detergent certification letter required pursuant to § 80.161(b)(3).

(2) The levels of the basic fuel parameters specified in this section (ethanol, olefins, aromatics, sulfur, and 90% evaporation distillation temperature) must be measured in accordance with applicable procedures in § 80.46.

(3) No detergent-active substance other than the detergent additive package undergoing testing may be

added to a certification test fuel. Typical nondetergent additives, such as antioxidants, corrosion inhibitors, and metal deactivators, may be present in the test fuel at the discretion of the additive certifier. In addition, any nondetergent additives (other than oxygenate compounds) which are commonly blended into gasoline and which are known or suspected to affect IVD or PFID formation, or to reduce the ability of the detergent in question to control such deposits, should be added to the test fuel for certification testing.

(4) Certification test requirements may be satisfied for a detergent additive using more than one batch of test fuel, provided that each batch satisfies all applicable test fuel requirements under this section.

(5) Unless otherwise required by this section, finished test fuels must conform to the requirements for commercial gasoline described in ASTM D4814.

(b) *Test fuel for intake valve deposit testing.* The following specifications apply for the test fuels required for use in the test procedure specified in § 80.176(b):

(1) The test fuel must contain no less than 8.0 volume percent and no more than 10.0 volume percent ethanol. Commercial fuel grade denatured fuel ethanol must be used that conforms to the requirement of § 80.1610 and ASTM D4806.

(2) The test fuel must contain no less than 8.0 volume percent olefins. At least 75 percent of the olefins must be derived from fluid catalytic cracker unit (FCC) gasoline. Such FCC gasoline can be full-range FCC gasoline or a mixture of light and heavy FCC gasolines. Such FCC gasoline must be produced by a commercial gasoline refiner and meet the following criteria:

(i) The FCC gasoline must be designated by the commercial refiner as full range FCC gasoline or whole FCC gasoline, and must have a T90 distillation temperature greater than 300 °F.

(ii) If a mixture of light and heavy FCC gasoline is used, heavy FCC gasoline must contribute at least 50 percent of the sulfur in the mixture. Heavy FCC gasoline must meet all the following criteria:

(A) The heavy FCC gasoline must be designated by the commercial refiner as heavy FCC gasoline.

(B) The heavy FCC gasoline must have an API gravity less than 45 and a T90 distillation temperature greater than 325 °F.

(3) The test fuel must contain no less than 28 volume percent aromatics.

(4) The test fuel must contain no less than 24 ppm sulfur. At least 60 percent

of the sulfur must be derived from FCC gasoline that meets the specifications in paragraph (b)(2) of this section.

(5) The test fuel must have a T90 distillation temperature of no less than 290 °F.

(6) The test fuel containing no deposit control additives must produce no less than 500 mg averaged over all intake valves when subjected to the intake valve deposit test specified in § 80.176(b).

(7) All gasoline blendstocks used to formulate the test fuel must be representative of normal refinery operations and shall be derived from conversion units downstream of distillation. Butanes and pentanes may be used for vapor pressure adjustment. The use of chemical grade streams is prohibited.

(c) *Test fuel for fuel injector deposit testing:* This paragraph provides specifications for the test fuels required for use in the test procedure specified in § 80.176(c). The test fuel must conform to the specifications in either paragraph (c)(1) or (c)(2) of this section. The same base test fuel must be used for deposit demonstration testing and for demonstrating compliance with the fuel injector deposit control standards in § 80.176(a).

(1) *Option 1.* (i) The test fuel must be a commercial full boiling range hydrocarbon gasoline or gasoline blending component, without oxygenates.

(ii) The test fuel containing no deposit control additives must produce at least 5 inoperable injectors valves when subjected to the fuel injector deposit test specified in § 80.176(c).

(2) *Option 2.* (i) The test fuel must meet the requirements for federal emissions test gasoline specified in §§ 80.112 and 80.113 into which 4-methylbenzenethiol has been blended as a concentration of 56 mg/L.

(ii) The test fuel containing no deposit control additives must produce at least 4 inoperable injectors valves when subjected to the fuel injector deposit test specified in § 80.176(c).

(d) *Materials incorporated by reference.* The published materials identified in this section are incorporated by reference into this section with the approval of the Director of the Federal Register under 5 U.S.C. 552(a) and 1 CFR part 51. To enforce any edition other than that specified in this section, a document must be published in the **Federal Register** and the material must be available to the public. All approved materials are available for inspection at the Air and Radiation Docket and Information Center (Air Docket) in the EPA Docket

Center (EPA/DC) at Rm. 3334, EPA West Bldg., 1301 Constitution Ave. NW., Washington, DC. The EPA/DC Public Reading Room hours of operation are 8:30 a.m. to 4:30 p.m., Monday through Friday, excluding legal holidays. The telephone number of the EPA/DC Public Reading Room is (202) 566-1744, and the telephone number for the Air Docket is (202) 566-1742. These approved materials are also available for inspection at the National Archives and Records Administration (NARA). For information on the availability of this material at NARA, call (202) 741-6030 or go to [http://www.archives.gov/federal\\_register/code\\_of\\_federal\\_regulations/ibr\\_locations.html](http://www.archives.gov/federal_register/code_of_federal_regulations/ibr_locations.html). In addition, these materials are available from the sources listed below.

(1) *ASTM International material.* The following standards are available from ASTM International, 100 Barr Harbor Dr., P.O. Box C700, West Conshohocken, PA 19428-2959, (877) 909-ASTM, or <http://www.astm.org>;

(i) ASTM D4806-13a, Standard Specification for Denatured Fuel Ethanol for Blending with Gasolines for Use as Automotive Spark-Ignition Engine Fuel, approved June 15, 2013.

(ii) ASTM D4814-13b, Standard Specification for Automotive Spark-Ignition Engine Fuel, approved December 1, 2013.

(2) [Reserved]

**Subpart H—[Amended]**

■ 28. Section 80.330 is amended by revising paragraphs (c)(1) and (d) to read as follows:

**§ 80.330 What are the sampling and testing requirements for refiners and importers?**

\* \* \* \* \*

(c) \* \* \*

(1) For purposes of paragraph (a) of this section, refiners and importers shall use the method provided in § 80.46(a)(1) or one of the alternative test methods listed in § 80.46(a)(3) to measure the sulfur content of gasoline they produce or import through December 31, 20. Beginning January 1, 2016, for purposes of paragraph (a) of this section, refiners and importers shall use an approved method in § 80.47.

\* \* \* \* \*

(d) *Test method for sulfur in butane.*

(1) Refiners and importers shall use the method provided in § 80.46(a)(2) through December 31, 2015 to measure the sulfur content of butane when the butane constitutes a batch of gasoline. Beginning January 1, 2016, refiners and importers shall use an approved method in § 80.47 to measure the sulfur content

of butane when the butane constitutes a batch of gasoline.

(2) Except as provided in paragraph (d)(1) of this section, any ASTM sulfur test method for gaseous fuels may be used for quality assurance testing under §§ 80.340(b)(4) and 80.400, if the protocols of the ASTM method are followed and the alternative test method is correlated to the method provided in § 80.46(a)(2) through December 31, 20, or in § 80.47 beginning January 1, 2016.

\* \* \* \* \*

■ 29. Section 80.340 is amended by revising paragraph (b)(1) and adding paragraph (d) to read as follows:

**§ 80.340 What standards and requirements apply to refiners producing gasoline by blending blendstocks into previously certified gasoline (PCG)?**

\* \* \* \* \*

(b) \* \* \*

(1) The sulfur content of the butane received from the butane supplier must not exceed the following sulfur standards on a per-gallon basis as follows:

- (i)(A) 120 ppm in 2004;
- (B) 30 ppm from January 1, 2005 through December 31, 2016; and
- (C) 10 ppm on or after January 1, 2017.

(ii) Except that the per-gallon sulfur content of butane blended to PCG that is designated as GPA gasoline shall not exceed 150 ppm from January 1, 2004, through December 31, 2006.

\* \* \* \* \*

(d) Refiners who blend only blender-grade pentane into PCG pursuant to the requirements of § 80.85 may meet the sampling and testing requirements by using sulfur test results of the pentane supplier pursuant to the requirements § 80.85, provided that the following requirements are also met:

(1) The sulfur content and volume of each batch of gasoline produced is that of the blender-grade pentane the refiner blends into gasoline for purposes of calculating compliance with the standards in §§ 80.195 and 80.216.

(2) If any of the requirements of this section are not met, in whole or in part, for any pentane blended into gasoline, that pentane is deemed in violation of the gasoline sulfur standards in § 80.85, or § 80.86, § 80.195, § 80.216 as applicable.

- 30. Section 80.370 is amended by:
  - a. Revising paragraph (a)(7)(iv).
  - b. Revising paragraph (d)(2).
  - c. Adding and reserving paragraph (e).
  - d. Revising paragraph (f).

**§ 80.370 What are the sulfur reporting requirements?**

\* \* \* \* \*

(a) \* \* \*

(7) \* \* \*

(iv) The sulfur content of the batch, along with identification of the test method used to measure the sulfur content of the batch, as determined under § 80.330; and

\* \* \* \* \*

(d) \* \* \*

(2) Submitted to EPA by March 31 for the prior calendar year averaging period.

\* \* \* \* \*

(e) [Reserved]

(f) *Attest reports.* Attest reports for refiner and importer attest engagements required under § 80.415 shall be submitted to the Administrator by June 1 of each year for the prior calendar year averaging period.

■ 31. Section 80.385 is amended by revising paragraph (e) to read as follows:

**§ 80.385 What acts are prohibited under the gasoline sulfur program?**

\* \* \* \* \*

(e) *Denatured fuel ethanol violation.*

(1) Through December 31, 2016, blend into gasoline any denatured fuel ethanol with a sulfur content higher than 30 ppm.

(2) Beginning January 1, 2017 and thereafter, blend into gasoline any denatured fuel ethanol with a sulfur content higher than 10 ppm.

\* \* \* \* \*

**Subpart I—[Amended]**

■ 32. Section 80.511 is amended by revising paragraphs (b)(4) and (b)(10) to read as follows:

**§ 80.511 What are the per-gallon and marker requirements that apply to NRLM diesel fuel, ECA marine fuel, and heating oil downstream of the refiner or importer?**

\* \* \* \* \*

(b) \* \* \*

(4) Except as provided in paragraphs (b)(5) through (8) of this section, the per-gallon sulfur standard of § 80.510(c) shall apply to all NRLM diesel fuel beginning August 1, 2014 for all downstream locations other than retail outlets or wholesale purchaser-consumer facilities, shall apply to all NRLM diesel fuel beginning October 1, 2014 for retail outlets and wholesale purchaser-consumer facilities, and shall apply to all NRLM diesel fuel beginning December 1, 2014 for all locations. This paragraph (b)(4) does not apply to LM diesel fuel produced from transmix or interface fuel that is sold or intended for sale in areas other than those listed in § 80.510(g)(1) or (g)(2), as provided by § 80.513(f).

\* \* \* \* \*

(10) For the purposes of this subpart, on any occasion where a distributor

directly dispenses fuel into vehicles or equipment from a mobile facility such as a tanker truck, the distributor shall be treated as a retailer, and the mobile facility shall be treated as a retail outlet.

■ 33. Section 80.572 is amended by revising paragraph (a) to read as follows:

**§ 80.572 What labeling requirements apply to retailers and wholesale purchaser-consumers of Motor Vehicle, NR, LM and NRLM diesel fuel and heating oil beginning June 1, 2010?**

\* \* \* \* \*

(a) From June 1, 2010 through November 30, 2014, any retailer or wholesale purchaser-consumer who sells, dispenses, or offers for sale or dispensing, motor vehicle diesel fuel subject to the 15 ppm sulfur standard of § 80.520(a)(1), must affix the following conspicuous and legible label, in block letters of no less than 24-point bold type, and printed in a color contrasting with the background, to each pump stand:

ULTRA-LOW SULFUR HIGHWAY  
DIESEL FUEL (15 ppm Sulfur  
Maximum)

Required for use in all highway diesel vehicles and engines.

Recommended for use in all diesel vehicles and engines.

\* \* \* \* \*

■ 34. Section 80.573 is amended by revising paragraph (a) to read as follows:

**§ 80.573 What labeling requirements apply to retailers and wholesale purchaser-consumers of NRLM diesel fuel and heating oil beginning June 1, 2012?**

\* \* \* \* \*

(a) From June 1, 2012 through September 30, 2014, for pumps dispensing NRLM diesel fuel subject to the 15 ppm sulfur standard of § 80.510(c):

ULTRA-LOW SULFUR NON-HIGHWAY  
DIESEL FUEL (15 ppm Sulfur  
Maximum)

Required for use in all model year 2011 and later nonroad diesel engines.

Recommended for use in all other non-highway diesel engines.

**WARNING**

Federal law prohibits use in highway vehicles or engines.

\* \* \* \* \*

■ 35. Section 80.574 is revised to read as follows:

**§ 80.574 What labeling requirements apply to retailers and wholesale purchaser-consumers of ECA marine fuel beginning June 1, 2014?**

(a) Any retailer or wholesale purchaser-consumer who sells, dispenses, or offers for sale or

dispensing ECA marine fuel must prominently and conspicuously display in the immediate area of each pump stand from which ECA marine fuel is offered for sale or dispensing, one of the following legible labels, as applicable, in block letters of no less than 24-point bold type, printed in a color contrasting with the background:

(1) From June 1, 2014 and beyond, for pumps dispensing ECA marine fuel subject to the 1,000 ppm sulfur standard of § 80.510(k):

1,000 ppm SULFUR ECA MARINE  
FUEL (1,000 ppm Sulfur Maximum).

For use in Category 3 (C3) marine vessels only.

**WARNING**

Federal law prohibits use in any engine that is not installed on a C3 marine vessel; use of fuel oil with a sulfur content greater than 1,000 ppm in an ECA is prohibited except as allowed by 40 CFR part 1043.

(2) The labels required by paragraph (a)(1) of this section must be placed on the vertical surface of each pump housing and on each side that has gallon and price meters. The labels shall be on the upper two-thirds of the pump, in a location where they are clearly visible.

(b) Alternative labels to those specified in paragraph (a) of this section may be used as approved by EPA. Send requests to—

(1) *For US Mail:* U.S. EPA, Attn: Diesel Sulfur Alternative Label Request, 6406J, 1200 Pennsylvania Avenue NW., Washington, DC 20460.

(2) [Reserved]

■ 36. Section 80.580 is amended by revising paragraph (e) to read as follows:

**§ 80.580 What are the sampling and testing methods for sulfur?**

\* \* \* \* \*

(e) *Materials incorporated by reference.* The published materials identified in this section are incorporated by reference into this section with the approval of the Director of the Federal Register under 5 U.S.C. 552(a) and 1 CFR part 51. To enforce any edition other than that specified in this section, a document must be published in the **Federal Register** and the material must be available to the public. All approved materials are available for inspection at the Air and Radiation Docket and Information Center (Air Docket) in the EPA Docket Center (EPA/DC) at Rm. 3334, EPA West Bldg., 1301 Constitution Ave. NW., Washington, DC. The EPA/DC Public Reading Room hours of operation are 8:30 a.m. to 4:30 p.m., Monday through Friday, excluding legal holidays. The

telephone number of the EPA/DC Public Reading Room is (202) 566-1744, and the telephone number for the Air Docket is (202) 566-1742. These approved materials are also available for inspection at the National Archives and Records Administration (NARA). For information on the availability of this material at NARA, call (202) 741-6030 or go to [http://www.archives.gov/federal-register/code\\_of\\_federal\\_regulations/ibr\\_locations.html](http://www.archives.gov/federal-register/code_of_federal_regulations/ibr_locations.html). In addition, these materials are available from the sources listed below.

(1) *ASTM International material*. The following standards are available from ASTM International, 100 Barr Harbor Dr., P.O. Box C700, West Conshohocken, PA 19428-2959, (877) 909-ASTM, or <http://www.astm.org>:

(i) ASTM D2622-10, Standard Test Method for Sulfur in Petroleum Products by Wavelength Dispersive X-ray Fluorescence Spectrometry, approved February 15, 2010.

(ii) ASTM D4294-10, Standard Test Method for Sulfur in Petroleum and Petroleum Products by Energy Dispersive X-ray Fluorescence Spectrometry, approved February 15, 2010.

(iii) ASTM D5453-12, Standard Test Method for Determination of Total Sulfur in Light Hydrocarbons, Spark Ignition Engine Fuel, Diesel Engine Fuel, and Engine Oil by Ultraviolet Fluorescence, approved November 1, 2012.

(iv) ASTM D6920-13, Standard Test Method for Total Sulfur in Naphthas, Distillates, Reformulated Gasolines, Diesels, Biodiesels, and Motor Fuels by Oxidative Combustion and Electrochemical Detection, approved September 15, 2013.

(2) [Reserved]

■ 37. Section 80.585 is amended by revising paragraph (d)(4) to read as follows:

**§ 80.585 What is the process for approval of a test method for determining the sulfur content of diesel or ECA marine fuel?**

\* \* \* \* \*

(d) \* \* \*

(4) The approval of any test method under paragraph (b) of this section shall be valid for five years from the date of approval by the Administrator. After the five year period has ceased, in order for the test method approval to remain valid, the test method must be resubmitted for approval with applicable precision and accuracy information contained in § 80.584(a) and (b). If, however, the test method is later approved by a voluntary consensus-based standards body, the approval shall remain valid as long as

the conditions of paragraph (a) of this section are met.

\* \* \* \* \*

■ 38. Section 80.604 is amended by revising paragraphs (f)(3) and (f)(4) to read as follows:

**§ 80.604 What are the annual reporting requirements for refiners and importers of NRLM diesel fuel?**

\* \* \* \* \*

(f) \* \* \*

(3) Except for small refiners subject to § 80.554(d), submitted to EPA by September 1 each year for the prior annual compliance period. Small refiners subject to the provisions of § 80.554(d), reports must be submitted by September 1 for the previous reporting period.

(4) With the exception of reports required under paragraph (b)(3) of this section, no reports will be required under this section after September 1, 2014.

**Subpart L—[Amended]**

■ 39. Section 80.1235 is amended by revising paragraphs (a)(6) and (b)(2) to read as follows:

**§ 80.1235 What gasoline is subject to the benzene requirements of this subpart?**

(a) \* \* \*

(6) Blendstock that is combined with PCG to produce gasoline must be sampled and tested in accordance with the provisions at § 80.1347(a)(5) or (6).

(b) \* \* \*

(2) Oxygenate added to PCG downstream of the refinery that produced the PCG, or downstream of the import facility where the PCG was imported, shall not be included in a refiner's or importer's compliance calculations unless the refiner or importer that produced or imported the PCG complies with the requirements of § 80.1238(b). On any occasion where any person downstream of the refinery or importer that produced or imported PCG adds oxygenate to such product, it shall not include the volume and benzene content of the oxygenate in any compliance calculations or for credit generation under this subpart.

\* \* \* \* \*

■ 40. Section 80.1238 is amended by revising paragraph (b)(1) to read as follows:

**§ 80.1238 How is a refinery's or importer's average benzene concentration determined?**

\* \* \* \* \*

(b) \* \* \*

(1) For oxygenate added to conventional gasoline or CBOB, the

refiner or importer must comply with the requirements of § 80.101(d)(4)(ii). The benzene content of the oxygenate must be determined using the applicable test method at § 80.46 through December 31, 2015, and at § 80.47 beginning January 1, 2016.

\* \* \* \* \*

■ 41. Section 80.1347 is amended by revising paragraphs (a)(3)(i) and (a)(5) and adding paragraph (a)(6) to read as follows:

**§ 80.1347 What are the sampling and testing requirements for refiners and importers?**

(a) \* \* \*

(3)(i) Each sample shall be tested in accordance with the methodology specified at § 80.46(e) through December 31, 2015, to determine its benzene concentration for compliance with the requirements of this subpart. Beginning January 1, 2016, each sample shall be tested in accordance with the methodology specified at § 80.47 to determine its benzene concentration for compliance with the requirements of this subpart. Any negative test result must be reported as zero.

\* \* \* \* \*

(5) Previously certified gasoline (PCG) may be excluded as follows:

(i) Any refiner who uses PCG to produce gasoline at a refinery, must exclude the PCG for purposes of demonstrating compliance with the benzene standards at § 80.1230.

(ii) To accomplish the exclusion required in paragraph (a)(5)(i) of this section, the refiner must determine the volume and benzene content of the PCG used at the refinery and the volume and benzene content of gasoline produced at the refinery, and use the compliance calculation procedures in paragraphs (a)(5)(iii) and (iv) of this section.

(iii) For each batch of PCG that is used to produce gasoline the refiner must include the volume and benzene content of the PCG as a negative volume and a positive benzene content in the refiner's compliance calculations in accordance with the requirements at § 80.1238.

(iv) For each batch of gasoline produced at the refinery using PCG and blendstock, the refiner must determine the volume and benzene content of the combined product and include each batch for purposes of benzene compliance in the refinery's compliance calculations at § 80.1240 without regard to the presence of previously certified gasoline in the batch.

(v) The refiner must use any PCG that it includes as a negative batch in its compliance calculations pursuant to

§ 80.1240 as a component in gasoline production during the annual averaging period in which the PCG was included as a negative batch in the refiner's compliance calculations.

(vi) Any negative annual average value must be reported as zero.

(vii) The refiner must also comply with § 80.65(i) when producing RBOB or RFG and § 80.101(g)(9) when producing conventional gasoline.

(6) As an alternative to the sampling and testing requirements in paragraph (a)(5) of this section, a refiner who produces gasoline by blending one or more blendstocks into PCG may sample and test each batch of blendstock when received at the refinery to determine the volume and benzene content, and treat each blendstock receipt as a separate batch for purposes of demonstrating compliance with the benzene standards in § 80.1230, and for benzene reporting.  
\* \* \* \* \*

■ 42. Section 80.1348 is revised to read as follows:

**§ 80.1348 What gasoline sample retention requirements apply to refiners and importers?**

(a) Through December 31, 2015, the gasoline sample retention requirements specified in subpart H of this part for the gasoline sulfur provisions apply for the purpose of complying with the requirements of this subpart L, except that in addition to including the sulfur test result as provided by § 80.335(a)(4)(ii), the refiner, importer, or independent laboratory shall also include with the retained sample the test result for benzene as conducted pursuant to § 80.46(e).

(b) Beginning January 1, 2016, pursuant to § 80.47, the gasoline sample retention requirements specified in subpart O of this part for the gasoline

sulfur provisions apply for the purpose of complying with the requirements of this subpart L, except that in addition to including the sulfur test result as provided by § 80.335(a)(4)(ii), the refiner, importer, or independent laboratory shall also include with the retained sample the test result for benzene as conducted pursuant to § 80.47.

■ 43. A new § 80.1349 is added to subpart L to read as follows:

**§ 80.1349 Alternative sampling and testing requirements for importers who import gasoline into the United States by truck.**

Importers who import conventional gasoline into the United States by truck may comply with the sampling and testing requirements in § 80.101(i)(3) instead of the requirements to sample and test every batch of gasoline under § 80.1347. An importer that uses this approach must meet the 0.62 volume percent benzene standard on a per-gallon basis.

■ 44. Section 80.1354 is amended by revising paragraphs (b)(2) and (d)(2) to read as follows:

**§ 80.1354 What are the reporting requirements for the gasoline benzene program?**

\* \* \* \* \*

(b) \* \* \*  
(2)(i) The annual average benzene concentration, per § 80.1238, along with identification of the test method(s) used to measure the annual average benzene concentration.

(ii) The maximum average benzene concentration, per § 80.1240(b), along with identification of the test method(s) used to measure the maximum average benzene concentration.

\* \* \* \* \*

(d) \* \* \*

(2) Submitted to EPA by March 31 each year for the prior calendar year averaging period.

\* \* \* \* \*

**Subpart M—[Amended]**

■ 45. Section 80.1407 is amended by revising paragraph (c)(5) to read as follows:

**§ 80.1407 How are the Renewable Volume Obligations calculated?**

\* \* \* \* \*

(c) \* \* \*

(5) Blendstock (including butane, pentane, and gasoline treated as blendstock (GTAB)) that has been combined with other blendstock and/or finished gasoline to produce gasoline.

\* \* \* \* \*

■ 46. Section 80.1451 is amended by revising paragraphs (a)(1) introductory text and (f)(2) to read as follows:

**§ 80.1451 What are the reporting requirements under the RFS program?**

(a) \* \* \*

(1) Annual compliance reports for the previous compliance period shall be submitted by March 31 of each year, except as provided in paragraph (a)(1)(xiv) of this section, and shall include all the following information:

\* \* \* \* \*

(f) \* \* \*

(2) Quarterly reports shall be submitted by the required deadline as shown in Table 1 of this section. Any reports generated by EMTS must be reviewed, supplemented, and/or corrected if not complete and accurate, and verified by the owner or responsible corporate officer prior to submittal. Table 1 follows:

TABLE 1 TO § 80.1451—QUARTERLY REPORTING DEADLINES

Calendar quarter	Time period covered	Quarterly report deadline
Quarter 1 .....	January 1–March 31 .....	June 1.
Quarter 2 .....	April 1–June 30 .....	September 1.
Quarter 3 .....	July 1–September 30 .....	December 1.
Quarter 4 .....	October 1–December 31 .....	March 31.

\* \* \* \* \*

■ 47. Section 80.1464 is amended by revising paragraph (d) to read as follows:

**§ 80.1464 What are the attest engagement requirements under the RFS program?**

\* \* \* \* \*

(d) For each compliance year, each party subject to the attest engagement requirements under this section shall

cause the reports required under this section to be submitted to EPA by June 1 of the year following the compliance year, except as provided in paragraph (g) of this section.

\* \* \* \* \*

■ 48. A new subpart O is added to part 80 to read as follows:

**Subpart O—Gasoline Sulfur**

- Sec.
- 80.1600 Additional definitions for subpart O.
- 80.1601 Fuels subject to the provisions of this subpart.
- 80.1602 Applicability.
- 80.1603 Gasoline sulfur standards for refiners and importers.



- 80.1604 Gasoline sulfur standards and requirements for parties downstream of refiners and importers.
- 80.1605 Deficit carryforward for refiners and importers.
- 80.1606 [Reserved]
- 80.1607 Gasoline sulfur standards and requirements for transmix processors and transmix blenders.
- 80.1608 [Reserved]
- 80.1609 Oxygenate blender requirements.
- 80.1610 Standards and requirements for producers and importers of denatured fuel ethanol and other oxygenates designated for use in transportation fuel.
- 80.1611 Standards and requirements for certified ethanol denaturant.
- 80.1612 [Reserved]
- 80.1613 Standards and other requirements for gasoline additive manufacturers and blenders.
- 80.1614 [Reserved]
- 80.1615 Credit generation.
- 80.1616 Credit use and transfer.
- 80.1617–80.1619 [Reserved]
- 80.1620 Small refiner definition.
- 80.1621 Small volume refinery definition.
- 80.1622 Approval for small refiner and small volume refinery status.
- 80.1623–80.1624 [Reserved]
- 80.1625 Hardship provisions.
- 80.1626–80.1629 [Reserved]
- 80.1630 Sampling and testing requirements for refiners, gasoline importers and producers and importers of certified ethanol denaturant.
- 80.1631 Gasoline, RBOB, and CBOB sample retention requirements.
- 80.1632–80.1639 [Reserved]
- 80.1640 Standards and requirements that apply to refiners producing gasoline by blending blendstocks into previously certified gasoline (PCG).
- 80.1641 Alternative sulfur standards and requirements that apply to importers who transport gasoline by truck.
- 80.1642 Sampling and testing requirements for producers and importers of denatured fuel ethanol and other oxygenates for use by oxygenate blenders.
- 80.1643 Sample retention requirements for oxygenate producers and importers.
- 80.1644 Sampling and testing requirements for producers and importers of certified ethanol denaturant.
- 80.1645 Sample retention requirements for producers and importers of denaturant designated as suitable for the manufacture of denatured fuel ethanol meeting federal quality requirements.
- 80.1646–80.1649 [Reserved]
- 80.1650 Registration.
- 80.1651 Product transfer document requirements.
- 80.1652 Reporting requirements for gasoline refiners, gasoline importers, oxygenate producers, and oxygenate importers.
- 80.1653 Recordkeeping.
- 80.1654 California gasoline requirements.
- 80.1655 National security exemption.
- 80.1656 Exemptions for gasoline used for research, development, or testing purposes.
- 80.1657 [Reserved]
- 80.1658 Requirements for gasoline for use in American Samoa, Guam, and the

Commonwealth of the Northern Mariana Islands.

- 80.1659 [Reserved]
- 80.1660 Prohibited acts.
- 80.1661 What evidence may be used to determine compliance with the prohibitions and requirements of this subpart and liability for violations of this subpart?
- 80.1662 Liability for violations.
- 80.1663 Defenses for a violation of a prohibited act.
- 80.1664 [Reserved]
- 80.1665 Penalties.
- 80.1666 Additional requirements for foreign small refiners and foreign small volume refineries.
- 80.1667 Attest engagement requirements.

### Subpart O—Gasoline Sulfur

#### § 80.1600 Additional definitions for subpart O.

The definitions of § 80.2 and the following additional definitions apply to this subpart O:

*California gasoline* means any gasoline designated by a refiner or importer for use in California.

*Certified ethanol denaturant* means ethanol denaturant that meets the requirements of § 80.1611.

*Certified Sulfur-FRGAS* has the meaning given in § 80.1666(a)(5).

*Denatured fuel ethanol (DFE)* means an alcohol of the chemical formula  $C_2H_6O$  which contains a denaturant to make it unfit for human consumption, that is produced or imported for use in motor gasoline, and that meets the requirements of § 80.1610.

*Ethanol denaturant* means previously certified gasoline (including previously certified blendstocks for oxygenate blending), gasoline blendstocks, or natural gasoline liquids that are added to neat (un-denatured) ethanol to make it unfit for human consumption in accordance with the requirements of the Alcohol and Tobacco Tax and Trade Bureau of the U.S. Treasury Department.

*Foreign refiner* is a person who meets the definition of refiner under § 80.2(i) for a foreign refinery.

*Foreign refinery* means a refinery that is located outside the United States. Note that the United States includes the Commonwealth of Puerto Rico, the Virgin Islands, Guam, American Samoa, and the Commonwealth of the Northern Mariana Islands.

*Non-Certified Sulfur-FRGAS* has the meaning given in § 80.1666(a)(6).

*Non-Sulfur-FRGAS* has the meaning given in § 80.1666(a)(4).

*Sulfur-FRGAS* has the meaning given in § 80.1666(a)(3).

*Transmix* has the meaning given at § 80.84(a)(2).

*Transmix blender* has the meaning given at § 80.84(a)(7).

*Transmix gasoline product (TGP)* has the meaning given at § 80.84(a)(3).

*Transmix processing facility* has the meaning given at § 80.84(a)(4).

*Transmix processor* has the meaning given at § 80.84(a)(5).

#### § 80.1601 Fuels subject to the provisions of this subpart.

(a) For the purposes of this subpart, the following fuels are subject to the standards and requirements of this subpart:

(1) Reformulated and conventional gasoline and RBOB, and CBOB (collectively called “gasoline” unless otherwise specified).

(2) Any blendstock blended with PCG, as defined in § 80.2(d).

(3) Oxygenates blended with gasoline, RBOB, or CBOB.

(b) For the purposes of this subpart, the following fuels are not subject to the standards and requirements of this subpart:

(1) Gasoline that is used to fuel aircraft, racing vehicles or racing boats that are used only in sanctioned racing events, provided that—

(i) Product transfer documents associated with such gasoline, and any pump stand from which such gasoline is dispensed, identify the gasoline either as gasoline that is restricted for use in aircraft, or as gasoline that is restricted for use in racing motor vehicles or racing boats that are used only in sanctioned racing events;

(ii) The gasoline is completely segregated from all other gasoline throughout production, distribution and sale to the ultimate consumer; and

(iii) The gasoline is not made available for use as motor vehicle gasoline, or dispensed for use in motor vehicles, except for motor vehicles used only in sanctioned racing events.

(2) California gasoline as defined in § 80.1600 subject to the provisions of § 80.1654.

(3) Gasoline that is exported for sale and use outside the United States.

(4) Exempt fuels under §§ 80.1655 (national security exemptions), 80.1656 (gasoline used for research, development, or testing purposes), and 80.1658 (gasoline used in American Samoa, Guam, and the Northern Mariana Islands).

#### § 80.1602 Applicability.

(a) The provisions of this subpart O shall apply beginning January 1, 2017, unless otherwise provided.

(b) The standards and requirements for gasoline sulfur under subpart H of this part shall continue to apply until the gasoline produced or imported by any refiner or importer is required to

comply with the standards and requirements under this subpart O.

**§ 80.1603 Gasoline sulfur standards for refiners and importers.**

(a) *Sulfur standards.* (1) *Annual average standard.* (i) The refinery or importer annual average gasoline sulfur standard is 10.00 parts per million (ppm) or milligrams per kilogram (mg/kg), except as provided in paragraph (a)(1)(iii) of this section.

(ii) The averaging period is a calendar year (January 1 through December 31).

(iii) The refinery or importer annual average gasoline sulfur standard is the maximum average sulfur level allowed for gasoline produced at a refinery or imported by an importer during each calendar year beginning January 1, 2017, except as provided by the following:

(A) The credit use provisions of § 80.1616.

(B) Beginning January 1, 2020, for small refiners and small volume refineries approved pursuant to the provisions of § 80.1622. Small refiners and small volume refineries will continue to be subject to the provisions of subpart H of this part through December 31, 2019 (or until compliance with this subpart O begins).

(C) Fuels not subject to the standards and requirements of this subpart O as specified in § 80.1601(b).

(iv) The annual average sulfur level is calculated in accordance with paragraph (c) of this section.

(2) *Per-gallon cap standard.* (i) The refinery or importer per-gallon cap standard is 80 ppm, on a per-gallon basis except as otherwise provided by this section.

(ii) The per-gallon cap of paragraph (a)(2)(i) of this section is the maximum sulfur level allowed for any batch of gasoline produced at a refinery or imported by an importer beginning January 1, 2017, except for fuels not subject to the standards and requirements of this subpart O as specified in § 80.1601(b).

(3) *Use of credits.* The refinery or importer annual average gasoline sulfur standard may be met using credits as provided under § 80.1616. Credits cannot be used to meet the applicable per-gallon standard.

(b) [Reserved]

(c) *Calculation of the annual average sulfur level.* (1) The annual refinery or importer average gasoline sulfur level is calculated as follows:

$$S_a = \frac{\sum_{i=1}^n (V_i \times S_i)}{\sum_{i=1}^n V_i}$$

Where:

Sa = The refinery or importer annual average sulfur level, in ppm (mg/kg).

Vi = The volume of gasoline produced or imported in batch i, in gallons.

Si = The sulfur content of batch i determined under § 80.1630, in ppm (mg/kg).

n = The number of batches of gasoline produced or imported during the averaging period.

i = Individual batch of gasoline produced or imported during the averaging period.

(2) The annual average sulfur level calculation in paragraph (c)(1) of this section shall be conducted to two decimal places using the rounding procedure specified in § 80.9.

(d) *Oxygenate added downstream from the refinery or import facility.* A refiner or importer may include oxygenate added downstream from the refinery or import facility when calculating the sulfur content of a batch, provided that the following requirements are met:

(1) For oxygenate added to reformulated gasoline, RBOB, conventional gasoline, or CBOB, the refiner or importer shall calculate the sulfur content of the batch by volume weighting the sulfur content of the conventional gasoline or CBOB and the sulfur content of the added oxygenate pursuant to the following requirements:

(i) The sulfur content of any reformulated gasoline, RBOB, conventional gasoline, or CBOB shall be determined by sampling and testing each batch pursuant to § 80.46 or § 80.47 as applicable.

(ii) For each complete annual compliance period, the sulfur content of all the oxygenate added downstream of the refinery or import facility shall be determined by one of the following methods:

(A) Testing the sulfur content of a sample of the oxygenate pursuant to § 80.46 or § 80.47, as applicable. The refiner or importer must demonstrate through records relating to sampling, testing, and blending that the test result was derived from a representative sample of the oxygenate that was blended with the batch of gasoline or BOB.

(B) If the oxygenate is denatured fuel ethanol, the sulfur content may be assumed to be 5.00 ppm.

(iii) For denatured fuel ethanol, the refiner or importer may assume that the denatured fuel ethanol was blended with gasoline or BOB at a concentration of 10 volume percent, unless the refiner or importer can demonstrate that a different amount of denatured fuel ethanol was actually blended with a batch of gasoline or BOB.

(iv) The refiner or importer of conventional gasoline or CBOB must

comply with the requirements of § 80.101(d)(4)(ii).

(v) The refiner or importer of reformulated gasoline or RBOB must comply with the requirements of § 80.69(a).

(vi) Any reformulated gasoline, RBOB, conventional gasoline, or CBOB must meet the per-gallon sulfur standard of paragraph (a)(2) of this section prior to calculating any dilution from the oxygenate added downstream.

(vii) The reported volume of the batch is the combined volume of the reformulated gasoline, RBOB, conventional gasoline, or CBOB and the downstream added oxygenate.

(2) The refiner or importer who first certifies the gasoline, CBOB, or RBOB is the only person who may account for the downstream addition of oxygenate pursuant to the requirements of paragraph (d) of this section. On any occasion where any person downstream of the refinery or importer that produced or imported previously certified gasoline, CBOB or RBOB adds oxygenate to such product, it shall not include the volume and sulfur content of the oxygenate in any compliance calculations or for credit generation under this subpart O.

(e) *Exclusions.* Refiners and importers must exclude from compliance calculations all the following:

(1) Gasoline that was not produced at the refinery or imported by the importer.

(2) In the case of an importer, gasoline that was imported as Certified Sulfur-FRGAS.

(3) Blendstocks transferred to others, except RBOB and CBOB as provided in this subpart O.

(4) Previously certified gasoline (PCG).

(5) Gasoline exempted from standards under § 80.1601(b).

(f) *Compliance calculation for the annual average sulfur standard.* (1) Compliance by a refinery or importer with the gasoline sulfur annual average standard at paragraph (a)(1) of this section is achieved if, for calendar year y, the compliance sulfur value is less than or equal to 10 times the total gasoline volume produced or imported, as determined by the following equation:

$$CSV_y = (V_y \times S_a) + D(y-1) - OC$$

Where:

CSV<sub>y</sub> = Compliance sulfur value for year y, in ppm-gallons.

V<sub>y</sub> = Total gasoline volume produced or imported in year y, in gallons.

S<sub>a</sub> = Annual average sulfur level calculated in accordance with paragraph (c) of this section, in ppm (mg/kg).

D(y-1) = Sulfur deficit from the previous reporting period, per § 80.1605, in ppm-gallons.

OC = Sulfur credits obtained by the refinery or importer, in ppm-gallons.

(2) Sulfur credits used in the calculation specified in paragraph (f)(1) of this section must be used in accordance with the requirements at § 80.1616.

(3) Compliance with the gasoline sulfur annual average standard at paragraph (a)(1) of this section is not achieved, and a deficit is created per § 80.1605, if for calendar year *y*, the compliance sulfur value is greater than 10 times the total gasoline volume produced or imported. The deficit value to be included in the following year's compliance calculation per paragraph (f) of this section is calculated as follows:

$$D_y = CSV_y - (V_y \times 10y)$$

Where:

$D_y$  = Sulfur deficit created in compliance period *y*, in ppm-gallons.

**§ 80.1604 Gasoline sulfur standards and requirements for parties downstream of refiners and importers.**

(a) The sulfur standard for gasoline at any downstream location shall be determined in accordance with the provisions of this section. A downstream location is any point in the gasoline distribution system downstream from refineries and import facilities, including, but not limited to, facilities of any of the following parties:

- (1) Distributors.
- (2) Carriers.
- (3) Oxygenate blenders.
- (4) Retailers.
- (5) Wholesale purchaser-consumers.

(b) Except as otherwise provided in this subpart O, the sulfur content of gasoline at any downstream location shall not exceed 95 ppm, on a per-gallon basis, beginning January 1, 2017.

**§ 80.1605 Deficit carryforward for refiners and importers.**

(a) *Deficit carryforward.* A refiner or importer may exceed the annual average sulfur standard for a given calendar year, creating a compliance deficit, provided that, in the calendar year following the year the standard is not met, the refinery or importer—

(1) Achieves compliance with the annual average sulfur standard in § 80.1603(a)(1); and

(2) Uses additional sulfur credits sufficient to offset the compliance deficit of the previous year.

(b) The compliance deficit value shall be calculated in accordance with § 80.1603(f)(3).

**§ 80.1606 [Reserved]**

**§ 80.1607 Gasoline sulfur standards and requirements for transmix processors and transmix blenders.**

Transmix processors and transmix blenders may comply with the following sampling and testing requirements and standards instead of the sampling and testing requirements and standards otherwise applicable to a refiner under this subpart O.

(a) Any transmix processor who recovers transmix gasoline product (TGP) from transmix through transmix processing under § 80.84(c) must show through sampling and testing (using the methods in § 80.1630) that the TGP meets the applicable sulfur standards under § 80.1604(b), prior to the TGP leaving the transmix processing facility.

(b) The sampling and testing required under paragraph (a) of this section shall be conducted following each occasion TGP is produced.

(c) Any transmix processor who produces gasoline by adding blendstock to TGP must, for such blendstock, comply with all requirements and standards that apply to a refiner under this subpart O, and must meet the downstream sulfur standards under § 80.1604 for the gasoline produced by blending blendstock and TGP, prior to the gasoline leaving the transmix processing facility.

(d) Any transmix processor who produces gasoline by blending blendstock into TGP must meet the sampling and testing requirements of this subpart O using one of the following methods:

(1) *Option 1.* (i) Sample and test the blendstock that will be added to TGP during the compliance year when received at the transmix processing facility, using the methods specified in § 80.1630, to determine the volume and sulfur content, and treat each volume of blendstock that is blended into a volume of TGP as a separate batch for purposes of calculating and reporting compliance with the applicable annual average and per-gallon cap sulfur standards in § 80.1603.

(ii) Use sulfur test results of the blendstock supplier provided that all the following requirements are met:

(A) Sampling and testing by the blendstock supplier is performed using the methods specified in § 80.1630.

(B) Testing for the sulfur content of the blendstock in the supplier's storage tank must be conducted following the last receipt of blendstock into the supplier's storage tank that supplies the transmix processor.

(C) The transmix processor must obtain a copy of the blendstock

supplier's test results, reflecting the sulfur content of each load of blendstock supplied to the transmix processor, at the time of each transfer of blendstock to the transmix processor.

(D) The transmix processor must conduct a quality assurance program of sampling and testing for each blendstock supplier. The frequency of blendstock sampling and testing must be one sample for every 500,000 gallons of blendstock received or one sample every 3 months, whichever results in more frequent sampling.

(iii) If any of the requirements of paragraph (d)(1)(ii) of this section are not met, in whole or in part, for any blendstock blended into TGP, the gasoline produced with that blendstock is deemed in violation of the gasoline sulfur standards of this subpart O.

(2) *Option 2.* (i) Sample and test each batch of TGP and determine the volume of the TGP.

(ii) Sample and test the gasoline produced by blending blendstock into TGP, and determine its volume.

(iii) Calculate the sulfur content and the volume of the batch by subtracting the volume and sulfur content of the TGP from the volume and sulfur content of the gasoline after blendstock blending. For purposes of compliance and reporting, the sulfur content shall be the calculated volume and sulfur content of the blendstock, and the applicable standards shall be the average and cap standards in § 80.1603. The applicable cap standard of the gasoline blend shall be the cap standard under § 80.1604.

(iv) Tests shall be performed using the methods specified in § 80.1630, to determine the sulfur content of the batch.

(v) The sulfur content of each batch of gasoline produced by blending blendstock into TGP must be no greater than the downstream sulfur standard under § 80.1604 applicable to the designation of the TGP.

(e) Any transmix blender who produces gasoline by blending transmix, or mixtures of gasoline and distillate fuel described in § 80.84(e), into previously certified gasoline under § 80.84(d) must meet the applicable downstream sulfur standards under § 80.1604 for the gasoline produced by blending transmix and previously certified gasoline and the endpoint standard specified in § 80.84.

(f) Any transmix processor or transmix blender who adds any feedstock to its transmix other than gasoline, distillate fuel, or gasoline blendstocks from pipeline interface must meet all requirements and standards that apply to a refiner under

this subpart O for all gasoline it produces during a compliance period.

**§ 80.1608 [Reserved]**

**§ 80.1609 Oxygenate blender requirements.**

(a) Oxygenate blenders who blend only oxygenate that complies with the requirements of paragraph (b) of this section into gasoline downstream of the refinery that produced the gasoline or the import facility where the gasoline was imported are not subject to the refiner or importer requirements of this subpart for such gasoline, but are subject to the requirements and prohibitions applicable to downstream parties in this subpart. Such oxygenate blenders are subject to the requirements of paragraph (b) of this section, the requirements and prohibitions applicable to downstream parties, the requirements of § 80.1603(d)(4), and the prohibition specified in § 80.1660(e).

(b) Beginning January 1, 2017, the DFE or other oxygenate used must comply with the requirements of § 80.1610 and all of the other requirements of this subpart O. Prior to January 1, 2017, DFE is subject to the sulfur requirements of § 80.385(e).

**§ 80.1610 Standards and requirements for producers and importers of denatured fuel ethanol and other oxygenates designated for use in transportation fuel.**

Beginning January 1, 2017, producers and importers of denatured fuel ethanol (DFE) or other oxygenates designated for use in transportation fuel must comply with the following requirements:

(a) *Standards.* (1) The sulfur content must not be greater than 10 ppm.

(2) The DFE or other oxygenate must be composed solely of carbon, hydrogen, nitrogen, oxygen and sulfur.

(3) In the case of DFE, only previously certified gasoline (including previously certified blendstocks for oxygenate blending), gasoline blendstocks, or natural gas liquids may be used as denaturants.

(4) The concentration of all denaturants used in DFE is limited to a maximum of 3.0 volume percent.

(b) *Registration.* Unless registered under § 80.1450, the producer or importer of DFE or other oxygenate must register with EPA pursuant to the requirements of § 80.1650.

(c) *PTDs.* In addition to any other product transfer document requirements under this part, on each occasion when any person transfers custody or title to any oxygenate upstream of any oxygenate blending facility, the transferor shall provide to the transferee product transfer documents which include the following information:

(1) For DFE, “Denatured fuel ethanol, maximum 10 ppm sulfur.”; or

(2) For oxygenates other than DFE, The name of the specific oxygenate must be identified on the PTD, followed by “maximum 10 ppm sulfur”.

(3) PTDs that are complaint with the requirements in paragraph (c) of this section must be transferred from each party transferring oxygenate to each party that receives oxygenate through to the oxygenate blender.

(4) Alternative PTD language to that specified in paragraphs (c)(1) and (2) of this section may be used as approved by EPA.

(d) *Batch numbers.* Every batch of oxygenate produced or imported at oxygenate production or import facility shall be assigned a number (the “batch number”), consisting of the EPA-assigned oxygenate producer or importer registration number, the EPA facility registration number, the last two digits of the year in which the batch was produced, and a unique number for the batch, beginning with the number one for the first batch produced or imported each calendar year and each subsequent batch during the calendar year being assigned the next sequential number (e.g., 4321–54321–95–000001, 4321–54321–95–000002, etc.). An alternative batch numbering protocol may be used as approved by the Administrator.

(e) *Annual Reports.* Submit annual reports to EPA pursuant to the requirements of § 80.1652.

**§ 80.1611 Standards and requirements for certified ethanol denaturant.**

Producers and importers of ethanol denaturant that is suitable for the manufacture of denatured fuel ethanol (DFE) meeting federal quality requirements may designate the denaturant as certified ethanol denaturant if the following requirements are met.

(a) *Standards.* (1) The sulfur content must not be greater than 330 ppm as determined in accordance with the test requirements of § 80.1630. If the denaturant manufacturer represents a batch of denaturant as having a sulfur content of less than 330 ppm in the PTD, then the actual sulfur content must be no greater than the stated value as determined in accordance with the requirements of § 80.1644.

(2) The ethanol denaturant must be composed solely of carbon, hydrogen, nitrogen, oxygen and sulfur.

(3) Only previously certified gasoline (including previously certified blendstocks for oxygenate blending), gasoline blendstocks, or natural gas liquids may be used as denaturants.

(b) *Registration.* Unless registered under § 80.76, § 80.103, or § 80.1450, the producer or importer of ethanol denaturant must register with EPA pursuant to the requirements of § 80.1650.

(c) *PTDs.* In addition to any other product transfer document requirements under this part 80, on each occasion when any person transfers custody or title to any ethanol denaturant designated as suitable for the production of DFE meeting federal quality requirements upstream of a DFE production or import facility, the transferor shall provide to the transferee product transfer documents which include all the following information.

(1) The following statement: “Certified Ethanol Denaturant suitable for use in the manufacture of denatured fuel ethanol meeting EPA standards.”.

(2) If the certified ethanol denaturant manufacturer represents that a batch of ethanol denaturant has sulfur content less than 330 ppm, then either the actual sulfur content of the denaturant must be clearly stated on the PTD, or the PTD must state the sulfur content is 330 ppm or less.

(3) Alternative PTD language to that specified in paragraph (c)(1) of this section may be used as approved by EPA.

(d) *Batch numbers.* Every batch of certified ethanol denaturant produced or imported at oxygenate production or import facility shall be assigned a number (the “batch number”), consisting of the EPA-assigned ethanol denaturant producer or importer registration number, the EPA facility registration number, the last two digits of the year in which the batch was produced, and a unique number for the batch, beginning with the number one for the first batch produced or imported each calendar year and each subsequent batch during the calendar year being assigned the next sequential number (e.g. 4321–54321–95–000001, 4321–54321–95–000002, etc.).

**§ 80.1612 [Reserved]**

**§ 80.1613 Standards and other requirements for gasoline additive manufacturers and blenders.**

Gasoline additive manufacturers and blenders must meet the following requirements:

(a) Gasoline additive manufacturers, as defined in 40 CFR 79.2(f), who manufacture additives with a maximum allowed treatment rate of 1.0 volume percent or less must meet all the following requirements:

(1) The additive must contribute no more than 3 ppm on a per gallon basis

to the sulfur content of gasoline when used at the maximum recommended treatment rate.

(2) The additive manufacturer must maintain records of its additive production quality control activities which demonstrates that the sulfur content of additive production batches complies with the sulfur requirement in paragraph (a)(1) of this section and make these records available to EPA upon request.

(3) The maximum treatment rate on the product transfer document for the additive must state all the following:

(i) The maximum registered concentration.

(ii) The maximum allowed treatment rate which corresponds to the maximum registered concentration. The maximum allowed concentration must be less than 1.0% by volume.

(b) Any person who blends an additive that meets the requirements of paragraph (a) in this section into PCG is not subject to any requirement of this subpart O, except the downstream gasoline sulfur standard of § 80.1604(b) and the prohibition in § 80.1660(f), if all the following conditions are met:

(1) The person blends the additive to PCG at a concentration of less than 1.0% by volume.

(2) The person does not add any other blendstock or additive except for oxygenates meeting the requirements of § 80.1610 and additives meeting the requirements of this section to PCG.

(c) Any person who blends any additive that does not meet the requirements of paragraphs (a) and (b) of this section, is subject to all of the requirements of this subpart O, including the standards and requirements at § 80.1640 that apply to refiners producing gasoline by blending blendstocks into PCG.

(d) Oxygenates subject to the 10 ppm per-gallon sulfur standard and the requirements of § 80.1610 are not subject to the provisions of this section. On any occasion where the additive blender is solely acting as an oxygenate blender, as defined in § 80.2(mmm), it is subject to the downstream gasoline sulfur standard of § 80.1604(b) and the prohibition in § 80.1660(e).

#### § 80.1614 [Reserved]

#### § 80.1615 Credit generation.

(a) Any of the following entities may generate credits under this subpart O:

(1) U.S. refiners, including small refiners under § 80.1620, and refiners owning small volume refineries under § 80.1621.

(2) Importers.

(3) Credits may not be generated by transmix processors, producers or

blenders of ethanol and other oxygenates, butane blenders using the flexibilities in § 80.82, or pentane blenders using the flexibilities in § 80.85.

(b) Beginning with the 2014 annual averaging period, the number of credits generated for use in complying with the annual average standards of either subpart H of this part or § 80.1603(a) shall be calculated annually for each applicable averaging period according to the following equation (pursuant to § 80.310):

$$CR_a = V_a \times (S_{C_{credit}} - S_a)$$

Where:

$CR_a$  = Credits generated for the averaging period.

$V_a$  = Total annual volume of gasoline produced at a refinery or imported during the averaging period.

$S_{C_{credit}}$  = 30.00 ppm.

$S_a$  = Actual annual average sulfur level, calculated in accordance with the provisions of § 80.205, for gasoline produced at a refinery or imported during the averaging period, exclusive of any credits. The value of  $S_a$  must be less than 30.00.

(c) Except as provided in paragraph (d) of this section, beginning with the 2017 annual averaging period, the number of credits generated for use in complying with the annual average standards of § 80.1603(c)(1) shall be calculated annually for each applicable averaging period according to the following equation:

$$CR_a = V_a \times (10 - S_a)$$

Where:

$CR_a$  = Credits generated for the averaging period for use in complying with the annual average standards of § 80.1603(a).

$V_a$  = Total annual volume of gasoline produced at a refinery or imported during the averaging period.

$S_a$  = Actual annual average sulfur level, calculated in accordance with the provisions of § 80.1603(c)(1), for gasoline produced at a refinery or imported during the averaging period, exclusive of any credits. The value of  $S_a$  must be less than 10.00.

(d) For approved small refiners and small volume refineries only, the number of credits generated from January 1, 2017 through December 31, 2019 shall be calculated annually for each applicable averaging period as follows:

(1) If a small refiner or small volume refiner has an annual average sulfur level ( $S_a$ ) less than 30.00 ppm but greater than 10.00 ppm from January 1, 2017 through December 31, 2019, the refiner may generate credits using the equation specified in paragraph (b) of this section for use in complying with

the annual average standards of subpart H of this part.

(2) If a small refiner or small volume refinery has an annual average sulfur level ( $S_a$ ) less than 10.00 ppm from January 1, 2017 through December 31, 2019, the refiner may generate credits using the equation specified in paragraph (c) of this section for use in complying with the annual average standards of § 80.1603(c)(1) and the following equation for complying with the annual average standards of subpart H of this part:

$$CR_{T2} = V_a \times (20.00)$$

Where:

$CR_{T2}$  = Credits generated for the averaging period for use in complying with the annual average standards of subpart H of this part only.

$V_a$  = Total annual volume of gasoline produced at a refinery or imported during the averaging period.

(For example: A small refiner with an annual average sulfur level of 8 ppm in 2018 may generate  $CR_a = 2$  ppm-volume credits (10–8) for compliance with the annual average standards of § 80.1603(c)(1) plus  $CR_{T2} = 20$  ppm-volume credits (30–10) for compliance with the annual average sulfur standards of subpart H of this part.)

(3) Beginning January 1, 2020, small refiners and small volume refineries must follow paragraph (c) of this section for calculating credits under this subpart O.

(e) No credits shall be generated—

(1) Under paragraphs (b), (c) and (d) of this section unless the value of  $CR_a$  is positive.

(2) Under paragraph (d)(2) of this section unless the value of  $CR_{T2}$  is positive.

(f) The values of  $CR_a$  and  $CR_{T2}$  shall be rounded to the nearest ppm-gallon in accordance with the rounding procedure specified in § 80.9.

(g) A refiner or importer that includes downstream added oxygenates in its RFG or conventional gasoline volume under the provisions of §§ 80.69 and 80.101(d)(4), respectively and §§ 80.340 and 80.1603(d), shall include the downstream added oxygenate for the purpose of generating credits under paragraphs (b) through (d) of this section.

#### § 80.1616 Credit use and transfer.

(a) *Credit use.* (1) Only refiners and importers may generate, use, transfer or own credits generated under this subpart O.

(2)  $CR_a$  credits generated pursuant to subpart H of this part in the 2012 and 2013 averaging periods and generated pursuant to § 80.1615 may be used by

refiners and importers to meet the applicable annual average sulfur standards of § 80.1603(a)(1).

(3) CR<sub>a</sub> credits generated under § 80.1615 may be used to meet the requirements of either subpart H of this part or this subpart O, subject to the credit life restrictions in paragraph (b) of this section.

(5) Credits generated under § 80.1615(c) may only be used to meet the requirements of this subpart O.

(6) CR<sub>T2</sub> credits generated under § 80.1615(d) may only be used to meet the requirements of subpart H of this part.

(b) *Credit life.* (1) Except as provided in paragraph (b)(2) of this section, credits are valid for use for five years after the year in which they are generated.

(2) Credits generated under § 80.1615(b) through (d) are valid for use for five years after the year in which they are generated, except that any CR<sub>a</sub> credits generated in 2015 and 2016 and any remaining CR<sub>T2</sub> credits will expire and become invalid after March 31, 2020, when the 2019 annual compliance report is due.

(3) A refiner or importer possessing credits must use all credits prior to falling into a compliance deficit.

(4) In no case may a credit be transferred more than twice before being used or terminated.

(c) *Credit transfers.* (1) Credits obtained from other refiners or importers may be used to meet the annual average standards of this subpart O, if all the following conditions are met:

(i) The credits are generated and reported according to the requirements of this subpart O.

(ii) The credits are used in compliance with the limitations regarding the appropriate periods for credit use pursuant to paragraph (a) of this section.

(iii) Any credit transfer takes place by March 31 following the calendar year averaging period when the credits are used.

(iv) The credit has not been transferred between EPA registered companies more than twice. The first transfer by the refiner or importer who generated the credit (“transferor”) may only be made to a refiner or importer who intends to use the credit (“transferee”); if the transferee cannot use the credit, it may make the second, and final, transfer only to a refiner or importer who intends to use the credit. Credit transfers that occur within a company are unlimited.

(v) The credit transferor must apply any credits necessary to meet the

transferor’s applicable average standard before transferring credits to any other refiner or importer.

(vi) The credit transferor does not create a negative credit balance as a result of the credit transfer.

(vii) Each transferor must supply to the transferee records indicating all the following:

(A) The years the credits were generated.

(B) The identity of the refiner or importer who generated the credits.

(C) The identity of the transferring party (if it is not the same party that generated the credits).

(2) In the case of credits that have been calculated or created improperly, or are otherwise determined to be invalid, all the following provisions apply:

(i) Invalid credits cannot be used to achieve compliance with the transferee’s averaging standard, regardless of the transferee’s good faith belief that the credits were valid.

(ii) The refiner or importer who used the credits, and any transferor of the credits, must adjust their credit records and reports and sulfur calculations as necessary to reflect the proper credits.

(iii) Any properly created credits existing in the transferor’s credit balance after correcting the credit balance, and after the transferor applies credits as needed to meet the average standard at the end of the compliance year, must first be applied to correct the invalid transfers before the transferor trades or banks the credits.

(3) CR<sub>T2</sub> credits generated under § 80.1615(d) from January 1, 2017 through December 31, 2019 may only be traded to and ultimately used from January 1, 2017 through December 31 by small refiners and small volume refineries approved under § 80.1622.

#### §§ 80.1617–80.1619 [Reserved]

#### § 80.1620 Small refiner definition.

(a) For the purposes of this subpart O, a gasoline small refiner is defined as any refiner who meets all the following criteria and has been approved by EPA as a small refiner per § 80.1622:

(1) Produces gasoline at its refineries by processing crude oil through refinery processing units.

(2) Employed an average of no more than 1,500 people, based on the average number of employees for all pay periods for calendar year 2012 for all subsidiary companies, all parent companies, all subsidiaries of the parent companies, and all joint venture partners.

(3) Had a corporate-average crude oil capacity less than or equal to 155,000 barrels per calendar day (bpcd) for 2012.

(b) For the purposes of this section, the term “refiner” shall include foreign refiners.

(c) The number of employees and crude oil capacity under paragraph (a) of this section shall be determined as follows:

(1) The refiner shall include the employees and crude oil capacity of any subsidiary companies, any parent company and subsidiaries of the parent company in which the parent has 50 percent or greater ownership, and any joint venture partners.

(2) For any refiner owned by a governmental entity, the number of employees and total crude oil capacity as specified in paragraph (a) of this section shall include all employees and crude oil production of the government to which the governmental entity is a part.

(d) Notwithstanding the provisions of paragraphs (a) and (e)(1) of this section, a refiner that acquires or reactivates a refinery that was shut down or non-operational during calendar year 2011, may apply for small refiner status under this subpart O.

(e) The following are ineligible for small refiner provisions under this subpart O:

(1) Refiners with refineries built or started up on or after January 1, 2012.

(2) Persons who exceed the employee or crude oil capacity criteria under this section on January 1, 2012, but who meet these criteria after that date, regardless of whether the reduction in employees or crude oil capacity is due to operational changes at the refinery or a company sale or reorganization.

(3) Importers.

(4) Refiners who produce gasoline other than by processing crude oil through refinery processing units.

(f)(1) A refiner approved as a small refiner under § 80.1622 who subsequently ceases production of gasoline from processing crude oil through refinery processing units, employs more than 1,500 people, or exceeds the 155,000 bpcd crude oil capacity limit after January 1, 2012 as a result of merger with or acquisition of or by another entity, is disqualified as a small refiner, except as provided for under paragraph (f)(4) of this section. If such disqualification occurs, the refiner shall notify EPA in writing no later than 20 days following the disqualifying event.

(2) Except as provided under paragraph (f)(3) of this section, any refiner whose status changes under this paragraph (f) shall meet the applicable standards of § 80.1603 within a period of up to 30 months from the disqualifying event for any of its

refineries that were previously subject to the small refiner standards of § 80.1623.

(3) A refiner may apply to EPA for up to an additional six months to comply with the standards of § 80.1603 if more than 30 months would be required for the necessary engineering, permitting, construction, and start-up work to be completed. Such applications must include detailed technical information supporting the need for additional time. EPA will base a decision to approve additional time on information provided by the refiner and on other relevant information.

(4) Disqualification under this paragraph (f) of this section shall not apply in the case of a merger between two previously approved small refiners.

(5) If a refiner receives a delay per paragraphs (f)(2) and/or (f)(3) of this section, the refiner may not generate gasoline sulfur credits under this subpart O during that 30 or 36 month period.

(6) All written notifications to EPA should be submitted to the address listed in § 80.1622.

**§ 80.1621 Small volume refinery definition.**

(a) For the purposes of this subpart O, a gasoline small volume refinery is defined as any refinery that meets all the following criteria, and has been approved by EPA as a small volume refinery per § 80.1622:

(1) Produces gasoline by processing crude oil through refinery processing units.

(2) The average aggregate daily crude oil throughput, including feedstocks derived from crude oil, for the calendar year 2012 (as determined by dividing the aggregate throughput for the calendar year by the number of days in the calendar year) does not exceed 75,000 barrels. Throughput means the total crude oil feedstock input into the refinery less volumes injected into the crude oil supply after refinery processing.

(b) The following are ineligible for the small volume refinery provisions under this subpart O:

(1) Refineries built or started up on or after January 1, 2013.

(2) Persons who exceed the crude oil throughput under this section for calendar year 2012 but who meet these criteria after that date, regardless of whether the reduction in crude oil capacity is due to operational changes at the refinery or a company sale or reorganization.

(3) Importers.

(4) Refineries that produce gasoline other than by processing crude oil through refinery processing units.

**§ 80.1622 Approval for small refiner and small volume refinery status.**

(a) Applications for small refiner or small volume refinery status under this subpart O must be submitted to EPA by January 1, 2015.

(b) To qualify for small refiner status under this subpart a refiner must submit an application to EPA containing all the following information for the refiner and for all subsidiary companies, all parent companies, all subsidiaries of the parent companies, and all joint venture partners:

(1)(i) A listing of the name and address of all company locations for the period January 1, 2012 through December 31, 2012.

(ii) The average number of employees at each location, based on the number of employees for each pay period for the period January 1, 2012 through December 31, 2012.

(iii) The type of business activities carried out at each location.

(iv) For joint ventures, the total number of employees includes the combined employee count of all corporate entities in the venture.

(v) For government-owned refineries, the total employee count includes all government employees.

(2)(i) The total corporate crude oil capacity of each refinery as reported to the Energy Information Administration (EIA) of the U.S. Department of Energy (DOE), for the period January 1, 2012 through December 31, 2012. The information submitted to EIA is presumed to be correct. In cases where a company disagrees with this information, the company may petition EPA with appropriate data to correct the record when the company submits its application.

(ii) Foreign small refiners applying for approval under this section must send the total corporate crude oil capacity of each refinery for the period January 1, 2012 through December 31, 2012, to the address listed in paragraph (g) of this section.

(3) The application must be signed by the president, chief operating or chief executive officer of the company, or his/her designee, stating that the information is true to the best of his/her knowledge, and that the company owned the refinery as of December 31, 2012.

(4) Name, address, phone number, facsimile number, and email address of a corporate contact person.

(c) To qualify for small volume refinery status under this subpart, a refiner must submit an application to EPA containing all the following information for the refinery, or refineries, for which the refiner is

applying for small volume refinery status:

(1) A listing of the name and address of each small volume refinery owned by the company.

(2)(i) The total crude throughput of each small volume refinery, defined as the total crude oil feedstock input into the refinery less the volumes injected into the crude oil supply after refinery processing, as reported to EIA, for the period January 1, 2012 through December 31, 2012. The information submitted to EIA is presumed to be correct. In cases where a company disagrees with this information, the company may petition EPA with appropriate data to correct the record when the company submits its application.

(ii) Foreign refiners applying for small volume refinery approval under this section must send the total crude throughput of each small volume refinery, defined as the total crude oil feedstock input into the refinery less the volumes injected into the crude oil supply after refinery processing of each refinery for the period January 1, 2012 through December 31, 2012, to the address listed in paragraph (g) of this section.

(3) The application must be signed by the president, chief operating or chief executive officer of the company, or his/her designee, stating that the information is true to the best of his/her knowledge, and that the company owned the refinery as of December 31, 2012.

(4) Name, address, phone number, facsimile number, and email address of a corporate contact person.

(d) For foreign refiners, the small refiner or small volume refinery status application must contain all of the elements required in paragraph (b) or (c) of this section, as applicable, must demonstrate compliance with § 80.1620, and must be submitted by June 1, 2016 to the address listed in paragraph (g) of this section.

(e) A refiner who qualifies as a small refiner or small volume refinery under this subpart and subsequently fails to meet all the qualifying criteria as set out in §§ 80.1620 and 80.1621 will be disqualified pursuant to § 80.1620(f) or § 80.1621(d).

(1) In the event such disqualification occurs, the refiner shall notify EPA in writing no later than 20 days following the disqualifying event.

(2) Disqualification under this paragraph (e) shall not apply in the case of a merger between two approved small refiners.

(3) Any refiner that acquires a refinery from another refiner with approved



small refiner or small volume refinery status under this subpart shall notify EPA in writing no later than 20 days following the acquisition.

(f) If EPA finds that a refiner provided false or inaccurate information in its small refiner status or small volume refinery status application under this subpart, the refiner's small refiner or small volume refinery status will be void as of the effective date of this subpart.

(g) Small refiner and small volume refinery status applications, and any other correspondence required by this section, § 80.1620, or § 80.1621 shall be sent to the following address: U.S. EPA—Attn: Tier 3 Program (Small Refiner/Small Volume Refinery Application), 6406J, 1200 Pennsylvania Avenue NW., Washington, DC 20460.

#### §§ 80.1623–80.1624 [Reserved]

#### § 80.1625 Hardship provisions.

EPA may, at its discretion, grant a refiner of gasoline that processes crude oil through refinery processing units, for one or more of its refineries, temporary relief from some or all of the provisions of this subpart.

(a) *Extreme hardship circumstances.*

(1) EPA may, at its discretion, grant a refiner of gasoline that processes crude oil through refinery processing units, for one or more of its refineries, temporary relief from some or all of the provisions of this subpart. EPA may grant such relief provided that the refiner demonstrates all the following:

(i) Unusual circumstances exist that impose extreme hardship and significantly affect the refiner's ability to comply by the applicable date.

(ii) It has made best efforts to comply with the requirements of this subpart.

(2) The application must specify the factors that demonstrate a significant economic hardship and must provide a detailed discussion regarding the inability of the refinery to produce gasoline meeting the requirements of § 80.1603. Such an application must include, at a minimum, all the following information:

(i) Documentation of efforts made to obtain necessary financing, including all the following:

(A) Copies of loan applications for the necessary financing of the construction of appropriate sulfur reduction technology and other equipment procurements or improvements.

(B) If financing has been disapproved or is otherwise unsuccessful, documents supporting the basis for that disapproval and evidence of efforts to pursue other means of financing.

(ii) A detailed analysis of the reasons the refinery is unable to produce

gasoline meeting the standards of this subpart O in 2017, including costs, specification of equipment still needed, potential equipment suppliers, and efforts already completed to obtain the necessary equipment.

(iii) If unavailability of equipment is part of the reason for the inability to comply, a discussion of other options considered, and the reasons these other options are not feasible.

(iv) If relevant, a demonstration that a needed or lower cost technology is immediately unavailable, but will be available in the near future, and full information regarding when and from what sources it will be available.

(v) Schematic drawings of the refinery configuration as of January 1, 2011, and as of the date of the hardship extension application, and any planned future additions or changes.

(vi) If relevant, a demonstration that a temporary unavailability exists of engineering or construction resources necessary for design or installation of the needed equipment.

(vii) A detailed analysis of the reasons the refinery is unable to use credits to meet the gasoline standards of this subpart O, including all avenues pursued to generate and/or procure credits, their cost, and ability to finance them.

(viii) A discussion of any sulfur reductions that can be achieved from current levels.

(ix) The date the refiner anticipates compliance with the standards in § 80.1603 can be achieved at its refinery.

(x) An analysis of the economic impact of compliance on the refiner's business (including financial statements from the last 5 years, or for any time period up to 10 years, at EPA's request).

(xi) Any other information regarding other strategies considered, including strategies or components of strategies that do not involve installation of equipment, and why meeting the standards in § 80.1603 beginning in 2017 (or 2020 for approved small refiners and small volume refineries) is infeasible.

(3) Hardship applications under this paragraph (a) must be submitted to EPA by January 1, 2016 to the address listed in paragraph (d) of this section.

(b) *Extreme unforeseen circumstances hardship.* (1) In appropriate extreme, unusual, and unforeseen circumstances (for example, natural disaster or refinery fire) which are clearly outside the control of the refiner or importer and which could not have been avoided by the exercise of prudence, diligence, and due care, EPA may permit a refiner or importer, for a brief period, to distribute gasoline which does not meet the

requirements of this subpart for all the following reasons:

(i) It is in the public interest to do so (e.g., distribution of the nonconforming gasoline is necessary to meet projected shortfalls which cannot otherwise be compensated for).

(ii) The refiner or importer exercised prudent planning and was not able to avoid the violation and has taken all reasonable steps to minimize the extent of the nonconformity.

(iii) The refiner or importer can show how the requirements for making compliant gasoline, and/or purchasing credits to partially or completely offset the nonconformity, will be expeditiously achieved.

(iv) The refiner or importer agrees to make up any air quality detriment associated with the nonconforming gasoline, where practicable.

(v) The refiner or importer pays to the U.S. Treasury an amount equal to the economic benefit of the nonconformity minus the amount expended pursuant to paragraph (b)(1)(iv) of this section, in making up the air quality detriment.

(2) The hardship application must meet all other applicable requirements of this section, except paragraph (a) of this section.

(c) *Applications.* (1) The hardship extension application must contain a letter signed by the president or the chief operating officer or chief executive officer of the company, or his/her designee, stating that the information contained in the application is true to the best of his/her knowledge.

(2) Hardship applications under this section must be submitted in writing to the following address: U.S. EPA—Attn: Tier 3 Program (Hardship Application), 6406J, 1200 Pennsylvania Avenue NW., Washington, DC 20460.

#### §§ 80.1626–80.1629 [Reserved]

#### § 80.1630 Sampling and testing requirements for refiners, gasoline importers and producers and importers of certified ethanol denaturant.

(a) *Sample and test each batch of gasoline and certified ethanol denaturant.* (1) Refiners and importers shall collect a representative sample from each batch of gasoline produced or imported and test each sample to determine its sulfur content for compliance with requirements under this subpart prior to the gasoline leaving the refinery or import facility, using the sampling and testing methods provided in this section or §§ 80.8 (sampling) and 80.47 (testing).

(2) Producers and importers of certified ethanol denaturant shall collect a representative sample from each batch of certified ethanol denaturant produced

or imported and test each sample to determine its sulfur content for compliance with requirements under this subpart prior to the certified ethanol denaturant leaving the certified ethanol denaturant production or import facility, using the sampling and testing methods provided in this section or §§ 80.8 (sampling) and 80.47 (testing).

(3) Except as provided in paragraph (a)(4) of this section, the requirements of this section apply beginning January 1, 2017 for gasoline refiners and importers. For producers and importers of certified ethanol denaturants, the requirements of this section apply beginning January 1, 2017, or the first date that certified ethanol denaturant is introduced into commerce, whichever is earlier.

(4)(i) Beginning January 1, 2017, any refiner who produces gasoline using computer-controlled in-line blending equipment is exempt from the requirement of paragraph (a)(1) of this section to obtain the test results required under paragraph (a)(1) of this section prior to the gasoline leaving the refinery, provided that the refiner obtains an exemption from this requirement from EPA. To obtain such exemption, the refiner must—

(A) Have been granted an in-line blending exemption under § 80.65(f)(4); or

(B) If the refiner has not been granted an exemption under § 80.65(f)(4), submit to EPA all of the information required under § 80.65(f)(4)(i)(A). A letter signed by the president, chief operating officer or chief executive officer of the company, or his/her designee, stating that the information contained in the submission is true to the best of his/her belief must accompany any submission under this paragraph (a)(4)(i)(B).

(ii) Refiners who seek an exemption under paragraph (a)(4)(i) of this section must comply with any EPA request for additional information or any other requirements that EPA includes as part of the exemption.

(iii) Within 60 days of EPA's receipt of a submission under paragraph (a)(4)(i)(B) of this section, EPA will notify the refiner if the exemption is not approved or of any deficiencies in the refiner's submission, or if any additional information is required or other requirements are included in the exemption pursuant to paragraph (a)(4)(ii) of this section. In the absence of such notification from EPA, the effective date of an exemption under paragraph (a)(4)(i) of this section for refiners who do not hold an exemption under § 80.65(f)(4) is 60 days from EPA's receipt of the refiner's submission

under paragraph (a)(4)(i)(B) of this section.

(iv) EPA reserves the right to modify the requirements of an exemption under paragraph (a)(4)(i) of this section, in whole or in part, at any time, if EPA determines that the refiner's operation does not effectively or adequately control, monitor or document the sulfur content of the refinery's gasoline production, or if EPA determines that any other circumstances exist which merit modification of the requirements of an exemption, such as advancements in the state of the art for in-line blending measurement which allow for additional control or more accurate monitoring or documentation of sulfur content. If EPA finds that a refiner provided false or inaccurate information in any submission required for an exemption under this section, upon notification from EPA, the refiner's exemption will be void *ab initio*.

(b) *Sampling methods.* For purposes of paragraph (a) of this section, refiners, gasoline importers, and producers and importers of certified ethanol denaturant shall sample each batch of gasoline by using one of the methods specified in § 80.8. Alternative methods for sampling batches of certified ethanol denaturant may be used as approved by the Administrator.

(c) *Test method for measuring sulfur content of gasoline and certified ethanol denaturant.* (1) For purposes of paragraph (a) of this section, refiners, gasoline importers, and producers and importers of certified ethanol denaturant shall use the method provided in § 80.47, as applicable, to measure the sulfur content of gasoline or certified ethanol denaturant they produce or import.

(2) Sulfur content shall be reported to the nearest ppm.

(3) Alternative methods for the measurement of the sulfur content of certified ethanol denaturants may be used as approved by the Administrator.

**§ 80.1631 Gasoline, RBOB, and CBOB sample retention requirements.**

(a) *Sample retention requirements.* Beginning January 1, 2017, or January 1 of the first year credits are generated under § 80.1615, whichever is earlier, any refiner or importer shall do all the following:

(1) Collect a representative portion of each sample analyzed under § 80.1630, of at least 330 milliliters in volume.

(2) Retain sample portions for the most recent 20 samples collected, or for each sample collected during the most recent 21 day period, whichever is greater, not to exceed 90 days for any given sample.

(3) Comply with the gasoline sample handling and storage procedures under § 80.1630 for each sample portion retained.

(4) Comply with any request by EPA to—

(i) Provide a retained sample portion to the Administrator's authorized representative; and

(ii) Ship a retained sample portion to EPA, within two working days of the date of the request, by an overnight shipping service or comparable means, to the address and following procedures specified by EPA, and accompanied with the sulfur test result for the sample determined under § 80.1630.

(b) *Sample retention requirement for samples subject to independent analysis requirements.* (1) Any refiner or importer who meets the independent analysis requirements under § 80.65(f) for any batch of reformulated gasoline or RBOB will have met the requirements of paragraph (a) of this section, provided the independent laboratory meets the requirements of paragraph (a) of this section for the gasoline batch; except that the retained RBOB sample for purposes of this subpart O must be a sample of the RBOB prior to hand blending with oxygenate.

(2) For samples retained by an independent laboratory under this paragraph (b), the test results required to be submitted under paragraph (a) of this section shall be the test results determined under § 80.65(e).

(c) *Sampling compliance certification.* Any refiner or importer shall include with each annual report filed under § 80.1652, the following statement, which must accurately reflect the facts and must be signed and dated by the same person who signs the annual report:

I certify that I have made inquiries that are sufficient to give me knowledge of the procedures to collect and store gasoline samples, and I further certify that the procedures meet the requirements of the ASTM procedures required under 40 CFR 80.1630.

(d) *Requirements for refiners who analyze composited samples.* Prior to January 1, 2017, for purposes of complying with the requirements of this section, refiners who analyze composited samples under § 80.1630 must retain portions of the composited samples. Portions of samples of each batch comprising the composited samples are not required to be retained.

(e) *Requirements for RBOB.* For purposes of complying with the requirements of this section for RBOB, a sample of each RBOB batch produced must be retained.

**§§ 80.1632–80.1639 [Reserved]****§ 80.1640 Standards and requirements that apply to refiners producing gasoline by blending blendstocks into previously certified gasoline (PCG).**

(a) Any refiner who produces gasoline by blending blendstock into PCG, as defined at § 80.2(d), must meet the requirements of § 80.1630 to sample and test every batch of gasoline as follows:

(1) Exclude the PCG for purposes of demonstrating compliance with the sulfur standards of this subpart O.

(2) To accomplish the exclusion required in paragraph (a)(5) of this section, the refiner must determine the volume and sulfur content of the PCG used at the refinery and the volume of and sulfur content of the gasoline produced at the refinery, and use the compliance calculation procedures in paragraphs (a)(3) and (4) of this section.

(3) For each batch of PCG that is used to produce gasoline the refiner must include the volume and sulfur content of the PCG as a negative volume and a positive sulfur content in the refiner's compliance calculations in accord with the requirements at § 80.1603.

(4) For each batch of gasoline produced at the refinery using PCG and blendstock, the refiner must determine the volume and sulfur content of the combined product and include each batch of combined product for purposes of sulfur compliance in the refinery's compliance calculations at § 80.1603 without regard to the presence of previously certified gasoline in the batch.

(5) The refiner must use any PCG that it includes as a negative batch in its compliance calculations pursuant to § 80.1603 as a component in gasoline production during the annual averaging period in which the PCG was included as a negative batch in the refiner's compliance calculations.

(6) The refiner must also comply with § 80.65(i) when producing RBOB or RFG and § 80.101(g)(9) when producing conventional gasoline or CBOB.

(7) Any negative annual average sulfur value shall be reported as zero and not as a negative result.

(b) In the alternative, a refiner may sample and test each batch of blendstock when received at the refinery to determine the volume and sulfur content, and treat each blendstock receipt as a separate batch for purposes of compliance calculations for the annual average sulfur standard and for reporting. This alternative applies only if every batch of blendstock used at a refinery during an averaging period has a sulfur content that is equal to, or less than, the applicable per-gallon cap standard under § 80.1603.

(c) Refiners who blend only butane into PCG may meet the sampling and testing requirements of this subpart O for sulfur by using sulfur test results of the butane supplier, provided that the requirements of § 80.82 are met.

(d) Refiners who blend only blender grade pentane into PCG may meet the sampling and testing requirements of this subpart O for sulfur by using sulfur test results of the pentane supplier, provided that the requirements of § 80.85 are met.

**§ 80.1641 Alternative sulfur standards and requirements that apply to importers who transport gasoline by truck.**

Importers who import gasoline into the United States by truck may comply with the following requirements instead of the requirements to sample and test every batch of gasoline under § 80.1630, and the annual sulfur average and per-gallon cap standards otherwise applicable to importers under § 80.1603:

(a) *Alternative standards.* The imported gasoline must comply with the following standards:

(1) The annual average standard of 10 ppm and the per-gallon standard of 80 ppm as provided by § 80.1603; or

(2) A per-gallon standard of 10 ppm.

(b) *Terminal testing.* The importer may use test results for sulfur content testing conducted by the terminal operator, for gasoline contained in the storage tank from which trucks used to transport gasoline into the United States are loaded, for purposes of demonstrating compliance with the standards in paragraph (a) of this section, provided all the following conditions are met:

(1) The sampling and testing shall be performed after each receipt of gasoline into the storage tank, or immediately before each transfer of gasoline to the importer's truck.

(2) The sampling and testing shall be performed using the methods specified in §§ 80.8 and 80.47, respectively.

(3) At the time of each transfer of gasoline to the importer's truck for import to the United States, the importer must obtain a copy of the terminal test result that indicates the sulfur content of the truck load (or each compartment if fuel was loaded from different storage tanks).

(c) *Quality assurance program.* The importer must conduct a quality assurance program for each truck loading terminal as follows:

(1) Quality assurance samples must be obtained from the truck-loading terminal and tested by the importer, or by an independent laboratory, and the terminal operator must not know in advance when samples are to be collected.

(2) The sampling and testing must be performed using the methods specified in §§ 80.8 and 80.47, respectively.

(3) The quality assurance test results for sulfur must differ from the terminal test result by no more than the ASTM reproducibility of the terminal's test results, as determined by the following equation:

$$R = 105 \times ((S + 2)/104) 0.4$$

Where:

R = ASTM reproducibility.

S = Sulfur content based on the terminal's test result.

(4) The frequency of the quality assurance sampling and testing must be at least one sample for each fifty of an importer's trucks that are loaded at a terminal, or one sample per month, whichever is more frequent.

(d) *Party required to conduct quality assurance testing.* The quality assurance program under paragraph (c) of this section shall be conducted by the importer. In the alternative, this testing may be conducted by an independent laboratory that meets the criteria under § 80.65(f)(2)(iii), provided the importer receives, no later than 21 days after the sample was taken, copies of all results of tests conducted.

(e) *Assignment of batch numbers.* The importer must treat each truckload of imported gasoline as a separate batch for purposes of reporting under § 80.1652 and assigning batch numbers and maintaining records under § 80.1653.

(f) *EPA inspections of terminals.* EPA inspectors or auditors, and auditors conducting attest engagements under § 80.1667, must be given full and immediate access to the truck-loading terminal and any laboratory at which samples of gasoline collected at the terminal are analyzed, and must be allowed to conduct inspections, review records, collect gasoline samples, and perform audits. These inspections or audits may be either announced or unannounced.

(g) *Certified Sulfur-FRGAS.* This section does not apply to Certified Sulfur-FRGAS.

(h) *Reporting requirements.* Any importer who elects to comply with the alternative standards in paragraph (a) of this section shall comply with all the following requirements:

(1) All importer recordkeeping and reporting requirements under §§ 80.1652 and 80.1653, except as provided in paragraph (h)(2) of this section.

(2) An importer who elects to comply with the alternative standards in paragraph (a)(2) of this section must certify in the annual report whether it is in compliance with the applicable

per-gallon batch standard set forth in paragraph (a)(2) of this section, in lieu of providing the information required by § 80.1652 regarding annual average sulfur content and compliance with the average standard under § 80.1603.

(i) *Effect of noncompliance.* If any of the requirements of this section are not met, all gasoline imported by the truck importer during the time any requirements are not met is deemed in violation of the gasoline sulfur average and per-gallon cap standards in § 80.1603. Additionally, if any requirement is not met, EPA may notify the importer of the violation and, if the requirement is not fulfilled within 10 days of notification, the truck importer may not in the future use the sampling and testing provisions in this section in lieu of the provisions in § 80.1630.

**§ 80.1642 Sampling and testing requirements for producers and importers of denatured fuel ethanol and other oxygenates for use by oxygenate blenders.**

Beginning January 1, 2017, producers and importers of denatured fuel ethanol (DFE) and other oxygenates for use by oxygenate blenders must satisfy the sampling and testing requirements in this section prior to the addition of the oxygenate to gasoline or blendstocks for oxygenate blending.

(a) *Sampling requirements.* Producers and importers of oxygenates for use by oxygenate blenders shall collect a representative sample from each batch of oxygenate produced or imported prior to the oxygenate leaving the oxygenate production or import facility, using the sampling methods specified in § 80.8 or § 80.47.

(b) *Determination of oxygenate sulfur content.* Producers and importers of oxygenates must test each batch of oxygenate they produce or import to determine its sulfur content to the nearest ppm using a test method provided in § 80.47, or, with respect to DFE may use the alternative means of determining the sulfur content contained in paragraph (c) of this section.

(c) *Alternative means of determining the sulfur content of DFE.* As an alternative to testing each batch of DFE pursuant to the requirements of paragraph (b) of this section, the sulfur content of batches of DFE produced using certified denaturant meeting the requirements of § 80.1611 may be determined as follows:

(1) The sulfur content of the batch of DFE shall be calculated by volume weighting the sulfur contribution from the denaturant, and the neat ethanol used.

(2) The sulfur content of the neat (undenatured) ethanol used in the calculation in paragraph (c)(1) of this section may be assumed to be negligible or assumed to be some specific value for the purposes of calculating the sulfur content of the DFE batch provided that the DFE manufacturer or importer conducts production quality control which demonstrates that such an assumption is valid. Otherwise, the sulfur content of the neat ethanol must be determined in accordance with the test requirements of § 80.1630.

(3) The sulfur content of the certified denaturant(s) used in the calculation in paragraph (c)(1) of this section must be consistent with the PTD(s) obtained from a registered certified ethanol denaturant producer(s) or importer(s) in accordance with the requirements of § 80.1611. If the PTD from the certified ethanol denaturant states that the sulfur content is 330 ppm, then the sulfur content of the sulfur content of the ethanol denaturant must be assumed to be 330 ppm.

(4) A sample of each batch of DFE must be retained pursuant to the requirements of § 80.1643.

(5) The sulfur content of each batch of DFE shall be reported to the nearest ppm.

**§ 80.1643 Sample retention requirements for oxygenate producers and importers.**

(a) *Sample retention requirements.* Beginning January 1, 2017, any producer or importer of oxygenate shall do all the following:

(1) Retain a representative portion of each sample analyzed under § 80.1642(b), of at least 330 milliliters in volume.

(2) Retain a representative sample of each batch of DFE for which the DEF producer or importer used the alternative means of determining the sulfur contents of the DFE batch pursuant to the requirements of § 80.1642(c), of at least 330 milliliters in volume.

(3) Retain sample portions for the most recent 20 samples collected, or for each sample collected during the most recent 21 day period, whichever is greater, not to exceed 90 days for any given sample.

(4) Comply with the DFE sample handling and storage procedures under § 80.1642 for each sample portion retained.

(5) Comply with any request by EPA to—

(i) Provide a retained sample portion to the Administrator's authorized representative; and

(ii) Ship a retained sample portion to EPA, within two working days of the

date of the request, by an overnight shipping service or comparable means, to the address and following procedures specified by EPA, and accompanied with the sulfur test result for the sample determined under § 80.1642 or the calculated sulfur content of the batch from which the sample was drawn determined pursuant to the requirements of § 80.1611(e).

(b) [Reserved]

**§ 80.1644 Sampling and testing requirements for producers and importers of certified ethanol denaturant.**

(a) *Sample and test each batch of certified ethanol denaturant.* (1) Producers and importers of certified ethanol denaturant shall collect a representative sample from each batch of certified ethanol denaturant produced or imported and test each sample to determine its sulfur content for compliance with requirements under this subpart prior to the ethanol denaturant leaving the production or import facility, using the sampling and testing methods provided in this section or §§ 80.8 (sampling) and 80.47 (testing).

(2) The requirements of this section apply beginning January 1, 2017 or on the first day that an ethanol denaturant manufacturer designates a batch of ethanol denaturant as compliant with the requirements of § 80.1611, whichever is earlier.

(b) *Determination of certified ethanol denaturant sulfur content.* Producers and importers of certified ethanol denaturant who are required to test each batch of certified ethanol denaturant they produce or import to determine its sulfur content pursuant to the requirements of § 80.1611 shall use the testing methods specified in paragraph (c) of this section.

(c) *Test method for measuring sulfur content of certified ethanol denaturant.* (1) For purposes of paragraph (b) of this section, producers and importers of certified ethanol denaturant shall use the method provided in § 80.47 to measure the sulfur content of certified ethanol denaturant they produce or import. Alternative test methods may be used as approved by the Administrator.

(2) The sulfur content of each batch of ethanol denaturant shall be reported to the nearest ppm.

**§ 80.1645 Sample retention requirements for producers and importers of denaturant designated as suitable for the manufacture of denatured fuel ethanol meeting federal quality requirements.**

Beginning January 1, 2017, or on the first day that any producer or importer of ethanol denaturant designates a batch of ethanol denaturant as suitable for the manufacture of denatured fuel ethanol

meeting federal quality requirements, whichever is earlier, the ethanol denaturant producer or importer shall do all the following:

(a) Retain a representative portion of each sample collected under § 80.1644, of at least 330 milliliters in volume.

(b) Retain sample portions for the most recent 20 samples collected, or for each sample collected during the most recent 21 day period, whichever is greater, not to exceed 90 days for any given sample.

(c) Comply with the ethanol denaturant sample handling and storage procedures under § 80.1644 for each sample portion retained.

(d) Comply with any request by EPA to—

(1) Provide a retained sample portion to the Administrator's authorized representative; and

(2) Ship a retained sample portion to EPA, within two working days of the date of the request, by an overnight shipping service or comparable means, to the address and following procedures specified by EPA, and accompanied with the sulfur test result for the sample determined under § 80.1644.

#### §§ 80.1646–80.1649 [Reserved]

#### § 80.1650 Registration.

The following registration requirements apply under this subpart:

(a) *Registration.* Registration with the EPA Administrator is required for any—

(1) Gasoline refiner or importer having any refinery or import facility subject to the gasoline sulfur standards under this subpart O, unless already registered as a gasoline refiner or importer under § 80.76 or § 80.103.

(2) Oxygenate producer or importer having any oxygenate production facility or import facility subject to the oxygenate sulfur standards under § 80.1610.

(3) Oxygenate blender who has any oxygenate blending facility that blends oxygenate into gasoline, RBOB, or CBOB where the resulting gasoline is subject to the gasoline sulfur standards under this subpart O, unless already registered as an oxygenate blender under § 80.76.

(4) Producer or importer of certified.

(b) *Registration dates.* (1) Any gasoline refiner or importer required to register shall do so by December 1, 2016, or at least 30 days in advance of the first date that such person will produce or import reformulated gasoline, conventional gasoline, RBOB, or CBOB, whichever is earlier. If a previously unregistered refiner or importer intends to generate credits prior to January 1, 2017 (pursuant to § 80.1615), registration must occur at

least 90 days prior to submitting an annual compliance report demonstrating credit generation.

(2) Any oxygenate producer or importer required to register shall do so by November 1, 2016, or at least 60 days in advance of the first date that such person will produce or import oxygenate, whichever is earlier.

(3) Any oxygenate blender required to register shall do so by November 1, 2016, or at least 90 days in advance of the first date that such person will blend oxygenate into RBOB, whichever is earlier.

(4) Any ethanol denaturant producer or importer required to register shall do so by November 1, 2016, or at least 60 days in advance of the first date that such person will produce or import ethanol denaturant, whichever is earlier.

(c) *Refiner registration.* (1) Registration shall be on forms and use procedures prescribed by the Administrator, and shall include all the following information:

(i) The name, business address, contact name, email address, and telephone number of the refiner.

(ii) For each separate refinery, the facility name, physical location, contact name, email address, telephone number, and type of facility.

(iii) For each separate refinery—

(A) Whether records are kept on-site or off-site of the refinery.

(B) If records are kept off-site, the primary off-site storage facility name, physical location, contact name, email address, and telephone number.

(iv) For each separate refinery that produces reformulated gasoline and/or RBOB, the name, address, contact name, email address, and telephone number of the independent laboratory used to meet the independent analysis requirements of § 80.65(f).

(2) EPA will supply a company registration number to each refiner, and a facility registration number for each refinery that is identified. These registration numbers shall be used in all reports to the Administrator.

(3)(i) Any refiner shall submit updated registration information to the Administrator within thirty days of any occasion when the registration information previously supplied becomes incomplete or inaccurate; except that

(ii) EPA must be notified in writing of any change in designated independent laboratory under paragraph (a)(1)(iv) of this section at least thirty days in advance of such change.

(d) *Gasoline importer registration.* (1) Registration shall be on forms and use procedures prescribed by the

Administrator, and shall include all the following information:

(i) The name, business address, contact name, email address, and telephone number of the importer.

(ii) For each importer's operations in a single PADD:

(A) Whether records are kept on-site at the registered address or off-site.

(B) If records are kept off-site, the primary off-site storage facility name, physical location, contact name, email address, and telephone number.

(C) For importers that import reformulated gasoline and/or RBOB, the name, address, contact name and telephone number of the independent laboratory used to meet the independent analysis requirements of § 80.65(f).

(2) EPA will supply a company registration number to each importer. This registration number shall be used in all reports to the Administrator.

(3)(i) Any importer shall submit updated registration information to the Administrator within thirty days of any occasion when the registration information previously supplied becomes incomplete or inaccurate; except that

(ii) EPA must be notified in writing of any change in designated independent laboratory under paragraph (d)(1)(ii)(C) of this section at least thirty days in advance of such change.

(e) *Oxygenate producer registration.*

(1) Registration shall be on forms and use procedures prescribed by the Administrator, and shall include all the following information:

(i) The name, business address, contact name, email address, and telephone number of the oxygenate producer.

(ii) For each separate oxygenate production facility, the facility name, physical location, contact name, telephone number, and type of facility.

(iii) For each separate oxygenate production facility—

(A) Whether records are kept on-site or off-site of the refinery.

(B) If records are kept off-site, the primary off-site storage facility name, physical location, contact name, and telephone number.

(iv) The type and chemical composition of the oxygenate.

(2) EPA will supply a company registration number to each oxygenate producer, and a facility registration number for each oxygenate production facility that is identified. These registration numbers or those provided under § 80.1450 shall be used in all reports to the Administrator.

(3) Any oxygenate producer shall submit updated registration information to the Administrator within thirty days

of any occasion when the registration information previously supplied becomes incomplete or inaccurate.

(f) *Oxygenate importer registration.* (1) Registration shall be on forms and use procedures prescribed by the Administrator, and shall include all the following information:

(i) The name, business address, contact name, and email address, telephone number of the importer.

(ii) For each importer's operations in a single PADD—

(A) Whether records are kept on-site at the registered address or off-site.

(B) If records are kept off-site, the primary off-site storage facility name, physical location, contact name, email address, and telephone number.

(iii) The type and chemical composition of the oxygenate.

(2) EPA will supply a company registration number to each importer. This registration number shall be used in all reports to the Administrator.

(g) *Oxygenate blender registration.* (1) Registration shall be on forms and use procedures prescribed by the Administrator, and shall include all the following information:

(i) The name, business address, contact name, and email address, telephone number of the oxygenate blender.

(ii) For each separate oxygenate blending facility, the facility name, physical location, contact name, telephone number, and type of facility.

(iii) For each separate oxygenate blending facility—

(A) Whether records are kept on-site or off-site of the refinery.

(B) If records are kept off-site, the primary off-site storage facility name, physical location, contact name, email address, and telephone number.

(iv) The type and chemical composition of the oxygenate.

(2) EPA will supply a company registration number to each oxygenate blender, and a facility registration number for each oxygenate blending facility that is identified. These registration numbers or those provided under § 80.1450 shall be used in all reports to the Administrator.

(3) Any oxygenate producer shall submit updated registration information to the Administrator within thirty days of any occasion when the registration information previously supplied becomes incomplete or inaccurate.

(h) *Certified ethanol denaturant producer registration.* (1) Registration shall be on forms and use procedures prescribed by the Administrator, and shall include all the following information:

(i) The name, business address, contact name, email address, and

telephone number of the ethanol denaturant producer.

(ii) For each separate ethanol denaturant production facility, the facility name, physical location, contact name, telephone number, and type of facility.

(iii) For each separate ethanol denaturant production facility—

(A) Whether records are kept on-site or off-site of the ethanol denaturant production facility.

(B) If records are kept off-site, the primary off-site storage facility name, physical location, contact name, and telephone number.

(2) EPA will supply a company registration number to each ethanol denaturant producer, and a facility registration number for each ethanol denaturant production facility that is identified. These registration numbers or those provided under § 80.1450 shall be used in all reports to the Administrator.

(3) Any ethanol denaturant producer shall submit updated registration information to the Administrator within thirty days of any occasion when the registration information previously supplied becomes incomplete or inaccurate.

(i) *Ethanol denaturant importer registration.* (1) Registration shall be on forms and use procedures prescribed by the Administrator, and shall include all the following information:

(i) The name, business address, contact name, and email address, telephone number of the importer.

(ii) For each importer's operations in a single PADD—

(A) Whether records are kept on-site at the registered address or off-site.

(B) If records are kept off-site, the primary off-site storage facility name, physical location, contact name, email address, and telephone number.

(2) EPA will supply a company registration number to each importer. This registration number shall be used in all reports to the Administrator.

#### **§ 80.1651 Product transfer document requirements.**

(a) *Gasoline, RBOB, CBOB, and oxygenates.* In addition to any other product transfer document requirements under this part 80, on each occasion that any person transfers custody or title to any gasoline, RBOB, CBOB, or oxygenate other than when gasoline is sold or dispensed for use in motor vehicles at a retail outlet or wholesale purchaser-consumer facility, the transferor shall provide to the transferee documents which include all the following information:

(1) The name and address of the transferor.

(2) The name and address of the transferee.

(3) The volume of gasoline, RBOB, CBOB, or oxygenate which is being transferred.

(4) The location of the gasoline, RBOB, CBOB, or oxygenate at the time of the transfer.

(5) The date of the transfer.

(b) *Gasoline for export or with an exemption and California gasoline.* In addition to any other product transfer document requirements under this part 80, on each occasion when any person transfers custody or title to any gasoline for export or with an exemption under §§ 80.1654, 80.1655, 80.1656, or 80.1658, any of the following statements must be included on the product transfer document:

(1) For gasoline with a national security exemption under § 80.1655, "This gasoline is for use in vehicles, engines, or equipment under an EPA-approved national security exemption only."

(2) For gasoline with a research, development, or testing exemption under § 80.1656, "This gasoline is for research, development, or testing purposes only."

(3) For gasoline for use in American Samoa, Guam, and the Commonwealth of the Northern Mariana Islands under § 80.1658, "This is gasoline for use only in Guam, American Samoa, or the Northern Mariana Islands."

(4) For gasoline for export purposes, "This gasoline is for export only."

(5) For gasoline for racing purposes, "This gasoline is for racing purposes only."

(6) For California gasoline, pursuant to § 80.1654, "California gasoline".

(c) *Gasoline additive.* On each occasion when any person transfers custody or title to any gasoline additive intended to be used at less than 1 volume percent, other than when the gasoline additive is sold or dispensed for use in motor vehicles at a retail outlet or wholesale purchaser-consumer facility, the transferor shall provide to the transferee documents which include information on the maximum recommended treatment level.

(d) *Ethanol denaturant.* On each occasion when any person transfers custody or title to any ethanol denaturant designated as suitable for use in the manufacture of denatured fuel ethanol meeting federal quality requirements pursuant to § 80.1611, the transferor shall provide to the transferee documents which include all the following information:

(1) The name and address of the transferor.

(2) The name and address of the transferee.

(3) The volume of ethanol denaturant which is being transferred.

(4) The location of the ethanol denaturant at the time of the transfer.

(5) The date of the transfer.

(6) A statement identifying the batch as "Ethanol denaturant suitable for the manufacture of denatured fuel ethanol meeting federal quality requirements", or another identifying statement as approved by EPA consistent with the requirements of § 80.1611.

(7) Information on the sulfur content of the ethanol denaturant, as applicable, pursuant to the requirements of § 80.1611.

(e) *Oxygenate*. On each occasion when any person transfers custody or title to any oxygenate, the transferor shall provide to the transferee documents which include all the following information:

(1) The name and address of the transferor.

(2) The name and address of the transferee.

(3) The volume of oxygenate which is being transferred.

(4) The location of the oxygenate at the time of the transfer.

(5) The date of the transfer.

(6) For denatured fuel ethanol, a statement identifying the batch as "Denatured fuel ethanol, maximum 10 ppm sulfur".

(7) For oxygenates other than DFE, the name of the specific oxygenate must be identified on the PTD, followed by "maximum 10 ppm sulfur".

(8) Alternative PTD language to that specified in paragraphs (e)(6) and (7) of this section may be used as approved by EPA consistent with the requirements of § 80.1610.

**§ 80.1652 Reporting requirements for gasoline refiners, gasoline importers, oxygenate producers, and oxygenate importers.**

Beginning with the 2017 averaging period or the first year credits are generated under § 80.1615 (whichever is earlier), and continuing for each averaging period thereafter, any gasoline refiner or importer shall submit to EPA annual reports that contain the information required in this section, and any other information as EPA may require. Beginning with the 2017 calendar year and continuing each calendar year thereafter, any oxygenate producer or importer shall submit to EPA annual reports that contain the information required in this section, and any other information as EPA may require. Reporting shall be on forms and use procedures prescribed by the Administrator.

(a) *Gasoline refiner and importer annual reports*. Any refiner, for each of its refineries, and any importer for the gasoline it imports, shall submit a report for each calendar year averaging period that includes all the following information:

(1) The EPA importer, or refiner and refinery facility registration numbers.

(2) The average standard under § 80.1603, reported to two decimal places.

(3) The total volume of gasoline produced or imported, reported to the nearest whole number.

(4) The annual average sulfur level of the gasoline produced or imported, reported to two decimal places.

(5) The annual average sulfur level after inclusion of any credits, reported to two decimal places.

(6) Separately provided information for credits, and separately by year of creation, as follows:

(i) The number of credits at the beginning of the averaging period, reported to the nearest whole number.

(ii) The number of credits generated, reported to the nearest whole number.

(iii) The number of credits used, reported to the nearest whole number.

(iv) If any credits were obtained from or transferred to other parties; and for each other party, its name and EPA refiner or importer registration number, and the number of credits obtained from or transferred to the other party.

(v) The number of credits that expired at the end of the averaging period, reported to the nearest whole number.

(vi) The number of credits that will carry over into the subsequent averaging period, reported to the nearest whole number.

(7) For each batch of gasoline produced or imported during the averaging period, all the following:

(i) The batch number assigned under § 80.65(d)(3); except that if composite samples of conventional gasoline representing multiple batches produced subsequent to December 31, 2003, are tested under § 80.101(i)(2) for anti-dumping compliance purposes, for purposes of this subpart a separate batch number must be assigned to each batch using the batch numbering procedures under § 80.65(d)(3).

(ii) The date the batch was produced.

(iii) The volume of the batch, reported to the nearest whole number.

(iv) The sulfur content of the batch, reported to two decimal places, along with identification of the test method used to determine the sulfur content of the batch, as determined under § 80.1630.

(8) All values measured or calculated pursuant to the requirements of this

paragraph (a) shall be in accordance with the rounding procedure specified in § 80.9.

(9) When submitting reports under this paragraph (a) from January 1, 2017 through December 31, 2019, any importer shall exclude Certified Sulfur-FRGAS.

(b) *Additional reporting requirements for gasoline importers*. From January 1, 2017 through December 31, 2019, importers shall report all the following information for Sulfur-FRGAS imported during an annual averaging period:

(1) The EPA refiner and refinery registration numbers of each foreign refiner and refinery where the Certified Sulfur-FRGAS was produced.

(2) The total gallons of Certified Sulfur-FRGAS and Non-Certified Sulfur-FRGAS imported from each foreign refiner and refinery, reported to one decimal place.

(c) *Oxygenate refiner and importer annual reports*. Any oxygenate producer, for each of its production facilities, and any importer for the oxygenate it imports, shall submit a report for each calendar year period that includes all the following information:

(1) The EPA oxygenate importer, or producer and producer facility registration numbers.

(2) The total volume of oxygenate produced or imported, reported to the nearest whole number.

(3) For each batch of oxygenate produced or imported during the calendar year, all the following:

(i) The batch number assigned under § 80.1610(d).

(ii) The date the batch was produced.

(iii) The volume of the batch, reported to the nearest whole number.

(iv) The sulfur content of the batch, reported to two decimal places.

(v) For oxygenates other than denatured fuel ethanol, the identification of the test method used to determine the sulfur content of the batch pursuant to the requirements of § 80.1642(c).

(vi) For denatured fuel ethanol, either the identification of the test method used to determine the sulfur content of the batch (pursuant to § 80.1642), or the information used to calculate the sulfur content pursuant to the requirements of § 80.1642(c).

(4) All values measured or calculated pursuant to the requirements of this paragraph (c) shall be in accordance with the rounding procedure specified in § 80.9.

(d) *Report submission*. Any annual report required under this section shall be—

(1) Signed and certified as meeting all of the applicable requirements of this



subpart by the owner or a responsible corporate officer of the refiner, gasoline importer, oxygenate producer, oxygenate importer, denaturant producer, or denaturant importer; and

(2) Submitted to EPA no later than the March 31 each year for the prior calendar year.

(e) *Attest reports.* Attest reports for refiner and importer attest engagements required under § 80.1667 shall be submitted to the Administrator by June 1 of each year for the prior calendar year.

#### § 80.1653 Recordkeeping.

Unless otherwise provided for in this section, the records required by this section shall be retained for a period of five years from the date of creation, and shall be delivered to the Administrator of EPA or to the Administrator's authorized representative upon request.

(a) *Records that must be kept by gasoline refiners, importers, and parties in the gasoline distribution system.*

Beginning January 1, 2017 or January 1 of the first year that credits are generated (whichever is earlier), any person who produces, imports, sells, offers for sale, dispenses, distributes, supplies, offers for supply, stores, or transports gasoline, shall keep records containing the information as required in this section.

(1) The product transfer document information required under § 80.1651.

(2) All the following information for any sampling and testing for sulfur content required under this subpart O:

(i) The location, date, time, and storage tank or truck identification for each sample collected.

(ii) The name and title of the person who collected the sample and the person who performed the test.

(iii) The results of the test as originally printed by the testing apparatus, or where no printed result is produced, the results as originally recorded by the person who performed the test.

(iv) Any record that contains a test result for the sample that is not identical to the result recorded under paragraph (a)(2)(iii) of this section.

(v) The test methodology used.

(b) *Additional records that refiners and importers must keep.* Beginning January 1, 2014, or January 1 of the first year credits are generated under § 80.1615, whichever is earlier, any refiner for each of its refineries and any importer for the gasoline it imports, shall keep records that include all the following information:

(1) For each batch of gasoline produced or imported—

(i) The batch volume.

(ii) The batch number assigned under § 80.65(d)(3) and the appropriate designation under paragraph (b)(1)(iv) of this section; except that for composite samples of conventional gasoline representing multiple batches, that are tested under § 80.101(i)(2) for purposes of this subpart, a separate batch number must be assigned to each batch using the batch numbering procedures under § 80.65(d)(3).

(iii) The date of production or importation.

(iv) If appropriate, the designation of the batch as California gasoline under § 80.1654, exempt gasoline for national security purposes under § 80.1655, exempt gasoline for research and development under § 80.1656, or for export outside the United States.

(v) The test methodology used.

(2) Information regarding credits, separately kept according to the year of creation; and for credit generation or use starting in 2014. The following information shall be kept separately for each type of credit generated under § 80.1615:

(i) The number of credits in the refiner's or importer's possession at the beginning of the averaging period.

(ii) The number of credits generated.

(iii) The number of credits used.

(iv) If any credits were obtained from or transferred to other parties, all the following for each other party:

(A) The party's name.

(B) The party's EPA refiner or importer registration number.

(C) The number of credits obtained from, or transferred to, the party.

(v) The number of credits that expired at the end of the averaging period.

(vi) The number of credits in the refiner's or importer's possession that will carry over into the subsequent averaging period.

(vii) Contracts or other commercial documents that establish each transfer of credits from the transferor to the transferee.

(3) The calculations used to determine compliance with the applicable sulfur average standards of § 80.1603 or § 80.1604.

(4) The calculations used to determine the number of credits generated under § 80.1615.

(5) A copy of all reports submitted to EPA under § 80.1652.

(6) In the case of parties who process transmix, records of any sampling and testing required under § 80.1607.

(c) *Additional records gasoline importers must keep.* Any importer shall keep records that identify and verify the source of each batch of certified Sulfur-FRGAS and non-certified Sulfur-FRGAS imported and

demonstrate compliance with the requirements for importers under § 80.1666.

(d) *Records that producers and importers of denatured fuel ethanol and other oxygenates must keep.* Beginning January 1, 2017 or the first date when DFE is introduced into commerce that is represented on the product transfer document as meeting the standards in § 80.1610 (whichever is earlier), records of all the following must be kept for each batch of oxygenate produced or imported by oxygenate producers and importers:

(1) The date the batch was produced.

(2) The batch number.

(3) The batch volume.

(4) The product transfer document for the batch.

(5) The sulfur content of the batch as determined pursuant to the requirements of § 80.1642.

(6) The following records shall be kept if the sulfur content of the batch was determined by analytical testing:

(i) The location, date, time, and storage tank or truck identification for each sample collected.

(ii) The name and title of the person who collected the sample and the person who performed the test.

(iii) The results of the test as originally printed by the testing apparatus, or where no printed result is produced, the results as originally recorded by the person who performed the test.

(iv) Any record that contains a test result for the sample that is not identical to the result recorded under paragraph (d)(5)(iii) of this section.

(v) The test methodology used.

(7) For denatured fuel ethanol, the following records shall be kept if the sulfur content of the batch was determined by the alternative means of demonstrating compliance with the sulfur requirements pursuant to the requirements of § 80.1642(c):

(i) The name and title of the person who calculated the sulfur content of the batch.

(ii) The date the calculation was performed.

(iii) The calculated sulfur content.

(iv) The sulfur content of the neat (undenatured) ethanol.

(v) The date each batch of neat ethanol was produced.

(vi) The neat ethanol batch number.

(vii) The neat ethanol batch volume.

(viii) As applicable, the neat ethanol production quality control records, or the test results on the neat ethanol including—

(A) The location, date, time, and storage tank or truck identification for each sample collected.

(B) The name and title of the person who collected the sample and the person who performed the test.

(C) The results of the test as originally printed by the testing apparatus, or where no printed result is produced, the results as originally recorded by the person who performed the test.

(D) Any record that contains a test result for the sample that is not identical to the result recorded under paragraph (d)(7)(v) of this section.

(E) The test methodology used.

(v) The sulfur content of the denaturant(s) used, and the volume percent at which the denaturant(s) were added to neat (un-denatured) ethanol to produce denatured fuel ethanol.

(vi) The product transfer documents for the denaturants used.

(e) *Records that parties who take custody of oxygenates in the oxygenate distribution system must keep.* Beginning January 1, 2017 or the first date when a party takes custody of oxygenate that is represented on the product transfer document as meeting the standards in § 80.1610 (whichever is earlier), all parties that take custody of oxygenate—from the oxygenate producer through to the oxygenate blender—must keep a copy of the product transfer document for each batch of oxygenate.

(f) *Records that must be kept by producers and importers of ethanol denaturant designated as suitable for use in the manufacturer of denatured fuel ethanol meeting federal quality requirements.* Beginning January 1, 2017 or the first date when a producer or importer of ethanol denaturant designated as suitable for use in the manufacturer of denatured fuel ethanol meeting federal quality requirements pursuant to the requirements of § 80.1611 introduces such denaturant into commerce, records of all the following must be kept for each batch of such denaturant produced or imported:

- (1) The date each batch was produced.
- (2) The batch number.
- (3) The batch volume.
- (4) The product transfer document for the batch.
- (5) The sulfur content of the batch.
- (6) The location, date, time, and storage tank or truck identification for each sample collected.

(7) The name and title of the person who collected the sample and the person who performed the test.

(8) The results of the test as originally printed by the testing apparatus, or where no printed result is produced, the results as originally recorded by the person who performed the test.

(9) Any record that contains a test result for the sample that is not identical

to the result recorded under paragraph (f)(5) of this section.

(10) The test methodology used.

(g) *Records that parties who take custody of ethanol denaturants designated as suitable for use in the manufacturer of denatured fuel ethanol meeting federal quality requirements.* Beginning January 1, 2017, all parties that take custody of denaturants designated as suitable for use in the manufacture of DFE pursuant to § 80.1611 must keep the following records:

(1) The product transfer document for the denaturant.

(2) As applicable, the volume percent at which the denaturant was added to neat ethanol.

(h) *Records that producers and importers of gasoline additives as defined in 40 CFR 79.2(f) must keep.* Beginning January 1, 2017 producers and importers of gasoline additives must keep the following records:

- (1) The date the batch was produced.
- (2) The volume of the batch.
- (3) The product transfer document for the batch.
- (4) The maximum recommended treatment rate.

(5) Records of the additive manufacturer's control practices which demonstrate that the additive will contribute no more than 3 ppm on a per gallon basis to the sulfur content of gasoline when used at the maximum recommended treatment rate.

(i) *Records that parties who take custody of gasoline additives in the gasoline additive distribution system must keep.* Beginning January 1, 2017, all parties that take custody of gasoline additives for bulk addition to gasoline from the producer through to the party that adds the additive to gasoline must keep the following records; these requirements of do not apply for gasoline additives packaged for addition to gasoline in the vehicle fuel tank:

- (1) The product transfer document for each batch of gasoline additive.
- (2) As applicable, the treatment at which the additive was added to gasoline.

(3) As applicable, the volume of gasoline that was treated with the additive. A new record shall be initiated in cases where a new batch of additives is mixed into a storage tank from which the additive is drawn to be injected into gasoline.

(j) *Records regarding credits.* The records required under this subpart O shall be kept for five years from the date they were created; except in the following cases:

- (1) *Transfers of credits.* Except as provided in paragraph (f)(2) of this

section, records relating to credit transfers shall be kept by the transferor for five years from the date the credits are transferred; and shall be kept by the transferee for five years from the date the credits were transferred, used, or terminated, whichever is later.

(2) *Credits generated prior to January 1, 2017.* (i) Where the party generating the credits does not transfer the credits, records must be kept for five years from the date of creation, use, or termination, whichever is later.

(ii) When credits generated prior to January 1, 2017 are transferred, records relating to such credits shall be kept by the transferor for five years from the date the credits are transferred; and shall be kept by the transferee for five years from the date the credits were transferred, used, or terminated, whichever is later.

(k) *Make records available to EPA.* On request by EPA, the records required in this section shall be provided to the Administrator's authorized representative. For records that are electronically generated or maintained, the equipment and software necessary to read the records shall be made available; or, if requested by EPA, electronic records shall be converted to paper documents which shall be provided to the Administrator's authorized representative.

#### **§ 80.1654 California gasoline requirements.**

(a) *California gasoline exemption.* California gasoline that complies with all the requirements of this section is exempt from all other provisions of this subpart O.

(b) *Requirements for California gasoline.* (1) Each batch of California gasoline must be designated as such by its refiner or importer.

(2) Designated California gasoline must be kept segregated from gasoline that is not California gasoline, at all points in the distribution system.

(3) Designated California gasoline must ultimately be used in the State of California and not used elsewhere.

(4) For California gasoline produced outside the State of California, the transferors and transferees must meet the product transfer document requirements of paragraph (b)(5) of this section.

(5)(i) Any refiner that operates a refinery located outside the State of California at which California gasoline (as defined in § 80.1600) is produced must provide to any person to whom custody or title of such gasoline has transferred, and each transferee must provide to any subsequent transferee,

documents which include all the following information:

(A) The name and address of the transferor.

(B) The name and address of the transferee.

(C) The volume of gasoline which is being transferred.

(D) The location of the gasoline at the time of the transfer.

(E) The date and time of the transfer.

(F) The identification of the gasoline as California gasoline.

(ii) Each refiner and transferee of California gasoline must maintain copies of the product transfer documents required to be provided by paragraph (b)(5)(i) of this section for a period of five years from the date of creation and shall deliver such documents to the Administrator or to the Administrator's authorized representative upon request.

(6) Gasoline that is ultimately used in any part of the United States outside of the State of California must comply with the standards and requirements of this subpart, regardless of any designation as California gasoline.

(c) *Use of California test methods and offsite sampling procedures.* In the case of any gasoline that is not California gasoline and that is either produced at a refinery located in the State of California or is imported from outside the United States into the State of California, the refiner or importer may, with regard to such gasoline—

(1) Use the sampling and testing methods approved in Title 13 of the California Code of Regulations instead of the sampling and testing methods required under § 80.1630; and

(2) Determine the sulfur content of gasoline at offsite tankage (which would otherwise be prohibited under § 80.65(e)(1)). Note that the requirements of § 80.65(e)(1), regarding when the properties of a batch of reformulated gasoline must be determined, specify that the properties of a batch of gasoline be determined prior to the gasoline leaving the refinery or import facility; however, under this section, a refiner of California gasoline may determine the properties of gasoline as specified under § 80.65(e)(1) at offsite tankage provided that—

(i) The samples are properly collected under the terms of a current and valid protocol agreement between the refiner and the California Air Resources Board with regard to sampling at the offsite tankage and consistent with the requirements prescribed in Title 13, California Code of Regulations, section 2250 et seq. (May 1, 2003); and

(ii) The refiner provides a copy of the protocol agreement to EPA upon request.

**§ 80.1655 National security exemption.**

(a) The standards of § 80.1603 do not apply to gasoline that is produced, imported, sold, offered for sale, supplied, offered for supply, stored, dispensed, or transported for use in any of the following:

(1) Tactical military vehicles, engines, or equipment having an EPA national security exemption from the gasoline emission standards under 40 CFR part 86.

(2) Tactical military vehicles, engines, or equipment that are not subject to a national security exemption from vehicle or engine emissions standards as described in paragraph (a)(1) of this section but, for national security purposes (for purposes of readiness for deployment overseas), need to be fueled on the same gasoline as the vehicles, engines, or equipment for which EPA has granted such a national security exemption.

(b) The exempt fuel must meet all the following conditions:

(1) It must be accompanied by product transfer documents as required under § 80.1651.

(2) It must be segregated from non-exempt gasoline at all points in the distribution system.

(3) It must be dispensed from a fuel pump stand, fueling truck, or tank that is labeled with the appropriate designation of the fuel.

(4) It may not be used in any vehicles, engines, or equipment other than those referred to in paragraph (a) of this section.

(c) Any national security exemptions approved under subpart H of this part will remain in place under this subpart O.

**§ 80.1656 Exemptions for gasoline used for research, development, or testing purposes.**

(a) *Written request for a research and development exemption.* Any person may receive an exemption from the provisions of this subpart for gasoline used for research, development, or testing ("R&D") purposes by submitting the information listed in paragraph (c) of this section to EPA. Applications for R&D exemptions must be submitted to the address in paragraph (h) of this section.

(b) *Criteria for a research and development exemption.* For a research and development exemption to be granted, the person requesting an exemption must do all the following:

(1) Demonstrate a purpose that constitutes an appropriate basis for exemption.

(2) Demonstrate that an exemption is necessary.

(3) Design a research and development program that is reasonable in scope.

(4) Have a degree of control consistent with the purpose of the program and EPA's monitoring requirements.

(c) *Information required to be submitted.* To demonstrate each of the elements in paragraph (b) of this section, the person requesting an exemption must include all the following information:

(1) A concise statement of the purpose of the program demonstrating that the program has an appropriate research and development purpose.

(2) An explanation of why the stated purpose of the program cannot be achieved in a practicable manner without performing one or more of the prohibited acts under this subpart O.

(3) All the following, to demonstrate the reasonableness of the scope of the program:

(i) An estimate of the program's beginning and ending dates.

(ii) An estimate of the maximum number of vehicles or engines involved in the program and the number of miles and engine hours that will be accumulated on each.

(iii) The sulfur content of the gasoline expected to be used in the program.

(iv) The quantity of gasoline which does not comply with the requirements of § 80.1603.

(v) The manner in which the information on vehicles and engines used in the program will be recorded and made available to the Administrator upon request.

(4) With regard to control, a demonstration that the program affords EPA a monitoring capability, including all the following:

(i) A description of the technical and operational aspects of the program.

(ii) The site(s) of the program (including facility name, street address, city, county, state, and zip code).

(iii) The manner in which information on the fuel used in the program (including quantity, fuel properties, name, address, telephone number and contact person of the supplier, and the date received from the supplier), will be recorded and made available to the Administrator upon request.

(iv) The manner in which the party will ensure that the research and development fuel will be segregated from gasoline meeting the standards of this subpart and how fuel pumps will be labeled to ensure proper use of the research and development fuel.

(v) The name, address, telephone number, and title of the person(s) in the organization requesting an exemption from whom further information on the application may be obtained.

(vi) The name, address, telephone number, and title of the person(s) in the organization requesting an exemption who is responsible for recording and making available the information specified in this paragraph (c), and the location where such information will be maintained.

(d) *Additional requirements.* (1) The product transfer documents associated with research and development gasoline must comply with requirements of § 80.1651(c).

(2) The research and development gasoline must be designated by the refiner or supplier, as applicable, as exempt research and development gasoline.

(3) The research and development gasoline must be kept segregated from non-exempt gasoline at all points in the distribution system.

(4) The research and development gasoline must not be sold, distributed, offered for sale or distribution, dispensed, supplied, offered for supply, transported to or from, or stored by a fuel retail outlet, or by a wholesale purchaser-consumer facility, unless the wholesale purchaser-consumer facility is associated with the research and development program that uses the gasoline.

(5) At the completion of the program, any emission control systems or elements of design which are damaged or rendered inoperative shall be replaced on vehicles remaining in service, or the responsible person will be liable for a violation of the Clean Air Act section 203(a)(3) (42 U.S.C. 7522(a)(3)) unless sufficient evidence is supplied that the emission controls or elements of design were not damaged.

(e) *Memorandum of exemption.* The Administrator will grant an R&D exemption upon a demonstration that the requirements of this section have been met. The R&D exemption will be granted in the form of a memorandum of exemption signed by the applicant and the Administrator (or delegate), which may include such terms and conditions as the Administrator determines necessary to monitor the exemption and to carry out the purposes of this section, including restoration of emission control systems.

(1) The volume of fuel subject to the approval shall not exceed the estimated amount under paragraph (c)(3) of this section, unless EPA grants a greater amount in writing.

(2) Any exemption granted under this section will expire at the completion of the test program or three years from the date of approval, whichever occurs first, and may only be extended upon re-application consistent with all requirements of this section.

(3) EPA may elect at any time to review the information contained in the request, and where appropriate may notify the responsible person of disapproval of the exemption.

(4) In granting an exemption the Administrator may include terms and conditions, including replacement of emission control devices or elements of design, that the Administrator determines are necessary for monitoring the exemption and for assuring that the purposes of this subpart are met.

(5) Any violation of a term or condition of the exemption, or of any requirement of this section, will cause the exemption to be void ab initio.

(6) If any information required under paragraph (c) of this section should change after approval of the exemption, the responsible person must notify EPA in writing immediately. Failure to do so may result in disapproval of the exemption or may make it void ab initio, and may make the party liable for a violation of this subpart O.

(f) *Effects of exemption.* Gasoline that is subject to a research and development exemption under this section is exempt from other provisions of this subpart O provided that the fuel is used in a manner that complies with the purpose of the program under paragraph (c) of this section and all other requirements of this section.

(g) *Notification of completion.* The party shall notify EPA in writing within 30 days after completion of the research and development program.

(h) *Submission.* Requests for research and development exemptions shall be sent to the following address: U.S. EPA—Attn: Tier 3 Program (R&D Exemption Request), 6406J, 1200 Pennsylvania Avenue NW., Washington, DC 20460.

#### § 80.1657 [Reserved]

#### § 80.1658 Requirements for gasoline for use in American Samoa, Guam, and the Commonwealth of the Northern Mariana Islands.

The gasoline sulfur standards of this subpart O do not apply to gasoline that is produced, imported, sold, offered for sale, supplied, offered for supply, stored, dispensed, or transported for use in the Territories of Guam, American Samoa or the Commonwealth of the Northern Mariana Islands, provided that such gasoline meets all the following requirements:

(a) The gasoline is designated by the refiner or importer as high sulfur gasoline only for use in Guam, American Samoa, or the Commonwealth of the Northern Mariana Islands.

(b) The gasoline is used only in Guam, American Samoa, or the Commonwealth of the Northern Mariana Islands.

(c) The gasoline is accompanied by documentation that complies with the product transfer document requirements of § 80.1651(c)(3).

(d) The gasoline is segregated from non-exempt high sulfur gasoline at all points in the distribution system from the point the fuel is designated as gasoline only for use in Guam, American Samoa, or the Commonwealth of the Northern Mariana Islands, while the fuel is in the United States but outside these Territories.

#### § 80.1659 [Reserved]

#### § 80.1660 Prohibited acts.

No person shall—

(a) *Averaging violation.* Produce or import gasoline that does not comply with the applicable sulfur average standard under § 80.1603.

(b) *Cap standard violation.* Produce, import, sell, offer for sale, dispense, supply, offer for supply, store or transport gasoline, oxygenate, or ethanol denaturant that does not comply with the applicable sulfur cap standards under § 80.1603, § 80.1604, § 80.1610, or § 80.1611.

(c) *Causing violating gasoline, oxygenate, or ethanol denaturant to be in the distribution system.* Cause gasoline, oxygenate, or ethanol denaturant to be in the distribution system which does not comply with an applicable sulfur cap standard under § 80.1603, § 80.1604, § 80.1610, or § 80.1611.

(d) *Oxygenate violation.* Starting March 1, 2017, blend into gasoline, RBOB, or CBOB any oxygenate, including but not limited to denatured fuel ethanol, that has a sulfur content higher than 10 ppm.

(e) *Additive blender violation.* Unless acting in the capacity of a gasoline refiner or importer under § 80.1613, introduce an additive other than an oxygenate compound into gasoline, CBOB, or RBOB which contributes more than 3 ppm to the sulfur content of the finished gasoline, CBOB, or RBOB.

(f) *Additive manufacturer violation.* Introduce an additive with a maximum allowed treatment rate of less than 1.0 volume percent into gasoline, CBOB, or RBOB which contributes more than 3 ppm to the sulfur content of the finished gasoline, CBOB, or RBOB, or introduce more than 1.0 volume percent of any

additive other than an oxygenate into gasoline, CBOB, or RBOB without complying with all the requirements of this subpart O, including the standards and requirements at § 80.1640 that apply to refiners producing gasoline by blending blendstocks into PCG.

(g) *Denaturant violation.* Cause or contribute to the introduction into commerce of an ethanol denaturant designated as suitable for the production manufacture of denatured fuel ethanol meeting federal quality requirements which does not comply with the requirements of § 80.1611.

(h) *Credit violation.* Generate, transfer, or use invalid credits or improperly transfer or use credits.

(i) *Export violation.* Distribute or dispense gasoline intended for export (pursuant to § 80.1603(b)(3)) for use in the United States.

(j) *Failure to meet a requirement.* Fail to meet a requirement that applies to that person under this subpart.

**§ 80.1661 What evidence may be used to determine compliance with the prohibitions and requirements of this subpart and liability for violations of this subpart?**

(a) Compliance with the sulfur standards of this subpart O shall be determined based on the sulfur level, measured or otherwise determined as applicable using the methodologies specified in §§ 80.47, 80.1611, and 80.1630. Any evidence or information, including the exclusive use of such evidence or information, may be used to establish the sulfur level of gasoline, ethanol denaturant, or oxygenate if the evidence or information is relevant to whether the sulfur level would have been in compliance with the standards if the appropriate sampling and testing methodology or other sulfur determination methodology as applicable had been correctly performed. Such evidence may be obtained from any source or location and may include, but is not limited to, test results using methods other than those specified in §§ 80.47 and 80.1630, business records, and commercial documents.

(b) Determinations of compliance with the requirements of this subpart other than the sulfur standards, and determinations of liability for any violation of this subpart, may be based on information obtained from any source or location. Such information may include, but is not limited to, business records and commercial documents.

**§ 80.1662 Liability for violations.**

The following persons are liable for violations under this subpart:

(a) *Persons liable for violations of prohibited acts.* (1) *Averaging violation.* Any refiner or importer who violates § 80.1660(a) is liable for the violation.

(2) *Causing an averaging violation.* Any refiner, importer, distributor, reseller, carrier, retailer, wholesale purchaser-consumer, oxygenate blender, ethanol denaturant producer, or ethanol denaturant importer who causes another party to violate § 80.1660(a), is liable for a violation of § 80.1660(c).

(3) *Cap standard violation.* Any refiner, gasoline importer, distributor, reseller, carrier, retailer, wholesale purchaser-consumer, oxygenate producer, oxygenate importer, oxygenate blender, ethanol denaturant producer, ethanol denaturant importer, additive manufacturer, or additive blender who owned, leased, operated, controlled or supervised a facility where a violation of § 80.1660(b) occurred, is deemed in violation of § 80.1660(b).

(4) *Causing a cap standard violation.* Any refiner, gasoline importer, distributor, reseller, carrier, retailer, wholesale purchaser-consumer, oxygenate producer, oxygenate importer, oxygenate blender, ethanol denaturant producer, ethanol denaturant importer, additive manufacturer, or additive blender who produced, imported, sold, offered for sale, dispensed, supplied, offered for supply, stored, transported, or caused the transportation or storage of gasoline, oxygenate, or ethanol denaturant that violates § 80.1660(b), is deemed in violation of § 80.1660(c).

(5) *Branded refiner/importer liability.* Any refiner or importer whose corporate, trade, or brand name, or whose marketing subsidiary's corporate, trade, or brand name appeared at a facility where a violation of § 80.1660(b) occurred, is deemed in violation of § 80.1660(b).

(6) *Causing violating gasoline to be in the distribution system.* Any refiner, gasoline importer, distributor, reseller, carrier, oxygenate producer, oxygenate importer, oxygenate blender, ethanol denaturant producer, ethanol denaturant importer, additive manufacturer, or additive blender who owned, leased, operated, controlled or supervised a facility from which gasoline, oxygenate, or ethanol denaturant was released into the distribution system which does not comply with an applicable sulfur cap standard or a sulfur averaging standard is deemed in violation of § 80.1660(d).

(7) *Carrier causation.* In order for a carrier to be liable under paragraph (a)(2), (a)(3), (a)(4), or (a)(6) of this section, EPA must demonstrate, by reasonably specific showing by direct or

circumstantial evidence, that the carrier caused the violation.

(8) *Oxygenate blender violation.* Any oxygenate blender who violates § 80.1660(e) is liable for the violation.

(9) *Additive manufacturer violation.* Any additive manufacturer who violates § 80.1660(g) is deemed liable for the violation.

(10) *Additive blender violation.* Any additive blender who violates § 80.1660(f) is deemed liable for the violation.

(11) *Credit violation.* Any refiner or importer who violates § 80.1660(h) is liable for the violation.

(12) *Parent corporation liability.* Any parent corporation is liable for any violations of this subpart that are committed by any of its wholly-owned subsidiaries.

(13) *Joint venture and joint owner liability.* Each partner to a joint venture, or each owner of a facility owned by two or more owners, is jointly and severally liable for any violation of this subpart that occurs at the joint venture facility or facility owned by the joint owners, or is committed by the joint venture operation or any of the joint owners of the facility.

(b) *Persons liable for failure to meet other provisions of this subpart.* Any person who—

(1) Fails to comply with a provision of this subpart not addressed in paragraph (a) of this section is liable for a violation of that provision.

(2) Causes another person to fail to meet a requirement of this subpart not addressed in paragraph (a) of this section is liable for causing a violation of that provision.

**§ 80.1663 Defenses for a violation of a prohibited act.**

(a) Any person deemed liable for a violation of a prohibition under § 80.1662(a)(3) through (10), will not be deemed in violation if the person demonstrates all the following:

(1) The violation was not caused by the person or the person's employee or agent.

(2) In cases where product transfer document requirements under this subpart apply, the product transfer documents account for the fuel found to be in violation and indicate that the violating product was in compliance with the applicable requirements while in that person's control; and

(3) The person conducted a quality assurance sampling and testing program, as described in paragraph (d) of this section. A carrier may rely on the quality assurance program carried out by another party, including the party who owns the gasoline in question,

provided that the quality assurance program is carried out properly. Retailers and wholesale purchaser-consumers are not required to conduct sampling and testing of gasoline as part of their quality assurance programs.

(b) In the case of a violation found at a facility operating under the corporate, trade or brand name of a refiner or importer, or a refiner's or importer's marketing subsidiary, the refiner or importer must show, in addition to the defense elements required under paragraphs (a)(1) through (3) of this section, that the violation was caused by any of the following:

(1) An act in violation of law (other than the Clean Air Act or this part 80), or an act of sabotage or vandalism.

(2) The action of any refiner, gasoline importer, retailer, distributor, reseller, oxygenate blender, carrier, retailer or wholesale purchaser-consumer in violation of a contractual agreement between the branded refiner or importer and the person designed to prevent such action, and despite periodic sampling and testing by the branded refiner or importer to ensure compliance with such contractual obligation.

(3) The action of any carrier or other distributor not subject to a contract with the refiner or importer, but engaged for transportation of gasoline, oxygenate, or ethanol denaturant despite specifications or inspections of procedures and equipment which are reasonably calculated to prevent such action.

(c) Under paragraph (a) of this section, for any person to show that a violation was not caused by that person, or under paragraph (b) of this section to show that a violation was caused by any of the specified actions, the person must demonstrate by reasonably specific showings, by direct or circumstantial evidence, that the violation was caused or must have been caused by another person and that the person asserting the defense did not contribute to that other person's causation.

(d) To demonstrate an acceptable quality assurance and testing program under paragraph (a)(2) of this section, a person must present evidence of all the following:

(1) A periodic sampling and testing program to ensure the gasoline the person sold, dispensed, supplied, stored, or transported, meets the applicable sulfur standard.

(2) On each occasion when gasoline is found not in compliance with the applicable sulfur standard—

(i) The person immediately ceases selling, offering for sale, dispensing, supplying, offering for supply, storing or

transporting the non-complying product; and

(ii) The person promptly remedies the violation and the factors that caused the violation (for example, by removing the non-complying product from the distribution system until the applicable standard is achieved and taking steps to prevent future violations of a similar nature from occurring).

(3) For any carrier who transports gasoline in a tank truck, the quality assurance program required under this paragraph (d) need not include periodic sampling and testing of gasoline in the tank truck, but in lieu of such tank truck sampling and testing, the carrier shall demonstrate evidence of an oversight program for monitoring compliance with the requirements of this subpart relating to the transport or storage of gasoline by tank truck, such as appropriate guidance to drivers regarding compliance with the applicable sulfur standard and product transfer document requirements, and the periodic review of records received in the ordinary course of business concerning gasoline quality and delivery.

#### § 80.1664 [Reserved]

#### § 80.1665 Penalties.

(a) Any person liable for a violation under § 80.1662 is subject to civil penalties as specified in section 205 of the Clean Air Act (42 U.S.C. 7524) for every day of each such violation and the amount of economic benefit or savings resulting from each violation.

(b) Any person liable under § 80.1662(a)(1) or (a)(2) for a violation of the applicable sulfur averaging standard or causing another party to violate that standard during any averaging period, is subject to a separate day of violation for each and every day in the averaging period. Any person liable under § 80.1662(a)(11) or (b) for a failure to fulfill any requirement for credit generation, transfer, use, banking, or deficit correction, is subject to a separate day of violation for each and every day in the averaging period in which invalid credits are generated or used.

(c)(1) Any person liable under § 80.1662(a)(3) through (10) for a violation of an applicable sulfur per gallon cap standard under this subpart O or of causing another party to violate a cap standard, is subject to a separate day of violation for each and every day the non-complying gasoline remains any place in the gasoline distribution system.

(2) Any person liable under § 80.1662(a)(6) for causing gasoline,

oxygenate, or ethanol denaturant to be in the distribution system which does not comply with an applicable sulfur cap standard, or a sulfur averaging standard, is subject to a separate day of violation for each and every day that the non-complying gasoline, oxygenate, or ethanol denaturant remains any place in the gasoline, oxygenate, or ethanol denaturant distribution system.

(3) For purposes of this paragraph (c), the length of time the gasoline, oxygenate, or ethanol denaturant in question remained in the gasoline, oxygenate, or ethanol denaturant distribution system is deemed to be twenty-five days, unless a person subject to liability or EPA demonstrates by reasonably specific showings, by direct or circumstantial evidence, that the non-complying gasoline, oxygenate, or ethanol denaturant remained in the gasoline, oxygenate, or ethanol denaturant distribution system for fewer than or more than twenty-five days.

(d) Any person liable under § 80.1662(b) for failure to meet, or causing a failure to meet, a provision of this subpart is liable for a separate day of violation for each and every day such provision remains unfulfilled.

#### § 80.1666 Additional requirements for foreign small refiners and foreign small volume refineries.

The provisions of this section apply to certain foreign refiners and importers during the period January 1, 2017 through December 31, 2019. After December 31, 2019, foreign refiners are not subject to compliance requirements under subpart H of this part, or this subpart O; instead, the importer of any foreign-produced gasoline shall be responsible for compliance with the standards and requirements of this subpart O that relate to importers.

(a) *Definitions.* (1) *Foreign small refiner* is a foreign refiner that meets the definition of a small refiner under § 80.1620.

(2) *Foreign small volume refinery* is a foreign refinery that meets the definition of a small volume refinery under § 80.1621.

(3) *Sulfur-FRGAS*, for this subpart, means gasoline produced from January 1, 2017 through December 31, 2019, at a foreign refinery of a refiner that has been approved as a small refiner or a small volume refinery under § 80.1622, and that is imported into the United States.

(4) *Non-Sulfur-FRGAS* means gasoline that is produced at a foreign refinery that has not been approved as a small refiner refinery or small volume refinery under § 80.1622, gasoline produced at a foreign refinery of an approved small

refiner or at an approved small volume refinery under § 80.1622 that is not imported into the United States, and gasoline produced at a foreign refinery that is approved during a year when the foreign refiner has opted to not participate in the Sulfur-FRGAS program under paragraph (c)(3) of this section.

(5) *Certified Sulfur-FRGAS* means Sulfur-FRGAS the foreign refiner intends to include in the foreign refinery's sulfur compliance calculations under §§ 80.195 and 80.205 and does include in these compliance calculations when reported to EPA.

(6) *Non-Certified Sulfur-FRGAS* means Sulfur-FRGAS that is not Certified Sulfur-FRGAS.

(b) *Petition for approval of small refiner or small volume refinery status.* To be approved for small refiner status or small volume refinery status a foreign refiner must submit a petition for approval as provided under § 80.1622 and this section. If small refiner status or small volume refinery status is approved, the foreign refiner may produce gasoline for export to the United States, during the period starting January 1, 2017 and ending December 31, 2019, that is subject to the sulfur content standards of subpart H of this part at § 80.195 that were applicable to refiners from 2006 through 2016. A foreign refiner is not eligible to generate sulfur credits under subpart H of this part or this subpart O, as this occurs through the importer.

(c) *General requirements for foreign refiners approved as small refiners or small volume refinery status.* A foreign refiner of a refinery that has been approved as a small refiner refinery or a small volume refinery must designate all gasoline produced at the foreign refinery that is exported to the United States as either Certified Sulfur-FRGAS or as Non-Certified Sulfur-FRGAS, except as provided in paragraph (c)(3) of this section.

(1) In the case of Certified Sulfur-FRGAS, the foreign refiner must meet the sulfur standards of subpart H of this part as described in paragraph (b) of this section and the requirements of this section.

(2) In the case of Non-Certified Sulfur-FRGAS, the foreign refiner shall meet all the following provisions, except the foreign refiner shall substitute the name Non-Certified Sulfur-FRGAS for the names "reformulated gasoline" or "RBOB" wherever they appear in the following provisions:

(i) The designation requirements in this section.

(ii) The recordkeeping requirements under § 80.1653.

(iii) The reporting requirements in § 80.1652 and this section.

(iv) The product transfer document requirements in § 80.1651 and this section.

(v) The prohibitions in § 80.1660 and this section.

(vi) The independent audit requirements under § 80.415 and paragraph (h) of this section; and the attest engagement provisions of §§ 80.125 through 80.127, 80.128(a), (b), (c), and (g) through (i), and 80.130.

(3)(i) Any foreign refiner that has been approved as a small refiner or whose refinery has been approved as a small volume refinery under this subpart O may elect to classify no gasoline imported into the United States as Sulfur-FRGAS, provided the foreign refiner notifies EPA of the election no later than November 1 of the prior calendar year.

(ii) An election under paragraph (c)(3)(i) of this section shall meet all the following requirements:

(A) Apply to an entire calendar year averaging period, and apply to all gasoline produced during the calendar year at the foreign refinery that is used in the United States.

(B) Remain in effect for each succeeding calendar year averaging period, unless and until the foreign refiner notifies EPA of a termination of the election. The change in election shall take effect at the beginning of the next calendar year.

(d) *Designation, product transfer documents, and foreign refiner certification.* (1) Any approved foreign small refiner or any foreign refiner having an approved small volume refinery under this subpart O must designate each batch of Sulfur-FRGAS as such at the time the gasoline is produced, unless the refinery has elected to classify no gasoline exported to the United States as Sulfur-FRGAS under paragraph (c)(3)(i) of this section.

(2) On each occasion when any person transfers custody or title to any Sulfur-FRGAS prior to its being imported into the United States, it must include all the following information as part of the product transfer document information in this section:

(i) Identification of the gasoline as Certified Sulfur-FRGAS or as Non-Certified Sulfur-FRGAS.

(ii) The name and EPA refinery registration number of the refinery where the Sulfur-FRGAS was produced.

(3) On each occasion when Sulfur-FRGAS is loaded onto a vessel or other transportation mode for transport to the United States, the foreign refiner shall prepare a certification for each batch of

the Sulfur-FRGAS that meets all the following requirements:

(i) The certification shall include the report of the independent third party under paragraph (f) of this section, and all the following additional information:

(A) The name and EPA registration number of the refinery that produced the Sulfur-FRGAS.

(B) The identification of the gasoline as Certified Sulfur-FRGAS or Non-Certified Sulfur-FRGAS.

(C) The volume of Sulfur-FRGAS being transported, in gallons.

(D) In the case of Certified Sulfur-FRGAS, the sulfur content as determined under paragraph (f) of this section, and a declaration that the Sulfur-FRGAS is being included in the compliance calculations under § 80.205 for the refinery that produced the Sulfur-FRGAS.

(ii) The certification shall be made part of the product transfer documents for the Sulfur-FRGAS.

(e) *Transfers of Sulfur-FRGAS to non-U.S. markets.* The foreign refiner is responsible to ensure that all gasoline classified as Sulfur-FRGAS is imported into the United States. A foreign refiner may remove the Sulfur-FRGAS classification, and the gasoline need not be imported into the United States, but only if—

(1)(i) The foreign refiner excludes the volume and sulfur content of the gasoline from the compliance calculations under § 80.205.

(ii) The exclusions under paragraph (e)(1)(i) of this section shall be on the basis of the sulfur content and volumes determined under paragraph (f) of this section; and

(2) The foreign refiner obtains sufficient evidence in the form of documentation that the gasoline was not imported into the United States.

(f) *Load port independent sampling, testing and refinery identification.* (1) On each occasion Sulfur-FRGAS is loaded onto a vessel for transport to the United States a foreign refiner shall have an independent third party do all the following:

(i) Inspect the vessel prior to loading and determine the volume of any tank bottoms.

(ii) Determine the volume of Sulfur-FRGAS loaded onto the vessel (exclusive of any tank bottoms present before vessel loading).

(iii) Obtain the EPA-assigned registration number of the foreign refinery.

(iv) Determine the name and country of registration of the vessel used to transport the Sulfur-FRGAS to the United States.



(v) Determine the date and time the vessel departs the port serving the foreign refinery.

(2) On each occasion Certified Sulfur-FRGAS is loaded onto a vessel for transport to the United States a foreign refiner shall have an independent third party—

(i) Collect a representative sample of the Certified Sulfur-FRGAS from each vessel compartment subsequent to loading on the vessel and prior to departure of the vessel from the port serving the foreign refinery.

(ii) Prepare a volume-weighted vessel composite sample from the compartment samples, and determine the value for sulfur in accordance with the methodology and requirements specified in § 80.1630, by either of the following:

(A) The third party analyzing the sample.

(B) The third party observing the foreign refiner analyzing the sample.

(iii) Review original documents that reflect movement and storage of the certified Sulfur-FRGAS from the refinery to the load port, and from this review determine all the following:

(A) The refinery at which the Sulfur-FRGAS was produced.

(B) That the Sulfur-FRGAS remained segregated from Non-Sulfur-FRGAS, Non-Certified Sulfur-FRGAS, and other Certified Sulfur-FRGAS produced at a different refinery.

(3) The independent third party shall submit a report—

(i) To the foreign refiner containing the information required under paragraphs (f)(1) and (2) of this section, to accompany the product transfer documents for the vessel; and

(ii) To the Administrator containing the information required under paragraphs (f)(1) and (2) of this section, within thirty days following the date of the independent third party's inspection. This report shall include a description of the method used to determine the identity of the refinery at which the gasoline was produced, assurance that the gasoline remained segregated as specified in paragraph (m)(1) of this section, and a description of the gasoline's movement and storage between production at the source refinery and vessel loading.

(4) The independent third party must do all the following:

(i) Be approved in advance by EPA, based on a demonstration of ability to perform the procedures required in this paragraph (f).

(ii) Be independent under the criteria specified in § 80.65(f)(2)(iii).

(iii) Sign a commitment that contains the provisions specified in paragraph (i)

of this section with regard to activities, facilities and documents relevant to compliance with the requirements of this paragraph (f).

(g) *Comparison of load port and port of entry testing.* (1)(i) Except as described in paragraph (g)(1)(ii) of this section, any foreign refiner and any U.S. importer of Certified Sulfur-FRGAS shall compare the results from the load port testing under paragraph (f) of this section, with the port of entry testing as reported under paragraph (o) of this section, for the volume of gasoline and the sulfur value.

(ii) Where a vessel transporting Certified Sulfur-FRGAS off loads this gasoline at more than one U.S. port of entry, and the conditions of paragraph (g)(2) of this section are met at the first U.S. port of entry, the requirements of paragraph (g)(2) of this section do not apply at subsequent ports of entry if the U.S. importer obtains a certification from the vessel owner, meeting the requirements of paragraph (r) of this section that the vessel has not loaded any gasoline or blendstock between the first U.S. port of entry and the subsequent port of entry.

(2) The U.S. importer and the foreign refiner shall treat the gasoline as Non-Certified Sulfur-FRGAS, and the foreign refiner shall exclude the gasoline volume and properties from its gasoline sulfur compliance calculations under § 80.205 under either of the following circumstances:

(i) The temperature-corrected volumes determined at the port of entry and at the load port differ by more than one percent.

(ii) The sulfur value determined at the port of entry is higher than the sulfur value determined at the load port, and the amount of this difference is greater than the reproducibility amount specified for the port of entry test result by ASTM.

(h) *Attest requirements.* All the following additional procedures shall be carried out by any foreign refiner of Sulfur-FRGAS as part of the applicable attest engagement for each foreign refinery under § 80.415:

(1) The inventory reconciliation analysis under the attest engagement provisions of § 80.128(b) and the tender analysis under § 80.128(c) shall include Non-Sulfur-FRGAS in addition to the gasoline types listed in § 80.128(b) and (c).

(2) Obtain separate listings of all tenders of Certified Sulfur-FRGAS, and of Non-Certified Sulfur-FRGAS. Agree the total volume of tenders from the listings to the gasoline inventory reconciliation analysis in the attest engagement provisions of § 80.128(b),

and to the volumes determined by the third party under paragraph (f)(1) of this section.

(3) For each tender under paragraph (h)(2) of this section where the gasoline is loaded onto a marine vessel, report as a finding the name and country of registration of each vessel, and the volumes of Sulfur-FRGAS loaded onto each vessel.

(4) Select a sample from the list of vessels identified in paragraph (h)(3) of this section used to transport Certified Sulfur-FRGAS, in accordance with the attest engagement guidelines in § 80.127, and for each vessel selected perform all the following:

(i) Obtain the report of the independent third party, under paragraph (f) of this section, and of the U.S. importer under paragraph (n) of this section.

(A) Agree the information in these reports with regard to vessel identification, gasoline volumes and test results.

(B) Identify, and report as a finding, each occasion the load port and port of entry parameter and volume results differ by more than the amounts allowed in paragraph (g) of this section, and determine whether the foreign refiner adjusted its refinery calculations as required in paragraph (g) of this section.

(ii) Obtain the documents used by the independent third party to determine transportation and storage of the Certified Sulfur-FRGAS from the refinery to the load port, under paragraph (f) of this section. Obtain tank activity records for any storage tank where the Certified Sulfur-FRGAS is stored, and pipeline activity records for any pipeline used to transport the Certified Sulfur-FRGAS, prior to being loaded onto the vessel. Use these records to determine whether the Certified Sulfur-FRGAS was produced at the refinery that is the subject of the attest engagement, and whether the Certified Sulfur-FRGAS was mixed with any Non-Certified Sulfur-FRGAS, Non-Sulfur-FRGAS, or any Certified Sulfur-FRGAS produced at a different refinery.

(5) Select a sample from the list of vessels identified in paragraph (h)(3) of this section used to transport certified and Non-Certified Sulfur-FRGAS, in accordance with the attest engagement guidelines of § 80.127, and for each vessel selected perform the following:

(i) Obtain a commercial document of general circulation that lists vessel arrivals and departures, and that includes the port and date of departure of the vessel, and the port of entry and date of arrival of the vessel.

(ii) Agree the vessel's departure and arrival locations and dates from the independent third party and U.S. importer reports to the information contained in the commercial document.

(6) Obtain separate listings of all tenders of Non-Sulfur-FRGAS, and perform all the following:

(i) Agree the total volume of tenders from the listings to the gasoline inventory reconciliation analysis in § 80.128(b).

(ii) Obtain a separate listing of the tenders under this paragraph (h)(6) where the gasoline is loaded onto a marine vessel. Select a sample from this listing in accordance with the guidelines in § 80.127, and obtain a commercial document of general circulation that lists vessel arrivals and departures, and that includes the port and date of departure and the ports and dates where the gasoline was off loaded for the selected vessels. Determine and report as a finding the country where the gasoline was off loaded for each vessel selected.

(7) In order to complete the requirements of this paragraph (h) an auditor must—

(i) Be independent of the foreign refiner.

(ii) Be licensed as a Certified Public Accountant in the United States and a citizen of the United States, or be approved in advance by EPA based on a demonstration of ability to perform the procedures required in the attest engagement provisions of §§ 80.125 through 80.130, 80.415 and this paragraph (h).

(iii) Sign a commitment that contains the provisions specified in this paragraph (h) with regard to activities and documents relevant to compliance with the requirements of the attest engagement provisions of §§ 80.125 through 80.130, 80.415 and this paragraph (h).

(i) *Foreign refiner commitments.* Any foreign refiner shall commit to and comply with the following provisions as a condition to being approved for small refiner status or small volume refinery status:

(1) Any U.S. EPA inspector or auditor will be given complete and immediate access to conduct inspections and audits of the foreign refinery.

(i) Inspections and audits may be either announced in advance by EPA, or unannounced.

(ii) Access will be provided to any location where—

(A) Gasoline is produced;

(B) Documents related to refinery operations are kept;

(C) Gasoline or blendstock samples are tested or stored; and

(D) Sulfur-FRGAS is stored or transported between the foreign refinery and the United States, including storage tanks, vessels and pipelines.

(iii) Inspections and audits may be by EPA employees or contractors to EPA.

(iv) Any documents requested that are related to matters covered by inspections and audits will be provided to an EPA inspector or auditor on request.

(v) Inspections and audits by EPA may include review and copying of any documents related to all the following:

(A) Approval of the refiner as a small refiner or approval of the refinery as a small volume refinery.

(B) The volume and sulfur content of Sulfur-FRGAS.

(C) The proper classification of gasoline as being Sulfur-FRGAS or as not being Sulfur-FRGAS, or as Certified Sulfur-FRGAS or as Non-Certified Sulfur-FRGAS.

(D) Transfers of title or custody to Sulfur-FRGAS.

(E) Sampling and testing of Sulfur-FRGAS.

(F) Work performed and reports prepared by independent third parties and by independent auditors under the requirements of this section and § 80.415, including work papers.

(G) Reports prepared for submission to EPA, and any work papers related to such reports.

(vi) Inspections and audits by EPA may include taking samples of gasoline or blendstock, and interviewing employees.

(vii) Any employee of the foreign refiner must be made available for interview by the EPA inspector or auditor, on request, within a reasonable time period.

(viii) English language translations of any documents must be provided to an EPA inspector or auditor, on request, within 10 working days.

(ix) English language interpreters must be provided to accompany EPA inspectors and auditors, on request.

(2) An agent for service located in the District of Columbia will be named. Service on this agent constitutes service on the foreign refiner or any employee of the foreign refiner for any action by EPA or otherwise by the United States related to the requirements of this subpart O.

(3) The forum for any civil or criminal enforcement action related to the provisions of this section for violations of the Clean Air Act or regulations promulgated thereunder shall be governed by the Clean Air Act, including the EPA administrative forum where allowed under the Clean Air Act.

(4) The substantive and procedural laws of the United States shall apply to

any civil or criminal enforcement action against the foreign refiner or any employee of the foreign refiner related to the provisions of this section.

(5) Submitting a petition for approval as a small refiner or for small volume refinery status, producing and exporting gasoline under such approval, and all other actions to comply with the requirements of this subpart O constitute actions or activities that satisfy the provisions of 28 U.S.C. 1605(a)(2), but solely with respect to actions instituted against the foreign refiner, its agents and employees in any court or other tribunal in the United States for conduct that violates the requirements applicable to the foreign refiner under this subpart O, including conduct that violates 18 U.S.C. 1001 or Clean Air Act section 113(c)(2) (42 U.S.C. 7413(c)(2)).

(6) The foreign refiner, or its agents or employees, must not seek to detain or to impose civil or criminal remedies against EPA inspectors or auditors, whether EPA employees or EPA contractors, for actions performed within the scope of EPA employment related to the provisions of this section.

(7) The commitment required by this paragraph (i) must be signed by the owner or president of the foreign refiner business.

(8) In any case where FRGAS produced at a foreign refinery is stored or transported by another company between the refinery and the vessel that transports the Sulfur-FRGAS to the United States, the foreign refiner shall obtain from each such other company a commitment that meets the requirements specified in paragraphs (i)(1) through (7) of this section.

(j) *Sovereign immunity.* By submitting a petition for approval as a small refiner or approval of a small volume refinery under this subpart O and this section, or by producing and exporting gasoline to the United States under such an approval under this section, the foreign refiner, its agents and employees, without exception, become subject to the full operation of the administrative and judicial enforcement powers and provisions of the United States without limitation based on sovereign immunity, with respect to actions instituted against the foreign refiner, its agents and employees in any court or other tribunal in the United States for conduct that violates the requirements applicable to the foreign refiner under this subpart O, including conduct that violates 18 U.S.C. 1001 or Clean Air Act section 113(c)(2) (42 U.S.C. 7413(c)(2)).

(k) *Bond posting.* Any foreign refiner must meet the following requirements as a condition to being approved for

small refiner or small volume refinery status:

(l) The foreign refiner shall post a bond of the amount calculated using the following equation:

$$\text{Bond} = G \times \$ 0.01$$

Where:

Bond = Amount of the bond in U. S. dollars.

G = The largest volume of gasoline produced at the foreign refinery and exported to the United States, in gallons, during a single calendar year among the most recent of the following calendar years, up to a maximum of three calendar years: the calendar year immediately preceding the date the approval petition is submitted, the calendar year the approval petition is submitted, and each succeeding calendar year.

(2) Bonds shall be posted by performing any of the following:

(i) Paying the amount of the bond to the Treasurer of the United States.

(ii) Obtaining a bond in the proper amount from a third party surety agent that is payable to satisfy U.S. administrative or judicial judgments against the foreign refiner, provided EPA agrees in advance as to the third party and the nature of the surety agreement.

(iii) An alternative commitment that results in assets of an appropriate liquidity and value being readily available to the United States, provided EPA agrees in advance as to the alternative commitment.

(3) If the bond amount for a foreign refinery increases, the foreign refiner shall increase the bond to cover the shortfall within 90 days of the date the bond amount changes. If the bond amount decreases, the foreign refiner may reduce the amount of the bond beginning 90 days after the date the bond amount changes.

(4) Bonds posted under this paragraph (k) shall—

(i) Be used to satisfy any judicial judgment that results from an administrative or judicial enforcement action for conduct in violation of this subpart O, including where such conduct violates 18 U.S.C. 1001 and Clean Air Act section 113(c)(2) (42 U.S.C. 7413(c)(2));

(ii) Be provided by a corporate surety that is listed in the U.S. Department of Treasury Circular 570 “Companies Holding Certificates of Authority as Acceptable Sureties on Federal Bonds and Acceptable Reinsuring Companies” (Available from the U.S. Department of the Treasury, Financial Management Service, Surety Bond Branch, 3700 East-West Highway, Room 6A04, Hyattsville, MD, 20782. Also available on the Internet at <http://www.fms.treas.gov/c570/c570.html>); and

(iii) Include a commitment that the bond will remain in effect for at least five years following the end of latest averaging period that the foreign refiner produces gasoline pursuant to the requirements of this subpart O.

(5) On any occasion a foreign refiner bond is used to satisfy any judgment, the foreign refiner shall increase the bond to cover the amount used within 90 days of the date the bond is used.

(l) *English language reports.* Any report or other document submitted to EPA by any foreign refiner must be in English, or must include an English language translation.

(m) *Prohibitions.* (1) No person may combine Certified Sulfur-FRGAS with any Non-Certified Sulfur-FRGAS or Non-Sulfur-FRGAS, and no person may combine Certified Sulfur-FRGAS with any Certified Sulfur-FRGAS produced at a different refinery, until the importer has met all the requirements of paragraph (n) of this section, except as provided in paragraph (e) of this section.

(2) No foreign refiner or other person may cause another person to commit an action prohibited in paragraph (m)(1) of this section, or that otherwise violates the requirements of this section.

(n) *U.S. importer requirements.* Any U.S. importer shall meet the following requirements:

(1) Each batch of imported gasoline shall be classified by the importer as being Sulfur-FRGAS or as Non-Sulfur-FRGAS, and each batch classified as Sulfur-FRGAS shall be further classified as Certified Sulfur-FRGAS or as Non-certified Sulfur-FRGAS.

(2) Gasoline shall be classified as Certified Sulfur-FRGAS or as Non-Certified Sulfur-FRGAS according to the designation by the foreign refiner if this designation is supported by product transfer documents prepared by the foreign refiner as required in paragraph (d) of this section, unless the gasoline is classified as Non-Certified Sulfur-FRGAS under paragraph (g) of this section.

(3) For each gasoline batch classified as Sulfur-FRGAS, any U.S. importer shall perform the following procedures:

(i) In the case of both Certified and Non-Certified Sulfur-FRGAS, have an independent third party—

(A) Determine the volume of gasoline in the vessel.

(B) Use the foreign refiner's Sulfur-FRGAS certification to determine the name and EPA-assigned registration number of the foreign refinery that produced the Sulfur-FRGAS.

(C) Determine the name and country of registration of the vessel used to

transport the Sulfur-FRGAS to the United States.

(D) Determine the date and time the vessel arrives at the U.S. port of entry.

(ii) In the case of Certified Sulfur-FRGAS, have an independent third party—

(A) Collect a representative sample from each vessel compartment subsequent to the vessel's arrival at the U.S. port of entry and prior to off loading any gasoline from the vessel.

(B) Prepare a volume-weighted vessel composite sample from the compartment samples.

(C) Determine the sulfur value using the methodologies specified in § 80.1630, by the third party analyzing the sample, or by the third party observing the importer analyzing the sample.

(4) Any importer shall submit reports within thirty days following the date any vessel transporting Sulfur-FRGAS arrives at the U.S. port of entry—

(i) To the Administrator containing the information determined under paragraph (n)(3) of this section; and

(ii) To the foreign refiner containing the information determined under paragraph (n)(3) of this section.

(5) Any U.S. importer shall meet the applicable requirements of this subpart O, including sulfur content standards specified in § 80.1603, for any imported gasoline that is not classified as Certified Sulfur-FRGAS under paragraph (n)(2) of this section.

(o) *Truck imports of Certified Sulfur-FRGAS produced by a foreign small refiner or foreign small volume refinery.*

(1) Any refiner whose Certified Sulfur-FRGAS is transported into the United States by truck may petition EPA to use alternative procedures to meet all the following requirements:

(i) Certification under paragraph (d)(5) of this section.

(ii) Load port and port of entry sampling and testing under paragraphs (f) and (g) of this section.

(iii) Attest under paragraph (h) of this section.

(iv) Importer testing under paragraph (n)(3) of this section.

(2) These alternative procedures must ensure Certified Sulfur-FRGAS remains segregated from Non-Certified Sulfur-FRGAS and from Non-Sulfur-FRGAS until it is imported into the United States. The petition will be evaluated based on whether it adequately addresses all the following:

(i) Provisions for monitoring pipeline shipments, if applicable, from the refinery, that ensure segregation of Certified Sulfur-FRGAS from that refinery from all other gasoline.

(ii) Contracts with any terminals and/or pipelines that receive and/or

transport Certified Sulfur-FRGAS, that prohibit the commingling of such Certified Sulfur-FRGAS with any of the following:

(A) Other Certified Sulfur-FRGAS from other refineries.

(B) All Non-Certified Sulfur-FRGAS.

(C) All Non-Sulfur-FRGAS

(iii) Procedures for obtaining and reviewing truck loading records and U.S. import documents for Certified Sulfur-FRGAS to ensure that such gasoline is only loaded into trucks making deliveries to the United States.

(iv) Attest procedures to be conducted annually by an independent third party that review loading records and import documents based on volume reconciliation, or other criteria, to confirm that all Certified Sulfur-FRGAS remains segregated throughout the distribution system and is only loaded into trucks for import into the United States.

(3) The petition required by this section must be submitted to EPA along with the application for small refiner status or small volume refinery status under § 80.1622 and this section.

(p) *Withdrawal or suspension of a foreign refinery's small refiner or small volume refinery status approval.* EPA may withdraw or suspend approval where any of the following occur:

(1) A foreign refiner fails to meet any requirement of this section.

(2) A foreign government fails to allow EPA inspections as provided in paragraph (i)(1) of this section.

(3) A foreign refiner asserts a claim of, or a right to claim, sovereign immunity in an action to enforce the requirements in this subpart O.

(4) A foreign refiner fails to pay a civil or criminal penalty that is not satisfied using the foreign refiner bond specified in paragraph (k) of this section.

(q) [Reserved]

(r) *Additional requirements for petitions, reports and certificates.* Any petition for approval, any alternative procedures under paragraph (o) of this section, and any certification under paragraph (d)(3) of this section shall be—

(1) Submitted in accordance with procedures specified by the Administrator, including use of any forms that may be specified by the Administrator; and

(2) Be signed by the president or owner of the foreign refiner company, or by that person's immediate designee, and shall contain the following declaration:

I hereby certify: (1) That I have actual authority to sign on behalf of and to bind [insert name of foreign refiner] with regard to all statements contained

herein; (2) that I am aware that the information contained herein is being certified, or submitted to the United States Environmental Protection Agency, under the applicable requirements of 40 CFR part 80, subparts H and O, and that the information is material for determining compliance under these regulations; and (3) that I have read and understand the information being certified or submitted, and this information is true, complete and correct to the best of my knowledge and belief after I have taken reasonable and appropriate steps to verify the accuracy thereof.

I affirm that I have read and understand the provisions of 40 CFR part 80, subpart O, including 40 CFR 80.1666 [insert name of foreign refiner]. Pursuant to Clean Air Act section 113(c) and 18 U.S.C. 1001, the penalty for furnishing false, incomplete or misleading information in this certification or submission is a fine of up to \$10,000, and/or imprisonment for up to five years.

#### **§ 80.1667 Attest engagement requirements.**

In addition to the requirements for attest engagements that apply to refiners and importers under §§ 80.125 through 80.130, 80.1666, and other sections of this part 80 the attest engagements for importers and refiners must include the following procedures and requirements each year.

(a) *Refiners subject to national standards and Small Refiner and Small Volume Refinery Status.* (1) If the refiner asserts small refinery status or small volume refinery status for the refinery, obtain the EPA approval letter for the refinery to determine the refinery's applicable annual average standard and credit generation status.

(2) Determine whether the refinery applied the correct annual average sulfur standard and whether it was eligible to generate credits and report the finding.

(3) If the annual average sulfur standard is incorrect or credit generation was inappropriate, recalculate compliance using the appropriate sulfur standard and using appropriate credits and report as a finding.

(b) *EPA reports.* (1) Obtain and read a copy of the refinery's or importer's annual sulfur reports filed with EPA for the year.

(2) Agree the yearly volume of gasoline reported to EPA in the sulfur reports with the inventory reconciliation analysis under the attest engagement provisions of § 80.128.

(3) Calculate the annual average sulfur level for all gasoline and agree that value with the value reported to EPA.

(4) Obtain and read a copy of the refinery's or importer's sulfur credit report.

(5) Agree the information in the refinery's or importer's batch reports filed with EPA under §§ 80.75 and 80.105, and any laboratory test results, with the information contained in the annual sulfur report required under § 80.1652.

(c) *Credit generation before 2017.* In the case of a refinery that generates credits during 2014 through 2016—

(1) Obtain a written representation from the company representative stating the refinery produces gasoline from crude oil.

(2) Obtain the annual average sulfur level from paragraph (b)(3) of this section.

(3) Compute and report as a finding the total number of sulfur credits generated, and agree this value with the value reported to EPA.

(d) *Credit generation in 2017 and thereafter.* The following procedures shall be completed for a refinery or importer that generates credits in 2017 and thereafter:

(1) Obtain the annual average sulfur level for gasoline from paragraph (b)(3) of this section.

(2) If the sulfur value under paragraph (d)(1) of this section is less than 10 ppm, compute and report as a finding the difference between the sulfur level under paragraph (d)(1) of this section and 10 ppm.

(3) Compute and report as a finding the total number of sulfur credits generated, and agree this number with the number reported to EPA.

(e) *Credit purchases and sales.* The following attest procedures shall be completed for a refinery or importer that is a transferor or transferee of credits during an averaging period:

(1) Obtain contracts or other documents for all credits transferred to another refinery or importer during the year being reviewed; compute and report as a finding the number and year of creation of credits represented in these documents as being transferred away; and agree with the report to EPA.

(2) Obtain contracts or other documents for all credits received during the year being reviewed; compute and report as a finding the number and year of creation of credits represented in these documents as being received; and agree with the report to EPA.

(f) *Credit expiration.* A refinery or importer that possesses credits during an averaging period must obtain a list of

all credits in the refiner's or importer's possession at any time during the year being reviewed, identified by the year of creation of the credits.

(g) *Credit reconciliation.* The following attest procedures shall be completed each year credits were in the refiner's or importer's possession at any time during the year:

(1) Obtain the credits remaining or the credit deficit from the previous year from the refiner's or importer's report to EPA for the previous year.

(2) Compute and report as a finding the net credits remaining at the conclusion of the year being reviewed by totaling—

(i) Credits remaining from the previous year; plus

(ii) Credits generated under in an averaging period; plus

(iii) Credits purchased; minus

(iv) Credits sold; minus

(v) Credits used; minus

(vi) Credits expiring; minus

(vii) Credit deficit from the previous year.

(3) Agree the credits remaining or the credit deficit at the conclusion of the year being reviewed with the report to EPA.

(4) If the refinery or importer had a credit deficit for both the previous year and the year being reviewed, report this fact as a finding.

## PART 85—CONTROL OF AIR POLLUTION FROM MOBILE SOURCES

■ 49. The authority citation for part 85 continues to read as follows:

*Authority:* 42 U.S.C. 7401–7671q.

### Subpart F—[Amended]

■ 50. Section 85.510 is amended by revising paragraph (b)(9) to read as follows:

#### § 85.510 Exemption provisions for new and relatively new vehicles/engines.

\* \* \* \* \*

(b) \* \* \*

(9) *OBD requirements.* (i) The OBD system must properly detect and identify malfunctions in all monitored emission-related powertrain systems or components including any new monitoring capability necessary to identify potential emission problems associated with the new fuel.

(ii) Conduct all OBD testing necessary to demonstrate compliance with 40 CFR 86.010–18 or 86.1806–05.

(iii) Submit the applicable OBD reporting requirements set forth in 40 CFR part 86, subparts A and S, and submit the following statement of compliance if the OEM vehicles/engines were required to be OBD-equipped:

The test group/engine family converted to an alternative fuel has fully functional OBD systems and therefore meets the OBD requirements specified in 40 CFR part 86 when operating on the alternative fuel.

\* \* \* \* \*

51. Section 85.515 is amended by revising paragraph (b)(9)(iii) to read as follows:

#### § 85.515 Exemption provisions for intermediate age vehicles/engines.

\* \* \* \* \*

(b) \* \* \*

(9) \* \* \*

(iii) In addition to conducting OBD testing described in this paragraph (b)(9), you must submit to EPA the following statement of compliance if the OEM vehicles/engines were required to be OBD-equipped:

The test group/engine family converted to an alternative fuel has fully functional OBD systems and therefore meets the OBD requirements specified in 40 CFR part 86 when operating on the alternative fuel.

\* \* \* \* \*

■ 52. Section 85.520 is amended by revising paragraph (b)(4)(iii) to read as follows:

#### § 85.520 Exemption provisions for outside useful life vehicles/engines.

\* \* \* \* \*

(b) \* \* \*

(4) \* \* \*

(iii) In addition to conducting OBD testing described in this paragraph (b)(4), you must submit to EPA the following statement of compliance if the OEM vehicles/engines were required to be OBD-equipped:

The test group/engine family converted to an alternative fuel has fully functional OBD systems and therefore meets the OBD requirements specified in 40 CFR part 86 when operating on the alternative fuel.

\* \* \* \* \*

### Subpart P—[Amended]

■ 53. Section 85.1515 is revised to read as follows:

#### § 85.1515 Emission standards and test procedures applicable to imported nonconforming motor vehicles and motor vehicle engines.

(a) Notwithstanding any other requirements of this subpart, any motor vehicle or motor vehicle engine conditionally imported pursuant to § 85.1505 or § 85.1509 and required to be emission tested shall be tested using the FCT at 40 CFR part 86 applicable to current model year motor vehicles and

motor vehicle engines at the time of testing or reduced testing requirements as follows:

(1) ICIs are eligible for reduced testing under this paragraph (a) subject to the following conditions:

(i) The OEM must have a valid certificate of conformity covering the vehicle.

(ii) The vehicle must be in its original configuration as certified by the OEM. This applies for all emission-related components, including the electronic control module, engine calibrations, and all evaporative/refueling control hardware. It also applies for OBD software and hardware, including all sensors and actuators.

(iii) The vehicle modified as described in paragraph (a)(1)(ii) of this section must fully comply with all applicable emission standards and requirements.

(iv) Vehicles must have the proper OBD systems installed and operating. When faults are present, the ICI must test and verify the system's ability to find the faults (such as disconnected components), set codes, and illuminate the light, and set readiness codes as appropriate for each vehicle. When no fault is present, the ICI must verify that after sufficient prep driving (typically one FTP test cycle), all OBD readiness codes are set and the OBD system does not indicate a malfunction (i.e., no codes set and no light illuminated).

(v) The ICI may not modify more than 300 vehicles in any given model year using reduced testing provisions in this paragraph (a).

(vi) The ICI must state in the application for certification that it will meet all the conditions in this paragraph (a)(1).

(2) The following provisions allow for ICIs to certify vehicles with reduced testing:

(i) In addition to the test waivers specified in 40 CFR 86.1829, you may provide a statement in the application for certification, supported by engineering analysis, that vehicles comply with any of the following standards that apply instead of submitting test data:

(A) Cold temperature CO and NMHC emission standards specified in 40 CFR 86.1811.

(B) SFTP emission standards specified in 40 CFR 86.1811 and 86.1816 for all pollutants.

(C) For anything other than diesel-fueled vehicles, PM emission standards specified in 40 CFR 86.1811 and 86.1816.

(D) Any running loss, refueling, spitback, bleed emissions, and leak

standards specified in 40 CFR part 86, subparts A and S.

(ii) You must perform testing and submit test data as follows to demonstrate compliance with emission standards:

(A) *Exhaust and fuel economy tests.* You must measure emissions over the FTP driving cycle and the highway fuel economy driving cycle as specified in 40 CFR 600.109 to meet the fuel economy requirements in 40 CFR part 600 and demonstrate compliance with the exhaust emission standards in 40 CFR part 86 (other than PM). Measure exhaust emissions and fuel economy with the same test procedures used by the original manufacturer to test the vehicle for certification. However, you must use an electric dynamometer meeting the requirements of § 86.108 or 40 CFR part 1066, subpart B, unless we approve a different dynamometer based on excessive compliance costs. If you certify based on testing with a different dynamometer, you must state in the application for certification that all vehicles in the emission family will comply with emission standards if tested on an electric dynamometer.

(B) *Evaporative emission test.* You may measure evaporative emissions as specified in this paragraph (a)(2)(ii)(B) to demonstrate compliance with the evaporative emission standards in 40 CFR part 86 instead of the otherwise specified procedures. Use measurement equipment for evaporative measurements specified in 40 CFR part 86, subpart B, except that the evaporative emission enclosure does not need to accommodate varying ambient temperatures. The evaporative measurement procedure is integral to the procedure for measuring exhaust emissions over the FTP driving cycle as described in paragraph (a)(ii)(2)(A) of this section. Perform canister preconditioning using the same procedure used by the original manufacturer to certify the vehicle; perform this canister loading before the initial preconditioning drive. Perform a diurnal emission test at the end of the stabilization period before the exhaust emission test by heating the fuel from 60 to 84 °F, either by exposing the vehicle to increasing ambient temperatures or by applying heat directly to the fuel tank. Measure hot soak emissions as described in 40 CFR 86.138–96(k). We may approve alternative measurement procedures that are equivalent to or more stringent than the specified procedures if the specified procedures are impractical for particular vehicle models or measurement facilities. The sum of the measured diurnal and hot soak values must meet the appropriate

emission standard as specified in this section.

(b) The emission standards applicable to nonconforming light-duty vehicles and light-duty trucks imported pursuant to this subpart are outlined in tables 1 and 2 of this section, respectively. The useful life as specified in tables 1 and 2 of this section is applicable to imported light-duty vehicles and light-duty trucks, respectively.

(c)(1) Nonconforming motor vehicles or motor vehicle engines of 1994 OP year and later conditionally imported pursuant to § 85.1505 or § 85.1509 shall meet all of the emission standards specified in 40 CFR part 86 for the OP year of the vehicle or motor vehicle engine. The useful life specified in 40 CFR part 86 for the OP year of the motor vehicle or motor vehicle engine is applicable where useful life is not designated in this subpart.

(2)(i) Nonconforming light-duty vehicles and light light-duty trucks (LDV/LLDTs) originally manufactured in OP years 2004, 2005 or 2006 must meet the FTP exhaust emission standards of bin 9 in Tables S04–1 and S04–2 in 40 CFR 86.1811–04 and the evaporative emission standards for light-duty vehicles and light light-duty trucks specified in 40 CFR 86.1811–01(e)(5).

(ii) Nonconforming LDT3s and LDT4s (HLDTs) and medium-duty passenger vehicles (MDPVs) originally manufactured in OP years 2004 through 2006 must meet the FTP exhaust emission standards of bin 10 in Tables S04–1 and S04–2 in 40 CFR 86.1811–04 and the applicable evaporative emission standards specified in 40 CFR 86.1811–04(e)(5). For 2004 OP year HLDTs and MDPVs where modifications commence on the first vehicle of a test group before December 21, 2003, this requirement does not apply to the 2004 OP year. ICIs opting to bring all of their 2004 OP year HLDTs and MDPVs into compliance with the exhaust emission standards of bin 10 in Tables S04–1 and S04–2 in 40 CFR 86.1811–04, may use the optional higher NMOG values for their 2004–2006 OP year LDT2s and 2004–2008 LDT4s.

(iii) Nonconforming LDT3s and LDT4s (HLDTs) and medium-duty passenger vehicles (MDPVs) originally manufactured in OP years 2007 and 2008 must meet the FTP exhaust emission standards of bin 8 in Tables S04–1 and S04–2 in 40 CFR 86.1811–04 and the applicable evaporative standards specified in 40 CFR 86.1811–04(e)(5).

(iv) Nonconforming LDV/LLDTs originally manufactured in OP years 2007 through 2021 and nonconforming

HLDTs and MDPVs originally manufactured in OP year 2009 through 2021 must meet the FTP exhaust emission standards of bin 5 in Tables S04–1 and S04–2 in 40 CFR 86.1811–04, and the evaporative standards specified in 40 CFR 86.1811–04(e)(1) through (4).

(v) ICIs are exempt from the Tier 2 and the interim non-Tier2 phase-in intermediate percentage requirements for exhaust, evaporative, and refueling emissions described in 40 CFR 86.1811–04.

(vi) In cases where multiple standards exist in a given model year in 40 CFR part 86 due to phase-in requirements of new standards, the applicable standards for motor vehicle engines required to be certified to engine-based standards are the least stringent standards applicable to the engine type for the OP year.

(vii) Nonconforming LDV/LLDTs originally manufactured in OP years 2009 through 2021 must meet the evaporative emission standards in Table S09–1 in 40 CFR 86.1811–09(e). However, LDV/LLDTs originally manufactured in OP years 2009 and 2010 and imported by ICIs who qualify as small-volume manufacturers as defined in 40 CFR 86.1838–01 are exempt from the LDV/LLDT evaporative emission standards in Table S09–1 in 40 CFR 86.1811–09(e), but must comply with the Tier 2 evaporative emission standards in Table S04–3 in 40 CFR 86.1811–04(e).

(viii) Nonconforming HLDTs and MDPVs originally manufactured in OP years 2010 through 2021 must meet the evaporative emission standards in Table S09–1 in 40 CFR 86.1811–09(e). However, HLDTs and MDPVs originally manufactured in OP years 2010 and 2011 and imported by ICIs, who qualify as small-volume manufacturers as defined in 40 CFR 86.1838–01, are exempt from the HLDTs and MDPVs evaporative emission standards in Table S09–1 in 40 CFR 86.1811–09(e), but must comply with the Tier 2 evaporative emission standards in Table S04–3 in 40 CFR 86.1811–04(e).

(ix) Nonconforming LDVs, LDTs, MDPVs, and complete heavy-duty vehicles at or below 14,000 pounds GVWR originally manufactured in OP years 2022 and later must meet the Tier 3 exhaust and evaporative emission standards in 40 CFR 86.1811–17, 86.1813–17, and 86.1816–18.

(3)(i) As an option to the requirements of paragraph (c)(2) of this section, independent commercial importers may elect to meet lower bins in Tables S04–1 and S04–2 of 40 CFR 86.1811–04 than specified in paragraph (c)(2) of this section and bank or sell NO<sub>x</sub> credits as permitted in 40 CFR 86.1860–04 and 40

CFR 86.1861–04. An ICI may not meet higher bins in Tables S04–1 and S04–2 of 40 CFR 86.1811–04 than specified in paragraph (c)(2) of this section unless it demonstrates to the Administrator at the time of certification that it has obtained appropriate and sufficient NO<sub>x</sub> credits from another manufacturer, or has generated them in a previous model year or in the current model year and not transferred them to another manufacturer or used them to address other vehicles as permitted in 40 CFR 86.1860–04 and 40 CFR 86.1861–04.

(ii) Where an ICI desires to obtain a certificate of conformity using a bin higher than specified in paragraph (c)(2) of this section, but does not have sufficient credits to cover vehicles produced under such certificate, the Administrator may issue such certificate if the ICI has also obtained a certificate of conformity for vehicles certified using a bin lower than that required under paragraph (c)(2) of this section. The ICI may then produce vehicles to the higher bin only to the extent that it has generated sufficient credits from vehicles certified to the lower bin during the same model year.

(4) [Reserved]

(5) Except for the situation where an ICI desires to bank, sell or use NO<sub>x</sub> credits as described in paragraph (c)(3) of this section, the requirements of 40 CFR 86.1811–04 related to fleet average NO<sub>x</sub> standards and requirements to comply with such standards do not apply to vehicles modified under this subpart.

(6) ICIs using bins higher than those specified in paragraph (c)(2) of this section must monitor their production so that they do not produce more vehicles certified to the standards of such bins than their available credits can cover. ICIs must not have a credit deficit at the end of a model year and are not permitted to use the deficit

carryforward provisions provided in 40 CFR 86.1860–04(e).

(7) The Administrator may condition the certificates of conformity issued to ICIs as necessary to ensure that vehicles subject to paragraph (c) of this section comply with the appropriate average NO<sub>x</sub> standard for each model year.

(8)(i) Nonconforming LDV/LLDTs originally manufactured in OP years 2010 and later must meet the cold temperature NMHC emission standards in Table S10–1 in 40 CFR 86.1811–10(g).

(ii) Nonconforming HLDTs and MDPVs originally manufactured in OP years 2012 and later must meet the cold temperature NMHC emission standards in Table S10–1 in 40 CFR 86.1811–10(g).

(iii) ICIs, which qualify as small-volume manufacturers, are exempt from the cold temperature NMHC phase-in intermediate percentage requirements described in 40 CFR 86.1811–10(g)(3). See 40 CFR 86.1811–04(k)(5)(vi) and (vii).

(iv) As an alternative to the requirements of paragraphs (c)(8)(i) and (ii) of this section, ICIs may elect to meet a cold temperature NMHC family emission level below the cold temperature NMHC fleet average standards specified in Table S10–1 of 40 CFR 86.1811–10 and bank or sell credits as permitted in 40 CFR 86.1864–10. An ICI may not meet a higher cold temperature NMHC family emission level than the fleet average standards in Table S10–1 of 40 CFR 86.1811–10 as specified in paragraphs (c)(8)(i) and (ii) of this section, unless it demonstrates to the Administrator at the time of certification that it has obtained appropriate and sufficient NMHC credits from another manufacturer, or has generated them in a previous model year or in the current model year and not traded them to another manufacturer or used them to address

other vehicles as permitted in 40 CFR 86.1864–10.

(v) Where an ICI desires to obtain a certificate of conformity using a higher cold temperature NMHC family emission level than specified in paragraphs (c)(8)(i) and (ii) of this section, but does not have sufficient credits to cover vehicles imported under such certificate, the Administrator may issue such certificate if the ICI has also obtained a certificate of conformity for vehicles certified using a cold temperature NMHC family emission level lower than that required under paragraphs (c)(8)(i) and (ii) of this section. The ICI may then import vehicles to the higher cold temperature NMHC family emission level only to the extent that it has generated sufficient credits from vehicles certified to a family emission level lower than the cold temperature NMHC fleet average standard during the same model year.

(vi) ICIs using cold temperature NMHC family emission levels higher than the cold temperature NMHC fleet average standards specified in paragraphs (c)(8)(i) and (ii) of this section must monitor their imports so that they do not import more vehicles certified to such family emission levels than their available credits can cover. ICIs must not have a credit deficit at the end of a model year and are not permitted to use the deficit carryforward provisions provided in 40 CFR 86.1864–10.

(vii) The Administrator may condition the certificates of conformity issued to ICIs as necessary to ensure that vehicles subject to this paragraph (c)(8) comply with the applicable cold temperature NMHC fleet average standard for each model year.

(d) Except as provided in paragraph (c) of this section, ICI's must not participate in emission-related programs for emissions averaging, banking and trading, or nonconformance penalties.

TABLE 1 TO § 85.1515—EMISSION STANDARDS APPLICABLE TO IMPORTED LIGHT-DUTY MOTOR VEHICLES<sup>1 2 3</sup>

OP Year	Hydrocarbon	Carbon monoxide	Oxides of nitrogen	Diesel particulate	Evaporative hydrocarbon	Useful life (years/miles)
1968–1976 .....	1.5 gpm .....	15 gpm .....	3.1 gpm .....	.....	6.0 g/test .....	5/50,000
1977–1979 .....	1.5 gpm .....	15 gpm .....	2.0 gpm .....	.....	6.0 g/test .....	5/50,000
1980 .....	0.41 gpm .....	7.0 gpm .....	2.0 gpm .....	.....	6.0 g/test .....	5/50,000
1981 .....	0.41 gpm .....	3.4 gpm .....	1.0 gpm .....	.....	2.0 g/test .....	5/50,000
1982–1986 .....	0.41 gpm .....	3.4 gpm .....	1.0 gpm .....	0.60 gpm .....	2.0 g/test .....	5/50,000
1987–1993 .....	0.41 gpm .....	3.4 gpm .....	1.0 gpm .....	0.20 gpm .....	2.0 g/test .....	5/50,000
1994 and later ..	( <sup>4</sup> ) .....	( <sup>4</sup> ) .....	( <sup>4</sup> ) .....	( <sup>4</sup> ) .....	( <sup>4</sup> ) .....	( <sup>4</sup> )

<sup>1</sup> Diesel particulate standards apply only to diesel fueled light-duty vehicles. Evaporative hydrocarbon standards apply only to non-diesel fueled light-duty vehicles. For alternative fueled light-duty vehicles, the evaporative hydrocarbon standard is interpreted as organic material hydrocarbon equivalent grams carbon per test, as applicable.

<sup>2</sup> No crankcase emissions shall be discharged into the ambient atmosphere from any non-diesel fueled light-duty vehicle.

<sup>3</sup> All light-duty vehicles shall meet the applicable emission standards at both low and high-altitudes according to the procedures specified in 40 CFR part 86 for current model year motor vehicles at the time of testing.

<sup>4</sup> Specified in 40 CFR part 86 for the OP year of the vehicle, as described in paragraph (c) of this section.



TABLE 2 TO § 85.1515—EMISSION STANDARDS APPLICABLE TO IMPORTED LIGHT-DUTY TRUCKS<sup>1 2 3 4 5</sup>

OP Year	Hydrocarbon	Carbon monoxide	Oxides of nitrogen	Diesel particulate	Evaporative hydrocarbon	Useful life (years/miles)
1968–78	2.0 gpm	20 gpm	3.1 gpm		6.0 g/test	5/50,000
1979–80	1.7 gpm	18 gpm	2.3 gpm		6.0 g/test	5/50,000
1981	1.7 gpm	18 gpm	2.3 gpm		2.0 g/test	5/50,000
1982–1983	1.7 gpm (2.0)	18 gpm (26)	2.3 gpm (2.3)	0.60 gpm (0.60)	2.0 g/test (2.6)	5/50,000
1984	0.80 gpm (1.0)	10 gpm (14)	2.3 gpm (2.3)	0.60 gpm (0.60)	2.0 g/test (2.6)	5/50,000
1985–1986	0.80 gpm (1.0)	10 gpm (14)	2.3 gpm (2.3)	0.60 gpm (0.60)	2.0 g/test (2.6)	11/120,000
1987	0.80 gpm (1.0)	10 gpm (14)	2.3 gpm (2.3)	0.26 gpm (0.26)	2.0 g/test (2.6)	11/120,000
1988–1989	0.80 gpm (1.0)	10 gpm (14)	1.2 gpm <sup>6</sup> (1.2)	0.26 gpm <sup>7</sup> (2.0)	2.0 g/test (2.6)	11/120,000
1988–1989	0.80 gpm (1.0)	10 gpm (14)	1.7 gpm <sup>6</sup> (1.7)	0.45 gpm <sup>7</sup> (0.26)	2.0 g/test (2.6)	11/120,000
1988–1989	0.80 gpm (1.0)	10 gpm (14)	2.3 gpm <sup>6</sup> (2.3)	0.45 gpm <sup>7</sup> (0.26)	2.0 g/test (2.6)	11/120,000
1990–1993	0.80 gpm (1.0)	10 gpm (14)	1.2 gpm <sup>8</sup> (1.2)	0.26 gpm <sup>7</sup> (0.26)	2.0 g/test (2.6)	11/120,000
1990–1993	0.80 gpm (1.0)	10 gpm (14)	1.7 gpm <sup>8</sup> (1.7)	0.45 gpm <sup>7</sup> (0.26)	2.0 g/test (2.6)	11/120,000
1994 and later	( <sup>9</sup> )	( <sup>9</sup> )	( <sup>9</sup> )	( <sup>9</sup> )	( <sup>9</sup> )	( <sup>9</sup> )

<sup>1</sup> Diesel particulate standards apply only to diesel fueled light-duty trucks. Evaporative hydrocarbon standards apply only to non-diesel fueled light-duty trucks. For alternative fueled light-duty trucks, the evaporative hydrocarbon standard is interpreted as organic material hydrocarbon equivalent grams carbon per test, as applicable.

<sup>2</sup> No crankcase emissions shall be discharged into the ambient atmosphere from any non-diesel fueled light-duty truck.

<sup>3</sup> A carbon monoxide standard of 0.50% of exhaust flow at curb idle is applicable to all 1984 and later model year light-duty trucks sold to, or owned by, an importer for principal use at other than a designated high-altitude location. This requirement is effective for light-duty trucks sold to, or owned by an importer for principal use at a designated high-altitude location beginning with the 1988 model year.

<sup>4</sup> All 1982 OP year and later light-duty trucks sold to, or owned by, an importer for principal use at a designated high-altitude location shall meet high-altitude emission standards according to the requirements specified in 40 CFR part 86 for current model year light-duty trucks at the time of testing.

<sup>5</sup> Standards in parentheses apply to motor vehicles sold to, or owned by, an importer for principal use at a designated high-altitude location. These standards must be met at high-altitude according to the procedures specified in 40 CFR part 86 for current model year motor vehicles at the time of testing.

<sup>6</sup> The oxides of nitrogen standard of 1.2 gpm applies to light-duty trucks at or below 3,750 pounds loaded vehicle weight and at or below 6,000 pounds GVWR. The 1.7 gpm standard applies to light-duty trucks above 3,750 pound loaded vehicle weight and at or below 6,000 pounds GVWR; the 2.3 gpm standard applies to light-duty trucks above 6,000 pounds GVWR.

<sup>7</sup> The diesel particulate standard of 0.26 gpm applies to light-duty trucks at or below 3,750 pounds loaded vehicle weight; the 0.45 gpm standard applies to light-duty trucks above 3,750 pounds loaded vehicle weight.

<sup>8</sup> The NO<sub>x</sub> standard of 1.2 gpm applies to light-duty trucks at or below 3,750 pounds loaded vehicle weight; the 1.7 gpm standard applies to light-duty trucks above 3,750 pounds loaded vehicle weight.

<sup>9</sup> Specified in 40 CFR part 86 for the OP year of the vehicle, as described in paragraph (c) of this section.

■ 54. Subpart W is revised to consist of §§ 85.2201, 85.2207, 85.2222, 85.2223, and 85.2231, to read as follows:

**Subpart W—Emission Control System Performance Warranty Short Tests**

Sec.

- 85.2201 Applicability.
- 85.2207 Onboard diagnostic test standards.
- 85.2222 Onboard diagnostic test procedures.
- 85.2223 Onboard diagnostic test report.
- 85.2231 Onboard diagnostic test equipment requirements.

**Subpart W—Emission Control System Performance Warranty Short Tests**

**§ 85.2201 Applicability.**

(a) This subpart describes the test provisions to be employed in conjunction with the Emissions Performance Warranty in subpart V of this part. These provisions generally rely on a vehicle's onboard diagnostic

system (OBD) to indicate whether a vehicle passes or fails the test.

(b) The provisions of this subpart may be used to establish warranty eligibility for light-duty vehicles, light-duty trucks, and medium-duty passenger vehicles when tested during the useful life as prescribed in subpart V of this part.

**§ 85.2207 Onboard diagnostic test standards.**

(a) A vehicle shall fail the OBD test if it is a 1996 or newer vehicle and the vehicle connector is missing, has been tampered with, or is otherwise inoperable.

(b) A vehicle shall fail the OBD test if the malfunction indicator light (MIL) is commanded to be illuminated and it is not visually illuminated according to visual inspection.

(c) A vehicle shall fail the OBD test if the MIL is commanded to be illuminated for one or more diagnostic

trouble codes (DTCs), as described in 40 CFR 86.1806.

**§ 85.2222 Onboard diagnostic test procedures.**

The test sequence for the OBD inspection shall consist of the following steps:

(a) The OBD inspection shall be conducted with the key-on/engine running, with the exception of inspecting for MIL illumination as required in paragraph (d)(4) of this section, during which the inspection shall be conducted with the key-on/engine off.

(b) The inspector shall locate the vehicle connector and plug the test system into the connector.

(c) The test system shall send a Mode \$01, PID \$01 request in accordance with 40 CFR 86.1806 to determine the OBD evaluation status. The test system shall determine what monitors are supported by the OBD system, and perform the

readiness evaluation for applicable monitors in accordance with the requirements and specifications in 40 CFR 86.1806.

(1) Coincident with the beginning of mandatory testing, repair, and retesting based upon the OBD test, if the readiness evaluation indicates that any onboard tests are not complete, the customer shall be instructed to return after the vehicle has been run under conditions that allow completion of all applicable onboard tests. If the readiness evaluation again indicates that any onboard test is not complete, the vehicle shall be failed.

(2) An exception to paragraph (c)(1) of this section is allowed for MY 1996 to MY 2000 vehicles, inclusive, with two or fewer unset readiness monitors, and for MY 2001 and newer vehicles with no more than one unset readiness monitor. Vehicles from those model years which would otherwise pass the OBD inspection, but for the unset readiness code in question, may be issued a passing certificate without being required to operate the vehicle in such a way as to activate those particular monitors. Vehicles from those model years with an unset readiness code that also have a DTC stored resulting in an illuminated MIL must be failed, though setting the unset readiness flag in question shall not be a prerequisite for passing the retest.

(d) The test system shall evaluate the MIL status bit and record status information in the vehicle test record.

(1) If the MIL status bit indicates that the MIL has been commanded to be illuminated, the test system shall send a Mode \$03 request in accordance with 40 CFR 86.1806 to determine the stored DTCs. The system shall repeat this cycle until the number of codes reported equals the number expected based on the Mode \$01 response. All DTCs resulting in MIL illumination shall be recorded in the vehicle test record and the vehicle shall fail the OBD inspection.

(2) If the MIL bit is not commanded to be illuminated the vehicle shall pass the OBD inspection, even if DTCs are present.

(3) If the MIL bit is commanded to be illuminated, the inspector shall visually inspect the MIL to determine if it is illuminated. If the MIL is commanded to be illuminated but is not, the vehicle shall fail the OBD inspection.

(4) If the MIL does not illuminate at all when the vehicle is in the key-on/engine-off condition, the vehicle shall fail the OBD inspection, even if no DTCs are present and the MIL has not been commanded on.

#### **§ 85.2223 Onboard diagnostic test report.**

(a) Motorists whose vehicles fail the OBD test described in § 85.2222 shall be provided with the OBD test results, including the codes retrieved, the name of the component or system associated with each DTC, the status of the MIL illumination command, and the customer alert statement as stated in paragraph (b) of this section.

(b) In addition to any codes that were retrieved, the test report shall include the following language:

Your vehicle's computerized self-diagnostic system (OBD) registered the faults listed below. The faults are probably an indication of a malfunction of an emission component. However, multiple and/or seemingly unrelated faults may be an indication of an emission-related problem that occurred previously, but upon further evaluation by the OBD system was determined to be only temporary. Therefore, proper diagnosis by a qualified technician is required to positively identify the source of any emission-related problem.

#### **§ 85.2231 Onboard diagnostic test equipment requirements.**

(a) The test system interface to the vehicle shall include a plug that conforms to the requirements and specifications of 40 CFR 86.1806.

(b) The test system shall be capable of communicating with the standard data link connector of vehicles with certified OBD systems.

(c) The test system shall be capable of checking for OBD monitors and the evaluation status of supported monitors (test complete/test not complete) in Mode \$01 PID \$01, as well as be able to request the DTCs, consistent with the requirements and specifications of 40 CFR 86.1806.

### **PART 86—CONTROL OF EMISSIONS FROM NEW AND IN-USE HIGHWAY VEHICLES AND ENGINES**

■ 55. The authority citation for part 86 continues to read as follows:

**Authority:** 42 U.S.C. 7401–7671q.

■ 56. Section 86.1 is revised to read as follows:

#### **§ 86.1 Incorporation by reference.**

(a) Certain material is incorporated by reference into this part with the approval of the Director of the Federal Register under 5 U.S.C. 552(a) and 1 CFR part 51. To enforce any edition other than that specified in this section, a document must be published in the **Federal Register** and the material must be available to the public. All approved material is available for inspection at U.S. EPA, Air and Radiation Docket and Information Center, 1301 Constitution

Ave., NW., Room B102, EPA West Building, Washington, DC 20460, (202) 202–1744, and is available from the sources listed below. It is also available for inspection at the National Archives and Records Administration (NARA). For information on the availability of this material at NARA, call 202–741–6030, or go to [http://www.archives.gov/federal\\_register/code\\_of\\_federal\\_regulations/ibr\\_locations.html](http://www.archives.gov/federal_register/code_of_federal_regulations/ibr_locations.html).

(b) *ASTM International material.* The following standards are available from ASTM International, 100 Barr Harbor Drive, P.O. Box C700, West Conshohocken, PA, 19428–2959, (610) 832–9585, or <http://www.astm.org/>:

(1) ASTM C1549–09, Standard Test Method for Determination of Solar Reflectance Near Ambient Temperature Using a Portable Solar Reflectometer, approved August 1, 2009, IBR approved for § 86.1869–12(b).

(2) ASTM D86–12, Standard Test Method for Distillation of Petroleum Products at Atmospheric Pressure, approved December 1, 2012, IBR approved for §§ 86.113–04(a), 86.113–94(b), 86.213(a), and 86.513(a).

(3) ASTM D93–13, Standard Test Methods for Flash Point by Pensky-Martens Closed Cup Tester, approved July 15, 2013, IBR approved for § 86.113–94(b).

(4) ASTM D445–12, Standard Test Method for Kinematic Viscosity of Transparent and Opaque Liquids (and Calculation of Dynamic Viscosity), approved April 15, 2012, IBR approved for § 86.113–94(b).

(5) ASTM D613–13, Standard Test Method for Cetane Number of Diesel Fuel Oil, approved December 1, 2013, IBR approved for § 86.113–94(b).

(6) ASTM D975–13a, Standard Specification for Diesel Fuel Oils, approved December 1, 2013, IBR approved for § 86.1910(c).

(7) ASTM D976–06 (Reapproved 2011), Standard Test Method for Calculated Cetane Index of Distillate Fuels, approved October 1, 2011, IBR approved for § 86.113–94(b).

(8) ASTM D1319–13, Standard Test Method for Hydrocarbon Types in Liquid Petroleum Products by Fluorescent Indicator Adsorption, approved May 1, 2013, IBR approved for §§ 86.113–04(a), 86.213(a), and 86.513(a).

(9) ASTM D1945–03 (reapproved 2010), Standard Test Method for Analysis of Natural Gas by Gas Chromatography, approved January 1, 2010, IBR approved for §§ 86.113–94(e) and 86.513(d).

(10) ASTM D2163–07, Standard Test Method for Determination of Hydrocarbons in Liquefied Petroleum

(LP) Gases and Propane/Propene Mixtures by Gas Chromatography, approved December 1, 2007, IBR approved for §§ 86.113–94(f).

(11) ASTM D2622–10, Standard Test Method for Sulfur in Petroleum Products by Wavelength Dispersive X-ray Fluorescence Spectrometry, approved February 15, 2010, IBR approved for §§ 86.113–04(a), 86.113–94(b), 86.213(a), and 86.513(a).

(12) ASTM D2699–13b, Standard Test Method for Research Octane Number of Spark-Ignition Engine Fuel, approved October 1, 2013, IBR approved for §§ 86.113–04(a) and 86.213(a).

(13) ASTM D2700–13b, Standard Test Method for Motor Octane Number of Spark-Ignition Engine Fuel, approved October 1, 2013, IBR approved for §§ 86.113–04(a) and 86.213(a).

(14) ASTM D3231–13, Standard Test Method for Phosphorus in Gasoline, approved June 15, 2013, IBR approved for §§ 86.113–04(a), 86.213(a), and 86.513(a).

(15) ASTM D3237–12, Standard Test Method for Lead in Gasoline by Atomic Absorption Spectroscopy, approved June 1, 2012, IBR approved for §§ 86.113–04(a), 86.213(a), and 86.513(a).

(16) ASTM D4052–11, Standard Test Method for Density, Relative Density, and API Gravity of Liquids by Digital Density Meter, approved October 15, 2011, IBR approved for § 86.113–94(b).

(17) ASTM D5186–03 (Reapproved 2009), Standard Test Method for Determination of the Aromatic Content and Polynuclear Aromatic Content of Diesel Fuels and Aviation Turbine Fuels by Supercritical Fluid Chromatography, approved April 15, 2009, IBR approved for § 86.113–94(b).

(18) ASTM D5191–13, Standard Test Method for Vapor Pressure of Petroleum Products (Mini Method), approved December 1, 2013, IBR approved for §§ 86.113–04(a), 86.213(a), and 86.513(a).

(19) ASTM E29–93a, Standard Practice for Using Significant Digits in Test Data to Determine Conformance with Specifications, approved March 15, 1993, IBR approved for §§ 86.004–15(c), 86.007–11(a), 86.007–15(m), 86.1803–01, 86.1823–01(a), 86.1824–01(c), 86.1825–01(c).

(20) ASTM E903–96, Standard Test Method for Solar Absorptance, Reflectance, and Transmittance of Materials Using Integrating Spheres, approved April 10, 1996, IBR approved for § 86.1869–12(b).

(21) ASTM E1918–06, Standard Test Method for Measuring Solar Reflectance of Horizontal and Low-Sloped Surfaces

in the Field, approved August 15, 2006, IBR approved for § 86.1869–12(b).

(c) *ANSI material*. The following standards are available from American National Standards Institute, 25 W 43rd Street, 4th Floor, New York, NY 10036, (212) 642–4900, or <http://www.ansi.org>:

(1) ANSI NGV1–2006, Standard for Compressed Natural Gas Vehicle (NGV) Fueling Connection Devices, 2nd edition, reaffirmed and consolidated March 2, 2006, IBR approved for § 86.1813–17(f).

(2) [Reserved]

(d) *California Air Resources Board*. The following documents are available from the California Air Resources Board, 1001 I Street, Sacramento, CA 95812, (916) 322–2884, or <http://www.arb.ca.gov>:

(1) California Requirements Applicable to the LEV III Program, including the following documents:

(i) LEV III exhaust emission standards are in Title 13 Motor Vehicles, Division 3 Air Resources Board, Chapter 1 Motor Vehicle Pollution Control Devices, Article 2 Approval of Motor Vehicle Pollution Control Devices (New Vehicles), § 1961.2 Exhaust Emission Standards and Test Procedures—2015 and Subsequent Model Passenger Cars, Light-Duty Trucks, and Medium-Duty Vehicles, effective as of December 31, 2012, IBR approved for § 86.1803–01.

(ii) LEV III evaporative emission standards for model year 2015 and later vehicles are in Title 13 Motor Vehicles, Division 3 Air Resources Board, Chapter 1 Motor Vehicle Pollution Control Devices, Article 2 Approval of Motor Vehicle Pollution Control Devices (New Vehicles) § 1976 Standards and Test Procedures for Motor Vehicle Fuel Evaporative Emissions, effective as of December 31, 2012, IBR approved for § 86.1803–01.

(2) California Regulatory Requirements Applicable to the National Low Emission Vehicle Program, October 1996, IBR approved for § 86.113–04(a).

(3) California Regulatory Requirements known as Onboard Diagnostics II (OBD–II), Approved on April 21, 2003, Title 13, California Code of Regulations, Section 1968.2, Malfunction and Diagnostic System Requirements for 2004 and Subsequent Model-Year Passenger Cars, Light-Duty Trucks, and Medium-Duty Vehicles and Engines (OBD–II), IBR approved for § 86.1806–05(j).

(4) California Regulatory Requirements known as Onboard Diagnostics II (OBD–II), Approved on November 9, 2007, Title 13, California Code of Regulations, Section 1968.2, Malfunction and Diagnostic System

Requirements for 2004 and Subsequent Model-Year Passenger Cars, Light-Duty Trucks, and Medium-Duty Vehicles and Engines (OBD–II), IBR approved for § 86.1806–05(j).

(5) California Regulatory Requirements known as Onboard Diagnostics II (OBD–II), Title 13, Motor Vehicles, Division 3, Air Resources Board, Chapter 1, Motor Vehicle Pollution Control Devices, Article 2, Approval of Motor Vehicle Pollution Control Devices (New Vehicles), § 1968.2 Malfunction and Diagnostic System Requirements—2004 and Subsequent Model-Year Passenger Cars, Light-Duty Trucks, and Medium-Duty Vehicles and Engines, effective as of July 31, 2013, IBR approved for § 86.1806–17(a).

(e) *ISO material*. The following standards are available from International Organization for Standardization, Case Postale 56, CH–1211 Geneva 20, Switzerland, 41–22–749–01–11, or <http://www.iso.org>:

(1) ISO 13837:2008(E), Road Vehicles—Safety glazing materials—Method for the determination of solar transmittance, First edition, April 15, 2008, IBR approved for § 86.1869–12(b).

(2) ISO 15765–4:2005(E), Road Vehicles—Diagnostics on Controller Area Networks (CAN)—Part 4: Requirements for emissions-related systems, January 15, 2005, IBR approved for §§ 86.010–18(k) and 86.1806–05(h).

(f) *NIST material*. The following documents are available from National Institute of Standards and Technology, 100 Bureau Drive, Gaithersburg, MD 20899, or <http://www.nist.gov>:

(1) NIST Special Publication 811, 2008 Edition, Guide for the Use of the International System of Units (SI), March 2008, IBR approved for § 86.1901(d).

(2) [Reserved]

(g) *SAE International material*. The following standards are available from SAE International, 400 Commonwealth Dr., Warrendale, PA 15096–0001, (877) 606–7323 (U.S. and Canada) or (724) 776–4970 (outside the U.S. and Canada), or <http://www.sae.org>:

(1) SAE J1151, Methane Measurement Using Gas Chromatography, stabilized September 2011, IBR approved for § 86.111–94(b).

(2) SAE J1349, Engine Power Test Code—Spark Ignition and Compression Ignition—As Installed Net Power Rating, revised September 2011, IBR approved for § 86.1803–01.

(3) SAE J1850, Class B Data Communication Network Interface, Revised May 2001, IBR approved for § 86.1806–05(h).

(4) SAE J1877, Recommended Practice for Bar-Coded Vehicle Identification Number Label, July 1994, IBR approved for § 86.095–35(i).

(5) SAE J1892, Recommended Practice for Bar-Coded Vehicle Emission Configuration Label, October 1993, IBR approved for § 86.095–35(i).

(6) SAE J1930, Electrical/Electronic Systems Diagnostic Terms, Definitions, Abbreviations, and Acronyms, Revised May 1998, IBR approved for §§ 86.1808–01(f), 86.1808–07(f).

(7) SAE J1930, Electrical/Electronic Systems Diagnostic Terms, Definitions, Abbreviations, and Acronyms—Equivalent to ISO/TR 15031–2: April 30, 2002, Revised April 2002, IBR approved for §§ 86.010–18(k) and 86.1806–05(h).

(8) SAE J1939, Recommended Practice for a Serial Control and Communications Vehicle Network, Revised October 2007, IBR approved for § 86.010–18(k).

(9) SAE J1939–11, Physical Layer—250K bits/s, Shielded Twisted Pair, Revised October 1999, IBR approved for § 86.1806–05(h).

(10) SAE J1939–13, Off-Board Diagnostic Connector, July 1999, IBR approved for § 86.1806–05(h).

(11) SAE J1939–13, Off-Board Diagnostic Connector, Revised March 2004, IBR approved for § 86.010–18(k).

(12) SAE J1939–21, Data Link Layer, Revised April 2001, IBR approved for § 86.1806–05(h).

(13) SAE J1939–31, Network Layer, Revised December 1997, IBR approved for § 86.1806–05(h).

(14) SAE J1939–71, Vehicle Application Layer (Through February 2007), Revised January 2008, IBR approved for §§ 86.010–38(j) and 86.1806–05(h).

(15) SAE J1939–73, Application Layer—Diagnostics, Revised September 2006, IBR approved for §§ 86.010–18(k), 86.010–38(j), and 86.1806–05(h).

(16) SAE J1939–81, Network Management, Revised May 2003, IBR approved for §§ 86.010–38(j) and 86.1806–05(h).

(17) SAE J1962, Diagnostic Connector Equivalent to ISO/DIS 15031–3; December 14, 2001, Revised April 2002, IBR approved for §§ 86.010–18(k) and 86.1806–05(h).

(18) SAE J1978, OBD II Scan Tool—Equivalent to ISO/DIS 15031–4; December 14, 2001, Revised April 2002, IBR approved for §§ 86.010–18(k) and 86.1806–05(h).

(19) SAE J1979, E/E Diagnostic Test Modes, Revised September 1997, IBR approved for §§ 86.1808–01(f) and 86.1808–07(f).

(20) SAE J1979, (R) E/E Diagnostic Test Modes, Revised May 2007, IBR

approved for §§ 86.010–18(k) and 86.1806–05(h).

(21) SAE J2012, (R) Diagnostic Trouble Code Definitions Equivalent to ISO/DIS 15031–6: April 30, 2002, Revised April 2002, IBR approved for §§ 86.010–18(k) and 86.1806–05(h).

(22) SAE J2064 FEB2011, R134a Refrigerant Automotive Air-Conditioned Hose, Revised February 2011, IBR approved for § 86.1867–12(a) and (b).

(23) SAE J2284–3, High Speed CAN (HSC) for Vehicle Applications at 500 KBPS, May 2001, IBR approved for §§ 86.1808–01(f) and 86.1808–07(f).

(24) SAE J2403, Medium/Heavy-Duty E/E Systems Diagnosis Nomenclature—Truck and Bus, Revised August 2007, IBR approved for §§ 86.010–18(k), 86.010–38(j), and 86.1806–05(h).

(25) SAE J2534, Recommended Practice for Pass-Thru Vehicle Programming, February 2002, IBR approved for §§ 86.1808–01(f) and 86.1808–07(f).

(26) SAE J2727 FEB2012, Mobile Air Conditioning System Refrigerant Emission Charts for R–134a and R–1234yf, Revised February 2012, IBR approved for § 86.1867–12(a) and (b).

(27) SAE J2765 OCT2008, Procedure for Measuring System COP [Coefficient of Performance] of a Mobile Air Conditioning System on a Test Bench, issued October 2008, IBR approved for § 86.1868–12(h).

(h) *Truck and Maintenance Council material.* The following documents are available from the Truck and Maintenance Council, 950 North Glebe Road, Suite 210, Arlington, VA 22203–4181, or (703) 838–1754:

(1) TMC RP 1210B, Revised June 2007, WINDOWSTMMUNICATION API, IBR approved for § 86.010–38(j).

(2) [Reserved]

#### Subpart A—[Amended]

■ 57. Section 86.000–7 is amended as follows:

■ a. By revising the introductory text.

■ b. By removing and reserving paragraph (h)(1).

■ c. By revising paragraph (h)(6).

■ d. By removing paragraph (h)(7).

#### § 86.000–7 Maintenance of records; submittal of information; right of entry.

Section 86.000–7 includes text that specifies requirements that differ from § 86.091–7 or § 86.094–7. Where a paragraph in § 86.091–7 or § 86.094–7 is identical and applicable to § 86.000–7, this may be indicated by specifying the corresponding paragraph and the statement “[Reserved]. For guidance see

§ 86.091–7.” or “[Reserved]. For guidance see § 86.094–7.”

\* \* \* \* \*

(h) \* \* \*

(6) EPA may void ab initio a certificate for a vehicle certified to Tier 1 certification standards or to the respective evaporative and/or refueling test procedure and accompanying evaporative and/or refueling standards as set forth or otherwise referenced in § 86.098–10 for which the manufacturer fails to retain the records required in this section or to provide such information to the Administrator upon request.

#### §§ 86.000–8, 86.000–9, 86.000–16 [Removed]

■ 58. Remove §§ 86.000–8, 86.000–9, and 86.000–16.

#### § 86.000–24 [Amended]

■ 59. Section 86.000–24 is amended as follows:

■ a. By removing the introductory text.

■ b. By removing and reserving paragraphs (a), (b)(1) introductory text, and (b)(1)(iii) through (f).

■ c. By removing and reserving paragraphs (g)(1) and (g)(2).

■ d. By removing paragraph (h).

#### §§ 86.000–26 and 86.000–28 [Removed]

■ 60A. Remove §§ 86.000–26 and 86.000–28.

#### § 86.001–9 [Removed]

■ 60B. Remove § 86.001–9.

#### § 86.001–22 [Removed]

■ 60C. Remove § 86.001–22.

■ 61. Section 86.001–23 is amended by revising the introductory text and adding a heading to paragraph (c) and removing and reserving paragraphs (c)(1), (f), and (g) to read as follows:

#### § 86.001–23 Required data.

Section 86.001–23 includes text that specifies requirements that differ from § 86.098–23. Where a paragraph in § 86.098–23 is identical and applicable to § 86.001–23, this may be indicated by specifying the corresponding paragraph and the statement “[Reserved]. For guidance see § 86.098–23.”

\* \* \* \* \*

(c) *Emission data*—

\* \* \* \* \*

#### §§ 86.001–25, 86.001–26, 86.001–28, and 86.001–30 [Removed]

■ 62A. Remove §§ 86.001–25, 86.001–26, 86.001–28, and 86.001–30.

#### § 86.004–9 [Removed]

■ 62B. Remove § 86.004–9.

■ 63. Section 86.004–11 is amended by revising paragraphs (b)(3) introductory text and (b)(4) introductory text and adding paragraph (b)(4)(iv) to read as follows:

**§ 86.004–11 Emission standards for 2004 and later model year diesel heavy-duty engines and vehicles.**

\* \* \* \* \*

(b) \* \* \*

(3) This paragraph (b)(3) applies as specified in 40 CFR 1037.103. Evaporative emissions (total of non-oxygenated hydrocarbons plus methanol) from heavy-duty vehicles equipped with methanol-fueled diesel engines shall not exceed the following standards. The standards apply equally to certification and in-use vehicles. The spitback standard also applies to newly assembled vehicles.

\* \* \* \* \*

(4) This paragraph (b)(4) applies as specified in 40 CFR 1037.103. Evaporative emissions from 2004 and later model year heavy-duty vehicles equipped with natural gas-fueled or liquefied petroleum gas-fueled HDEs shall not exceed the following standards. The standards apply equally to certification and in-use vehicles.

\* \* \* \* \*

(iv) Compressed natural gas vehicles must meet the requirements for fueling connection devices as specified in § 86.1813–17(f)(1). Vehicles meeting these requirements are deemed to comply with evaporative emission standards.

\* \* \* \* \*

■ 64. Section 86.004–21 is amended as follows:

- a. By revising the introductory text.
- b. By removing and reserving paragraph (b)(4)(i).
- c. By removing paragraph (b)(5)(v).
- d. By removing and reserving paragraphs (k) and (l).

**§ 86.004–21 Application for certification.**

Section 86.004–21 includes text that specifies requirements that differ from § 86.094–21. Where a paragraph in § 86.094–21 is identical and applicable to § 86.004–21, this may be indicated by specifying the corresponding paragraph and the statement “[Reserved]. For guidance see § 86.094–21.”

\* \* \* \* \*

**§ 86.004–25 [Amended]**

- 65. Section 86.004–25 is amended by removing and reserving paragraphs (b)(4)(ii) and (b)(4)(iv).
- 66. Section 86.004–26 is amended as follows:
  - a. By removing the introductory text.

- b. By removing and reserving paragraphs (a) and (b).
- c. By revising paragraph (d).

**§ 86.004–26 Mileage and service accumulation; emission measurements.**

\* \* \* \* \*

(d)(1) This paragraph (d) applies for heavy-duty engines.

(2)(i) The results of all emission testing shall be supplied to the Administrator. The manufacturer shall furnish to the Administrator explanation for voiding any test. The Administrator will determine if voiding the test was appropriate based upon the explanation given by the manufacturer for the voided test. Tests between test points may be conducted as required by the Administrator. Data from all tests (including voided tests) may be submitted weekly to the Administrator, but shall be delivered to the Administrator within 7 days after completion of the test. In addition, all test data shall be compiled and provided to the Administrator in accordance with § 86.007–23. Where the Administrator conducts a test on a durability data vehicle at a prescribed test point, the results of that test will be used in the calculation of the deterioration factor.

(ii) The results of all emission tests shall be recorded and reported to the Administrator. These test results shall be rounded as specified in 40 CFR part 1065 to the number of decimal places contained in the applicable emission standard expressed to one additional significant figure.

(3) Whenever a manufacturer intends to operate and test a vehicle (or engine) that may be used for emission data, the manufacturer shall retain in its records all information concerning all emission tests and maintenance, including vehicle (or engine) alterations to represent other vehicle (or engine) selections. This information shall be submitted, including the vehicle (or engine) description and specification information required by the Administrator, to the Administrator following the emission test.

(4) Emission testing of any type with respect to any certification vehicle or engine other than that specified in this subpart is not allowed except as such testing may be specifically authorized by the Administrator.

**§ 86.004–28 [Amended]**

- 67. Section 86.004–28 is amended by removing the introductory text and by removing and reserving paragraphs (a), (b), (f), and (g).
- 68. Section 86.004–30 is amended as follows:

- a. By revising the introductory text.
- b. By removing and reserving paragraphs (a)(4), (a)(5), (a)(10)(i), and (a)(11)(i) and (a)(12) through (a)(16).
- c. By removing paragraphs (a)(19) through (a)(21).
- d. By removing and reserving paragraphs (b)(1)(i) and (b)(1)(ii).
- e. By removing paragraph (b)(1)(ii)(C) and (b)(1)(ii)(D).
- f. By removing and reserving paragraph (b)(4).

**§ 86.004–30 Certification.**

Section 86.004–30 includes text that specifies requirements that differ from § 86.094–30. Where a paragraph in § 86.094–30 is identical and applicable to § 86.004–30, this may be indicated by specifying the corresponding paragraph and the statement “[Reserved]. For guidance see § 86.094–30.”

\* \* \* \* \*

■ 69. Section 86.004–38 is amended by removing the introductory text, removing and reserving paragraph (g), and adding paragraph (i) to read as follows:

**§ 86.004–38 Maintenance instructions.**

\* \* \* \* \*

(i) For each new diesel-fueled engine subject to the standards prescribed in § 86.007–11, as applicable, the manufacturer shall furnish or cause to be furnished to the ultimate purchaser a statement that “This engine must be operated only with ultra low-sulfur diesel fuel (meeting EPA specifications for highway diesel fuel, including a 15 ppm sulfur cap).”

■ 70. Section 86.005–10 is amended by revising the introductory text and paragraph (c) to read as follows:

**§ 86.005–10 Emission standards for 2005 and later model year Otto-cycle heavy-duty engines and vehicles.**

Section 86.005–10 includes text that specifies requirements that differ from § 86.099–10. Where a paragraph in § 86.099–10 is identical and applicable to § 86.005–10, this may be indicated by specifying the corresponding paragraph and the statement “[Reserved]. For guidance see § 86.099–10.”

\* \* \* \* \*

(c) No crankcase emissions shall be discharged into the ambient atmosphere from any new 1998 or later model year Otto-cycle heavy-duty engine.

\* \* \* \* \*

**§ 86.005–17 [Removed]**

- 71. Remove § 86.005–17.
- 72. Section 86.007–17 is revised to read as follows:

**§ 86.007–17 Onboard diagnostics for engines used in applications less than or equal to 14,000 pounds GVWR.**

Heavy-duty engines intended to be installed in heavy duty vehicles at or below 14,000 pounds GVWR that are subject to standards under this subpart must meet onboard diagnostic requirements as specified in § 86.1806.

**§ 86.007–21 [Amended]**

■ 73. Section 86.007–21 is amended as follows:

■ a. By removing and reserving paragraph (b)(4)(i).

■ b. By removing paragraphs (b)(9) and (b)(10).

■ c. By removing and reserving paragraphs (k) and (l).

■ 74. Section 86.007–23 is amended by removing and reserving paragraphs (b)(2), (f), (g), and (l) and revising the introductory text and paragraph (c) to read as follows:

**§ 86.007–23 Required data.**

Section 86.007–23 includes text that specifies requirements that differ from § 86.098–23 or § 86.001–23. Where a paragraph in § 86.098–23 or § 86.001–23 is identical and applicable to § 86.007–23, this may be indicated by specifying the corresponding paragraph and the statement “[Reserved]. For guidance see § 86.098–23.” or “[Reserved]. For guidance see § 86.001–23.”.

\* \* \* \* \*

(c) *Emission data from certification vehicles and engines.* The manufacturer shall submit emission data for each applicable emission standard from vehicles and engines tested in accordance with applicable test procedures and in such numbers as specified. These data shall include zero-mile or zero-hour data, if generated, and emission data generated for certification as required under § 86.004–26. However, manufacturers may provide a statement in the application for certification that vehicles and engines comply with the following standards instead of submitting test data, provided that the statement is supported by previous emission tests, development tests, or other appropriate information, and good engineering judgment:

(1) Idle CO, smoke, or particulate matter emissions from methanol-fueled or gaseous-fueled diesel-cycle certification engines.

(2) Particulate matter emissions from Otto-cycle certification engines or gaseous-fueled certification engines.

(3) CO emissions from diesel-cycle certification engines.

(4) Formaldehyde emissions from petroleum-fueled engines.

(5) Particulate matter and formaldehyde emissions when conducting Selective Enforcement Audit testing of Otto-cycle engines.

(6) Smoke from methanol-fueled or petroleum-fueled diesel-cycle certification engines.

(7) Smoke when conducting Selective Enforcement Audit testing of diesel-cycle engines.

(8) Evaporative emissions from vehicles fueled by natural gas, liquefied petroleum gas, or hydrogen.

\* \* \* \* \*

**§ 86.007–30 [Amended]**

■ 75. Section 86.007–30 is amended as follows:

■ a. By removing and reserving paragraphs (a)(4), (a)(5), (a)(7), (a)(10)(i), (a)(11)(i), and (a)(12) through (a)(16).

■ b. By removing paragraphs (a)(19) through (a)(21).

■ c. By removing and reserving paragraphs (b)(1)(i), (b)(1)(ii), and (b)(4).

■ d. By removing paragraph (f).

■ 76. Section 86.007–35 is amended as follows:

■ a. By revising paragraph (a) introductory text.

■ b. By removing and reserving paragraphs (a)(1) and (a)(2).

■ c. By revising paragraph (c).

■ d. By removing and reserving paragraphs (d), (f), and (i).

**§ 86.007–35 Labeling.**

\* \* \* \* \*

(a) The manufacturer of any motor vehicle (or motor vehicle engine) subject to the applicable emission standards (and family emission limits, as appropriate) of this subpart, shall, at the time of manufacture, affix a permanent legible label, of the type and in the manner described below, containing the information hereinafter provided, to all production models of such vehicles (or engines) available for sale to the public and covered by a Certificate of Conformity under § 86.007–30(a).

\* \* \* \* \*

(c) Vehicles powered by model year 2007 through 2013 diesel-fueled engines must include permanent, readily visible labels on the dashboard (or instrument panel) and near all fuel inlets that state “Use Ultra Low Sulfur Diesel Fuel Only”; or “Ultra Low Sulfur Diesel Fuel Only”.

\* \* \* \* \*

**§ 86.007–38 [Removed]**

■ 77. Remove § 86.007–38.

■ 78. Section 86.008–10 is amended as follows:

■ a. By removing the introductory text.

■ b. By revising paragraph (b) introductory text.

■ c. By adding paragraph (b)(5).

■ d. By revising paragraph (e).

**§ 86.008–10 Emission standards for 2008 and later model year Otto-cycle heavy-duty engines and vehicles.**

\* \* \* \* \*

(b) This paragraph (b) applies as specified in 40 CFR 1037.103. Evaporative emissions from heavy-duty vehicles shall not exceed the following standards when measured using the test procedures specified in 40 CFR 1037.501. The standards apply equally to certification and in-use vehicles. The spitback standard also applies to newly assembled vehicles. For certification vehicles only, manufacturers may conduct testing to quantify a level of nonfuel background emissions for an individual test vehicle. Such a demonstration must include a description of the source(s) of emissions and an estimated decay rate. The demonstrated level of nonfuel background emissions may be subtracted from emission test results from certification vehicles if approved in advance by the Administrator.

\* \* \* \* \*

(5) Compressed natural gas vehicles must meet the requirements for fueling connection devices as specified in § 86.1813–17(f)(1). Vehicles meeting these requirements are deemed to comply with evaporative emission standards.

\* \* \* \* \*

(e) The standards described in this section do not apply to Otto-cycle medium-duty passenger vehicles (MDPVs) that are subject to regulation under subpart S of this part, except as specified in subpart S of this part. The standards described in this section also do not apply to Otto-cycle engines used in such MDPVs, except as specified in subpart S of this part. The term “medium-duty passenger vehicle” is defined in § 86.1803.

\* \* \* \* \*

■ 79. Section 86.010–38 is amended by revising paragraphs (g) and (i) to read as follows:

**§ 86.010–38 Maintenance instructions.**

\* \* \* \* \*

(g) Manufacturers are subject to the service-information requirements of § 86.1808–01(f) beginning in the 2005 model year for manufacturers of heavy-duty vehicles and heavy-duty engines weighing 14,000 pounds gross vehicle weight (GVW) and less that are subject to the OBD requirements of this part.

\* \* \* \* \*

(i) Through model year 2013, the manufacturer shall furnish or cause to

be furnished to the ultimate purchaser the following statement for each new diesel-fueled engine subject to the standards prescribed in § 86.007–11, as applicable: “This engine must be operated only with ultra low-sulfur diesel fuel (meeting EPA specifications for highway diesel fuel, including a 15 ppm sulfur cap).”

\* \* \* \* \*

80. Section 86.016–1 is amended by revising paragraphs (a), (b), and (c) and adding paragraphs (g) and (h) to read as follows:

**§ 86.016–1 General applicability.**

(a) *Applicability.* The provisions of this subpart apply for certain types of new heavy-duty engines and vehicles as described in this paragraph (a). Note that this subpart does not apply for light-duty vehicles, light-duty trucks, or medium-duty passenger vehicles (see subpart S of this part for requirements that apply for those vehicles). In some cases, manufacturers of heavy-duty engines and vehicles can choose whether to meet the requirements of this subpart or the requirements of subpart S of this part; those provisions are therefore considered optional, but only to the extent that manufacturers comply with the other set of requirements. In cases where a provision applies only for a certain vehicle group based on its model year, vehicle class, motor fuel, engine type, or other distinguishing characteristics, the limited applicability is cited in the appropriate section. The provisions of this subpart apply for certain heavy-duty engines and vehicles as follows:

(1) The provisions of this subpart related to exhaust emission standards apply for diesel-cycle and Otto-cycle heavy-duty engines installed in vehicles above 14,000 pounds GVWR; however, these vehicles may instead be certified under subpart S of this part as specified in § 86.1801.

(2) The provisions of this subpart related to exhaust emission standards apply for engines that will be installed in incomplete vehicles at or below 14,000 pounds GVWR; however, these vehicles may instead be certified under subpart S of this part as specified in § 86.1801.

(3) Diesel-cycle and Otto-cycle complete heavy-duty vehicles at or below 14,000 pounds GVWR and the corresponding engines are not subject to the provisions of this subpart related to exhaust emission standards, except that these provisions are optional for diesel-cycle engines installed in such vehicles until those vehicles become subject to the Tier 3 standards under § 86.1816–18.

(4) The provisions of this subpart related to evaporative emission standards apply for diesel-cycle and Otto-cycle heavy-duty vehicles as follows:

(i) These provisions do not apply for vehicles at or below 14,000 pounds GVWR.

(ii) Vehicles above 14,000 pounds GVWR must meet evaporative emission standards as specified in 40 CFR 1037.103. This involves meeting the standards specified in §§ 86.008–10(b) and 86.007–11(b)(3) and (4) until the Tier 3 standards in § 86.1813 start to apply.

(iii) Note that diesel-fueled vehicles are not subject to evaporative emissions under this part.

(5) The provisions of this subpart related to onboard diagnostics apply for diesel-cycle and Otto-cycle heavy-duty engines and vehicles as follows:

(i) Engines installed in vehicles above 14,000 pounds GVWR must meet the onboard diagnostic requirements specified in § 86.010–18.

(ii) Engines installed in vehicles at or below 14,000 pounds GVWR must meet the onboard diagnostic requirements specified in § 86.1806.

(b) *Relationship to subpart S of this part.* Unless specified otherwise, if engines are not subject to provisions of this subpart or if manufacturers choose not to meet optional provisions of this subpart as described in paragraph (a) of this section, those engines must be installed in vehicles meeting the corresponding requirements under subpart S of this part. If a vehicle and its installed engine comply with a mix of provisions from this subpart and from subpart S of this part, the vehicle must be certified under subpart S of this part, and the engine does not need to be certified separately.

(c) *Greenhouse gas emission standards.* See 40 CFR parts 1036 and 1037 for greenhouse gas emission standards that apply for heavy-duty engines and vehicles.

\* \* \* \* \*

(g) *Clean alternative fuel conversions.* The provisions of this subpart also apply for clean alternative fuel conversions as defined in 40 CFR 85.502 of all vehicles described in paragraph (a) of this section.

(h) *Turbine engines.* Turbine engines are deemed to be compression-ignition engines for purposes of this part.

**§ 86.079–36 [Removed]**

■ 81. Remove § 86.079–36.

■ 82. Section 86.082–2 is amended by adding definitions for “Round” and “United States” in alphabetical order to read as follows.

**§ 86.082–2 Definitions.**

\* \* \* \* \*

*Round* has the meaning given in 40 CFR 1065.1001, unless otherwise specified.

\* \* \* \* \*

*United States* has the meaning given in 40 CFR 1068.30.

\* \* \* \* \*

**§ 86.085–2 [Amended]**

■ 83. Section 86.085–2 is amended by removing the definition for “Incomplete gasoline-fueled heavy-duty vehicle”.

\* \* \* \* \*

■ 84. Section 86.085–20 is revised to read as follows:

**§ 86.085–20 Incomplete vehicles, classification.**

For purposes of this part:

(a) A heavy-duty gasoline-fueled vehicle is considered to be a complete vehicle if it has the primary load carrying device or container attached at the time the vehicle leaves the control of the manufacturer of the engine, and is considered to be an incomplete vehicle if it does not.

(b) For all other heavy-duty vehicles, a vehicle that has the primary load carrying device or container attached at the time the vehicle is introduced into U.S. commerce is considered to be a complete vehicle. Vehicles not considered to be complete vehicles are incomplete vehicles. For purposes of determining when a vehicle is introduced into U.S. commerce, an assembly of motor vehicle parts is deemed to be a vehicle if either of the following applies:

(1) A piece of equipment that is intended for self-propelled use on highways becomes a vehicle when it includes at least an engine, a transmission, and a frame. (Note: For purposes of this definition, any electrical, mechanical, and/or hydraulic devices attached to engines for the purpose of powering wheels are considered to be transmissions.)

(2) A piece of equipment that is intended for self-propelled use on highways becomes a vehicle when it includes a passenger compartment attached to a frame with axles.

**§ 86.085–37 [Amended]**

■ 85. Section 86.085–37 is amended by removing and reserving paragraph (b).

**§ 86.087–2 [Removed]**

■ 86. Remove § 86.087–2.

**§ 86.091–29 [Amended]**

■ 87. Section 86.091–29 is amended by removing and reserving paragraph (a).



■ 88. Section 86.094–7 is amended by adding paragraph (h)(6) to read as follows:

**§ 86.094–7 Maintenance of records; submittal of information; right of entry.**

\* \* \* \* \*

(h) \* \* \*

(6) EPA may void ab initio a certificate for a vehicle certified to Tier 1 certification standards or to the respective evaporative and/or refueling test procedure and accompanying evaporative and/or refueling standards as set forth or otherwise referenced in § 86.098–10 for which the manufacturer fails to retain the records required in this section or to provide such information to the Administrator upon request.

**§ 86.094–13 [Removed]**

■ 89. Remove § 86.094–13.

**§ 86.094–14 [Amended]**

■ 90. Section 86.094–14 is amended by removing and reserving paragraphs (c)(5) and (c)(7)(i)(A)(1).

**§ 86.094–16 [Removed]**

■ 91. Remove § 86.094–16.

**§ 86.094–21 [Amended]**

■ 92. Section 86.094–21 is amended by removing paragraph (b)(1)(i)(C) and by removing and reserving paragraphs (b)(4)(i), (b)(5)(iii)(B), (b)(8), (d), and (g).

**§ 86.094–25 [Amended]**

■ 93. Section 86.094–25 is amended as follows:

- a. By removing and reserving paragraphs (a), (b)(3)(i)(A), and (b)(3)(ii).
- b. By removing paragraphs (b)(3)(iii) through (b)(3)(vii).
- c. By removing and reserving paragraphs (b)(4) through (b)(6), (d), and (g).

**§§ 86.094–26 and 86.094–28 [Removed]**

■ 94. Remove §§ 86.094–26 and 86.094–28.

**§ 86.094–30 [Amended]**

■ 95. Section 86.094–30 is amended as follows:

- a. By removing and reserving paragraphs (a)(1)(ii), (a)(4), (a)(5), and (a)(7).
- b. By removing paragraphs (a)(9) through (a)(14).
- c. By removing and reserving paragraphs (b)(1)(i), (b)(1)(ii), and (b)(4).
- d. By removing and reserving paragraph (d).

**§§ 86.095–23, 86.095–26, and 86.095–30 [Removed]**

■ 96. Remove §§ 86.095–23, 86.095–26, and 86.095–30.

■ 97. Section 86.095–35 is amended as follows:

- a. By removing and reserving paragraphs (a)(1) and (a)(2).
- b. By adding paragraph (a)(4) introductory text.
- c. By removing and reserving paragraphs (d), (e), and (f).
- d. By adding paragraph (g) introductory text.

**§ 86.095–35 Labeling.**

(a) \* \* \*

(1)–(2) [Reserved]

\* \* \* \* \*

(4) *Heavy-duty vehicles employing a fuel or fuels covered by evaporative emission standards.* This paragraph (a)(4) applies for vehicles subject to evaporative emission standards under this subpart, as described in § 86.016–1(a)(4). See 40 CFR part 1037 for provisions that apply in later model years.

\* \* \* \* \*

(d)–(f) [Reserved]

(g) *Incomplete vehicle fuel tank capacity.* This paragraph (g) applies for vehicles subject to evaporative emission standards under this subpart, as described in § 86.016–1(a)(4). See 40 CFR part 1037 for provisions that apply in later model years.

\* \* \* \* \*

**§§ 86.096–7, 86.096–8, and 86.096–21 [Removed]**

■ 98. Remove §§ 86.096–7, 86.096–8, and 86.096–21.

**§ 86.096–24 [Amended]**

■ 99. Section 86.096–24 is amended as follows:

- a. By removing and reserving paragraphs (a)(8) through (a)(11).
- b. By removing and reserving paragraphs (a)(14)(ii), (a)(14)(iii), and (a)(14)(vii).
- c. By removing and reserving paragraphs (b)(1), (c)(1), (c)(2), and (d).
- d. By removing paragraphs (g) and (h).

**§§ 86.096–26, 86.096–30, 86.096–35, 86.096–38, and 86.097–9 [Removed]**

■ 100. Remove §§ 86.096–26, 86.096–30, 86.096–35, 86.096–38, and 86.097–9.

**§ 86.098–23 [Amended]**

■ 101. Section 86.098–23 is amended by removing and reserving paragraphs (b)(1)(i), (e)(2), and (e)(3).

**§§ 86.098–24, 86.098–25, 86.098–26, 86.098–28, 86.098–30, 86.098–35, 86.099–8, and 86.099–9 [Removed]**

■ 102A. Remove §§ 86.098–24, 86.098–25, 86.098–26, 86.098–28, 86.098–30, 86.098–35, 86.099–8, and 86.099–9.

**§ 86.099–17 [Removed]**

■ 102B. Remove § 86.099–17.

**Subpart B—[Amended]**

■ 103. Section 86.101 is revised to read as follows:

**§ 86.101 General applicability.**

(a) *General provisions.* This subpart describes test procedures for measuring exhaust, evaporative, and refueling emissions from motor vehicles subject to emission standards under subpart S of this part. This generally includes light-duty vehicles, light-duty trucks, and complete heavy-duty vehicles at or below 14,000 pounds GVWR. The following provisions apply for all testing under this subpart:

(1) Provisions of this subpart apply to tests performed by both the Administrator and manufacturers.

(2) References in this subpart to engine families and emission control systems apply to durability groups and test groups as applicable.

(3) Except as noted, heavy-duty vehicles are subject to all the same provisions of this subpart that apply to light-duty trucks.

(4) The procedures in this subpart apply for testing vehicles powered by any fuel, except as specified in subpart S of this part.

(5) For exhaust emission testing, measure emissions for all pollutants with an applicable emission standard.

(6) All emission control systems designed for production vehicles must be functioning during testing.

Maintenance to correct component malfunction or failure must be authorized in accordance with § 86.1834.

(7) The test sequence for the Federal Test Procedure (FTP) includes steps to precondition vehicles for evaporative emission measurements; these steps are required for exhaust testing whether or not testing includes evaporative emission measurements.

(8) Evaporative emission measurement procedures of this subpart include specifications for testing methanol-fueled vehicles. For vehicles fueled with other oxygenated fuels, use good engineering judgment to apply these procedures. For example, if you are testing an ethanol-fueled vehicle, perform diagnostics in your evaporative emission enclosure with ethanol and propane.

(9) For exhaust emission testing with ethanol-gasoline blends that have less than 25% ethanol by volume, if you use NMHC-to-NMOG conversion factors instead of measuring oxygenates as described in 40 CFR 1066.635, the

testing specifications and diagnostic requirements in this part 86 that are specific to ethanol-gasoline blends do not apply.

(b) *Migration to 40 CFR parts 1065 and 1066.* This subpart transitions to rely on the test procedure specifications in 40 CFR parts 1065 and 1066 as follows:

(1) Through model year 2021, manufacturers may use the test procedures specified in paragraph (c) or (d) of this section or, using good engineering judgment, elements of both. For any EPA testing before model year 2022, EPA will use the manufacturer's selected procedures for determining road load parameters and applying acceptable speed-tolerance criteria. For any other parameters, EPA may conduct testing using either of the specified procedures. As allowed under this part, manufacturers may use carryover data from previous model years to demonstrate compliance with emission standards, without regard to the provisions of this section.

(2) Manufacturers must use the following procedures before model year 2022:

(i) For vehicles certified to any of the Tier 3 emission standards specified in subpart S of this part, determine overall driver accuracy based on driven cycle energy as described in 40 CFR 1066.425(j).

(ii) Equipment specifications and measurement procedures that are specific to PM emissions from 40 CFR part 1066 apply for any vehicles certified to the Tier 3 PM emission standards specified in subpart S of this part.

(iii) Use 40 CFR 1066.635 to determine NMOG for any vehicles certified to the Tier 3 NMOG+NO<sub>x</sub> emission standards in subpart S of this part.

(3) For model years 2022 and later, manufacturers must use the test procedures specified in paragraph (d) of this section.

(c) *Interim procedures.* Test vehicles as described in this subpart for the appropriate model year, through model year 2021, as follows:

(1) Sections 86.106 through 86.115 set forth general testing specifications and equipment requirements. Sections 86.116 through 86.126 discuss calibration methods and frequency. Sections 86.127 through 86.145 describe procedures for measuring exhaust and evaporative emissions. Sections 86.146 through 86.157 lay out refueling test

procedures. Sections 86.158 through 86.166 cover procedures related to the Supplemental Federal Test Procedure and testing related to air conditioning systems. The test procedure for measuring fuel system leaks is described in 40 CFR 1066.985.

(2) Alternate equipment, procedures, and calculation methods may be used if shown to yield equivalent or superior results, and if approved in advance by the Administrator.

(d) *Long-term procedures.* Test vehicles as described in 40 CFR parts 1065 and 1066. The following requirements from this subpart also apply:

(1) Use fuel for testing and service accumulation as specified in § 86.113.

(2) Perform evaporative emission tests as follows:

(i) Use evaporative testing equipment meeting the specifications in § 86.107. This equipment must meet calibration requirements as specified in § 86.117.

(ii) Generate fuel test temperature profiles as described in § 86.129–94(d).

(iii) Follow the general provisions and driving schedules described in 40 CFR part 1066, subpart I. Evaporative testing consists of vehicle preconditioning as described in § 86.132, diurnal measurement as described in § 86.133, running loss testing as described in § 86.134, and hot soak testing as described in § 86.138.

(iv) Calculate emission results as described in § 86.143.

(3) Keep records as described in § 86.142

(4) Perform refueling emission tests, calculate emission results, and keep associated records as described in § 86.146 through 86.157.

■ 104. Section 86.102 is revised to read as follows:

#### § 86.102 Definitions.

The definitions in § 86.1803 apply to this subpart.

#### § 86.106–00 [Removed]

■ 105. Section 86.106–00 is removed.

■ 106. Section 86.106–96 is amended by revising paragraph (a)(3) to read as follows:

#### § 86.106–96 Equipment required; overview.

(a) \* \* \*

(3) *Fuel, analytical gas, and driving schedule specifications.* Fuel specifications for exhaust and evaporative emission testing and for mileage accumulation for petroleum-

fueled and methanol-fueled vehicles are specified in § 86.113. Analytical gases are specified in § 86.114. The Urban Dynamometer Driving Schedule (UDDS), US06, and SC03 driving schedules, for use in exhaust emission tests, and the New York City Cycle (NYCC), for use with the UDDS in running loss tests, are specified in §§ 86.115, 86.130, 86.159, 86.160, and appendix I to this part.

\* \* \* \* \*

#### § 86.107–96 [Amended]

■ 107. Section 86.107–96 is amended by removing and reserving paragraph (e).

#### § 86.108–79 [Removed]

■ 108A. Section 86.108–79 is removed.

#### § 86.110–90 [Removed]

■ 108B. Section 86.110–90 is removed.

■ 109. Section 86.110–94 is amended by revising paragraphs (b)(6)(i) and (d) to read as follows:

#### § 86.110–94 Exhaust gas sampling system; diesel-cycle vehicles, and Otto-cycle vehicles requiring particulate emissions measurements.

\* \* \* \* \*

(b) \* \* \*

(6) \* \* \*

(i) Sized to permit development of turbulent flow (Reynolds No. >>4000) and complete mixing of the exhaust and dilution air between the mixing orifice and each of the two sample probes (i.e., the particulate probe and the heated THC sample probe). It is recommended that uniform mixing be demonstrated by the user.

\* \* \* \* \*

(d) *Filters, particulate sampling.* Use fluorocarbon-coated glass fiber filters or fluorocarbon-based (membrane) filters to collect particulate matter, as follows:

(1) Use primary and back-up test filters as follows for particulate measurements:

(i) During each phase of the UDDS, sample dilute exhaust simultaneously with paired primary and back-up test filters.

(ii) Position the back-up filter holder 3 to 4 inches downstream of the primary filter holder.

(iii) Determine the net weight of particulate material collected on each primary test filter and each back-up test filter using the procedure described in § 86.139.

(iv) Determine a ratio of net weights using the following formula:

$$\text{Ratio of net weights} = \frac{(\text{Mass Particulate})_{\text{primary filter}}}{(\text{Mass Particulate})_{\text{primary filter}} + (\text{Mass Particulate})_{\text{back-up filter}}}$$

(v) If the ratio is greater than 0.95, base the particulate emission calculations on the net weight of the primary filter only.

(vi) If the ratio is less than 0.95, base the particulate emission calculations on the combined net weights of the back-up test filter and the primary test filter.

(2) The particulate filter must have a 47 mm diameter (37 mm stain area).

**§ 86.111-90 [Removed]**

■ 110. Section 86.111-90 is removed.

■ 111. Section 86.111-94 is amended by revising paragraph (b)(3)(vii) to read as follows:

**§ 86.111-94 Exhaust gas analytical system.**

\* \* \* \* \*

(b) \* \* \*

(3) \* \* \*

(vii) Using a methane analyzer consisting of a gas chromatograph combined with a FID, measure methane according to SAE J1151 (incorporated by reference in § 86.1).

\* \* \* \* \*

■ 112. Section 86.113-04 is amended by revising paragraphs (a)(1), (a)(2) and (a)(3)(i) to read as follows:

**§ 86.113-04 Fuel specifications.**

\* \* \* \* \*

(a) \* \* \*

(1) Gasoline meeting the following specifications, or substantially equivalent specifications approved by the Administrator, must be used for exhaust and evaporative emission testing:

TABLE 1 OF § 86.113-04—TEST FUEL SPECIFICATIONS FOR GASOLINE WITHOUT ETHANOL

Item	Regular	Reference procedure <sup>1</sup>
Research octane, Minimum <sup>2</sup> .....	93 .....	ASTM D2699
Octane sensitivity <sup>2</sup> .....	7.5 .....	ASTM D2700
Distillation Range (°F):		
Evaporated initial boiling point <sup>3</sup> .....	75-95 .....	
10% evaporated .....	120-135 .....	
50% evaporated .....	200-230 .....	ASTM D86
90% evaporated .....	300-325 .....	
Evaporated final boiling point .....	415 Maximum .....	
Hydrocarbon composition (vol %):		
Olefins .....	10% Maximum .....	
Aromatics .....	35% Maximum .....	ASTM D1319
Saturates .....	Remainder .....	
Lead, g/gallon (g/liter), Maximum .....	0.050 .....	ASTM D3237
	(0.013) .....	
Phosphorous, g/gallon (g/liter), Maximum .....	0.005 .....	ASTM D3231
	(0.0013) .....	
Total sulfur, wt. % <sup>4</sup> .....	0.0015-0.008 .....	ASTM D2622
Dry Vapor Pressure Equivalent (DVPE), kPa (psi) <sup>5</sup> .....	60.0-63.4 .....	ASTM D5191
	(8.7-9.2) .....	

<sup>1</sup> ASTM procedures are incorporated by reference in § 86.1.

<sup>2</sup> Octane specifications are optional for manufacturer testing.

<sup>3</sup> For testing at altitudes above 1,219 m (4000 feet), the specified range is 75-105° F.

<sup>4</sup> Sulfur concentration will not exceed 0.0045 weight percent for EPA testing.

<sup>5</sup> For testing unrelated to evaporative emission control, the specified range is 54.8-63.7 kPa (8.0-9.2 psi). For testing at altitudes above 1,219 m (4000 feet), the specified range is 52.0-55.4 kPa (7.6-8.0 psi). Calculate dry vapor pressure equivalent, DVPE, based on the measured total vapor pressure,  $p_T$ , using the following equation:  $DVPE$  (kPa) =  $0.956 \cdot p_T - 2.39$  (or  $DVPE$  (psi) =  $0.956 \cdot p_T - 0.347$ ). DVPE is intended to be equivalent to Reid Vapor Pressure using a different test method.

(2) Manufacturers may use California test fuels, as follows:

(i) For model year 2014 and earlier vehicles certified for 50-state sale, manufacturers may perform exhaust emission tests using California Phase 2 gasoline as specified in Chapter 4 of the California Regulatory Requirements Applicable to the National Low Emission Vehicle Program, October 1996 (incorporated by reference in § 86.1). However, the Administrator may use or require the use of test fuel meeting the specifications in paragraph (a)(1) of this section for confirmatory testing, selective enforcement auditing and in-use testing.

(ii) For model year 2015 and later, manufacturers may certify 50-state Tier 2 vehicles based on testing used to meet California's LEV III standards, subject to the following provisions:

(A) Manufacturers may perform exhaust and evaporative emission tests using California Phase 2 gasoline or California LEV III gasoline. The Administrator may use or require the use of test fuel meeting the specifications in paragraph (a)(1) of this section for confirmatory testing, selective enforcement auditing and in-use testing.

(B) All evaporative testing with California fuel must be conducted with

temperatures meeting the specifications adopted by the California Air Resources Board.

(C) The vehicles must also meet exhaust and evaporative emission standards at high-altitude conditions as specified in §§ 86.1811-17 and 86.1813-17, except that testing is based on the fuel specified in paragraph (a)(1) of this section.

(D) The vehicle must meet the applicable cold temperature standards using test fuel specified for cold temperature testing in § 86.213.

(3) \* \* \*

(i) Unless otherwise approved by the Administrator, gasoline representative

of commercial gasoline that will be generally available through retail outlets must be used in service accumulation. Unless otherwise approved by the Administrator, where the vehicle is to be used for evaporative emission durability demonstration, such fuel must contain ethanol as required by § 86.1824–08(f)(1).

\* \* \* \* \*

**§ 86.113–07 [Removed]**

■ 113. Remove § 86.113–07.

■ 114. A new § 86.113–15 is added to subpart B to read as follows:

**§ 86.113–15 Fuel specifications.**

Section 86.113–15 includes text that specifies requirements that differ from § 86.113–94. Where a paragraph in § 86.113–94 is identical and applicable to § 86.113–15, this may be indicated by specifying the corresponding paragraph and the statement “[Reserved]. For guidance see § 86.113–94.”

(a) *Gasoline fuel.* This paragraph (a) describes how to transition to an ethanol-blend test fuel for vehicles certified under subpart S of this part. You may use the test fuels specified in § 86.113–04(a) for vehicles that are not yet subject to testing with the new fuel. You may use the specified ethanol-blend test fuel anytime earlier than we specify as long as you use the corresponding procedures for measuring and calculating emission results. See 40 CFR 600.117 for special provisions that apply for emission measurements related to fuel economy and greenhouse gases. Manufacturers must certify using E10 test fuel as specified in 40 CFR part 1065, subpart H, and service accumulation fuel meeting applicable specifications as follows:

(1) Except as allowed under paragraph (a)(2) of this section, Use E10 test fuel to demonstrate compliance with the Tier 3 exhaust emission standards as specified in § 86.1811 and 86.1816, and to demonstrate compliance with the Tier 3 evaporative emission standards as specified in § 86.1813.

(2) You may use California test fuels to demonstrate compliance with Tier 3 emission standards as follows:

(i) For vehicles certified for 50-state sale, you may instead use California Phase 3 gasoline (E10) as adopted in California’s LEV III program for exhaust emission testing. Through model year 2019, we will also use this E10 fuel for any low-altitude exhaust emission testing with such vehicles. Starting in model year 2020, we may use test fuel meeting either California Phase 3 gasoline (E10) or the gasoline (E10) test

fuel specified in this paragraph (a). For cold temperature testing and for exhaust emission tests at high-altitude conditions, you may certify vehicles through model year 2019 based on testing with the gasoline (E0) test fuel specified in § 86.113–04(a); for such vehicles, we may use test fuel meeting either the gasoline (E0) test fuel specified in § 86.113–04(a) or the gasoline (E10) test fuel specified in this paragraph (a).

(ii) For vehicles that were certified to SULEV exhaust emission standards with a 150,000 mile useful life under California’s LEV II program and that are eligible to use that carryover data for continued certification, you may use that carryover data to demonstrate compliance with the exhaust emission standards that apply for Bin 30 vehicles under § 86.1811–17 for model years 2015 through 2019. The test fuel specifications that applied for the original emission measurements under the LEV II program also apply for any additional exhaust testing under the Tier 3 program, including confirmatory testing, selective enforcement auditing, and in-use testing. For vehicles certified under this paragraph (a)(2)(ii), use the E10 test fuel specified in 40 CFR 1065.710 for cold temperature testing and high-altitude testing.

(iii) For vehicles certified for 50-state sale, you may instead use California test fuel for evaporative emission testing as follows:

(A) If you originally certified vehicles in California in model year 2015 or 2016 to PZEV standards with California Phase 2 gasoline, you may use that data with carryover vehicles to certify to the Tier 3 evaporative emission standards through model year 2019. We will use this same fuel to measure diurnal, hot soak, running loss, and SHED rig emissions at low-altitude conditions for such vehicles. For refueling, spitback, and high-altitude testing, you may use test fuel meeting either the gasoline (E0) test fuel specified in § 86.113–04(a) or the gasoline (E10) test fuel specified in this paragraph (a); we may use either of the specified fuels for our testing. For leak testing, you must use the gasoline (E10) test fuel specified in this paragraph (a).

(B) If you certify vehicles to LEV III standards with California Phase 3 gasoline (E10), you may use that collection of data to certify to the Tier 3 evaporative emission standards. Through model year 2019, we will use this same fuel to measure diurnal, hot soak, running loss, SHED rig, and canister bleed emissions (as

appropriate) at low-altitude conditions; starting in model year 2020, we may use either California Phase 3 gasoline (E10) or the gasoline (E10) test fuel specified in this paragraph (a) for our testing with such vehicles. For refueling, spitback, high-altitude, and leak testing, you must use the gasoline (E10) test fuel specified in this paragraph (a), except that you may instead use the gasoline (E0) test fuel specified in § 86.113–04(a) for model year 2015 and 2016; we will use your selected fuel for our testing. Note that you may no longer certify vehicles to the Tier 3 standards based on California’s rig-testing procedures after model year 2021, as described in § 86.1813–17(g).

(C) For evaporative emission testing with California test fuels, perform tests based on the test temperatures specified by the California Air Resources Board.

(3) Except as specified in paragraph (a)(2)(iii) of this section and in this paragraph (a)(3), use E10 test fuel to demonstrate compliance with the refueling and spitback emission standards for any vehicles that must be certified to meet the diurnal plus hot soak standards with E10 test fuel under paragraphs (a)(1) and (2) of this section. You may delay using E10 test fuel until model year 2022 for incomplete heavy-duty vehicles not certified to refueling emission standards.

(4) If a vehicle uses E10 test fuel for evaporative emission testing and E0 is the applicable test fuel for exhaust emission testing, exhaust measurement and reporting requirements apply over the course of the evaporative emission test, but the vehicle need not meet the exhaust emission standards during the evaporative emission test run.

(5) For service accumulation, use a commercially available fuel, subject to the additional specification in § 86.1824–08(f) for evaporative emissions.

(b) through (g) [Reserved]. For guidance see § 86.113–94.

115. Section 86.113–94 is amended by removing and reserving paragraphs (a) and (d) and revising paragraphs (b)(2), (b)(3), (e), and (f)(3) to read as follows:

**§ 86.113–94 Fuel specifications.**

\* \* \* \* \*

(b) \* \* \*

(2) A diesel fuel designated as “Type 2–D” grade meeting the following specifications, or substantially equivalent specifications approved by the Administrator, must be used for exhaust emission testing:

Property	Unit	Type 2-D	Reference procedure <sup>1</sup>
(i) Cetane Number .....	.....	40-50 .....	ASTM D613
(ii) Cetane Index .....	.....	40-50 .....	ASTM D976
(iii) Distillation range:			
(A) IBP .....		340-400 (171.1-204.4)	ASTM D86
(B) 10 pct. point .....	°F (°C)	400-460 (204.4-237.8)	
(C) 50 pct. point .....		470-540 (243.3-282.2)	
(D) 90 pct. point .....		560-630 (293.3-332.2)	
EP .....		610-690 (321.1-365.6)	
(iv) Gravity .....		°API .....	32-37 .....
(v) Total sulfur .....	ppm .....	7-15 .....	ASTM D2622
(vi) Hydrocarbon composition: Aromatics, minimum (Remainder shall be paraffins, naphthenes, and olefins).	pct. ....	27 .....	ASTM D5186
(vii) Flashpoint, min. ....	°F (°C) .....	130 (54.4) .....	ASTM D93
(viii) Viscosity .....	centistokes .....	2.0-3.2 .....	ASTM D445

<sup>1</sup> ASTM procedures are incorporated by reference in § 86.1.

(3) A diesel fuel designated as “Type 2-D” grade meeting the following specifications, or substantially equivalent specifications approved by the Administrator, must be used for service accumulation:

Property	Unit	Type 2-D	Reference procedure <sup>1</sup>
(i) Cetane Number .....	.....	38-58 .....	ASTM D613
(ii) Cetane Index, minimum .....	.....	40 .....	ASTM D976
(iii) 90 percent distillation .....	°F .....	540-630 .....	ASTM D86
(iv) Gravity .....	°API .....	30-39 .....	ASTM D4052
(v) Total sulfur .....	Ppm .....	7-15 .....	ASTM D2622
(vi) Flashpoint, minimum .....	°F (°C) .....	130 (54.4) .....	ASTM D93
(vii) Viscosity .....	centistokes .....	1.5-4.5 .....	ASTM D445

<sup>1</sup> ASTM procedures are incorporated by reference in § 86.1.

\* \* \* \* \*

(e) *Natural gas.* (1) A natural gas fuel meeting the following specifications, or substantially equivalent specifications approved by the Administrator, must be used for exhaust and evaporative emission testing:

Item	Value <sup>1</sup>
Methane, CH <sub>4</sub> .....	Minimum, 89.0 mole percent.
Ethane, C <sub>2</sub> H <sub>6</sub> .....	Maximum, 4.5 mole percent.
C <sub>3</sub> and higher .....	Maximum, 2.3 mole percent.
C <sub>6</sub> and higher .....	Maximum, 0.2 mole percent.
Oxygen .....	Maximum, 0.6 mole percent.
Inert gases (sum of CO <sub>2</sub> and N <sub>2</sub> ).	Maximum, 4.0 mole percent.

<sup>1</sup> All parameters are based on the reference procedures in ASTM D1945 (incorporated by reference in § 86.1).

(2) The natural gas at ambient conditions must have a distinctive odor potent enough for its presence to be detected down to a concentration in air of not over one-fifth of the lower limit of flammability.

(3) Natural gas representative of commercially available natural gas fuel generally available through retail outlets shall be used in service accumulation for natural gas-fueled vehicles.

(4) A natural gas fuel meeting different specifications may be used for testing and service accumulation if all the following conditions are met:

- (i) The alternate test fuel is commercially available.
- (ii) Information acceptable to the Administrator is provided to show that only the designated fuel will be used in customer service.
- (iii) The Administrator must provide advance written approval for the alternate test fuel.

(f) \* \* \*  
 (3) The specification range of the fuel to be used under paragraphs (f)(1) and (2) of this section shall be measured in accordance with ASTM D2163 (incorporated by reference in § 86.1).

\* \* \* \* \*

**§ 86.115-00 [Removed]**

116. Section 86.115-00 is removed.

■ 117. Section 86.115-78 is amended by revising the section heading and paragraphs (a) and (b) introductory text to read as follows:

**§ 86.115-78 EPA dynamometer driving schedules.**

(a) The driving schedules for the Urban Dynamometer Driving Schedule, US06, SC03, and the New York City Cycles are specified in appendix I of this part. The driving schedules are

defined by a smooth trace drawn through the specified speed vs. time relationships. They each consist of a distinct non-repetitive series of idle, acceleration, cruise, and deceleration modes of various time sequences and rates.

(b) The driver should attempt to follow the target schedule as closely as possible (refer to § 86.128 for additional cycle driving instructions). The speed tolerance at any given time for these schedules, or for a driver’s aid chart approved by the Administrator, are as follows:

\* \* \* \* \*

■ 118. Section 86.117-96 is amended by revising the introductory text and paragraphs (c) introductory text, (c)(1)(vii), and (c)(1)(ix) to read as follows:

**§ 86.117-96 Evaporative emission enclosure calibrations.**

The calibration of evaporative emission enclosures consists of three parts: initial and periodic determination of enclosure background emissions (hydrocarbons and methanol); initial determination of enclosure internal volume; and periodic hydrocarbon and methanol retention check and calibration. Ethanol retention checks may be performed instead of methanol

retention checks. Alcohol retentions may be omitted if no alcohol-fueled vehicles will be tested in the evaporative enclosure. For evaporative and refueling emission tests with ethanol-gasoline blends that have less than 25% ethanol by volume, if you account for ethanol with a mathematical adjustment as described in § 86.1813–17(a)(1)(iv) instead of measuring ethanol, the testing specifications and diagnostic requirements in this part 86 that are specific to ethanol-gasoline blends do not apply. Alternate calibration methods may be used if shown to yield equivalent or superior results, and if approved in advance by the Administrator; specifically, more extreme temperatures may be used for determining calibration without affecting the validity of test results.

\* \* \* \* \*

(c) *Hydrocarbon and methanol (organic gas) retention check and calibration.* The hydrocarbon and methanol (if the enclosure is used for methanol-fueled vehicles) retention check provides a check upon the calculated volume and also measures the leak rate. The enclosure leak rate shall be determined prior to its introduction into service, following any modifications or repairs to the enclosure that may affect the integrity of the enclosure, and at least monthly thereafter. The methanol retention check must be performed only upon initial installation and after major maintenance, consistent with good engineering judgment. If six consecutive monthly retention checks are successfully completed without corrective action, the enclosure leak rate may be determined quarterly thereafter as long as no corrective action is required.

(1) \* \* \*

(vii) Inject into the enclosure 0.5 to 1.0 grams of pure methanol at a recommended temperature of at least 150 °F (65 °C) and/or 0.5 to 1.0 grams of pure propane at lab ambient temperature. The injected quantity may be measured by volume flow or by mass measurement. The method used to measure the quantity of methanol and propane must have an accuracy of ±0.5 percent of the measured value (less accurate methods may be used with the advance approval of the Administrator).

\* \* \* \* \*

(ix) To verify the enclosure calibration, calculate the mass of propane and the mass of methanol using the measurements taken in paragraphs (c)(1)(vi) and (viii) of this section. See paragraph (d) of this section. This quantity must be within ±2 percent of

that measured in paragraph (c)(1)(vii) of this section for propane and ±5 percent for methanol. Evaluate long-term trends using good engineering judgment to minimize measurement bias. Keep records to document such evaluations and make them available to EPA upon request.

\* \* \* \* \*

§ 86.118–78 [Removed]

■ 119A. Section 86.118–78 is removed.

§ 86.127–96 and 86.128–00 [Removed]

■ 119B. Sections 86.127–96 and 86.128–00 are removed.

■ 120. Section 86.128–79 is amended by revising paragraph (d) to read as follows:

§ 86.128–79 **Transmissions.**

\* \* \* \* \*

(d) The vehicle shall be driven with appropriate accelerator pedal movement necessary to achieve the speed versus time relationship prescribed by the driving schedule. Both smoothing of speed variations and excessive accelerator pedal perturbations are to be avoided.

\* \* \* \* \*

§ 86.129–80 [Amended]

■ 121. Section 86.129–80 is amended by removing and reserving paragraph (a).

§ 86.130–00 [Removed]

■ 122. Section 86.130–00 is removed.

■ 123. Section 86.130–96 is amended by adding introductory text, revising paragraph (e), and adding paragraph (f) to read as follows:

§ 86.130–96 **Test sequence; general requirements.**

Paragraphs (a) through (d) of this section are applicable to vehicles tested for the FTP test. Paragraph (e) of this section is applicable to vehicles tested for the SFTP supplemental tests of air conditioning (SC03) and aggressive driving (US06). Paragraph (f) of this section is applicable to all emission testing.

\* \* \* \* \*

(e) The supplemental tests for exhaust emissions related to aggressive driving (US06) and air conditioning (SC03) use are conducted as stand-alone tests as described in §§ 86.158 through 86.160. These tests may be performed in any sequence that maintains the appropriate preconditioning requirements as specified in § 86.132.

(f) If tests are invalidated after collection of emission data from previous test segments, the test may be repeated to collect only those data

points needed to complete emission measurements. Compliance with emission standards may be determined by combining emission measurements from different test runs. If any emission measurements are repeated, the new measurements supersede previous values.

§ 86.131–00 [Removed]

■ 124. Section 86.131–00 is removed.

■ 125. Section 86.131–96 is amended by adding paragraphs (f) and (g) to read as follows:

§ 86.131–96 **Vehicle preparation.**

\* \* \* \* \*

(f) For vehicles to be tested for aggressive driving emissions (US06), provide a throttle position sensing signal that is compatible with the test dynamometer. This signal provides the input information that controls dynamometer dynamic inertia weight adjustments (see §§ 86.108–00(b)(2)(ii) and 86.129–00(f)(2)). If a manufacturer chooses not to implement dynamic inertia adjustments for a portion or all of their product line, this requirement is not applicable.

(g) You may disable any AECDs that have been approved solely for emergency vehicle applications under paragraph (4) of the definition of defeat device in § 86.1803. The emission standards do not apply when any of these AECDs are active.

§ 86.132–96 [Amended]

■ 126. Section 86.132–96 is amended by removing and reserving paragraph (k).

■ 127. Section 86.134–96 is amended by revising paragraphs (g)(1)(vi), (g)(1)(xvi), and (g)(2)(vi) and adding paragraph (g)(4) to read as follows:

§ 86.134–96 **Running loss test.**

\* \* \* \* \*

(g) \* \* \*

(1) \* \* \*

(vi) Set vehicle air conditioning controls as described in 40 CFR 1066.835.

\* \* \* \* \*

(xvi) Fuel tank pressure must not exceed 10 inches of water during the running loss test, except that temporary exceedances are allowed for vehicles whose tank pressure remained below 10 inches of water during the entire outdoor driving period specified in § 86.129. These temporary pressure exceedances may not occur for more than 10 percent of the total driving time.

\* \* \* \* \*

(2) \* \* \*

(vi) Set vehicle air conditioning controls as described in 40 CFR 1066.835.

\* \* \* \* \*

(4) *High-altitude testing.* For testing under high-altitude conditions, decrease the target ambient and fuel temperatures by 5 °F. For example, the fuel temperature profile should be adjusted downward based on a nominal starting temperature of 90 °F, and the nominal temperature in the enclosure should be 90 °F.

\* \* \* \* \*

#### § 86.135–00 [Removed]

■ 128. Section 86.135–00 is removed.

■ 129. Section 86.135–90 is amended by revising paragraphs (a) and (d) to read as follows:

#### § 86.135–90 Dynamometer procedure.

(a) The dynamometer run consists of two tests—a “cold” start test, after a minimum 12-hour and a maximum 36-hour soak according to the provisions of §§ 86.132 and 86.133, and a “hot” start test following the “cold” start by 10 minutes. Engine startup (with all accessories turned off), operation over the UDDS and engine shutdown make a complete cold-start test. Engine startup and operation over the first 505 seconds of the driving schedule complete the hot start test. The exhaust emissions are diluted with ambient air in the dilution tunnel as shown in Figure B94–5 and Figure B94–6. A dilution tunnel is not required for testing vehicles waived from the requirement to measure particulate matter. Six particulate samples are collected on filters for weighing; the first sample plus backup is collected during the first 505 seconds of the cold-start test; the second sample plus backup is collected during the remainder of the cold-start test (including shutdown); the third sample plus backup is collected during the hot start test. Continuous or batch proportional samples of gaseous emissions are collected for analysis during each test phase. Use the following measurement procedures for each type of engine:

(1) For gasoline-fueled, natural gas-fueled and liquefied petroleum gas-fueled Otto-cycle vehicles, the composite samples collected in bags are analyzed for THC, CO, CO<sub>2</sub>, CH<sub>4</sub>, and NO<sub>x</sub>.

(2) For petroleum-fueled diesel-cycle vehicles (optional for natural gas-fueled, liquefied petroleum gas-fueled and methanol-fueled diesel-cycle vehicles), THC is sampled and analyzed continuously according to the provisions of § 86.110. Parallel samples

of the dilution air are similarly analyzed for THC, CO, CO<sub>2</sub>, CH<sub>4</sub>, and NO<sub>x</sub>.

(3) For natural gas-fueled, liquefied petroleum gas-fueled and methanol-fueled vehicles, bag samples are collected and analyzed for THC (if not sampled continuously), CO, CO<sub>2</sub>, CH<sub>4</sub>, and NO<sub>x</sub>.

(4) For methanol-fueled vehicles, methanol and formaldehyde samples are taken for both exhaust emissions and dilution air (a single dilution air formaldehyde sample, covering the total test period may be collected). Parallel bag samples of dilution air are analyzed for THC, CO, CO<sub>2</sub>, CH<sub>4</sub>, and NO<sub>x</sub>.

\* \* \* \* \*

(d) Practice runs over the prescribed driving schedule may be performed at test point, provided an emission sample is not taken, for the purpose of finding the appropriate throttle action to maintain the proper speed-time relationship, or to permit sampling system adjustment. Both smoothing of speed variations and excessive accelerator pedal perturbations are to be avoided. When using two-roll dynamometers a truer speed-time trace may be obtained by minimizing the rocking of the vehicle in the rolls; the rocking of the vehicle changes the tire rolling radius on each roll. This rocking may be minimized by restraining the vehicle horizontally (or nearly so) by using a cable and winch.

\* \* \* \* \*

#### § 86.135–94 [Removed]

■ 130A. Section 86.135–94 is removed.

#### § 86.137–90 [Removed]

■ 130B. Section 86.137–90 is removed.

■ 131. Section 86.137–94 is amended by revising paragraphs (b)(16) through (b)(24) to read as follows:

#### § 86.137–94 Dynamometer test run, gaseous and particulate emissions.

\* \* \* \* \*

(b) \* \* \*

(16) Immediately after the end of the sample period, turn off the cooling fan and close the engine compartment cover.

(17) Turn off the CVS or disconnect the exhaust tube from the tailpipe(s) of the vehicle.

(18) Repeat the steps in paragraphs (b)(2) through (b)(12) of this section for the hot start test, except only two evacuated sample bags, two methanol sample impingers, two formaldehyde sample impingers, and one pair of particulate sample filters, as appropriate, are required. The step in paragraph (b)(9) of this section shall begin between 9 and 11 minutes after

the end of the sample period for the cold-start test.

(19) At the end of the deceleration scheduled to occur at 505 seconds, simultaneously turn off gas flow measuring device No. 1 (and the petroleum-fueled diesel hydrocarbon integrator No. 1; mark the petroleum-fueled diesel hydrocarbon recorder chart and turn off the No. 1 particulate sample pump, if applicable) and position the sample selector valve to the “standby” position. (Engine shutdown is not part of the hot start test sample period.) Record the measured roll or shaft revolutions (and the No. 1 gas meter reading or flow measurement instrument). Carefully remove the third pair of particulate sample filters from the holder and place in a clean petri dish and cover, if applicable.

(20) As soon as possible, transfer the hot start “transient” exhaust and dilution air samples to the analytical system and process the samples according to § 86.140, obtaining a stabilized reading of the exhaust bag sample on all analyzers within 20 minutes of the end of the sample collection phase of the test. Obtain methanol and formaldehyde sample analyses, if applicable, within 24 hours of the end of the sample period. If it is not possible to perform analysis on the methanol and formaldehyde samples within 24 hours, the samples should be stored in a dark, cold (4–10 °C) environment until analysis. Analyze the samples within fourteen days.

(21) As soon as possible, and in no case longer than one hour after the end of the hot start phase of the test, transfer the six particulate filters to the weighing chamber for post-test conditioning, if applicable.

(22) Disconnect the exhaust tube from the vehicle tailpipe(s) and drive the vehicle from dynamometer.

(23) The CVS or CFV may be turned off, if desired.

(24) Vehicles to be tested for evaporative emissions proceed according to § 86.134; vehicles to be tested with the supplemental two-diurnal test sequence for evaporative emissions proceed according to § 86.138–96(k). For all others, this completes the test sequence.

#### § 86.137–96 [Removed]

■ 132. Section 86.137–96 is removed.

■ 133. Section 86.142–90 is amended by revising paragraph (d) to read as follows:

#### § 86.142–90 Records required.

\* \* \* \* \*

(d) Test results. Also include a comparison of drive cycle energy and



target cycle energy relative to both inertia and road load forces as specified in 40 CFR 1066.425 for each drive cycle or test phase, as appropriate.

■ 134. Section 86.143–96 is amended by revising paragraph (c) to read as follows:

**§ 86.143–96 Calculations; evaporative emissions.**

(c) If the test fuel contains at least 25% oxygenated compounds by volume, measure the concentration of oxygenated compounds directly using a

photoacoustic analyzer specified in 40 CFR 1065.269 or using impingers as described in 40 CFR 1065.805(f). Calculate total hydrocarbon equivalent emissions with the following equation, using density values specified in 40 CFR 1066.1005(f):

$$m_{\text{THCE}} = m_{\text{THC}} + \rho_{\text{THC}} \cdot \sum_{i=1}^N \frac{m_{\text{OHC}i}}{\rho_{\text{OHC}i}} \cdot (1 - RF_{\text{OHC}i[\text{THC-FID}]})$$

Where:

- $m_{\text{THCE}}$  = the sum of the mass of THCE in the SHED.
- $m_{\text{THC}}$  = the mass of THC and all oxygenated hydrocarbons in the SHED, as measured by the FID. Calculate THC mass based on  $\rho_{\text{THC}}$ .
- $\rho_{\text{THC}}$  = the effective C<sub>1</sub>-equivalent density of THC as specified in 40 CFR 1066.1005(f).
- $m_{\text{OHC}i}$  = the mass of oxygenated species  $i$  in the SHED.
- $\rho_{\text{OHC}i}$  = the C<sub>1</sub>-equivalent density of oxygenated species  $i$ .
- $RF_{\text{OHC}i[\text{THC-FID}]}$  = the response factor of a THC-FID to oxygenated species  $i$  relative to propane on a C<sub>1</sub>-equivalent basis as determined in 40 CFR 1065.845.

■ 135. Section 86.153–98 is amended by adding paragraph (b)(3) to read as follows:

**§ 86.153–98 Vehicle and canister preconditioning; refueling test.**

- (b) \* \* \*
- (3) Manufacturers may use the procedures described in this paragraph (b) to demonstrate compliance with the seal test for vehicles with fuel tanks exceeding 35 gallons nominal fuel tank capacity, and for any incomplete vehicles.

**§ 86.162–00 [Removed]**

■ 136A. Section 86.162–00 is removed.

**§ 86.167–17 [Removed]**

- 136B. Section 86.167–17 is removed.
- 137. Subpart C is revised to consist of §§ 86.201 and 86.213 to read as follows:

**Subpart C—Emission Regulations for 1994 and Later Model Year Gasoline-Fueled New Light-Duty Vehicles, New Light-Duty Trucks and New Medium-Duty Passenger Vehicles; Cold Temperature Test Procedures**

- Sec. 86.201 General applicability.
- 86.213 Fuel specifications.

**Subpart C—Emission Regulations for 1994 and Later Model Year Gasoline-Fueled New Light-Duty Vehicles, New Light-Duty Trucks and New Medium-Duty Passenger Vehicles; Cold Temperature Test Procedures**

**§ 86.201 General applicability.**

(a) Vehicles are subject to cold temperature testing requirements as described in subpart S of this part and 40 CFR part 600. Perform testing to measure CO and NMHC emissions and determine fuel economy as described in 40 CFR part 1066; see especially 40 CFR 1066.710.

(b) Perform intermediate temperature testing as follows:

(1) For testing during ambient temperatures of less than 50°F (10 °C), perform testing as described in 40 CFR part 1066, subpart H.

(2) For testing at temperatures of 50°F (10 °C) or higher, perform FTP testing as described in 40 CFR part 1066.

(c) Through model year 2021, manufacturers may certify vehicles based on data collected according to previously published cold temperature and intermediate temperature testing procedures. In addition, we may approve the use of previously published cold temperature and intermediate temperature testing procedures for later model years as an alternative procedure under 40 CFR 1066.10(c).

(d) Section 86.213 describes special provisions related to test fuel specifications.

**§ 86.213 Fuel specifications.**

(a) *Gasoline.* Use a gasoline test fuel with ethanol (low-level blend only) or without ethanol as follows:

(1) You must certify using service accumulation fuel and E10 test fuel as specified in § 86.113 for any vehicles required to use a low-level ethanol-gasoline blend test fuel for measuring exhaust emissions. You may use this test fuel any time earlier than we specify.

(2) You may use the test fuel specified in this paragraph (a)(2) for vehicles that are not yet subject to exhaust testing with an ethanol-blend test fuel under § 86.113. Manufacturers may certify based on this fuel using carryover data until testing with the ethanol-blend test fuel is required. The following specifications apply for gasoline test fuel without ethanol:

TABLE 1 OF § 86.213—COLD TEMPERATURE TEST FUEL SPECIFICATIONS FOR GASOLINE WITHOUT ETHANOL

Item	Regular	Premium	Reference procedure <sup>1</sup>
(RON+MON)/2 <sup>2</sup> .....	87.8±0.3 .....	92.3±0.5 .....	ASTM D2699
Sensitivity <sup>3</sup> .....	7.5 .....	7.5 .....	ASTM D2700
Distillation Range (°F):			
Evaporated initial boiling point .....	76–96 .....	76–96 .....	ASTM D86
10% evaporated .....	98–118 .....	105–125 .....	
50% evaporated .....	179–214 .....	195–225 .....	
90% evaporated .....	316–346 .....	316–346 .....	
Evaporated final boiling point .....	413 Maximum .....	413 Maximum .....	
Hydrocarbon composition (vol %):			
Olefins .....	12.5±0.5 .....	10.5±0.5 .....	ASTM D1319
Aromatics .....	26.4±4.0 .....	32.0±4.0 .....	
Saturates .....	Remainder .....	Remainder .....	
Lead, g/gallon .....	0.01, Maximum .....	0.01, Maximum .....	ASTM D3237

TABLE 1 OF § 86.213—COLD TEMPERATURE TEST FUEL SPECIFICATIONS FOR GASOLINE WITHOUT ETHANOL—Continued

Item	Regular	Premium	Reference procedure <sup>1</sup>
Phosphorous, g/gallon .....	0.005 Maximum .....	0.005 Maximum .....	ASTM D3231
Total sulfur, wt. % <sup>3</sup> .....	0.0015–0.008 .....	0.0015–0.008 .....	ASTM D2622
RVP, psi .....	11.5±0.3 .....	11.5±0.3 .....	ASTM D5191

<sup>1</sup> ASTM procedures are incorporated by reference in § 86.1.

<sup>2</sup> Octane specifications are optional for manufacturer testing. The premium fuel specifications apply for vehicles designed to use high-octane premium fuel.

<sup>3</sup> Sulfur concentration will not exceed 0.0045 weight percent for EPA testing.

(3) Manufacturers may use the E0 gasoline test fuel specified in § 86.113 for certification instead of the fuel specified in paragraph (a)(2) of this section, as long as the change in test fuel does not cause cold temperature NMHC, CO, or CO<sub>2</sub> emissions to decrease; manufacturers must keep records documenting these emission effects and make them available to EPA upon request.

(4) We may approve alternate fuel specifications that are substantially equivalent to those in paragraph (a)(2) of this section for a manufacturer's testing.

(b) *Diesel fuel.* Diesel fuel for testing under this subpart must meet the specifications for low-temperature test fuel in 40 CFR 1065.703.

**Subpart D—[Removed and reserved]**

■ 138. Subpart D is removed and reserved.

**Subpart F—[Amended]**

**§ 86.505–78 [Removed]**

■ 139. Remove § 86.505–78.

■ 140. Section 86.513–94 is redesignated as § 86.513, and the newly redesignated § 86.513 is amended by revising paragraphs (a) and (d) to read as follows:

**§ 86.513 Fuel and engine lubricant specifications.**

(a) *Gasoline.* (1) Gasoline meeting the following specifications, or substantially equivalent specifications approved by the Administrator, must be used for exhaust and evaporative emission testing:

TABLE 1 OF § 86.513—GASOLINE TEST FUEL SPECIFICATIONS

Item	Value	Procedure <sup>1</sup>
Distillation Range:		
1. Initial boiling point, °C .....	23.9–35.0 <sup>2</sup> .....	ASTM D86
2. 10% point, °C .....	48.9–57.2 .....	
3. 50% point, °C .....	93.3–110.0 .....	
4. 90% point, °C .....	1148.9–162.8 .....	
5. End point, °C .....	212.8 maximum .....	
Hydrocarbon composition:		
1. Olefins, volume % .....	10 maximum .....	ASTM D1319
2. Aromatics, volume % .....	35 maximum .....	
3. Saturates .....	Remainder .....	
Lead (organic), g/liter .....	0.013 maximum .....	ASTM D3237
Phosphorous, g/liter .....	0.0013 maximum .....	ASTM D3231
Sulfur, weight % .....	0.008 maximum .....	ASTM D2622
Dry Vapor Pressure Equivalent (DVPE), kPa .....	55.2 to 63.4 <sup>3</sup> .....	ASTM D5191

<sup>1</sup> ASTM procedures are incorporated by reference in § 86.1.

<sup>2</sup> For testing at altitudes above 1,219 m, the specified initial boiling point range is (23.9 to 40.6) °C.

<sup>3</sup> For testing at altitudes above 1,219 m, the specified volatility range is 52 to 55 kPa. Calculate dry vapor pressure equivalent, DVPE, based on the measured total vapor pressure,  $p_T$ , using the following equation:  $DVPE$  (kPa) =  $0.956 \cdot p_T - 2.39$  (or  $DVPE$  (psi) =  $0.956 \cdot p_T - 0.347$ ). DVPE is intended to be equivalent to Reid Vapor Pressure using a different test method.

(2) The following specifications apply for fuels used during service accumulation for certification:

(i) Unleaded gasoline and engine lubricants representative of commercial fuels and engine lubricants which will be generally available through retail outlets shall be used in service accumulation.

(ii) The octane rating of the gasoline used shall be no higher than 4.0 Research octane numbers above the minimum recommended by the manufacturer.

(iii) The Reid Vapor Pressure of the gasoline used shall be characteristic of commercial gasoline fuel during the

season in which the service accumulation takes place.

\* \* \* \* \*

(d) *Natural gas fuel.* (1) Natural gas meeting the following specifications, or substantially equivalent specifications approved by the Administrator, must be used for exhaust and evaporative emission testing:

TABLE 2 OF § 86.513—NATURAL GAS TEST FUEL SPECIFICATIONS

Item	Value <sup>1</sup>
Methane, CH <sub>4</sub> .....	Minimum, 89.0 mole percent.

TABLE 2 OF § 86.513—NATURAL GAS TEST FUEL SPECIFICATIONS—Continued

Item	Value <sup>1</sup>
Ethane, C <sub>2</sub> H <sub>6</sub> .....	Maximum, 4.5 mole percent.
C <sub>3</sub> and higher .....	Maximum, 2.3 mole percent.
C <sub>6</sub> and higher .....	Maximum, 0.2 mole percent.
Oxygen .....	Maximum, 0.6 mole percent.

TABLE 2 OF § 86.513—NATURAL GAS TEST FUEL SPECIFICATIONS—Continued

Item	Value <sup>1</sup>
Inert gases (sum of CO <sub>2</sub> and N <sub>2</sub> ).	Maximum, 4.0 mole percent.

<sup>1</sup> All parameters are based on the reference procedures in ASTM D1945 (incorporated by reference in § 86.1).

(2) The natural gas at ambient conditions must have a distinctive odor potent enough for its presence to be detected down to a concentration in air of not over one-fifth of the lower limit of flammability.

(3) Natural gas fuel and engine lubricants representative of commercial fuels and engine lubricants generally available through retail outlets shall be used in service accumulation.

(4) A natural gas fuel meeting different specifications may be used for testing and service accumulation if all the following conditions are met:

(i) The alternate test fuel is commercially available.

(ii) Information, acceptable to the Administrator, is provided to show that only the designated fuel will be used in customer service.

(iii) The Administrator must provide advance written approval for the alternate test fuel.

\* \* \* \* \*

■ 141. Section 86.515–78 is amended by revising paragraphs (a) and (d) to read as follows:

**§ 86.515–78 EPA urban dynamometer driving schedule.**

(a) The dynamometer driving schedules are listed in appendix I. The driving schedules are defined by a smooth trace drawn through the specified speed vs. time relationships. They consist of a nonrepetitive series of idle, acceleration, cruise, and deceleration modes of various time sequences and rates. Appropriate driving schedules are as follows:

- (1) Class I—Appendix I(b).
- (2) Class II—Appendix I(a)(2).
- (3) Class III—Appendix I(a)(2).

\* \* \* \* \*

(d) For motorcycles with an engine displacement less than 50 cc and a top speed less than 58.7 km/hr (36.5 mph), the speed indicated for each second of operation on the applicable Class I driving trace (speed versus time sequence) specified in appendix I(b) shall be adjusted downward by the ratio of actual top speed to specified maximum test speed. Calculate the ratio with three significant figures by dividing the top speed of the motorcycle

in km/hr by 58.7. For example, for a motorcycle with a top speed of 48.3 km/hr (30 mph), the ratio would be  $48.3/58.7 = 0.823$ . The top speed to be used under this section shall be indicated in the manufacturer's application for certification, and shall be the highest sustainable speed of the motorcycle with an 80 kg rider on a flat paved surface. If the motorcycle is equipped with a permanent speed governor that is unlikely to be removed in actual use, measure the top speed in the governed configuration; otherwise measure the top speed in the ungoverned configuration.

**Subpart G—[Amended]**

■ 142. Section 86.608–98 is amended by revising paragraph (a) to read as follows:

**§ 86.608–98 Test procedures.**

(a) The prescribed test procedures are the Federal Test Procedure, as described in subpart B of this part, and the cold temperature CO test procedure as described in subpart C of this part. For purposes of Selective Enforcement Audit testing, the manufacturer shall not be required to perform any of the test procedures in subpart B of this part relating to evaporative emission testing, other than refueling emissions testing, except as specified in paragraph (a)(2) of this section.

(1) The Administrator may omit any of the testing procedures described in paragraph (a) of this section. Further, the Administrator may, on the basis of a written application by a manufacturer, approve optional test procedures other than those in subparts B and C of this part for any motor vehicle which is not susceptible to satisfactory testing using the procedures in subparts B and C of this part.

(2) The following exceptions to the test procedures in subpart B of this part are applicable to Selective Enforcement Audit testing:

(i) For mileage accumulation, the manufacturer may use test fuel meeting the specifications for mileage and service accumulation fuels of § 86.113. Otherwise, the manufacturer may use fuels other than those specified in this section only with the advance approval of the Administrator.

(ii) The manufacturer may measure the temperature of the test fuel at other than the approximate mid-volume of the fuel tank, as specified in § 86.131–96(a) with only a single temperature sensor, and may drain the test fuel from other than the lowest point of the tank, as specified in §§ 86.131–96(b) and 86.152–98(a), provided an equivalent method is used. Equivalency

documentation shall be maintained by the manufacturers and shall be made available to the Administrator upon request. Additionally, for any test vehicle that has remained under laboratory ambient temperature conditions for at least 6 hours prior to testing, the vehicle soak described in § 86.132–96(c) may be eliminated upon approval of the Administrator. In such cases, the vehicle shall be operated through the preconditioning drive described in § 86.132–96(c) immediately following the fuel drain and fill procedure described in § 86.132–96(b).

(iii) The manufacturer may perform additional preconditioning on Selective Enforcement Audit test vehicles other than the preconditioning specified in § 86.132 only if the additional preconditioning was performed on certification test vehicles of the same configuration.

(iv) [Reserved]

(v) The manufacturer may substitute slave tires for the drive wheel tires on the vehicle as specified in § 86.135–90(e): Provided, that the slave tires are the same size.

(vi) [Reserved]

(vii) In performing exhaust sample analysis under § 86.140–94.

(A) When testing diesel vehicles, or methanol-fueled Otto-cycle vehicles, the manufacturer shall allow a minimum of 20 minutes warm-up for the HC analyzer, and for diesel vehicles, a minimum of two hours warm-up for the CO, CO<sub>2</sub> and NO<sub>x</sub> analyzers. (Power is normally left on infrared and chemiluminescent analyzers. When not in use, the chopper motors of the infrared analyzers are turned off and the phototube high voltage supply to the chemiluminescent analyzers is placed in the standby position.)

(B) The manufacturer shall exercise care to prevent moisture from condensing in the sample collection bags.

(viii) The manufacturer need not comply with § 86.142 or § 86.155, since the records required therein are provided under other provisions of this subpart G.

(ix) If a manufacturer elects to perform the background determination procedure described in paragraph (a)(2)(xi) of this section in addition to performing the refueling emissions test procedure, the elapsed time between the initial and final FID readings shall be recorded, rounded to the nearest second rather than minute as described in § 86.154–98(e)(8). In addition, the vehicle soak described in § 86.153–98(e) shall be conducted with the windows and luggage compartment of the vehicle open.

(x) The Administrator may elect to perform a seal test, described in § 86.153–98(b), of both integrated and non-integrated systems instead of the full refueling test. When testing non-integrated systems, a manufacturer may conduct the canister purge described in § 86.153–98(b)(1) directly following the preconditioning drive described in § 86.132–96(e) or directly following the exhaust emissions test described in § 86.137–96.

(xi) In addition to the refueling test, a manufacturer may elect to perform the following background emissions determination immediately prior to the refueling measurement procedure described in § 86.154, provided EPA is notified of this decision prior to the start of testing in an SEA.

(A) The SHED shall be purged for several minutes immediately prior to the background determination. Warning: If at any time the concentration of hydrocarbons, of methanol, or of methanol and hydrocarbons exceeds 15,000 ppm C, the enclosure should be immediately purged. This concentration provides a 4:1 safety factor against the lean flammability limit.

(B) The FID (or HFID) hydrocarbon analyzer shall be zeroed and spanned immediately prior to the background determination. If not already on, the enclosure mixing fan and the spilled fuel mixing blower shall be turned on at this time.

(C) Place the vehicle in the SHED. The ambient temperature level encountered by the test vehicle during the entire background emissions determination shall be 80 °F ±3 °F. The windows and luggage compartment of the vehicle must be open and the gas cap must be secured.

(D) Seal the SHED. Immediately analyze the ambient concentration of hydrocarbons in the SHED and record. This is the initial background hydrocarbon concentration.

(E) Soak the vehicle for ten minutes ±1 minute.

(F) The FID (or HFID) hydrocarbon analyzer shall be zeroed and spanned immediately prior to the end of the background determination.

(G) Analyze the ambient concentration of hydrocarbons in the SHED and record. This is the final background hydrocarbon concentration.

(H) The total hydrocarbon mass emitted during the background determination is calculated according to § 86.156. To obtain a per-minute background emission rate, divide the total hydrocarbon mass calculated in this paragraph by the duration of the soak, rounded to the nearest second,

described in paragraph (a)(2)(xi)(G) of this section.

(I) The background emission rate is multiplied by the duration of the refueling measurement obtained in paragraph (a)(2)(ix) of this section. This number is then subtracted from the total grams of emissions calculated for the refueling test according to § 86.156–98(a) to obtain the adjusted value for total refueling emissions. The final results for comparison with the refueling emission standard shall be computed by dividing the adjusted value for total refueling mass emissions by the total gallons of fuel dispensed in the refueling test as described in § 86.156–98(b).

(xii) In addition to the requirements of subpart B of this part, the manufacturer shall prepare gasoline-fueled and methanol-fueled vehicles as follows prior to emission testing:

(A) The manufacturer shall inspect the fuel system to ensure the absence of any leaks of liquid or vapor to the atmosphere by applying a pressure of 14.5±0.5 inches of water (3.6±0.1 kPa) to the fuel system, allowing the pressure to stabilize, and isolating the fuel system from the pressure source. Following isolation of the fuel system, pressure must not drop more than 2.0 inches of water (0.5 kPa) in five minutes. If required, the manufacturer shall perform corrective action in accordance with paragraph (d) of this section and report this action in accordance with § 86.609–98(d).

(B) When performing this pressure check, the manufacturer shall exercise care to neither purge nor load the evaporative or refueling emission control systems.

(C) The manufacturer may not modify the test vehicle's evaporative or refueling emission control systems by component addition, deletion, or substitution, except to comply with paragraph (a)(2)(ii) of this section if approved in advance by the Administrator.

(3) The following exceptions to the test procedures in subpart C of this part are applicable to Selective Enforcement Audit testing:

(i) The manufacturer may measure the temperature of the test fuel at other than the approximate mid-volume of the fuel tank, as specified in § 86.107–96(e), and may drain the test fuel from other than the lowest point of the fuel tank, provided an equivalent method is used. Equivalency documentation shall be maintained by the manufacturer and shall be made available to the Administrator upon request.

(ii) In performing exhaust sample analysis under § 86.140, the

manufacturer shall exercise care to prevent moisture from condensing in the sample collection bags.

(iii) The manufacturer need not comply with § 86.142 since the records required therein are provided under other provisions of this subpart G.

(iv) In addition to the requirements of subpart C of this part, the manufacturer shall prepare gasoline-fueled vehicles as follows prior to exhaust emission testing:

(A) The manufacturer shall inspect the fuel system to ensure the absence of any leaks of liquid or vapor to the atmosphere by applying a pressure of 14.5±0.5 inches of water (3.6±0.1 kPa) to the fuel system allowing the pressure to stabilize and isolating the fuel system from the pressure source. Following isolation of the fuel system, pressure must not drop more than 2.0 inches of water (0.5 kPa) in five minutes. If required, the manufacturer shall perform corrective action in accordance with paragraph (d) of this section and report this action in accordance with § 86.609–98(d).

(B) When performing this pressure check, the manufacturer shall exercise care to neither purge nor load the evaporative or refueling emission control system.

(C) The manufacturer shall not modify the test vehicle's evaporative or refueling emission control system by component addition, deletion, or substitution, except if approved in advance by the Administrator, to comply with paragraph (a)(3)(i) of this section.

\* \* \* \* \*

■ 143. Section 86.609–98 is amended by revising paragraphs (a), (b), and (c) to read as follows:

**§ 86.609–98 Calculation and reporting of test results.**

(a) Initial test results are calculated following the test procedures specified in § 86.608–98(a). Round the initial test results to the number of decimal places contained in the applicable emission standard expressed to one additional significant figure.

(b) Final test results for each test vehicle are calculated by summing the initial test results derived in paragraph (a) of this section for each test vehicle, dividing by the number of times that specific test has been conducted on the vehicle, and rounding to the same number of decimal places contained in the applicable standard expressed to one additional significant figure.

(c) *Final deteriorated test results.* (1) *For each test vehicle.* The final deteriorated test results for each light-duty vehicle tested for exhaust

emissions and/or refueling emissions according to subpart B, subpart C, or subpart R of this part are calculated by first multiplying or adding, as appropriate, the final test results by or to the appropriate deterioration factor derived from the certification process for the engine or evaporative/refueling family and model year to which the selected configuration belongs, and then by multiplying by the appropriate reactivity adjustment factor, if applicable, and rounding to the same number of decimal places contained in the applicable emission standard. For the purpose of this paragraph (c), if a multiplicative deterioration factor as computed during the certification process is less than one, that deterioration factor is one. If an additive deterioration factor as computed during the certification process is less than zero, that deterioration factor will be zero.

(2) *Exceptions.* There are no deterioration factors for light-duty vehicle emissions obtained during spitback testing in accordance with § 86.146. Accordingly, for the fuel dispensing spitback test, the term “final deteriorated test results” means the final test results derived in paragraph (b) of this section for each test vehicle, rounded to the same number of decimal places contained in the applicable emission standard.

\* \* \* \* \*

#### § 86.610–98 [Amended]

- 144. Section 86.610–98 is amended by removing and reserving paragraph (c)(2).
- 145. Section 86.612–97 is revised to read as follows:

#### § 86.612–97 Suspension and revocation of certificates of conformity.

(a) The certificate of conformity is immediately suspended with respect to any vehicle failing pursuant to § 86.610–98(b) effective from the time that testing of that vehicle is completed.

(b) The Administrator may suspend the certificate of conformity for a configuration that does not pass a selective enforcement audit pursuant to § 86.610–98(c) based on the first test, or all tests, conducted on each vehicle. This suspension will not occur before ten days after failure to pass the audit.

(c) If the results of vehicle testing pursuant to the requirements of this subpart indicate the vehicles of a particular configuration produced at more than one plant do not conform to the regulations with respect to which the certificate of conformity was issued, the Administrator may suspend the certificate of conformity with respect to that configuration for vehicles

manufactured by the manufacturer in other plants of the manufacturer.

(d) The Administrator will notify the manufacturer in writing of any suspension or revocation of a certificate of conformity in whole or in part: Except, that the certificate of conformity is immediately suspended with respect to any vehicle failing pursuant to § 86.610–98(b) and as provided for in paragraph (a) of this section.

(e) The Administrator may revoke a certificate of conformity for a configuration when the certificate has been suspended pursuant to paragraph (b) or (c) of this section if the proposed remedy for the nonconformity, as reported by the manufacturer to the Administrator, is one requiring a design change(s) to the engine and/or emission control system as described in the Application for Certification of the affected configuration.

(f) Once a certificate has been suspended for a failed vehicle as provided for in paragraph (a) of this section, the manufacturer must take the following actions:

(1) Before the certificate is reinstated for that failed vehicle—

- (i) Remedy the nonconformity; and
- (ii) Demonstrate that the vehicle’s final deteriorated test results conform to the applicable emission standards or family particulate emission limits, as defined in this part 86 by retesting the vehicle in accordance with the requirements of this subpart.

(2) Submit a written report to the Administrator within thirty days after successful completion of testing on the failed vehicle, which contains a description of the remedy and test results for the vehicle in addition to other information that may be required by this subpart.

(g) Once a certificate has been suspended pursuant to paragraph (b) or (c) of this section, the manufacturer must take the following actions before the Administrator will consider reinstating such certificate:

(1) Submit a written report to the Administrator which identifies the reason for the noncompliance of the vehicles, describes the proposed remedy, including a description of any proposed quality control and/or quality assurance measures to be taken by the manufacturer to prevent the future occurrence of the problem, and states the date on which the remedies will be implemented.

(2) Demonstrate that the engine family or configuration for which the certificate of conformity has been suspended does in fact comply with the requirements of this subpart by testing vehicles selected from normal production runs of that

engine family or configuration at the plant(s) or the facilities specified by the Administrator, in accordance with: the conditions specified in the initial test order pursuant to § 86.603 for a configuration suspended pursuant to paragraph (b) or (c) of this section.

(3) If the Administrator has not revoked the certificate pursuant to paragraph (e) of this section and if the manufacturer elects to continue testing individual vehicles after suspension of a certificate, the certificate is reinstated for any vehicle actually determined to have its final deteriorated test results in conformance with the applicable standards through testing in accordance with the applicable test procedures.

(h) Once a certificate for a failed engine family or configuration has been revoked under paragraph (e) of this section and the manufacturer desires to introduce into commerce a modified version of that engine family or configuration, the following actions will be taken before the Administrator may issue a certificate for the new engine family or configuration:

(1) If the Administrator determines that the proposed change(s) in vehicle design may have an effect on emission performance deterioration and/or fuel economy, he/she shall notify the manufacturer within five working days after receipt of the report in paragraph (g)(1) of this section whether subsequent testing under this subpart will be sufficient to evaluate the proposed change(s) or whether additional testing will be required.

(2) After implementing the change(s) intended to remedy the nonconformity, the manufacturer shall demonstrate, if the certificate was revoked pursuant to paragraph (e) of this section, that the modified vehicle configuration does in fact conform with the requirements of this subpart by testing vehicles selected from normal production runs of that modified vehicle configuration in accordance with the conditions specified in the initial test order pursuant to § 86.603. The Administrator shall consider this testing to satisfy the testing requirements of § 86.079–32 or § 86.079–33 if the Administrator had so notified the manufacturer. If the subsequent testing results in a pass decision pursuant to the criteria in § 86.610–98(c), the Administrator shall reissue or amend the certificate, if necessary, to include that configuration: *Provided*, that the manufacturer has satisfied the testing requirements specified in paragraph (h)(1) of this section. If the subsequent audit results in a fail decision pursuant to the criteria in § 86.610–98(c), the revocation remains in effect. Any design change

approvals under this subpart are limited to the modification of the configuration specified by the test order.

(i) A manufacturer may at any time subsequent to an initial suspension of a certificate of conformity with respect to a test vehicle pursuant to paragraph (a) of this section, but not later than fifteen (15) days or such other period as may be allowed by the Administrator after notification of the Administrator's decision to suspend or revoke a certificate of conformity in whole or in part pursuant to paragraph (b), (c) or (e) of this section, request that the Administrator grant such manufacturer a hearing as to whether the tests have been properly conducted or any sampling methods have been properly applied.

(j) After the Administrator suspends or revokes a certificate of conformity pursuant to this section or notifies a manufacturer of his intent to suspend, revoke or void a certificate of conformity under § 86.007–30(e) or § 86.1850, and prior to the commencement of a hearing under § 86.614, if the manufacturer demonstrates to the Administrator's satisfaction that the decision to suspend, revoke or void the certificate was based on erroneous information, the Administrator shall reinstate the certificate.

(k) To permit a manufacturer to avoid storing non-test vehicles when conducting testing of an engine family or configuration subsequent to suspension or revocation of the certificate of conformity for that engine family or configuration pursuant to paragraph (b), (c), or (e) of this section, the manufacturer may request that the Administrator conditionally reinstate the certificate for that engine family or configuration. The Administrator may reinstate the certificate subject to the condition that the manufacturer consents to recall all vehicles of that engine family or configuration produced from the time the certificate is conditionally reinstated if the engine family or configuration fails the subsequent testing and to remedy any nonconformity at no expense to the owner.

#### Subpart H—[Removed and reserved]

■ 146. Subpart H is removed and reserved.

#### Subpart L—[Amended]

■ 147. Section 86.1102–87 is amended by adding a definition of “Round” to paragraph (b) in alphabetical order to read as follows:

#### § 86.1102–87 Definitions.

\* \* \* \* \*

(b) \* \* \*

*Round* has the meaning given in 40 CFR 1065.1001.

\* \* \* \* \*

■ 148. Section 86.1105–87 is amended by revising paragraph (e) to read as follows:

#### § 86.1105–87 Emission standards for which nonconformance penalties are available.

\* \* \* \* \*

(e) The values of COC<sub>50</sub>, COC<sub>90</sub>, and MC<sub>50</sub> in paragraphs (a) and (b) of this section are expressed in December 1984 dollars. The values of COC<sub>50</sub>, COC<sub>90</sub>, and MC<sub>50</sub> in paragraphs (c) and (d) of this section are expressed in December 1989 dollars. The values of COC<sub>50</sub>, COC<sub>90</sub>, and MC<sub>50</sub> in paragraph (f) of this section are expressed in December 1991 dollars. The values of COC<sub>50</sub>, COC<sub>90</sub>, and MC<sub>50</sub> in paragraphs (g) and (h) of this section are expressed in December 1994 dollars. The values of COC<sub>50</sub>, COC<sub>90</sub>, and MC<sub>50</sub> in paragraph (i) of this section are expressed in December 2001 dollars. The values of COC<sub>50</sub>, COC<sub>90</sub>, and MC<sub>50</sub> in paragraph (j) of this section are expressed in December 2011 dollars. These values shall be adjusted for inflation to dollars as of January of the calendar year preceding the model year in which the NCP is first available by using the change in the overall Consumer Price Index, and rounded to the nearest whole dollar.

\* \* \* \* \*

#### Subpart M—[Removed and reserved]

■ 149. Subpart M is removed and reserved.

#### Subpart N—Exhaust Test Procedures for Heavy-duty Engines

■ 150. The heading of subpart N is revised to read as set forth above.

■ 151. Section 86.1305–2010 is redesignated as § 86.1305, and newly redesignated § 86.1305 is revised to read as follows:

#### § 86.1305 Introduction; structure of subpart.

(a) This subpart specifies the equipment and procedures for performing exhaust-emission tests on Otto-cycle and diesel-cycle heavy-duty engines. Subpart A of this part sets forth the emission standards and general testing requirements to comply with EPA certification procedures.

(b) Use the applicable equipment and procedures for spark-ignition or compression-ignition engines in 40 CFR

part 1065 to determine whether engines meet the duty-cycle emission standards in subpart A of this part. Measure the emissions of all regulated pollutants as specified in 40 CFR part 1065. Use the duty cycles and procedures specified in §§ 86.1333, 86.1360, and 86.1362. Adjust emission results from engines using aftertreatment technology with infrequent regeneration events as described in § 86.004–28.

(c) The provisions in §§ 86.1370 and 86.1372 apply for determining whether an engine meets the applicable not-to-exceed emission standards.

(d) Measure smoke using the procedures in subpart I of this part for evaluating whether engines meet the smoke standards in subpart A of this part.

(e) Use the fuels specified in 40 CFR part 1065 to perform valid tests, as follows:

(1) For service accumulation, use the test fuel or any commercially available fuel that is representative of the fuel that in-use engines will use.

(2) For diesel-fueled engines, use the ultra low-sulfur diesel fuel specified in 40 CFR part 1065 for emission testing.

(3) For gasoline-fueled engines, use the appropriate E10 fuel specified in 40 CFR part 1065; however, through model year 2021 you may instead use the appropriate E0 fuel specified in 40 CFR part 1065, with the exception that the E0 fuel must have sulfur concentration between 0.0015 and 0.008 weight percent and research octane of at least 93. Starting in model year 2022, you may certify up to 5 percent of your nationwide sales volume of engines certified under subpart A of this part in a given model year based on this E0 test fuel if those engines are certified with carryover data.

(f) You may use special or alternate procedures to the extent we allow them under 40 CFR 1065.10. In addition, for 2010 and earlier model year engines, you may use modified test procedures as needed to conform to the procedures that were specified at the time of emission testing for the model year in question.

(g) This subpart applies to you as a manufacturer, and to anyone who does testing for you.

(h) For testing conducted with engines installed in vehicles, including field testing conducted to measure emissions under Not-To-Exceed test procedures, use the test procedures and equipment specified in 40 CFR part 1065, subpart J.

#### §§ 86.1305–90, 86.1305–2004 [Removed]

■ 152A. Remove §§ 86.1305–90 and 86.1305–2004.

§§ 86.1306–07, 86.1306–96, 86.1308–84, 86.1309–90, 86.1310–90, 86.1310–2007, 86.1311–94, 86.1312–88, 86.1312–2007, 86.1313–94, 86.1313–98, 86.1313–2004, 86.1313–2007, 86.1314–94, 86.1316–94, 86.1318–84, 86.1319–90, 86.1320–90, 86.1321–94, 86.1322–84, 86.1323–84, 86.1323–2007, 86.1324–84, 86.1325–94, 86.1326–90, 86.1327–96, 86.1327–98, 86.1330–90, and 86.1332–90 [Removed]

■ 152B. Remove §§ 86.1306–07, 86.1306–96, 86.1308–84, 86.1309–90,

86.1310–90, 86.1310–2007, 86.1311–94, 86.1312–88, 86.1312–2007, 86.1313–94, 86.1313–98, 86.1313–2004, 86.1313–2007, 86.1314–94, 86.1316–94, 86.1318–84, 86.1319–90, 86.1320–90, 86.1321–94, 86.1322–84, 86.1323–84, 86.1323–2007, 86.1324–84, 86.1325–94, 86.1326–90, 86.1327–96, 86.1327–98, 86.1330–90, and 86.1332–90.

■ 153. Section 86.1333–2010 is redesignated as § 86.1333, and newly

redesignated § 86.1333 is amended by revising paragraphs (a)(1), (c), and (d) to read as follows:

**§ 86.1333 Transient test cycle generation.**

(a) \* \* \*

(1) To unnormalize rpm, use the following equations:

(i) For diesel engines:

$$Actual\ rpm = \frac{\%rpm \cdot (Max\ Test\ Speed - Curb\ Idle\ Speed)}{112} + Curb\ Idle\ Speed$$

Where:

Max Test Speed = the maximum test speed as calculated in 40 CFR part 1065.

(ii) For Otto-cycle engines:

$$Actual\ rpm = \frac{\%rpm \cdot (Max\ Test\ Speed - Curb\ Idle\ Speed)}{100} + Curb\ Idle\ Speed$$

Where:

Max Test Speed = the maximum test speed as calculated in 40 CFR part 1065.

redesignated § 86.1360 is amended by revising paragraphs (b)(1), (c), and (f)(3) to read as follows:

mapping procedures defined in 40 CFR 1065.510.

\* \* \* \* \*

(f) \* \* \*

(c) *Clutch operation.* Manual transmission engines may be tested with a clutch. If used, the clutch shall be disengaged at all zero percent speeds, zero percent torque points, but may be engaged up to two points preceding a non-zero point, and may be engaged for time segments with zero percent speed and torque points of durations less than four seconds.

(d) Determine idle speeds as specified in 40 CFR 1065.510.

**§ 86.1360 Supplemental emission test; test cycle and procedures.**

\* \* \* \* \*

(b) \* \* \*

(1) Perform testing as described in § 86.1362 for determining whether an engine meets the applicable standards when measured over the supplemental emission test.

\* \* \* \* \*

(c) The engine speeds A, B and C, referenced in the table in paragraph (b)(1) of this section, must be determined as follows:

Speed A =  $n_{lo} + 0.25 \times (n_{hi} - n_{lo})$   
 Speed B =  $n_{lo} + 0.50 \times (n_{hi} - n_{lo})$   
 Speed C =  $n_{lo} + 0.75 \times (n_{hi} - n_{lo})$

Where:  $n_{hi}$  = High speed as determined by calculating 70% of the maximum power. The highest engine speed where this power value occurs on the power curve is defined as  $n_{hi}$ .

$n_{lo}$  = Low speed as determined by calculating 50% of the maximum power. The lowest engine speed where this power value occurs on the power curve is defined as  $n_{lo}$ .

Maximum power = the maximum observed power calculated according to the engine

(3) If the Maximum Allowable Emission Limit for any point, as calculated under paragraphs (f)(1) and (2) of this section, is greater than the applicable Not-to-Exceed limit (if within the Not-to-Exceed control area defined in § 86.1370(b)), then the Maximum Allowable Emission Limit for that point shall be defined as the applicable Not-to-Exceed limit.

\* \* \* \* \*

■ 156. Section 86.1362–2010 is redesignated as § 86.1362, and newly redesignated § 86.1362 is revised to read as follows:

**§ 86.1362 Steady-state testing with a ramped-modal cycle.**

This section describes how to test engines under steady-state conditions.

(a) Measure emissions by testing the engine on a dynamometer with the following ramped-modal duty cycle to determine whether it meets the applicable steady-state emission standards:

§§ 86.1333–90, 86.1334–84, 86.1335–90, 86.1336–84, 86.1337–96, 86.1337–2007, 86.1338–84, 86.1338–2007, 86.1339–90, 86.1340–90, 86.1340–94, 86.1341–90, 86.1341–98, 86.1342–90, 86.1342–94, 86.1343–88, and 86.1344–94 [Removed]

■ 154. Remove §§ 86.1333–90, 86.1334–84, 86.1335–90, 86.1336–84, 86.1337–96, 86.1337–2007, 86.1338–84, 86.1338–2007, 86.1339–90, 86.1340–90, 86.1340–94, 86.1341–90, 86.1341–98, 86.1342–90, 86.1342–94, 86.1343–88, and 86.1344–94.

■ 155. Section 86.1360–2007 is redesignated as § 86.1360, and newly

RMC Mode	Time in mode (seconds)	Engine speed <sup>1 2</sup>	Torque (percent) <sup>2 3</sup>
1a Steady-state .....	170	Warm Idle .....	0.
1b Transition .....	20	Linear Transition .....	Linear Transition.
2a Steady-state .....	173	A .....	100.
2b Transition .....	20	Linear Transition .....	Linear Transition.
3a Steady-state .....	219	B .....	50.
3b Transition .....	20	B .....	Linear Transition.
4a Steady-state .....	217	B .....	75.
4b Transition .....	20	Linear Transition .....	Linear Transition.



RMC Mode	Time in mode (seconds)	Engine speed <sup>1 2</sup>	Torque (percent) <sup>2 3</sup>
5a Steady-state	103	A	50.
5b Transition	20	A	Linear Transition.
6a Steady-state	100	A	75.
6b Transition	20	A	Linear Transition.
7a Steady-state	103	A	25.
7b Transition	20	Linear Transition	Linear Transition.
8a Steady-state	194	B	100.
8b Transition	20	B	Linear Transition.
9a Steady-state	218	B	25.
9b Transition	20	Linear Transition	Linear Transition.
10a Steady-state	171	C	100.
10b Transition	20	C	Linear Transition.
11a Steady-state	102	C	25.
11b Transition	20	C	Linear Transition.
12a Steady-state	100	C	75.
12b Transition	20	C	Linear Transition.
13a Steady-state	102	C	50.
13b Transition	20	Linear Transition	Linear Transition.
14 Steady-state	168	Warm Idle	0.

<sup>1</sup> Speed terms are defined in 40 CFR part 1065.

<sup>2</sup> Advance from one mode to the next within a 20-second transition phase. During the transition phase, command a linear progression from the speed or torque setting of the current mode to the speed or torque setting of the next mode.

<sup>3</sup> The percent torque is relative to maximum torque at the commanded engine speed.

(b) Perform the ramped-modal test as described in 40 CFR part 1065.

(c) For 2007 through 2010 model years, manufacturers may follow the

mode order described in this paragraph (c) instead of the mode order specified in paragraph (a) of this section. Any

EPA testing with these engines will rely on the same procedure used by the manufacturer for certification.

RMC Mode	Time in mode (seconds)	Engine speed <sup>1 2</sup>	Torque (percent) <sup>2 3</sup>
1a Steady-state	170	Warm Idle	0.
1b Transition	20	Linear Transition	Linear Transition.
2a Steady-state	170	A	100.
2b Transition	20	A	Linear Transition.
3a Steady-state	102	A	25.
3b Transition	20	A	Linear Transition.
4a Steady-state	100	A	75.
4b Transition	20	A	Linear Transition.
5a Steady-state	103	A	50.
5b Transition	20	Linear Transition	Linear Transition.
6a Steady-state	194	B	100.
6b Transition	20	B	Linear Transition.
7a Steady-state	219	B	25.
7b Transition	20	B	Linear Transition.
8a Steady-state	220	B	75.
8b Transition	20	B	Linear Transition.
9a Steady-state	219	B	50.
9b Transition	20	Linear Transition	Linear Transition.
10a Steady-state	171	C	100.
10b Transition	20	C	Linear Transition.
11a Steady-state	102	C	25.
11b Transition	20	C	Linear Transition.
12a Steady-state	100	C	75.
12b Transition	20	C	Linear Transition.
13a Steady-state	102	C	50.
13b Transition	20	Linear Transition	Linear Transition.
14 Steady-state	168	Warm Idle	0.

<sup>1</sup> Speed terms are defined in 40 CFR part 1065.

<sup>2</sup> Advance from one mode to the next within a 20-second transition phase. During the transition phase, command a linear progression from the speed or torque setting of the current mode to the speed or torque setting of the next mode.

<sup>3</sup> The percent torque is relative to maximum torque at the commanded engine speed.

**§§ 86.1362–2007 and 86.1363–2007 [Removed]**

■ 157. Remove §§ 86.1362–2007 and 86.1363–2007.

■ 158. Section 86.1370–2007 is redesignated as § 86.1370, and newly redesignated § 86.1370 is amended by revising paragraphs (a), (b)(3), (b)(6),

and (f) introductory text to read as follows:

**§ 86.1370 Not-To-Exceed test procedures.**

(a) *General.* The purpose of this test procedure is to measure in-use emissions of heavy-duty diesel engines while operating within a broad range of speed and load points (the Not-To-Exceed Control Area) and under conditions which can reasonably be expected to be encountered in normal vehicle operation and use. Emission results from this test procedure are to be compared to the Not-To-Exceed Limits specified in § 86.007–11(a)(4), or to later Not-To-Exceed Limits. The Not-To-Exceed Limits do not apply for engine-starting conditions. Tests conducted using the procedures specified in this subpart are considered valid Not-To-Exceed tests (Note: duty cycles and limits on ambient conditions do not apply for Not-To-Exceed tests).

(b) \* \* \*

(3) Notwithstanding the provisions of paragraphs (b)(1) and (2) of this section, all operating speed and load points with brake specific fuel consumption (BSFC) values within 5% of the minimum BSFC value of the engine. For the purposes of this requirement, BSFC must be calculated under the general test cell conditions specified in 40 CFR part 1065. The manufacturer may petition the Administrator at certification to exclude such points if the manufacturer can demonstrate that the engine is not expected to operate at such points in normal vehicle operation and use. Engines equipped with drivelines with multi-speed manual transmissions or automatic transmissions with a finite number of gears are not subject to the requirements of this paragraph (b)(3).

\* \* \* \* \*

(6)(i) For petroleum-fueled diesel cycle engines, the manufacturer may identify particular engine-vehicle combinations and may petition the Administrator at certification to exclude operating points from the Not-to-Exceed Control Area defined in paragraphs (b)(1) through (5) of this section if the manufacturer can demonstrate that the engine is not capable of operating at such points when used in the specified engine-vehicle combination(s).

(ii) For diesel cycle engines that are not petroleum-fueled, the manufacturer may petition the Administrator at certification to exclude operating points from the Not-to-Exceed Control Area defined in paragraphs (b)(1) through (5) of this section if the manufacturer can demonstrate that the engine is not expected to operate at such points in normal vehicle operation and use.

\* \* \* \* \*

(f) *NTE cold temperature operating exclusion.* Engines equipped with

exhaust gas recirculation (EGR) whose operation within the NTE control area specified in paragraph (b) of this section when operating during cold temperature conditions as specified in paragraph (f)(1) of this section are not subject to the NTE emission limits during the specified cold temperature conditions.

\* \* \* \* \*

**§ 86.1372–2007 [Redesignated as § 86.1372]**

■ 159. Section 86.1372–2007 is redesignated as § 86.1372.

**§ 86.1375–2007 and 86.1380–2004 [Removed]**

■ 160. Remove §§ 86.1375–2007 and 86.1380–2004.

**Subpart O—[Removed and reserved]**

■ 161. Subpart O is removed and reserved.

**Subpart R—[Removed and reserved]**

■ 162. Subpart R is removed and reserved.

**Subpart S—[Amended]**

■ 163. Section 86.1801–12 is amended by revising paragraphs (a) through (d) and adding paragraphs (e), (f), and (g) to read as follows:

**§ 86.1801–12 Applicability.**

(a) *Applicability.* The provisions of this subpart apply to certain types of new vehicles as described in this paragraph (a). Where the provisions apply for a type of vehicle, they apply for vehicles powered by any fuel, unless otherwise specified. In some cases, manufacturers of heavy-duty engines and vehicles can choose whether to meet the requirements of this subpart or the requirements of subpart A of this part; those provisions are therefore considered optional, but only to the extent that manufacturers comply with the other set of requirements. In cases where a provision applies only to a certain vehicle group based on its model year, vehicle class, motor fuel, engine type, or other distinguishing characteristics, the limited applicability is cited in the appropriate section. References in this subpart to 40 CFR part 86 generally apply to Tier 2 and older vehicles, while references to 40 CFR part 1066 generally apply to Tier 3 and newer vehicles; see 40 CFR 86.101 for detailed provisions related to this transition. The provisions of this subpart apply to certain vehicles as follows:

(1) The provisions of this subpart apply for light-duty vehicles and light-duty trucks.

(2) The provisions of this subpart apply for medium-duty passenger vehicles. The provisions of this subpart also apply for other complete heavy-duty vehicles at or below 14,000 pounds GVWR, except as follows:

(i) The provisions of this subpart are optional for diesel-cycle vehicles through model year 2017; however, if you are using the provisions of § 86.1811–17(b)(9) or § 86.1816–18(b)(8) to transition to the Tier 3 exhaust emission standards, the provisions of this subpart are optional for those diesel-cycle vehicles until the start of the Tier 3 phase-in for those vehicles.

(ii) Greenhouse gas emission standards apply as specified in 40 CFR parts 1036 and 1037 instead of the standards specified in this subpart.

(3) The provisions of this subpart generally do not apply to incomplete heavy-duty vehicles or to complete vehicles above 14,000 pounds GVWR (see subpart A of this part and 40 CFR part 1037). However, this subpart applies to such vehicles in the following cases:

(i) Heavy duty vehicles above 14,000 pounds GVWR and all sizes of incomplete heavy-duty vehicles may be optionally certified to the exhaust emission standards in this subpart that apply for heavy-duty vehicles.

(ii) The evaporative emission standards apply for incomplete heavy-duty vehicles at or below 14,000 pounds GVWR. Evaporative emission standards also apply for complete and incomplete heavy-duty vehicles above 14,000 pounds GVWR as specified in 40 CFR 1037.103.

(iii) Refueling emission standards apply for complete heavy-duty vehicles above 14,000 pounds GVWR as specified in 40 CFR 1037.103. All sizes of incomplete heavy-duty vehicles may be optionally certified to the refueling emission standards in this subpart.

(iv) The onboard diagnostic requirements in this subpart apply for incomplete vehicles at or below 14,000 pounds GVWR, but not for any vehicles above 14,000 pounds GVWR.

(4) The provisions of this subpart are optional for diesel-fueled Class 3 heavy-duty vehicles in a given model year if those vehicles are equipped with engines certified to the appropriate standards in § 86.007–11 for which less than half of the engine family's sales for the model year in the United States are for complete Class 3 heavy-duty vehicles. This includes engines sold to all vehicle manufacturers. If you are the original manufacturer of the engine and

the vehicle, base this showing on your sales information. If you manufacture the vehicle but are not the original manufacturer of the engine, you must use your best estimate of the original manufacturer's sales information.

(5) If you optionally certify vehicles to standards under this subpart, those vehicles are subject to all the regulatory requirements as if the standards were mandatory.

(b) *Relationship to subpart A of this part.* Unless specified otherwise, if heavy-duty vehicles are not subject to provisions of this subpart or if manufacturers choose not to meet optional provisions of this subpart as described in paragraph (a) of this section, the engines installed in those vehicles must meet the corresponding requirements under subpart A of this part. If a vehicle and its installed engine comply with a mix of provisions from this subpart and from subpart A of this part, the vehicle must be certified under this subpart, and the engine does not need to be certified separately.

(c) *Clean alternative fuel conversions.* The provisions of this subpart also apply to clean alternative fuel conversions as defined in 40 CFR 85.502 of all vehicles described in paragraph (a) of this section.

(d) *Small-volume manufacturers.* Special certification procedures are available for small-volume manufacturers as described in § 86.1838.

(e) *You.* The term "you" in this subpart refers to manufacturers subject to the emission standards and other requirements of this subpart.

(f) *Vehicle.* The term "vehicle", when used generically, does not exclude any type of vehicle for which the regulations apply (such as light-duty trucks).

(g) *Complete and incomplete vehicles.* Several provisions in this subpart, including the applicability provisions described in this section, are different for complete and incomplete vehicles. We differentiate these vehicle types as described in § 86.085–20.

\* \* \* \* \*

■ 164. Section 86.1803–01 is amended as follows:

- a. By removing the definition for "Certification Short Test (CST)".
- b. By adding definitions for "Class 2b" and "Class 3" in alphabetical order.
- c. By removing the definition for "Complete heavy-duty vehicle".
- d. By revising the definitions for "Emergency vehicle", "Family emission limit (FEL)", "Heavy-duty vehicle", and "Hybrid electric vehicle (HEV)".
- e. By removing the definitions for "Incomplete heavy-duty vehicle" and "Incomplete truck".

■ f. By adding definitions for "LEV III" and "Low-altitude conditions" in alphabetical order.

■ g. By removing the definition for "Low altitude conditions".

■ h. By revising the definition for "Non-methane organic gases (NMOG)".

■ i. By adding a definition for "Rated power" in alphabetical order.

■ j. By removing the definition for "Round, rounded or rounding".

■ k. By adding definitions for "Round (rounded, rounding)", "Section 177 states", "Tier 3", and "United States" in alphabetical order.

■ l. By revising the definition for "U.S. sales".

■ m. By adding definitions for "Volatile liquid fuel" and "We (us, our)" in alphabetical order.

**§ 86.1803–01 Definitions.**

\* \* \* \* \*

*Class 2b* means relating to heavy-duty vehicles at or below 10,000 pounds GVWR.

*Class 3* means relating to heavy-duty vehicles above 10,000 pounds GVWR and at or below 14,000 pounds GVWR.

\* \* \* \* \*

*Emergency vehicle* means one of the following:

(1) For the greenhouse gas emission standards in § 86.1818, emergency vehicle means a motor vehicle manufactured primarily for use as an ambulance or combination ambulance-hearse or for use by the U.S. Government or a State or local government for law enforcement.

(2) For the OBD requirements in § 86.1806, emergency vehicle means a motor vehicle manufactured primarily for use in medical response or for use by the U.S. Government or a State or local government for law enforcement or fire protection.

\* \* \* \* \*

*Family emission limit (FEL)* means a bin standard or emission level selected by the manufacturer that serves as the applicable emission standard for the vehicles in the family or test group in the context of fleet-average standards or emission credits.

\* \* \* \* \*

*Heavy-duty vehicle* means any motor vehicle rated at more than 8,500 pounds GVWR or that has a vehicle curb weight of more than 6,000 pounds or that has a basic vehicle frontal area in excess of 45 square feet. Note that MDPVs are heavy-duty vehicles that are in many cases subject to requirements that apply for light-duty trucks.

\* \* \* \* \*

*Hybrid electric vehicle (HEV)* means a motor vehicle which draws propulsion

energy from onboard sources of stored energy that are both an internal combustion engine or heat engine using consumable fuel, and a rechargeable energy storage system such as a battery, capacitor, hydraulic accumulator, or flywheel. This includes plug-in hybrid electric vehicles.

\* \* \* \* \*

*LEV III* means relating to the LEV III emission standards in Title 13, §§ 1961.2 and 1976 of the California Code of Regulations, as adopted by the California Air Resources Board (incorporated by reference in § 86.1).

\* \* \* \* \*

*Low-altitude conditions* means a test altitude less than 549 meters (1,800 feet).

\* \* \* \* \*

*Non-methane organic gases (NMOG)* means the sum of oxygenated and non-oxygenated hydrocarbons contained in a gas sample as measured using the procedures described in 40 CFR 1066.635.

\* \* \* \* \*

*Rated power* means an engine's maximum power output in an installed configuration, as determined by using SAE J1349 (incorporated by reference in § 86.1).

\* \* \* \* \*

*Round (rounded, rounding)* has the meaning given in 40 CFR 1065.1001, unless otherwise specified.

\* \* \* \* \*

*Section 177 states* means the states that have adopted California's motor vehicle standards for a particular model year under section 177 of the Clean Air Act (42 U.S.C. 7507).

\* \* \* \* \*

*Tier 3* means relating to the Tier 3 emission standards described in §§ 86.1811–17, 86.1813–17, and 86.1816–18.

\* \* \* \* \*

*United States* has the meaning given in 40 CFR 1068.30.

\* \* \* \* \*

*U.S. sales* means, unless otherwise specified, sales in any state or territory of the United States except for California or the section 177 states. Sale location is based on the point of first sale to a dealer, distributor, fleet operator, broker, or other entity.

\* \* \* \* \*

*Volatile liquid fuel* means any fuel other than diesel or biodiesel that is a liquid at atmospheric pressure and has a Reid Vapor Pressure higher than 2.0 pounds per square inch.

\* \* \* \* \*

We (us, our) means the Administrator of the Environmental Protection Agency and any authorized representatives.

\* \* \* \* \*

**§ 86.1805–01 [Removed]**

■ 165. Remove § 86.1805–01.

■ 166. A new § 86.1805–17 is added to subpart S to read as follows:

**§ 86.1805–17 Useful life.**

(a) *General provisions.* The useful life values specified in this section apply for all exhaust, evaporative, refueling, and OBD emission requirements described in this subpart, except for standards that are specified to apply only at certification. These useful life requirements also apply to all air conditioning leakage credits, air conditioning efficiency credits, and other credit programs used by the manufacturer to comply with the fleet-average CO<sub>2</sub> emission standards in § 86.1818. Useful life values are specified as a given number of calendar years and miles of driving, whichever comes first.

(b) *Greenhouse gas pollutants.* The emission standards in § 86.1818 apply for a useful life of 10 years or 120,000 miles for LDV and LLDT and 11 years or 120,000 miles for HLDT and HDV. Manufacturers may alternatively certify based on a longer useful life as specified in paragraph (d) of this section.

(c) *Cold temperature emission standards.* The cold temperature NMHC emission standards in § 86.1811 apply for a useful life of 10 years or 120,000 miles for vehicles at or below 6,000 pounds GVWR, and 11 years or 120,000 miles for vehicles above 6,000 pounds GVWR. The cold temperature CO emission standards in § 86.1811 apply for a useful life of 5 years or 50,000 miles.

(d) *Criteria pollutants.* The useful life provisions of this paragraph (d) apply for all emission standards not covered by paragraph (b) or (c) of this section. Except as specified in paragraph (f) of this section and in §§ 86.1811, 86.1813, and 86.1816, the useful life for LDT2, HLDT, MDPV, and HDV is 15 years or 150,000 miles. The useful life for LDV and LDT1 is 10 years or 120,000 miles. Manufacturers may optionally certify LDV and LDT1 to a useful life of 15 years or 150,000 miles, in which case the longer useful life would apply for all the standards and requirements covered by this paragraph (d).

(e) *Intermediate useful life.* Where exhaust emission standards are specified for an intermediate useful life, these standards apply for five years or 50,000 miles.

(f) *Interim provisions.* The useful life provisions of § 86.1805–12 apply for vehicles not yet subject to Tier 3 requirements. For example, vehicles above 6,000 pounds GVWR are not subject to the useful life provisions in this section until model year 2019 unless manufacturers voluntarily certify to the Tier 3 requirements earlier than the regulations require. Also, where the transition to Tier 3 standards involves a phase-in percentage for a given standard, vehicles not included as part of the phase-in portion of the fleet continue to be subject to the useful life provisions of § 86.1805–12 with respect to that standard. The useful life values for a set of vehicles may be different for exhaust and evaporative emission standards in 2021 and earlier model years; if vehicles have different useful life values for evaporative and exhaust emission standards, the evaporative useful life applies for the OBD requirements related to the leak standard and the exhaust useful life applies for all other OBD requirements.

**§§ 86.1806–01 and 86.1806–04 [Removed]**

■ 167. Remove §§ 86.1806–01 and 86.1806–04.

■ 168. Section 86.1806–05 is amended by revising the section heading and paragraphs (b) introductory text, (h), and (j) and adding paragraph (k)(7) to read as follows:

**§ 86.1806–05 Onboard diagnostics.**

\* \* \* \* \*

(b) *Malfunction descriptions.* The OBD system must detect and identify malfunctions in all monitored emission-related powertrain systems or components according to the following malfunction definitions as measured and calculated in accordance with test procedures set forth in subpart B of this part (chassis-based test procedures), excluding those test procedures defined as “Supplemental” test procedures in § 86.004–2 and codified in §§ 86.158, 86.159, and 86.160. For clean alternative fuel conversion manufacturers, your OBD system is expected to detect and identify malfunctions in all monitored emission-related powertrain systems or components according to the malfunction definitions described in this paragraph (b) as measured and calculated in accordance with the chassis-based test procedures set forth in subpart B of this part to the extent feasible, excluding the elements of the Supplemental FTP (see § 86.1803). However, at a minimum, systems must detect and identify malfunctions as

described in paragraph (k)(7) of this section.

\* \* \* \* \*

(h) *Incorporation by reference.* The following additional requirements apply based on industry standard specifications, which are incorporated by reference in § 86.1:

(1) The following requirements apply for standardized on-board to off-board communications:

(i) Starting in model year 2008, light-duty vehicles and light-duty trucks must comply with ISO 15765–4:2005(E), “Road Vehicles-Diagnostics on Controller Area Network (CAN)—Part 4: Requirements for emission-related systems”, January 15, 2005.

(ii) Starting in model year 2008, heavy-duty vehicles must comply with the protocol described in paragraph (h)(1)(i) of this section, or the following set of SAE standards: SAE J1939–11, Revised October 1999; SAE J1939–13, July 1999; SAE J1939–21, Revised April 2001; SAE J1939–31, Revised December 1997; SAE J1939–71, Revised January 2008; SAE J1939–73, Revised September 2006; SAE J1939–81, May 2003.

(iii) Note that for model years 1996 through 2007 manufacturers could instead comply with the protocols specified in SAE J1850, ISO 9141–2, or ISO 14230–4.

(2) Light-duty vehicles and light-duty trucks must meet the following additional specifications:

(i) Basic diagnostic data (as specified in §§ 86.094–17(e) and (f)) shall be provided in the format and units in SAE J1979 “E/E Diagnostic Test Modes—Equivalent to ISO/DIS 15031–5: Revised, May 2007.

(ii) Diagnostic trouble codes shall be consistent with SAE J2012 “Diagnostic Trouble Code Definitions—Equivalent to ISO/DIS 15031–6: April 30, 2002”, (Revised, April 2002).

(iii) The connection interface between the OBD system and test equipment and diagnostic tools shall meet the functional requirements of SAE J1962 “Diagnostic Connector—Equivalent to ISO/DIS 15031–3: December 14, 2001” (Revised, April 2002).

(iv) SAE J1930, Revised April 2002. All acronyms, definitions and abbreviations shall be formatted according to this industry standard. Alternatively, manufacturers may use SAE J2403, Revised August 2007.

(v) All equipment used to interface, extract, and display OBD-related information shall meet SAE J1978 “OBD II Scan Tool” Equivalent to ISO 15031–4: December 14, 2001”, (Revised, April 2002).

\* \* \* \* \*

(j) *California OBDII compliance option.* Manufacturers may comply with California's OBD requirements instead of meeting the requirements of this section as follows:

(1) Through the 2006 model year, demonstration of compliance with California OBDII requirements (Title 13 California Code of Regulations § 1968.2 (13 CCR 1968.2)), as modified, approved and filed on April 21, 2003 (incorporated by reference, see § 86.1), shall satisfy the requirements of this section, except that compliance with 13 CCR 1968.2(e)(4.2.2)(C), pertaining to 0.02 inch evaporative leak detection, and 13 CCR 1968.2(d)(1.4), pertaining to tampering protection, are not required to satisfy the requirements of this section. Also, the deficiency provisions of 13 CCR 1968.2(i) do not apply. In addition, demonstration of compliance with 13 CCR 1968.2(e)(16.2.1)(C), to the extent it applies to the verification of proper alignment between the camshaft and crankshaft, applies only to vehicles equipped with variable valve timing.

(2) For 2007 through 2012 model year vehicles, demonstration of compliance with California OBD II requirements (Title 13 California Code of Regulations § 1968.2 (13 CCR 1968.2)), approved on November 9, 2007 (incorporated by reference, see § 86.1), shall satisfy the requirements of this section, except that compliance with 13 CCR 1968.2(e)(4.2.2)(C), pertaining to 0.02 inch evaporative leak detection, and 13 CCR 1968.2(d)(1.4), pertaining to tampering protection, are not required to satisfy the requirements of this section. Also, the deficiency provisions of 13 CCR 1968.2(k) do not apply. In addition, demonstration of compliance with 13 CCR 1968.2(e)(15.2.1)(C), to the extent it applies to the verification of proper alignment between the camshaft and crankshaft, applies only to vehicles equipped with variable valve timing.

(3) Beginning with the 2013 model year, manufacturers may demonstrate compliance with California's 2013 OBD requirements as described in § 86.1806–17(a).

(4) For all model years, the deficiency provisions of paragraph (i) of this section and the evaporative leak detection requirement of paragraph (b)(4) of this section, if applicable, apply to manufacturers selecting this paragraph for demonstrating compliance.

(k) \* \* \*

(7) For clean alternative fuel conversion manufacturers (e.g., natural gas, liquefied petroleum gas, methanol, ethanol), in lieu of the requirements specified for other manufacturers in this paragraph (k), you may demonstrate that

the malfunction indicator light will illuminate, at a minimum, under any of the following circumstances when the vehicle is operated on the applicable alternative fuel:

(i) *Otto-cycle.* A catalyst is replaced with a defective catalyst system where the catalyst brick for the monitored volume has been removed (i.e., empty catalyst system) resulting in an increase of 1.5 times the NMOG (or NMOG+NO<sub>x</sub>) standard or FEL above the NMOG (or NMOG+NO<sub>x</sub>) emission level measured using a representative 4000 mile catalyst system.

(ii) *Diesel.* (A) If monitored for emissions performance—a catalyst is replaced with a defective catalyst system where the catalyst brick for the monitored volume has been removed (i.e., empty catalyst can) resulting in exhaust emissions exceeding 1.5 times the applicable standard or FEL for NO<sub>x</sub> (or NMOG+NO<sub>x</sub>) or PM.

(B) If monitored for performance—a particulate trap is replaced with a trap that has catastrophically failed.

(iii) *Misfire.* (A) *Otto-cycle.* An engine misfire condition is induced that completely disables one or more cylinders, either through mechanical or electrical means, resulting in exhaust emissions exceeding 1.5 times the applicable standards or FEL for CO, NMOG, or NO<sub>x</sub> (or NMOG+NO<sub>x</sub>).

(B) *Diesel.* An engine misfire condition resulting in complete lack of cylinder firing is induced and is not detected.

(iv) If so equipped, any oxygen sensor is replaced with a completely defective oxygen sensor, or an electronic simulation of such, resulting in exhaust emissions exceeding 1.5 times the applicable standard or FEL for CO, NMOG, or NO<sub>x</sub> (or NMOG+NO<sub>x</sub>).

(v) If so equipped and applicable, a vapor leak is introduced in the evaporative and/or refueling system (excluding the tubing and connections between the purge valve and the intake manifold) greater than or equal in magnitude to a leak caused by a 0.040 inch diameter orifice, or the evaporative purge air flow is blocked or otherwise eliminated from the complete evaporative emission control system. At a minimum, gas cap removal or complete venting of the evaporative and/or refueling system may be introduced resulting in a gross leak of the complete evaporative emission control system.

(vi) A malfunction condition is induced resulting in complete disablement in any emission-related powertrain system or component, including but not necessarily limited to, the exhaust gas recirculation (EGR)

system, if equipped, the secondary air system, if equipped, and the fuel control system, singularly resulting in exhaust emissions exceeding 1.5 times the applicable emission standard or FEL for PM, CO, NMOG, or NO<sub>x</sub> (or NMOG+NO<sub>x</sub>).

(vii) A malfunction condition is induced that completely disables an electronic emission-related powertrain system or component not otherwise described in this paragraph (k) that either provides input to or receives commands from the onboard computer resulting in a measurable impact on emissions. At a minimum, manufacturers may be required to perform this disablement on critical inputs and outputs where lack of the input and output disables an entire monitor as described in this paragraph (k)(7)(vii), disables multiple monitors (e.g., two or more) used by the onboard computer, or renders the entire onboard computer and its functions inoperative.

(viii) Clean alternative fuel conversion manufacturers must use good engineering judgment to induce malfunctions and may perform more stringent malfunction demonstrations than described in this paragraph (k)(7). In addition, the Administrator reserves the right to request a clean alternative fuel conversion manufacturer to perform stricter demonstration requirements, to the extent feasible, on clean alternative fuel conversions.

\* \* \* \* \*

■ 169. A new § 86.1806–17 is added to subpart S to read as follows:

**§ 86.1806–17 Onboard diagnostics.**

*Model year 2017 and later vehicles* must have onboard diagnostic (OBD) systems as described in this section. OBD systems must generally detect malfunctions in the emission control system, store trouble codes corresponding to detected malfunctions, and alert operators appropriately.

(a) Vehicles must comply with the 2013 OBD requirements adopted for California as described in this paragraph (a). California's 2013 OBD–II requirements are part of Title 13, § 1968.2 of the California Code of Regulations, approved on July 31, 2013 (incorporated by reference in § 86.1). The following clarifications and exceptions apply for vehicles certified under this subpart:

(1) For vehicles not certified in California, references to vehicles meeting certain California Air Resources Board emission standards are understood to refer to the corresponding EPA emission standards for a given family, where applicable. Use good

engineering judgment to correlate the specified standards with the bin standards that apply under this subpart.

(2) Vehicles must comply with OBD requirements throughout the useful life as specified in § 86.1805. If the specified useful life is different for evaporative and exhaust emissions, the useful life specified for evaporative emissions applies for monitoring related to fuel-system leaks and the useful life specified for exhaust emissions applies for all other parameters.

(3) The purpose and applicability statements in 13 CCR 1968.2(a) and (b) do not apply.

(4) The anti-tampering provisions in 13 CCR 1968.2(d)(1.4) do not apply.

(5) The requirement to verify proper alignment between the camshaft and crankshaft described in 13 CCR 1968.2(e)(15.2.1)(C) applies only for vehicles equipped with variable valve timing.

(6) The deficiency provisions described in paragraph (c) of this section apply instead of 13 CCR 1968.2(k).

(7) For emergency vehicles only, the provisions of 13 CCR 1968.2(e)(6.2.1) related to monitoring and identification of air-fuel ratio cylinder imbalance, as part of the fuel system monitoring, do not apply until model year 2020, unless the vehicle met the requirements in 2016 or earlier model years.

(8) Apply thresholds for exhaust emission malfunctions from Tier 3 vehicles based on the thresholds calculated for the corresponding bin standards in the California LEV II program as prescribed for the latest model year in CCR 1968.2(e)(1) through (3). For example, for Tier 3 Bin 160 standards, apply the threshold that applies for the LEV standards. For cases involving Tier 3 standards that have no corresponding bin standards from the California LEV II program, use the next highest LEV II bin. For example, for Tier 3 Bin 50 standards, apply the threshold that applies for the ULEV standards. You may apply thresholds that are more stringent than we require under this paragraph (a)(8).

(b) The following additional provisions apply:

(1) Model year 2017 and later vehicles must meet the OBD system requirements described in this paragraph (b)(1). When monitoring conditions are satisfied, test vehicles must detect the presence of a leak with an effective leak diameter at or above 0.020 inches, illuminate the MIL, and store the appropriate confirmed diagnostic trouble codes (DTCs) (13 CCR 1968.2 refers to these as fault codes). For a 0.020 inch leak, the DTC(s) shall be a

generic SAE J2012 DTC that is specific to an EVAP system very small leak (e.g., P0456, P04EE, or P04EF) or an equivalent manufacturer-specific DTC that we approve. Conduct testing using an O'Keefe Controls Co. metal "Type B" orifice with a diameter of 0.020 inches or an alternate orifice diameter approved under 13 CCR 1968.2(e)(4.2.3) or (e)(4.2.4).

(i) Use the methodology specified in 13 CCR 1968.2(h)(2.2) to select test vehicles to demonstrate that the OBD system is capable of detecting a 0.020 inch leak installed in the evaporative system, except that the manufacturer may use production-representative vehicles instead of the vehicle options specified in 13 CCR 1968.2(h)(2.3).

(ii) Perform tests in the laboratory, with or without a dynamometer, or on an outdoor road surface, as necessary to exercise the vehicle's ability to detect leaks in the evaporative system.

(iii) Perform at least two tests to evaluate the OBD system for leaks that are installed near the fuel fill pipe and near the canister. The implanted leak near the fuel fill pipe must be at the fuel cap or between the fuel cap and the fuel tank. The implanted leak near the canister must be in the vapor line between the canister and the fuel tank, or between the canister and the purge valve). If a vehicle has multiple canisters or fuel fill pipes, repeat the testing to evaluate the system for implanted leaks corresponding to each canister and fuel fill pipe. You may propose to implant leaks in different locations (e.g., near the purge valve); we will approve your alternate leak location if it more effectively demonstrates leak detection for your particular fuel system design.

(iv) If vehicle operation is needed to fulfill preconditioning (i.e., when engine-off tests require driving before vehicle shutdown to enable the engine-off monitor) or monitoring conditions for leak detection under this paragraph (b)(1) utilize an FTP cycle, Unified cycle, or some other specified operating cycle that will satisfy the approved monitoring or preconditioning conditions without the interference of approved deficiencies. Continue vehicle operation as needed to illuminate the MIL and store the appropriate DTCs.

(v) Emission measurements are not required during this OBD evaporative system leak monitoring demonstration testing.

(vi) For test groups not selected for testing in a given model year, you may instead provide a statement in the application for certification, consistent with good engineering judgment, that vehicles meet leak-detection

requirements based on previous OBD tests, development tests, or other appropriate information. For any untested test groups, the statement specified in § 86.1844–01(d)(8) applies with regard to the leak monitoring requirement. We may ask you to provide the data and other information that formed the basis for your statement. Select test groups in later model years such that testing will rotate to cover your whole product line over time.

(vii) Submit the following information in the application for certification:

(A) Describe the test sequence.

(B) Identify the driving cycle used and the time expired and distance driven before the MIL illuminated.

(C) Identify the ranges of in-use environmental and vehicle operating conditions for which the vehicle will not meet the leak-detection specifications described in this paragraph (b)(1). To meet this requirement, you may give us the same information you gave the California Air Resources Board regarding enable conditions for the evaporative system leak monitor.

(D) Identify the confirmed and permanent DTCs set by the OBD system during testing.

(E) Include the freeze frame information stored at the point the fault is detected.

(F) Include the SAE J1979 test results (e.g., Mode/Service \$06) corresponding to the DTCs that were stored during the test.

(viii) If you have one or more vehicle models in model year 2016 that do not comply with the leak requirements in 13 CCR 1968.2(e)(4), you may comply with the requirements of this paragraph (b)(1) in model year 2017 by substituting model year 2016 vehicles on an equal-percentage basis. Demonstrate this by calculating the percentage of vehicles subject to OBD requirements under this subpart that meet the requirements of this paragraph (b)(1) in model years 2016 and 2017; the sum of these two percentage values must be at or above 100 percent. Any model year 2017 vehicles not meeting the requirements of this paragraph (b)(1), as allowed by this paragraph (b)(1)(viii), may not be counted as compliant Tier 3 vehicles under the alternative phase-in specified in § 86.1813–17(g)(2)(ii).

(2) For vehicles subject to the leak standard in § 86.1813, OBD systems must record in computer memory the result of the most recent successfully completed diagnostic check for a 0.020 inch leak. Someone must be able to use the data to determine the miles driven since the last check occurred, the pass/fail result, and whether there has been

a check since the computer memory was last cleared (e.g., from a scan tool command or battery disconnect). The system may be designed to keep data only from the previous 750 miles of driving. (Note: This 750 mile requirement is related to the use of the OBD evaporative leak monitor in the leak test and should not be confused with either the minimum or maximum distance values specified in Table G-19 of SAE J1979.) The data must be reported in a standardized format consistent with other data required for the OBD system. The results must be scan-readable.

(3) For vehicles with fuel tanks exceeding 25 gallons nominal fuel tank capacity, you may request our approval for a leak threshold greater than 0.020 inches, up to a maximum value of 0.040 inches. We will generally approve a leak threshold equal to the standard that applies under § 86.1813.

(c) You may ask us to accept as compliant a vehicle that does not fully meet specific requirements under this section. Such deficiencies are intended to allow for minor deviations from OBD standards under limited conditions. We expect vehicles to have functioning OBD systems that meet the objectives stated in this section. The following provisions apply regarding OBD system deficiencies:

(1) Except as specified in paragraph (d) of this section, we will not approve a deficiency that involves the complete lack of a major diagnostic monitor, such as monitors related to exhaust aftertreatment devices, oxygen sensors, air-fuel ratio sensors, NO<sub>x</sub> sensors, engine misfire, evaporative leaks, and diesel EGR (if applicable).

(2) We will approve a deficiency only if you show us that full compliance is infeasible or unreasonable considering any relevant factors, such as the technical feasibility of a given monitor, or the lead time and production cycles of vehicle designs and programmed computing upgrades.

(3) Our approval for a given deficiency applies only for a single model year, though you may continue to ask us to extend a deficiency approval in renewable one-year increments. We may approve an extension if you demonstrate an acceptable level of effort toward compliance and show that the necessary hardware or software modifications would pose an unreasonable burden.

(d) For alternative-fuel vehicles, manufacturers may request a waiver from specific requirements for which monitoring may not be reliable for operation with the alternative fuel. However, we will not waive

requirements that we judge to be feasible for a particular manufacturer or vehicle model.

(e) For alternative-fuel conversions, manufacturers may meet the requirements of § 86.1806-05 instead of the requirements of this section.

(f) You may ask us to waive certain requirements in this section for emergency vehicles. We will approve your request for an appropriate duration if we determine that the OBD requirement in question could harm system performance in a way that would impair a vehicle's ability to perform its emergency functions.

(g) The following interim provisions describe an alternate implementation schedule for the requirements of this section in certain circumstances:

(1) Manufacturers may delay complying with all the requirements of this section, and instead meet all the requirements that apply under § 86.1806-05, for any heavy-duty vehicles that are not yet subject to the Tier 3 standards in § 86.1816.

(2) Except as specified in this paragraph (g)(2), small-volume manufacturers may delay complying with all the requirements of this section until model year 2022, and instead meet all the requirements that apply under § 86.1806-05 during those years. This provision does not apply for a vehicle model if it is identical to a 2016 vehicle model that was certified to meet California's OBD requirements under § 86.1806-05(j)(3). A vehicle model is considered identical to one from model year 2016 if it is certified in the current year based on the same test data for exhaust or evaporative emissions under the carryover data provisions of this subpart.

(3) Manufacturers may disregard the requirements of this section that apply above 8,500 pounds GVWR before model year 2019 and instead meet all the requirements that apply under § 86.1806-05. This also applies for model year 2019 vehicles from a test group with vehicles that have a Job 1 date on or before March 3, 2018 (see 40 CFR 85.2304).

#### § 86.1807-01 [Amended]

■ 170. Section 86.1807-01 is amended by removing and reserving paragraph (a)(3)(ix).

■ 171. Section 86.1808-01 is amended as follows:

■ a. By revising paragraphs (f)(1), (f)(3) introductory text, (f)(6)(ii)(D), (f)(7)(i) introductory text, (f)(7)(ii)(B), (f)(10)(ii), (f)(13) introductory text, (f)(13)(iv), and (f)(16)(i).

■ b. By adding paragraph (g).

#### § 86.1808-01 Maintenance instructions.

\* \* \* \* \*

(f) \* \* \*  
(1) *Applicability.* Manufacturers are subject to the provisions of this paragraph (f) for 1996 model year for and later light-duty vehicles and light-duty trucks. Manufacturers are subject to the provisions of this paragraph (f) for 2005 model year and later heavy-duty vehicles at or below 14,000 pounds GVWR and the corresponding engines that are subject to the OBD requirements of this part.

\* \* \* \* \*

(3) *Information dissemination.* Each manufacturer shall provide or cause to be provided to the persons specified in paragraph (f)(2)(i) of this section and to any other interested parties a manufacturer-specific Web site containing the information specified in paragraph (f)(2)(i) of this section for vehicles identified in paragraph (f)(1) of this section that have been offered for sale; this requirement does not apply to indirect information, including the information specified in paragraphs (f)(12) through (f)(16) of this section. Each manufacturer Web site shall—

\* \* \* \* \*

(6) \* \* \*

(ii) \* \* \*

(D) Any alternative means proposed by a manufacturer must be available to aftermarket technicians at a fair and reasonable price.

\* \* \* \* \*

(7) \* \* \*

(i) All information required to be made available by this section shall be made available at a fair and reasonable price. In determining whether a price is fair and reasonable, consideration may be given to relevant factors, including, but not limited to, the following:

\* \* \* \* \*

(ii) \* \* \*

(B) The Administrator will act on the request within 180 days following receipt of a complete request or following receipt of any additional information requested by the Administrator.

\* \* \* \* \*

(10) \* \* \*

(ii) Provide on the manufacturer's Web site an index of all emissions-related training information available for purchase by aftermarket service providers for 1994 and newer vehicles. The required information must be made available for purchase within 3 months of model introduction and then must be made available at the same time it is made available to manufacturer-franchised dealerships, whichever is earlier. The index shall describe the title



of the course or instructional session, the cost of the video tape or duplicate, and information on how to order the item(s) from the manufacturer Web site. All of the items available must be shipped within 24 hours of the order being placed and are to be made available at a fair and reasonable price as described in paragraph (f)(7) of this section. Manufacturers unable to meet the 24 hour shipping requirement under circumstances where orders exceed supply and additional time is needed by the distributor to reproduce the item being ordered may exceed the 24 hour shipping requirement, but in no instance can take longer than 14 days to ship the item.

\* \* \* \* \*

(13) *Generic and enhanced information for scan tools.*

Manufacturers shall make available to equipment and tool companies all generic and enhanced service information including bi-directional control and data stream information as defined in paragraph (f)(2)(ii) of this section. This requirement applies for 1996 and later model year vehicles.

\* \* \* \* \*

(iv) Manufacturers can satisfy the requirement of paragraph (f)(13)(iii) of this section by making available diagnostic trouble trees on their Web sites in full text.

\* \* \* \* \*

(16) \* \* \*

(i) Manufacturers who have developed special tools to extinguish the malfunction indicator light (MIL) for Model Years 1994 through 2003 shall make available the necessary information to equipment and tool companies to design a comparable generic tool.

\* \* \* \* \*

(g) Through model year 2013, the manufacturer shall furnish or cause to be furnished to the purchaser the following statement for each new diesel-fueled Tier 2 vehicle (certified using a test fuel with 15 ppm sulfur or less): "This vehicle must be operated only with ultra low sulfur diesel fuel (that is, diesel fuel meeting EPA specifications for highway diesel fuel, including a 15 ppm sulfur cap)."

**§ 86.1808-07 [Removed]**

■ 172. Remove § 86.1808-07.

■ 173. Section 86.1809-12 is amended by revising paragraph (c) introductory text to read as follows:

**§ 86.1809-12 Prohibition of defeat devices.**

\* \* \* \* \*

(c) For cold temperature CO and cold temperature NMHC emission control,

the Administrator will use a guideline to determine the appropriateness of the CO and NMHC emission control at ambient temperatures between 25 °F (the upper bound of the FTP test temperature range) and 68 °F (the lower bound of the FTP test temperature range). The guideline for CO emission congruity across the intermediate temperature range is the linear interpolation between the CO standard applicable at 25 °F and the CO standard applicable at 68 °F. The guideline for NMHC emission congruity across the intermediate temperature range is the linear interpolation between the NMHC FEL pass limit (e.g., 0.3499 g/mi for a 0.3 g/mi FEL) applicable at 20 °F and the Tier 2 NMOG standard or the Tier 3 NMOG+NO<sub>x</sub> bin standard to which the vehicle was certified at 68 °F, where the intermediate temperature NMHC level is rounded to the nearest hundredth for comparison to the interpolated line. For vehicles that exceed this CO emissions guideline or this NMHC emissions guideline upon intermediate temperature testing:

\* \* \* \* \*

■ 174. Section 86.1810-01 is amended by removing and reserving paragraph (m), and revising paragraphs (f), (k)(3), and (o) to read as follows:

**§ 86.1810-01 General standards; increase in emissions; unsafe condition; waivers.**

\* \* \* \* \*

(f) *Altitude requirements.* Unless otherwise specified, emission standards apply at low-altitude conditions and at high-altitude conditions. The following exceptions apply:

(1) The supplemental exhaust emission standards as described in § 86.1811-04(f) apply only at low-altitude conditions;

(2) The cold temperature NMHC emission standards as described in § 86.1811-10(g) apply only at low-altitude conditions;

(3) The evaporative emission standards specified in § 86.1811-09(e) apply at low-altitude conditions. The evaporative emission standards specified in § 86.1811-04(e) continue to apply at high-altitude conditions for 2009 and later model year vehicles.

\* \* \* \* \*

(k) \* \* \*

(3) *Refueling receptacle requirements.* Compressed natural gas vehicles must meet the requirements for fueling connection devices as specified in § 86.1813-17(f)(1).

\* \* \* \* \*

(o) *NMOG measurement procedures.* Measure NMOG emissions using the

procedures described in 40 CFR 1065.635.

\* \* \* \* \*

■ 175. A new § 86.1810-17 is added to subpart S to read as follows:

**§ 86.1810-17 General requirements.**

The following provisions apply to all vehicles certified under this subpart:

(a) Any device, system or element of design installed on or incorporated in a new motor vehicle to enable such vehicle to conform to the standards imposed by this subpart:

(1) Shall not in its operation or function cause the emission into the ambient air of any noxious or toxic substance that would not be emitted in the operation of such vehicle without such system, except as specifically permitted by regulation; and

(2) Shall not in its operation, function or malfunction result in any unsafe condition endangering the vehicle, its occupants, or persons or property in close proximity to the vehicle.

(b) In establishing the physically adjustable range of each adjustable parameter on a new motor vehicle, the manufacturer shall ensure that, taking into consideration the production tolerances, safe vehicle drivability characteristics are available within that range.

(c) Unless otherwise specified, the emission standards of this subpart apply equally for certification and for in-use vehicles throughout the specified useful-life period. Also, manufacturers must use good engineering judgment to determine that all of a vehicle's emission-related components are designed to operate properly throughout the specified useful-life period.

(d) Vehicles may not discharge crankcase emissions into the ambient atmosphere.

(e) All vehicles must have an onboard diagnostic system as described in § 86.1806.

(f) Emission standards apply at low-altitude conditions and at high-altitude conditions, except as noted in this subpart.

(g) The cold temperature CO and NMHC standards in this subpart refer to test procedures set forth in subpart C of this part and 40 CFR part 1066, subpart H. All other emission standards in this subpart rely on test procedures set forth in subpart B of this part. These procedures rely on the test specifications in 40 CFR parts 1065 and 1066 as described in subparts B and C of this part.

(h) Multi-fueled vehicles (including dual-fueled and flexible-fueled vehicles) must comply with all the requirements

established for each consumed fuel (and blend of fuels for flexible-fueled vehicles). The following specific provisions apply for flexible-fueled vehicles that operate on ethanol and gasoline:

(1) For exhaust emissions, we may identify the worst-case fuel blend for testing in addition to what is required for gasoline-fueled vehicles. The worst-case fuel blend may be the fuel specified in 40 CFR 1065.725, or it may consist of a combination of the fuels specified in 40 CFR 1065.710(b) and 1065.725. We may waive testing with the worst-case blended fuel for US06 and/or SC03 duty cycles; if we waive only SC03 testing, substitute the SC03 emission result using the standard test fuel for gasoline-fueled vehicles to calculate composite SFTP emissions.

(2) For refueling emissions, we may identify the worst-case fuel blend for testing in addition to what is required for gasoline-fueled vehicles. The worst-case fuel blend may consist of a combination of the fuels specified in 40 CFR 1065.710(c) and 1065.725. This is generally expected to be a fuel blend with 10 percent ethanol and a nominal Dry Vapor Pressure Equivalent of 10 psi. You may prepare such a worst-case fuel blend by mixing it before dispensing into the vehicle's fuel tank, or by consecutively dispensing appropriate amounts of the two specified fuels into a fuel tank.

(3) No additional spitback or evaporative emission testing is required beyond the emission measurements with the gasoline test fuel specified in 40 CFR 1065.710.

(i) Where we specify requirements based on a percentage of total sales volume in a given model year, you may instead ask us to calculate the percentage based on production volumes instead of sales volumes.

#### § 86.1811-01 [Removed]

■ 176. Remove § 86.1811-01.

■ 177. Section 86.1811-04 is amended as follows:

■ a. By revising paragraph (e)(3)(i).

■ b. By removing and reserving paragraph (h).

■ c. By revising paragraphs (j), (n), and (o)(1) to read as follows:

#### § 86.1811-04 Emission standards for light-duty vehicles, light-duty trucks and medium-duty passenger vehicles.

\* \* \* \* \*

(e) \* \* \*

(3) \* \* \*

(i) For gasoline-fueled and methanol-fueled LDV, LDT and MDPV: 0.20 grams hydrocarbon per gallon (0.053 grams per

liter) of fuel dispensed. This standard also applies for diesel-fueled LDV.

\* \* \* \* \*

(j) *Highway NO<sub>x</sub> exhaust emission standard.* The NO<sub>x</sub> emissions measured on the federal Highway Fuel Economy Test in 40 CFR part 600, subpart B, must not be greater than 1.33 times the applicable FTP NO<sub>x</sub> standard to which the manufacturer certifies the test group. Both the measured emissions and the product of the NO<sub>x</sub> standard and 1.33 must be rounded to the nearest 0.01 g/mi before being compared.

\* \* \* \* \*

(n) *Requirements for vehicles with rechargeable energy storage systems.* Manufacturers must measure emissions from hybrid electric vehicles (including plug-in hybrid electric vehicles) as described in 40 CFR part 1066, subpart F, except that these procedures do not apply for plug-in hybrid electric vehicles during charge-depleting operation.

(o) \* \* \*

(1) Manufacturers must measure NMOG emissions using the procedures described in 40 CFR 1066.635.

\* \* \* \* \*

■ 178. A new § 86.1811-17 is added to subpart S to read as follows:

#### § 86.1811-17 Exhaust emission standards for light-duty vehicles, light-duty trucks and medium-duty passenger vehicles.

(a) *Applicability and general provisions.* This section describes exhaust emission standards that apply for model year 2017 and later light-duty vehicles, light-duty trucks, and medium-duty passenger vehicles. MDPVs are subject to all the same provisions of this section that apply to LDT4. Some of the provisions of this section also apply to heavy-duty vehicles as specified in § 86.1816. See § 86.1818 for greenhouse gas emission standards. See § 86.1813 for evaporative and refueling emission standards. This section may apply to vehicles from model years earlier than 2017 as specified in paragraph (b)(11) of this section.

(b) *Tier 3 exhaust emission standards.* Exhaust emissions may not exceed the Tier 3 exhaust emission standards, as follows:

(1) Measure emissions using the chassis dynamometer procedures of 40 CFR part 1066, as follows:

(i) Establish appropriate load settings based on loaded vehicle weight (see § 86.1803).

(ii) Use appropriate driving schedules. Measurements involve testing over multiple driving schedules. The Federal

Test Procedure (FTP) is based on testing with the Urban Dynamometer Driving Schedule (UDDS). The Supplemental Federal Test Procedure (SFTP) involves testing with the UDDS, the US06 driving schedule, and the SC03 driving schedule. See 40 CFR 1066.801 for further information on these test cycles.

(iii) Calculate SFTP emissions as a composite of test results over the driving schedules identified in paragraph (b)(1)(ii) of this section based on the following calculation:

$$\text{SFTP (g/mi)} = 0.35 \times \text{FTP} + 0.28 \times \text{US06} + 0.37 \times \text{SC03}$$

(A) For test vehicles that do not have air conditioning, you may omit SC03 testing. To calculate composite SFTP emissions for such vehicles, use FTP emission results to substitute for the SC03 value in the equation.

(B) You may also use FTP emission results to substitute for the SC03 value in the equation for the types of vehicles identified in 40 CFR 600.115 that automatically qualify for the derived 5-cycle method for determining fuel economy label values. Such vehicles remain subject to the SFTP standard when tested over the SC03 driving schedule. Other vehicles remain subject to the litmus-test provisions in 40 CFR 600.115.

(iv) Use E10 test fuel as required in § 86.113, except as specified in this section.

(v) Hydrocarbon emission standards are expressed as NMOG; however, for certain vehicles you may measure exhaust emissions based on nonmethane hydrocarbon instead of NMOG as described in 40 CFR 1066.635.

(vi) Measure emissions from hybrid electric vehicles (including plug-in hybrid electric vehicles) as described in 40 CFR part 1066, subpart F, except that these procedures do not apply for plug-in hybrid electric vehicles during charge-depleting operation.

(2) Table 1 of this section describes fully phased-in Tier 3 standards that apply as specified in this paragraph (b) for the identified driving schedules. The FTP standards for NMOG+NO<sub>x</sub> apply on a fleet-average basis using discrete bin standards as described in paragraph (b)(4) of this section. The bin standards include additional emission standards for high-altitude testing and for CO emissions when testing over the FTP driving schedule. The SFTP standards for NMOG+NO<sub>x</sub> apply on a fleet-average basis as described in paragraph (b)(5) of this section. Table 1 follows:

TABLE 1 OF § 86.1811–17—FULLY PHASED-IN TIER 3 EXHAUST EMISSION STANDARDS  
[g/mile]

NMOG+NO <sub>x</sub>		PM		CO	Formaldehyde
FTP <sup>1</sup>	SFTP	FTP	US06	SFTP	FTP
0.030	0.050	0.003	0.006	4.2	0.004

<sup>1</sup> The fleet-average FTP emission standard for NMOG+NO<sub>x</sub> is 0.026 g/mile for any LDV or LDT1 test group certified to standards based on a useful life of 120,000 miles or 10 years in a given model year.

(3) The FTP standards specified in this section apply for testing at low-altitude conditions and high-altitude conditions as specified in paragraph (b)(4) of this section. The SFTP standards specified in paragraph (b)(2) of this section apply only for testing at low-altitude conditions.

(4) The FTP emission standard for NMOG+NO<sub>x</sub> is based on a fleet average for a given model year. You must specify a family emission limit (FEL) for each test group. The FEL serves as the emission standard for the test group with respect to all required FTP testing. Calculate your fleet-average emission level as described in § 86.1860 based on

the FEL that applies for low-altitude testing to show that you meet the specified standard. For multi-fueled vehicles, calculate fleet-average emission levels based only on emission levels for testing with gasoline or diesel fuel. You may generate emission credits for banking and trading and you may use banked or traded credits as described in § 86.1861 for demonstrating compliance with the FTP emission standard for NMOG+NO<sub>x</sub>. You comply with the emission standard for a given model year if you have enough credits to show that your fleet-average emission level is at or below the

applicable standard. You may exchange FTP credits between or among any test groups subject to standards under this section. You may not exchange FTP and SFTP credits.

(i) Specify one of the identified values from Table 2 of this section as the FEL for demonstrating that your fleet-average emission level complies with the FTP emission standard for NMOG+NO<sub>x</sub> under low-altitude conditions. These FEL values define emission bins that also determine corresponding emission standards for NMOG+NO<sub>x</sub> emissions under high-altitude conditions, and for CO emissions, as follows:

TABLE 2 OF § 86.1811–17—TIER 3 FTP BIN STANDARDS  
[g/mile]

FEL Name	NMOG+NO <sub>x</sub> FELs for low altitude	NMOG+NO <sub>x</sub> for high altitude	CO for low and high altitude
Bin 160 .....	0.160	0.160	4.2
Bin 125 .....	0.125	0.160	2.1
Bin 70 .....	0.070	0.105	1.7
Bin 50 .....	0.050	0.070	1.7
Bin 30 .....	0.030	0.050	1.0
Bin 20 .....	0.020	0.030	1.0
Bin 0 .....	0.000	0.000	0.0

(ii) Manufacturers earn a compliance credit of 0.005 g/mile NMOG+NO<sub>x</sub> for vehicles that are certified for a useful life of 150,000 miles or 15 years and that are covered by an extended warranty over the same period for all components whose failure triggers MIL illumination. Manufacturers may apply the compliance credit as follows:

(A) You may reduce your official FTP emission result for certification by the amount of the compliance credit if that allows you to certify to a more stringent bin. In that case, you may use the more stringent bin standard for calculating the fleet-average NMOG+NO<sub>x</sub> emission level. For any compliance testing with these vehicles, the applicable FTP bin standard for NMOG+NO<sub>x</sub> is higher than the specified bin standard by the amount of the compliance credit. For example, if the official FTP emission result for NMOG+NO<sub>x</sub> is 0.052 g/mile, this qualifies for an FEL of 0.050 g/mile

for calculating the fleet average and the vehicle is subject to an FTP bin standard of 0.055 g/mile.

(B) If the amount of the compliance credit does not allow you to certify to a more stringent bin, calculate the fleet-average NMOG+NO<sub>x</sub> emission level using an FEL for these vehicles that is smaller than the bin standard by the amount of the compliance credit. For any compliance testing with these vehicles, the specified bin standard applies. For example, if the official FTP emission result for NMOG+NO<sub>x</sub> is 0.038 g/mile, calculate the fleet-average NMOG+NO<sub>x</sub> emission level by specifying an FEL of 0.045 g/mile; these vehicles are subject to the specified FTP bin standard of 0.050 g/mile.

(iii) If you qualify for a compliance credit for direct ozone reduction under the LEV III program, you may apply the compliance credit approved for California vehicles as described in

paragraphs (b)(4)(ii)(A) and (B) of this section.

(iv) You may combine the adjustments in paragraphs (b)(4)(ii) and (iii) of this section if you qualify for them separately.

(5) The SFTP emission standard for NMOG+NO<sub>x</sub> is also based on a fleet average in a given model year. You must specify FELs as described in paragraph (b)(4) of this section and calculate a fleet-average emission level to show that you meet the SFTP emission standard for NMOG+NO<sub>x</sub>, except that you may specify FELs in any even increment of 0.010 g/mile up to a maximum value of 0.180 g/mile. You may generate emission credits for banking and trading and you may use banked or traded credits as described in § 86.1861 for demonstrating compliance with the SFTP emission standard for NMOG+NO<sub>x</sub>. You comply with the emission standard for a given model

year if you have enough credits to show that your fleet-average emission level is at or below the applicable standard. You may exchange SFTP credits between or among any test groups subject to standards under this section. You may not exchange FTP and SFTP credits. The SFTP standards described in this section apply only for testing at low-altitude conditions.

(6) The full Tier 3 program includes new emission standards for NMOG+NO<sub>x</sub>, PM, CO, and formaldehyde; it also includes measurement with a new test fuel and a longer useful life (for some vehicles). Vehicles meeting all these requirements are considered Final Tier 3 vehicles. Vehicles that do not meet all the Tier 3 requirements are considered Interim Tier 3 vehicles. Paragraphs (b)(7) through (13) of this section describe how to comply with standards during a phase-in period.

(7) The Tier 3 PM standards phase in over several years. The following provisions describe the primary approach for phasing in the Tier 3 PM standards:

(i) You must meet the FTP and the US06 PM standards with 20, 20, 40, 70, and 100 percent of your projected nationwide sales of all vehicles subject to this section in model years 2017 through 2021, respectively. In model years 2017 and 2018, an interim US06 PM standard of 0.010 g/mile applies. Each vehicle meeting the Tier 3 FTP standard for PM must also meet the Tier 3 US06 standard for PM. In model year 2017, the phase-in requirement applies only for vehicles at or below 6,000 pounds GVWR; however, you may meet an alternative phase-in requirement of 10 percent in model year 2017 based on your full production of vehicles subject to standards under this section.

(ii) You may disregard the phase-in percentages specified in paragraph (b)(7)(i) of this section if you instead comply with an indexed PM phase-in schedule as described in this paragraph (b)(7)(ii). To do this, you must notify us of your intent before January 1, 2017, and include a detailed plan for complying with the indexed phase-in schedule. You comply with the indexed phase-in schedule by calculating a PM phase-in index at or above 540 using the following equation for model years 2017 through 2021:

$$\text{PM phase-in index} = 5 \cdot \text{APP}_{2017} + 4 \cdot \text{APP}_{2018} + 3 \cdot \text{APP}_{2019} + 2 \cdot \text{APP}_{2020} + \text{APP}_{2021}$$

Where:

APP = The phase-in percentage of vehicles meeting the Tier 3 PM standards for the indicated model year, based on actual

sales, as described in paragraph (b)(7)(i) of this section.

(iii) Vehicles meeting the Tier 3 PM standards must meet those standards over the useful life as specified in § 86.1805. Note that Interim Tier 3 vehicles may have different useful life values for PM emission standards than for other emission standards.

(iv) Any vehicles not included for demonstrating compliance with the Tier 3 PM phase-in requirement must instead comply with an FTP emission standard for PM of 0.010 g/mile, and a composite SFTP emission standard for PM of 0.070 g/mile.

(v) Measure PM emissions from all vehicles using the same test fuel specified in paragraph (b)(8) of this section for measuring NMOG+NO<sub>x</sub> emissions.

(vi) You may certify Interim Tier 3 vehicles based on carryover data.

(vii) You may use the alternative phase-in provisions described in paragraph (b)(9) of this section to transition to the Tier 3 exhaust emission standards on a different schedule.

(8) The following provisions describe the primary approach for phasing in the Tier 3 standards other than PM in 2025 and earlier model years:

(i) *FTP phase-in.* The fleet-average FTP emission standard for NMOG+NO<sub>x</sub> phases in over several years as described in this paragraph (b)(8)(i). You must identify FELs as described in paragraph (b)(4) of this section and calculate a fleet-average emission level to show that you meet the FTP emission standard for NMOG+NO<sub>x</sub> that applies for each model year. For model year 2017, do not include vehicles above 6,000 pounds GVWR. Through model year 2019, you may also certify to transitional Bin 85 or Bin 110 standards, which consist of all-altitude FTP emission standards for NMOG+NO<sub>x</sub> of 0.085 or 0.110 g/mile, respectively; additional FTP standards for PM, CO, and formaldehyde apply as specified in this section for vehicles certified to Bin 125 standards. Fleet-average FTP emission standards decrease through the phase-in period as shown in the following table:

TABLE 3 OF § 86.1811–17—DECLINING FLEET-AVERAGE TIER 3 FTP EMISSION STANDARDS FOR NMOG+NO<sub>x</sub>

Model year	LDV, LDT1 <sup>1</sup>	LDT2, HLDT
2017 <sup>2</sup> .....	0.086	0.101
2018 .....	0.079	0.092
2019 .....	0.072	0.083
2020 .....	0.065	0.074

TABLE 3 OF § 86.1811–17—DECLINING FLEET-AVERAGE TIER 3 FTP EMISSION STANDARDS FOR NMOG+NO<sub>x</sub>—Continued

Model year	LDV, LDT1 <sup>1</sup>	LDT2, HLDT
2021 .....	0.058	0.065
2022 .....	0.051	0.056
2023 .....	0.044	0.047
2024 .....	0.037	0.038
2025 .....	0.030	0.030

<sup>1</sup> Calculate the adjusted fleet-average standard for LDV and LDT1 test groups certified to standards based on a useful life of 120,000 miles or 10 years in a given model year by multiplying the specified value by 0.85 and rounding to the nearest 0.001 g/mile. Through model year 2019, apply this adjustment only if one or more test groups is certified to Bin 70 or lower standards based on a useful life of 120,000 miles or 10 years.

<sup>2</sup> Vehicles above 6,000 pounds GVWR must meet the Tier 3 standards starting with model year 2018.

(ii) *SFTP phase-in.* The fleet-average SFTP emission standard for NMOG+NO<sub>x</sub> phases in over several years as described in this paragraph (b)(8)(ii). You must identify FELs as described in paragraph (b)(5) of this section and calculate a fleet-average emission level to show that you meet the SFTP emission standard for NMOG+NO<sub>x</sub> that applies for each model year.

(A) Calculate the fleet-average emission level together for all your light-duty vehicles and light-duty trucks, except for those certified using the provisions of paragraph (b)(8)(ii)(C) of this section. For model year 2017, do not include vehicles above 6,000 pounds GVWR (in the numerator or denominator).

(B) Fleet-average FTP emission standards decrease through the phase-in period as shown in the following table:

TABLE 4 OF § 86.1811–17—DECLINING FLEET-AVERAGE TIER 3 SFTP EMISSION STANDARDS

Model year	NMOG+NO <sub>x</sub> (g/mile)
2017 <sup>1</sup> .....	0.103
2018 .....	0.097
2019 .....	0.090
2020 .....	0.083
2021 .....	0.077
2022 .....	0.070
2023 .....	0.063
2024 .....	0.057
2025 .....	0.050

<sup>1</sup> Vehicles above 6,000 pounds GVWR must meet the Tier 3 standards starting with model year 2018.

(C) You may use the Option 1 provisions specified in the LEV III

program to demonstrate compliance with EPA's SFTP standards. Do not include any such test groups when demonstrating compliance with the phased-in fleet-average SFTP standards specified in this paragraph (b)(8)(ii). Note that this option is not available for vehicles certified to the transitional bins described in paragraph (b)(8)(i) of this section.

(iii) *Interim provisions.* (A) For LDT2 and HLDT certified to bins higher than Bin 70 under this section through model year 2019, the Tier 2 useful life period applies as specified in § 86.1805–12 for all criteria pollutants other than PM. A similar provisions applies for LDV and LDT1, as described in Table 3 of this section.

(B) You may use the E0 test fuel specified in § 86.113 through model year 2019 for gasoline-fueled vehicles certified to bins higher than Bin 70. You may not certify these vehicles using carryover data after model year 2019.

(iv) You may use the alternative phase-in provisions described in paragraph (b)(9) of this section to transition to the Tier 3 exhaust emission standards on a different schedule.

(9) This paragraph (b)(9) describes an alternative approach to phasing in the Tier 3 emission standards for vehicles above 6,000 pounds GVWR. If you choose this approach, you must phase in the Tier 3 standards for all your vehicles above 6,000 pounds GVWR that are subject to this section according to this schedule. Under this alternative phase-in, you must meet the fully phased-in standards specified in this paragraph (b) with 40, 70, and 100 percent of your projected nationwide sales of all vehicles above 6,000 pounds GVWR that are subject to this section in model years 2019 through 2021, respectively. Any vehicles not subject to Tier 3 standards during the phase-in period must continue to comply with the Tier 2 standards in § 86.1811–04(c) and (f), including the Tier 2 SFTP emission standards for NMHC+NO<sub>x</sub> and CO for 4,000-mile testing as specified in § 86.1811–04(f)(1). Vehicles subject to Tier 2 standards under this paragraph (b)(9) are subject to the useful life provisions in § 86.1805–12 relative to exhaust emission standards. Each vehicle counting toward the phase-in percentage under this paragraph (b)(9) must meet all the standards that apply throughout the useful life as specified in § 86.1805–17, and must use the Tier 3 test fuel specified in § 86.113–07. The following exceptions and special provisions apply under this paragraph (b)(9):

(i) For model year 2019, you may exclude from the phase-in calculation

any test groups with vehicles above 6,000 pounds GVWR that have a Job 1 date on or before March 3, 2018 (see 40 CFR 85.2304).

(ii) The FTP and SFTP emission standards for NMOG+NO<sub>x</sub> are fleet-average standards. Calculate your fleet-average values based on all the vehicles that are subject to the standard in a given year. You may not generate credits for banking or trading in model years 2019 or 2020, and you may not use banked or traded credits to demonstrate compliance with the standards in those years.

(iii) The US06 emission standard for PM is 0.010 g/mile in model years 2019 through 2021, and 0.006 g/mile starting in model year 2022. The other standards described in this paragraph (b)(9) apply to all your vehicles above 6,000 pounds GVWR in model years 2022 through 2024.

(10) You may not use credits generated from Tier 2 vehicles for demonstrating compliance with the Tier 3 standards except as specified in this paragraph (b)(10). You may generate early credits with U.S. sales of Tier 2 vehicles in the two model years before the Tier 3 standards start to apply for a given vehicle model. Vehicles certified to the Tier 2 standards must meet all the Tier 2 requirements in § 86.1811–10, including the fleet-average Tier 2 standards. Calculate early Tier 3 emission credits as described in § 86.1861 by subtracting the appropriate Tier 2 fleet-average value for FTP emissions of NMOG+NO<sub>x</sub> from 0.160 g/mile. Calculate your fleet-average value for the model year based on vehicles at or below 6,000 pounds GVWR in 2015, on all sizes of vehicles in 2016, and on vehicles above 6,000 pounds GVWR in 2017. You may use these early credits as described in § 86.1861 for demonstrating compliance with the FTP emission standard for NMOG+NO<sub>x</sub> starting in model year 2017. For model years 2018 and later, you may use these early credits for banking or trading subject to a limitation based on credits generated in California, as follows:

(i) For the applicable model years in which you generate emission credits relative to California's LEV III fleet-average NMOG+NO<sub>x</sub> standard, determine the actual California sales of light-duty vehicles and light-duty trucks and the actual nationwide sales of those same vehicles. In 2015, count sales only from vehicle models at or below 6,000 pounds GVWR. For each model year, multiply the credits generated under the California program by the ratio of nationwide vehicle sales to LEV III vehicle sales to calculate an effective nationwide quantity. Sum these results

for model years 2015 through 2017. Note that this calculation results in a maximum credit quantity based on vehicle sales in all states, even though the initial credit calculation does not include vehicle sales in California or the section 177 states. If you comply with the LEV III standards based on pooled emission credits for California and the section 177 states, use those pooled emission credits and corresponding sales for calculating the maximum credit quantity under this paragraph (b)(10)(i).

(ii) You may not use more early credits generated under this paragraph (b)(10) for banking or trading to demonstrate compliance with Tier 3 emission standards than the calculated value of the effective nationwide credit quantity summed in paragraph (b)(10)(i) of this section. If your generated credits are greater than this threshold, determine the percentage of your generated early credits that exceed the threshold. Calculate an adjusted quantity of early credits generated under this paragraph (b)(10) by decreasing the generated quantity from each model year by the calculated percentage that exceed the applicable threshold. This adjusted quantity of credits may be used for banking or trading relative to the Tier 3 standards, subject to the five-year credit life described in § 86.1861.

(11) You may certify vehicles to the Tier 3 standards starting in model year 2015. To do this, you may either sell all your LEV III vehicles models nationwide, or you may certify a subset of your fleet to alternate fleet-average emission standards as follows:

(i) The alternate fleet-average FTP emission standards for NMOG+NO<sub>x</sub> are 0.100 g/mile in 2015 and 0.093 g/mile in 2016 for LDV and LDT1.

(ii) The alternate fleet-average FTP emission standards for NMOG+NO<sub>x</sub> are 0.119 g/mile in 2015, 0.110 g/mile in 2016, and 0.101 g/mile in 2017 for LDT2 and HLDT.

(iii) The alternate fleet-average SFTP emission standards for NMOG+NO<sub>x</sub> are 0.140 in 2015 for LDV and LDT1, 0.110 in 2016 for all vehicles, and 0.103 in 2017 for LDT2 and HLDT.

(iv) The vehicles must meet FTP and SFTP standards for PM as specified in § 86.1811–04. The PM testing provisions of § 86.1829–01(b)(1)(iii)(B) apply for these vehicles.

(v) Vehicles not certified to the Tier 3 standards in a given model year must meet all the requirements that apply for Tier 2 vehicles in that model year.

(vi) For cold temperature testing and for high-altitude testing, you may use the E0 fuel specified in § 86.113–04(a)

or § 86.213 instead of the E10 test fuel specified in § 86.113–07.

(vii) For vehicles certified under this paragraph (b)(11), you may generate emission credits and use those credits for demonstrating compliance with Tier 3 standards as described in paragraph (b)(10) of this section.

(12) The following alternate standards apply for in-use testing:

(i) Alternate in-use FTP standards for NMOG+NO<sub>x</sub> apply for 2021 and earlier model year vehicles certified to Bin 70 and lower. Calculate these alternate standards by multiplying the applicable FEL by 1.4. These alternate standards apply only for testing at low-altitude conditions.

(ii) The alternate in-use FTP standard for PM is 0.006 g/mile for 2021 and earlier model year vehicles.

(iii) The in-use US06 standard for PM is 0.010 g/mile for 2023 and earlier model year vehicles.

(13) Keep records as needed to show that you meet the requirements specified in this paragraph (b) for phasing in standards and for complying with declining fleet-average average standards.

(c) *Highway NMOG+NO<sub>x</sub> exhaust emission standard.* NMOG+NO<sub>x</sub> emissions measured on the federal Highway Fuel Economy Test in 40 CFR part 600, subpart B, may not exceed the applicable FTP bin standard for NMOG+NO<sub>x</sub>. Demonstrate compliance with this standard for low-mileage vehicles by applying the appropriate deterioration factor. For vehicles not certified to any Tier 3 emission standards specified in paragraph (b) of this section, the provisions of § 86.1811–04(j) apply instead of this paragraph (c).

(d) *Special provisions for Otto-cycle engines.* The special provisions described in this paragraph (d) apply for vehicles with Otto-cycle engines. For vehicles not certified to any Tier 3 emission standards, the provisions of § 86.1810–01(i)(6), (i)(13), and (i)(14) apply instead of this paragraph (d).

(1) *Enrichment limits.* The nominal air-fuel ratio throughout the US06 cycle may not be richer than the leanest air-fuel mixture required for lean best torque, except as allowed under paragraph (d)(2) of this section. Unless we approve otherwise in advance, lean best torque is the leanest air-fuel ratio required at any speed and load point with a fixed spark advance to make peak torque. The allowable tolerance around

the nominal value for any given speed and load point over the US06 cycle for a particular vehicle is 4 percent, which is calculated as the nominal mass-based air-fuel ratio for lean best torque divided by 1.04.

(2) *Engine protection.* AECs that use commanded enrichment to protect the engine or emission control hardware must not use enrichment more frequently or to a greater degree than is needed for this purpose. For purposes of this section, commanded enrichment includes intended engine operation at air-fuel ratios rich of stoichiometry, except the following:

(i) Cycling back and forth in a narrow window between rich and lean operation as a result of feedback controls targeted to maintain overall engine operation at stoichiometry.

(ii) Small changes in the target air-fuel ratio to optimize vehicle emissions or drivability. This may be called “closed-loop biasing.”

(iii) Temporary enrichment in response to rapid throttle motion.

(iv) Enrichment during cold-start and warm-up conditions.

(v) Temporary enrichment for running OBD checks to comply with § 86.1806.

(3) *A/C-on specific calibrations.* (i) A/C-on specific calibrations (e.g., air-fuel ratio, spark timing, and exhaust gas recirculation) that differ from A/C-off calibrations may be used for a given set of engine operating conditions (e.g., engine speed, manifold pressure, coolant temperature, air charge temperature, and any other parameters). Such calibrations must not unnecessarily reduce emission control effectiveness during A/C-on operation when the vehicle is operated under conditions that may reasonably be expected during normal operation and use. If emission control effectiveness decreases as a result of such calibrations, the manufacturer must describe in the Application for Certification the circumstances under which this occurs and the reason for using these calibrations.

(ii) For AECs involving commanded enrichment, these AECs must not operate differently for A/C-on operation than for A/C-off operation, except as provided under paragraph (d)(2) of this section. This includes both the sensor inputs for triggering enrichment and the degree of enrichment employed.

(4) *“Lean-on-cruise” calibration strategies.* Manufacturers may use “lean-on-cruise” strategies subject to the following specifications:

(i) A “lean-on-cruise” strategy is defined as the use of an air-fuel ratio significantly leaner than stoichiometry during non-deceleration conditions at speeds above 40 mph.

(ii) You must not employ “lean-on-cruise” strategies during vehicle operation in normal driving conditions, including A/C usage, unless at least one of the following conditions is met:

(A) Such strategies are substantially employed during the FTP, US06, or SC03 duty cycle.

(B) Such strategies are demonstrated not to significantly reduce vehicle emission control effectiveness over the operating conditions in which they are employed.

(C) Such strategies are demonstrated to be necessary to protect the vehicle occupants, engine, or emission control hardware.

(iii) If you propose to use a “lean-on-cruise” strategy, you must describe in the application for certification the circumstances under which such a calibration would be used and the reasons for using it.

(e) through (f) [Reserved]

(g) *Cold temperature exhaust emission standards.* The following standards apply for vehicles tested over the test procedures specified in subpart C of this part:

(1) *Cold temperature CO standards.* These cold temperature CO standards are applicable only to gasoline-fueled vehicles. These standards apply for testing at low-altitude conditions and high-altitude conditions. Cold temperature CO exhaust emission standards apply when measured using the test procedures specified in subpart C of this part, as follows:

(i) For LDV and LDT1, the standard is 10.0 g/mile CO.

(ii) For LDT2, LDT3 and LDT4, the standard is 12.5 grams per mile CO.

(2) *Cold temperature NMHC standards.* Fleet average cold temperature NMHC standards are applicable only to gasoline-fueled vehicles, and apply equally to certification and in-use except as otherwise specified in § 86.1811–10(u) for in-use standards for applicable phase-in models. Testing with other fuels such as a high-level ethanol-gasoline blend, or testing on diesel vehicles, is not required. Multi-fuel, bi-fuel or dual-fuel vehicles must comply with requirements using gasoline only.

(i) The standards are shown in the following table:

**TABLE 5 OF § 86.1811–17—FLEET AVERAGE COLD TEMPERATURE NMHC EXHAUST EMISSION STANDARDS**

Vehicle weight category	Cold temperature NMHC sales-weighted fleet average standard (g/mile)
LDV and LLDT .....	0.3
HLDT .....	0.5

(ii) The manufacturer must calculate its fleet average cold temperature NMHC emission level(s) as described in § 86.1864–10(m).

(iii) The standards specified in this paragraph (g)(2) apply only for testing at low-altitude conditions. However, manufacturers must submit an engineering evaluation indicating that common calibration approaches are utilized at high altitudes. Any deviation from low altitude emission control practices must be included in the auxiliary emission control device (AECD) descriptions submitted at certification. Any AECD specific to high altitude must require engineering emission data for EPA evaluation to quantify any emission impact and validity of the AECD.

(h) *Small-volume manufacturers.* Small-volume manufacturers may use the following Tier 3 phase-in provisions:

(1) Instead of the fleet-average FTP standards for NMOG+NO<sub>x</sub> specified in this section, small-volume manufacturers may meet alternate fleet-average standards of 0.125 g/mile through model year 2021, and 0.051 g/mile for model years 2022 through 2027. The following additional provisions apply for vehicles certified under this paragraph (h)(1):

(i) Vehicles are subject to exhaust emission standards over the useful life as specified in § 86.1805–12 through model year 2021, and as specified in this section starting in model year 2022.

(ii) Gasoline-fueled vehicles may use the E0 test fuel specified in § 86.113–04 for vehicles certified to bins higher than Bin 70 through model year 2021.

(iii) Vehicles certified under this paragraph (h)(1) may generate emission credits and they may use banked or traded emission credits relative to the alternate fleet-average FTP standard for NMOG+NO<sub>x</sub> only in model years 2022 through 2027.

(iv) Vehicles are subject to all the other requirements specified in this section.

(2) Small-volume manufacturers may delay complying with all the requirements of this section until model year 2022, and instead meet all the requirements that apply to Tier 2 vehicles under § 86.1811–10 for 2021 and earlier model years.

(3) If meeting the Tier 3 standards would cause severe economic hardship, small-volume manufacturers may ask us to approve an extended compliance deadline under the provisions of 40 CFR 1068.250, except that the solvency criterion does not apply and there is no maximum duration of the hardship relief.

**§§ 86.1812–01 and 86.1813–01 [Removed]**

■ 179. Remove §§ 86.1812–01 and 86.1813–01.

■ 180. A new § 86.1813–17 is added to subpart S to read as follows:

**§ 86.1813–17 Evaporative and refueling emission standards.**

Vehicles must meet evaporative and refueling emission standards as specified in this section. These standards apply for heavy duty vehicles above 14,000 pounds GVWR as specified in § 86.1801. The emission standards apply for total hydrocarbon equivalent (THCE) measurements using the test procedures specified in subpart B of this part, as appropriate. Note that § 86.1829 allows you to certify without testing in certain circumstances. Except as specified in paragraph (b) of this section, evaporative and refueling emission standards do not apply for diesel-fueled vehicles. Unless otherwise specified, MDPVs are subject to all the same provisions of this section that apply to LDT4.

(a) *Tier 3 evaporative emission standards.* Vehicles may not exceed the Tier 3 evaporative emission standards, as follows:

(1) Measure emissions using the test procedures of subpart B of this part, as follows:

(i) Follow the vehicle preconditioning and exhaust testing procedures as described in subpart B of this part.

(ii) Measure diurnal, running loss, and hot soak emissions as shown in § 86.130. This includes separate measurements for the two-diurnal test sequence and the three-diurnal test sequence; however, gaseous-fueled vehicles are not subject to evaporative emission standards using the two-diurnal test sequence.

(iii) For gasoline-fueled vehicles, use E10 test fuel as required in § 86.113, except as specified in this section.

(iv) Emissions are generally measured with a flame ionization detector (FID).

In the case of diurnal, hot soak, and running loss testing with E10 test fuel, multiply measured (unspeciated) FID values by 1.08 to account for the FID's reduced response to ethanol. You may instead determine total hydrocarbon equivalent for E10 testing based on speciated measurements as described in § 86.143–96(c). You must use the same method (with or without speciation) for all of the specified evaporative testing for a given evaporative/refueling family. Similarly, any evaporative/refueling families certified in later model years using carryover data must use the same method that was used for the original testing. We may do testing with or without speciation, but we will apply the 1.08 correction factor to unspeciated measurements only if you also use it to determine your final test results.

(2) Diurnal and hot soak emissions may not exceed the Tier 3 emission standards, as follows:

(i) The emission standard for the sum of diurnal and hot soak measurements from the two- diurnal test sequence and the three- diurnal test sequence is based on a fleet average in a given model year. You must specify a family emission limit (FEL) for each evaporative family. The FEL serves as the emission standard for the evaporative family with respect to all required diurnal and hot soak testing. Calculate your fleet average emission level as described in § 86.1860 based on the FEL that applies for low-altitude testing to show that you meet the specified standard. For multi-fueled vehicles, calculate fleet-average emission levels based only on emission levels for testing with gasoline. You may generate emission credits for banking and trading and you may use banked or traded credits for demonstrating compliance with the diurnal plus hot soak emission standard for vehicles required to meet the Tier 3 standards, other than electric vehicles and gaseous-fueled vehicles, as described in § 86.1861 starting in model year 2017. You comply with the emission standard for a given model year if you have enough credits to show that your fleet-average emission level is at or below the applicable standard. You may exchange credits between or among evaporative families within an averaging set as described in § 86.1861. Separate diurnal plus hot soak emission standards apply as shown for high-altitude conditions. The sum of diurnal and hot soak measurements may not exceed the following fleet-average Tier 3 standards:



TABLE 1 OF § 86.1813–17—TIER 3 DIURNAL PLUS HOT SOAK EMISSION STANDARDS (GRAMS PER TEST)

Vehicle category	Low-altitude conditions	High-altitude conditions
LDV, LDT1 .....	0.300	0.65
LDT2 .....	0.400	0.85
HLDT .....	0.500	1.15 <sup>1</sup>
HDV .....	0.600	1.75

<sup>1</sup> 1.25 g/test for MDPVs.

(ii) Specify FELs as follows:

(A) You may specify the low-altitude FEL in increments of 0.025 g above or below the otherwise applicable Tier 3 diurnal plus hot soak standard, up to the maximum values specified in the following table:

TABLE 2 OF § 86.1813–17—TIER 3 FEL CAPS FOR LOW-ALTITUDE TESTING

Vehicle category	FEL Caps
LDV .....	0.500
LLDT .....	0.650
HLDT .....	0.900
MDPV .....	1.000
HDV .....	1.4

(B) Calculate the FEL for testing at high-altitude conditions based on the difference between the low-altitude FEL and the standard. For example, if a light-duty vehicle was certified with an FEL of 0.400 g instead of the 0.300 g standard, the FEL for testing under high-altitude conditions would be 0.75 g (0.65+0.10).

(iii) Hydrocarbon emissions must not exceed 0.020 g for LDV and LDT and 0.030 g for HDV when tested using the Bleed Emission Test Procedure adopted by the California Air Resources Board as part of the LEV III program. This procedure quantifies diurnal emissions without measuring hot soak emissions. The standards in this paragraph (a)(2)(iii) do not apply for testing at high-altitude conditions. For vehicles with non-integrated refueling canisters, the bleed emission test and standard do not apply to the refueling canister. You may perform the Bleed Emission Test Procedure using the analogous test temperatures and the E10 test fuel specified in subpart B of this part.

(3) Running losses may not exceed 0.05 g per mile when measured using the test procedures specified in § 86.134. This standard does not apply for gaseous-fueled vehicles.

(4) Fuel systems for vehicles operating on one or more volatile liquid fuels may not exceed an effective leak diameter of 0.02 inches when measured using the procedure specified in 40 CFR 1066.985.

For vehicles with fuel tanks exceeding 25 gallons nominal fuel tank capacity, you may request our approval for a leak standard greater than 0.020 inches, up to a maximum value of 0.040 inches.

(5) The Tier 3 evaporative emission standards start to phase in with model year 2017 for vehicles at or below 6,000 pounds GVWR and with model year 2018 for vehicles above 6,000 pounds GVWR. Table 3 of this section specifies the minimum percentage of each manufacturer's sales in each model year that must be certified to the Tier 3 evaporative emission standards. Calculate annual percentages based on actual nationwide sales of all vehicles subject to standards under this paragraph (a) for the applicable model year; however, if all your FELs for Tier 3 evaporative families are at the applicable standard (neither generating nor using emission credits), the phase-in requirements are based on projected sales. Also, if you certify vehicles above 6,000 pounds GVWR to the Tier 3 evaporative emission standards in model year 2017, you may count projected U.S. sales of those vehicles toward your calculation for meeting the 40 percent requirement in 2017 (numerator only). Manufacturers may meet this requirement using the additional alternative phase-in provisions in paragraph (g) of this section. Vehicles from the identified model years not certified to the Tier 3 evaporative emission standards continue to be subject to the evaporative emission standards specified in § 86.1811–09(e) or § 86.1816–08(d), including the useful life provisions of § 86.1805–12. Note that this subjects LDV and LDT1 to a 150,000 mile useful life for evaporative emissions if the vehicles are subject to a 150,000 mile useful life for exhaust emissions. Keep records as needed to show that you meet the phase-in requirements specified in this section. See paragraph (g) of this section for additional provisions that apply for model year 2017 and the rest of the phase-in.

TABLE 3 OF § 86.1813–17—DEFAULT PHASE-IN SCHEDULE FOR TIER 3 EVAPORATIVE EMISSION STANDARDS

Model year	Minimum percentage of vehicles subject to the Tier 3 standards
2017 .....	1,2 40
2018 .....	60
2019 .....	60
2020 .....	80
2021 .....	80

TABLE 3 OF § 86.1813–17—DEFAULT PHASE-IN SCHEDULE FOR TIER 3 EVAPORATIVE EMISSION STANDARDS—Continued

Model year	Minimum percentage of vehicles subject to the Tier 3 standards
2022 .....	100

<sup>1</sup> The phase-in percentage for model year 2017 applies only for vehicles at or below 6,000 pounds GVWR.

<sup>2</sup> The leak standard specified in paragraph (a)(4) of this section does not apply for model year 2017.

(6) For model year 2017, exclude vehicle sales from California and section 177 states from the calculation to demonstrate compliance with the phase-in schedule in paragraph (a)(5) or (g) of this section, and from the credit calculation in § 86.1860.

(b) *Refueling emissions.* Light-duty vehicles, light-duty trucks, and complete heavy-duty vehicles must meet the refueling emission standards in this paragraph (b) when measured over the procedure specified in § 86.150. These standards apply starting with model year 2018 for vehicles above 10,000 pounds GVWR. The following refueling standards apply:

(1) 0.20 g THCE per gallon of fuel dispensed for vehicles using volatile liquid fuels. This standard also applies for diesel-fueled LDV.

(2) 0.15 g THC per gallon of fuel dispensed for liquefied petroleum gas-fueled vehicles and natural gas-fueled vehicles.

(c) *Fuel spitback.* For vehicles fueled by volatile liquid fuels, fuel spitback emissions may not exceed 1.0 g THCE when measured using the test procedures specified in § 86.146. The fuel spitback standard applies only to newly assembled vehicles.

(d) [Reserved]

(e) *Auxiliary engines and separate fuel systems.* The provisions of 40 CFR 1037.103(g) apply for vehicles with auxiliary engines. This includes any engines installed in the final vehicle configuration that contribute no motive power through the vehicle's transmission.

(f) *Refueling provisions for gaseous-fueled vehicles.* The following provisions apply specifically for gaseous-fueled vehicles:

(1) Compressed natural gas vehicles must meet the requirements for fueling connection devices as specified in ANSI NGV1–2006 (incorporated by reference in § 86.1).

(2) [Reserved]

(3) With our advance approval, liquefied petroleum gas-fueled vehicles with gauges or valves that can be opened to release fuel or fuel vapor during refueling (such as fixed liquid level gauges) may be tested for refueling emissions without opening such gauges or valves, as outlined in § 86.157–98(d)(2). We will approve your request if you can show that such gauges or valves will not be open during in-use refueling due to inaccessibility or other design features that would prevent them from opening or make this very unlikely.

(g) *Alternative phase-in options for Tier 3 evaporative emission standards.* You may use any of the following alternative methods to transition to the Tier 3 evaporative emission standards:

(1) Starting in model year 2015, you may earn an “allowance” for each vehicle that you certify early under this paragraph (g)(1). For each allowance you earn, you may count it as one compliant vehicle in a later model year during the phase-in period. Calculate the total phase-in percentage in each model year by adding the allowances to the number of compliant vehicles (in the numerator), without increasing total sales (in the denominator). For each allowance you earn, you may alternatively count it as one compliant vehicle under the phase-in schedule described in paragraph (g)(5) of this section, except that you may not use those allowances to increase the value of the phase-in index from any model year by more than 10 percentage points. Vehicles earning allowances under this paragraph (g)(1) may not have an FEL above the applicable Tier 3 standard, and may not generate emission credits for banking or trading. Allowances may not be traded to another company. You may earn allowances under this paragraph (g)(1) for early-compliant vehicles as follows:

(i) Model year 2015 and 2016 vehicles at or below 6,000 pounds GVWR meeting the Tier 3 standards in paragraph (a) of this section or the equivalent California standards as specified in paragraph (g)(4) of this section earn allowances, as long as the vehicles are not sold in California or any of the section 177 states.

(ii) Model year 2015 through 2017 LDV and LDT above 6,000 pounds GVWR meeting the Tier 3 standards in paragraph (a) of this section or the equivalent California standards as specified in paragraph (g)(4) of this section earn allowances, as long as the vehicles are not sold in California or any of the section 177 states.

(iii) Model year 2015 through 2017 MDPV and HDV meeting the Tier 3

standards in paragraph (a) of this section or the equivalent California standards as specified in paragraph (g)(4) of this section earn allowances for vehicles sold in any state.

(iv) To the extent that you over-comply with the 40-percent phase-in requirement in model year 2017, you may count your actual U.S. sales exceeding the required number of Tier 3 vehicles as allowances toward meeting the phase-in requirement in 2018 and later model years.

(v) For HDV above 10,000 pounds GVWR and at or below 14,000 pounds GVWR that you certify to the refueling emission standards in paragraph (b) of this section in model years 2015 through 2017 and sell outside of California and the section 177 states, a single vehicle may produce two allowances if it is certified to the Tier 3 diurnal plus hot soak standard. Allowances earned under this paragraph (g)(1)(v) may alternatively be used in model years 2018 through 2022 to phase in the refueling standard, except that a single early-compliant vehicle produces only a single allowance.

(vi) Complete HDV above 14,000 pounds GVWR and all sizes of incomplete HDV earn allowances as described in paragraph (g)(1)(v) of this section if they are certified to the refueling emission standards in paragraph (b) of this section in model years 2015 through 2021.

(2) The following alternative phase-in options apply for model year 2017:

(i) You may disregard the percentage phase-in specified in paragraph (a)(5) of this section for 2017 if you choose 50-state certification for all your vehicles meeting the LEV III PZEV evaporative standards in 2017. Under this option, you may not produce a higher-emitting version of those vehicle models for sale outside of California or the section 177 states. Such vehicles may be certified using carryover data under the California program, but they may not generate or use emission credits. LDV and LDT1 that comply under this paragraph (g)(2)(i) may not generate allowances under paragraph (g)(1) of this section, regardless of the calculated percentage of compliant vehicles in model year 2017.

(ii) You may comply with the phase-in requirement for model year 2017 by meeting the Tier 3 emission standards for diurnal plus hot soak, running loss, and bleed emissions (or the equivalent set of California standards as allowed in this section) with 20 percent of vehicles at or below 6,000 pounds GVWR, and by meeting the leak standard in paragraph (a)(2)(iii) of this section with 20 percent of vehicles at or below 6,000 pounds

GVWR. You may optionally include vehicles above 6,000 pounds GVWR under this paragraph (g)(2)(ii) to calculate the percentage (numerator only) if they meet the leak and/or evaporative emission standards in model year 2017. Vehicles complying with Tier 3 evaporative emission standards may generate or use emission credits relative to the diurnal plus hot soak standard as specified in this section, but they may not generate allowances. You may apply this option and use the alternative phase-in calculation in paragraph (g)(4) of this section, subject to the following conditions:

(A) You must meet or exceed the 20 percent threshold for both evaporative emissions and the leak standard.

(B) All the vehicles meeting the leak standard must also meet the Tier 3 evaporative emission standards and the OBD requirements in § 86.1806–17(b)(1).

(C) Determine the appropriate percentage for calculating compliance under paragraph (g)(4) of this section by adding 20 to the percentage of vehicles meeting the Tier 3 evaporative emission standards to account for vehicles meeting the leak standard. Do not increase the percentage based on meeting the leak standard with more than 20 percent of your vehicles in model year 2017.

(3) If you certify model year 2021 or earlier vehicles to the LEV III evaporative emission standards in California, you may certify those as Tier 3 vehicles that count toward meeting the phase-in requirements of this section. Such vehicles must still be certified to the high-altitude standards in paragraph (a)(2) of this section and the leak standard specified in paragraph (a)(4) of this section. You may not certify vehicles under this paragraph (g)(3) after model year 2021. Vehicles meeting the LEV III standards may also generate allowances under paragraph (g)(1) of this section; however, these vehicles may generate or use emission credits under this subpart only if they are not used to generate allowances and if they are certified using the Option 2 procedures under the LEV III program (including the bleed emission test). Vehicles may be certified under this paragraph (g)(3) based on the rig test (“Option 1”) if they are certified to LEV III standards based on the rig test before model year 2017; this certification option applies through model year 2021. Include these Option 1 vehicles in the calculation of fleet average emissions by using the appropriate Tier 3 emission standard as the FEL. Note that the rig test is considered a diurnal test with

respect to the provisions to account for ethanol emissions as described in paragraph (a)(1)(iv) of this section.

(4) If you fall short of the phase-in percentage specifications in paragraph (a)(5) of this section, you may designate the requisite number of Tier 2 vehicles as Tier 3 vehicles for purposes of demonstrating compliance with the Tier 3 standards in this section. To do this, factor those Tier 2 vehicles into the Tier 3 fleet-average emission calculation using an FEL that is equal to the applicable diurnal plus hot soak standard from the two-day test sequence. The Tier 3 emission standards do not apply to these Tier 2 vehicles. In addition, you may disregard the phase-in percentages specified in paragraph (a)(5) of this section if you instead comply based on one of the following alternative measures:

(i) You may comply with an alternate phase-in schedule described in this paragraph (g)(4)(i). To do this, you must give us a detailed plan for describing how you will meet the alternate phase-in schedule. You comply with the alternate phase-in schedule by calculating an evaporative phase-in index using the following equation that is at or above 1,280 for model years 2017 through 2022 (or 1,040 for model years 2018 through 2022 if you use the provisions of paragraph (g)(2)(i) of this section):

$$\text{Evaporative phase-in index} = 6 \cdot \text{APP}_{2017} + 5 \cdot \text{APP}_{2018} + 4 \cdot \text{APP}_{2019} + 3 \cdot \text{APP}_{2020} + 2 \cdot \text{APP}_{2021} + \text{APP}_{2022}$$

Where:

APP = The phase-in percentage of vehicles meeting the Tier 3 evaporative emission standards for the indicated model year, based on actual sales, as described in paragraph (a)(5) of this section.

(ii) You may comply with an alternate phase-in schedule described in this paragraph (g)(4)(ii). To do this, you must give us a detailed plan for describing how you will meet the alternate phase-in schedule. You comply with the alternate phase-in schedule by calculating an evaporative phase-in index using the following equation that is at or above 420 for model years 2017 through 2022 (or 380 for model years 2018 through 2022 if you use the provisions of paragraph (g)(2)(i) of this section):

$$\text{Evaporative phase-in index} = \text{APP}_{2017} + \text{APP}_{2018} + \text{APP}_{2019} + \text{APP}_{2020} + \text{APP}_{2021} + \text{APP}_{2022}$$

Where:

APP = The phase-in percentage of vehicles meeting the Tier 3 evaporative emission standards for the indicated model year, based on actual sales, as described in paragraph (a)(5) of this section.

(5) This paragraph (g)(5) describes an alternative approach to phasing in the evaporative and refueling emission standards for gaseous-fueled vehicles above 8,500 pounds GVWR. Under this alternative phase-in, you may disregard the requirements of this section related to evaporative emission standards that apply for these vehicles before model year 2019. Similarly, you may disregard the refueling emission standards of this section before model year 2019 for vehicles above 10,000 pounds GVWR. For model year 2019, you may exclude from the phase-in calculation any evaporative families with vehicles that have a Job 1 date on or before March 3, 2018 (see 40 CFR 85.2304). Any vehicles not subject to Tier 3 evaporative emission standards during this phase-in period must continue to comply with the evaporative emission standards in § 86.1816–08(d); such vehicles are subject to the useful life provisions in § 86.1805–12 relative to evaporative emission standards. Each vehicle counting toward the phase-in percentage under this paragraph (g)(5) must meet all the standards that apply throughout the useful life as specified in § 86.1805–17.

(h) *Small-volume manufacturers.* Small-volume manufacturers meeting the eligibility requirements in § 86.1838 may delay complying with the requirements in this section until model year 2022. If meeting the Tier 3 standards would cause severe economic hardship, such manufacturers may ask us to approve an extended compliance deadline under the provisions of 40 CFR 1068.250, except that the solvency criterion does not apply and there is no maximum duration of the hardship relief.

**§§ 86.1814–01, 86.1814–02, 86.1815–01, and 86.1815–02 [Removed]**

- 181. Remove §§ 86.1814–01, 86.1814–02, 86.1815–01, and 86.1815–02.
- 182. A new § 86.1816–18 is added to subpart S to read as follows:

**§ 86.1816–18 Emission standards for heavy-duty vehicles.**

(a) *Applicability and general provisions.* This section describes exhaust emission standards that apply for model year 2018 and later complete heavy-duty vehicles. These standards are optional for incomplete heavy-duty vehicles and for heavy-duty vehicles above 14,000 pounds GVWR as described in § 86.1801. Greenhouse gas emission standards are specified in § 86.1818 for MDPVs and in 40 CFR 1037.104 for other HDV. See § 86.1813 for evaporative and refueling emission standards. This section may apply to

vehicles before model year 2018 as specified in paragraph (b)(11) of this section. Separate requirements apply for MDPVs as specified in § 86.1811. See subpart A of this part for requirements that apply for incomplete heavy-duty vehicles and for heavy-duty engines certified independent of the chassis. The following general provisions apply:

(1) Test all vehicles as described in this section using a chassis dynamometer; establish appropriate load settings based on adjusted loaded vehicle weight (see § 86.1803).

(2) Some provisions apply differently depending on the vehicle's power-to-weight ratio. Determine a vehicle's power-to-weight ratio by dividing the engine's rated power by the vehicle's GVWR (in hp/pound). For purposes of this section, if a test group includes multiple configurations, use the vehicle with the highest power-to-weight ratio to characterize the test group.

(3) Use E10 test fuel as required in § 86.113, except as specified in this section.

(4) Measure emissions from hybrid electric vehicles (including plug-in hybrid electric vehicles) as described in 40 CFR part 1066, subpart F, except that these procedures do not apply for plug-in hybrid electric vehicles during charge-depleting operation.

(b) *Tier 3 exhaust emission standards.* Exhaust emissions may not exceed the Tier 3 exhaust emission standards, as follows:

(1) Measure emissions using the procedures of subpart B of this part, using specific driving schedules and additional procedures as follows:

(i) The Federal Test Procedure (FTP) is based on testing with the Urban Dynamometer Driving Schedule (UDDS) specified in paragraph (a) of Appendix I of this part.

(ii) The Heavy-Duty Supplemental Federal Test Procedure (HD-SFTP) involves testing with the UDDS, the SC03 driving schedule specified in paragraph (h) of Appendix I of this part, and one of the following additional driving schedules:

(A) For Class 2b vehicles, the US06 driving schedule specified in paragraph (g) of Appendix I of this part.

(B) For Class 2b vehicles with a power-to-weight ratio at or below 0.024 hp/pound that are certified to optional standards under paragraphs (b)(2) and (4) of this section, the highway portion of the US06 driving schedule characterized as the "second bag" in § 86.159–08(a).

(C) For Class 3 vehicles, the LA–92 driving schedule as specified in paragraph (c) of Appendix I of this part.

(iii) HD-SFTP emissions are calculated as a composite of test results over these driving schedules based on the following calculation:

$$\text{HD-SFTP (g/mi)} = 0.35 \cdot \text{FTP} + 0.28 \cdot \text{HDSIM} + 0.37 \cdot \text{SC03}$$

Where:

HDSIM = the appropriate driving schedule specified in paragraph (b)(1)(ii)(A) through (C) of this section.

(iv) You may alternatively use FTP emission results to substitute for the

SC03 value in the calculation under paragraph (b)(1)(iii) of this section for a given vehicle for any testing under this section. Such vehicles remain subject to the SFTP standard when tested over the SC03 driving schedule.

(v) Hydrocarbon emission standards are expressed as NMOG; however, you may measure exhaust emissions based on nonmethane hydrocarbon instead of NMOG as described in 40 CFR 1066.635.

(2) Table 1 of this section describes fully phased-in Tier 3 standards that apply as specified in this paragraph (b) for the identified driving schedules. The FTP standards for NMOG+NO<sub>x</sub> apply on a fleet-average basis using discrete bin standards as described in paragraph (b)(4) of this section. The bin standards include additional emission standards for CO emissions, and for NMOG+NO<sub>x</sub> standards when testing over the HD-SFTP driving schedule. Table 1 follows:

TABLE 1 OF § 86.1816-18—FULLY PHASED-IN TIER 3 HDV EXHAUST EMISSION STANDARDS [Tg/mile]

HDV class	Fleet-average NMOG+NO <sub>x</sub>	PM		Formaldehyde
	FTP	FTP	HD-SFTP	FTP
2b .....	0.178	0.008	<sup>1</sup> 0.010	0.006
3 .....	0.247	0.010	0.007	0.006

<sup>1</sup> For vehicles with a power-to-weight ratio at or below 0.024 hp/pound that are certified using the driving schedule described in paragraph (b)(1)(ii)(B) of this section, the HD-SFTP standard for PM is 0.007 g/mile instead of the value specified in the table.

(3) The FTP standards specified in this section apply equally for testing at low-altitude conditions and high-altitude conditions. The HD-SFTP standards described in this section apply only for testing at low-altitude conditions.

(4) The FTP emission standard for NMOG+NO<sub>x</sub> is based on a fleet average in a given model year. You must specify a family emission limit (FEL) for each test group. The FEL serves as the emission standard for the test group with respect to all required FTP testing. Calculate your fleet-average emission

level as described in § 86.1860 to show that you meet the specified standard. For multi-fueled vehicles, calculate fleet-average emission levels based only on emission levels for testing with gasoline or diesel fuel. You may generate or use emission credits for banking and trading and you may use banked or traded credits for demonstrating compliance with the FTP emission standard for NMOG+NO<sub>x</sub> as described in § 86.1861. You comply with the emission standard for a given model year if you have enough credits to show that your fleet-average emission

level is at or below the applicable standard. You may exchange credits between or among any test groups subject to standards under this section. Specify one of the identified values from Table 2 or Table 3 of this section as the FEL for demonstrating that your fleet-average emission level complies with the FTP emission standard for NMOG+NO<sub>x</sub>. These FEL values define emission bins that also determine corresponding emission standards for NMOG+NO<sub>x</sub> emissions over the HD-SFTP driving schedule and for CO emissions, as follows:

TABLE 2 OF § 86.1816-18—TIER 3 BIN STANDARDS—CLASS 2B [g/mile]

FEL Name	NMOG+NO <sub>x</sub>		CO	
	FTP (FEL)	HD-SFTP <sup>1</sup>	FTP	HD-SFTP
Bin 250 .....	0.250	0.800	6.4	22.0
Bin 200 .....	0.200	0.800	4.2	22.0
Bin 170 .....	0.170	0.450	4.2	12.0
Bin 150 .....	0.150	0.450	3.2	12.0
Bin 0 <sup>2</sup> .....	0.000	0.000	0.0	0.0

<sup>1</sup> Vehicles with a power-to-weight ratio at or below 0.024 hp/pound that are certified using the driving schedule described in paragraph (b)(1)(ii)(B) of this section, the following HD-SFTP bin standards for NMOG+NO<sub>x</sub> apply instead of those identified in the table: 0.350 g/mile for Bin 150 and Bin 170; and 0.550 g/mile for Bin 200 and Bin 250.

<sup>2</sup> Vehicles certified to Bin 0 must also meet PM and formaldehyde standards of 0.000 g/mile instead of the standards specified in paragraph (b)(2) of this section.

TABLE 3 OF § 86.1816-18—TIER 3 BIN STANDARDS—CLASS 3 [g/mile]

FEL Name	NMOG+NO <sub>x</sub>		CO	
	FTP (FEL)	HD-SFTP	FTP	HD-SFTP
Bin 400 .....	0.400	0.550	7.3	6.0
Bin 270 .....	0.270	0.550	4.2	6.0
Bin 230 .....	0.230	0.350	4.2	4.0

TABLE 3 OF § 86.1816–18—TIER 3 BIN STANDARDS—CLASS 3—Continued  
[g/mile]

FEL Name	NMOG+NO <sub>x</sub>		CO	
	FTP (FEL)	HD-SFTP	FTP	HD-SFTP
Bin 200 .....	0.200	0.350	3.7	4.0
Bin 0 <sup>1</sup> .....	0.000	0.000	0.0	0.0

<sup>1</sup> Vehicles certified to Bin 0 must also meet PM and formaldehyde standards of 0.000 g/mile instead of the standards specified in paragraph (b)(2) of this section.

(5) [Reserved]

(6) The full Tier 3 program includes new emission standards for NMOG+NO<sub>x</sub>, PM, CO, and formaldehyde; it also includes measurement with a new test fuel and a longer useful life. Vehicles meeting all these requirements are considered Final Tier 3 vehicles. Vehicles that do not meet all the Tier 3 requirements are considered Interim Tier 3 vehicles. The Tier 3 PM standards phase in over several years. Any vehicles not subject to Tier 3 PM standards during the phase-in period must continue to comply with the PM standards in § 86.1816–08. Paragraph (b)(7) of this section describes how to transition to Tier 3 standards for emissions other than PM. The following provisions describe the primary approach for phasing in the Tier 3 PM standards:

(i) You must meet the FTP emission standard for PM with 20, 40, 70, and 100 percent of your projected nationwide sales of all vehicles subject to this section in model years 2018 through 2021, respectively. Each vehicle meeting the Tier 3 FTP standard for PM must also meet the Tier 3 HD-SFTP standard for PM.

(ii) You may disregard the phase-in percentages specified in paragraph (b)(6)(i) of this section if you instead comply with an indexed PM phase-in schedule as described in this paragraph (b)(6)(ii). To do this, you must notify us of your intent before January 1, 2018, and include a detailed plan for complying with the indexed phase-in schedule. You comply with the indexed

phase-in schedule by calculating a PM phase-in index at or above 440 using the following equation for model years 2018 through 2021:

$$\text{PM phase-in index} = 4 \cdot \text{APP}_{2018} + 3 \cdot \text{APP}_{2019} + 2 \cdot \text{APP}_{2020} + \text{APP}_{2021}$$

Where:

APP = The phase-in percentage of vehicles meeting the Tier 3 PM standards for the indicated model year, based on actual sales.

(iii) Vehicles meeting the Tier 3 PM standards must meet those standards over the useful life as specified in § 86.1805. Note that Interim Tier 3 vehicles may have different useful life values for PM emission standards than for other emission standards.

(iv) Measure PM emissions from all vehicles using the same test fuel used for measuring NMOG+NO<sub>x</sub> emissions.

(v) You may certify Interim Tier 3 vehicles based on carryover data.

(vi) You may use the alternative phase-in provisions described in paragraph (b)(8) of this section to transition to the Tier 3 exhaust emission standards on a different schedule.

(7) The following provisions describe the primary approach for phasing in the Tier 3 standards other than PM in 2022 and earlier model years:

(i) The fleet-average FTP emission standard for NMOG+NO<sub>x</sub> phases in over several years as described in this paragraph (b)(7)(i). You must identify FELs as described in paragraph (b)(4) of this section and calculate a fleet-average emission level to show that you meet the FTP emission standard for NMOG+NO<sub>x</sub> that applies for each

model year. You may certify using transitional bin standards specified in Table 5 of this section through model year 2021; these vehicles are subject to FTP emission standards for PM and formaldehyde as described in paragraph (b)(2) of this section. You may use the E0 test fuel specified in § 86.113 for gasoline-fueled vehicles certified to the transitional bins; the useful life period for these vehicles is 120,000 miles or 11 years. Fleet-average FTP emission standards decrease as shown in the following table:

TABLE 4 OF § 86.1816–18—DECLINING FLEET-AVERAGE FTP EMISSION STANDARDS FOR NMOG+NO<sub>x</sub>  
[g/mile]

Model Year	Class 2b	Class 3
2016 <sup>1</sup> .....	0.333	0.548
2017 <sup>1</sup> .....	0.310	0.508
2018 .....	0.278	0.451
2019 .....	0.253	0.400
2020 .....	0.228	0.349
2021 .....	0.203	0.298
2022 .....	0.178	0.247

<sup>1</sup> Fleet-average standards are shown for 2016 and 2017 for purposes of voluntary early compliance as described in paragraph (b)(11) of this section.

TABLE 5 OF § 86.1816–18—TRANSITIONAL TIER 3 FTP BIN STANDARDS  
[g/mile]<sup>1</sup>

Class	FEL Name	NMOG+NO <sub>x</sub>	NO <sub>x</sub> <sup>2</sup>	CO
2b .....	Bin 395	0.395	0.2	6.4
	Bin 340	0.340	0.2	6.4
3 .....	Bin 630	0.630	0.4	7.3
	Bin 570	0.570	0.4	7.3

<sup>1</sup> Vehicles certified to Transitional Tier 3 FTP bins are not subject to HD-SFTP standards.

<sup>2</sup> The NO<sub>x</sub> standard applies only for certification testing with emission-data vehicles.

(ii) You may use the alternative phase-in provisions described in paragraph (b)(8) of this section to transition to the Tier 3 exhaust emission standards on a different schedule.

(8) This paragraph (b)(8) describes an alternative approach to phasing in the Tier 3 emission standards. If you choose this approach, you must phase in the Tier 3 standards for all your vehicles subject to this section according to this schedule. Under this alternative phase in, you must meet all the standards specified in paragraph (b)(2) of this section according to the phase-in schedule specified in Table 6 of this section based on the indicated percentage of your projected nationwide sales in each model year. These vehicles must meet the applicable FTP emission

standard for CO and the HD-SFTP emission standards for NMOG+NO<sub>x</sub> and CO that apply for Class 2b Bin 170 and Class 3 Bin 230 as described in paragraph (b)(4) of this section. Any vehicles not subject to Tier 3 standards during the phase-in period must continue to comply with the gaseous exhaust emission standards in § 86.1816–08. Each vehicle counting toward the PM phase-in percentage under this paragraph (b)(8) in model years 2019 and 2020 must also be included in the portion of the fleet meeting the Tier 3 standards for pollutants other than PM. Each vehicle counting toward the phase-in percentage for any pollutant must use the Tier 3 test fuel specified in § 86.113–07. The following exceptions and

special provisions apply under this paragraph (b)(8):

(i) For model year 2019, you may exclude from the phase-in calculation any test groups that have a Job 1 date on or before March 3, 2018 (see 40 CFR 85.2304).

(ii) You may generate Tier 3 emission credits during the phase-in period if all your pre-Tier 3 vehicles in a given model year have FELs at or below the NO<sub>x</sub> and NMHC standards in § 86.1816–08. Determine emission credits by calculating fleet-average emission levels for Tier 3 and pre-Tier 3 vehicles together; for pre-Tier 3 vehicles use an NMOG+NO<sub>x</sub> equivalent FEL of 0.395 g/mile for Class 2b vehicles and 0.630 g/mile for Class 3 vehicles.

TABLE 6 OF § 86.1816–18—ALTERNATIVE PHASE-IN SCHEDULE

Model Year	Class 2b		Class 3	
	PM (percent)	Other than PM (percent)	PM (percent)	Other than PM (percent)
2019 .....	40	65	40	60
2020 .....	70	77	70	73
2021 .....	100	88	100	87
2022 .....	100	100	100	100

(9) You may not use credits generated from vehicles certified under § 86.1816–08 for demonstrating compliance with the Tier 3 standards.

(10) [Reserved]

(11) You may voluntarily certify your vehicles under this section in model years 2016 and 2017. If you do this, the fleet-average FTP emission standards for NMOG+NO<sub>x</sub> apply to all your heavy-duty vehicles under this section as specified in paragraph (b)(7)(i) of this section. Use any of the available bin standards as described in this section. Vehicles certified under this paragraph (b)(11) must comply with the PM standards specified in § 86.1816–08 instead of the Tier 3 PM standards specified in this section.

(12) Alternate standards apply for in-use testing with 2022 and earlier model

year vehicles as described in this paragraph (b)(12). These alternate standards apply in the first model year that a test group is certified to Tier 3 FTP or HD-SFTP standards for NMOG+NO<sub>x</sub> or PM under this section. The alternate in-use standards also apply in the following model year (but not beyond 2022) for carryover test groups certified to the same bin standards. If you certify a test group to more stringent bin standards under this section in a given model year, the alternate in-use standards apply as if that were the first model year of certifying to the Tier 3 standards. The provisions of this section apply separately for NMOG+NO<sub>x</sub> and PM. This paragraph (b)(12) does not apply for Bin 0 vehicles.

(i) The alternate in-use FTP standards for PM are 0.016 g/mile for Class 2b vehicles and 0.020 g/mile for Class 3 vehicles.

(ii) The alternate in-use HD-SFTP standards for PM are 0.012 g/mile for Class 2b vehicles with a power-to-weight ratio at or below 0.024 hp/pound that are certified to optional standards under paragraphs (b)(2) and (4) of this section, and 0.015 g/mile for other Class 2b vehicles. The alternate in-use HD-SFTP standard for PM is 0.012 g/mile for Class 3 vehicles. Alternate in-use HD-SFTP standards do not apply for vehicles certified to the transitional bins described in paragraph (b)(7) of this section.

(iii) Alternate in-use FTP and HD-SFTP standards for NMOG+NO<sub>x</sub> apply as specified in the following table:

TABLE 7 OF § 86.1816–18—ALTERNATE IN-USE NMOG+NO<sub>x</sub> STANDARDS  
[g/mile]

Class	FEL Name	FTP	HD-SFTP <sup>1</sup>
2b .....	Bin 250 .....	0.370	1.120
	Bin 200 .....	0.300	1.120
	Bin 170 .....	0.250	0.630
	Bin 150 .....	0.220	0.630

TABLE 7 OF § 86.1816–18—ALTERNATE IN-USE NMOG+NO<sub>x</sub> STANDARDS—Continued  
[g/mile]

Class	FEL Name	FTP	HD-SFTP <sup>1</sup>
3	Bin 400	0.600	0.770
	Bin 270	0.400	0.770
	Bin 230	0.340	0.490
	Bin 200	0.300	0.490

<sup>1</sup> For Class 2b vehicles with a power-to-weight ratio at or below 0.024 hp/pound that are certified to optional standards under paragraphs (b)(2) and (4) of this section, the following alternate in-use FTP standards for NMOG+NO<sub>x</sub> apply instead of those identified in the table: 0.490 g/mile for Bin 150 and Bin 170; and 0.770 g/mile for Bin 200 and Bin 250. Note that vehicles certified to transitional Tier 3 FTP bins are not subject to HD-SFTP standards.

(13) Keep records as needed to show that you meet the requirements specified in this paragraph (b) for phasing in standards and for complying with declining fleet-average average standards.

(c) *Highway NMOG+NO<sub>x</sub> exhaust emission standard.* For vehicles certified to any of the Tier 3 standards specified in paragraph (b) of this section, NMOG+NO<sub>x</sub> emissions measured on the highway test cycle in 40 CFR part 600, subpart B, may not exceed the applicable NMOG+NO<sub>x</sub> bin standard for FTP testing. Demonstrate compliance with this standard for low-mileage vehicles by applying the appropriate deterioration factor.

(d) *Provisions for Otto-cycle engines.* The special provisions described in § 86.1811–17(d) apply to vehicles with Otto-cycle engines that are certified under this section.

(e) *Small-volume manufacturers.* Small-volume manufacturers meeting the eligibility requirements in § 86.1838 may delay complying with the requirements in this section until model year 2022. This also applies for continuing to use the E0 test fuel specified in § 86.113 through model year 2021. If meeting the Tier 3 standards would cause severe economic hardship, such manufacturers may ask us to approve an extended compliance deadline under the provisions of 40 CFR 1068.250, except that the solvency criterion does not apply and there is no maximum duration of the hardship relief.

■ 183. Section § 86.1817–08 is amended by revising the introductory text to read as follows:

**§ 86.1817–08 Complete heavy-duty vehicle averaging, trading, and banking program.**

Section 86.1817–08 includes text that specifies requirements that differ from § 86.1817–05. Where a paragraph in § 86.1817–05 is identical and applicable to § 86.1817–08, this may be indicated by specifying the corresponding paragraph and the statement “[Reserved]. For guidance see

§ 86.1817–05.” This section does not apply for NO<sub>x</sub> or NMOG+NO<sub>x</sub> emissions for vehicles certified to the Tier 3 standards in § 86.1816–18, including those vehicles that certify to the Tier 3 standards before model year 2018. See §§ 86.1860 and 86.1861 for provisions that apply for vehicles certified to the Tier 3 standards.

\* \* \* \* \*

■ 184. Section 86.1818–12 is amended by revising paragraph (a) to read as follows:

**§ 86.1818–12 Greenhouse gas emission standards for light-duty vehicles, light-duty trucks, and medium-duty passenger vehicles.**

(a) *Applicability.* (1) This section contains standards and other regulations applicable to the emission of the air pollutant defined as the aggregate group of six greenhouse gases: Carbon dioxide, nitrous oxide, methane, hydrofluorocarbons, perfluorocarbons, and sulfur hexafluoride. This section applies to 2012 and later model year LDV, LDT and MDPV, including multi-fuel vehicles, vehicles fueled with alternative fuels, hybrid electric vehicles, plug-in hybrid electric vehicles, electric vehicles, and fuel cell vehicles. Unless otherwise specified, multi-fuel vehicles must comply with all requirements established for each consumed fuel. The provisions of this section, except paragraph (c), also apply to clean alternative fuel conversions as defined in 40 CFR 85.502, of all model year light-duty vehicles, light-duty trucks, and medium-duty passenger vehicles. Manufacturers that qualify as a small business according to the requirements of § 86.1801–12(j) are exempt from the emission standards in this section. Manufacturers that have submitted a declaration for a model year according to the requirements of § 86.1801–12(k) for which approval has been granted by the Administrator are conditionally exempt from the emission standards in paragraphs (c) through (e) of this section for the approved model year.

(2) The standards specified in this section apply only for testing at low-altitude conditions. However, manufacturers must submit an engineering evaluation indicating that common calibration approaches are utilized at high altitude. Any deviation from low altitude emission control practices must be included in the auxiliary emission control device (AECD) descriptions submitted at certification. Any AECD specific to high altitude requires engineering emission data for EPA evaluation to quantify any emission impact and determine the validity of the AECD.

\* \* \* \* \*

■ 185. Section § 86.1821–01 is amended by revising paragraphs (a) and (b) introductory text an adding paragraphs (b)(10) and (f) to read as follows:

**§ 86.1821–01 Evaporative/refueling family determination.**

(a) The gasoline-, ethanol-, methanol-, liquefied petroleum gas-, and natural gas-fueled vehicles described in a certification application will be divided into groupings expected to have similar evaporative and/or refueling emission characteristics (as applicable) throughout their useful life. Each group of vehicles with similar evaporative and/or refueling emission characteristics shall be defined as a separate evaporative/refueling family. Manufacturers shall use good engineering judgment to determine evaporative/refueling families.

(b) For vehicles that operate on volatile liquid fuels to be classed in the same evaporative/refueling family, they must be similar with respect to all the following items:

\* \* \* \* \*

(10) Evaporative emission standard or family emission limit (FEL).

\* \* \* \* \*

(f) For vehicles to be classed in the same leak family, they must be similar with respect to the items listed in paragraph (b) of this section and use the same OBD method for detecting leaks.



■ 186. Section § 86.1823–08 is amended as follows:

- a. By revising the introductory text.
- b. By removing and reserving paragraph (g).
- c. By adding paragraph (n).

**§ 86.1823–08 Durability demonstration procedures for exhaust emissions.**

This section describes durability demonstration procedures for exhaust emissions. Eligible small-volume manufacturers or small-volume test groups may optionally meet the requirements of §§ 86.1826 and 86.1838 instead of the requirements of paragraphs (a) through (m) of this section. A separate durability demonstration is required for each durability group.

\* \* \* \* \*

(n) *Emission component durability.* [Reserved]. For guidance see 40 CFR 86.1823–01(e).

■ 187. Section § 86.1824–08 is amended as follows:

- a. By revising the introductory text.
- b. By revising paragraphs (a) and (f)(1).
- c. By removing and reserving paragraph (h).
- d. By adding paragraph (k).

**§ 86.1824–08 Durability demonstration procedures for evaporative emissions.**

This section describes durability demonstration procedures for evaporative emissions. Eligible small-volume manufacturers or small-volume test groups may optionally meet the requirements of §§ 86.1826 and 86.1838 instead of the requirements of paragraphs (a) through (j) of this section. A separate durability demonstration is required for each evaporative/refueling family.

(a) *Durability program objective.* The durability program must predict an expected in-use emission deterioration rate and emission level that effectively represents a significant majority of the distribution of emission levels and deterioration in actual use over the full useful life of candidate in-use vehicles of each vehicle design which uses the durability program. This requirement applies for all SHED-based measurements except the bleed emission test. The standard for bleed emissions applies for the full useful life, but manufacturers do not need to establish deterioration factors for bleed emissions. The requirements of this section do not apply for spitback or leak standards.

\* \* \* \* \*

(f) \* \* \*

(1) For gasoline fueled vehicles certified to meet the evaporative

emission standards set forth in this subpart, any mileage accumulation method for evaporative emissions must employ gasoline fuel for the entire mileage accumulation period which contains ethanol in, at least, the highest concentration permissible in gasoline under federal law and that is commercially available in any state in the United States. Unless otherwise approved by the Administrator, the manufacturer must determine the appropriate ethanol concentration by selecting the highest legal concentration commercially available during the calendar year before the one in which the manufacturer begins its mileage accumulation. The manufacturer must also provide information acceptable to the Administrator to indicate that the mileage accumulation method is of sufficient design, duration and severity to stabilize the permeability of all non-metallic fuel and evaporative system components to the mileage accumulation fuel constituents.

\* \* \* \* \*

(k) *Emission component durability.* [Reserved]. For guidance see 40 CFR 86.1824–01(d).

■ 188. Section § 86.1826–01 is revised to read as follows:

**§ 86.1826–01 Assigned deterioration factors for small-volume manufacturers and small-volume test groups.**

(a) *Applicability.* This program is an option available for small-volume manufacturers and small-volume test groups as described in § 86.1838.

(b) *Determination of deterioration factors.* No service accumulation method or vehicle/component selection method is required. Deterioration factors for all types of regulated emissions are assigned using the provisions in this paragraph (b). A separate assigned deterioration factor is required for each durability group. Manufacturers shall use good engineering judgment in applying deterioration factors. Manufacturers may use assigned deterioration factors that the Administrator determines and prescribes.

(1) The deterioration factors will be the Administrator’s estimate, periodically updated and published in a guidance document, of the 70th percentile deterioration factors calculated using the industry-wide database of previously completed durability data vehicles or engines used for certification.

(2) The Administrator may use discretion to develop assigned deterioration factors using alternative methods if there is insufficient information to calculate an appropriate

industry-wide deterioration factor (for example: a new engine technology coupled with a proven emission control system). These methods may include the use of assigned deterioration factors based on similar durability vehicles.

(3) Alternatively, with advance approval from the Administrator, a manufacturer may use deterioration factors developed by another manufacturer. The manufacturer seeking to use these deterioration factors must—

(i) Demonstrate that the engines from the two manufacturers share technical parameters to the degree that would support the conclusion that a common deterioration factor should apply for both vehicle configurations as defined in § 86.1803.

(ii) Provide supporting information, such as histograms of exhaust temperature data, comparisons of vehicle weight and road load horsepower, or comparisons of powertrains and emission control systems.

■ 189. Section 86.1828–01 is amended by removing and reserving paragraph (d) and adding paragraph (g) to read as follows:

**§ 86.1828–01 Emission data vehicle selection.**

\* \* \* \* \*

(g) *Cold temperature NMHC testing.* For cold temperature NMHC exhaust emission compliance for each durability group, the manufacturer must select the vehicle expected to emit the highest NMHC emissions at 20 °F on candidate in-use vehicles from the test vehicles specified in paragraph (a) of this section. When the expected worst-case cold temperature NMHC vehicle is also the expected worst-case cold temperature CO vehicle as selected in paragraph (c) of this section, then cold temperature testing is required only for that vehicle; otherwise, testing is required for both the worst-case cold temperature CO vehicle and the worst-case cold temperature NMHC vehicle.

**§ 86.1828–10 [Removed]**

■ 190. Remove § 86.1828–10.

■ 191. Section 86.1829–01 is amended as follows:

- a. By removing and reserving paragraph (b)(1)(iii)(C).
- b. By revising paragraph (b)(2)(i).
- c. By adding paragraph (b)(2)(iv).
- d. By revising paragraph (b)(4).
- f. By removing and reserving paragraph (d).

**§ 86.1829–01 Durability and emission testing requirements; waivers.**

\* \* \* \* \*

(b) \* \* \*

(2) \* \* \*

(i) *Testing at low altitude.* One EDV in each evaporative/refueling family and evaporative/refueling emission control system combination must be tested in accordance with the evaporative/refueling test procedure requirement of subpart B of this part. The configuration of the EDV will be determined under the provisions of § 86.1828–01. The EDV must also be tested for exhaust emission compliance using the FTP and SFTP procedures of subpart B of this part. In lieu of testing natural gas or hydrogen fueled vehicles to demonstrate compliance with the evaporative and refueling emission standards specified in this subpart, a manufacturer may provide a statement in its application for certification that, based on the manufacturer's engineering evaluation of appropriate testing and/or design parameters, all light-duty vehicles, light-duty trucks, and complete heavy-duty vehicles comply with applicable emission standards. This same testing exemption applies for vehicles fueled by liquefied petroleum gas, except that refueling tests are required for systems that allow venting during the refueling operation.

\* \* \* \* \*

(iv) For diesel-fueled light-duty vehicles, a manufacturer may provide a statement in the application for certification that vehicles comply with the refueling emission standard instead of submitting test data. Such a statement must be based on previous emission tests, development tests, or other appropriate information, and good engineering judgment.

\* \* \* \* \*

(4) *Electric vehicles and fuel cell vehicles.* For electric vehicles and fuel cell vehicles, manufacturers may provide a statement in the application for certification that vehicles comply with all the requirements of this subpart instead of submitting test data. Such a statement must be based on previous emission tests, development tests, or other appropriate information, and good engineering judgment.

\* \* \* \* \*

■ 192. A new § 86.1829–15 is added to subpart S to read as follows:

**§ 86.1829–15 Durability and emission testing requirements; waivers.**

This section describes general testing requirements for certifying vehicles under this subpart, and includes several provisions allowing for statements of compliance instead of testing in certain circumstances. Where a manufacturer provides a statement instead of test data

under this section, it must be based on previous emission tests, development tests, or other appropriate information, and on good engineering judgment.

(a) One durability demonstration is required for each durability group. The configuration of the DDV is determined according to § 86.1822. The DDV shall be tested and accumulate service mileage according to the provisions of §§ 86.1823, 86.1824, 86.1825, and 86.1831. Small-volume manufacturers and small-volume test groups may optionally use the alternative durability provisions of § 86.1838.

(b) The manufacturer must test EDVs as follows to demonstrate compliance with emission standards:

(1) Test one EDV in each durability group using the test procedures in 40 CFR part 1066 to demonstrate compliance with cold temperature CO and NMHC exhaust emission standards.

(2) Test one EDV in each test group using the FTP and SFTP test procedures in 40 CFR part 1066 and the HFET test procedures of 40 CFR part 600, subpart B, to demonstrate compliance with other exhaust emission standards.

(3) Test one EDV in each evaporative/refueling family and evaporative/refueling emission control system combination using the test procedures in subpart B of this part to demonstrate compliance with evaporative and refueling emission standards.

(c) The manufacturer must demonstrate compliance with emission standards at low-altitude conditions as described in paragraph (b) of this section. For standards that apply at high-altitude conditions, the manufacturer may either perform the same tests or provide a statement in the application for certification that, based on an engineering evaluation of appropriate testing to measure or simulate high-altitude emissions, all vehicles comply with applicable emission standards at high altitude.

(d) Manufacturers may omit exhaust testing for certification in certain circumstances as follows:

(1) For vehicles subject to the Tier 3 PM standards in §§ 86.1811, a manufacturer may provide a statement in the application for certification that vehicles comply with applicable PM standards instead of submitting PM test data for a certain number of vehicles. However, each manufacturer must test vehicles from a minimum number of durability data groups as follows:

(i) Manufacturers with a single durability data group subject to the Tier 3 PM standards in § 86.1811 must submit PM test data for that group.

(ii) Manufacturers with two to eight durability data groups subject to the

Tier 3 PM standards in § 86.1811 must submit PM test data for at least two durability data groups each model year. EPA will work with the manufacturer to select durability data groups for testing, with the general expectation that testing will rotate to cover a manufacturer's whole product line over time. If a durability data group has been certified in an earlier model year based on submitted PM data, and that durability data group is eligible for certification using carryover test data, that carryover data may count toward meeting the requirements of this paragraph (d)(1), subject to the selection of durability data groups.

(iii) Manufacturers with nine or more durability data groups subject to the Tier 3 PM standards in § 86.1811 must submit PM test data for at least 25 percent of those durability data groups each model year. We will work with the manufacturer to select durability data groups for testing as described in paragraph (d)(1)(ii) of this section.

(2) Small-volume manufacturers may provide a statement in the application for certification that vehicles comply with the applicable PM standard instead of submitting test data.

(3) Manufacturers may omit PM measurements for fuel economy and GHG testing conducted in addition to the testing needed to demonstrate compliance with the PM emission standards.

(4) Manufacturers may provide a statement in the application for certification that vehicles comply with the applicable formaldehyde standard instead of submitting test data.

(5) When conducting Selective Enforcement Audit testing, a manufacturer may petition the Administrator to waive the requirement to measure PM emissions and formaldehyde emissions.

(e) Manufacturers may omit evaporative or refueling testing for certification in certain circumstances as follows:

(1) For diesel-fueled vehicles, a manufacturer may provide a statement in the application for certification that vehicles comply with the refueling emission standard instead of submitting test data.

(2) For vehicles fueled by natural gas, a manufacturer may provide a statement in the application for certification that vehicles comply with evaporative emission standards instead of submitting test data. Compressed natural gas vehicles meeting the requirements for fueling connection devices in § 86.1813–17(f)(1) are deemed to comply with evaporative and refueling emission standards.

(3) For vehicles fueled by liquefied petroleum gas, a manufacturer may provide a statement in the application for certification that vehicles comply with evaporative and refueling emission standards instead of submitting test data, except that refueling tests are required for systems that allow venting during the refueling operation.

(4) Manufacturers may provide a statement in the application for certification that vehicles comply with the leak standard in § 86.1813 instead of submitting test data.

(5) For vehicles certified to the refueling emission standards in §§ 86.1811 or 86.1813, a manufacturer may provide a statement in the application for certification that vehicles comply with the fuel dispensing spitback standard instead of submitting test data.

(6) In lieu of testing vehicles for the supplemental two-diurnal test sequence, a manufacturer may optionally provide a statement of compliance in its application for certification that, based on the manufacturer's good engineering judgment, all vehicles in the evaporative/refueling emission family comply with the evaporative emission standard for the supplemental two-diurnal test sequence.

(i) The option to provide a statement of compliance in lieu of 2-diurnal evaporative certification test data is limited to vehicles with conventional evaporative emission control systems (as determined by the Administrator). EPA may perform confirmatory 2-diurnal evaporative emission testing on test vehicles certified using this option. If data shows noncompliance, it will be addressed through § 86.1851. Also, if data shows noncompliance, EPA will generally disallow subsequent waivers for the applicable evaporative family.

(ii) Manufacturers shall supply information if requested by EPA in support of the statement of compliance described in this paragraph (e)(6). This information shall include evaporative calibration information for the emission-data vehicle and for other vehicles in the evaporative/refueling family, including, but not limited to, canister type, canister volume, canister working capacity, canister shape and internal configuration, fuel tank volume, fuel tank geometry, the type of fuel delivery system (return, returnless, variable flow fuel pump, etc.), a description of the input parameters and software strategy used to control the evaporative canister purge, the nominal purge flow volume (in bed volumes) when vehicles are driven over the 2-diurnal (FTP) driving cycle, the nominal purge flow volume (in bed volumes) when vehicles are

driven over the 3-diurnal (FTP + running loss) driving cycle, and other supporting information as necessary to demonstrate that the purge flow rate calibration on the 2-diurnal test sequence is adequate to comply with the evaporative emission standard for the supplemental two-diurnal test sequence.

(7) Where a California evaporative emission standard is at least as stringent as a comparable federal evaporative emission standard for a vehicle, we may accept test data demonstrating compliance with the California standard as demonstrating compliance with the comparable standard under this subpart. We may require you to provide test data clearly demonstrating that a vehicle tested using the California-specified test procedures will meet the comparable standard under this subpart when tested using the test procedures specified in this part.

(8) Through model year 2019, we may accept test data demonstrating compliance with the California refueling emission standard as demonstrating compliance with the analogous refueling emission standard under this subpart if all the following conditions apply:

(i) You certified the vehicles in model year 2016 to California's refueling emission standards.

(ii) You are certifying the vehicles to refueling standards for the new model year based on carryover data instead of performing new testing.

(iii) You are also certifying the vehicles for evaporative emissions based on California test procedures under the provisions of paragraph (e)(6) of this section.

(9) For vehicles with fuel tanks exceeding 35 gallons nominal fuel tank capacity, and for any incomplete vehicles, a manufacturer may provide a statement in the application for certification that vehicles comply with refueling emission standards instead of submitting test data, consistent with 40 CFR 1037.103(c).

(f) For electric vehicles and fuel cell vehicles, manufacturers may provide a statement in the application for certification that vehicles comply with all the requirements of this subpart instead of submitting test data. Tailpipe emissions of regulated pollutants from vehicles powered solely by electricity are deemed to be zero.

■ 193. Section 86.1837–01 is amended by revising paragraph (a) to read as follows:

**§ 86.1837–01 Rounding of emission measurements.**

(a) Unless otherwise specified, the results of all emission tests shall be

rounded to the number of places to the right of the decimal point indicated by expressing the applicable emission standard of this subpart to one additional significant figure, in accordance with 40 CFR 1065.20.

\* \* \* \* \*

■ 194. Section 86.1838–01 is amended by revising the section heading and paragraphs (a), (b), (c), and (d) introductory text to read as follows:

**§ 86.1838–01 Small-volume manufacturer certification procedures.**

(a) *Overview.* The small-volume manufacturer certification procedures described in paragraphs (b) and (c) of this section are optional. Small-volume manufacturers may use these optional procedures to demonstrate compliance with the general standards and specific emission requirements contained in this subpart.

(b) *Eligibility requirements—(1) Small-volume manufacturers.* (i) Optional small-volume manufacturer certification procedures apply for vehicles produced by manufacturers with the following number of combined sales of vehicles subject to standards under this subpart in all states and territories of the United States in the model year for which certification is sought, including all vehicles and engines imported under the provisions of 40 CFR 85.1505 and 85.1509:

(A) 5,000 units for the Tier 3 standards described in §§ 86.1811, 86.1813, and 86.1816. This volume threshold applies for phasing in the Tier 3 standards and for determining the corresponding deterioration factors. This is based on average nationwide sales volumes for model years 2012 through 2014 for manufacturers that sell vehicles in model year 2012. The provision allowing delayed compliance with the Tier 3 standards applies for qualifying companies even if sales after model year 2014 increase beyond 5,000 units. Manufacturers with no sales in model year 2012 may instead rely on projected sales volumes; however, if nationwide sales exceed an average value of 5,000 units in any three consecutive model years, the manufacturer is no longer eligible for provisions that apply to small-volume manufacturers after two additional model years. For example, if actual sales in model years 2015 through 2017 exceed 5,000 units, the small-volume provisions would no longer apply starting in model year 2020.

(B) 15,000 units for all other requirements. See § 86.1845 for separate provisions that apply for in-use testing.

(ii) If a manufacturer's aggregated sales in the United States, as determined

in paragraph (b)(3) of this section are fewer than the number of units specified in paragraph (b)(1)(i) of this section, the manufacturer (or each manufacturer in the case of manufacturers in an aggregated relationship) may certify under the provisions of paragraph (c) of this section.

(iii) A manufacturer that qualifies as a small business under the Small Business Administration regulations in 13 CFR Part 121 is eligible for all the provisions that apply for small-volume manufacturers under this subpart. See § 86.1801–12(j) to determine whether companies qualify as small businesses.

(iv) The sales volumes specified in this section are based on actual sales, unless otherwise specified.

(v) Except for delayed implementation of new emission standards, an eligible manufacturer must transition out of the special provisions that apply for small-volume manufacturers as described in § 86.1801–12(k)(2)(i) through (iii) if sales volumes increase above the applicable threshold.

(2) *Small-volume test groups.* (i) If the aggregated sales in all states and territories of the United States, as determined in paragraph (b)(3) of this section are equal to or greater than 15,000 units, then the manufacturer (or each manufacturer in the case of manufacturers in an aggregated relationship) will be allowed to certify a number of units under the small-volume test group certification procedures in accordance with the criteria identified in paragraphs (b)(2)(ii) through (iv) of this section.

(ii) If there are no additional manufacturers in an aggregated relationship meeting the provisions of paragraph (b)(3) of this section, then the manufacturer may certify whole test groups whose total aggregated sales (including heavy-duty engines) are less than 15,000 units using the small-volume provisions of paragraph (c) of this section.

(iii) If there is an aggregated relationship with another manufacturer which satisfies the provisions of paragraph (b)(3) of this section, then the following provisions shall apply:

(A) If none of the manufacturers own 50 percent or more of another manufacturer in the aggregated relationship, then each manufacturer may certify whole test groups whose total aggregated sales (including heavy-duty engines) are less than 15,000 units using the small-volume provisions of paragraph (c) of this section.

(B) If any of the manufacturers own 50 percent or more of another manufacturer in the aggregated relationship, then the limit of 14,999 units must be shared

among the manufacturers in such a relationship. In total for all the manufacturers involved in such a relationship, aggregated sales (including heavy-duty engines) of up to 14,999 units may be certified using the small-volume provisions of paragraph (c) of this section. Only whole test groups shall be eligible for small-volume status under paragraph (c) of this section.

(iv) In the case of a joint venture arrangement (50/50 ownership) between two manufacturers, each manufacturer retains its eligibility for 14,999 units under the small-volume test group certification procedures, but the joint venture must draw its maximum 14,999 units from the units allocated to its parent manufacturers. Only whole test groups shall be eligible for small-volume status under paragraph (c) of this section.

(3) *Sales aggregation for related manufacturers.* The projected or actual sales from different firms shall be aggregated in the following situations:

(i) Vehicles and/or engines produced by two or more firms, one of which is 10 percent or greater part owned by another;

(ii) Vehicles and/or engines produced by any two or more firms if a third party has equity ownership of 10 percent or more in each of the firms;

(iii) Vehicles and/or engines produced by two or more firms having a common corporate officer(s) who is (are) responsible for the overall direction of the companies;

(iv) Vehicles and/or engines imported or distributed by all firms where the vehicles and/or engines are manufactured by the same entity and the importer or distributor is an authorized agent of the entity.

(c) *Small-volume provisions.* Small-volume manufacturers and small-volume test groups shall demonstrate compliance with all applicable sections of this subpart, with the following exceptions:

(1) *Durability demonstration.* Use the provisions of § 86.1826 rather than the requirements of §§ 86.1823, 86.1824, and 86.1825.

(2) *In-use verification testing.* Measure emissions from in-use vehicles as described in § 86.1845, subject to the following additional provisions:

(i) In-use verification test vehicles may be procured from customers or may be owned by, or under the control of the manufacturer, provided that the vehicle has accumulated mileage in typical operation on public streets and has received typical maintenance.

(ii) In lieu of procuring in-use verification test vehicles that have a minimum odometer reading of 50,000

miles, a manufacturer may demonstrate to the satisfaction of the Agency that, based on owner survey data, the average mileage accumulated after 4 years for a given test group is less than 50,000 miles. The Agency may approve procurement of in-use verification test vehicles that have a lower minimum odometer reading based on such data.

(iii) The provisions of § 86.1845–04(c)(2) that require one vehicle of each test group during high mileage in-use verification testing to have a minimum odometer mileage do not apply.

(iv) Manufacturers intending to use the provisions of this paragraph (c) shall submit to the Agency a plan detailing how these provisions will be met before submitting an application for certification for the subject vehicles.

(d) *Operationally independent manufacturers.* Manufacturers may submit an application to EPA requesting treatment as an operationally independent manufacturer. A manufacturer that is granted operationally independent status may qualify for all the regulatory provisions of this subpart that apply for small-volume manufacturers on the basis of its own vehicle production and/or sales volumes, and would not require aggregation with related manufacturers. In this paragraph (d), the term “related manufacturer(s)” means manufacturers that would qualify for aggregation under the requirements of paragraph (b)(3) of this section.

\* \* \* \* \*

■ 195. Section 86.1843–01 is amended by revising paragraph (g) to read as follows:

**§ 86.1843–01 General information requirements.**

\* \* \* \* \*

(g) *Recordkeeping.* (1) This subpart includes various requirements to record data or other information. Unless we specify otherwise, store these records in any format and on any media and keep them readily available for eight years after you send an associated application for certification, or eight years after you generate the data if they do not support an application for certification. You must promptly send us organized, written records in English upon request. We may review them at any time.

(2) Upon written request by the Administrator, a manufacturer shall submit any information as described in § 86.1844–01 within 15 business days. A manufacturer may request the Administrator to grant an extension. The request must clearly indicate the

circumstances necessitating the extension.

\* \* \* \* \*

■ 196. Section 86.1844–01 is amended by revising paragraphs (a), (d)(7), (d)(8), (d)(9), (d)(11), and (d)(16)(i) introductory text, removing paragraph (d)(16)(iv), and adding paragraph (e)(7) to read as follows:

**§ 86.1844–01 Information requirements: Application for certification and submittal of information upon request.**

(a) All the information listed in this section must be submitted to the Agency according to the requirements specified in § 86.1843; however, we may ask you to include less information than we specify, as long as you keep the specified records.

\* \* \* \* \*

(d) \* \* \*

(7) A comprehensive list of all test results, including official certification levels, and the applicable intermediate and full useful life emission standards to which the test group is to be certified as required in § 86.1829. Include the following additional information related to testing:

(i) Include a comparison of drive cycle energy and target cycle energy relative to both inertia and road load forces as specified in 40 CFR 1066.425 for each drive cycle or test phase, as appropriate.

(ii) For gasoline-fueled Tier 3 vehicles, identify the method of accounting for ethanol in determining evaporative emissions, as described in § 86.1813.

(iii) Identify any aspects of testing for which the regulations obligate EPA testing to conform to your selection of test methods.

(8) A statement that all applicable vehicles will conform to the emission standards for which emission data is not being provided, as allowed under § 86.1806 or § 86.1829. The statement shall clearly identify the standards for which emission testing was not completed.

(9) Information describing each emission control diagnostic system required by § 86.1806, including all of the following:

(i) A description of the functional operation characteristics of the diagnostic system, with additional information demonstrating that the system meets the requirements specified in § 86.1806. Include all testing and demonstration data submitted to the California Air Resources Board for certification.

(ii) The general method of detecting malfunctions for each emission-related powertrain component.

(iii) Any deficiencies, including resolution plans and schedules.

(iv) A statement that the diagnostic system is adequate for the performance warranty test described in 40 CFR Part 85, subpart W.

(v) For vehicles certified to meet the leak standard in § 86.1813, a description of the anticipated test procedure. The description must include, at a minimum, a method for accessing the fuel system for measurements and a method for pressurizing the fuel system to perform the procedure specified in 40 CFR 1066.985. The recommended test method must include at least two separate points for accessing the fuel system, with additional access points as appropriate for multiple fuel tanks and multiple evaporative or refueling canisters.

\* \* \* \* \*

(11) A list of all auxiliary emission control devices (AECD) installed on any applicable vehicles, including a justification for each AECD, the parameters they sense and control, a detailed justification of each AECD that results in a reduction in effectiveness of the emission control system, and rationale for why it is not a defeat device as defined under § 86.1809. The following specific provisions apply for AECDs:

(i) For any AECD uniquely used at high altitudes, EPA may request engineering emission data to quantify any emission impact and validity of the AECD.

(ii) For any AECD uniquely used on multi-fuel vehicles when operated on fuels other than gasoline, EPA may request engineering emission data to quantify any emission impact and validity of the AECD.

(iii) For Tier 3 vehicles with spark-ignition engines, describe how AECDs are designed to comply with the requirements of § 86.1811–17(d). Identify which components need protection through enrichment strategies; describe the temperature limitations for those components; and describe how the enrichment strategy corresponds to those temperature limitations. We may also require manufacturers to submit this information for certification related to Tier 2 vehicles.

\* \* \* \* \*

(16) \* \* \*

(i) A statement indicating that the manufacturer has conducted an engineering analysis of the complete exhaust system to ensure that the exhaust system has been designed–

\* \* \* \* \*

(e) \* \* \*

(7) The results of any production vehicle evaluation testing required for OBD systems under § 86.1806.

\* \* \* \* \*

**§ 86.1845–01 [Removed]**

■ 197. Remove § 86.1845–01.

■ 198. Section 86.1845–04 is amended by revising paragraphs (a)(1), (a)(3), (b)(3) introductory text, (b)(4), (b)(5), (b)(6), (b)(7), (c), and (f) to read as follows:

**§ 86.1845–04 Manufacturer in-use verification testing requirements.**

(a) \* \* \*

(1) Manufacturers of LDV, LDT, MDPV and complete HDV must test, or cause to have tested, a specified number of vehicles. Such testing must be conducted in accordance with the provisions of this section.

\* \* \* \* \*

(3) The following provisions apply regarding the possibility of residual effects from varying fuel sulfur levels:

(i) Vehicles certified to Tier 3 standards under § 86.1811 must always measure emissions over the FTP, then over the HFET (if applicable), then over the US06 portion of the SFTP. If a Tier 3 vehicle meets all the applicable emission standards except the FTP or HFET emission standard for NMOG+NO<sub>x</sub>, and a fuel sample from the tested vehicle (representing the as-received condition) has a measured fuel sulfur level exceeding 15 ppm when measured as described in 40 CFR 1065.710, the manufacturer may repeat the FTP and HFET measurements and use the new emission values as the official results for that vehicle. For all other cases of testing Tier 3 vehicles, measured emission levels from the first test will be considered the official results for the test vehicle, regardless of any test results from additional test runs. Where repeat testing is allowed, the vehicle may operate for up to two US06 cycles (with or without measurement) before repeating the FTP and HFET measurements. The repeat measurements must include both FTP and HFET, even if the vehicle failed only one of those tests, unless the HFET is not required for a particular vehicle. Tier 3 vehicles may not undergo any other vehicle preconditioning to eliminate fuel sulfur effects on the emission control system, unless we approve it in advance.

(ii) Upon a manufacturer's written request, prior to in-use testing, that presents information to EPA regarding pre-conditioning procedures designed solely to remove the effects of high sulfur in gasoline from vehicles

produced through the 2007 model year, EPA will consider allowing such procedures on a case-by-case basis.

EPA's decision will apply to manufacturer in-use testing conducted under this section and to any in-use testing conducted by EPA. Such procedures are not available for complete HDV. For model year 2007 and later Tier 2 vehicles, this provision can be used only in American Samoa, Guam, and the Commonwealth of the Northern Mariana Islands, and then only if low sulfur gasoline is determined by the Administrator to be unavailable in that specific location.

(b) \* \* \*

(3) *Number of test vehicles.* For each test group, the minimum number of vehicles that must be tested is specified in Table S04-06 and Table S04-07 of this paragraph (b)(3). After testing the minimum number of vehicles of a specific test group as specified in Table S04-06 or S04-07 of this paragraph (b)(3), a manufacturer may test additional vehicles upon request and approval by the Agency prior to the initiation of the additional testing. Any additional testing must be completed within the testing completion requirements shown in § 86.1845-04(b)(4). The request and Agency approval (if any) shall apply to test groups on a case by case basis and apply only to testing under this paragraph. Separate approval will be required to test additional vehicles under paragraph (c) of this section. In addition to any testing that is required under Table S04-06 and Table S04-07, a manufacturer shall test one vehicle from each evaporative/refueling family for evaporative/refueling emissions. If a manufacturer believes it is unable to procure the test vehicles necessary to test the required number of vehicles in a test group, the manufacturer may request, subject to Administrator approval, a decreased sample size for that test group. The request shall include a description of the methods the manufacturer has used to procure the required number of vehicles. The approval of any such request, and the substitution of an alternative sample size requirement for the test group, will be based on a review of the procurement efforts made by the manufacturer to determine if all reasonable steps have been taken to procure the required test group size. Tables S04-06 and S04-07 follow:

\* \* \* \* \*

(4) *Completion of testing.* Testing of the vehicles in a test group and evaporative/refueling family must be completed within 12 months of the end

of production of that test group (or evaporative/refueling family) for that model year.

(5) *Testing.* (i) Each test vehicle of a test group shall be tested in accordance with the FTP and the US06 portion of the SFTP as described in subpart B of this part, when such test vehicle is tested for compliance with applicable exhaust emission standards under this subpart. Test vehicles subject to applicable exhaust CO<sub>2</sub> emission standards under this subpart shall also be tested in accordance with the HFET as described in part 600, subpart B, of this chapter.

(ii) Manufacturers must measure PM emissions over the FTP and US06 driving schedules for at least 50 percent of the vehicles tested under paragraph (b)(5)(i) of this section.

(iii) Starting with model year 2018 vehicles, manufacturers must demonstrate compliance with the Tier 3 leak standard specified in § 86.1813, if applicable, as described in this paragraph (b)(5)(iii). Manufacturers must evaluate each vehicle tested under paragraph (b)(5)(i) of this section, except that leak testing is not required for vehicles tested under paragraph (b)(5)(iv) of this section for diurnal emissions. In addition, manufacturers must evaluate at least one vehicle from each leak family for a given model year. Manufacturers may rely on OBD monitoring instead of testing as follows:

(A) A vehicle is considered to pass the leak test if the OBD system completed a leak check within the previous 750 miles of driving without showing a leak fault code.

(B) Whether or not a vehicle's OBD system has completed a leak check within the previous 750 miles of driving, the manufacturer may operate the vehicle as needed to force the OBD system to perform a leak check. If the OBD leak check does not show a leak fault, the vehicle is considered to pass the leak test.

(C) If the most recent OBD leak check from paragraph (b)(5)(iii)(A) or (B) of this section shows a leak-related fault code as specified in § 86.1806-17(b), the vehicle is presumed to have failed the leak test. Manufacturers may perform the leak measurement procedure described in 40 CFR 1066.985 for an official result to replace the finding from the OBD leak check.

(D) Manufacturers may not perform repeat OBD checks or leak measurements to over-ride a failure under paragraph (b)(5)(iii)(C) of this section.

(iv) For nongaseous-fueled vehicles, one test vehicle of each evaporative/refueling family shall be tested in

accordance with the supplemental 2-diurnal-plus-hot-soak evaporative emission and refueling emission procedures described in subpart B of this part, when such test vehicle is tested for compliance with applicable evaporative emission and refueling standards under this subpart. For gaseous-fueled vehicles, one test vehicle of each evaporative/refueling family shall be tested in accordance with the 3-diurnal-plus-hot-soak evaporative emission and refueling emission procedures described in subpart B of this part, when such test vehicle is tested for compliance with applicable evaporative emission and refueling standards under this subpart. The test vehicles tested to fulfill the evaporative/refueling testing requirement of this paragraph (b)(5)(ii) will be counted when determining compliance with the minimum number of vehicles as specified in Table S04-06 and Table S04-07 in paragraph (b)(3) of this section for testing under paragraph (b)(5)(i) of this section only if the vehicle is also tested for exhaust emissions under the requirements of paragraph (b)(5)(i) of this section.

(6) Each test vehicle not rejected based on the criteria specified in appendix II to this subpart shall be tested in as-received condition.

(7) A manufacturer may conduct subsequent diagnostic maintenance and/or testing of any vehicle. Any such maintenance and/or testing shall be reported to the Agency as specified in § 86.1847.

(c) *High-mileage testing*—(1) *Test groups.* Testing must be conducted for each test group.

(2) *Vehicle mileage.* All test vehicles must have a minimum odometer mileage of 50,000 miles. At least one vehicle of each test group must have a minimum odometer mileage of 105,000 miles or 75 percent of the full useful life mileage, whichever is less. See § 86.1838-01(c)(2) for small-volume manufacturer mileage requirements.

(3) *Number of test vehicles.* For each test group, the minimum number of vehicles that must be tested is specified in Table S04-06 and Table S04-07 in paragraph (b)(3) of this section. After testing the minimum number of vehicles of a specific test group as specified in Table S04-06 and Table S04-07 in paragraph (b)(3) of this section, a manufacturer may test additional vehicles upon request and approval by the Agency prior to the initiation of the additional testing. Any additional testing must be completed within the testing completion requirements shown in § 86.1845-04(c)(4). The request and Agency approval (if any) shall apply to

test groups on a case by case basis and apply only to testing under this paragraph (c). In addition to any testing that is required under Table S04–06 and Table S04–07, a manufacturer shall test one vehicle from each evaporative/refueling family for evaporative/refueling emissions. If a manufacturer believes it is unable to procure the test vehicles necessary to test the required number of vehicles in a test group as specified in Table S04–06 or Table S04–07, the manufacturer may request, subject to Administrator approval, a decreased sample size for that test group. The request shall include a description of the methods the manufacturer has used to procure the required number of vehicles. The approval of any such request, and the substitution of an alternative sample size requirement for the test group, will be based on a review of the procurement efforts made by the manufacturer to determine if all reasonable steps have been taken to procure the required test group size.

(4) *Initiation and completion of testing.* Testing of a test group (or evaporative refueling family) must commence within 4 years of the end of production of the test group (or evaporative/refueling family) and be completed within 5 years of the end of production of the test group (or evaporative/refueling family).

(5) *Testing.* (i) Each test vehicle shall be tested in accordance with the FTP and the US06 portion of the SFTP as described in subpart B of this part when such test vehicle is tested for compliance with applicable exhaust emission standards under this subpart. Test vehicles subject to applicable exhaust CO<sub>2</sub> emission standards under this subpart shall also be tested in accordance with the HFET as described in 40 CFR part 600, subpart B. One test vehicle from each test group shall be tested over the FTP at high altitude. The test vehicle tested at high altitude is not required to be one of the same test vehicles tested at low altitude. The test vehicle tested at high altitude is counted when determining the compliance with the requirements shown in Table S04–06 and Table S04–07 in paragraph (b)(3) of this section or the expanded sample size as provided for in this paragraph (c).

(ii) Manufacturers must measure PM emissions over the FTP and US06 driving schedules for at least 50 percent of the vehicles tested under paragraph (c)(5)(i) of this section.

(iii) Starting with model year 2018 vehicles, manufacturers must evaluate each vehicle tested under paragraph (c)(5)(i) of this section to demonstrate

compliance with the Tier 3 leak standard specified in § 86.1813, except that leak testing is not required for vehicles tested under paragraph (c)(5)(iv) of this section for diurnal emissions. In addition, manufacturers must evaluate at least one vehicle from each leak family for a given model year. Manufacturers may rely on OBD monitoring instead of testing as described in paragraph (c)(5)(iii) of this section.

(iv) For nongaseous-fueled vehicles, one test vehicle of each evaporative/refueling family shall be tested in accordance with the supplemental 2-diurnal-plus-hot-soak evaporative emission procedures described in subpart B of this part, when such test vehicle is tested for compliance with applicable evaporative emission and refueling standards under this subpart. For gaseous-fueled vehicles, one test vehicle of each evaporative/refueling family shall be tested in accordance with the 3-diurnal-plus-hot-soak evaporative emission procedures described in subpart B of this part, when such test vehicle is tested for compliance with applicable evaporative emission and refueling standards under this subpart. The test vehicles tested to fulfill the evaporative/refueling testing requirement of this paragraph (b)(5)(ii) will be counted when determining compliance with the minimum number of vehicles as specified in Table S04–06 and table S04–07 in paragraph (b)(3) of this section for testing under paragraph (b)(5)(i) of this section only if the vehicle is also tested for exhaust emissions under the requirements of paragraph (b)(5)(i) of this section.

(6) *Test condition.* Each test vehicle not rejected based on the criteria specified in appendix II to this subpart shall be tested in as-received condition.

(7) *Diagnostic maintenance.* A manufacturer may conduct subsequent diagnostic maintenance and/or testing on any vehicle. Any such maintenance and/or testing shall be reported to the Agency as specified in § 86.1847–01.

\* \* \* \* \*

(f)(1) A manufacturer must conduct in-use testing on a test group by determining NMOG exhaust emissions as described in 40 CFR 1066.635.

(2) For flexible-fueled vehicles certified to NMOG (or NMOG+NO<sub>x</sub>) standards, the manufacturer may ask for EPA approval to demonstrate compliance using an equivalent NMOG emission result calculated from a ratio of ethanol NMOG exhaust emissions to gasoline NMHC exhaust emissions. Ethanol NMOG exhaust emissions are measured values from testing with the

ethanol test fuel, expressed as NMOG. Gasoline NMHC exhaust emissions are measured values from testing with the gasoline test fuel, expressed as NMHC. This ratio must be established during certification for each emission-data vehicle for the applicable test group. Use good engineering judgment to establish a different ratio for each duty cycle or test interval as appropriate. Identify the ratio values you develop under this paragraph (f)(1) and describe the duty cycle or test interval to which they apply in the Part II application for certification. Calculate the equivalent NMOG emission result by multiplying the measured gasoline NMHC exhaust emissions for a given duty cycle or test interval by the appropriate ratio.

(3) If the manufacturer measures NMOG as described in 40 CFR 1066.635(a), it must also measure and report HCHO emissions. As an alternative to measuring the HCHO content, if the manufacturer measures NMOG as permitted in 40 CFR 1066.635(c), the Administrator may approve, upon submission of supporting data by a manufacturer, the use of HCHO to NMHC ratios. To request the use of HCHO to NMHC ratios, the manufacturer must establish during certification testing the ratio of measured HCHO exhaust emissions to measured NMHC exhaust emissions for each emission-data vehicle for the applicable test group. The results must be submitted to the Administrator with the Part II application for certification. Following approval of the application for certification, the manufacturer may conduct in-use testing on the test group by measuring NMHC exhaust emissions rather than HCHO exhaust emissions. The measured NMHC exhaust emissions must be multiplied by the HCHO to NMHC ratio submitted in the application for certification for the test group to determine the equivalent HCHO exhaust emission values for the test vehicle. The equivalent HCHO exhaust emission values must be compared to the HCHO exhaust emission standard applicable to the test group.

■ 199. Section 86.1846–01 is revised to read as follows:

**§ 86.1846–01 Manufacturer in-use confirmatory testing requirements.**

(a) *General requirements.* (1) Manufacturers must test, or cause testing to be conducted, under this section when the emission levels shown by a test group sample from testing under § 86.1845 exceeds the criteria specified in paragraph (b) of this section. The testing required under this section applies separately to each test



group and at each test point (low and high mileage) that meets the specified criteria. The testing requirements apply separately for each model year. These provisions apply to heavy-duty vehicles starting with model year 2007. These provisions do not apply to emissions of CO<sub>2</sub>, CH<sub>4</sub>, and N<sub>2</sub>O.

(2) The provisions of § 86.1845–04(a)(3) regarding fuel sulfur effects apply equally to testing under this section.

(b) *Criteria for additional testing.* (1) A manufacturer shall test a test group or a subset of a test group as described in paragraph (j) of this section when the results from testing conducted under § 86.1845 show mean exhaust emissions for that test group of any pollutant(s) (except CO<sub>2</sub>, CH<sub>4</sub>, and N<sub>2</sub>O) to be equal to or greater than 1.30 times the applicable in-use standard and a failure rate, among the test group vehicles, for the corresponding pollutant(s) of fifty percent or greater.

(i) Additional testing is not required under this paragraph (b)(1) based on Supplemental FTP testing or evaporative/refueling testing. Testing conducted at high altitude under the requirements of § 86.1845–04(b) will be included in determining if a test group meets the criteria triggering testing required under this section.

(ii) The vehicle tested under the requirements of § 86.1845–04(c)(2) with a minimum odometer miles of 75% of useful life will not be included in determining if a test group meets the triggering criteria.

(iii) The SFTP composite emission levels shall include the IUVF FTP emissions, the IUVF US06 emissions, and the values from the SC03 Air Conditioning EDV certification test (without DFs applied). The calculations shall be made using the equations prescribed in § 86.164. If more than one set of certification SC03 data exists (due to running change testing or other reasons), the manufacturer shall choose the SC03 result to use in the calculation from among those data sets using good engineering judgment.

(2) If fewer than 50 percent of the vehicles from a leak family pass either the leak test or the diurnal test under § 86.1845, EPA may require further leak testing under this paragraph (b)(2). Testing under this section must include five vehicles from the family. If all five of these vehicles fail the test, the manufacturer must test five additional vehicles.

EPA will determine whether to require further leak testing under this section after providing the manufacturer an opportunity to discuss the results, including consideration of any of the

following information, or other items that may be relevant:

(i) Detailed system design, calibration, and operating information, technical explanations as to why the individual vehicles tested failed the leak standard.

(ii) Comparison of the subject vehicles to other similar models from the same manufacturer.

(iii) Data or other information on owner complaints, technical service bulletins, service campaigns, special policy warranty programs, warranty repair data, state I/M data, and data available from other manufacturer-specific programs or initiatives.

(iv) Evaporative emission test data on any individual vehicles that did not pass leak testing during IUVF.

(c) *Useful life.* Vehicles tested under the provisions of this section must be within the useful life specified for the emission standards which were exceeded in the testing under § 86.1845. Testing should be within the useful life specified, subject to sections 207(c)(5) and (c)(6) of the Clean Air Act where applicable.

(d) *Number of test vehicles.* A manufacturer must test a minimum of ten vehicles of the test group or Agency-designated subset. A manufacturer may, at the manufacturer's discretion, test more than ten vehicles under this paragraph for a specific test group or Agency-designated subset. If a manufacturer chooses to test more than the required ten vehicles, all testing must be completed within the time designated in the testing completion requirements of paragraph (g) of this section. Any vehicles which are eliminated from the sample either prior to or subsequent to testing, or any vehicles for which test results are determined to be void, must be replaced in order that the final sample of vehicles for which test results acceptable to the Agency are available equals a minimum of ten vehicles. A manufacturer may cease testing with a sample of five vehicles if the results of the first five vehicles tested show mean emissions for each pollutant to be less than 75.0 percent of the applicable standard, with no vehicles exceeding the applicable standard for any pollutant.

(e) *Emission testing.* Each test vehicle of a test group or Agency-designated subset shall be tested in accordance with the FTP and/or the SFTP (whichever of these tests performed under § 86.1845 produces emission levels requiring testing under this section) as described in subpart B of this part, when such test vehicle is tested for compliance with applicable exhaust emission standards under this subpart.

(f) *Geographical limitations.* (1) Test groups or Agency-designated subsets certified to 50-state standards: For low altitude testing no more than 50 percent of the test vehicles may be procured from California. The test vehicles procured from the 49 state area must be procured from a location with a heating degree day 30 year annual average equal to or greater than 4000.

(2) Test groups or Agency-designated subsets certified to 49 state standards: For low-altitude testing all vehicles shall be procured from a location with a heating degree day 30 year annual average equal to or greater than 4000.

(3) Vehicles procured for high altitude testing may be procured from any area provided that the vehicle's primary area of operation was above 4000 feet.

(g) *Testing.* Testing required under this section must commence within three months of completion of the testing under § 86.1845 which triggered the confirmatory testing and must be completed within seven months of the completion of the testing which triggered the confirmatory testing. Any industry review of the results obtained under § 86.1845 and any additional vehicle procurement and/or testing which takes place under the provisions of § 86.1845 which the industry believes may affect the triggering of required confirmatory testing must take place within the three month period. The data and the manufacturers reasoning for reconsideration of the data must be provided to the Agency within the three month period.

(h) *Limit on manufacturer conducted testing.* For each manufacturer, the maximum number of test group(s) (or Agency-designated subset(s)) of each model year for which testing under this section shall be required is limited to 50 percent of the total number of test groups of each model year required to be tested by each manufacturer as prescribed in § 86.1845, rounded to the next highest whole number where appropriate. For each manufacturer with only one test group under § 86.1845, such manufacturer shall have a maximum potential testing requirement under this section of one test group (or Agency-designated subset) per model year.

(i) *Testing plan.* Prior to beginning in-use confirmatory testing the manufacturer must, after consultation with the Agency, submit a written plan describing the details of the vehicle procurement, maintenance, and testing procedures (not otherwise specified by regulation) it intends to use. EPA must approve the test plan before the manufacturer may start further testing.

(j) *Testing a subset.* EPA may designate a subset of the test group based on transmission type for testing under this section in lieu of testing the entire test group when the results for the entire test group from testing conducted under § 86.1845 show mean emissions and a failure rate which meet these criteria for additional testing.

■ 200. Section 86.1848–10 is amended by revising paragraph (c)(7) to read as follows:

**§ 86.1848–10 Compliance with emission standards for the purpose of certification.**

\* \* \* \* \*

(c) \* \* \*

(7) All certificates of conformity issued are conditional upon compliance with all the provisions of §§ 86.1811 through 86.1816 and §§ 86.1860 through 86.1862 both during and after model year production. The manufacturer bears the burden of establishing to the satisfaction of the Administrator that the terms and conditions upon which each certificate was issued were satisfied. For recall and warranty purposes, vehicles

not covered by a certificate of conformity will continue to be held to the standards stated or referenced in the certificate that otherwise would have applied to the vehicles.

(i) Failure to meet the applicable fleet average standard will be considered to be a failure to satisfy the terms and conditions upon which the certificate was issued and the vehicles sold in violation of the fleet average standard will not be covered by the certificate.

(ii) Failure to comply fully with the prohibition against selling credits that it has not generated or that are not available, as specified in § 86.1861, will be considered a failure to satisfy the terms and conditions upon which the certificate was issued and the vehicles sold in violation of this prohibition will not be covered by the certificate.

(iii) Failure to comply fully with the phase-in requirements of §§ 86.1811 through 86.1816 will be considered a failure to satisfy the terms and conditions upon which the certificate was issued and the vehicles sold that do

not comply with the applicable standards, up to the number needed to comply, will not be covered by the certificate.

\* \* \* \* \*

■ 201. A new § 86.1860–17 is added to subpart S to read as follows:

**§ 86.1860–17 How to comply with the Tier 3 fleet-average standards.**

(a) You must show that you meet the applicable fleet-average NMOG+NO<sub>x</sub> standards from §§ 86.1811 and 86.1816 and the fleet-average evaporative emission standards from § 86.1813 as described in this section. Note that separate fleet-average calculations are required for the FTP and SFTP exhaust emission standards under § 86.1811.

(b) Calculate your fleet-average value for each model year for all vehicle models subject to a separate fleet-average standard using the following equation, rounded to the nearest 0.001 g/mile for NMOG+NO<sub>x</sub> emissions and the nearest 0.001 g/test for evaporative emissions:

$$\text{Fleet average value} = \frac{\sum_{i=1}^b (N_i \cdot FEL_i)}{N_{\text{total}}}$$

Where:

*i* = A counter associated with each separate Tier 3 test group or evaporative family.

*b* = The number of separate Tier 3 test groups or evaporative families from a given averaging set to which you certify your vehicles.

*N<sub>i</sub>* = The actual nationwide sales for the model year for test group or evaporative family *i*. Include allowances for evaporative emissions as described in § 86.1813.

*FEL<sub>i</sub>* = The FEL selected for test group or evaporative family *i*. Disregard any separate standards that apply for in-use testing or for testing under high-altitude conditions.

*N<sub>total</sub>* = The actual nationwide sales for the model year for all your Tier 3 vehicles from the averaging set, except as described in paragraph (c) of this section. The pool of vehicle models included in *N<sub>total</sub>* may vary by model year, and it may be different for evaporative standards, FTP exhaust standards, and SFTP exhaust standards in a given model year.

(c) Do not include any of the following vehicles to calculate your fleet-average value:

(1) Vehicles that you do not certify to the standards of this part because they are permanently exempted under 40 CFR part 85 or part 1068.

(2) Exported vehicles.

(3) Vehicles excluded under § 86.1801.

(4) For model year 2017, do not include vehicle sales in California or the section 177 states for calculating the fleet average value for evaporative emissions.

(d) Except as specified in paragraph (e) of this section, your calculated fleet-average value may not exceed the corresponding fleet-average standard for the model year.

(e) You may generate or use emission credits related to your calculated fleet-average value as follows:

(1) You may generate emission credits as described in § 86.1861 if your fleet-average value is below the corresponding fleet-average standard.

(2) You may use emission credits as described in § 86.1861 if your fleet-average value is above the corresponding fleet-average standard. Except as specified in paragraph (e)(3) of this section, you must use enough credits for each model year to show that your adjusted fleet average value does not exceed the fleet-average standard.

(3) The following provisions apply if you do not have enough emission credits to demonstrate compliance with a fleet-average standard in a given model year:

(i) You may have a credit deficit for up to three model years within an averaging set under § 86.1861–17(c). You may not bank emission credits with respect to a given emission standard during a model year in which you have a credit deficit in the same averaging set. If you fail to meet the fleet-average standard for four consecutive model years, the vehicles causing you to exceed the fleet-average standard will be considered not covered by the certificate of conformity. You will be subject to penalties on an individual-vehicle basis for sale of vehicles not covered by a certificate of conformity.

(ii) You must notify us in writing how you plan to eliminate the credit deficit within the specified time frame. If we determine that your plan is unreasonable or unrealistic, we may deny an application for certification for a test group or evaporative family if its bin standard or FEL would increase your credit deficit. We may determine that your plan is unreasonable or unrealistic based on a consideration of past and projected use of specific technologies, the historical sales mix of your vehicle models, your commitment to limit sales of higher-emission vehicles, and expected access to traded

credits. We may also consider your plan unreasonable if your fleet-average emission level increases relative to the first model year of a credit deficit or any later model year. We may require that you send us interim reports describing your progress toward resolving your credit deficit over the course of a model year.

(f) If the applicable bin standards and FELs for all your vehicle models are at or below a corresponding fleet-average standard for a given model year, and you do not want to generate emission credits, you may omit the calculations described in this section.

(g) For purposes of calculating the statute of limitations, the following actions are all considered to occur at the expiration of the deadline for offsetting a deficit as specified in paragraph (e)(3) of this section:

(1) Failing to meet the requirements of paragraph (e)(3) of this section.

(2) Failing to satisfy the conditions upon which a certificate was issued relative to offsetting a deficit.

(3) Selling, offering for sale, introducing or delivering into U.S. commerce, or importing vehicles that are found not to be covered by a certificate as a result of failing to offset a deficit.

■ 202. A new § 86.1861–17 is added to subpart S to read as follows:

**§ 86.1861–17 How do the NMOG+NO<sub>x</sub> and evaporative emission credit programs work?**

You may use emission credits for purposes of certification to show compliance with the applicable fleet-average NMOG+NO<sub>x</sub> standards from § 86.1811 and 86.1816 and the fleet-average evaporative emission standards from § 86.1813 as described in 40 CFR part 1037, subpart H, with certain exceptions and clarifications as specified in this section. MDPVs are subject to the same provisions of this section that apply to LDT4.

(a) Calculate emission credits as described in this paragraph (a) instead of using the provisions of 40 CFR 1037.705. Calculate positive or negative emission credits relative to the applicable fleet-average standard. Calculate positive emission credits if your fleet-average level is below the standard. Calculate negative emission credits if your fleet-average value is above the standard. Calculate credits separately for each type of standard and for each averaging set. Calculate emission credits using the following equation, rounded to the nearest whole number:

$$\text{Emission credit} = \text{Volume}[\text{Fleet average standard} - \text{Fleet average value}]$$

Where:

*Emission credit* = The positive or negative credit for each discrete fleet-average standard, in units of vehicle-grams per mile for NMOG+NO<sub>x</sub> and vehicle-grams per test for evaporative emissions.

*Volume* = Sales volume in a given model year from the collection of test groups or evaporative families covered by the fleet-average value, as described in § 86.1860.

(b) The following restrictions apply instead of those specified in 40 CFR 1037.740:

(1) Except as specified in paragraph (b)(3) of this section, emission credits may be exchanged only within an averaging set, as follows:

(i) HDV represent a separate averaging set with respect to all emission standards.

(ii) LDV and LDT certified to standards based on a useful life of 150,000 miles and 15 years together represent a single averaging set with respect to NMOG+NO<sub>x</sub> emission standards. Note that FTP and SFTP credits are not interchangeable.

(iii) LDV and LDT1 certified to standards based on a useful life of 120,000 miles and 10 years together represent a single averaging set with respect to NMOG+NO<sub>x</sub> emission standards. Note that FTP and SFTP credits are not interchangeable.

(iv) The following separate averaging sets apply for evaporative emission standards:

(A) LDV and LDT1 together represent a single averaging set.

(B) LDT2 represents a single averaging set.

(C) HLDT represents a single averaging set.

(D) HDV represents a single averaging set.

(2) You may exchange evaporative emission credits across averaging sets as follows if you need additional credits to offset a deficit after the final year of maintaining deficit credits as allowed under paragraph (c) of this section:

(i) You may exchange LDV/LDT1 and LDT2 emission credits.

(ii) You may exchange HLDT and HDV emission credits.

(3) Except as specified in paragraph (b)(4) of this section, credits expire after five years. For example, credits you generate in model year 2018 may be used only through model year 2023.

(4) For the Tier 3 declining fleet-average FTP and SFTP emission standards for NMOG+NO<sub>x</sub> described in § 86.1811–17(b)(8), credits generated in model years 2017 through 2024 expire after eight years, or after model year 2030, whichever comes first; however, these credits may not be traded after five years. This extended credit life also

applies for small-volume manufacturers generating credits under § 86.1811–17(h)(1) in model years 2022 through 2024. Note that the longer credit life does not apply for heavy-duty vehicles, for vehicles certified under the alternate phase-in described in § 86.1811–17(b)(9), or for vehicles generating early Tier 3 credits under § 86.1811–17(b)(11) in model year 2017.

(c) The credit-deficit provisions 40 CFR 1037.745 apply to the NMOG+NO<sub>x</sub> and evaporative emission standards for Tier 3 vehicles.

(d) The reporting and recordkeeping provisions of § 86.1862 apply instead of those specified in 40 CFR 1037.730 and 1037.735.

(e) The provisions of 40 CFR 1037.645 do not apply.

■ 203. Section 86.1862–04 is revised to read as follows:

**§ 86.1862–04 Maintenance of records and submittal of information relevant to compliance with fleet-average standards.**

(a) *Overview.* This section describes reporting and recordkeeping requirements for vehicles subject to the following standards:

(1) Tier 2 NO<sub>x</sub> emission standard for LDV and LDT in § 86.1811–04.

(2) Tier 3 FTP emission standard for NMOG+NO<sub>x</sub> for LDV and LDT in § 86.1811.

(3) Tier 3 SFTP emission standard for NMOG+NO<sub>x</sub> for LDV and LDT (including MDPV) in § 86.1811.

(4) Tier 3 evaporative emission standards in § 86.1813.

(5) Tier 3 FTP emission standard for NMOG+NO<sub>x</sub> for HDV (other than MDPV) in § 86.1816.

(6) Cold temperature NMHC standards in § 86.1811.

(b) *Maintenance of records.* (1) The manufacturer producing any vehicles subject to a fleet-average standard under this subpart must establish and maintain all the following information in organized and indexed records for each model year:

(i) Model year.

(ii) Applicable fleet-average standard.

(iii) Calculated fleet-average value.

(iv) All values used in calculating the fleet-average value achieved.

(2) The manufacturer producing any vehicle subject to the provisions in this section must keep all the following information for each vehicle:

(i) Model year.

(ii) Applicable fleet-average standard.

(iii) EPA test group or evaporative family, as applicable.

(iv) Assembly plant.

(v) Vehicle identification number.

(vi) The FEL and the fleet-average standard to which the vehicle is certified.

(vii) Information on the point of first sale, including the purchaser, city, and state.

(3) The manufacturer must retain all records required to be maintained under this section for a period of eight years from the due date for the annual report. Records may be stored in any format and on any media, as long as manufacturers can promptly send EPA organized written records in English if we ask for them. Manufacturers must keep records readily available as EPA may review them at any time.

(4) The Administrator may require the manufacturer to retain additional records or submit information not specifically required by this section.

(5) EPA may void ab initio a certificate of conformity for a vehicle certified to emission standards as set forth or otherwise referenced in this subpart for which the manufacturer fails to retain the records required in this section, to provide such information to the Administrator upon request, or to submit the reports required in this section in the specified time period.

(c) *Reporting.* (1) Each manufacturer must submit an annual report. Except as provided in paragraph (b)(2) of this section, the annual report must contain, for each applicable fleet average standard, the fleet average value achieved, all values required to calculate the fleet-average value, the number of credits generated or debits incurred, all the values required to calculate the credits or debits, and sufficient information to show compliance with all phase-in requirements, if applicable. The annual report must also contain the resulting balance of credits or debits.

(2) When a manufacturer calculates compliance with the fleet-average standard using the provisions in § 86.1860–04(c)(2) or § 86.1860–17(f), the annual report must state that the manufacturer has elected to use such provision and must contain the fleet-average standard as the fleet-average value for that model year.

(3) For each applicable fleet-average standard, the annual report must also include documentation on all credit transactions the manufacturer has engaged in since those included in the last report. Information for each transaction must include all the following information:

- (i) Name of credit provider.
- (ii) Name of credit recipient.
- (iii) Date the transfer occurred.
- (iv) Quantity of credits transferred.
- (v) Model year in which the credits were earned.

(4) Unless a manufacturer reports the data required by this section in the

annual production report required under § 86.1844–01(e) and subsequent model year provisions, a manufacturer must submit an annual report for each model year after production ends for all affected vehicles produced by the manufacturer subject to the provisions of this subpart and no later than May 1 of the calendar year following the given model year. Annual reports must be submitted to: Director, Compliance Division, U.S. Environmental Protection Agency, 2000 Traverwood, Ann Arbor, Michigan 48105.

(5) Failure by a manufacturer to submit the annual report in the specified time period for all vehicles subject to the provisions in this section is a violation of Clean Air Act section 203(a)(1) (42 U.S.C 7522(a)(1)) for each subject vehicle produced by that manufacturer.

(6) If EPA or the manufacturer determines that a reporting error occurred on an annual report previously submitted to EPA, the manufacturer's credit or debit calculations will be recalculated. EPA may void erroneous credits, unless transferred, and must adjust erroneous debits. In the case of transferred erroneous credits, EPA must adjust the selling manufacturer's credit or debit balance to reflect the sale of such credits and any resulting generation of debits.

(d) *Notice of opportunity for hearing.* Any voiding of the certificate under paragraph (a)(6) of this section will be made only after EPA has offered the manufacturer concerned an opportunity for a hearing conducted in accordance with § 86.614 for light-duty vehicles and light-duty trucks and with 40 CFR part 1068, subpart G, for heavy-duty vehicles.

■ 204. Section 86.1863–07 is amended by revising the section heading and adding introductory text to read as follows:

**§ 86.1863–07 Optional chassis certification for diesel vehicles.**

This section does not apply for vehicles certified to the Tier 3 standards in § 86.1816–18, including those vehicles that certify to the Tier 3 standards before model year 2018.

\* \* \* \* \*

■ 205. Section 86.1864–10 is amended by revising paragraph (p) to read as follows:

**§ 86.1864–10 How to comply with the fleet average cold temperature NMHC standards.**

\* \* \* \* \*

(p) *Reporting and recordkeeping.* Keep records and submit information for demonstrating compliance with the

fleet average cold temperature NMHC standard as described in § 86.1862–04.

■ 206. Section 86.1868–12 is amended by revising paragraphs (f)(1) and (g)(1) to read as follows:

**§ 86.1868–12 CO<sub>2</sub> credits for improving the efficiency of air conditioning systems.**

\* \* \* \* \*

(f) \* \* \*

(1) The manufacturer shall perform the AC17 test specified in 40 CFR 1066.845 on each unique air conditioning system design and vehicle platform combination for which the manufacturer intends to accrue air conditioning efficiency credits. The manufacturer must test at least one unique air conditioning system within each vehicle platform in a model year, unless all unique air conditioning systems within a vehicle platform have been previously tested. A unique air conditioning system design is a system with unique or substantially different component designs or types and/or system control strategies (e.g., fixed displacement vs. variable displacement compressors, orifice tube vs. thermostatic expansion valve, single vs. dual evaporator, etc.). In the first year of such testing, the tested vehicle configuration shall be the highest production vehicle configuration within each platform. In subsequent model years the manufacturer must test other unique air conditioning systems within the vehicle platform, proceeding from the highest production untested system until all unique air conditioning systems within the platform have been tested, or until the vehicle platform experiences a major redesign. Whenever a new unique air conditioning system is tested, the highest production configuration using that system shall be the vehicle selected for testing. Air conditioning system designs which have similar cooling capacity, component types, and control strategies, yet differ in terms of compressor pulley ratios or condenser or evaporator surface areas will not be considered to be unique system designs. The test results from one unique system design may represent all variants of that design. Manufacturers must use good engineering judgment to identify the unique air conditioning system designs which will require AC17 testing in subsequent model years. Results must be reported separately for all four phases (two phases with air conditioning off and two phases with air conditioning on) of the test to the Environmental Protection Agency, and the results of the calculations required in 40 CFR 1066.845 must also be reported. In each subsequent model year

additional air conditioning system designs, if such systems exist, within a vehicle platform that is generating air conditioning credits must be tested using the AC17 procedure. When all unique air conditioning system designs within a platform have been tested, no additional testing is required within that platform, and credits may be carried over to subsequent model years until there is a significant change in the platform design, at which point a new sequence of testing must be initiated. No more than one vehicle from each credit-generating platform is required to be tested in each model year.

\* \* \* \* \*

(g) \* \* \*

(1) For each air conditioning system selected by the manufacturer to generate air conditioning efficiency credits, the manufacturer shall perform the AC17 Air Conditioning Efficiency Test Procedure specified in 40 CFR 1066.845, according to the requirements of this paragraph (g).

\* \* \* \* \*

■ 207. Appendix I to part 86 is amended by revising the appendix heading and the heading of paragraph (a), adding paragraph (a) introductory text and paragraphs (a)(1) through (3), revising paragraphs (b) and (c), and removing and reserving paragraph (d) to read as follows:

**Appendix I to Part 86—Dynamometer Schedules**

(a) *EPA light-duty urban dynamometer driving schedule (UDDS)*. This driving schedule is also known as the LA-4 cycle.

(1) The driving schedule in this paragraph (a) applies for light-duty vehicles, light-duty trucks, and heavy-duty vehicles certified under subpart S of this part.

(2) The driving schedule in this paragraph (a) applies for motorcycles with engine displacement at or above 170 cc. Calculate the speed-versus-time sequence in kilometers per hour by multiplying the listed speed by 1.6 and rounding to the nearest 0.1 kilometers per hour.

(3) The driving schedule follows:

\* \* \* \* \*

(b) *EPA driving schedule for motorcycles with engine displacement below 170 cc*. Use the driving schedule specified in paragraph (a)(2) of this appendix, except that the schedule specified in this paragraph (b) applies for the portion of the driving schedule from 164 to 332 seconds.

**SPEED VERSUS TIME SEQUENCE**

Time (sec.)	Speed (kph)
164	3.4
165	6.8
166	10.3
167	13.7
168	17.1
169	20.5
170	23.0
171	25.2
172	26.7
173	27.4
174	26.6
175	26.0
176	25.6
177	25.9
178	26.1
179	26.3
180	26.7
181	28.2
182	27.5
183	24.9
184	23.5
185	20.1
186	18.3
187	17.8
188	18.8
189	19.3
190	20.7
191	23.0
192	25.4
193	28.3
194	31.6
195	34.7
196	37.5
197	38.6
198	40.7
199	42.0
200	43.6
201	45.1
202	46.7
203	47.7
204	48.5
205	49.2
206	49.2
207	49.0
208	48.9
209	48.7
210	48.7
211	48.7
212	48.7
213	48.7
214	48.9
215	49.1
216	49.6
217	50.2
218	50.9
219	51.3
220	51.8
221	52.4
222	52.8
223	53.4
224	54.1
225	55.1
226	56.0
227	56.6
228	56.9
229	57.0
230	56.9
231	56.6
232	56.6
233	56.8
234	57.1

**SPEED VERSUS TIME SEQUENCE—  
Continued**

Time (sec.)	Speed (kph)
235	57.5
236	57.7
237	58.1
238	58.3
239	58.6
240	58.7
241	58.7
242	58.5
243	58.5
244	58.5
245	58.5
246	58.5
247	58.5
248	58.4
249	58.1
250	57.8
251	57.1
252	56.6
253	56.2
254	55.9
255	55.6
256	55.5
257	55.8
258	55.9
259	56.0
260	56.0
261	55.7
262	55.3
263	54.9
264	54.5
265	54.0
266	54.3
267	53.9
268	53.8
269	53.6
270	53.4
271	53.5
272	53.7
273	54.0
274	54.4
275	54.9
276	55.4
277	55.9
278	56.9
279	57.4
280	57.6
281	58.0
282	58.0
283	57.8
284	57.2
285	56.5
286	55.5
287	54.4
288	53.4
289	53.4
290	53.4
291	52.9
292	51.9
293	51.8
294	51.9
295	51.8
296	51.4
297	51.3
298	51.3
299	51.3
300	50.9
301	50.3
302	49.8
303	48.9
304	47.8

SPEED VERSUS TIME SEQUENCE— Continued		Time (sec.)	Speed (mph)	Time (sec.)	Speed (mph)
		33	11.1	106	0.0
		34	11.1	107	0.0
		35	13.1	108	0.4
305	46.6	36	15.0	109	1.2
306	45.4	37	16.9	110	1.9
307	44.1	38	16.9	111	3.8
308	43.0	39	16.1	112	7.7
309	41.8	40	15.7	113	11.5
310	39.9	41	15.4	114	14.6
311	38.3	42	15.0	115	18.0
312	36.5	43	13.8	116	21.5
313	35.0	44	10.8	117	25.0
314	33.7	45	8.4	118	28.4
315	32.6	46	6.1	119	30.7
316	31.7	47	4.2	120	31.9
317	31.6	48	3.5	121	32.3
318	31.1	49	3.5	122	32.3
319	30.0	50	1.5	123	31.9
320	28.5	51	0.0	124	30.3
321	25.7	52	0.0	125	28.0
322	22.3	53	0.0	126	24.2
323	20.8	54	0.0	127	20.0
324	19.8	55	0.0	128	16.1
325	19.2	56	0.0	129	11.5
326	17.6	57	0.0	130	8.1
327	16.1	58	0.0	131	5.0
328	12.9	59	0.0	132	3.5
329	11.2	60	0.0	133	1.9
330	8.3	61	0.0	134	0.0
331	4.9	62	0.0	135	0.0
332	1.5	63	1.2	136	0.0
		64	3.5	137	0.0
		65	7.7	138	0.0
		66	11.1	139	0.0
		67	13.8	140	0.0
		68	16.5	141	0.0
		69	18.4	142	0.0
		70	20.4	143	1.5
		71	20.7	144	6.9
		72	19.6	145	12.7
		73	17.3	146	16.5
		74	12.3	147	20.0
		75	8.1	148	23.0
		76	6.1	149	25.7
		77	9.6	150	28.0
		78	12.7	151	30.7
		79	15.7	152	32.6
		80	18.0	153	34.2
		81	20.4	154	35.3
		82	21.9	155	36.9
		83	23.4	156	36.9
		84	23.8	157	37.2
		85	24.6	158	37.6
		86	25.0	159	37.6
		87	26.1	160	37.6
		88	26.1	161	37.2
		89	26.9	162	37.2
		90	26.9	163	36.9
		91	26.9	164	36.5
		92	26.5	165	36.5
		93	25.7	166	34.9
		94	21.9	167	33.4
		95	16.5	168	31.9
		96	10.0	169	29.2
		97	4.6	170	25.0
		98	1.5	171	25.0
		99	0.4	172	26.1
		100	0.0	173	27.6
		101	0.0	174	29.2
		102	0.0	175	31.1
		103	0.0	176	32.3
		104	0.0	177	34.2
		105	0.0	178	34.9

(c) EPA driving schedule for class 3 heavy-duty vehicles. This driving schedule is also known as the LA-92 cycle.

Time (sec.)	Speed (mph)
1	0.0
2	0.0
3	0.0
4	0.0
5	0.0
6	0.0
7	0.0
8	0.0
9	0.0
10	0.0
11	0.0
12	0.0
13	0.0
14	0.0
15	0.0
16	0.0
17	0.0
18	0.0
19	0.0
20	0.0
21	1.2
22	4.2
23	7.3
24	8.8
25	10.8
26	12.3
27	13.1
28	12.3
29	12.3
30	11.5
31	11.5
32	11.1

Time (sec.)	Speed (mph)	Time (sec.)	Speed (mph)	Time (sec.)	Speed (mph)
179	35.7	252	20.4	325	33.8
180	36.5	253	21.1	326	34.9
181	36.9	254	21.1	327	36.9
182	36.9	255	22.3	328	39.2
183	37.2	256	23.0	329	41.1
184	37.6	257	23.8	330	43.0
185	37.2	258	24.2	331	43.8
186	37.6	259	24.6	332	44.5
187	38.0	260	25.0	333	45.3
188	38.4	261	25.7	334	45.3
189	39.2	262	25.7	335	44.9
190	39.6	263	26.5	336	44.5
191	39.9	264	27.6	337	43.8
192	40.7	265	28.4	338	43.4
193	40.3	266	29.2	339	42.6
194	41.1	267	30.3	340	41.9
195	41.1	268	31.1	341	41.5
196	40.7	269	31.1	342	40.7
197	31.9	270	30.7	343	40.3
198	23.9	271	31.1	344	41.1
199	15.9	272	29.6	345	41.5
200	7.9	273	29.2	346	42.6
201	2.7	274	29.2	347	43.4
202	0.4	275	28.8	348	44.2
203	0.4	276	28.0	349	44.9
204	2.7	277	23.0	350	45.7
205	3.8	278	21.1	351	46.5
206	3.8	279	21.5	352	46.8
207	1.5	280	20.7	353	47.2
208	0.0	281	20.7	354	48.0
209	0.0	282	19.6	355	47.6
210	0.0	283	16.5	356	48.4
211	0.0	284	13.1	357	48.0
212	0.0	285	9.6	358	47.2
213	0.0	286	7.3	359	46.1
214	0.0	287	3.8	360	45.7
215	0.0	288	0.8	361	44.9
216	0.0	289	0.0	362	44.2
217	0.0	290	0.0	363	43.8
218	0.0	291	0.0	364	44.5
219	0.0	292	0.0	365	44.9
220	0.0	293	0.0	366	45.3
221	0.0	294	0.0	367	46.5
222	0.0	295	0.0	368	48.0
223	0.0	296	0.0	369	48.8
224	0.0	297	0.0	370	49.5
225	0.0	298	0.0	371	49.9
226	0.0	299	0.0	372	49.9
227	0.0	300	0.0	373	49.9
228	0.0	301	0.0	374	49.5
229	0.0	302	0.0	375	49.5
230	0.0	303	0.0	376	48.8
231	0.0	304	0.0	377	48.8
232	0.0	305	0.0	378	48.8
233	0.0	306	0.0	379	48.4
234	0.0	307	0.0	380	48.8
235	0.0	308	0.0	381	49.5
236	0.0	309	0.0	382	50.3
237	0.0	310	0.0	383	50.7
238	1.5	311	0.0	384	51.8
239	5.0	312	0.0	385	52.6
240	8.8	313	0.4	386	53.4
241	11.5	314	2.7	387	54.1
242	14.2	315	7.3	388	55.3
243	15.4	316	11.5	389	55.3
244	16.1	317	15.4	390	56.1
245	16.1	318	18.4	391	56.4
246	16.9	319	20.7	392	56.4
247	16.5	320	24.2	393	56.4
248	16.9	321	26.9	394	57.2
249	18.0	322	29.6	395	56.8
250	19.2	323	31.1	396	57.6
251	20.4	324	32.6	397	57.6



Time (sec.)	Speed (mph)	Time (sec.)	Speed (mph)	Time (sec.)	Speed (mph)
398	57.6	471	59.9	544	5.4
399	58.0	472	58.8	545	1.9
400	58.0	473	58.0	546	0.0
401	58.4	474	57.6	547	0.0
402	58.4	475	56.8	548	0.0
403	58.8	476	56.1	549	0.0
404	59.1	477	55.3	550	0.0
405	58.8	478	54.1	551	0.0
406	58.8	479	52.6	552	0.0
407	58.0	480	49.2	553	0.0
408	58.0	481	46.1	554	0.0
409	57.6	482	43.0	555	0.0
410	57.6	483	37.2	556	0.0
411	57.6	484	29.6	557	0.0
412	57.6	485	21.5	558	0.0
413	57.6	486	16.5	559	0.0
414	59.1	487	15.7	560	0.0
415	59.5	488	18.4	561	0.0
416	59.9	489	21.5	562	0.0
417	60.3	490	25.0	563	0.0
418	60.3	491	27.3	564	0.0
419	61.1	492	29.2	565	0.0
420	60.3	493	30.7	566	0.0
421	59.9	494	31.5	567	0.0
422	59.5	495	31.1	568	0.0
423	59.1	496	31.1	569	0.0
424	59.1	497	30.3	570	0.0
425	59.5	498	30.0	571	0.0
426	59.5	499	30.0	572	0.4
427	59.5	500	29.6	573	1.5
428	59.9	501	30.0	574	3.5
429	60.3	502	28.8	575	6.1
430	60.7	503	28.8	576	10.4
431	60.7	504	28.0	577	14.2
432	61.4	505	28.4	578	16.9
433	61.8	506	28.0	579	19.2
434	61.8	507	28.4	580	20.0
435	61.8	508	28.4	581	21.5
436	61.8	509	28.8	582	23.4
437	61.1	510	28.4	583	24.6
438	60.7	511	28.4	584	24.2
439	60.3	512	28.0	585	20.0
440	60.3	513	26.5	586	16.9
441	60.3	514	24.2	587	13.4
442	59.5	515	22.7	588	13.4
443	58.8	516	20.4	589	15.7
444	59.1	517	17.7	590	18.4
445	58.8	518	15.7	591	21.1
446	58.8	519	13.1	592	23.4
447	58.8	520	10.8	593	25.3
448	58.4	521	8.4	594	27.6
449	58.0	522	7.3	595	28.8
450	58.0	523	5.0	596	30.3
451	58.0	524	3.8	597	30.7
452	58.4	525	3.5	598	31.5
453	59.1	526	1.9	599	31.1
454	59.5	527	0.8	600	31.1
455	59.9	528	0.0	601	30.3
456	59.9	529	0.0	602	30.3
457	60.3	530	0.0	603	30.3
458	61.1	531	0.8	604	30.7
459	61.1	532	1.9	605	31.1
460	61.1	533	3.8	606	32.3
461	61.4	534	6.9	607	32.6
462	61.4	535	9.6	608	32.6
463	61.1	536	11.1	609	32.6
464	60.7	537	11.1	610	31.1
465	59.9	538	10.4	611	26.9
466	59.1	539	8.8	612	22.3
467	59.1	540	9.2	613	18.0
468	59.1	541	10.0	614	13.8
469	59.9	542	10.4	615	9.6
470	59.5	543	10.4	616	4.6

Time (sec.)	Speed (mph)	Time (sec.)	Speed (mph)	Time (sec.)	Speed (mph)
617	6.1	690	30.3	763	1.5
618	10.0	691	29.2	764	5.4
619	14.2	692	28.4	765	9.2
620	17.3	693	25.0	766	11.5
621	20.0	694	21.1	767	14.6
622	21.5	695	16.9	768	17.3
623	22.3	696	13.4	769	19.2
624	22.3	697	13.1	770	21.1
625	22.3	698	12.3	771	20.7
626	22.3	699	12.7	772	20.7
627	23.0	700	15.7	773	19.6
628	23.0	701	19.2	774	18.4
629	22.7	702	22.3	775	16.9
630	22.3	703	24.6	776	16.9
631	21.9	704	25.7	777	16.5
632	22.7	705	26.5	778	16.9
633	23.8	706	26.5	779	16.9
634	25.0	707	26.9	780	16.9
635	25.3	708	27.3	781	17.3
636	25.7	709	27.3	782	19.2
637	26.5	710	27.6	783	20.4
638	26.9	711	28.4	784	21.1
639	27.3	712	28.8	785	22.3
640	28.0	713	28.8	786	22.3
641	29.2	714	29.2	787	22.7
642	30.0	715	28.8	788	22.3
643	30.0	716	28.8	789	22.7
644	29.6	717	28.0	790	22.3
645	29.6	718	28.0	791	23.8
646	28.8	719	27.6	792	25.7
647	28.4	720	26.5	793	27.6
648	28.0	721	24.6	794	29.6
649	27.3	722	20.7	795	30.0
650	25.7	723	16.5	796	29.2
651	24.6	724	15.0	797	27.6
652	25.0	725	14.2	798	25.0
653	26.5	726	14.2	799	23.8
654	28.0	727	13.8	800	23.4
655	29.6	728	13.8	801	24.2
656	30.7	729	11.9	802	23.4
657	32.3	730	8.4	803	23.0
658	33.0	731	4.2	804	20.4
659	34.2	732	1.2	805	18.8
660	34.6	733	0.0	806	17.3
661	35.3	734	0.0	807	15.0
662	36.1	735	0.0	808	13.1
663	36.1	736	0.0	809	9.2
664	36.9	737	0.0	810	6.9
665	36.9	738	0.0	811	4.6
666	37.6	739	0.0	812	4.6
667	37.6	740	0.0	813	4.6
668	38.4	741	0.0	814	4.2
669	38.0	742	0.0	815	5.4
670	37.6	743	0.0	816	4.6
671	37.6	744	0.0	817	3.5
672	37.2	745	0.0	818	2.3
673	36.9	746	0.0	819	2.3
674	36.1	747	0.0	820	1.9
675	35.7	748	0.0	821	3.1
676	36.1	749	0.0	822	6.1
677	35.7	750	0.0	823	4.6
678	35.7	751	0.0	824	2.7
679	35.7	752	0.0	825	2.3
680	36.1	753	0.0	826	2.3
681	36.1	754	0.0	827	3.1
682	35.7	755	0.0	828	4.2
683	35.7	756	0.0	829	3.5
684	34.9	757	0.0	830	3.8
685	34.6	758	0.0	831	4.2
686	34.2	759	0.0	832	3.5
687	33.8	760	0.0	833	3.5
688	33.4	761	0.0	834	3.5
689	33.0	762	0.0	835	4.6

Time (sec.)	Speed (mph)	Time (sec.)	Speed (mph)	Time (sec.)	Speed (mph)
836	5.8	909	64.1	982	38.0
837	3.5	910	64.9	983	38.0
838	0.8	911	65.3	984	37.2
839	3.5	912	65.3	985	36.9
840	3.8	913	65.3	986	36.1
841	2.3	914	64.1	987	35.7
842	0.0	915	63.4	988	34.9
843	1.2	916	63.0	989	34.9
844	6.9	917	63.4	990	33.8
845	13.8	918	64.1	991	31.5
846	18.8	919	64.9	992	28.8
847	23.8	920	65.3	993	25.7
848	27.3	921	64.5	994	24.6
849	30.7	922	64.1	995	23.4
850	33.8	923	63.4	996	22.3
851	37.6	924	63.7	997	21.5
852	40.7	925	63.4	998	20.0
853	43.8	926	63.4	999	20.0
854	46.1	927	63.4	1000	19.2
855	48.0	928	63.4	1001	19.2
856	49.5	929	63.7	1002	18.0
857	51.5	930	64.5	1003	11.9
858	53.0	931	65.3	1004	6.9
859	54.5	932	64.9	1005	2.7
860	55.7	933	63.7	1006	0.8
861	56.8	934	63.0	1007	0.4
862	58.0	935	59.9	1008	0.0
863	59.1	936	55.3	1009	0.0
864	60.3	937	50.7	1010	0.0
865	61.1	938	49.2	1011	0.0
866	61.8	939	48.0	1012	0.0
867	61.8	940	46.1	1013	0.0
868	61.8	941	44.2	1014	0.0
869	61.8	942	41.1	1015	0.0
870	62.6	943	39.9	1016	0.0
871	63.4	944	36.1	1017	0.0
872	63.0	945	32.6	1018	0.0
873	63.0	946	29.2	1019	0.0
874	62.6	947	24.6	1020	0.0
875	61.8	948	20.7	1021	0.0
876	61.8	949	19.2	1022	0.0
877	62.2	950	16.5	1023	0.4
878	62.2	951	15.0	1024	2.7
879	62.6	952	11.9	1025	6.1
880	63.7	953	9.6	1026	9.2
881	64.5	954	8.4	1027	11.5
882	64.9	955	5.8	1028	14.2
883	66.0	956	1.2	1029	16.1
884	66.0	957	0.0	1030	18.0
885	66.8	958	0.0	1031	20.0
886	66.4	959	0.0	1032	21.5
887	66.8	960	1.2	1033	23.0
888	67.2	961	3.1	1034	24.2
889	66.4	962	5.0	1035	25.0
890	66.4	963	8.4	1036	25.7
891	66.0	964	11.5	1037	26.9
892	65.7	965	14.6	1038	27.6
893	65.7	966	16.9	1039	27.6
894	66.4	967	18.8	1040	28.4
895	66.0	968	21.1	1041	29.2
896	65.7	969	23.8	1042	29.2
897	65.3	970	26.5	1043	30.0
898	65.3	971	28.0	1044	29.6
899	64.5	972	29.6	1045	29.6
900	64.5	973	30.7	1046	28.8
901	64.1	974	32.6	1047	28.0
902	63.7	975	34.2	1048	23.8
903	63.7	976	35.3	1049	18.8
904	63.7	977	36.1	1050	11.9
905	64.5	978	36.9	1051	6.1
906	64.5	979	38.0	1052	1.5
907	64.9	980	38.0	1053	1.5
908	64.5	981	38.0	1054	4.2

Time (sec.)	Speed (mph)	Time (sec.)	Speed (mph)	Time (sec.)	Speed (mph)
1055	8.1	1128	42.2	1201	27.3
1056	10.4	1129	41.9	1202	28.8
1057	13.1	1130	41.5	1203	30.0
1058	15.4	1131	41.9	1204	29.6
1059	18.0	1132	41.9	1205	29.6
1060	20.4	1133	41.9	1206	28.8
1061	23.0	1134	42.2	1207	26.1
1062	25.3	1135	42.6	1208	22.3
1063	27.3	1136	42.6	1209	19.2
1064	28.8	1137	42.6	1210	16.5
1065	30.3	1138	42.6	1211	12.7
1066	31.1	1139	42.6	1212	9.6
1067	32.3	1140	42.6	1213	6.9
1068	31.9	1141	42.6	1214	4.2
1069	32.3	1142	42.2	1215	2.3
1070	31.9	1143	43.0	1216	0.8
1071	31.1	1144	43.4	1217	0.0
1072	28.8	1145	43.0	1218	0.0
1073	25.0	1146	42.6	1219	0.0
1074	22.7	1147	41.9	1220	0.0
1075	18.8	1148	40.7	1221	0.0
1076	15.4	1149	36.9	1222	0.0
1077	13.4	1150	32.6	1223	0.0
1078	11.9	1151	28.0	1224	0.0
1079	8.8	1152	23.4	1225	0.0
1080	5.0	1153	18.4	1226	0.0
1081	1.9	1154	14.6	1227	0.0
1082	2.3	1155	12.3	1228	0.0
1083	2.7	1156	9.2	1229	0.0
1084	3.5	1157	5.8	1230	0.0
1085	6.5	1158	1.9	1231	0.0
1086	10.8	1159	0.4	1232	0.0
1087	13.8	1160	0.0	1233	0.0
1088	16.1	1161	0.0	1234	0.0
1089	18.4	1162	0.0	1235	0.0
1090	20.4	1163	0.0	1236	0.0
1091	21.9	1164	0.0	1237	0.0
1092	21.9	1165	0.4	1238	0.0
1093	20.7	1166	4.2	1239	0.0
1094	17.3	1167	9.2	1240	3.5
1095	13.1	1168	11.9	1241	10.4
1096	9.6	1169	14.2	1242	15.4
1097	8.8	1170	15.7	1243	17.3
1098	10.8	1171	15.0	1244	17.3
1099	12.7	1172	14.2	1245	18.4
1100	14.2	1173	13.4	1246	21.5
1101	14.6	1174	13.8	1247	24.6
1102	13.1	1175	14.6	1248	27.3
1103	11.1	1176	14.6	1249	30.0
1104	11.1	1177	14.2	1250	31.5
1105	11.1	1178	16.1	1251	31.9
1106	13.1	1179	15.7	1252	32.6
1107	15.7	1180	15.7	1253	33.4
1108	18.4	1181	14.6	1254	34.9
1109	20.7	1182	13.1	1255	36.5
1110	23.8	1183	10.0	1256	37.6
1111	25.7	1184	7.3	1257	39.2
1112	28.0	1185	3.5	1258	40.3
1113	30.0	1186	0.8	1259	40.7
1114	31.1	1187	0.0	1260	41.1
1115	32.3	1188	0.0	1261	40.7
1116	34.2	1189	0.0	1262	40.7
1117	35.7	1190	0.0	1263	40.7
1118	36.9	1191	0.4	1264	41.5
1119	38.8	1192	2.7	1265	42.6
1120	40.3	1193	7.3	1266	43.0
1121	41.5	1194	11.5	1267	44.5
1122	42.2	1195	15.4	1268	45.3
1123	43.0	1196	19.2	1269	45.3
1124	43.8	1197	21.9	1270	44.9
1125	43.8	1198	23.8	1271	43.4
1126	43.4	1199	25.0	1272	40.3
1127	43.0	1200	26.1	1273	38.0

Time (sec.)	Speed (mph)	Time (sec.)	Speed (mph)	Time (sec.)	Speed (mph)
1274	36.1	1347	32.6	1420	0.0
1275	36.5	1348	33.8	1421	0.0
1276	38.0	1349	34.6	1422	0.0
1277	39.2	1350	34.9	1423	0.0
1278	40.7	1351	34.6	1424	0.0
1279	42.2	1352	34.9	1425	0.0
1280	43.4	1353	34.6	1426	0.0
1281	44.9	1354	34.9	1427	0.0
1282	45.7	1355	34.9	1428	0.0
1283	46.1	1356	34.9	1429	0.0
1284	46.8	1357	34.2	1430	0.0
1285	46.5	1358	33.8	1431	0.0
1286	46.5	1359	32.6	1432	0.0
1287	46.5	1360	31.5	1433	0.0
1288	46.1	1361	30.0	1434	0.0
1289	46.1	1362	28.8	1435	0.0
1290	46.1	1363	27.3	1436	0.0
1291	46.8	1364	23.8	1437	0.0
1292	47.6	1365	23.0	1438	0.0
1293	48.0	1366	23.0	1439	0.0
1294	48.4	1367	22.3	1440	0.0
1295	48.0	1368	20.4	1441	0.0
1296	48.0	1369	18.8	1442	0.0
1297	47.2	1370	17.7	1443	0.0
1298	46.5	1371	16.1	1444	0.0
1299	46.8	1372	14.6	1445	0.0
1300	47.2	1373	12.7	1446	0.0
1301	48.4	1374	11.1	1447	0.0
1302	48.4	1375	9.2	1448	0.0
1303	48.8	1376	8.8	1449	0.0
1304	48.4	1377	7.3	1450	0.0
1305	47.6	1378	6.1	1451	0.0
1306	46.5	1379	5.0	1452	0.0
1307	44.2	1380	4.2	1453	0.0
1308	42.2	1381	3.5	1454	0.0
1309	41.5	1382	2.7	1455	0.0
1310	41.1	1383	2.3	1456	1.2
1311	40.7	1384	1.5	1457	4.2
1312	40.3	1385	1.2	1458	7.3
1313	39.6	1386	0.0	1459	8.8
1314	39.2	1387	1.2	1460	10.8
1315	38.8	1388	4.2	1461	12.3
1316	38.0	1389	7.3	1462	13.1
1317	37.6	1390	8.8	1463	12.3
1318	37.2	1391	10.8	1464	12.3
1319	36.5	1392	12.3	1465	11.5
1320	34.6	1393	13.1	1466	11.5
1321	31.5	1394	12.3	1467	11.1
1322	29.6	1395	12.3	1468	11.1
1323	29.2	1396	11.5	1469	11.1
1324	28.8	1397	11.5	1470	13.1
1325	28.8	1398	11.1	1471	15.0
1326	28.0	1399	11.1	1472	16.9
1327	28.0	1400	11.1	1473	16.9
1328	28.4	1401	13.1	1474	16.1
1329	29.6	1402	15.0	1475	15.7
1330	30.0	1403	16.9	1476	15.4
1331	30.3	1404	16.9	1477	15.0
1332	29.2	1405	16.1	1478	13.8
1333	26.5	1406	15.7	1479	10.8
1334	25.3	1407	15.4	1480	8.4
1335	25.0	1408	15.0	1481	6.1
1336	24.6	1409	13.8	1482	4.2
1337	24.6	1410	10.8	1483	3.5
1338	25.3	1411	8.4	1484	3.5
1339	26.1	1412	6.1	1485	1.5
1340	27.3	1413	4.2	1486	0.0
1341	28.4	1414	3.5	1487	0.0
1342	29.2	1415	3.5	1488	0.0
1343	29.2	1416	1.5	1489	0.0
1344	29.6	1417	0.0	1490	0.0
1345	30.0	1418	0.0	1491	0.0
1346	31.1	1419	0.0	1492	0.0

Time (sec.)	Speed (mph)	Time (sec.)	Speed (mph)	Time (sec.)	Speed (mph)
1493	0.0	1566	5.0	1639	2.7
1494	0.0	1567	3.5	1640	3.8
1495	0.0	1568	1.9	1641	3.8
1496	0.0	1569	0.0	1642	1.5
1497	0.0	1570	0.0	1643	0.0
1498	1.2	1571	0.0	1644	0.0
1499	3.5	1572	0.0	1645	0.0
1500	7.7	1573	0.0	1646	0.0
1501	11.1	1574	0.0	1647	0.0
1502	13.8	1575	0.0	1648	0.0
1503	16.5	1576	0.0	1649	0.0
1504	18.4	1577	0.0	1650	0.0
1505	20.4	1578	1.5	1651	0.0
1506	20.7	1579	6.9	1652	0.0
1507	19.6	1580	12.7	1653	0.0
1508	17.3	1581	16.5	1654	0.0
1509	12.3	1582	20.0	1655	0.0
1510	8.1	1583	23.0	1656	0.0
1511	6.1	1584	25.7	1657	0.0
1512	9.6	1585	28.0	1658	0.0
1513	12.7	1586	30.7	1659	0.0
1514	15.7	1587	32.6	1660	0.0
1515	18.0	1588	34.2	1661	0.0
1516	20.4	1589	35.3	1662	0.0
1517	21.9	1590	36.9	1663	0.0
1518	23.4	1591	36.9	1664	0.0
1519	23.8	1592	37.2	1665	0.0
1520	24.6	1593	37.6	1666	0.0
1521	25.0	1594	37.6	1667	0.0
1522	26.1	1595	37.6	1668	0.0
1523	26.1	1596	37.2	1669	0.0
1524	26.9	1597	37.2	1670	0.0
1525	26.9	1598	36.9	1671	0.0
1526	26.9	1599	36.5	1672	0.0
1527	26.5	1600	36.5	1673	1.5
1528	25.7	1601	34.9	1674	5.0
1529	21.9	1602	33.4	1675	8.8
1530	16.5	1603	31.9	1676	11.5
1531	10.0	1604	29.2	1677	14.2
1532	4.6	1605	25.0	1678	15.4
1533	1.5	1606	25.0	1679	16.1
1534	0.4	1607	26.1	1680	16.1
1535	0.0	1608	27.6	1681	16.9
1536	0.0	1609	29.2	1682	16.5
1537	0.0	1610	31.1	1683	16.9
1538	0.0	1611	32.3	1684	18.0
1539	0.0	1612	34.2	1685	19.2
1540	0.0	1613	34.9	1686	20.4
1541	0.0	1614	35.7	1687	20.4
1542	0.0	1615	36.5	1688	21.1
1543	0.4	1616	36.9	1689	21.1
1544	1.2	1617	36.9	1690	22.3
1545	1.9	1618	37.2	1691	23.0
1546	3.8	1619	37.6	1692	23.8
1547	7.7	1620	37.2	1693	24.2
1548	11.5	1621	37.6	1694	24.6
1549	14.6	1622	38.0	1695	25.0
1550	18.0	1623	38.4	1696	25.7
1551	21.5	1624	39.2	1697	25.7
1552	25.0	1625	39.6	1698	26.5
1553	28.4	1626	39.9	1699	27.6
1554	30.7	1627	40.7	1700	28.4
1555	31.9	1628	40.3	1701	29.2
1556	32.3	1629	41.1	1702	30.3
1557	32.3	1630	41.1	1703	31.1
1558	31.9	1631	40.7	1704	31.1
1559	30.3	1632	31.9	1705	30.7
1560	28.0	1633	23.9	1706	31.1
1561	24.2	1634	15.9	1707	29.6
1562	20.0	1635	7.9	1708	29.2
1563	16.1	1636	2.7	1709	29.2
1564	11.5	1637	0.4	1710	28.8
1565	8.1	1638	0.4	1711	28.0

Time (sec.)	Speed (mph)
1712 .....	23.0
1713 .....	21.1
1714 .....	21.5
1715 .....	20.7
1716 .....	20.7
1717 .....	19.6
1718 .....	16.5
1719 .....	13.1
1720 .....	9.6
1721 .....	7.3
1722 .....	3.8
1723 .....	0.8
1724 .....	0.0
1725 .....	0.0
1726 .....	0.0
1727 .....	0.0
1728 .....	0.0
1729 .....	0.0
1730 .....	0.0
1731 .....	0.0
1732 .....	0.0
1733 .....	0.0
1734 .....	0.0
1735 .....	0.0

(d) [Reserved]

\* \* \* \* \*

**Appendix XIII through Appendix XVIII to Part 86—[Removed]**

■ 208. Appendix XIII through Appendix XVIII to part 86 are removed.

**PART 600—FUEL ECONOMY AND GREENHOUSE GAS EXHAUST EMISSIONS OF MOTOR VEHICLES**

■ 209. The authority citation for part 600 continues to read as follows:

**Authority:** 49 U.S.C. 32901—23919q, Pub. L. 109–58.

**Subpart A—[Amended]**

■ 210. Section 600.001 is amended by adding paragraph (e) to read as follows:

**§ 600.001 General applicability.**

\* \* \* \* \*

(e) *You*. The term “you” in this part refers to manufacturers subject to the requirements of this part.

■ 211. Section 600.002 is amended by revising the definitions for “Alcohol” and “Alcohol-fueled automobile” and adding a definition for “We (us, our)” in alphabetical order to read as follows:

**§ 600.002 Definitions.**

\* \* \* \* \*

*Alcohol* means a mixture containing 85 percent or more by volume methanol, denatured ethanol, or other alcohols, in any combination.

*Alcohol-fueled automobile* means an automobile designed to operate on alcohol, but not on gasoline.

\* \* \* \* \*

*We (us, our)* means the Administrator of the Environmental Protection Agency and any authorized representatives.

\* \* \* \* \*

■ 212. Section 600.011 is amended by revising paragraphs (b), (c)(2), and (c)(3) to read as follows:

**§ 600.011 Incorporation by reference.**

\* \* \* \* \*

(b) *ASTM International material*. The following documents are available from ASTM International, 100 Barr Harbor Drive, P.O. Box C700, West Conshohocken, PA, 19428–2959, (610) 832–9585, or <http://www.astm.org/>.

(1) ASTM D975–13a, Standard Specification for Diesel Fuel Oils, approved December 1, 2013, IBR approved for § 600.107–08(b).

(2) ASTM D1298–12b, Standard Test Method for Density, Relative Density, or API Gravity of Crude Petroleum and Liquid Petroleum Products by Hydrometer Method, approved June 1, 2012, IBR approved for §§ 600.113–12(f) and 600.510–12(g).

(3) ASTM D1945–03 (Reapproved 2010), Standard Test Method for Analysis of Natural Gas By Gas Chromatography, approved January 1, 2010, IBR approved for § 600.113–12(f) and (k).

(4) ASTM D3338/D3338M–09, Standard Test Method for Estimation of Net Heat of Combustion of Aviation Fuels, approved April 15, 2009, IBR approved for § 600.113–12(f).

(5) ASTM D3343–05 (Reapproved 2010), Standard Test Method for Estimation of Hydrogen Content of Aviation Fuels, approved October 1, 2010, IBR approved for § 600.113–12(f).

(c) \* \* \*

(2) SAE J1634, Battery Electric Vehicle Energy Consumption and Range Test Procedure, revised October 2012, IBR approved for §§ 600.116–12(a) and 600.311–12(j) and (k).

(3) SAE J1711, Recommended Practice for Measuring the Exhaust Emissions and Fuel Economy of Hybrid-Electric Vehicles, Including Plug-In Hybrid Vehicles, revised June 2010, IBR approved for §§ 600.114–12(c) and (f), 600.116–12(b) and (c), and 600.311–12(c), (j), and (k).

\* \* \* \* \*

**Subpart B—[Amended]**

■ 213. Section 600.111–08 is revised to read as follows:

**§ 600.111–08 Test procedures.**

This section describes test procedures for the FTP, highway fuel economy test (HFET), US06, SC03, and the cold temperature FTP tests. Perform testing

according to test procedures and other requirements contained in this part 600 and in 40 CFR parts 86 and 1066, including the provisions of 40 CFR part 86, subparts B, C, and S. Manufacturers may certify vehicles based on data collected according to previously published test procedures for model years through 2021. In addition, we may approve the use of previously published test procedures for later model years as an alternative procedure under 40 CFR 1066.10(c). See 40 CFR 86.101 and 86.201 for detailed provisions related to this transition.

(a) *FTP testing procedures*. Conduct FTP testing as described in 40 CFR 1066.810 through 1066.820. You may omit evaporative emission measurements for testing under this part 600 unless we specifically require it.

(b) *Highway fuel economy testing procedures*. Conduct HFET testing as described in 40 CFR 1066.840.

(c) *US06 testing procedures*. Conduct US06 testing as described in 40 CFR 1066.830 and 1066.831.

(d) *SC03 testing procedures*. Conduct SC03 testing as described in 40 CFR 1066.830 and 835.

(e) *Cold temperature FTP procedures*. Conduct cold temperature FTP testing as described in 40 CFR part 1066, subpart H.

(f) *Testing with alternative fuels*. For vehicles designed to operate on an alternative fuel in addition to gasoline or diesel fuel, perform FTP and HFET testing as described in paragraphs (a) and (b) of this section for each type of fuel on which the vehicle is designed to operate. No US06, SC03, or cold temperature FTP testing is required on the alternative fuel.

(g) *Testing for vehicles with rechargeable energy storage systems*. Test electric vehicles and hybrid electric vehicles as described in § 600.116.

(h) *Special test procedures*. We may allow or require you to use procedures other than those specified in this section as described in 40 CFR 1066.10(c). For example, special test procedures may be used for advanced technology vehicles, including, but not limited to fuel cell vehicles, hybrid electric vehicles using hydraulic energy storage, and vehicles equipped with hydrogen internal combustion engines. Additionally, we may conduct fuel economy and carbon-related exhaust emission testing using the special test procedures approved for a specific vehicle.

**§ 600.113–08 [Removed]**

■ 214A. Remove § 600.113–08.

**§ 600.114–08 [Removed]**

■ 214B. Remove 600.114–08.



- 215. Section 600.116–12 is amended as follows:
  - a. By revising the section heading.
  - b. By revising paragraph (a)(5).
  - c. By redesignating paragraphs (b) and (c) as paragraphs (c) and (d), respectively.
  - d. By adding a new paragraph (b).
  - e. By revising the redesignated paragraphs (c) introductory text, (c)(1) introductory text, and (c)(2) introductory text.
  - f. By revising the redesignated paragraph (c)(5).
  - g. By adding paragraph (c)(9).

**§ 600.116–12 Special procedures related to electric vehicles and hybrid electric vehicles.**

(a) \* \* \*

(5) We may approve alternate measurement procedures with respect to electric vehicles if they are necessary or appropriate for meeting the objectives of this part. For example, we may approve the use of an earlier version of SAE J1634 for carryover vehicles, or if you show that it is equivalent for your vehicle.

\* \* \* \* \*

(b) Determine performance values for hybrid electric vehicles that have no plug-in capability as specified in §§ 600.210 and 600.311 using the procedures for charge-sustaining operation from SAE J1711 (incorporated by reference in § 600.011). We may approve alternate measurement procedures with respect to these vehicles if that is necessary or appropriate for meeting the objectives of this part. For example, we may approve alternate Net Energy Change tolerances for charge-sustaining operation as described in paragraph (c)(5) of this section.

(c) Determine performance values for hybrid electric vehicles that have plug-in capability as specified in §§ 600.210 and 600.311 using the procedures of SAE J1711 (incorporated by reference in § 600.011), with the following clarifications and modifications:

(1) To determine fuel economy and CREE values to demonstrate compliance with CAFE and GHG standards, calculate composite values representing combined operation during charge-depleting and charge-sustaining operation using the following utility factors except as specified in this paragraph (c):

\* \* \* \* \*

(2) To determine fuel economy and CO<sub>2</sub> emission values for labeling purposes, calculate composite values representing combined operation during charge-depleting and charge-sustaining operation using the following utility

factors except as specified in this paragraph (c):

\* \* \* \* \*

(5) The End-of-Test criterion is based on a 1 percent Net Energy Change as specified in Section 3.8 of SAE J1711. We may approve alternate Net Energy Change tolerances as specified in Section 3.9.1 or Appendix C of SAE J1711 if the 1 percent threshold is insufficient or inappropriate for marking the end of charge-depleting operation. For charge-sustaining tests, we may approve the use of alternate Net Energy Change tolerances as specified in Appendix C of SAE J1711 to correct final fuel economy values, CO<sub>2</sub> emissions, and carbon-related exhaust emissions. For charge-sustaining tests, do not use alternate Net Energy Change tolerances to correct emissions of criteria pollutants. Additionally, if we approve an alternate End-of-Test criterion or Net Energy Change tolerances for a specific vehicle, we may use the alternate criterion or tolerances for any testing we conduct on that vehicle.

\* \* \* \* \*

(9) The utility factors described in this paragraph (c) are derived from equations in SAE J2841. You may alternatively calculate utility factors directly from the corresponding equations in SAE J2841.

\* \* \* \* \*

■ 216. A new § 600.117 is added to subpart B to read as follows:

**§ 600.117 Interim provisions.**

The following provisions apply instead of other provisions specified in this part through model year 2019:

(a) Except as specified in paragraph (e) of this section, manufacturers must demonstrate compliance with greenhouse gas emission standards and determine fuel economy values using gasoline test fuel as specified in 40 CFR 86.113–04(a), regardless of any testing with Tier 3 test fuel under paragraph (b) of this section.

(b) Manufacturers may demonstrate that vehicles comply with Tier 3 emission standards as specified in 40 CFR part 86, subpart S, during fuel economy measurements using the gasoline test fuel specified in 40 CFR 86.113–04(a), as long as this test fuel is used for all the duty cycles specified in 40 CFR part 86, subpart S. If a vehicle fails to meet a Tier 3 emission standard using the gasoline test fuel specified in 40 CFR 86.113–04(a), the manufacturer must retest the vehicle using the Tier 3 test fuel specified in 40 CFR 1065.710(b) to demonstrate compliance with all applicable emission standards over that test cycle.

(c) If a manufacturer demonstrates compliance with emission standards for criteria pollutants over all five test cycles using the Tier 3 test fuel specified in 40 CFR 1065.710(b), the manufacturer may use the derived five-cycle calculations to demonstrate compliance with greenhouse gas emission standards and determine fuel economy values. This also applies for fuel economy labeling, as long as the test group meets the criteria described in § 600.115. Vehicles tested over the FTP and HFET cycles with the test fuel specified in 40 CFR 86.113–04(a) under this paragraph (b) must meet the Tier 3 emission standards over those test cycles.

(d) Manufacturers may perform testing with either gasoline test fuel specified in 40 CFR 86.113–04(a) or in 40 CFR 1065.710(b) to evaluate whether their vehicles meet the criteria for derived 5-cycle testing under 40 CFR 600.115; however, all five tests must use test fuel meeting the same specifications.

(e) For IUVP testing under § 86.1845, manufacturers may demonstrate compliance with greenhouse gas emission standards using a test fuel meeting specifications for demonstrating compliance with emission standards for criteria pollutants.

**Subpart C—[Amended]**

**§ 600.206–08 [Removed]**

■ 217A. Remove § 600.206–08.

**§ 600.207–08 [Removed]**

■ 217B. Remove § 600.207–08.

**§ 600.208–08 [Removed]**

■ 217C. Remove § 600.208–08.

**§ 600.209–08 [Removed]**

■ 217D. Remove § 600.209–08.

**§ 600.210–08 [Removed]**

■ 217D. Remove § 600.210–08.

**Subpart D—[Amended]**

**§ 600.302–08 [Removed]**

■ 218A. Remove § 600.302–08.

**§ 600.311–08 [Removed]**

■ 218B. Remove § 600.311–08.

■ 219. Section 600.311–12 is amended by revising paragraph (g) to read as follows:

§ 600.311–12 Determination of values for fuel economy labels.

\* \* \* \* \*

(g) Smog rating. Establish a rating for exhaust emissions other than CO2 based on the applicable emission standards for the appropriate model year as shown in Tables 1 through 3 of this section. For Independent Commercial Importers that import vehicles not subject to Tier 2 or

Tier 3 emission standards, the vehicle's smog rating is 1. Similarly, if a manufacturer certifies vehicles to emission standards that are less stringent than all the identified standards for any reason, the vehicle's smog rating is 1. If EPA or California emission standards change in the future, we may revise the emission levels

corresponding to each rating for future model years as appropriate to reflect the changed standards. If this occurs, we would publish the revised ratings as described in § 600.302–12(k), allowing sufficient lead time to make the changes; we would also expect to initiate a rulemaking to update the smog rating in the regulation.

TABLE 1 OF § 600.311–12—CRITERIA FOR ESTABLISHING SMOG RATING FOR MODEL YEAR 2025 AND LATER

Table with 3 columns: Rating, U.S. EPA tier 3 emission standard, California air resources board LEV III emission standard. Rows include ratings 1, 2, 4, 5, 6, 7, 10 and corresponding bin and standard names.

TABLE 2 OF § 600.311–12—CRITERIA FOR ESTABLISHING SMOG RATING FOR MODEL YEARS 2018–2024

Table with 4 columns: Rating, U.S. EPA tier 3 emission standard, U.S EPA tier 2 emission standard, California air resources board LEV III emission standard. Rows include ratings 1, 3, 5, 6, 7, 8, 10 and corresponding bin and standard names.

TABLE 3 OF § 600.311–12—CRITERIA FOR ESTABLISHING SMOG RATING THROUGH MODEL YEAR 2017

Table with 4 columns: Rating, U.S. EPA tier 2 emission standard, California air resources board LEV II emission standard, California air resources board LEV III emission standard. Rows include ratings 1, 2, 3, 4, 5, 6, 7, 8, 9, 10 and corresponding bin and standard names.

\* \* \* \* \*

Subpart F—[Amended]

§ 600.507–08 [Removed]

■ 220A. Remove § 600.507–08.

§ 600.509–08 [Removed]

■ 220B. Remove § 600.509–08.

§ 600.510–08 [Removed]

■ 220C. Remove § 600.510–08.

§ 600.512–08 [Removed]

■ 220D. Remove § 600.512–08.

Appendix IV and Appendix V to Part 600—[Removed and Reserved]

■ 221. Remove and reserve Appendix IV and Appendix V to part 600.

PART 1036—CONTROL OF EMISSIONS FROM NEW AND IN-USE HEAVY-DUTY HIGHWAY ENGINES

■ 222. The authority citation for part 1036 continues to read as follows:

Authority: 42 U.S.C. 7401–7671q.

Subpart B—[Amended]

■ 223. Section 1036.115 is amended by adding paragraph (b) to read as follows:

§ 1036.115 Other requirements.

\* \* \* \* \*

(b) You must design and produce your engines to comply with evaporative emission standards as follows:

(1) For complete heavy-duty vehicles you produce, you must certify the vehicles to emission standards as specified in 40 CFR 1037.103.

(2) For incomplete heavy-duty vehicles, and for engines used in

vehicles you do not produce, you do not need to certify your engines to evaporative emission standards or otherwise meet those standards. However, vehicle manufacturers certifying their vehicles with your engines may depend on you to produce your engines according to their specifications. Also, your engines must meet applicable exhaust emission standards in the installed configuration.

### PART 1037—CONTROL OF EMISSIONS FROM NEW HEAVY-DUTY MOTOR VEHICLES

■ 224. The authority citation for part 1037 continues to read as follows:

**Authority:** 42 U.S.C. 7401–7671q.

#### Subpart B—[Amended]

■ 225. Section 1037.101 is amended by revising paragraph (b)(4) and adding paragraph (c)(3) to read as follows:

#### § 1037.101 Overvay of emission standards for heavy-duty vehicles.

\* \* \* \* \*

(b) \* \* \*

(4) *Fuel evaporative emissions.* These requirements are described in 40 CFR part 86 and § 1037.103.

(c) \* \* \*

(3) For evaporative and refueling emissions, vehicles are regulated based on the type of fuel they use. Vehicles fueled with volatile liquid fuels or gaseous fuels are subject to evaporative emission standards. Vehicles up to a certain size that are fueled with gasoline, diesel fuel, ethanol, methanol, or LPG are subject to refueling emission standards.

■ 226. A new § 1037.103 is added to read as follows:

#### § 1037.103 Evaporative and refueling emission standards.

(a) *Applicability.* Evaporative and refueling emission standards apply to heavy-duty vehicles as follows:

(1) Complete and incomplete heavy-duty vehicles at or below 14,000 pounds GVWR must meet evaporative and refueling emission standards as specified in 40 CFR part 86, subpart S, instead of the requirements specified in this section.

(2) Heavy-duty vehicles above 14,000 pounds GVWR that run on volatile liquid fuel (such as gasoline or ethanol) or gaseous fuel (such as natural gas or LPG) must meet evaporative and refueling emission standards as specified in this section.

(b) *Emission standards.* The evaporative and refueling emission standards and measurement procedures specified in 40 CFR 86.1813 apply for

vehicles above 14,000 pounds GVWR, except as described in this section. The evaporative emission standards phase in over model years 2018 through 2022, with provisions allowing for voluntary compliance with the standards as early as model year 2015. Count vehicles subject to standards under this section the same as heavy-duty vehicles at or below 14,000 pounds GVWR to comply with the phase-in requirements specified in 40 CFR 86.1813. These vehicles may generate and use emission credits as described in 40 CFR part 86, subpart S, but only for vehicles that are tested for certification instead of relying on the provisions of paragraph (c) of this section. The following provisions apply instead of what is specified in 40 CFR 86.1813:

(1) The refueling standards in 40 CFR 86.1813(b) apply to complete vehicles starting in model year 2022; they are optional for incomplete vehicles.

(2) The leak standard in 40 CFR 86.1813(a)(4) does not apply.

(3) The FEL cap relative to the diurnal plus hot soak standard for low-altitude testing is 1.9 grams per test.

(4) The diurnal plus hot soak standard for high-altitude testing is 2.3 grams per test.

(5) Testing does not require measurement of exhaust emissions. Disregard references in subpart B of this part to procedures, equipment specifications, and recordkeeping related to measuring exhaust emissions. All references to the exhaust test under 40 CFR part 86, subpart B, are considered the “dynamometer run” as part of the evaporative testing sequence under this subpart.

(6) Vehicles not yet subject to the Tier 3 standards in 40 CFR 86.1813 must meet evaporative emission standards as specified in §§ 86.008–10(b) and 86.007–11(b)(3) and (4).

(c) *Compliance demonstration.* You may provide a statement in the application for certification that vehicles above 14,000 pounds GVWR comply with evaporative and refueling emission standards instead of submitting test data if you include an engineering analysis describing how vehicles include design parameters, equipment, operating controls, or other elements of design that adequately demonstrate that vehicles comply with the standards. We would expect emission control components and systems to exhibit a comparable degree of control relative to vehicles that comply based on testing. For example, vehicles that comply under this paragraph (c) should rely on comparable material specifications to limit fuel permeation, and components should be

sized and calibrated to correspond with the appropriate fuel capacities, fuel flow rates, purge strategies, and other vehicle operating characteristics. You may alternatively show that design parameters are comparable to those for vehicles at or below 14,000 pounds GVWR certified under 40 CFR part 86, subpart S.

(d) *CNG refueling requirement.* Compressed natural gas vehicles must meet the requirements for fueling connection devices as specified in 40 CFR 86.1813–17(f)(1). Vehicles meeting these requirements are deemed to comply with evaporative and refueling emission standards.

(e) *Incomplete vehicles.* If you sell incomplete vehicles, you must identify the maximum fuel tank capacity for which you designed the vehicle’s evaporative emission control system.

(f) *Useful life.* Your vehicles must meet the evaporative emission standards of this section throughout their useful life, expressed in service miles or calendar years, whichever comes first. The useful life values for the standards of this section are those that apply for criteria pollutants under 40 CFR part 86.

(g) *Auxiliary engines and separate fuel systems.* The provisions of this paragraph (g) apply for vehicles with auxiliary engines. This includes any engines installed in the final vehicle configuration that contribute no motive power through the vehicle’s transmission.

(1) Auxiliary engines and associated fuel-system components must be installed when testing complete vehicles. If the auxiliary engine draws fuel from a separate fuel tank, you must fill the extra fuel tank before the start of diurnal testing as described for the vehicle’s main fuel tank. Use good engineering judgment to ensure that any nonmetal portions of the fuel system related to the auxiliary engine have reached stabilized levels of permeation emissions. The auxiliary engine must not operate during the running loss test or any other portion of testing under this section.

(2) For testing with incomplete vehicles, you may omit installation of auxiliary engines and associated fuel-system components as long as those components installed in the final configuration are certified to meet the applicable emission standards for Small SI equipment described in 40 CFR 1054.112 or for Large SI engines in 40 CFR 1048.105. For any fuel-system components that you do not install, your installation instructions must describe this certification requirement.

■ 227. Section 1037.104 is amended by adding paragraph (h)(2) to read as follows:

**§ 1037.104 Exhaust emission standards for CO<sub>2</sub>, CH<sub>4</sub>, and N<sub>2</sub>O for heavy-duty vehicles at or below 14,000 pounds GVWR.**

\* \* \* \* \*

(h) \* \* \*

(2) The evaporative and refueling emission standards in § 1037.103.

\* \* \* \* \*

**Subpart C—[Amended]**

■ 228. Section 1037.230 is amended by adding paragraph (e) to read as follows:

**§ 1037.230 Vehicle families, sub-families, and configurations.**

\* \* \* \* \*

(e) Divide your vehicles that are subject to evaporative emission standards into groups of vehicles with similar physical features expected to affect evaporative emissions. Group vehicles in the same evaporative emission family if they are the same in all the following aspects, unless we approve a better way of grouping vehicles into families that have similar emission control characteristics:

(1) Method of vapor storage, including the number of vapor storage devices, the working material, and the total working capacity of vapor storage (as determined under 40 CFR 86.132–96(h)(1)(iv)). You may consider the working capacity to be the same if the values differ by 20 grams or less.

(2) Method of purging stored vapors.

(3) Material for liquid and vapor fuel lines.

\* \* \* \* \*

■ 229. A new § 1037.243 is added to subpart C to read as follows:

**§ 1037.243 Demonstrating compliance with evaporative emission standards.**

(a) For purposes of certification, your vehicle family is considered in compliance with the evaporative emission standards in subpart B of this part if you prepare an engineering analysis showing that your vehicles in the family will comply with applicable standards throughout the useful life, and there are no test results from an emission-data vehicle representing the family that exceed an emission standard.

(b) Your evaporative emission family is deemed not to comply if your engineering analysis is not adequate to show that all the vehicles in the family will comply with applicable emission standards throughout the useful life, or if a test result from an emission-data vehicle representing the family exceeds an emission standard.

(c) To compare emission levels with emission standards, apply deterioration factors to the measured emission levels. Establish an additive deterioration factor based on an engineering analysis that takes into account the expected aging from in-use vehicles.

(d) Apply the deterioration factor to the official emission result, as described in paragraph (c) of this section, then round the adjusted figure to the same number of decimal places as the emission standard. Compare the rounded emission levels to the emission standard for each emission-data vehicle.

(e) Your analysis to demonstrate compliance with emission standards must take into account your design strategy for vehicles that require testing. Specifically, vehicles above 14,000 pounds GVWR are presumed to need the same technologies that are required for heavy-duty vehicles at or below 14,000 pounds GVWR. Similarly, your analysis to establish a deterioration factor must take into account your testing to establish deterioration factors for smaller vehicles.

**Subpart F—[Amended]**

■ 230. Section 1037.501 is amended by adding paragraph (a) to read as follows:

**§ 1037.501 General testing and modeling provisions.**

\* \* \* \* \*

(a) Use the equipment and procedures specified in 40 CFR part 1066 to determine whether vehicles meet the evaporative and refueling emission standards specified in § 1037.103.

\* \* \* \* \*

**PART 1039—CONTROL OF EMISSIONS FROM NEW AND IN-USE NONROAD COMPRESSION-IGNITION ENGINES**

■ 231. The authority citation for part 1039 continues to read as follows:

Authority: 42 U.S.C. 7401–7671q.

**Subpart F—[Amended]**

■ 232. Section 1039.505 is revised to read as follows:

**§ 1039.505 How do I test engines using steady-state duty cycles, including ramped-modal testing?**

This section describes how to test engines under steady-state conditions. In some cases, we allow you to choose the appropriate steady-state duty cycle for an engine; you may also choose between discrete-mode and ramped-modal testing. In all cases, you must use the duty cycle you select in your application for certification for all testing you perform for that engine

family. If we test your engines to confirm that they meet emission standards, we will use the duty cycle you select for your own testing. If you submit certification test data using more than one duty cycle, any of the selected duty cycles may be used for any subsequent testing. We may also perform other testing as allowed by the Clean Air Act.

(a) You may perform steady-state testing with either discrete-mode or ramped-modal cycles as described in 40 CFR part 1065.

(b) Measure emissions by testing the engine on a dynamometer with one of the following duty cycles to determine whether it meets the steady-state emission standards in § 1039.101(b):

(1) Use the 5-mode duty cycle or the corresponding ramped-modal cycle described in paragraph (a) of Appendix II of this part for constant-speed engines. Note that these cycles do not apply to all engines used in constant-speed applications, as described in § 1039.801.

(2) Use the 6-mode duty cycle or the corresponding ramped-modal cycle described in paragraph (b) of Appendix II of this part for variable-speed engines below 19 kW. You may instead use the 8-mode duty cycle or the corresponding ramped-modal cycle described in appendix IV of this part if some engines from your engine family will be used in applications that do not involve governing to maintain engine operation around rated speed.

(3) Use the 8-mode duty cycle or the corresponding ramped-modal cycle described in paragraph (c) of Appendix II of this part for variable-speed engines at or above 19 kW.

(c) For constant-speed engines whose design prevents full-load operation for extended periods, you may ask for approval under 40 CFR 1065.10(c) to replace full-load operation with the maximum load for which the engine is designed to operate for extended periods.

(d) To allow non-motoring dynamometers on cycles with idle, you may omit additional points from the duty-cycle regression as follows:

(1) For variable-speed engines with low-speed governors, you may omit speed, torque, and power points from the duty-cycle regression statistics if the following are met:

(i) The engine operator demand is at its minimum.

(ii) The dynamometer demand is at its minimum.

(iii) It is an idle point  $f_{\text{ref}} = 0\%$  (idle) and  $T_{\text{ref}} = 0\%$  (idle).

(iv)  $T_{\text{ref}} < T \leq 5\% \cdot T_{\text{maxmapped}}$ .

(2) For variable-speed engines without low-speed governors, you may omit torque and power points from the duty-cycle regression statistics if the following are met:

- (i) The dynamometer demand is at its minimum.
- (ii) It is an idle point  $f_{nref} = 0\%$  (idle) and  $T_{ref} = 0\%$  (idle).
- (iii)  $f_{nref} - (2\% \cdot f_{ntest}) < f_n < f_{nref} + (2\% \cdot f_{ntest})$ .
- (iv)  $T_{ref} < T \leq 5\% \cdot T_{maxmapped}$ .

#### § 1039.510—[Amended]

- 233. Section 1039.510 is amended by removing paragraph (c).

### PART 1042—CONTROL OF EMISSIONS FROM NEW AND IN-USE MARINE COMPRESSION-IGNITION ENGINES AND VESSELS

- 234. The authority citation for part 1042 continues to read as follows:

Authority: 42 U.S.C. 7401–7671q.

#### Subpart F—[Amended]

- 235. Section 1042.505 is revised to read as follows:

#### § 1042.505 Testing engines using discrete-mode or ramped-modal duty cycles.

This section describes how to test engines under steady-state conditions. In some cases, we allow you to choose the appropriate steady-state duty cycle for an engine; you may also choose between discrete-mode and ramped-modal testing. In all cases, you must use the duty cycle you select in your application for certification for all testing you perform for that engine family. If we test your engines to confirm that they meet emission standards, we will use the duty cycles you select for your own testing. If you submit certification test data using more than one duty cycle, any of the selected duty cycles may be used for any subsequent testing. We may also perform other testing as allowed by the Clean Air Act.

(a) You may perform steady-state testing with either discrete-mode or ramped-modal cycles as described in 40 CFR Part 1065.

(b) Measure emissions by testing the engine on a dynamometer with one of the following duty cycles (as specified) to determine whether it meets the emission standards in §§ 1042.101 or 1042.104:

(1) *General cycle.* Use the 4-mode duty cycle or the corresponding ramped-modal cycle described in paragraph (a) of Appendix II of this part for commercial propulsion marine engines that are used with (or intended

to be used with) fixed-pitch propellers, propeller-law auxiliary engines, and any other engines for which the other duty cycles of this section do not apply. Use this duty cycle also for commercial variable-speed propulsion marine engines that are used with (or intended to be used with) controllable-pitch propellers or with electrically coupled propellers, unless these engines are not intended for sustained operation (e.g., for at least 30 minutes) at all four modes when installed in the vessel.

(2) *Recreational marine engines.* Except as specified in paragraph (b)(3) of this section, use the 5-mode duty cycle or the corresponding ramped-modal cycle described in paragraph (b) of Appendix II of this part for recreational marine engines with maximum engine power at or above 37 kW.

(3) *Controllable-pitch and electrically coupled propellers.* Use the 4-mode duty cycle or the corresponding ramped-modal cycle described in paragraph (c) of Appendix II of this part for constant-speed propulsion marine engines that are used with (or intended to be used with) controllable-pitch propellers or with electrically coupled propellers. Use this duty cycle also for variable-speed propulsion marine engines that are used with (or intended to be used with) controllable-pitch propellers or with electrically coupled propellers if the duty cycles in paragraph (b)(1) and (b)(2) of this section do not apply.

(4) *Constant-speed auxiliary engines.* Use the 5-mode duty cycle or the corresponding ramped-modal cycle described in 40 CFR Part 1039, Appendix II, paragraph (a) for constant-speed auxiliary engines.

(5) *Variable-speed auxiliary engines.* (i) Use the duty cycle specified in paragraph (b)(1) of this section for propeller-law auxiliary engines.

(ii) Use the 6-mode duty cycle or the corresponding ramped-modal cycle described in 40 CFR Part 1039, Appendix II, paragraph (b) for variable-speed auxiliary engines with maximum engine power below 19 kW that are not propeller-law engines.

(iii) Use the 8-mode duty cycle or the corresponding ramped-modal cycle described in 40 CFR Part 1039, Appendix III, paragraph (c) for variable-speed auxiliary engines with maximum engine power at or above 19 kW that are not propeller-law engines.

(c) For constant-speed engines whose design prevents full-load operation for extended periods, you may ask for approval under 40 CFR 1065.10(c) to replace full-load operation with the maximum load for which the engine is

designed to operate for extended periods.

### PART 1048—CONTROL OF EMISSIONS FROM NEW, LARGE NONROAD SPARK-IGNITION ENGINES

- 236. The authority citation for part 1048 continues to read as follows:

Authority: 42 U.S.C. 7401–7671q.

#### Subpart F—[Amended]

- 237. Section 1048.505 is amended by revising the introductory text and paragraphs (a) and (c) and removing paragraphs (d) through (g) to read as follows:

#### § 1048.505 How do I test engines using steady-state duty cycles, including ramped-modal testing?

This section describes how to test engines under steady-state conditions. In some cases, we allow you to choose the appropriate steady-state duty cycle for an engine; you may also choose between discrete-mode and ramped-modal testing. In all cases, you must use the duty cycle you select in your application for certification for all testing you perform for that engine family. If we test your engines to confirm that they meet emission standards, we will use the duty cycles you select for your own testing. If you submit certification test data using more than one duty cycle, any of the selected duty cycles may be used for any subsequent testing. We may also perform other testing as allowed by the Clean Air Act.

(a) You may perform steady-state testing with either discrete-mode or ramped-modal cycles described in 40 CFR Part 1065.

\* \* \* \* \*

(c) For full-load operating modes, operate the engine at wide-open throttle.

### PART 1054—CONTROL OF EMISSIONS FROM NEW, SMALL NONROAD SPARK-IGNITION ENGINES AND EQUIPMENT

- 238. The authority citation for part 1054 continues to read as follows:

Authority: 42 U.S.C. 7401–7671q.

#### Subpart F—[Amended]

- 239. Section 1054.505 is amended by revising paragraph (a) and removing paragraph (e) to read as follows:

#### § 1054.505 How do I test engines?

(a) This section describes how to test engines under steady-state conditions. For handheld engines you must perform

tests with discrete-mode sampling. For nonhandheld engines we allow you to perform tests with either discrete-mode or ramped-modal testing methods, as described in 40 CFR Part 1065. You must use the same modal testing method for certification and all other testing you perform for an engine family. If we test your engines to confirm that they meet emission standards, we will use the modal testing method you select for your own testing. If you submit certification test data collected with both discrete-mode and ramped-modal testing (either in your original application or in an amendment to your application), either method may be used for subsequent testing. We may also perform other testing as allowed by the Clean Air Act. Conduct duty-cycle testing as follows:

(1) For discrete-mode testing, sample emissions separately for each mode, then calculate an average emission level for the whole cycle using the weighting factors specified for each mode. Control engine speed as specified in this section. Use one of the following methods for confirming torque values for nonhandheld engines:

(i) Calculate torque-related cycle statistics and compare with the established criteria as specified in 40 CFR 1065.514 to confirm that the test is valid.

(ii) Evaluate each mode separately to validate the duty cycle. All torque feedback values recorded during non-idle sampling periods must be within ±2 percent of the reference value or within ±0.27 N·m of the reference value, whichever is greater. Also, the mean torque value during non-idle sampling periods must be within ±1 percent of the reference value or ±0.12 N·m of the reference value, whichever is greater. Control torque during idle as specified in paragraph (c) of this section.

(2) Unless we specify otherwise, you may simulate the governor for ramped-modal testing consistent with good engineering judgment.

\* \* \* \* \*

**PART 1065—ENGINE-TESTING PROCEDURES**

■ 240. The authority citation for part 1065 continues to read as follows:

Authority: 42 U.S.C. 7401–7671q.

**Subpart A—[Amended]**

■ 241. Section 1065.1 is amended by revising paragraph (h) to read as follows:

**§ 1065.1 Applicability.**

\* \* \* \* \*

(h) This part describes procedures and specifications for measuring an engine's exhaust emissions. While the measurements are geared toward engine-based measurements (in units of g/kW·hr), many of these provisions apply equally to vehicle-based measurements (in units of g/mile or g/kilometer). 40 CFR Part 1066 describes the analogous procedures for vehicle-based emission measurements, and in many cases states that specific provisions of this part 1065 also apply for those vehicle-based measurements. Where material from this part 1065 applies for vehicle-based measurements under 40 CFR Part 1066, it is sometimes necessary to include parenthetical statements in this part 1065 to properly cite secondary references that are different for vehicle-based testing. See 40 CFR Part 1066 and the standard-setting part for additional information.

■ 242. Section 1065.2 is amended by revising paragraphs (d) and (e) to read as follows:

**§ 1065.2 Submitting information to EPA under this part.**

\* \* \* \* \*

(d) We may require an authorized representative of your company to approve and sign the submission, and to certify that all the information submitted is accurate and complete. This includes everyone who submits information, including manufacturers and others.

(e) See 40 CFR 1068.10 for provisions related to confidential information. Note however that under 40 CFR 2.301, emission data are generally not eligible for confidential treatment.

\* \* \* \* \*

■ 243. Section 1065.10 is amended by revising paragraphs (a), (c)(7) introductory text, and (d) to read as follows:

**§ 1065.10 Other procedures.**

(a) *Your testing.* The procedures in this part apply for all testing you do to show compliance with emission standards, with certain exceptions noted in this section. In some other sections in this part, we allow you to use other procedures (such as less precise or less accurate procedures) if they do not affect your ability to show that your engines comply with the applicable emission standards. This generally requires emission levels to be far enough below the applicable emission standards so that any errors caused by greater imprecision or inaccuracy do not affect your ability to state

unconditionally that the engines meet all applicable emission standards.

\* \* \* \* \*

(c) \* \* \*

(7) You may request to use alternate procedures that are equivalent to the specified procedures, or procedures that are more accurate or more precise than the specified procedures. We may perform tests with your engines using either the approved alternate procedures or the specified procedures. The following provisions apply to requests for alternate procedures:

\* \* \* \* \*

(d) *Advance approval.* If we require you to request approval to use other procedures under paragraph (c) of this section, you may not use them until we approve your request.

■ 244. Section 1065.12 is amended by revising paragraphs (a), (d) introductory text, and (e) introductory text to read as follows:

**§ 1065.12 Approval of alternate procedures.**

(a) To get approval for an alternate procedure under § 1065.10(c), send the Designated Compliance Officer an initial written request describing the alternate procedure and why you believe it is equivalent to the specified procedure. Anyone may request alternate procedure approval. This means that an individual engine manufacturer may request to use an alternate procedure. This also means that an instrument manufacturer may request to have an instrument, equipment, or procedure approved as an alternate procedure to those specified in this part. We may approve your request based on this information alone, whether or not it includes all the information specified in this section. Where we determine that your original submission does not include enough information for us to determine that the alternate procedure is equivalent to the specified procedure, we may ask you to submit supplemental information showing that your alternate procedure is consistently and reliably at least as accurate and repeatable as the specified procedure.

\* \* \* \* \*

(d) If we do not approve your proposed alternate procedure based on the information in your initial request, we may ask you to send additional information to fully evaluate your request. While we consider the information specified in this paragraph (d) and the statistical criteria of paragraph (e) of this section to be sufficient to demonstrate equivalence, it may not be necessary to include all the

information or meet the specified statistical criteria. For example, systems that do not meet the statistical criteria in paragraph (e) of this section because they have a small bias toward high emission results could be approved since they would not adversely affect your ability to demonstrate compliance with applicable standards.

(e) Absent any other directions from us, use a *t*-test and an *F*-test calculated according to § 1065.602 to evaluate whether your proposed alternate procedure is equivalent to the specified procedure. We may give you specific directions regarding methods for statistical analysis, or we may approve other methods that you propose. Such alternate methods may be more or less stringent than those specified in this paragraph (e). In determining the appropriate statistical criteria, we will consider the repeatability of measurements made with the reference procedure. For example, less stringent statistical criteria may be appropriate for measuring emission levels being so low that they adversely affect the repeatability of reference measurements. We recommend that you consult a statistician if you are unfamiliar with these statistical tests. Perform the tests as follows:

\* \* \* \* \*

■ 245. Section 1065.15 is amended by revising paragraphs (a), (b), and (c)(2)(ii) to read as follows:

**§ 1065.15 Overview of procedures for laboratory and field testing.**

\* \* \* \* \*

(a) In the standard-setting part, we set brake-specific emission standards in g/(kW-hr) (or g/(hp-hr)), for the following constituents:

- (1) Total oxides of nitrogen, NO<sub>x</sub>.
  - (2) Hydrocarbons, HC, which may be expressed in the following ways:
    - (i) Total hydrocarbons, THC.
    - (ii) Nonmethane hydrocarbons, NMHC, which results from subtracting methane, CH<sub>4</sub>, from THC.
    - (iii) Total hydrocarbon-equivalent, THCE, which results from adjusting THC mathematically to be equivalent on a carbon-mass basis.
    - (iv) Nonmethane hydrocarbon-equivalent, NMHCE, which results from adjusting NMHC mathematically to be equivalent on a carbon-mass basis.
  - (3) Particulate matter, PM.
  - (4) Carbon monoxide, CO.
  - (5) Carbon dioxide, CO<sub>2</sub>.
  - (6) Methane, CH<sub>4</sub>.
  - (7) Nitrous oxide, N<sub>2</sub>O.
- (b) Note that some engines are not subject to standards for all the emission

constituents identified in paragraph (a) of this section. Note also that the standard-setting part may include standards for pollutants not listed in paragraph (a) of this section.

(c) \* \* \*

(2) \* \* \*

(ii) *Batch sampling.* In batch sampling, continuously extract and store a sample of raw or dilute exhaust for later measurement. Extract a sample proportional to the raw or dilute exhaust flow rate. You may extract and store a proportional sample of exhaust in an appropriate container, such as a bag, and then measure NO<sub>x</sub>, HC, CO, CO<sub>2</sub>, CH<sub>4</sub>, N<sub>2</sub>O, and CH<sub>2</sub>O concentrations in the container after the test interval. You may deposit PM from proportionally extracted exhaust onto an appropriate substrate, such as a filter. In this case, divide the PM by the amount of filtered exhaust to calculate the PM concentration. Multiply batch sampled concentrations by the total (raw or dilute) flow from which it was extracted during the test interval. This product is the total mass of the emitted constituent.

\* \* \* \* \*

■ 246. Section 1065.20 is amended by revising paragraphs (a)(3), (b) introductory text, (c), (f)(1) and (g) to read as follows:

**§ 1065.20 Units of measure and overview of calculations.**

(a) \* \* \*

(3) We generally designate temperatures in units of degrees Celsius (°C) unless a calculation requires an absolute temperature. In that case, we designate temperatures in units of Kelvin (K). For conversion purposes throughout this part, 0 °C equals 273.15 K. Unless specified otherwise, always use absolute temperature values for multiplying or dividing by temperature.

(b) *Concentrations.* This part does not rely on amounts expressed in parts per million. Rather, we express such amounts in the following SI units:

\* \* \* \* \*

(c) *Absolute pressure.* Measure absolute pressure directly or calculate it as the sum of atmospheric pressure plus a differential pressure that is referenced to atmospheric pressure. Always use absolute pressure values for multiplying or dividing by pressure.

\* \* \* \* \*

(f) \* \* \*

(1) Whenever we specify a range by a single value and corresponding limit values above and below that value (such as X ± Y), target the associated control point to that single value (X). Examples of this type of range include “±10% of

maximum pressure”, or “(30 ± 10) kPa”. In these examples, you would target the maximum pressure or 30 kPa, respectively.

\* \* \* \* \*

(g) *Scaling of specifications with respect to an applicable standard.* Because this part 1065 is applicable to a wide range of engines and emission standards, some of the specifications in this part are scaled with respect to an engine’s applicable standard or maximum power. This ensures that the specification will be adequate to determine compliance, but not overly burdensome by requiring unnecessarily high-precision equipment. Many of these specifications are given with respect to a “flow-weighted mean” that is expected at the standard or during testing. Flow-weighted mean is the mean of a quantity after it is weighted proportional to a corresponding flow rate. For example, if a gas concentration is measured continuously from the raw exhaust of an engine, its flow-weighted mean concentration is the sum of the products (dry-to-wet corrected, if applicable) of each recorded concentration times its respective exhaust flow rate, divided by the sum of the recorded flow rates. As another example, the bag concentration from a CVS system is the same as the flow-weighted mean concentration, because the CVS system itself flow-weights the bag concentration. Refer to § 1065.602 for information needed to estimate and calculate flow-weighted means. Wherever a specification is scaled to a value based upon an applicable standard, interpret the standard to be the family emission limit if the engine is certified under an emission credit program in the standard-setting part.

■ 247. Section 1065.25 is revised to read as follows:

**§ 1065.25 Recordkeeping.**

(a) The procedures in this part include various requirements to record data or other information. Refer to the standard-setting part and § 1065.695 regarding specific recordkeeping requirements.

(b) You must promptly send us organized, written records in English if we ask for them. We may review them at any time.

(c) We may waive specific reporting or recordkeeping requirements we determine to be unnecessary for the purposes of this part and the standard-setting part. Note that while we will generally keep the records required by this part, we are not obligated to keep records we determine to be unnecessary for us to keep. For example, while we



require you to keep records for invalid tests so that we may verify that your invalidation was appropriate, it is not necessary for us to keep records for our own invalid tests.

#### Subpart B—[Amended]

■ 248. Section 1065.130 is amended by revising paragraphs (a) and (c)(6) to read as follows:

##### § 1065.130 Engine exhaust.

(a) *General.* Use the exhaust system installed with the engine or one that represents a typical in-use configuration. This includes any applicable aftertreatment devices. We refer to exhaust piping as an exhaust stack; this is equivalent to a tailpipe for vehicle configurations.

\* \* \* \* \*

(c) \* \* \*  
(6) We recommend that you connect multiple exhaust stacks from a single engine into one stack upstream of any emission sampling. For raw or dilute partial-flow emission sampling, to ensure mixing of the multiple exhaust streams before emission sampling, we recommend a minimum Reynolds number,  $Re^{\#}$ , of 4000 for the combined exhaust stream, where  $Re^{\#}$  is based on the inside diameter of the combined flow at the first sampling point. You may configure the exhaust system with turbulence generators, such as orifice plates or fins, to achieve good mixing; inclusion of turbulence generators may be required for  $Re^{\#}$  less than 4000 to ensure good mixing.  $Re^{\#}$  is defined in § 1065.640. For dilute full-flow (CVS) emission sampling, you may configure the exhaust system without regard to mixing in the laboratory section of the raw exhaust. For example you may size the laboratory section to reduce its pressure drop even if the  $Re^{\#}$ , in the laboratory section of the raw exhaust is less than 4000.

\* \* \* \* \*

■ 249. Section 1065.140 is revised to read as follows:

##### § 1065.140 Dilution for gaseous and PM constituents.

(a) *General.* You may dilute exhaust with ambient air, purified air, or nitrogen. References in this part to “dilution air” may include any of these. For gaseous emission measurement, the dilution air must be at least 15 °C. Note that the composition of the dilution air affects some gaseous emission measurement instruments’ response to emissions. We recommend diluting exhaust at a location as close as possible to the location where ambient air dilution would occur in use. Dilution

may occur in a single stage or in multiple stages. For dilution in multiple stages, the first stage is considered primary dilution and later stages are considered secondary dilution.

(b) *Dilution-air conditions and background concentrations.* Before dilution air is mixed with exhaust, you may precondition it by increasing or decreasing its temperature or humidity. You may also remove constituents to reduce their background concentrations. The following provisions apply to removing constituents or accounting for background concentrations:

(1) You may measure constituent concentrations in the dilution air and compensate for background effects on test results. See § 1065.650 for calculations that compensate for background concentrations (40 CFR 1066.610 for vehicle testing).

(2) Measure these background concentrations the same way you measure diluted exhaust constituents, or measure them in a way that does not affect your ability to demonstrate compliance with the applicable standards. For example, you may use the following simplifications for background sampling:

(i) You may disregard any proportional sampling requirements.

(ii) You may use unheated gaseous sampling systems.

(iii) You may use unheated PM sampling systems.

(iv) You may use continuous sampling if you use batch sampling for diluted emissions.

(v) You may use batch sampling if you use continuous sampling for diluted emissions.

(3) For removing background PM, we recommend that you filter all dilution air, including primary full-flow dilution air, with high-efficiency particulate air (HEPA) filters that have an initial minimum collection efficiency specification of 99.97% (see § 1065.1001 for procedures related to HEPA-filtration efficiencies). Ensure that HEPA filters are installed properly so that background PM does not leak past the HEPA filters. If you choose to correct for background PM without using HEPA filtration, demonstrate that the background PM in the dilution air contributes less than 50% to the net PM collected on the sample filter. You may correct net PM without restriction if you use HEPA filtration.

(c) *Full-flow dilution; constant-volume sampling (CVS).* You may dilute the full flow of raw exhaust in a dilution tunnel that maintains a nominally constant volume flow rate, molar flow rate or mass flow rate of diluted exhaust, as follows:

(1) *Construction.* Use a tunnel with inside surfaces of 300 series stainless steel. Electrically ground the entire dilution tunnel. We recommend a thin-walled and insulated dilution tunnel to minimize temperature differences between the wall and the exhaust gases. You may not use any flexible tubing in the dilution tunnel upstream of the PM sample probe. You may use nonconductive flexible tubing downstream of the PM sample probe and upstream of the CVS flow meter; use good engineering judgment to select a tubing material that is not prone to leaks, and configure the tubing to ensure smooth flow at the CVS flow meter.

(2) *Pressure control.* Maintain static pressure at the location where raw exhaust is introduced into the tunnel within  $\pm 1.2$  kPa of atmospheric pressure. You may use a booster blower to control this pressure. If you test using more careful pressure control and you show by engineering analysis or by test data that you require this level of control to demonstrate compliance at the applicable standards, we will maintain the same level of static pressure control when we test.

(3) *Mixing.* Introduce raw exhaust into the tunnel by directing it downstream along the centerline of the tunnel. If you dilute directly from the exhaust stack, the end of the exhaust stack is considered to be the start of the dilution tunnel. You may introduce a fraction of dilution air radially from the tunnel’s inner surface to minimize exhaust interaction with the tunnel walls. You may configure the system with turbulence generators such as orifice plates or fins to achieve good mixing. We recommend a minimum Reynolds number,  $Re^{\#}$ , of 4000 for the diluted exhaust stream, where  $Re^{\#}$  is based on the inside diameter of the dilution tunnel.  $Re^{\#}$  is defined in § 1065.640.

(4) *Flow measurement preconditioning.* You may condition the diluted exhaust before measuring its flow rate, as long as this conditioning takes place downstream of any heated HC or PM sample probes, as follows:

(i) You may use flow straighteners, pulsation dampeners, or both of these.

(ii) You may use a filter.

(iii) You may use a heat exchanger to control the temperature upstream of any flow meter, but you must take steps to prevent aqueous condensation as described in paragraph (c)(6) of this section.

(5) *Flow measurement.* Section 1065.240 describes measurement instruments for diluted exhaust flow.

(6) *Aqueous condensation.* This paragraph (c)(6) describes how you must address aqueous condensation in the

CVS. As described below, you may meet these requirements by preventing or limiting aqueous condensation in the CVS from the exhaust inlet to the last emission sample probe. See that paragraph for provisions related to the CVS between the last emission sample probe and the CVS flow meter. You may heat and/or insulate the dilution tunnel walls, as well as the bulk stream tubing downstream of the tunnel to prevent or limit aqueous condensation. Where we allow aqueous condensation to occur, use good engineering judgment to ensure that the condensation does not affect your ability to demonstrate that your engines comply with the applicable standards (see § 1065.10(a)).

(i) *Preventing aqueous condensation.* To prevent condensation, you must keep the temperature of internal surfaces, excluding any sample probes, above the dew point of the dilute exhaust passing through the CVS tunnel. Use good engineering judgment to monitor temperatures in the CVS. For the purposes of this paragraph (c)(6), assume that aqueous condensation is pure water condensate only, even though the definition of “aqueous condensation” in § 1065.1001 includes condensation of any constituents that contain water. No specific verification check is required under this paragraph (c)(6)(i), but we may ask you to show how you comply with this requirement. You may use engineering analysis, CVS tunnel design, alarm systems, measurements of wall temperatures, and calculation of water dew point to demonstrate compliance with this requirement. For optional CVS heat exchangers, you may use the lowest water temperature at the inlet(s) and outlet(s) to determine the minimum internal surface temperature.

(ii) *Limiting aqueous condensation.* This paragraph (c)(6)(ii) specifies limits of allowable condensation and requires you to verify that the amount of condensation that occurs during each test interval does not exceed the specified limits.

(A) Use chemical balance equations in § 1065.655 to calculate the mole fraction of water in the dilute exhaust continuously during testing. Alternatively, you may continuously measure the mole fraction of water in the dilute exhaust prior to any condensation during testing. Use good engineering judgment to select, calibrate and verify water analyzers/detectors. The linearity verification requirements of § 1065.307 do not apply to water analyzers/detectors used to correct for the water content in exhaust samples.

(B) Use good engineering judgment to select and monitor locations on the CVS

tunnel walls prior to the last emission sample probe. If you are also verifying limited condensation from the last emission sample probe to the CVS flow meter, use good engineering judgment to select and monitor locations on the CVS tunnel walls, optional CVS heat exchanger, and CVS flow meter. For optional CVS heat exchangers, you may use the lowest water temperature at the inlet(s) and outlet(s) to determine the minimum internal surface temperature. Identify the minimum surface temperature on a continuous basis.

(C) Identify the maximum potential mole fraction of dilute exhaust lost on a continuous basis during the entire test interval. This value must be less than or equal to 0.02. Calculate on a continuous basis the mole fraction of water that would be in equilibrium with liquid water at the measured minimum surface temperature. Subtract this mole fraction from the mole fraction of water that would be in the exhaust without condensation (either measured or from the chemical balance), and set any negative values to zero. This difference is the potential mole fraction of the dilute exhaust that would be lost due to water condensation on a continuous basis.

(D) Integrate the product of the molar flow rate of the dilute exhaust and the potential mole fraction of dilute exhaust lost, and divide by the totalized dilute exhaust molar flow over the test interval. This is the potential mole fraction of the dilute exhaust that would be lost due to water condensation over the entire test interval. Note that this assumes no re-evaporation. This value must be less than or equal to 0.005.

(7) *Flow compensation.* Maintain nominally constant molar, volumetric or mass flow of diluted exhaust. You may maintain nominally constant flow by either maintaining the temperature and pressure at the flow meter or by directly controlling the flow of diluted exhaust. You may also directly control the flow of proportional samplers to maintain proportional sampling. For an individual test, verify proportional sampling as described in § 1065.545.

(d) *Partial-flow dilution (PFD).* You may dilute a partial flow of raw or previously diluted exhaust before measuring emissions. Section 1065.240 describes PFD-related flow measurement instruments. PFD may consist of constant or varying dilution ratios as described in paragraphs (d)(2) and (3) of this section. An example of a constant dilution ratio PFD is a “secondary dilution PM” measurement system.

(1) *Applicability.* (i) You may use PFD to extract a proportional raw exhaust

sample for any batch or continuous PM emission sampling over any transient duty cycle, any steady-state duty cycle, or any ramped-modal cycle.

(ii) You may use PFD to extract a proportional raw exhaust sample for any batch or continuous gaseous emission sampling over any transient duty cycle, any steady-state duty cycle, or any ramped-modal cycle.

(iii) You may use PFD to extract a proportional raw exhaust sample for any batch or continuous field-testing.

(iv) You may use PFD to extract a proportional diluted exhaust sample from a CVS for any batch or continuous emission sampling.

(v) You may use PFD to extract a constant raw or diluted exhaust sample for any continuous emission sampling.

(vi) You may use PFD to extract a constant raw or diluted exhaust sample for any steady-state emission sampling.

(2) Constant dilution-ratio PFD. Do one of the following for constant dilution-ratio PFD:

(i) Dilute an already proportional flow. For example, you may do this as a way of performing secondary dilution from a CVS tunnel to achieve overall dilution ratio for PM sampling.

(ii) Continuously measure constituent concentrations. For example, you might dilute to precondition a sample of raw exhaust to control its temperature, humidity, or constituent concentrations upstream of continuous analyzers. In this case, you must take into account the dilution ratio before multiplying the continuous concentration by the sampled exhaust flow rate.

(iii) Extract a proportional sample from a separate constant dilution ratio PFD system. For example, you might use a variable-flow pump to proportionally fill a gaseous storage medium such as a bag from a PFD system. In this case, the proportional sampling must meet the same specifications as varying dilution ratio PFD in paragraph (d)(3) of this section.

(iv) For each mode of a discrete-mode test (such as a locomotive notch setting or a specific setting for speed and torque), use a constant dilution ratio for any PM sampling. You must change the overall PM sampling system dilution ratio between modes so that the dilution ratio on the mode with the highest exhaust flow rate meets § 1065.140(e)(2) and the dilution ratios on all other modes is higher than this (minimum) dilution ratio by the ratio of the maximum exhaust flow rate to the exhaust flow rate of the corresponding other mode. This is the same dilution ratio requirement for RMC or field transient testing. You must account for

this change in dilution ratio in your emission calculations.

(3) Varying dilution-ratio PFD. All the following provisions apply for varying dilution-ratio PFD:

(i) Use a control system with sensors and actuators that can maintain proportional sampling over intervals as short as 200 ms (i.e., 5 Hz control).

(ii) For control input, you may use any sensor output from one or more measurements; for example, intake-air flow, fuel flow, exhaust flow, engine speed, and intake manifold temperature and pressure.

(iii) Account for any emission transit time in the PFD system, as necessary.

(iv) You may use preprogrammed data if they have been determined for the specific test site, duty cycle, and test engine from which you dilute emissions.

(v) We recommend that you run practice cycles to meet the verification criteria in § 1065.545. Note that you must verify every emission test by meeting the verification criteria with the data from that specific test. Data from previously verified practice cycles or other tests may not be used to verify a different emission test.

(vi) You may not use a PFD system that requires preparatory tuning or calibration with a CVS or with the emission results from a CVS. Rather, you must be able to independently calibrate the PFD.

(e) *Dilution air temperature, dilution ratio, residence time, and temperature control of PM samples.* Dilute PM samples at least once upstream of transfer lines. You may dilute PM samples upstream of a transfer line using full-flow dilution, or partial-flow dilution immediately downstream of a PM probe. In the case of partial-flow dilution, you may have up to 26 cm of insulated length between the end of the probe and the dilution stage, but we recommend that the length be as short as practical. The intent of these specifications is to minimize heat transfer to or from the emission sample before the final stage of dilution, other than the heat you may need to add to prevent aqueous condensation. This is accomplished by initially cooling the sample through dilution. Configure dilution systems as follows:

(1) Set the dilution air temperature to  $(25 \pm 5)$  °C. Use good engineering judgment to select a location to measure this temperature that is as close as practical upstream of the point where dilution air mixes with raw exhaust.

(2) For any PM dilution system (i.e., CVS or PFD), add dilution air to the raw exhaust such that the minimum overall ratio of diluted exhaust to raw exhaust

is within the range of (5:1 to 7:1) and is at least 2:1 for any primary dilution stage. Base this minimum value on the maximum engine exhaust flow rate for a given test interval. Either measure the maximum exhaust flow during a practice run of the test interval or estimate it based on good engineering judgment (for example, you might rely on manufacturer-published literature).

(3) Configure any PM dilution system to have an overall residence time of (1.0 to 5.5) s, as measured from the location of initial dilution air introduction to the location where PM is collected on the sample media. Also configure the system to have a residence time of at least 0.50 s, as measured from the location of final dilution air introduction to the location where PM is collected on the sample media. When determining residence times within sampling system volumes, use an assumed flow temperature of 25 °C and pressure of 101.325 kPa.

(4) Control sample temperature to a  $(47 \pm 5)$  °C tolerance, as measured anywhere within 20 cm upstream or downstream of the PM storage media (such as a filter). Measure this temperature with a bare-wire junction thermocouple with wires that are  $(0.500 \pm 0.025)$  mm diameter, or with another suitable instrument that has equivalent performance.

■ 250. Section 1065.145 is amended by revising paragraphs (a), (c)(1), (c)(2)(ii), (d)(1)(ii), (e)(2)(ii), and (e)(3)(ii) to read as follows:

**§ 1065.145 Gaseous and PM probes, transfer lines, and sampling system components.**

(a) *Continuous and batch sampling.* Determine the total mass of each constituent with continuous or batch sampling. Both types of sampling systems have probes, transfer lines, and other sampling system components that are described in this section.

\* \* \* \* \*

(c) \* \* \*

(1) *Probe design and construction.* Use sample probes with inside surfaces of 300 series stainless steel or, for raw exhaust sampling, use any nonreactive material capable of withstanding raw exhaust temperatures. Locate sample probes where constituents are mixed to their mean sample concentration. Take into account the mixing of any crankcase emissions that may be routed into the raw exhaust. Locate each probe to minimize interference with the flow to other probes. We recommend that all probes remain free from influences of boundary layers, wakes, and eddies—especially near the outlet of a raw-

exhaust stack where unintended dilution might occur. Make sure that purging or back-flushing of a probe does not influence another probe during testing. You may use a single probe to extract a sample of more than one constituent as long as the probe meets all the specifications for each constituent.

\* \* \* \* \*

(2) \* \* \*

(ii) For probes that extract hydrocarbons for THC or NMHC analysis from the diluted exhaust of compression-ignition engines, two-stroke spark-ignition engines, or four-stroke spark-ignition engines at or below 19 kW, we recommend heating the probe to minimize hydrocarbon contamination consistent with good engineering judgment. If you routinely fail the contamination check in the 1065.520 pretest check, we recommend heating the probe section to approximately 190 °C to minimize contamination.

\* \* \* \* \*

(d) \* \* \*

(1) \* \* \*

(ii) For THC transfer lines for testing compression-ignition engines, two-stroke spark-ignition engines, or four-stroke spark-ignition engines at or below 19 kW, maintain a wall temperature tolerance throughout the entire line of  $(191 \pm 11)$  °C. If you sample from raw exhaust, you may connect an unheated, insulated transfer line directly to a probe. Design the length and insulation of the transfer line to cool the highest expected raw exhaust temperature to no lower than 191 °C, as measured at the transfer line's outlet. For dilute sampling, you may use a transition zone between the probe and transfer line of up to 92 cm to allow your wall temperature to transition to  $(191 \pm 11)$  °C.

\* \* \* \* \*

(e) \* \* \*

(2) \* \* \*

(ii) *Thermal chiller.* You may use a thermal chiller upstream of some gas analyzers and storage media. You may not use a thermal chiller upstream of a THC measurement system for compression-ignition engines, two-stroke spark-ignition engines, or four-stroke spark-ignition engines at or below 19 kW. If you use a thermal chiller upstream of an NO<sub>2</sub>-to-NO converter or in a sampling system without an NO<sub>2</sub>-to-NO converter, the chiller must meet the NO<sub>2</sub> loss-performance check specified in § 1065.376. Monitor the dewpoint,  $T_{\text{dew}}$ , and absolute pressure,  $p_{\text{total}}$ , downstream of a thermal chiller. You may use continuously recorded

values of  $T_{dew}$  and  $p_{total}$  in the amount of water calculations specified in § 1065.645. If it is valid to assume the degree of saturation in the thermal chiller, you may calculate  $T_{dew}$  based on the known chiller performance and continuous monitoring of chiller temperature,  $T_{chiller}$ . If it is valid to assume a constant temperature offset between  $T_{chiller}$  and  $T_{dew}$ , due to a known and fixed amount of sample reheat between the chiller outlet and the temperature measurement location, you may factor in this assumed temperature offset value into emission calculations. If we ask for it, you must show by engineering analysis or by data the validity of any assumptions allowed by this paragraph (e)(2)(ii). For our testing we may use average temperature and pressure values over the test interval or a nominal pressure value that we estimate as the dryer's average pressure expected during testing as constant values in the calculations specified in § 1065.645. For your testing you may use the maximum temperature and minimum pressure values observed during a test interval or duty cycle or the high alarm temperature setpoint and the low alarm pressure setpoint as constant values in the amount of water calculations specified in § 1065.645. For your testing you may also use a nominal  $p_{total}$ , which you may estimate as the

dryer's lowest absolute pressure expected during testing.

(3) \* \* \*  
 (ii) For testing compression-ignition engines, two-stroke spark-ignition engines, or four-stroke spark-ignition engines at or below 19 kW, if you use a THC sample pump upstream of a THC analyzer or storage medium, its inner surfaces must be heated to a tolerance of  $(191 \pm 11)$  °C.  
 \* \* \* \* \*

■ 251. Section 1065.170 is amended by revising paragraphs (a)(1), (b) including Table 1, (c)(1)(i), and Figure 1 to read as follows:

**§ 1065.170 Batch sampling for gaseous and PM constituents.**

\* \* \* \* \*

(a) \* \* \*

(1) Verify proportional sampling after an emission test as described in § 1065.545. Use good engineering judgment to select storage media that will not significantly change measured emission levels (either up or down). For example, do not use sample bags for storing emissions if the bags are permeable with respect to emissions or if they off gas emissions to the extent that it affects your ability to demonstrate compliance with the applicable gaseous emission standards. As another example, do not use PM filters that irreversibly absorb or adsorb gases to the extent that it affects your ability to

demonstrate compliance with the applicable PM emission standard.

\* \* \* \* \*

(b) *Gaseous sample storage media.* Store gas volumes in sufficiently clean containers that minimally off-gas or allow permeation of gases. Use good engineering judgment to determine acceptable thresholds of storage media cleanliness and permeation. To clean a container, you may repeatedly purge and evacuate a container and you may heat it. Use a flexible container (such as a bag) within a temperature-controlled environment, or use a temperature controlled rigid container that is initially evacuated or has a volume that can be displaced, such as a piston and cylinder arrangement. Use containers meeting the specifications in the Table 1 of this section, noting that you may request to use other container materials under § 1065.10. Sample temperatures must stay within the following ranges for each container material:

(1) Up to 40 °C for Tedlar™ and Kynar™.

(2)  $(191 \pm 11)$  °C for Teflon™ and 300 series stainless steel used with measuring THC or NMHC from compression-ignition engines, two-stroke spark-ignition engines, and four-stroke spark-ignition engines at or below 19 kW. For all other engines and pollutants, these materials may be used for sample temperatures up to 202 °C.

TABLE 1 OF § 1065.170—CONTAINER MATERIALS FOR GASEOUS BATCH SAMPLING

Emissions	Engine type	All other engines
	Compression-ignition Two-stroke spark-ignition Four-stroke spark-ignition at or below 19 kW	
CO, CO <sub>2</sub> , O <sub>2</sub> , CH <sub>4</sub> , C <sub>2</sub> H <sub>6</sub> , C <sub>3</sub> H <sub>8</sub> , NO, NO <sub>2</sub> , N <sub>2</sub> O	Tedlar™, Kynar™, Teflon™, or 300 series stainless steel..	Tedlar™, Kynar™, Teflon™, or 300 series stainless steel.
THC, NMHC .....	Teflon™ or 300 series stainless steel .....	Tedlar™, Kynar™, Teflon™, or 300 series stainless steel.

(c) \* \* \*

(1) \* \* \*

(i) If you expect that a filter's total surface concentration of PM will exceed 400 µg, assuming a 38 mm diameter filter stain area, for a given test interval, you may use filter media with a

minimum initial collection efficiency of 98%; otherwise you must use a filter media with a minimum initial collection efficiency of 99.7%. Collection efficiency must be measured as described in ASTM D2986 (incorporated by reference in

§ 1065.1010), though you may rely on the sample-media manufacturer's measurements reflected in their product ratings to show that you meet this requirement.

\* \* \* \* \*

Figure 1 of §1065.170—PM filter cassette specifications.

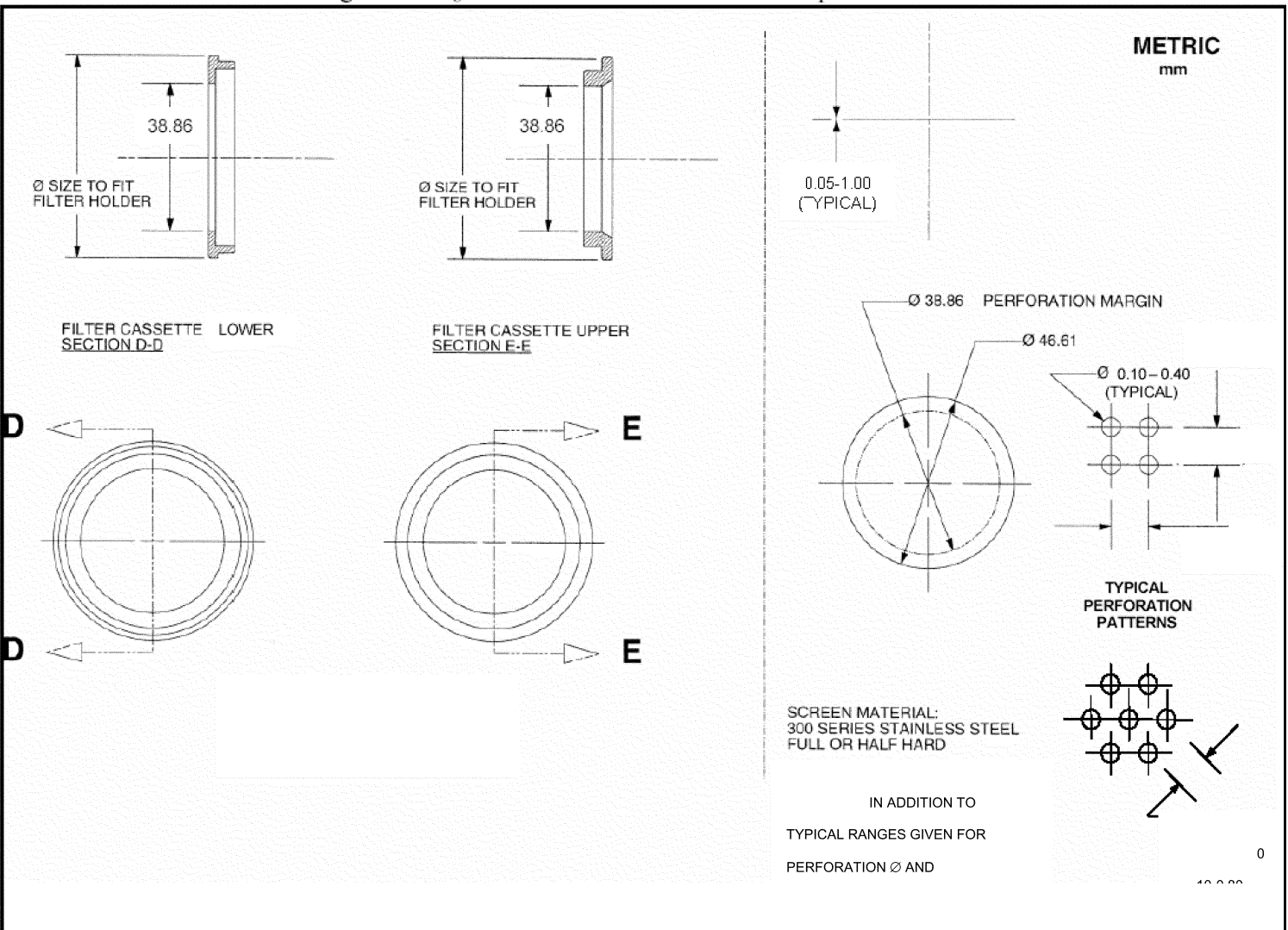

**Subpart C—[Amended]**

■ 252. Section 1065.201 is amended by revising paragraphs (b), (d), (e), and (h) to read as follows:

**§ 1065.201 Overview and general provisions.**

(b) *Instrument types.* You may use any of the specified instruments as

described in this subpart to perform emission tests. If you want to use one of these instruments in a way that is not specified in this subpart, or if you want to use a different instrument, you must first get us to approve your alternate procedure under § 1065.10. Where we specify more than one instrument for a particular measurement, we may identify which instrument serves as the

reference for comparing with an alternate procedure. You may generally use instruments with compensation algorithms that are functions of other gaseous measurements and the known or assumed fuel properties for the test fuel. The target value for any compensation algorithm is 0% (that is,

no bias high and no bias low), regardless of the uncompensated signal's bias.

\* \* \* \* \*

(d) *Redundant systems.* For all measurement instruments described in this subpart, you may use data from multiple instruments to calculate test results for a single test. If you use redundant systems, use good engineering judgment to use multiple measured values in calculations or to disregard individual measurements. Note that you must keep your results from all measurements. This requirement applies whether or not you actually use the measurements in your calculations.

(e) *Range.* You may use an instrument's response above 100% of its operating range if this does not affect your ability to show that your engines

comply with the applicable emission standards. Note that we require additional testing and reporting if an analyzer responds above 100% of its range. Auto-ranging analyzers do not require additional testing or reporting.

\* \* \* \* \*

(h) *Recommended practices.* This subpart identifies a variety of recommended but not required practices for proper measurements. We believe in most cases it is necessary to follow these recommended practices for accurate and repeatable measurements. However, we do not specifically require you to follow these recommended practices to perform a valid test, as long as you meet the required calibrations and verifications of measurement systems specified in subpart D of this part. Similarly, we are not required to follow

all recommended practices, as long as we meet the required calibrations and verifications. Our decision to follow or not follow a given recommendation when we perform a test does not depend on whether you followed it during your testing.

■ 253. Section 1065.202 is revised to read as follows:

**§ 1065.202 Data updating, recording, and control.**

Your test system must be able to update data, record data and control systems related to operator demand, the dynamometer, sampling equipment, and measurement instruments. Use data acquisition and control systems that can record at the specified minimum frequencies, as follows:

TABLE 1 OF § 1065.202—DATA RECORDING AND CONTROL MINIMUM FREQUENCIES

Applicable test protocol section	Measured values	Minimum command and control frequency <sup>a</sup>	Minimum recording frequency <sup>b,c</sup>
§ 1065.510	Speed and torque during an engine step-map	1 Hz	1 mean value per step.
§ 1065.510	Speed and torque during an engine sweep-map	5 Hz	1 Hz means.
§ 1065.514; § 1065.530	Transient duty cycle reference and feedback speeds and torques.	5 Hz	1 Hz means.
§ 1065.514; § 1065.530	Steady-state and ramped-modal duty cycle reference and feedback speeds and torques.	1 Hz	1 Hz.
§ 1065.520; § 1065.530; § 1065.550	Continuous concentrations of raw or dilute analyzers.		1 Hz.
§ 1065.520; § 1065.530	Batch concentrations of raw or dilute analyzers		1 mean value per test interval.
§ 1065.550			1 Hz.
§ 1065.530; § 1065.545	Diluted exhaust flow rate from a CVS with a heat exchanger upstream of the flow measurement.		1 Hz.
§ 1065.530; § 1065.545	Diluted exhaust flow rate from a CVS without a heat exchanger upstream of the flow measurement.	5 Hz	1 Hz means.
§ 1065.530; § 1065.545	Intake-air or raw-exhaust flow rate		1 Hz means.
§ 1065.530; § 1065.545	Dilution air flow if actively controlled (for example, a partial-flow PM sampling system) <sup>d</sup> .	5 Hz	1 Hz means.
§ 1065.530; § 1065.545	Sample flow from a CVS that has a heat exchanger.	1 Hz	1 Hz.
§ 1065.530; § 1065.545	Sample flow from a CVS that does not have a heat exchanger.	5 Hz	1 Hz means.

<sup>a</sup> The specifications for minimum command and control frequency do not apply for CFVs that are not using active control.

<sup>b</sup> 1 Hz means are data reported from the instrument at a higher frequency, but recorded as a series of 1 s mean values at a rate of 1 Hz.

<sup>c</sup> For CFVs in a CVS, the minimum recording frequency is 1 Hz. The minimum recording frequency does not apply for CFVs used to control sampling from a CVS utilizing CFVs.

<sup>d</sup> Dilution air flow specifications do not apply for CVS dilution air.

■ 254. Section 1065.205 is revised to read as follows:

**§ 1065.205 Performance specifications for measurement instruments.**

Your test system as a whole must meet all the calibrations, verifications,

and test-validation criteria specified outside this section for laboratory testing or field testing, as applicable. We recommend that your instruments meet the specifications in Table 1 of this section for all ranges you use for testing.

We also recommend that you keep any documentation you receive from instrument manufacturers showing that your instruments meet the specifications in Table 1 of this section.

TABLE 1 OF § 1065.205—RECOMMENDED PERFORMANCE SPECIFICATIONS FOR MEASUREMENT INSTRUMENTS

Measurement instrument	Measured quantity symbol	Complete system rise time ( $t_{10-90}$ ) and fall time ( $t_{90-10}$ ) <sup>a</sup>	Recording update frequency	Accuracy <sup>b</sup>	Repeatability <sup>b</sup>	Noise <sup>b</sup>
Engine speed transducer	$f_n$	1 s	1 Hz means	2% of pt. or 0.5% of max.	1% of pt. or 0.25% of max.	0.05% of max.
Engine torque transducer	$T$	1 s	1 Hz means	2% of pt. or 1% of max.	1% of pt. or 0.5% of max.	0.05% of max.
Electrical work (active-power meter)	$W$	1 s	1 Hz means	2% of pt. or 0.5% of max.	1% of pt. or 0.25% of max.	0.05% of max.
General pressure transducer (not a part of another instrument).	$p$	5 s	1 Hz	2% of pt. or 1% of max.	1% of pt. or 0.5% of max.	0.1% of max.
Atmospheric pressure meter for PM-stabilization and balance environments.	$p_{atmos}$	50 s	5 times per hour.	50 Pa	25 Pa	5 Pa
General purpose atmospheric pressure meter	$p_{atmos}$	50 s	5 times per hour.	250 Pa	100Pa	50 Pa
Temperature sensor for PM-stabilization and balance environments.	$T$	50 s	0.1 Hz	0.25 K	0.1 K	0.1 K
Other temperature sensor (not a part of another instrument).	$T$	10 s	0.5 Hz	0.4% of pt. K or 0.2% of max K.	0.2% of pt. K or 0.1% of max K.	0.1% of max.
Dewpoint sensor for intake air, PM-stabilization and balance environments.	$T_{dew}$	50 s	0.1 Hz	0.25 K	0.1 K	0.02 K
Other dewpoint sensor	$T_{dew}$	50 s	0.1 Hz	1 K	0.5 K	0.1 K
Fuel flow meter <sup>c</sup> (Fuel totalizer)	$\dot{m}$	5 s (—)	1 Hz (—)	2% of pt. or 1.5% of max.	1% of pt. or 0.75% of max.	0.5% of max.
Total diluted exhaust meter (CVS) <sup>c</sup> (With heat exchanger before meter).	$\dot{n}$	1 s (5 s)	1 Hz means (1 Hz)	2% of pt. or 1.5% of max.	1% of pt. or 0.75% of max.	1% of max.
Dilution air, inlet air, exhaust, and sample flow meters <sup>c</sup> .	$\dot{n}$	1 s	1 Hz means of 5 Hz samples.	2.5% of pt. or 1.5% of max.	1.25% of pt. or 0.75% of max.	1% of max.
Continuous gas analyzer	$x$	5 s	1 Hz	2% of pt. or 2% of meas.	1% of pt. or 1% of meas.	1% of max.
Batch gas analyzer	$X$			2% of pt. or 2% of meas.	1% of pt. or 1% of meas.	1% of max.
Gravimetric PM balance	$m_{PM}$			See § 1065.790.	0.5 µg	
Inertial PM balance	$m_{PM}$	5 s	1 Hz	2% of pt. or 2% of meas.	1% of pt. or 1% of meas.	0.2% of max

<sup>a</sup> The performance specifications identified in the table apply separately for rise time and fall time.

<sup>b</sup> Accuracy, repeatability, and noise are all determined with the same collected data, as described in § 1065.305, and based on absolute values. "pt." refers to the overall flow-weighted mean value expected at the standard; "max" refers to the peak value expected at the standard over any test interval, not the maximum of the instrument's range; "meas" refers to the actual flow-weighted mean measured over any test interval.

<sup>c</sup> The procedure for accuracy, repeatability and noise measurement described in § 1065.305 may be modified for flow meters to allow noise to be measured at the lowest calibrated value instead of zero flow rate.

■ 255. Section 1065.210 is amended by revising paragraph (c) to read as follows:

**§ 1065.210 Work input and output sensors.**  
\* \* \* \* \*

(c) *Electrical work.* Use a watt-hour meter output to calculate total work according to § 1065.650. Use a watt-hour meter that outputs active power. Watt-hour meters typically combine a Wheatstone bridge voltmeter and a Hall-effect clamp-on ammeter into a single microprocessor-based instrument that analyzes and outputs several

parameters, such as alternating or direct current voltage, current, power factor, apparent power, reactive power, and active power.  
\* \* \* \* \*

■ 256. Section 1065.225 is amended by revising paragraph (a) to read as follows:

**§ 1065.225 Intake-air flow meter.**

(a) *Application.* You may use an intake-air flow meter in combination with a chemical balance of fuel, inlet air, and exhaust to calculate raw

exhaust flow as described in § 1065.655(e) and (f), as follows:

(1) Use the actual value of calculated raw exhaust in the following cases:

- (i) For multiplying raw exhaust flow rate with continuously sampled concentrations.
- (ii) For multiplying total raw exhaust flow with batch-sampled concentrations.
- (iii) For verifying minimum dilution ratio for PM batch sampling as described in § 1065.546.



(iv) For calculating the dilution air flow for background correction as described in § 1065.667.

(2) In the following cases, you may use an intake-air flow meter signal that does not give the actual value of raw exhaust, as long as it is linearly proportional to the exhaust flow rate's actual calculated value:

(i) For feedback control of a proportional sampling system, such as a partial-flow dilution system.

(ii) For multiplying with continuously sampled gas concentrations, if the same signal is used in a chemical-balance calculation to determine work from brake-specific fuel consumption and fuel consumed.

\* \* \* \* \*

■ 257. Section 1065.230 is amended by revising paragraph (d) to read as follows:

**§ 1065.230 Raw exhaust flow meter.**

\* \* \* \* \*

(d) *Exhaust cooling.* You may cool raw exhaust upstream of a raw-exhaust flow meter, as long as you observe all the following provisions:

(1) Do not sample PM downstream of the cooling.

(2) If cooling causes exhaust temperatures above 202 °C to decrease to below 180 °C, do not sample NMHC downstream of the cooling for compression-ignition engines, two-stroke spark-ignition engines, or four-stroke spark-ignition engines at or below 19 kW.

(3) The cooling must not cause aqueous condensation.

■ 258. Section 1065.240 is amended by revising paragraph (d) to read as follows:

**§ 1065.240 Dilution air and diluted exhaust flow meters.**

\* \* \* \* \*

(d) *Exhaust cooling.* You may cool diluted exhaust upstream of a dilute-exhaust flow meter, as long as you observe all the following provisions:

(1) Do not sample PM downstream of the cooling.

(2) If cooling causes exhaust temperatures above 202 °C to decrease to below 180 °C, do not sample NMHC downstream of the cooling for compression-ignition engines, two-stroke spark-ignition engines, or four-stroke spark-ignition engines at or below 19 kW.

(3) The cooling must not cause aqueous condensation as described in § 1065.140(c)(6).

■ 259. Section 1065.250 is amended by revising paragraph (b) to read as follows:

**§ 1065.250 Nondispersive infrared analyzer.**

\* \* \* \* \*

(b) *Component requirements.* We recommend that you use an NDIR analyzer that meets the specifications in Table 1 of § 1065.205. Note that your NDIR-based system must meet the calibration and verifications in §§ 1065.350 and 1065.355 and it must also meet the linearity verification in § 1065.307.

■ 260. Section 1065.260 is amended by revising paragraphs (b), (c), and (e) to read as follows:

**§ 1065.260 Flame-ionization detector.**

\* \* \* \* \*

(b) *Component requirements.* We recommend that you use a FID analyzer that meets the specifications in Table 1 of § 1065.205. Note that your FID-based system for measuring THC, THCE, or CH<sub>4</sub> must meet all the verifications for hydrocarbon measurement in subpart D of this part, and it must also meet the linearity verification in § 1065.307.

(c) *Heated FID analyzers.* For measuring THC or THCE from compression-ignition engines, two-stroke spark-ignition engines, and four-stroke spark-ignition engines at or below 19 kW, you must use heated FID analyzers that maintain all surfaces that are exposed to emissions at a temperature of (191 ±11) °C.

\* \* \* \* \*

(e) *NMHC and NMOG.* For demonstrating compliance with NMHC standards, you may either measure THC and CH<sub>4</sub> and determine NMHC as described in § 1065.660(b)(2) or (3), or you may measure THC and determine NMHC mass as described in § 1065.660(b)(1). See 40 CFR 1066.635 for methods to demonstrate compliance with NMOG standards for vehicle testing.

\* \* \* \* \*

■ 261. Section 1065.267 is amended by revising paragraph (b) to read as follows:

**§ 1065.267 Gas chromatograph with a flame ionization detector.**

\* \* \* \* \*

(b) *Component requirements.* We recommend that you use a GC-FID that meets the specifications in Table 1 of § 1065.205 and that the measurement be done according to SAE J1151 (incorporated by reference in § 1065.1010). The GC-FID must meet the linearity verification in § 1065.307.

■ 262. A new § 1065.269 is added to subpart C under the center header "Hydrocarbon Measurements" to read as follows:

**§ 1065.269 Photoacoustic analyzer for ethanol and methanol.**

(a) *Application.* You may use a photoacoustic analyzer to measure ethanol and/or methanol concentrations in diluted exhaust for batch sampling.

(b) *Component requirements.* We recommend that you use a photoacoustic analyzer that meets the specifications in Table 1 of § 1065.205. Note that your photoacoustic system must meet the verification in § 1065.369 and it must also meet the linearity verification in § 1065.307. Use an optical wheel configuration that gives analytical priority to measurement of the least stable components in the sample. Select a sample integration time of at least 5 seconds. Take into account sample chamber and sample line volumes when determining flush times for your instrument.

■ 263. Section 1065.270 is amended by revising paragraph (b) to read as follows:

**§ 1065.270 Chemiluminescent detector.**

\* \* \* \* \*

(b) *Component requirements.* We recommend that you use a CLD that meets the specifications in Table 1 of § 1065.205. Note that your CLD-based system must meet the quench verification in § 1065.370 and it must also meet the linearity verification in § 1065.307. You may use a heated or unheated CLD, and you may use a CLD that operates at atmospheric pressure or under a vacuum.

\* \* \* \* \*

■ 264. Section 1065.272 is amended by revising paragraph (b) to read as follows:

**§ 1065.272 Nondispersive ultraviolet analyzer.**

\* \* \* \* \*

(b) *Component requirements.* We recommend that you use an NDUV analyzer that meets the specifications in Table 1 of § 1065.205. Note that your NDUV-based system must meet the verifications in § 1065.372 and it must also meet the linearity verification in § 1065.307.

\* \* \* \* \*

■ 265. Section 1065.275 is amended by revising paragraph (b) to read as follows:

**§ 1065.275 N<sub>2</sub>O measurement devices.**

\* \* \* \* \*

(b) *Instrument types.* You may use any of the following analyzers to measure N<sub>2</sub>O:

(1) Nondispersive infrared (NDIR) analyzer.

(2) Fourier transform infrared (FTIR) analyzer. Use appropriate analytical procedures for interpretation of infrared spectra. For example, EPA Test Method

320 is considered a valid method for spectral interpretation (see <http://www.epa.gov/ttn/emc/methods/method320.html>).

(3) Laser infrared analyzer. Examples of laser infrared analyzers are pulsed-mode high-resolution narrow band mid-infrared analyzers, and modulated continuous wave high-resolution narrow band mid-infrared analyzers.

(4) Photoacoustic analyzer. Use an optical wheel configuration that gives analytical priority to measurement of the least stable components in the sample. Select a sample integration time of at least 5 seconds. Take into account sample chamber and sample line volumes when determining flush times for your instrument.

(5) Gas chromatograph analyzer. You may use a gas chromatograph with an electron-capture detector (GC-ECD) to measure N<sub>2</sub>O concentrations of diluted exhaust for batch sampling.

(i) You may use a packed or porous layer open tubular (PLOT) column phase of suitable polarity and length to achieve adequate resolution of the N<sub>2</sub>O peak for analysis. Examples of acceptable columns are a PLOT column consisting of bonded polystyrene-divinylbenzene or a Porapack Q packed column. Take the column temperature profile and carrier gas selection into consideration when setting up your

method to achieve adequate N<sub>2</sub>O peak resolution.

(ii) Use good engineering judgment to zero your instrument and correct for drift. You do not need to follow the specific procedures in §§ 1065.530 and 1065.550(b) that would otherwise apply. For example, you may perform a span gas measurement before and after sample analysis without zeroing and use the average area counts of the pre-span and post-span measurements to generate a response factor (area counts/span gas concentration), which you then multiply by the area counts from your sample to generate the sample concentration.

\* \* \* \* \*

■ 266. Section 1065.280 is amended by revising paragraph (b) to read as follows:

**§ 1065.280 Paramagnetic and magnetopneumatic O<sub>2</sub> detection analyzers.**

\* \* \* \* \*

(b) *Component requirements.* We recommend that you use a PMD or MPD analyzer that meets the specifications in Table 1 of § 1065.205. Note that it must meet the linearity verification in § 1065.307.

■ 267. Section 1065.284 is amended by revising paragraph (b) to read as follows:

**§ 1065.284 Zirconia (ZrO<sub>2</sub>) analyzer.**

\* \* \* \* \*

(b) *Component requirements.* We recommend that you use a ZrO<sub>2</sub> analyzer that meets the specifications in Table 1 of § 1065.205. Note that your ZrO<sub>2</sub>-based system must meet the linearity verification in § 1065.307.

■ 268. Section 1065.295 is amended by revising paragraph (b) to read as follows:

**§ 1065.295 PM inertial balance for field-testing analysis.**

\* \* \* \* \*

(b) *Component requirements.* We recommend that you use a balance that meets the specifications in Table 1 of § 1065.205. Note that your balance-based system must meet the linearity verification in § 1065.307. If the balance uses an internal calibration process for routine spanning and linearity verifications, the process must be NIST-traceable.

\* \* \* \* \*

**Subpart D—[Amended]**

■ 269. Section 1065.303 is revised to read as follows:

**§ 1065.303 Summary of required calibration and verifications.**

The following table summarizes the required and recommended calibrations and verifications described in this subpart and indicates when these have to be performed:

TABLE 1 OF § 1065.303—SUMMARY OF REQUIRED CALIBRATION AND VERIFICATIONS

Type of calibration or verification	Minimum frequency <sup>1</sup>
§ 1065.305: Accuracy, repeatability and noise .....	Accuracy: Not required, but recommended for initial installation. Repeatability: Not required, but recommended for initial installation. Noise: Not required, but recommended for initial installation.
§ 1065.307: Linearity verification .....	Speed: Upon initial installation, within 370 days before testing and after major maintenance. Torque: Upon initial installation, within 370 days before testing and after major maintenance. Electrical power, current, and voltage: Upon initial installation, within 370 days before testing and after major maintenance. <sup>2</sup> Fuel flow rate: Upon initial installation, within 370 days before testing, and after major maintenance. Intake-air, dilution air, diluted exhaust, and batch sampler flow rates: Upon initial installation, within 370 days before testing and after major maintenance, unless flow is verified by propane check or by carbon or oxygen balance. Raw exhaust flow rate: Upon initial installation, within 185 days before testing and after major maintenance, unless flow is verified by propane check or by carbon or oxygen balance. Gas dividers: Upon initial installation, within 370 days before testing, and after major maintenance. Gas analyzers (unless otherwise noted): Upon initial installation, within 35 days before testing and after major maintenance. FTIR and photoacoustic analyzers: Upon initial installation, within 370 days before testing and after major maintenance. GC-ECD: Upon initial installation and after major maintenance. PM balance: Upon initial installation, within 370 days before testing and after major maintenance. Pressure, temperature, and dewpoint: Upon initial installation, within 370 days before testing and after major maintenance.
§ 1065.308: Continuous gas analyzer system response and updating-recording verification—for gas analyzers not continuously compensated for other gas species.	Upon initial installation or after system modification that would affect response.

TABLE 1 OF § 1065.303—SUMMARY OF REQUIRED CALIBRATION AND VERIFICATIONS—Continued

Type of calibration or verification	Minimum frequency <sup>1</sup>
§ 1065.309: Continuous gas analyzer system-response and updating-recording verification—for gas analyzers continuously compensated for other gas species.	Upon initial installation or after system modification that would affect response.
§ 1065.310: Torque .....	Upon initial installation and after major maintenance.
§ 1065.315: Pressure, temperature, dewpoint .....	Upon initial installation and after major maintenance.
§ 1065.320: Fuel flow .....	Upon initial installation and after major maintenance.
§ 1065.325: Intake flow .....	Upon initial installation and after major maintenance.
§ 1065.330: Exhaust flow .....	Upon initial installation and after major maintenance.
§ 1065.340: Diluted exhaust flow (CVS) .....	Upon initial installation and after major maintenance.
§ 1065.341: CVS and batch sampler verification <sup>3</sup> .....	Upon initial installation, within 35 days before testing, and after major maintenance.
§ 1065.342 Sample dryer verification .....	For thermal chillers: upon installation and after major maintenance.
	For osmotic membranes; upon installation, within 35 days of testing, and after major maintenance.
§ 1065.345: Vacuum leak .....	For laboratory testing: upon initial installation of the sampling system, within 8 hours before the start of the first test interval of each duty-cycle sequence, and after maintenance such as pre-filter changes.
	For field testing: after each installation of the sampling system on the vehicle, prior to the start of the field test, and after maintenance such as pre-filter changes.
§ 1065.350: CO <sub>2</sub> NDIR H <sub>2</sub> O interference .....	Upon initial installation and after major maintenance.
§ 1065.355: CO NDIR CO <sub>2</sub> and H <sub>2</sub> O interference .....	Upon initial installation and after major maintenance.
§ 1065.360: FID calibration .....	Calibrate all FID analyzers: upon initial installation and after major maintenance.
THC FID optimization, and THC FID verification .....	Optimize and determine CH <sub>4</sub> response for THC FID analyzers: upon initial installation and after major maintenance.
	Verify CH <sub>4</sub> response for THC FID analyzers: upon initial installation, within 185 days before testing, and after major maintenance.
§ 1065.362: Raw exhaust FID O <sub>2</sub> interference .....	For all FID analyzers: upon initial installation, and after major maintenance.
	For THC FID analyzers: upon initial installation, after major maintenance, and after FID optimization according to § 1065.360.
§ 1065.365: Nonmethane cutter penetration .....	Upon initial installation, within 185 days before testing, and after major maintenance.
§ 1065.369: H <sub>2</sub> O, CO, and CO <sub>2</sub> interference verification for ethanol photoacoustic analyzers.	Upon initial installation and after major maintenance.
§ 1065.370: CLD CO <sub>2</sub> and H <sub>2</sub> O quench .....	Upon initial installation and after major maintenance.
§ 1065.372: NDUV HC and H <sub>2</sub> O interference .....	Upon initial installation and after major maintenance.
§ 1065.375: N <sub>2</sub> O analyzer interference .....	Upon initial installation and after major maintenance.
§ 1065.376: Chiller NO <sub>2</sub> penetration .....	Upon initial installation and after major maintenance.
§ 1065.378: NO <sub>2</sub> -to-NO converter conversion .....	Upon initial installation, within 35 days before testing, and after major maintenance.
§ 1065.390: PM balance and weighing .....	Independent verification: upon initial installation, within 370 days before testing, and after major maintenance.
	Zero, span, and reference sample verifications: within 12 hours of weighing, and after major maintenance.
§ 1065.395: Inertial PM balance and weighing .....	Independent verification: upon initial installation, within 370 days before testing, and after major maintenance.
	Other verifications: upon initial installation and after major maintenance.

<sup>1</sup> Perform calibrations and verifications more frequently than we specify, according to measurement system manufacturer instructions and good engineering judgment.

<sup>2</sup> Perform linearity verification either for electrical power or for current and voltage.

<sup>3</sup> The CVS verification described in § 1065.341 is not required for systems that agree within ±2% based on a chemical balance of carbon or oxygen of the intake air, fuel, and diluted exhaust.

■ 270. Section 1065.305 is amended by revising paragraph (d)(10)(i) to read as follows:

**§ 1065.305 Verifications for accuracy, repeatability, and noise.**

\* \* \* \* \*

(d) \* \* \*

(10) \* \* \*

(i) Your measurement systems meet all the other required calibration, verification, and validation specifications that apply as specified in the regulations.

\* \* \* \* \*

■ 271. Section 1065.307 is revised to read as follows:

**§ 1065.307 Linearity verification.**

(a) *Scope and frequency.* Perform linearity verification on each measurement system listed in Table 1 of this section at least as frequently as indicated in Table 1 of § 1065.303, consistent with measurement system manufacturer's recommendations and good engineering judgment. The intent of linearity verification is to determine that a measurement system responds accurately and proportionally over the measurement range of interest. Linearity

verification generally consists of introducing a series of at least 10 reference values to a measurement system. The measurement system quantifies each reference value. The measured values are then collectively compared to the reference values by using a least-squares linear regression and the linearity criteria specified in Table 1 of this section.

(b) *Performance requirements.* If a measurement system does not meet the applicable linearity criteria referenced in Table 1 of this section, correct the deficiency by re-calibrating, servicing,

or replacing components as needed. Repeat the linearity verification after correcting the deficiency to ensure that the measurement system meets the linearity criteria. Before you may use a measurement system that does not meet linearity criteria, you must demonstrate to us that the deficiency does not adversely affect your ability to demonstrate compliance with the applicable standards.

(c) *Procedure.* Use the following linearity verification protocol, or use good engineering judgment to develop a different protocol that satisfies the intent of this section, as described in paragraph (a) of this section:

(1) In this paragraph (c), the letter “y” denotes a generic measured quantity, the superscript over-bar denotes an arithmetic mean (such as  $\bar{y}$ ), and the subscript “<sub>ref</sub>” denotes the known or reference quantity being measured.

(2) Use good engineering judgment to operate a measurement system at normal operating conditions. This may include any specified adjustment or periodic calibration of the measurement system.

(3) If applicable, zero the instrument as you would before an emission test by introducing a zero signal. Depending on the instrument, this may be a zero-concentration gas, a reference signal, a set of reference thermodynamic conditions, or some combination of these. For gas analyzers, use a zero gas that meets the specifications of § 1065.750 and introduce it directly at the analyzer port.

(4) If applicable, span the instrument as you would before an emission test by introducing a span signal. Depending on the instrument, this may be a span-concentration gas, a reference signal, a set of reference thermodynamic conditions, or some combination of these. For gas analyzers, use a span gas that meets the specifications of § 1065.750 and introduce it directly at the analyzer port.

(5) If applicable, after spanning the instrument, check zero with the same signal you used in paragraph (c)(3) of this section. Based on the zero reading, use good engineering judgment to determine whether or not to rezero and or re-span the instrument before continuing.

(6) For all measured quantities, use the instrument manufacturer’s recommendations and good engineering judgment to select reference values,  $y_{refi}$ , that cover a range of values that you expect would prevent extrapolation beyond these values during emission testing. We recommend selecting a zero reference signal as one of the reference values for the linearity verification. For

pressure, temperature, dewpoint, power, current, voltage, photoacoustic analyzers, and GC-ECD linearity verifications, we recommend at least three reference values. For all other linearity verifications select at least ten reference values.

(7) Use the instrument manufacturer’s recommendations and good engineering judgment to select the order in which you will introduce the series of reference values. For example, you may select the reference values randomly to avoid correlation with previous measurements and to avoid hysteresis; you may select reference values in ascending or descending order to avoid long settling times of reference signals; or you may select values to ascend and then descend to incorporate the effects of any instrument hysteresis into the linearity verification.

(8) Generate reference quantities as described in paragraph (d) of this section. For gas analyzers, use gas concentrations known to be within the specifications of § 1065.750 and introduce them directly at the analyzer port.

(9) Introduce a reference signal to the measurement instrument.

(10) Allow time for the instrument to stabilize while it measures the value at the reference condition. Stabilization time may include time to purge an instrument and time to account for its response.

(11) At a recording frequency of at least  $f$  Hz, specified in Table 1 of § 1065.205, measure the value at the reference condition for 30 seconds (you may select a longer sampling period if the recording update frequency is less than 0.5 Hz) and record the arithmetic mean of the recorded values,  $\bar{y}_i$ . Refer to § 1065.602 for an example of calculating an arithmetic mean.

(12) Repeat the steps in paragraphs (c)(9) through (11) of this section until measurements are complete at each of the reference conditions.

(13) Use the arithmetic means,  $\bar{y}_i$ , and reference values,  $y_{refi}$ , to calculate least-squares linear regression parameters and statistical values to compare to the minimum performance criteria specified in Table 1 of this section. Use the calculations described in § 1065.602. Using good engineering judgment, you may weight the results of individual data pairs (i.e.  $(y_{refi}, \bar{y}_i)$ ), in the linear regression calculations.

(d) *Reference signals.* This paragraph (d) describes recommended methods for generating reference values for the linearity-verification protocol in paragraph (c) of this section. Use reference values that simulate actual values, or introduce an actual value and

measure it with a reference-measurement system. In the latter case, the reference value is the value reported by the reference-measurement system. Reference values and reference-measurement systems must be NIST-traceable. We recommend using calibration reference quantities that are NIST-traceable within 0.5% uncertainty, if not specified elsewhere in this part 1065. Use the following recommended methods to generate reference values or use good engineering judgment to select a different reference:

(1) *Speed.* Run the engine or dynamometer at a series of steady-state speeds and use a strobe, photo tachometer, or laser tachometer to record reference speeds.

(2) *Torque.* Use a series of calibration weights and a calibration lever arm to simulate engine torque. You may instead use the engine or dynamometer itself to generate a nominal torque that is measured by a reference load cell or proving ring in series with the torque-measurement system. In this case, use the reference load cell measurement as the reference value. Refer to § 1065.310 for a torque-calibration procedure similar to the linearity verification in this section.

(3) *Electrical power, current, and voltage.* You must perform linearity verification for either electrical power meters, or for current and voltage meters. Perform linearity verifications using a reference meter and controlled sources of current and voltage. We recommend using a complete calibration system that is suitable for the electrical power distribution industry.

(4) *Fuel rate.* Operate the engine at a series of constant fuel-flow rates or recirculate fuel back to a tank through the fuel flow meter at different flow rates. Use a gravimetric reference measurement (such as a scale, balance, or mass comparator) at the inlet to the fuel-measurement system. Use a stopwatch or timer to measure the time intervals over which reference masses of fuel are introduced to the fuel measurement system. The reference fuel mass divided by the time interval is the reference fuel flow rate.

(5) *Flow rates—inlet air, dilution air, diluted exhaust, raw exhaust, or sample flow.* Use a reference flow meter with a blower or pump to simulate flow rates. Use a restrictor, diverter valve, a variable-speed blower or a variable-speed pump to control the range of flow rates. Use the reference meter’s response as the reference values.

(i) *Reference flow meters.* Because the flow range requirements for these various flows are large, we allow a variety of reference meters. For

example, for diluted exhaust flow for a full-flow dilution system, we recommend a reference subsonic venturi flow meter with a restrictor valve and a blower to simulate flow rates. For inlet air, dilution air, diluted exhaust for partial-flow dilution, raw exhaust, or sample flow, we allow reference meters such as critical flow orifices, critical flow venturis, laminar flow elements, master mass flow standards, or Roots meters. Make sure the reference meter is calibrated and its calibration is NIST-traceable. If you use the difference of two flow measurements to determine a net flow rate, you may use one of the measurements as a reference for the other.

(ii) *Reference flow values.* Because the reference flow is not absolutely constant, sample and record values of  $\dot{n}_{\text{refi}}$  for 30 seconds and use the arithmetic mean of the values,  $\bar{n}_{\text{ref}}$ , as the reference value. Refer to § 1065.602 for an example of calculating arithmetic mean.

(6) *Gas division.* Use one of the two reference signals:

(i) At the outlet of the gas-division system, connect a gas analyzer that meets the linearity verification described in this section and has not been linearized with the gas divider being verified. For example, verify the linearity of an analyzer using a series of reference analytical gases directly from compressed gas cylinders that meet the specifications of § 1065.750. We recommend using a FID analyzer or a PMD or MPD O<sub>2</sub> analyzer because of their inherent linearity. Operate this analyzer consistent with how you would operate it during an emission test. Connect a span gas to the gas-divider inlet. Use the gas-division system to divide the span gas with purified air or nitrogen. Select gas divisions that you typically use. Use a selected gas division as the measured value. Use the analyzer response divided by the span gas concentration as the reference gas-division value. Because the instrument response is not absolutely constant, sample and record values of  $x_{\text{ref}}$  for 30 seconds and use the arithmetic mean of the values,  $\bar{x}_{\text{ref}}$ , as the reference value. Refer to § 1065.602 for an example of calculating arithmetic mean.

(ii) Using good engineering judgment and the gas divider manufacturer's recommendations, use one or more reference flow meters to measure the flow rates of the gas divider and verify the gas-division value.

(7) *Continuous constituent concentration.* For reference values, use a series of gas cylinders of known gas concentration or use a gas-division

system that is known to be linear with a span gas. Gas cylinders, gas-division systems, and span gases that you use for reference values must meet the specifications of § 1065.750.

(8) *Temperature.* You may perform the linearity verification for temperature measurement systems with thermocouples, RTDs, and thermistors by removing the sensor from the system and using a simulator in its place. Use a NIST-traceable simulator that is independently calibrated and, as appropriate, cold-junction-compensated. The simulator uncertainty scaled to absolute temperature must be less than 0.5% of  $T_{\text{max}}$ . If you use this option, you must use sensors that the supplier states are accurate to better than 0.5% of  $T_{\text{max}}$  compared with their standard calibration curve.

(9) *Mass.* For linearity verification for gravimetric PM balances, use external calibration weights that meet the requirements in § 1065.790.

(e) *Measurement systems that require linearity verification.* Table 1 of this section indicates measurement systems that require linearity verification, subject to the following provisions:

(1) Perform linearity verification more frequently based on the instrument manufacturer's recommendation or good engineering judgment.

(2) The expression " $x_{\text{min}}$ " refers to the reference value used during linearity verification that is closest to zero. This is the value used to calculate the first tolerance in Table 1 of this section using the intercept,  $a_0$ . Note that this value may be zero, positive, or negative depending on the reference values. For example, if the reference values chosen to validate a pressure transducer vary from  $-10$  to  $-1$  kPa,  $x_{\text{min}}$  is  $-1$  kPa. If the reference values used to validate a temperature device vary from 290 to 390 K,  $x_{\text{min}}$  is 290 K.

(3) The expression "max" generally refers to the absolute value of the reference value used during linearity verification that is furthest from zero. This is the value used to scale the first and third tolerances in Table 1 of this section using  $a_0$  and *SEE*. For example, if the reference values chosen to validate a pressure transducer vary from  $-10$  to  $-1$  kPa, then  $p_{\text{max}}$  is  $+10$  kPa. If the reference values used to validate a temperature device vary from 290 to 390 K, then  $T_{\text{max}}$  is 390 K. For gas dividers where "max" is expressed as,  $x_{\text{max}}/x_{\text{span}}$ ;  $x_{\text{max}}$  is the maximum gas concentration used during the verification,  $x_{\text{span}}$  is the undivided, undiluted, span gas concentration, and the resulting ratio is the maximum divider point reference value used during the verification (typically 1). The

following are special cases where "max" refers to a different value:

(i) For linearity verification with a PM balance,  $m_{\text{max}}$  refers to the typical mass of a PM filter.

(ii) For linearity verification of torque on the engine's primary output shaft,  $T_{\text{max}}$  refers to the manufacturer's specified engine torque peak value of the lowest torque engine to be tested.

(4) The specified ranges are inclusive. For example, a specified range of 0.98–1.02 for  $a_1$  means  $0.98 \leq a_1 \leq 1.02$ .

(5) Linearity verification is optional for systems that pass the flow-rate verification for diluted exhaust as described in § 1065.341 (the propane check) or for systems that agree within  $\pm 2\%$  based on a chemical balance of carbon or oxygen of the intake air, fuel, and exhaust.

(6) You must meet the  $a_1$  criteria for these quantities only if the absolute value of the quantity is required, as opposed to a signal that is only linearly proportional to the actual value.

(7) Linearity verification is required for the following temperature measurements:

(i) The following temperature measurements always require linearity verification:

(A) Air intake.  
(B) Aftertreatment bed(s), for engines tested with aftertreatment devices subject to cold-start testing.

(C) Dilution air for gaseous and PM sampling, including CVS, double-dilution, and partial-flow systems.

(D) PM sample.

(E) Chiller sample, for gaseous sampling systems that use thermal chillers to dry samples and use chiller temperature to calculate the dewpoint at the outlet of the chiller. For your testing, if you choose to use a high alarm temperature setpoint for the chiller temperature as a constant value in determining the amount of water removed from the emission sample, you may use good engineering judgment to verify the accuracy of the high alarm temperature setpoint instead of linearity verification on the chiller temperature. To verify that the alarm trip point value is no less than 2.0 °C below the reference value at the trip point, we recommend that you input a reference simulated temperature signal below the alarm trip point and increase this signal until the high alarm trips.

(ii) Linearity verification is required for the following temperature measurements if these temperature measurements are specified by the engine manufacturer:

(A) Fuel inlet.

(B) Air outlet to the test cell's charge air cooler air outlet, for engines tested

with a laboratory heat exchanger that simulates an installed charge air cooler.

(C) Coolant inlet to the test cell's charge air cooler, for engines tested with a laboratory heat exchanger that simulates an installed charge air cooler.

(D) Oil in the sump/pan.

(E) Coolant before the thermostat, for liquid-cooled engines.

(8) Linearity verification is required for the following pressure measurements:

(i) The following pressure measurements always require linearity verification:

(A) Air intake restriction.

(B) Exhaust back pressure as required in § 1065.130(h).

(C) Barometer.

(D) CVS inlet gage pressure where the raw exhaust enters the tunnel.

(E) Sample dryer, for gaseous sampling systems that use either osmotic-membrane or thermal chillers to dry samples. For your testing, if you choose to use a low alarm pressure setpoint for the sample dryer pressure as a constant value in determining the amount of water removed from the emission sample, you may use good engineering judgment to verify the accuracy of the low alarm pressure setpoint instead of linearity verification on the sample dryer pressure. To verify that the trip point value is no more than

4.0 kPa above the reference value at the trip point, we recommend that you input a reference pressure signal above the alarm trip point and decrease this signal until the low alarm trips.

(ii) Linearity verification is required for the following pressure measurements if these pressure measurements are specified by the engine manufacturer:

(A) The test cell's charge air cooler and interconnecting pipe pressure drop, for turbo-charged engines tested with a laboratory heat exchanger that simulates an installed charge air cooler.

(B) Fuel outlet.

TABLE 1 OF § 1065.307—MEASUREMENT SYSTEMS THAT REQUIRE LINEARITY VERIFICATION

Measurement system	Quantity	Linearity criteria			
		$x_{\min}(a_1 - 1) + a_0$	$a_1$	SEE	$r^2$
Speed .....	$f_n$ .....	$\leq 0.05\% \cdot f_{n\max}$	0.98–1.02	$\leq 2\% \cdot f_{n\max}$	$\geq 0.990$
Torque .....	$T$ .....	$\leq 1\% \cdot T_{\max}$	0.98–1.02	$\leq 2\% \cdot T_{\max}$	$\geq 0.990$
Electrical power .....	$P$ .....	$\leq 1\% \cdot P_{\max}$	0.98–1.02	$\leq 2\% \cdot P_{\max}$	$\geq 0.990$
Current .....	$I$ .....	$\leq 1\% \cdot I_{\max}$	0.98–1.02	$\leq 2\% \cdot I_{\max}$	$\geq 0.990$
Voltage .....	$U$ .....	$\leq 1\% \cdot U_{\max}$	0.98–1.02	$\leq 2\% \cdot U_{\max}$	$\geq 0.990$
Fuel flow rate .....	$\dot{m}$ .....	$\leq 1\% \cdot \dot{m}_{\max}$	0.98–1.02	$\leq 2\% \cdot \dot{m}_{\max}$	$\geq 0.990$
Intake-air flow rate <sup>1</sup> .....	$\dot{n}$ .....	$\leq 1\% \cdot \dot{n}_{\max}$	0.98–1.02	$\leq 2\% \cdot \dot{n}_{\max}$	$\geq 0.990$
Dilution air flow rate <sup>1</sup> .....	$\dot{n}$ .....	$\leq 1\% \cdot \dot{n}_{\max}$	0.98–1.02	$\leq 2\% \cdot \dot{n}_{\max}$	$\geq 0.990$
Diluted exhaust flow rate <sup>1</sup> .....	$\dot{n}$ .....	$\leq 1\% \cdot \dot{n}_{\max}$	0.98–1.02	$\leq 2\% \cdot \dot{n}_{\max}$	$\geq 0.990$
Raw exhaust flow rate <sup>1</sup> .....	$\dot{n}$ .....	$\leq 1\% \cdot \dot{n}_{\max}$	0.98–1.02	$\leq 2\% \cdot \dot{n}_{\max}$	$\geq 0.990$
Batch sampler flow rates <sup>1</sup> .....	$\dot{n}$ .....	$\leq 1\% \cdot \dot{n}_{\max}$	0.98–1.02	$\leq 2\% \cdot \dot{n}_{\max}$	$\geq 0.990$
Gas dividers .....	$x/x_{\text{span}}$ .....	$\leq 0.5\% \cdot x_{\max}$	0.98–1.02	$\leq 2\% \cdot x_{\max}$	$\geq 0.990$
Gas analyzers for laboratory testing .....	$x$ .....	$\leq 0.5\% \cdot x_{\max}$	0.99–1.01	$\leq 1\% \cdot x_{\max}$	$\geq 0.998$
Gas analyzers for field testing .....	$x$ .....	$\leq 1\% \cdot x_{\max}$	0.99–1.01	$\leq 1\% \cdot x_{\max}$	$\geq 0.998$
PM balance .....	$m$ .....	$\leq 1\% \cdot m_{\max}$	0.99–1.01	$\leq 1\% \cdot m_{\max}$	$\geq 0.998$
Pressures .....	$p$ .....	$\leq 1\% \cdot p_{\max}$	0.99–1.01	$\leq 1\% \cdot p_{\max}$	$\geq 0.998$
Dewpoint for intake air, PM-stabilization and balance environments ..	$T_{\text{dew}}$ .....	$\leq 0.5\% \cdot T_{\text{dewmax}}$	0.99–1.01	$\leq 0.5\% \cdot T_{\text{dewmax}}$	$\geq 0.998$
Other dewpoint measurements .....	$T_{\text{dew}}$ .....	$\leq 1\% \cdot T_{\text{dewmax}}$	0.99–1.01	$\leq 1\% \cdot T_{\text{dewmax}}$	$\geq 0.998$
Analog-to-digital conversion of temperature signals .....	$T$ .....	$\leq 1\% \cdot T_{\max}$	0.99–1.01	$\leq 1\% \cdot T_{\max}$	$\geq 0.998$

<sup>1</sup> For flow meters that determine volumetric flow rate,  $\dot{V}_{\text{std}}$ , you may substitute  $\dot{V}_{\text{std}}$  for  $\dot{n}$  as the quantity and substitute  $\dot{V}_{\text{stdmax}}$  for  $\dot{n}_{\max}$ .

■ 272. Section 1065.308 is amended by revising paragraph (d)(2) and adding paragraph (g) to read as follows:

**§ 1065.308 Continuous gas analyzer system-response and updating-recording verification—for gas analyzers not continuously compensated for other gas species.**

\* \* \* \* \*

(d) \* \* \*

(2) *Equipment setup.* We recommend using minimal lengths of gas transfer lines between all connections and fast-acting three-way valves (2 inlets, 1 outlet) to control the flow of zero and blended span gases to the sample system's probe inlet or a tee near the outlet of the probe. If you inject the gas at a tee near the outlet of the probe, you

may correct the transformation time,  $t_{50}$ , for an estimate of the transport time from the probe inlet to the tee. Normally the gas flow rate is higher than the sample flow rate and the excess is overflowed out the inlet of the probe. If the gas flow rate is lower than the sample flow rate, the gas concentrations must be adjusted to account for the dilution from ambient air drawn into the probe. We recommend you use the final, stabilized analyzer reading as the final gas concentration. Select span gases for the species being measured. You may use binary or multi-gas span gases. You may use a gas blending or mixing device to blend span gases. A gas blending or mixing device is recommended when blending span gases diluted in N<sub>2</sub> with span gases

diluted in air. You may use a multi-gas span gas, such as NO–CO–CO<sub>2</sub>–C<sub>3</sub>H<sub>8</sub>–CH<sub>4</sub>, to verify multiple analyzers at the same time. If you use standard binary span gases, you must run separate response tests for each analyzer. In designing your experimental setup, avoid pressure pulsations due to stopping the flow through the gas-blending device. The change in gas concentration must be at least 20% of the analyzer's range.

\* \* \* \* \*

(g) *Optional procedure.* Instead of using a three-way valve to switch between zero and span gases, you may use a fast-acting two-way valve to switch sampling between ambient air and span gas at the probe inlet. For this

alternate procedure, the following provisions apply:

(1) If your probe is sampling from a continuously flowing gas stream (e.g., a CVS tunnel), you may adjust the span gas flow rate to be different than the sample flow rate.

(2) If your probe is sampling from a gas stream that is not continuously flowing (e.g., a raw exhaust stack), you must adjust the span gas flow rate to be less than the sample flow rate so ambient air is always being drawn into the probe inlet. This avoids errors associated with overflowing span gas out of the probe inlet and drawing it back in when sampling ambient air.

(3) When sampling ambient air or ambient air mixed with span gas, all the analyzer readings must be stable within  $\pm 0.5\%$  of the target gas concentration step size. If any analyzer reading is outside the specified range, you must resolve the problem and verify that all the analyzer readings meet this specification.

(4) For oxygen analyzers, you may use purified  $N_2$  as the zero gas and ambient air (plus purified  $N_2$  if needed) as the reference gas. Perform the verification with seven repeat measurements that each consist of stabilizing with purified  $N_2$ , switching to ambient air and observing the analyzer's rise and stabilized reading, followed by switching back to purified  $N_2$  and observing the analyzer's fall and stabilized reading.

■ 273. Section 1065.309 is amended by revising paragraphs (a) and (d)(2) and adding paragraphs (g) and (h) to read as follows:

**§ 1065.309 Continuous gas analyzer system-response and updating-recording verification—for gas analyzers continuously compensated for other gas species.**

(a) *Scope and frequency.* This section describes a verification procedure for system response and updating-recording frequency for continuous gas analyzers that output a single gas species mole fraction (i.e., concentration) based on a continuous combination of multiple gas species measured with multiple detectors (i.e., gas analyzers continuously compensated for other gas species). See § 1065.308 for verification procedures that apply to continuous gas analyzers that are not continuously compensated for other gas species or that use only one detector for gaseous species. Perform this verification to determine the system response of the continuous gas analyzer and its sampling system. This verification is required for continuous gas analyzers used for transient or ramped-modal testing. You need not perform this

verification for batch gas analyzers or for continuous gas analyzers that are used only for discrete-mode testing. For this check we consider water vapor a gaseous constituent. This verification does not apply to any processing of individual analyzer signals that are time-aligned to their  $t_{50}$  times and were verified according to § 1065.308. For example, this verification does not apply to correction for water removed from the sample done in post-processing according to § 1065.659 (40 CFR 1066.620 for vehicle testing) and it does not apply to NMHC determination from THC and  $CH_4$  according to § 1065.660. Perform this verification after initial installation (i.e., test cell commissioning) and after any modifications to the system that would change the system response.

\* \* \* \* \*

(d) \* \* \*

(2) *Equipment setup.* We recommend using minimal lengths of gas transfer lines between all connections and fast-acting three-way valves (2 inlets, 1 outlet) to control the flow of zero and blended span gases to the sample system's probe inlet or a tee near the outlet of the probe. If you inject the gas at a tee near the outlet of the probe, you may correct the transformation time,  $t_{50}$ , for an estimate of the transport time from the probe inlet to the tee. Normally the gas flow rate is higher than the sample flow rate and the excess is overflowed out the inlet of the probe. If the gas flow rate is lower than the sample flow rate, the gas concentrations must be adjusted to account for the dilution from ambient air drawn into the probe. We recommend you use the final, stabilized analyzer reading as the final gas concentration. Select span gases for the species being continuously combined, other than  $H_2O$ . Select concentrations of compensating species that will yield concentrations of these species at the analyzer inlet that covers the range of concentrations expected during testing. You may use binary or multi-gas span gases. You may use a gas blending or mixing device to blend span gases. A gas blending or mixing device is recommended when blending span gases diluted in  $N_2$  with span gases diluted in air. You may use a multi-gas span gas, such as  $NO-CO-CO_2-C_3H_8-CH_4$ , to verify multiple analyzers at the same time. In designing your experimental setup, avoid pressure pulsations due to stopping the flow through the gas blending device. The change in gas concentration must be at least 20% of the analyzer's range. If  $H_2O$  correction is applicable, then span gases must be humidified before entering the

analyzer; however, you may not humidify  $NO_2$  span gas by passing it through a sealed humidification vessel that contains water. You must humidify  $NO_2$  span gas with another moist gas stream. We recommend humidifying your  $NO-CO-CO_2-C_3H_8-CH_4$ , balance  $N_2$  blended gas by flowing the gas mixture through a sealed vessel that humidifies the gas by bubbling it through distilled water and then mixing the gas with dry  $NO_2$  gas, balance purified air. If your system does not use a sample dryer to remove water from the sample gas, you must humidify your span gas to the highest sample  $H_2O$  content that you estimate during emission sampling. If your system uses a sample dryer during testing, it must pass the sample dryer verification check in § 1065.342, and you must humidify your span gas to an  $H_2O$  content greater than or equal to the level determined in § 1065.145(e)(2). If you are humidifying span gases without  $NO_2$ , use good engineering judgment to ensure that the wall temperatures in the transfer lines, fittings, and valves from the humidifying system to the probe are above the dewpoint required for the target  $H_2O$  content. If you are humidifying span gases with  $NO_2$ , use good engineering judgment to ensure that there is no condensation in the transfer lines, fittings, or valves from the point where humidified gas is mixed with  $NO_2$  span gas to the probe. We recommend that you design your setup so that the wall temperatures in the transfer lines, fittings, and valves from the humidifying system to the probe are at least 5 °C above the local sample gas dewpoint. Operate the measurement and sample handling system as you do for emission testing. Make no modifications to the sample handling system to reduce the risk of condensation. Flow humidified gas through the sampling system before this check to allow stabilization of the measurement system's sampling handling system to occur, as it would for an emission test.

\* \* \* \* \*

(g) *Optional procedure.* Follow the optional procedures in § 1065.308(g), noting that you may use compensating gases mixed with ambient air for oxygen analyzers.

(h) *Analyzers with  $H_2O$  compensation sampling downstream of a sample dryer.* You may omit humidifying the span gas as described in this paragraph (h). If an analyzer compensates only for  $H_2O$ , you may apply the requirements of § 1065.308 instead of the requirements of this section. You may omit humidifying the span gas if you meet the following conditions:



(1) The analyzer is located downstream of a sample dryer.

(2) The maximum value for H<sub>2</sub>O mole fraction downstream of the dryer must be less than or equal to 0.010. Verify this during each sample dryer verification according to § 1065.342.

■ 274. Section 1065.310 is revised to read as follows:

**§ 1065.310 Torque calibration.**

(a) *Scope and frequency.* Calibrate all torque-measurement systems including dynamometer torque measurement transducers and systems upon initial installation and after major maintenance. Use good engineering judgment to repeat the calibration. Follow the torque transducer manufacturer's instructions for linearizing your torque sensor's output. We recommend that you calibrate the torque-measurement system with a reference force and a lever arm.

(b) *Recommended procedure to quantify lever-arm length.* Quantify the lever-arm length, NIST-traceable within ±0.5% uncertainty. The lever arm's length must be measured from the centerline of the dynamometer to the point at which the reference force is measured. The lever arm must be perpendicular to gravity (i.e., horizontal), and it must be perpendicular to the dynamometer's rotational axis. Balance the lever arm's torque or quantify its net hanging torque, NIST-traceable within ±1% uncertainty, and account for it as part of the reference torque.

(c) *Recommended procedure to quantify reference force.* We recommend dead-weight calibration, but you may use either of the following procedures to quantify the reference force, NIST-traceable within ±0.5% uncertainty.

(1) *Dead-weight calibration.* This technique applies a known force by hanging known weights at a known distance along a lever arm. Make sure the weights' lever arm is perpendicular to gravity (i.e., horizontal) and perpendicular to the dynamometer's rotational axis. Apply at least six calibration-weight combinations for each applicable torque-measuring range, spacing the weight quantities about equally over the range. Oscillate or rotate the dynamometer during calibration to reduce frictional static hysteresis. Determine each weight's reference force by multiplying its NIST-traceable mass by the local acceleration of Earth's gravity, as described in § 1065.630. Calculate the reference torque as the weights' reference force multiplied by the lever arm reference length.

(2) *Strain gage, load transducer, or proving ring calibration.* This technique applies force either by hanging weights on a lever arm (these weights and their lever arm length are not used as part of the reference torque determination) or by operating the dynamometer at different torques. Apply at least six force combinations for each applicable torque-measuring range, spacing the force quantities about equally over the range. Oscillate or rotate the dynamometer during calibration to reduce frictional static hysteresis. In this case, the reference torque is determined by multiplying the force output from the reference meter (such as a strain gage, load transducer, or proving ring) by its effective lever-arm length, which you measure from the point where the force measurement is made to the dynamometer's rotational axis. Make sure you measure this length perpendicular to the reference meter's measurement axis and perpendicular to the dynamometer's rotational axis.

■ 275. Section 1065.315 is amended by revising paragraph (a)(2) to read as follows:

**§ 1065.315 Pressure, temperature, and dewpoint calibration.**

(a) \* \* \*

(2) *Temperature.* We recommend digital dry-block or stirred-liquid temperature calibrators, with data logging capabilities to minimize transcription errors. We recommend using calibration reference quantities that are NIST-traceable within 0.5% uncertainty. You may perform linearity verification for temperature measurement systems with thermocouples, RTDs, and thermistors by removing the sensor from the system and using a simulator in its place. Use a NIST-traceable simulator that is independently calibrated and, as appropriate, cold-junction compensated. The simulator uncertainty scaled to absolute temperature must be less than 0.5% of  $T_{max}$ . If you use this option, you must use sensors that the supplier states are accurate to better than 0.5% of  $T_{max}$  compared with their standard calibration curve.

\* \* \* \* \*

■ 276. Section 1065.341 is amended by revising the section heading and paragraphs (a) introductory text, (d) introductory text, and (f)(3) to read as follows:

**§ 1065.341 CVS, PFD, and batch sampler verification (propane check).**

(a) A propane check serves as a CVS verification to determine if there is a discrepancy in measured values of diluted exhaust flow. You may use the

same procedure to verify PFDs and batch samplers. For purposes of PFD and batch sampler verification, read the term CVS to mean PFD or batch sampler as appropriate. A propane check also serves as a batch-sampler verification to determine if there is a discrepancy in a batch sampling system that extracts a sample from a CVS, as described in paragraph (g) of this section. Using good engineering judgment and safe practices, this check may be performed using a gas other than propane, such as CO<sub>2</sub> or CO. A failed propane check might indicate one or more problems that may require corrective action, as follows:

\* \* \* \* \*

(d) If you performed the vacuum-side leak verification of the HC sampling system as described in paragraph (c)(8) of this section, you may use the HC contamination procedure in § 1065.520(f) to verify HC contamination. Otherwise, zero, span, and verify contamination of the HC sampling system, as follows:

\* \* \* \* \*

(f) \* \* \*

(3) Calculate total C<sub>3</sub>H<sub>8</sub> mass based on your CVS and HC data as described in § 1065.650 (40 CFR 1066.605 for vehicle testing) and § 1065.660, using the molar mass of C<sub>3</sub>H<sub>8</sub>,  $M_{C_3H_8}$ , instead of the effective molar mass of HC,  $M_{HC}$ .

\* \* \* \* \*

■ 277. Section 1065.350 is amended by revising paragraph (d) and adding paragraph (e) to read as follows:

**§ 1065.350 H<sub>2</sub>O interference verification for CO<sub>2</sub> NDIR analyzers.**

\* \* \* \* \*

(d) *Procedure.* Perform the interference verification as follows:

(1) Start, operate, zero, and span the CO<sub>2</sub> NDIR analyzer as you would before an emission test. If the sample is passed through a dryer during emission testing, you may run this verification test with the dryer if it meets the requirements of § 1065.342. Operate the dryer at the same conditions as you will for an emission test. You may also run this verification test without the sample dryer.

(2) Create a humidified test gas by bubbling zero gas that meets the specifications in § 1065.750 through distilled H<sub>2</sub>O in a sealed vessel. If the sample is not passed through a dryer during emission testing, control the vessel temperature to generate an H<sub>2</sub>O level at least as high as the maximum expected during emission testing. If the sample is passed through a dryer during emission testing, control the vessel temperature to generate an H<sub>2</sub>O level at

least as high as the level determined in § 1065.145(e)(2) for that dryer.

(3) Introduce the humidified test gas into the sample system. You may introduce it downstream of any sample dryer, if one is used during testing.

(4) If the sample is not passed through a dryer during this verification test, measure the H<sub>2</sub>O mole fraction,  $x_{H_2O}$ , of the humidified test gas, as close as possible to the inlet of the analyzer. For example, measure dewpoint,  $T_{dew}$ , and absolute pressure,  $p_{total}$ , to calculate  $x_{H_2O}$ . Verify that the H<sub>2</sub>O content meets the requirement in paragraph (d)(2) of this section. If the sample is passed through a dryer during this verification test, you must verify that the H<sub>2</sub>O content of the humidified test gas downstream of the vessel meets the requirement in paragraph (d)(2) of this section based on either direct measurement of the H<sub>2</sub>O content (e.g., dewpoint and pressure) or an estimate based on the vessel pressure and temperature. Use good engineering judgment to estimate the H<sub>2</sub>O content. For example, you may use previous direct measurements of H<sub>2</sub>O content to verify the vessel's level of saturation.

(5) If a sample dryer is not used in this verification test, use good engineering judgment to prevent condensation in the transfer lines, fittings, or valves from the point where  $x_{H_2O}$  is measured to the analyzer. We recommend that you design your system so the wall temperatures in the transfer lines, fittings, and valves from the point where  $x_{H_2O}$  is measured to the analyzer are at least 5 °C above the local sample gas dewpoint.

(6) Allow time for the analyzer response to stabilize. Stabilization time may include time to purge the transfer line and to account for analyzer response.

(7) While the analyzer measures the sample's concentration, record 30 seconds of sampled data. Calculate the arithmetic mean of this data. The analyzer meets the interference verification if this value is within (0.0 ± 0.4) mmol/mol.

(e) *Exceptions.* The following exceptions apply:

(1) You may omit this verification if you can show by engineering analysis that for your CO<sub>2</sub> sampling system and your emission-calculation procedures, the H<sub>2</sub>O interference for your CO<sub>2</sub> NDIR analyzer always affects your brake-specific emission results within ±0.5% of each of the applicable standards. This specification also applies for vehicle testing, except that it relates to emission results in g/mile or g/kilometer.

(2) You may use a CO<sub>2</sub> NDIR analyzer that you determine does not meet this

verification, as long as you try to correct the problem and the measurement deficiency does not adversely affect your ability to show that engines comply with all applicable emission standards.

■ 278. Section 1065.355 is amended by revising paragraphs (d)(2) and (d)(4) to read as follows:

**§ 1065.355 H<sub>2</sub>O and CO<sub>2</sub> interference verification for CO NDIR analyzers.**

\* \* \* \* \*

(d) \* \* \*

(2) Create a humidified CO<sub>2</sub> test gas by bubbling a CO<sub>2</sub> span gas that meets the specifications in § 1065.750 through distilled H<sub>2</sub>O in a sealed vessel. If the sample is not passed through a dryer during emission testing, control the vessel temperature to generate an H<sub>2</sub>O level at least as high as the maximum expected during emission testing. If the sample is passed through a dryer during emission testing, control the vessel temperature to generate an H<sub>2</sub>O level at least as high as the level determined in § 1065.145(e)(2) for that dryer. Use a CO<sub>2</sub> span gas concentration at least as high as the maximum expected during testing.

\* \* \* \* \*

(4) If the sample is not passed through a dryer during this verification test, measure the H<sub>2</sub>O mole fraction,  $x_{H_2O}$ , of the humidified CO<sub>2</sub> test gas as close as possible to the inlet of the analyzer. For example, measure dewpoint,  $T_{dew}$ , and absolute pressure,  $p_{total}$ , to calculate  $x_{H_2O}$ . Verify that the H<sub>2</sub>O content meets the requirement in paragraph (d)(2) of this section. If the sample is passed through a dryer during this verification test, you must verify that the H<sub>2</sub>O content of the humidified test gas downstream of the vessel meets the requirement in paragraph (d)(2) of this section based on either direct measurement of the H<sub>2</sub>O content (e.g., dewpoint and pressure) or an estimate based on the vessel pressure and temperature. Use good engineering judgment to estimate the H<sub>2</sub>O content. For example, you may use previous direct measurements of H<sub>2</sub>O content to verify the vessel's level of saturation.

\* \* \* \* \*

279. Section 1065.360 is amended by revising paragraphs (a)(3), (b), (d), and (e) to read as follows:

**§ 1065.360 FID optimization and verification.**

(a) \* \* \*

(3) Verify the CH<sub>4</sub> response within 185 days before testing as described in paragraph (e) of this section.

(b) *Calibration.* Use good engineering judgment to develop a calibration

procedure, such as one based on the FID-analyzer manufacturer's instructions and recommended frequency for calibrating the FID. Alternately, you may remove system components for off-site calibration. For a FID that measures THC, calibrate using C<sub>3</sub>H<sub>8</sub> calibration gases that meet the specifications of § 1065.750. For a FID that measures CH<sub>4</sub>, calibrate using CH<sub>4</sub> calibration gases that meet the specifications of § 1065.750. We recommend FID analyzer zero and span gases that contain approximately the flow-weighted mean concentration of O<sub>2</sub> expected during testing. If you use a FID to measure CH<sub>4</sub> downstream of a nonmethane cutter, you may calibrate that FID using CH<sub>4</sub> calibration gases with the cutter. Regardless of the calibration gas composition, calibrate on a carbon number basis of one (C<sub>1</sub>). For example, if you use a C<sub>3</sub>H<sub>8</sub> span gas of concentration 200 μmol/mol, span the FID to respond with a value of 600 μmol/mol. As another example, if you use a CH<sub>4</sub> span gas with a concentration of 200 μmol/mol, span the FID to respond with a value of 200 μmol/mol.

\* \* \* \* \*

(d) *THC FID CH<sub>4</sub> response factor determination.* This procedure is only for FID analyzers that measure THC. Since FID analyzers generally have a different response to CH<sub>4</sub> versus C<sub>3</sub>H<sub>8</sub>, determine each THC-FID analyzer's CH<sub>4</sub> response factor,  $RF_{CH_4[THC-FID]}$ , after FID optimization. Use the most recent  $RF_{CH_4[THC-FID]}$  measured according to this section in the calculations for HC determination described in § 1065.660 to compensate for CH<sub>4</sub> response. Determine  $RF_{CH_4[THC-FID]}$  as follows, noting that you do not determine  $RF_{CH_4[THC-FID]}$  for FIDs that are calibrated and spanned using CH<sub>4</sub> with a nonmethane cutter:

(1) Select a C<sub>3</sub>H<sub>8</sub> span gas concentration that you use to span your analyzers before emission testing. Use only span gases that meet the specifications of § 1065.750. Record the C<sub>3</sub>H<sub>8</sub> concentration of the gas.

(2) Select a CH<sub>4</sub> span gas concentration that you use to span your analyzers before emission testing. Use only span gases that meet the specifications of § 1065.750. Record the CH<sub>4</sub> concentration of the gas.

(3) Start and operate the FID analyzer according to the manufacturer's instructions.

(4) Confirm that the FID analyzer has been calibrated using C<sub>3</sub>H<sub>8</sub>. Calibrate on a carbon number basis of one (C<sub>1</sub>). For example, if you use a C<sub>3</sub>H<sub>8</sub> span gas of concentration 200 μmol/mol, span the FID to respond with a value of 600 μmol/mol.

(5) Zero the FID with a zero gas that you use for emission testing.

(6) Span the FID with the C<sub>3</sub>H<sub>8</sub> span gas that you selected under paragraph (d)(1) of this section.

(7) Introduce at the sample port of the FID analyzer, the CH<sub>4</sub> span gas that you selected under paragraph (d)(2) of this section.

(8) Allow time for the analyzer response to stabilize. Stabilization time may include time to purge the analyzer and to account for its response.

(9) While the analyzer measures the CH<sub>4</sub> concentration, record 30 seconds of sampled data. Calculate the arithmetic mean of these values.

(10) For analyzers with multiple ranges, you need to perform the procedure in this paragraph (d) only on a single range.

(11) Divide the mean measured concentration by the recorded span concentration of the CH<sub>4</sub> calibration gas. The result is the FID analyzer's response factor for CH<sub>4</sub>,  $RF_{CH_4[THC-FID]}$ .

(e) *THC FID CH<sub>4</sub> response verification.* This procedure is only for FID analyzers that measure THC. Verify  $RF_{CH_4[THC-FID]}$  as follows:

(1) Perform a CH<sub>4</sub> response factor determination as described in paragraph (d) of this section. If the resulting value of  $RF_{CH_4[THC-FID]}$  is within  $\pm 5\%$  of its most recent previously determined value, the THC FID passes the CH<sub>4</sub> response verification. For example, if the most recent previous value for  $RF_{CH_4[THC-FID]}$  was 1.05 and it increased by 0.05 to become 1.10 or it decreased by 0.05 to become 1.00, either case would be acceptable because  $\pm 4.8\%$  is less than  $\pm 5\%$ .

(2) If  $RF_{CH_4[THC-FID]}$  is not within the tolerance specified in paragraph (e)(1) of this section, use good engineering judgment to verify that the flow rates and/or pressures of FID fuel, burner air, and sample are at their most recent previously recorded values, as determined in paragraph (c) of this section. You may adjust these flow rates as necessary. Then determine the  $RF_{CH_4[THC-FID]}$  as described in paragraph (d) of this section and verify that it is within the tolerance specified in this paragraph (e).

(3) If  $RF_{CH_4[THC-FID]}$  is not within the tolerance specified in this paragraph (e), re-optimize the FID response as described in paragraph (c) of this section.

(4) Determine a new  $RF_{CH_4[THC-FID]}$  as described in paragraph (d) of this section. Use this new value of  $RF_{CH_4[THC-FID]}$  in the calculations for HC determination, as described in § 1065.660.

(5) For analyzers with multiple ranges, you need to perform the procedure in this paragraph (e) only on a single range.

280. Section 1065.362 is amended by adding paragraph (d)(15) to read as follows:

**§ 1065.362 Non-stoichiometric raw exhaust FID O<sub>2</sub> interference verification.**

\* \* \* \* \*

(d) \* \* \*

(15) For analyzers with multiple ranges, you need to perform the procedure in this paragraph (d) only on a single range.

281. Section 1065.365 is amended by revising paragraphs (a), (b), (d)(1), (e)(1), (f) introductory text, and (f)(1) to read as follows:

**§ 1065.365 Nonmethane cutter penetration fractions.**

(a) *Scope and frequency.* If you use a FID analyzer and a nonmethane cutter (NMC) to measure methane (CH<sub>4</sub>), determine the nonmethane cutter's penetration fractions of CH<sub>4</sub>,  $PF_{CH_4}$ , and ethane,  $PF_{C_2H_6}$ . As detailed in this section, these penetration fractions may be determined as a combination of NMC penetration fractions and FID analyzer response factors, depending on your particular NMC and FID analyzer configuration. Perform this verification after installing the nonmethane cutter. Repeat this verification within 185 days of testing to verify that the catalytic activity of the cutter has not deteriorated. Note that because nonmethane cutters can deteriorate rapidly and without warning if they are operated outside of certain ranges of gas concentrations and outside of certain temperature ranges, good engineering judgment may dictate that you determine a nonmethane cutter's penetration fractions more frequently.

(b) *Measurement principles.* A nonmethane cutter is a heated catalyst that removes nonmethane hydrocarbons from an exhaust sample stream before the FID analyzer measures the remaining hydrocarbon concentration. An ideal nonmethane cutter would have a CH<sub>4</sub> penetration fraction,  $PF_{CH_4}$ , of 1.000, and the penetration fraction for all other nonmethane hydrocarbons would be 0.000, as represented by  $PF_{C_2H_6}$ . The emission calculations in § 1065.660 use the measured values from this verification to account for less than ideal NMC performance.

\* \* \* \* \*

(d) \* \* \*

(1) Select CH<sub>4</sub> and C<sub>2</sub>H<sub>6</sub> analytical gas mixtures and ensure that both mixtures meet the specifications of § 1065.750. Select a CH<sub>4</sub> concentration that you

would use for spanning the FID during emission testing and select a C<sub>2</sub>H<sub>6</sub> concentration that is typical of the peak NMHC concentration expected at the hydrocarbon standard or equal to the THC analyzer's span value. For CH<sub>4</sub> analyzers with multiple ranges, perform this procedure on the highest range used for emission testing.

\* \* \* \* \*

(e) \* \* \*

(1) Select CH<sub>4</sub> and C<sub>2</sub>H<sub>6</sub> analytical gas mixtures and ensure that both mixtures meet the specifications of § 1065.750. Select a CH<sub>4</sub> concentration that you would use for spanning the FID during emission testing and select a C<sub>2</sub>H<sub>6</sub> concentration that is typical of the peak NMHC concentration expected at the hydrocarbon standard and the C<sub>2</sub>H<sub>6</sub> concentration typical of the peak total hydrocarbon (THC) concentration expected at the hydrocarbon standard or equal to the THC analyzer's span value. For CH<sub>4</sub> analyzers with multiple ranges, perform this procedure on the highest range used for emission testing.

\* \* \* \* \*

(f) *Procedure for a FID calibrated with CH<sub>4</sub>, bypassing the NMC.* If you use a FID with an NMC that is calibrated with CH<sub>4</sub>, by bypassing the NMC, determine its combined ethane (C<sub>2</sub>H<sub>6</sub>) response factor and penetration fraction,  $RFPF_{C_2H_6[NMC-FID]}$ , as well as its CH<sub>4</sub> penetration fraction,  $PF_{CH_4[NMC-FID]}$ , as follows:

(1) Select CH<sub>4</sub> and C<sub>2</sub>H<sub>6</sub> analytical gas mixtures and ensure that both mixtures meet the specifications of § 1065.750. Select a CH<sub>4</sub> concentration that you would use for spanning the FID during emission testing and select a C<sub>2</sub>H<sub>6</sub> concentration that is typical of the peak NMHC concentration expected at the hydrocarbon standard or equal to the THC analyzer's span value. For CH<sub>4</sub> analyzers with multiple ranges, perform this procedure on the highest range used for emission testing.

\* \* \* \* \*

■ 282. A new § 1065.369 is added to subpart D under the center header "Hydrocarbon Measurements" to read as follows:

**§ 1065.369 H<sub>2</sub>O, CO, and CO<sub>2</sub> interference verification for photoacoustic alcohol analyzers.**

(a) *Scope and frequency.* If you measure ethanol or methanol using a photoacoustic analyzer, verify the amount of H<sub>2</sub>O, CO, and CO<sub>2</sub> interference after initial analyzer installation and after major maintenance.

(b) *Measurement principles.* H<sub>2</sub>O, CO, and CO<sub>2</sub> can positively interfere with a

photoacoustic analyzer by causing a response similar to ethanol or methanol. If the photoacoustic analyzer uses compensation algorithms that utilize measurements of other gases to meet this interference verification, simultaneously conduct these other measurements to test the compensation algorithms during the analyzer interference verification.

(c) *System requirements.*

Photoacoustic analyzers must have combined interference that is within  $(0.0 \pm 0.5)$   $\mu\text{mol/mol}$ . We strongly recommend a lower interference that is within  $(0.0 \pm 0.25)$   $\mu\text{mol/mol}$ .

(d) *Procedure.* Perform the interference verification by following the procedure in § 1065.375(d), comparing the results to paragraph (c) of this section.

■ 283. Section 1065.370 is amended by revising paragraphs (d)(9) and (e)(5) to read as follows:

**§ 1065.370 CLD CO<sub>2</sub> and H<sub>2</sub>O quench verification.**

\* \* \* \* \*

(d) \* \* \*

(9) While flowing NO and CO<sub>2</sub> through the gas divider, stabilize the output of the gas divider. Determine the CO<sub>2</sub> concentration from the gas divider output, applying gas property correction as necessary to ensure accurate gas division, or measure it using an NDIR. Record this concentration,  $x_{\text{CO}_2\text{act}}$ , and use it in the quench verification calculations in § 1065.675.

Alternatively, you may use a simple gas blending device and use an NDIR to determine this CO<sub>2</sub> concentration. If you use an NDIR, it must meet the requirements of this part for laboratory testing and you must span it with the CO<sub>2</sub> span gas from paragraph (d)(4) of this section.

\* \* \* \* \*

(e) \* \* \*

(5) Humidify the NO span gas by bubbling it through distilled H<sub>2</sub>O in a sealed vessel. If the humidified NO span gas sample does not pass through a sample dryer for this verification test, control the vessel temperature to generate an H<sub>2</sub>O level approximately equal to the maximum mole fraction of H<sub>2</sub>O expected during emission testing. If the humidified NO span gas sample does not pass through a sample dryer, the quench verification calculations in § 1065.675 scale the measured H<sub>2</sub>O quench to the highest mole fraction of H<sub>2</sub>O expected during emission testing. If the humidified NO span gas sample passes through a dryer for this verification test, control the vessel temperature to generate an H<sub>2</sub>O level at least as high as the level determined in

§ 1065.145(e)(2). For this case, the quench verification calculations in § 1065.675 do not scale the measured H<sub>2</sub>O quench.

\* \* \* \* \*

■ 284. Section 1065.375 is amended by revising paragraph (d) to read as follows:

**§ 1065.375 Interference verification for N<sub>2</sub>O analyzers.**

\* \* \* \* \*

(d) *Procedure.* Perform the interference verification as follows:

(1) Start, operate, zero, and span the N<sub>2</sub>O analyzer as you would before an emission test. If the sample is passed through a dryer during emission testing, you may run this verification test with the dryer if it meets the requirements of § 1065.342. Operate the dryer at the same conditions as you will for an emission test. You may also run this verification test without the sample dryer.

(2) Create a humidified test gas by bubbling a multi component span gas that incorporates the target interference species and meets the specifications in § 1065.750 through distilled H<sub>2</sub>O in a sealed vessel. If the sample is not passed through a dryer during emission testing, control the vessel temperature to generate an H<sub>2</sub>O level at least as high as the maximum expected during emission testing. If the sample is passed through a dryer during emission testing, control the vessel temperature to generate an H<sub>2</sub>O level at least as high as the level determined in § 1065.145(e)(2) for that dryer. Use interference span gas concentrations that are at least as high as the maximum expected during testing.

(3) Introduce the humidified interference test gas into the sample system. You may introduce it downstream of any sample dryer, if one is used during testing.

(4) If the sample is not passed through a dryer during this verification test, measure the H<sub>2</sub>O mole fraction,  $x_{\text{H}_2\text{O}}$ , of the humidified interference test gas as close as possible to the inlet of the analyzer. For example, measure dewpoint,  $T_{\text{dew}}$ , and absolute pressure,  $p_{\text{total}}$ , to calculate  $x_{\text{H}_2\text{O}}$ . Verify that the H<sub>2</sub>O content meets the requirement in paragraph (d)(2) of this section. If the sample is passed through a dryer during this verification test, you must verify that the H<sub>2</sub>O content of the humidified test gas downstream of the vessel meets the requirement in paragraph (d)(2) of this section based on either direct measurement of the H<sub>2</sub>O content (e.g., dewpoint and pressure) or an estimate based on the vessel pressure and temperature. Use good engineering

judgment to estimate the H<sub>2</sub>O content. For example, you may use previous direct measurements of H<sub>2</sub>O content to verify the vessel's level of saturation.

(5) If a sample dryer is not used in this verification test, use good engineering judgment to prevent condensation in the transfer lines, fittings, or valves from the point where  $x_{\text{H}_2\text{O}}$  is measured to the analyzer. We recommend that you design your system so that the wall temperatures in the transfer lines, fittings, and valves from the point where  $x_{\text{H}_2\text{O}}$  is measured to the analyzer are at least 5 °C above the local sample gas dewpoint.

(6) Allow time for the analyzer response to stabilize. Stabilization time may include time to purge the transfer line and to account for analyzer response.

(7) While the analyzer measures the sample's concentration, record its output for 30 seconds. Calculate the arithmetic mean of this data. When performed with all the gases simultaneously, this is the combined interference.

(8) The analyzer meets the interference verification if the result of paragraph (d)(7) of this section meets the tolerance in paragraph (c) of this section.

(9) You may also run interference procedures separately for individual interference gases. If the interference gas levels used are higher than the maximum levels expected during testing, you may scale down each observed interference value (the arithmetic mean of 30 second data described in paragraph (d)(7) of this section) by multiplying the observed interference by the ratio of the maximum expected concentration value to the actual value used during this procedure. You may run separate interference concentrations of H<sub>2</sub>O (down to 0.025 mol/mol H<sub>2</sub>O content) that are lower than the maximum levels expected during testing, but you must scale up the observed H<sub>2</sub>O interference by multiplying the observed interference by the ratio of the maximum expected H<sub>2</sub>O concentration value to the actual value used during this procedure. The sum of the scaled interference values must meet the tolerance for combined interference as specified in paragraph (c) of this section.

■ 285. Section 1065.376 is amended by revising paragraphs (b), (d)(2)(vi), and (d)(2)(viii) to read as follows:

**§ 1065.376 Chiller NO<sub>2</sub> penetration.**

\* \* \* \* \*

(b) *Measurement principles.* A chiller removes H<sub>2</sub>O, which can otherwise

interfere with a NO<sub>x</sub> measurement. However, liquid H<sub>2</sub>O remaining in an improperly designed chiller can remove NO<sub>2</sub> from the sample. If a chiller is used without an NO<sub>2</sub>-to-NO converter upstream, it could remove NO<sub>2</sub> from the sample prior NO<sub>x</sub> measurement.

\* \* \* \* \*

(d) \* \* \*  
(2) \* \* \*

(vi) Next saturate the sampling system by overflowing a dewpoint generator's output, set at a dewpoint of 50 °C, to the gas sampling system's probe or overflow fitting. Sample the dewpoint generator's output through the sampling system and chiller for at least 10 minutes until the chiller is expected to be removing a constant rate of H<sub>2</sub>O.

\* \* \* \* \*

(viii) Correct  $x \text{NO}_{x\text{meas}}$  to  $x \text{NO}_{x\text{dry}}$  based upon the residual H<sub>2</sub>O vapor that passed through the chiller at the chiller's outlet temperature and pressure.

\* \* \* \* \*

#### Subpart E—[Amended]

■ 286. Section 1065.405 is revised to read as follows:

##### § 1065.405 Test engine preparation and maintenance.

This part 1065 describes how to test engines for a variety of purposes, including certification testing, production-line testing, and in-use testing. Depending on which type of testing is being conducted, different preparation and maintenance requirements apply for the test engine.

(a) If you are testing an emission-data engine for certification, make sure it is built to represent production engines, consistent with paragraph (f) of this section. This includes governors that you normally install on production engines. Production engines should also be tested with their installed governors. If your engine is equipped with multiple user-selectable governor types and if the governor does not manipulate the emission control system (i.e., the governor only modulates an "operator demand" signal such as commanded fuel rate, torque, or power), choose the governor type that allows the test cell to most accurately follow the duty cycle. If the governor manipulates the emission control system, treat it as an adjustable parameter. See paragraph (b) of this section for guidance on setting adjustable parameters. If you do not install governors on production engines, simulate a governor that is representative of a governor that others will install on your production engines. In certain circumstances, you may

incorporate test cell components to simulate an in-use configuration, consistent with good engineering judgment. For example, §§ 1065.122 and 1065.125 allow the use of test cell components to represent engine cooling and intake air systems. The provisions in § 1065.110(e) also apply to emission-data engines for certification.

(b) We may set adjustable parameters to any value in the valid range, and you are responsible for controlling emissions over the full valid range. For each adjustable parameter, if the standard-setting part has no unique requirements and if we have not specified a value, use good engineering judgment to select the most common setting. If information on the most common setting is not available, select the setting representing the engine's original shipped configuration. If information on the most common and original settings is not available, set the adjustable parameter in the middle of the valid range.

(c) Testing generally occurs only after the test engine has undergone a stabilization step (or in-use operation). If the engine has not already been stabilized, run the test engine, with all emission control systems operating, long enough to stabilize emission levels. Note that you must generally use the same stabilization procedures for emission-data engines for which you apply the same deterioration factors so low-hour emission-data engines are consistent with the low-hour engine used to develop the deterioration factor.

(1) Unless otherwise specified in the standard-setting part, you may consider emission levels stable without measurement after 50 h of operation. If the engine needs less operation to stabilize emission levels, record your reasons and the methods for doing this, and give us these records if we ask for them. If the engine will be tested for certification as a low-hour engine, see the standard-setting part for limits on testing engines to establish low-hour emission levels.

(2) You may stabilize emissions from a catalytic exhaust aftertreatment device by operating it on a different engine, consistent with good engineering judgment. Note that good engineering judgment requires that you consider both the purpose of the test and how your stabilization method will affect the development and application of deterioration factors. For example, this method of stabilization is generally not appropriate for production engines. We may also allow you to stabilize emissions from a catalytic exhaust aftertreatment device by operating it on an engine-exhaust simulator.

(d) Record any maintenance, modifications, parts changes, diagnostic or emissions testing and document the need for each event. You must provide this information if we request it.

(e) For accumulating operating hours on your test engines, select engine operation that represents normal in-use operation for the engine family.

(f) If your engine will be used in a vehicle equipped with a canister for storing evaporative hydrocarbons for eventual combustion in the engine and the test sequence involves a cold-start or hot-start duty cycle, attach a canister to the engine before running an emission test. You may omit using an evaporative canister for any hot-stabilized duty cycles. You may request to omit using an evaporative canister during testing if you can show that it would not affect your ability to show compliance with the applicable emission standards. You may operate the engine without an installed canister for service accumulation. Prior to an emission test, use the following steps to precondition a canister and attach it to your engine:

(1) Use a canister and plumbing arrangement that represents the in-use configuration of the largest capacity canister in all expected applications.

(2) Precondition the canister as described in 40 CFR 86.132–96(j).

(3) Connect the canister's purge port to the engine.

(4) Plug the canister port that is normally connected to the fuel tank.

(g) This paragraph (g) defines the components that are considered to be part of the engine for laboratory testing. See § 1065.110 for provisions related to system boundaries with respect to work inputs and outputs.

(1) This paragraph (g)(1) describes certain criteria for considering a component to be part of the test engine. The criteria are intended to apply broadly, such that a component would generally be considered part of the engine in cases of uncertainty. Except as specified in paragraph (g)(2) of this section, an engine-related component meeting both the following criteria is considered to be part of the test engine for purposes of testing and for stabilizing emission levels, preconditioning, and measuring emission levels:

(i) The component directly affects the functioning of the engine, is related to controlling emissions, or transmits engine power. This would include engine cooling systems, engine controls, and transmissions.

(ii) The component is covered by the applicable certificate of conformity. For example, this criterion would typically

exclude radiators not described in an application for certification.

(2) This paragraph (g)(2) applies for engine-related components that meet the criteria of paragraph (g)(1) of this section, but that are part of the laboratory setup or are used for other engines. Such components are considered to be part of the test engine for preconditioning, but not for engine stabilization. For example, if you test your engines using the same laboratory exhaust tubing for all tests, there would be no restrictions on the number of test hours that could be accumulated with the tubing, but it would need to be preconditioned separately for each engine.

■ 287. Section 1065.410 is amended by revising paragraph (c) to read as follows:

**§ 1065.410 Maintenance limits for stabilized test engines.**

\* \* \* \* \*

(c) If you inspect an engine, keep a record of the inspection and update your application to document any changes that result. You may use any kind of equipment, instrument, or tool to identify bad engine components or perform maintenance if it is available at dealerships and other service outlets.

\* \* \* \* \*

**Subpart F—[Amended]**

■ 288. Section 1065.501 is revised to read as follows:

**§ 1065.501 Overview.**

(a) Use the procedures detailed in this subpart to measure engine emissions over a specified duty cycle. Refer to subpart J of this part for field test procedures that describe how to measure emissions during in-use engine operation. This section describes how to:

(1) Map your engine, if applicable, by recording specified speed and torque data, as measured from the engine's primary output shaft.

(2) Transform normalized duty cycles into reference duty cycles for your engine by using an engine map.

(3) Prepare your engine, equipment, and measurement instruments for an emission test.

(4) Perform pre-test procedures to verify proper operation of certain equipment and analyzers.

(5) Record pre-test data.

(6) Start or restart the engine and sampling systems.

(7) Sample emissions throughout the duty cycle.

(8) Record post-test data.

(9) Perform post-test procedures to verify proper operation of certain equipment and analyzers.

(10) Weigh PM samples.

(b) Unless we specify otherwise, you may control the regeneration timing of infrequently regenerated aftertreatment devices such as diesel particulate filters using good engineering judgment. You may control the regeneration timing using a sequence of engine operating conditions or you may initiate regeneration with an external regeneration switch or other command. This provision also allows you to ensure that a regeneration event does not occur during an emission test.

(c) An emission test generally consists of measuring emissions and other parameters while an engine follows one or more duty cycles that are specified in the standard-setting part. There are two general types of duty cycles:

(1) *Transient cycles.* Transient duty cycles are typically specified in the standard-setting part as a second-by-second sequence of speed commands and normalized torque (or power) commands. Operate an engine over a transient cycle such that the speed and torque of the engine's primary output shaft follows the target values. Proportionally sample emissions and other parameters and use the calculations in subpart G of this part to calculate emissions. Start a transient test according to the standard-setting part, as follows:

(i) A cold-start transient cycle where you start to measure emissions just before starting an engine that has not been warmed up.

(ii) A hot-start transient cycle where you start to measure emissions just before starting a warmed-up engine.

(iii) A hot running transient cycle where you start to measure emissions after an engine is started, warmed up, and running.

(2) *Steady-state cycles.* Steady-state duty cycles are typically specified in the standard-setting part as a list of discrete operating points (modes or notches), where each operating point has one value of a normalized speed command and one value of a normalized torque (or power) command. Ramped-modal cycles for steady-state testing also list test times for each mode and transition times between modes where speed and torque are linearly ramped between modes, even for cycles with % power. Start a steady-state cycle as a hot running test, where you start to measure emissions after an engine is started, warmed up and running. Run a steady-state duty cycle as a discrete-mode cycle or a ramped-modal cycle, as follows:

(i) *Discrete-mode cycles.* Before emission sampling, stabilize an engine at the first discrete mode of the duty cycle specified in the standard-setting

part. Sample emissions and other parameters for that mode in the same manner as a transient cycle, with the exception that reference speed and torque values are constant. Record data for that mode, transition to the next mode, and then stabilize the engine at the next mode. Continue to sample each mode discretely as a separate test interval and calculate composite brake-specific emission results according to § 1065.650(g)(2).

(A) Use good engineering judgment to determine the time required to stabilize the engine. You may make this determination before starting the test based on prior experience, or you may make this determination in real time based on an automated stability criteria. If needed, you may continue to operate the engine after reaching stability to get laboratory equipment ready for sampling.

(B) Collect PM on separate PM sample media for each mode.

(C) The minimum sample time is 60 seconds. We recommend that you sample both gaseous and PM emissions over the same test interval. If you sample gaseous and PM emissions over different test intervals, there must be no change in engine operation between the two test intervals. These two test intervals may completely or partially overlap, they may run consecutively, or they may be separated in time.

(ii) *Ramped-modal cycles.* Perform ramped-modal cycles similar to the way you would perform transient cycles, except that ramped-modal cycles involve mostly steady-state engine operation. Generate a ramped-modal duty cycle as a sequence of second-by-second (1 Hz) reference speed and torque points. Run the ramped-modal duty cycle in the same manner as a transient cycle and use the 1 Hz reference speed and torque values to validate the cycle, even for cycles with % power. Proportionally sample emissions and other parameters during the cycle and use the calculations in subpart G of this part to calculate emissions.

(d) Other subparts in this part identify how to select and prepare an engine for testing (subpart E), how to perform the required engine service accumulation (subpart E), and how to calculate emission results (subpart G).

(e) Subpart J of this part describes how to perform field testing.

■ 289. Section 1065.510 is amended by revising paragraph (d)(5)(ii) to read as follows:

**§ 1065.510 Engine mapping.**

\* \* \* \* \*

(d) \* \* \*

(5) \* \* \*

(ii) For any constant-speed engine, you may perform an engine map with a continuous torque sweep by continuing to record the mean feedback speed and torque at 1 Hz or more frequently. Use the dynamometer to increase torque. Increase the reference torque at a constant rate from no-load to the endpoint torque as defined in paragraph (d)(5)(i) of this section. You may continue mapping at higher torque setpoints. Unless the standard-setting part specifies otherwise, target a torque sweep rate equal to the manufacturer-declared test torque (or a torque derived from your published power level if the declared test torque is not known) divided by 180 seconds. Stop recording after you complete the sweep. Verify that the average torque sweep rate over the entire map is within  $\pm 7\%$  of the target torque sweep rate. Use linear interpolation to determine intermediate values from this series of mean feedback speed and torque values. Use this series of mean feedback speeds and torques to generate the power map as described in paragraph (e) of this section.

\* \* \* \* \*

■ 290. Section 1065.512 is amended by revising paragraph (b)(5) to read as follows:

**§ 1065.512 Duty cycle generation.**

\* \* \* \* \*

(b) \* \* \*

(5) *Ramped-modal cycles.* For ramped-modal cycles, generate reference speed and torque values at 1 Hz and use this sequence of points to run the cycle and validate it in the same manner as with a transient cycle. During the transition between modes, linearly ramp the denormalized reference speed and torque values between modes to generate reference points at 1 Hz. Do not linearly ramp the normalized reference torque values between modes and then denormalize them. Do not linearly ramp normalized or denormalized reference power points. These cases will produce nonlinear torque ramps in the denormalized reference torques. If the speed and torque ramp runs through a point above the engine's torque curve, continue to command the reference torques and allow the operator demand to go to maximum. Note that you may omit power and either torque or speed points from the cycle-validation criteria under these conditions as specified in § 1065.514.

\* \* \* \* \*

■ 291. A new § 1065.516 is added to subpart F to read as follows:

**§ 1065.516 Sample system decontamination and preconditioning.**

This section describes how to manage the impact of sampling system contamination on emission measurements. Use good engineering judgment to determine if you should decontaminate and precondition your sampling system. Contamination occurs when a regulated pollutant accumulates in the sample system in a high enough concentration to cause release during emission tests. Hydrocarbons and PM are generally the only regulated pollutants that contaminate sample systems. Note that although this section focuses on avoiding excessive contamination of sampling systems, you must also use good engineering judgment to avoid loss of sample to a sampling system that is too clean. The goal of decontamination is not to perfectly clean the sampling system, but rather to achieve equilibrium between the sampling system and the exhaust so emission components are neither lost to nor entrained from the sampling system.

(a) You may perform contamination checks as follows to determine if decontamination is needed:

(1) For dilute exhaust sampling systems, measure hydrocarbon and PM emissions by sampling with the CVS dilution air turned on, without an engine connected to it.

(2) For raw analyzers and systems that collect PM samples from raw exhaust, measure hydrocarbon and PM emissions by sampling purified air or nitrogen.

(3) When calculating zero emission levels, apply all applicable corrections, including initial THC contamination and diluted (CVS) exhaust background corrections.

(4) Sampling systems are considered contaminated if either of the following conditions applies:

(i) The hydrocarbon emission level exceeds 2% of the flow-weighted mean concentration expected at the HC standard.

(ii) The PM emission level exceeds 5% of the level expected at the standard and exceeds 20  $\mu\text{g}$  on a 47 mm PTFE membrane filter.

(b) To precondition or decontaminate sampling systems, use the following recommended procedure or select a different procedure using good engineering judgment:

(1) Start the engine and use good engineering judgment to operate it at a condition that generates high exhaust temperatures at the sample probe inlet.

(2) Operate any dilution systems at their expected flow rates. Prevent aqueous condensation in the dilution systems.

(3) Operate any PM sampling systems at their expected flow rates.

(4) Sample PM for at least 10 min using any sample media. You may change sample media at any time during this process and you may discard them without weighing them.

(5) You may purge any gaseous sampling systems that do not require decontamination during this procedure.

(6) You may conduct calibrations or verifications on any idle equipment or analyzers during this procedure.

(c) If your sampling system is still contaminated following the procedures specified in paragraph (b) of this section, you may use more aggressive procedures to decontaminate the sampling system, as long as the decontamination does not cause the sampling system to be cleaner than an equilibrium condition such that artificially low emission measurements may result.

■ 292. A new § 1065.518 is added to subpart F to read as follows:

**§ 1065.518 Engine preconditioning.**

(a) This section applies for engines where measured emissions are affected by prior operation, such as with a diesel engine that relies on urea-based selective catalytic reduction. Note that § 1065.520(e) allows you to run practice duty cycles before the emission test; this section recommends how to do this for the purpose of preconditioning the engine. Follow the standard-setting part if it specifies a different engine preconditioning procedure.

(b) The intent of engine preconditioning is to manage the representativeness of emissions and emission controls over the duty cycle and to reduce bias.

(c) This paragraph (c) specifies the engine preconditioning procedures for different types of duty cycles. You must identify the amount of preconditioning before starting to precondition. You must run the predefined amount of preconditioning. You may measure emissions during preconditioning. You may not abort an emission test sequence based on emissions measured during preconditioning. For confirmatory testing, you may ask us to run more preconditioning cycles than we specify in this paragraph (c); we will agree to this only if you show that additional preconditioning cycles are required to meet the intent of paragraph (b) of this section, for example, due to the effect of DPF regeneration on  $\text{NH}_3$  storage in the SCR catalyst. Perform preconditioning as follows, noting that the specific cycles for preconditioning are the same ones that apply for emission testing:



*(1) Cold-start transient cycle.*

Precondition the engine by running at least one hot-start transient cycle. We will precondition your engine by running two hot-start transient cycles. Immediately after completing each preconditioning cycle, shut down the engine and complete the engine-off soak period. Immediately after completing the last preconditioning cycle, shut down the engine and begin the cold soak as described in § 1065.530(a)(1).

*(2) Hot-start transient cycle.*

Precondition the engine by running at least one hot-start transient cycle. We will precondition your engine by running two hot-start transient cycles. Immediately after completing each preconditioning cycle, shut down the engine, then start the next cycle (including the emission test) as soon as practical. For any repeat cycles, start the next cycle within 60 seconds after completing the last preconditioning cycle (this is optional for manufacturer testing).

*(3) Hot-running transient cycle.*

Precondition the engine by running at least one hot-running transient cycle. We will precondition your engine by running two hot-running transient cycles. Do not shut down the engine between cycles. Immediately after completing each preconditioning cycle, start the next cycle (including the emission test) as soon as practical. For any repeat cycles, start the next cycle within 60 seconds after completing the last preconditioning cycle (this is optional for manufacturer testing). See § 1065.530(a)(1)(iii) for additional instructions if the cycle begins and ends under different operating conditions.

*(4) Discrete-mode cycle for steady-state testing.* Precondition the engine at the same operating condition as the next test mode, unless the standard-setting part specifies otherwise. We will precondition your engine by running it for at least five minutes before sampling.

*(5) Ramped-modal cycle for steady-state testing.* Precondition the engine by running at least the second half of the ramped-modal cycle, based on the number of test modes. For example, for the five-mode cycle specified in 40 CFR 1039.505(b)(1), the second half of the cycle consists of modes three through five. We will precondition your engine by running one complete ramped-modal cycle. Do not shut down the engine between cycles. Immediately after completing each preconditioning cycle, start the next cycle (including the emission test) as soon as practical. For any repeat cycles, start the next cycle within 60 seconds after completing the last preconditioning cycle. See § 1065.530(a)(1)(iii) for additional

instructions if the cycle begins and ends under different operating conditions.

(d) You may conduct calibrations or verifications on any idle equipment or analyzers during engine preconditioning.

■ 293. Section 1065.520 is revised to read as follows:

**§ 1065.520 Pre-test verification procedures and pre-test data collection.**

(a) For tests in which you measure PM emissions, follow the procedures for PM sample preconditioning and tare weighing according to § 1065.590.

(b) Unless the standard-setting part specifies different tolerances, verify at some point before the test that ambient conditions are within the tolerances specified in this paragraph (b). For purposes of this paragraph (b), “before the test” means any time from a point just prior to engine starting (excluding engine restarts) to the point at which emission sampling begins.

(1) Ambient temperature of (20 to 30) °C. See § 1065.530(j) for circumstances under which ambient temperatures must remain within this range during the test.

(2) Atmospheric pressure of (80.000 to 103.325) kPa and within ±5 kPa of the value recorded at the time of the last engine map. You are not required to verify atmospheric pressure prior to a hot start test interval for testing that also includes a cold start.

(3) Dilution air conditions as specified in § 1065.140, except in cases where you preheat your CVS before a cold start test. We recommend verifying dilution air conditions just prior to the start of each test interval.

(c) You may test engines at any intake-air humidity, and we may test engines at any intake-air humidity.

(d) Verify that auxiliary-work inputs and outputs are configured as they were during engine mapping, as described in § 1065.510(a).

(e) You may perform a final calibration of the speed, torque, and proportional-flow control systems, which may include performing practice duty cycles (or portions of duty cycles). This may be done in conjunction with the preconditioning in § 1065.518.

(f) Verify the amount of nonmethane hydrocarbon contamination in the exhaust and background HC sampling systems within 8 hours before the start of the first test interval of each duty-cycle sequence for laboratory tests. You may verify the contamination of a background HC sampling system by reading the last bag fill and purge using zero gas. For any NMHC measurement system that involves separately measuring CH<sub>4</sub> and subtracting it from

a THC measurement or for any CH<sub>4</sub> measurement system that uses an NMC, verify the amount of THC contamination using only the THC analyzer response. There is no need to operate any separate CH<sub>4</sub> analyzer for this verification; however, you may measure and correct for THC contamination in the CH<sub>4</sub> sample path for the cases where NMHC is determined by subtracting CH<sub>4</sub> from THC or, where CH<sub>4</sub> is determined, using an NMC as configured in § 1065.365(d), (e), and (f); and using the calculations in § 1065.660(b)(2). Perform this verification as follows:

(1) Select the HC analyzer range for measuring the flow-weighted mean concentration expected at the HC standard.

(2) Zero the HC analyzer at the analyzer zero or sample port. Note that FID zero and span balance gases may be any combination of purified air or purified nitrogen that meets the specifications of § 1065.750. We recommend FID analyzer zero and span gases that contain approximately the flow-weighted mean concentration of O<sub>2</sub> expected during testing.

(3) Span the HC analyzer using span gas introduced at the analyzer span or sample port. Span on a carbon number basis of one (C<sub>1</sub>). For example, if you use a C<sub>3</sub>H<sub>8</sub> span gas of concentration 200 µmol/mol, span the FID to respond with a value of 600 µmol/mol.

(4) Overflow zero gas at the HC probe inlet or into a tee near the probe outlet.

(5) Measure the THC concentration in the sampling and background systems as follows:

(i) For continuous sampling, record the mean THC concentration as overflow zero gas flows.

(ii) For batch sampling, fill the sample medium (e.g., bag) and record its mean THC concentration.

(iii) For the background system, record the mean THC concentration of the last fill and purge.

(6) Record this value as the initial THC concentration,  $X_{\text{THC}[\text{THC-FID}]_{\text{init}}}$ , and use it to correct measured values as described in § 1065.660.

(7) You may correct the measured initial THC concentration for drift as follows:

(i) For batch and continuous HC analyzers, after determining the initial THC concentration, flow zero gas to the analyzer zero or sample port. When the analyzer reading is stable, record the mean analyzer value.

(ii) Flow span gas to the analyzer span or sample port. When the analyzer reading is stable, record the mean analyzer value.

(iii) Use mean analyzer values from paragraphs (f)(2), (f)(3), (f)(7)(i), and



(f)(7)(ii) of this section to correct the initial THC concentration recorded in paragraph (f)(6) of this section for drift, as described in § 1065.550.

(8) If any of the  $x_{\text{THC}|\text{THC-FID}}^{\text{init}}$  values exceed the greatest of the following values, determine the source of the contamination and take corrective action, such as purging the system during an additional preconditioning cycle or replacing contaminated portions:

(i) 2% of the flow-weighted mean concentration expected at the HC (THC or NMHC) standard.

(ii) 2% of the flow-weighted mean concentration of HC (THC or NMHC) measured during testing.

(iii) 2  $\mu\text{mol/mol}$ .

(9) If corrective action does not resolve the deficiency, you may request to use the contaminated system as an alternate procedure under § 1065.10.

■ 294. Section 1065.526 is revised to read as follows:

**§ 1065.526 Repeating of void modes or test intervals.**

(a) Test modes and test intervals can be voided because of instrument malfunction, engine stalling, emissions exceeding instrument ranges, and other unexpected deviations from the specified procedures. This section specifies circumstances for which a test mode or test interval can be repeated without repeating the entire test.

(b) This section is intended to result in replicate test modes and test intervals that are identical to what would have occurred if the cause of the voiding had not occurred. It does not allow you to repeat test modes or test intervals in any circumstances that would be inconsistent with good engineering judgment. For example, the procedures specified here for repeating a mode or interval may not apply for certain engines that include hybrid energy storage features or emission controls that involve physical or chemical storage of pollutants. This section applies for circumstances in which emission concentrations exceed the analyzer range only if it is due to operator error or analyzer malfunction. It does not apply for circumstances in which the emission concentrations exceed the range because they were higher than expected.

(c) If one of the modes of a discrete-mode duty cycle is voided while running the duty cycle as provided in this section, you may void the results for that individual mode and continue the duty cycle as follows:

(1) If the engine has stalled or been shut down, restart the engine.

(2) Use good engineering judgment to restart the duty cycle using the appropriate steps in § 1065.530(b).

(3) Stabilize the engine by operating it at the mode at which the duty cycle was interrupted and continue with the duty cycle as specified in the standard-setting part.

(d) If an individual mode of a discrete-mode duty cycle sequence is voided after running the full duty cycle, you may void results for that mode and repeat testing for that mode as follows:

(1) Use good engineering judgment to restart the test sequence using the appropriate steps in § 1065.530(b).

(2) Stabilize the engine by operating it at that mode.

(3) Sample emissions over an appropriate test interval.

(4) If you sampled gaseous and PM emissions over separate test intervals for a voided mode, you must void both test intervals and repeat sampling of both gaseous and PM emissions for that mode.

(e) If a transient or ramped-modal cycle test interval is voided as provided in this section, you may repeat the test interval as follows:

(1) Use good engineering judgment to restart (as applicable) and precondition the engine to the same condition as would apply for normal testing. This may require you to complete the voided test interval. For example, you may generally repeat a hot-start test of a heavy-duty highway engine after completing the voided hot-start test and allowing the engine to soak for 20 minutes.

(2) Complete the remainder of the test according to the provisions in this subpart.

(f) Keep records from the voided test mode or test interval in the same manner as required for unvoided tests.

■ 295. Section 1065.530 is amended by revising paragraphs (a), (b), and (c) to read as follows:

**§ 1065.530 Emission test sequence.**

(a) Time the start of testing as follows:

(1) Perform one of the following if you precondition the engine as described in § 1065.518:

(i) For cold-start duty cycles, shut down the engine. Unless the standard-setting part specifies that you may only perform a natural engine cooldown, you may perform a forced engine cooldown. Use good engineering judgment to set up systems to send cooling air across the engine, to send cool oil through the engine lubrication system, to remove heat from coolant through the engine cooling system, and to remove heat from any exhaust aftertreatment systems. In the case of a forced aftertreatment

cooldown, good engineering judgment would indicate that you not start flowing cooling air until the aftertreatment system has cooled below its catalytic activation temperature. For platinum-group metal catalysts, this temperature is about 200 °C. Once the aftertreatment system has naturally cooled below its catalytic activation temperature, good engineering judgment would indicate that you use clean air with a temperature of at least 15 °C, and direct the air through the aftertreatment system in the normal direction of exhaust flow. Do not use any cooling procedure that results in unrepresentative emissions (see § 1065.10(c)(1)). You may start a cold-start duty cycle when the temperatures of an engine's lubricant, coolant, and aftertreatment systems are all between (20 and 30) °C.

(ii) For hot-start emission measurements, shut down the engine immediately after completing the last preconditioning cycle. For any repeat cycles, start the hot-start transient emission test within 60 seconds after completing the last preconditioning cycle (this is optional for manufacturer testing).

(iii) For testing that involves hot-stabilized emission measurements, such as any steady-state testing with a ramped-modal cycle, start the hot-stabilized emission test within 60 seconds after completing the last preconditioning cycle (the time between cycles is optional for manufacturer testing). If the hot-stabilized cycle begins and ends with different operating conditions, add a linear transition period of 20 seconds between hot-stabilized cycles where you linearly ramp the (denormalized) reference speed and torque values over the transition period. See § 1065.501(c)(2)(i) for discrete-mode cycles.

(2) If you do not precondition the engine as described in § 1065.518, perform one of the following:

(i) For cold-start duty cycles, prepare the engine according to paragraph (a)(1)(i) of this section.

(ii) For hot-start duty cycles, first operate the engine at any speed above peak-torque speed and at (65 to 85) % of maximum mapped power until either the engine coolant, block, or head absolute temperature is within  $\pm 2\%$  of its mean value for at least 2 min or until the engine thermostat controls engine temperature. Shut down the engine. Start the duty cycle within 20 min of engine shutdown.

(iii) For testing that involves hot-stabilized emission measurements, bring the engine either to warm idle or the first operating point of the duty cycle.

Start the test within 10 min of achieving temperature stability. Determine temperature stability either as the point at which the engine coolant, block, or head absolute temperature is within  $\pm 2\%$  of its mean value for at least 2 min, or as the point at which the engine thermostat controls engine temperature.

(b) Take the following steps before emission sampling begins:

(1) For batch sampling, connect clean storage media, such as evacuated bags or tare-weighted filters.

(2) Start all measurement instruments according to the instrument manufacturer's instructions and using good engineering judgment.

(3) Start dilution systems, sample pumps, cooling fans, and the data-collection system.

(4) Pre-heat or pre-cool heat exchangers in the sampling system to within their operating temperature tolerances for a test.

(5) Allow heated or cooled components such as sample lines, filters, chillers, and pumps to stabilize at their operating temperatures.

(6) Verify that there are no significant vacuum-side leaks according to § 1065.345.

(7) Adjust the sample flow rates to desired levels, using bypass flow, if desired.

(8) Zero or re-zero any electronic integrating devices, before the start of any test interval.

(9) Select gas analyzer ranges. You may automatically or manually switch gas analyzer ranges during a test only if switching is performed by changing the span over which the digital resolution of the instrument is applied. During a test you may not switch the gains of an analyzer's analog operational amplifier(s).

(10) Zero and span all continuous analyzers using NIST-traceable gases that meet the specifications of § 1065.750. Span FID analyzers on a carbon number basis of one (1),  $C_1$ . For example, if you use a  $C_3H_8$  span gas of concentration 200  $\mu\text{mol/mol}$ , span the FID to respond with a value of 600  $\mu\text{mol/mol}$ . Span FID analyzers consistent with the determination of their respective response factors, *RF*, and penetration fractions, *PF*, according to § 1065.365.

(11) We recommend that you verify gas analyzer responses after zeroing and spanning by sampling a calibration gas that has a concentration near one-half of the span gas concentration. Based on the results and good engineering judgment, you may decide whether or not to re-zero, re-span, or re-calibrate a gas analyzer before starting a test.

(12) Drain any accumulated condensate from the intake air system before starting a duty cycle, as described in § 1065.125(e)(1). If engine and aftertreatment preconditioning cycles are run before the duty cycle, treat the preconditioning cycles and any associated soak period as part of the duty cycle for the purpose of opening drains and draining condensate. Note that you must close any intake air condensate drains that are not representative of those normally open during in-use operation.

(c) Start and run each test interval as described in this paragraph (c). The procedure varies depending on whether the test interval is part of a discrete-mode cycle, and whether the test interval includes engine starting. Note that the standard-setting part may apply different requirements for running test intervals. For example, 40 CFR part 1033 specifies a different way to perform discrete-mode testing.

(1) For steady-state discrete-mode duty cycles, start the duty cycle with the engine warmed-up and running as described in § 1065.501(c)(2)(i). Run each mode in the sequence specified in the standard-setting part. This will require controlling engine speed, engine load, or other operator demand settings as specified in the standard-setting part. Simultaneously start any electronic integrating devices, continuous data recording, and batch sampling. We recommend that you stabilize the engine for at least 5 minutes for each mode. Once sampling begins, sample continuously for at least 1 minute. Note that longer sample times may be needed for accurately measuring very low emission levels.

(2) For transient and steady-state ramped-modal duty cycles that do not include engine starting, start the test interval with the engine running as soon as practical after completing engine preconditioning. Simultaneously start any electronic integrating devices, continuous data recording, batch sampling, and execution of the duty cycle.

(3) If engine starting is part of the test interval, simultaneously start any electronic integrating devices, continuous data recording, and batch sampling before attempting to start the engine. Initiate the sequence of points in the duty cycle when the engine starts.

(4) For batch sampling systems, you may advance or delay the start and end of sampling at the beginning and end of the test interval to improve the accuracy of the batch sample, consistent with good engineering judgment.

\* \* \* \* \*

■ 296. Section 1065.545 is revised to read as follows:

**§ 1065.545 Verification of proportional flow control for batch sampling.**

For any proportional batch sample such as a bag or PM filter, demonstrate that proportional sampling was maintained using one of the following, noting that you may omit up to 5% of the total number of data points as outliers:

(a) For any pair of flow rates, use recorded sample and total flow rates, where total flow rate means the raw exhaust flow rate for raw exhaust sampling and the dilute exhaust flow rate for CVS sampling, or their 1 Hz means with the statistical calculations in § 1065.602. Determine the standard error of the estimate, *SEE*, of the sample flow rate versus the total flow rate. For each test interval, demonstrate that *SEE* was less than or equal to 3.5% of the mean sample flow rate.

(b) For any pair of flow rates, use recorded sample and total flow rates, where total flow rate means the raw exhaust flow rate for raw exhaust sampling and the dilute exhaust flow rate for CVS sampling, or their 1 Hz means to demonstrate that each flow rate was constant within  $\pm 2.5\%$  of its respective mean or target flow rate. You may use the following options instead of recording the respective flow rate of each type of meter:

(1) *Critical-flow venturi option*. For critical-flow venturis, you may use recorded venturi-inlet conditions or their 1 Hz means. Demonstrate that the flow density at the venturi inlet was constant within  $\pm 2.5\%$  of the mean or target density over each test interval. For a CVS critical-flow venturi, you may demonstrate this by showing that the absolute temperature at the venturi inlet was constant within  $\pm 4\%$  of the mean or target absolute temperature over each test interval.

(2) *Positive-displacement pump option*. You may use recorded pump-inlet conditions or their 1 Hz means. Demonstrate that the flow density at the pump inlet was constant within  $\pm 2.5\%$  of the mean or target density over each test interval. For a CVS pump, you may demonstrate this by showing that the absolute temperature at the pump inlet was constant within  $\pm 2\%$  of the mean or target absolute temperature over each test interval.

(c) Using good engineering judgment, demonstrate with an engineering analysis that the proportional-flow control system inherently ensures proportional sampling under all circumstances expected during testing. For example, you might use CFVs for

both sample flow and total dilute exhaust (CVS) flow and demonstrate that they always have the same inlet pressures and temperatures and that they always operate under critical-flow conditions.

■ 297. Section 1065.546 is amended by revising the section heading and the introductory text to read as follows:

**§ 1065.546 Verification of minimum dilution ratio for PM batch sampling.**

Use continuous flows and/or tracer gas concentrations for transient and ramped-modal cycles to verify the minimum dilution ratios for PM batch sampling as specified in § 1065.140(e)(2) over the test interval. You may use mode-average values instead of continuous measurements for discrete mode steady-state duty cycles. Determine the minimum primary and minimum overall dilution ratios using one of the following methods (you may use a different method for each stage of dilution):

\* \* \* \* \*

■ 298. Section 1065.550 is revised to read as follows:

**§ 1065.550 Gas analyzer range verification and drift verification.**

(a) *Range verification.* If an analyzer operated above 100% of its range at any time during the test, perform the following steps:

(1) For batch sampling, re-analyze the sample using the lowest analyzer range that results in a maximum instrument response below 100%. Report the result from the lowest range from which the analyzer operates below 100% of its range.

(2) For continuous sampling, repeat the entire test using the next higher analyzer range. If the analyzer again operates above 100% of its range, repeat the test using the next higher range. Continue to repeat the test until the analyzer always operates at less than 100% of its range.

(b) *Drift verification.* Gas analyzer drift verification is required for all gaseous exhaust constituents for which an emission standard applies. It is also required for CO<sub>2</sub> even if there is no CO<sub>2</sub> emission standard. It is not required for other gaseous exhaust constituents for which only a reporting requirement applies (such as CH<sub>4</sub> and N<sub>2</sub>O).

(1) Verify drift using one of the following methods:

(i) For regulated exhaust constituents determined from the mass of a single component, perform drift verification based on the regulated constituent. For example, when NO<sub>x</sub> mass is determined with a dry sample measured with a CLD and the removed water is corrected

based on measured CO<sub>2</sub>, CO, THC, and NO<sub>x</sub> concentrations, you must verify the calculated NO<sub>x</sub> value.

(ii) For regulated exhaust constituents determined from the masses of multiple subcomponents, perform the drift verification based on either the regulated constituent or all the mass subcomponents. For example, when NO<sub>x</sub> is measured with separate NO and NO<sub>2</sub> analyzers, you must verify either the NO<sub>x</sub> value or both the NO and NO<sub>2</sub> values.

(iii) For regulated exhaust constituents determined from the concentrations of multiple gaseous emission subcomponents prior to performing mass calculations, perform drift verification on the regulated constituent. You may not verify the concentration subcomponents (e.g., THC and CH<sub>4</sub> for NMHC) separately. For example, for NMHC measurements, perform drift verification on NMHC; do not verify THC and CH<sub>4</sub> separately.

(2) Drift verification requires two sets of emission calculations. For each set of calculations, include all the constituents in the drift verification. Calculate one set using the data before drift correction and calculate the other set after correcting all the data for drift according to § 1065.672. Note that for purposes of drift verification, you must leave unaltered any negative emission results over a given test interval (i.e., do not set them to zero). These unaltered results are used when verifying either test interval results or composite brake-specific emissions over the entire duty cycle for drift. For each constituent to be verified, both sets of calculations must include the following:

(i) Calculated mass (or mass rate) emission values over each test interval.

(ii) If you are verifying each test interval based on brake-specific values, calculate brake-specific emission values over each test interval.

(iii) If you are verifying over the entire duty cycle, calculate composite brake-specific emission values.

(3) The duty cycle is verified for drift if you satisfy the following criteria:

(i) For each regulated gaseous exhaust constituent, you must satisfy one of the following:

(A) For each test interval of the duty cycle, the difference between the uncorrected and the corrected brake-specific emission values of the regulated constituent must be within ±4% of the uncorrected value or the applicable emissions standard, whichever is greater. Alternatively, the difference between the uncorrected and the corrected emission mass (or mass rate) values of the regulated constituent must be within ±4% of the uncorrected value

or the composite work (or power) multiplied by the applicable emissions standard, whichever is greater. For purposes of verifying each test interval, you may use either the reference or actual composite work (or power).

(B) For each test interval of the duty cycle and for each mass subcomponent of the regulated constituent, the difference between the uncorrected and the corrected brake-specific emission values must be within ±4% of the uncorrected value. Alternatively, the difference between the uncorrected and the corrected emissions mass (or mass rate) values must be within ±4% of the uncorrected value.

(C) For the entire duty cycle, the difference between the uncorrected and the corrected composite brake-specific emission values of the regulated constituent must be within ±4% of the uncorrected value or applicable emission standard, whichever is greater.

(D) For the entire duty cycle and for each subcomponent of the regulated constituent, the difference between the uncorrected and the corrected composite brake-specific emission values must be within ±4% of the uncorrected value.

(ii) Where no emission standard applies for CO<sub>2</sub>, you must satisfy one of the following:

(A) For each test interval of the duty cycle, the difference between the uncorrected and the corrected brake-specific CO<sub>2</sub> values must be within ±4% of the uncorrected value; or the difference between the uncorrected and the corrected CO<sub>2</sub> mass (or mass rate) values must be within ±4% of the uncorrected value.

(B) For the entire duty cycle, the difference between the uncorrected and the corrected composite brake-specific CO<sub>2</sub> values must be within ±4% of the uncorrected value.

(4) If the test is not verified for drift as described in paragraph (b)(1) of this section, you may consider the test results for the duty cycle to be valid only if, using good engineering judgment, the observed drift does not affect your ability to demonstrate compliance with the applicable emission standards. For example, if the drift-corrected value is less than the standard by at least two times the absolute difference between the uncorrected and corrected values, you may consider the data to be verified for demonstrating compliance with the applicable standard.

**Subpart G—[Amended]**

■ 299. Section 1065.601 is amended by revising paragraph (b) to read as follows:

**§ 1065.601 Overview.**

\* \* \* \* \*

(b) You may use data from multiple systems to calculate test results for a single emission test, consistent with good engineering judgment. You may also make multiple measurements from a single batch sample, such as multiple weighings of a PM filter or multiple readings from a bag sample. Although you may use an average of multiple measurements from a single test, you may not use test results from multiple emission tests to report emissions.

(1) We allow weighted means where appropriate.

(2) You may discard statistical outliers, but you must report all results.

(3) For emission measurements related to durability testing, we may allow you to exclude certain test points other than statistical outliers relative to compliance with emission standards, consistent with good engineering judgment and normal measurement variability; however, you must include these results when calculating the deterioration factor. This would allow you to use durability data from an engine that has an intermediate test result above the standard that cannot be discarded as a statistical outlier, as long as good engineering judgment indicates that the test result does not represent the engine's actual emission level. Note that good engineering judgment would preclude you from excluding endpoints. Also, if normal measurement variability causes emission results below zero, include the negative result in calculating the deterioration factor to avoid an upward bias. These provisions related to durability testing are intended

to address very stringent standards where measurement variability is large relative to the emission standard.

\* \* \* \* \*

■ 300. Section 1065.602 is amended by revising paragraphs (f), (j), (k), and (l)(1)(ii) to read as follows:

**§ 1065.602 Statistics.**

\* \* \* \* \*

(f) *t-test*. Determine if your data passes a *t-test* by using the following equations and tables:

(1) For an unpaired *t-test*, calculate the *t* statistic and its number of degrees of freedom, as follows:

$$t = \frac{|\bar{y}_{\text{ref}} - \bar{y}|}{\sqrt{\frac{\sigma_{\text{ref}}^2}{N_{\text{ref}}} + \frac{\sigma_y^2}{N}}}$$

Eq. 1065.602-5

$$v = \frac{\left(\frac{\sigma_{\text{ref}}^2}{N_{\text{ref}}} + \frac{\sigma_y^2}{N}\right)^2}{\frac{\left(\frac{\sigma_{\text{ref}}^2}{N_{\text{ref}}}\right)^2}{N_{\text{ref}} - 1} + \frac{\left(\frac{\sigma_y^2}{N}\right)^2}{N - 1}}$$

Eq. 1065.602-6

*Example:*

$$\bar{y}_{\text{ref}} = 1205.3$$

$$\bar{y} = 1123.8$$

$$\sigma_{\text{ref}} = 9.399$$

$$\sigma_y = 10.583$$

$$N_{\text{ref}} = 11$$

$$N = 7$$

$$t = \frac{|1205.3 - 1123.8|}{\sqrt{\frac{9.399^2}{11} + \frac{10.583^2}{7}}}$$

$$t = 16.63$$

(2) For a paired *t-test*, calculate the *t* statistic and its number of degrees of freedom, as follows, noting that the  $\epsilon_i$  are the errors (e.g., differences) between each pair of  $y_{\text{ref}i}$  and  $y_i$ :

$$\sigma_{\text{ref}} = 9.399$$

$$\sigma_y = 10.583$$

$$N_{\text{ref}} = 11$$

$$N = 7$$

$$v = \frac{\left( \frac{9.399^2}{11} + \frac{10.583^2}{7} \right)^2}{\frac{\left( \frac{9.399^2}{11} \right)^2}{11-1} + \frac{\left( \frac{10.583^2}{7} \right)^2}{7-1}}$$

$$v = 11.76$$

(2) For a paired  $t$ -test, calculate the  $t$  statistic and its number of degrees of freedom,  $v$ , as follows, noting that the  $\varepsilon_i$  are the errors (e.g., differences) between each pair of  $y_{\text{ref}i}$  and

$y_i$ :

$$t = \frac{|\bar{\varepsilon}| \cdot \sqrt{N}}{\sigma_{\varepsilon}}$$

Eq. 1065.602-7

*Example:*

$$\bar{\varepsilon} = -0.12580$$

$$N = 16$$

$$\sigma_{\varepsilon} = 0.04837$$

$$t = \frac{|-0.12580| \cdot \sqrt{16}}{0.04837}$$

$$t = 10.403$$

$$v = N - 1$$

Example:

$$N = 16$$

$$v = 16 - 1$$

$$v = 15$$

(3) Use Table 1 of this section to compare  $t$  to the  $t_{crit}$  values tabulated versus the number of degrees of freedom. If  $t$  is less than  $t_{crit}$ , then  $t$  passes the  $t$ -test. The Microsoft Excel software has a TINV function that returns results equivalent results and may be used in place of Table 1, which follows:

TABLE 1 OF § 1065.602—CRITICAL  $t$  VALUES VERSUS NUMBER OF DEGREES OF FREEDOM,  $v^1$

v	Confidence	
	90%	95%
1 .....	6.314	12.706
2 .....	2.920	4.303
3 .....	2.353	3.182
4 .....	2.132	2.776
5 .....	2.015	2.571
6 .....	1.943	2.447
7 .....	1.895	2.365
8 .....	1.860	2.306
9 .....	1.833	2.262
10 .....	1.812	2.228
11 .....	1.796	2.201
12 .....	1.782	2.179
13 .....	1.771	2.160

TABLE 1 OF § 1065.602—CRITICAL  $t$  VALUES VERSUS NUMBER OF DEGREES OF FREEDOM,  $v^1$ —Continued

v	Confidence	
	90%	95%
14 .....	1.761	2.145
15 .....	1.753	2.131
16 .....	1.746	2.120
18 .....	1.734	2.101
20 .....	1.725	2.086
22 .....	1.717	2.074
24 .....	1.711	2.064
26 .....	1.706	2.056
28 .....	1.701	2.048
30 .....	1.697	2.042
35 .....	1.690	2.030
40 .....	1.684	2.021

TABLE 1 OF § 1065.602—CRITICAL  $t$  VALUES VERSUS NUMBER OF DEGREES OF FREEDOM,  $v^1$ —Continued

v	Confidence	
	90%	95%
50 .....	1.676	2.009
70 .....	1.667	1.994
100 .....	1.660	1.984
1000+ .....	1.645	1.960

<sup>1</sup> Use linear interpolation to establish values not shown here.

\* \* \* \* \*

(j) *Standard estimate of error.*  
Calculate a standard estimate of error, *SEE*, as follows:

$$SEE_y = \sqrt{\frac{\sum_{i=1}^N [y_i - a_{0y} - (a_{1y} \cdot y_{refi})]^2}{N - 2}}$$

Eq. 1065.602-11

*Example:*

$$N = 6000$$

$$y_1 = 2045.8$$

$$a_{0y} = -16.8083$$

$$a_{1y} = 1.0110$$

$$y_{ref1} = 2045.0$$

$$SEE_y = \sqrt{\frac{[2045.8 - (-16.8083) - (1.0110 \cdot 2045.0)]^2 + \dots + [y_{6000} - (-16.8083) - (1.0110 \cdot y_{ref6000})]^2}{6000 - 2}}$$

$$SEE_y = 5.348$$

(k) Coefficient of determination. Calculate a coefficient of determination,  $r_y^2$ , as follows:

$$r_y^2 = 1 - \frac{\sum_{i=1}^N [y_i - a_{0y} - (a_{1y} \cdot y_{refi})]^2}{\sum_{i=1}^N [y_i - \bar{y}]^2}$$

Eq. 1065.602-12

*Example:*

$$N = 6000$$

$$y_1 = 2045.8$$

$$a_{0y} = -16.8083$$

$$a_{1y} = 1.0110$$



$$y_{\text{ref1}} = 2045.0$$

$$\bar{y} = 1480.5$$

$$r_y^2 = 1 - \frac{[2045.8 - (-16.8083) - (1.0110 \times 2045.0)]^2 + \dots [y_{6000} - (-16.8083) - (1.0110 \cdot y_{\text{ref6000}})]^2}{[2045.8 - 1480.5]^2 + \dots [y_{6000} - 1480.5]^2}$$

$$r_y^2 = 0.9859$$

(l) \* \* \*

(1) \* \* \*

(ii) Based on your engine design, estimate maximum power,  $P_{\text{max}}$ , the design speed at maximum power,  $f_{\text{nmax}}$ , the design maximum intake manifold boost pressure,  $p_{\text{inmax}}$ , and temperature,  $T_{\text{inmax}}$ . Also, estimate a mean fraction of power that is lost due to friction and pumping,  $\bar{p}_{\text{frict}}$ . Use this information along with the engine displacement volume,  $V_{\text{disp}}$ , an approximate volumetric efficiency,  $\eta_v$ , and the number of engine strokes per power stroke (two-stroke or four-stroke),  $N_{\text{stroke}}$ , to estimate the maximum raw exhaust molar flow rate,  $\dot{n}_{\text{exhmax}}$ .

\* \* \* \* \*

■ 301. Section 1065.610 is amended by revising paragraphs (a) introductory

text, (a)(1), (c)(3), and (d)(3)(ii) to read as follows:

**§ 1065.610 Duty cycle generation.**

\* \* \* \* \*

(a) *Maximum test speed,  $f_{\text{n test}}$ .* This section generally applies to duty cycles for variable-speed engines. For constant-speed engines subject to duty cycles that specify normalized speed commands, use the no-load governed speed as the measured  $f_{\text{n test}}$ . This is the highest engine speed where an engine outputs zero torque. For variable-speed engines, determine  $f_{\text{n test}}$  as follows:

(1) Develop a measured value for  $f_{\text{n test}}$  as follows:

(i) Determine maximum power,  $P_{\text{max}}$ , from the engine map generated according to § 1065.510 and calculate

the value for power equal to 98% of  $P_{\text{max}}$ .

(ii) Determine the lowest and highest engine speeds corresponding to 98% of  $P_{\text{max}}$ , using linear interpolation as appropriate.

(iii) Determine the engine speed corresponding to maximum power,  $f_{\text{n Pmax}}$ , by calculating the average of the two speed values from paragraph (a)(1)(ii) of this section.

(iv) Transform the map into a normalized power-versus-speed map by dividing power terms by  $P_{\text{max}}$  and dividing speed terms by  $f_{\text{n Pmax}}$ . Use the following equation to calculate a quantity representing the sum of squares from the normalized map:

$$\text{Sum of squares} = f_{\text{normi}}^2 + P_{\text{normi}}^2$$

Eq. 1065.610-1

Where:

$i$  = an indexing variable that represents one recorded value of an engine map.

$f_{\text{normi}}$  = an engine speed normalized by dividing it by  $f_{\text{n Pmax}}$ .

$P_{\text{normi}}$  = an engine power normalized by dividing it by  $P_{\text{max}}$ .

(v) Determine the maximum value for the sum of the squares from the map and multiply that value by 0.98.

(vi) Determine the lowest and highest engine speeds corresponding to the value calculated in paragraph (a)(1)(v) of this section, using linear interpolation as appropriate.

Calculate  $f_{ntest}$  as the average of these two speed values.

(viii) The following example illustrates a calculation of  $f_{ntest}$ :

$$(f_{n1} = 2360, P_1 = 223.1, f_{nnorm1} = 1.002, P_{norm1} = 0.967)$$

$$(f_{n2} = 2364, P_2 = 227.7, f_{nnorm2} = 1.004, P_{norm2} = 0.986)$$

$$(f_{n3} = 2369, P_3 = 230.0, f_{nnorm3} = 1.006, P_{norm3} = 0.994)$$

$$(f_{n4} = 2374, P_4 = 220.8, f_{nnorm4} = 1.008, P_{norm4} = 0.951)$$

$$f_{ntest} = \frac{\left( \left( 2360 + (2364 - 2360) \cdot \frac{0.98 \cdot 230.0 - 223.1}{227.7 - 223.1} \right) + \left( 2369 + (2374 - 2369) \cdot \frac{0.98 \cdot 230.0 - 230.0}{220.8 - 230.0} \right) \right)}{2}$$

$$= \frac{2363 + 2371}{2} = 2367 \text{ r/min}$$

$$\text{Sum of squares} = (1.002^2 + 0.967^2) = 1.94$$

$$\text{Sum of squares} = (1.004^2 + 0.986^2) = 1.98$$

$$\text{Sum of squares} = (1.006^2 + 0.994^2) = 2.00$$

$$\text{Sum of squares} = (1.008^2 + 0.951^2) = 1.92$$

$$f_{npmax} = \frac{\left( \left( 2360 + (2364 - 2360) \cdot \frac{0.98 \cdot 2.0 - 1.94}{1.98 - 1.94} \right) + \left( 2369 + (2374 - 2369) \cdot \frac{0.98 \cdot 2.0 - 2.0}{1.92 - 2.0} \right) \right)}{2}$$

$$= \frac{2363 + 2371}{2} = 2367 \text{ r/min}$$

\* \* \* \* \*

(c) \* \* \*

(3) *Intermediate speed.* Based on the map, determine maximum torque,  $T_{max}$ , and the corresponding speed,  $f_{nTmax}$ , calculated as the average of the lowest and highest speeds at which torque is equal to 98% of  $T_{max}$ . Use linear interpolation between points to determine the speeds where torque is equal to 98% of  $T_{max}$ . Identify your reference intermediate speed as one of the following values:

(i)  $f_{nTmax}$  if it is between (60 and 75) % of maximum test speed.

(ii) 60% of maximum test speed if  $f_{nTmax}$  is less than 60% of maximum test speed.

(iii) 75% of maximum test speed if  $f_{nTmax}$  is greater than 75% of maximum test speed.

(d) \* \* \*

(3) \* \* \*

(ii) If the cycle begins with a set of contiguous idle points (zero-percent speed, and zero-percent torque), leave the reference torques set to zero for this initial contiguous idle segment. This is to represent free idle operation with the transmission in neutral or park at the

start of the transient duty cycle, after the engine is started. If the initial idle segment is longer than 24 seconds, change the reference torques for the remaining idle points in the initial contiguous idle segment to CITT (i.e., change idle points corresponding to 25 seconds to the end of the initial idle segment to CITT). This is to represent shifting the transmission to drive.

\* \* \* \* \*

■ 302. Section 1065.630 is revised to read as follows:

**§ 1065.630 Local acceleration of gravity.**

(a) The acceleration of Earth's gravity,  $a_g$ , varies depending on the test location. Determine  $a_g$  at your location by entering latitude, longitude, and

elevation data into the U.S. National Oceanographic and Atmospheric Administration's surface gravity prediction Web site at [http://www.ngs.noaa.gov/cgi-bin/grav\\_pdx.prl](http://www.ngs.noaa.gov/cgi-bin/grav_pdx.prl).

(b) If the Web site specified in paragraph (a) of this section is unavailable, you may calculate  $a_g$  for your latitude as follows:

$$a_g = 9.7803267715 \cdot [1 + 5.2790414 \cdot 10^{-3} \cdot \sin^2(\theta) + 2.32718 \cdot 10^{-5} \cdot \sin^4(\theta) + 1.262 \cdot 10^{-7} \cdot \sin^6(\theta) + 7 \cdot 10^{-10} \cdot \sin^8(\theta)]$$

Eq. 1065.630-1

Where:

$\theta$  = Degrees north or south latitude.

*Example:*

$\theta = 45^\circ$

$$a_g = 9.7803267715 \cdot (1 + 5.2790414 \cdot 10^{-3} \cdot \sin^2(45) + 2.32718 \cdot 10^{-5} \cdot \sin^4(45) + 1.262 \cdot 10^{-7} \cdot \sin^6(45) + 7 \cdot 10^{-10} \cdot \sin^8(45))$$

$$a_g = 9.8061992026 \text{ m/s}^2$$

■ 303. Section 1065.640 is revised to read as follows:

**§ 1065.640 Flow meter calibration calculations.**

This section describes the calculations for calibrating various flow

meters. After you calibrate a flow meter using these calculations, use the calculations described in § 1065.642 to calculate flow during an emission test. Paragraph (a) of this section first describes how to convert reference flow meter outputs for use in the calibration equations, which are presented on a molar basis. The remaining paragraphs describe the calibration calculations that are specific to certain types of flow meters.

(a) *Reference meter conversions.* The calibration equations in this section use molar flow rate,  $\dot{n}_{\text{ref}}$ , as a reference

quantity. If your reference meter outputs a flow rate in a different quantity, such as standard volume rate,  $\dot{V}_{\text{stdref}}$ , actual volume rate,  $\dot{V}_{\text{actref}}$ , or mass rate,  $\dot{m}_{\text{ref}}$ , convert your reference meter output to a molar flow rate using the following equations, noting that while values for volume rate, mass rate, pressure, temperature, and molar mass may change during an emission test, you should ensure that they are as constant as practical for each individual set point during a flow meter calibration:

$$\dot{n}_{\text{ref}} = \frac{\dot{V}_{\text{stdref}} \cdot P_{\text{std}}}{T_{\text{std}} \cdot R} = \frac{\dot{V}_{\text{actref}} \cdot P_{\text{act}}}{T_{\text{act}} \cdot R} = \frac{\dot{m}_{\text{ref}}}{M_{\text{mix}}}$$

Eq. 1065.640-1

Where:

$\dot{n}_{\text{ref}}$  = reference molar flow rate.

$\dot{V}_{\text{stdref}}$  = reference volume flow rate, corrected to a standard pressure and a standard temperature.

$\dot{V}_{\text{actref}}$  = reference volume flow rate at the actual pressure and temperature of the flow rate.

$\dot{m}_{\text{ref}}$  = reference mass flow.

$P_{\text{std}}$  = standard pressure.

$P_{\text{act}}$  = actual pressure of the flow rate.

$T_{\text{std}}$  = standard temperature.

$T_{\text{act}}$  = actual temperature of the flow rate.

$R$  = molar gas constant.

$M_{\text{mix}}$  = molar mass of the flow rate.

*Example 1:*

$$\dot{V}_{\text{stdref}} = 1000.00 \text{ ft}^3/\text{min} = 0.471948 \text{ m}^3/\text{s}$$

$$p_{\text{std}} = 29.9213 \text{ in Hg @ } 32 \text{ }^\circ\text{F} = 101.325 \text{ kPa} = 101325 \text{ Pa} = 101325 \text{ kg}/(\text{m}\cdot\text{s}^2)$$

$$T_{\text{std}} = 68.0 \text{ }^\circ\text{F} = 293.15 \text{ K}$$

$$R = 8.314472 \text{ J}/(\text{mol}\cdot\text{K}) = 8.314472 \text{ (m}^2\cdot\text{kg)} / (\text{s}^2\cdot\text{mol}\cdot\text{K})$$

$$\dot{n}_{\text{ref}} = \frac{0.471948 \cdot 101325}{293.15 \cdot 8.314472}$$

$$\dot{n}_{\text{ref}} = 19.619 \text{ mol/s}$$

*Example 2:*

$$\dot{m}_{\text{ref}} = 17.2683 \text{ kg}/\text{min} = 287.805 \text{ g/s}$$

$$M_{\text{mix}} = 28.7805 \text{ g/mol}$$

$$\dot{n}_{\text{ref}} = \frac{287.805}{28.7805}$$

$$\dot{n}_{\text{ref}} = 10.0000 \text{ mol/s}$$

(b) PDP calibration calculations. For each restrictor position, calculate the following values from the mean values determined in § 1065.340, as follows:

(1) PDP volume pumped per revolution,  $V_{\text{rev}}$  ( $\text{m}^3/\text{r}$ ):

$$V_{\text{rev}} = \frac{\bar{\dot{n}}_{\text{ref}} \cdot R \cdot \bar{T}_{\text{in}}}{\bar{P}_{\text{in}} \cdot \bar{f}_{\text{nPDP}}}$$

Eq. 1065.640-2

*Example:*

$$\bar{n}_{\text{ref}} = 25.096 \text{ mol/s}$$

$$R = 8.314472 \text{ J/(mol}\cdot\text{K)} = 8.314472 \text{ (m}^2\cdot\text{kg)/(s}^2\cdot\text{mol}\cdot\text{K)}$$

$$\bar{T}_{\text{in}} = 299.5 \text{ K}$$

$$\bar{p}_{\text{in}} = 98.290 \text{ kPa} = 98290 \text{ Pa} = 98290 \text{ kg/(m}\cdot\text{s}^2)$$

$$\bar{f}_{\text{nPDP}} = 1205.1 \text{ r/min} = 20.085 \text{ r/s}$$

$$V_{\text{rev}} = \frac{25.096 \cdot 8.314472 \cdot 299.5}{98290 \cdot 20.085}$$

$$V_{\text{rev}} = 0.03166 \text{ m}^3/\text{r}$$

(2) PDP slip correction factor,  $K_s$  (s/r):

$$K_s = \frac{1}{\bar{f}_{\text{nPDP}}} \cdot \sqrt{\frac{\bar{p}_{\text{out}} - \bar{p}_{\text{in}}}{\bar{p}_{\text{out}}}}$$

Eq. 1065.640-3

*Example:*

$$\bar{f}_{\text{nPDP}} = 1205.1 \text{ r/min} = 20.085 \text{ r/s}$$

$$\bar{p}_{\text{out}} = 100.103 \text{ kPa}$$

$$\bar{p}_{\text{in}} = 98.290 \text{ kPa}$$

$$K_s = \frac{1}{20.085} \cdot \sqrt{\frac{100.103 - 98.290}{100.103}}$$

$$K_s = 0.006700 \text{ s/r}$$

(3) Perform a least-squares regression of PDP volume pumped per revolution,  $V_{\text{rev}}$ , versus PDP slip correction factor,  $K_s$ , by calculating slope,  $a_1$ , and intercept,  $a_0$ , as described in § 1065.602.

(4) Repeat the procedure in paragraphs (b)(1) through (3) of this section for every speed that you run your PDP.

(5) The following example illustrates these calculations:

TABLE 1 OF § 1065.640—EXAMPLE OF PDP CALIBRATION DATA

$\bar{f}_{\text{nPDP}}$ (revolution/s)	$a_1$ (m <sup>3</sup> /s)	$a_0$ (m <sup>3</sup> /revolution)
12.6 .....	0.841	0.056
16.5 .....	0.831	-0.013
20.9 .....	0.809	0.028
23.4 .....	.788	-0.061

(6) For each speed at which you operate the PDP, use the corresponding slope,  $a_1$ , and intercept,  $a_0$ , to calculate flow rate during emission testing as described in § 1065.642.

(c) *Venturi governing equations and permissible assumptions.* This section describes the governing equations and permissible assumptions for calibrating a venturi and calculating flow using a venturi. Because a subsonic venturi (SSV) and a critical-flow venturi (CFV)

both operate similarly, their governing equations are nearly the same, except for the equation describing their pressure ratio,  $r$  (i.e.,  $r_{SSV}$  versus  $r_{CFV}$ ). These governing equations assume one-dimensional isentropic inviscid compressible flow of an ideal gas. In paragraph (c)(4) of this section, we describe other assumptions that you may make, depending upon how you conduct your emission tests. If we do not allow you to assume that the measured flow is an ideal gas, the governing equations include a first-order correction for the behavior of a real gas; namely, the compressibility factor,  $Z$ . If good engineering judgment dictates using a value other than  $Z=1$ , you may either use an appropriate equation of state to determine values of  $Z$  as a function of measured pressures and temperatures, or you may develop your own calibration equations based on good engineering judgment. Note that the equation for the flow coefficient,  $C_f$ , is based on the ideal gas assumption that the isentropic exponent,  $\gamma$ , is equal to the ratio of specific heats,  $C_p/C_v$ . If good engineering judgment dictates using a real gas isentropic exponent, you may either use an appropriate equation of state to determine values of  $\gamma$  as a function of measured pressures and temperatures, or you may develop your own calibration equations based on good engineering judgment. Calculate molar flow rate, as follows:

$$\dot{n} = C_d \cdot C_f \cdot \frac{A_t \cdot p_{in}}{\sqrt{Z \cdot M_{mix} \cdot R \cdot T_{in}}}$$

Eq. 1065.640-4

Where:

- $C_d$  = discharge coefficient, as determined in paragraph (c)(1) of this section.
- $C_f$  = flow coefficient, as determined in paragraph (c)(2) of this section.
- $A_t$  = venturi throat cross-sectional area.
- $p_{in}$  = venturi inlet absolute static pressure.
- $Z$  = compressibility factor.
- $M_{mix}$  = molar mass of gas mixture.
- $R$  = molar gas constant.
- $T_{in}$  = venturi inlet absolute temperature.

(1) Using the data collected in § 1065.340, calculate  $C_d$  using the following equation:

Example:

- $M_{air}$  = 28.96559 g/mol
- $x_{H_2O}$  = 0.0169 mol/mol
- $M_{H_2O}$  = 18.01528 g/mol

$$C_d = \dot{n}_{ref} \cdot \frac{\sqrt{Z \cdot M_{mix} \cdot R \cdot T_{in}}}{C_f \cdot A_t \cdot p_{in}}$$

Where:

$\dot{n}_{ref}$  = a reference molar flow rate.

(2) Determine  $C_f$  using one of the following methods:

(i) For CFV flow meters only, determine  $C_{fCFV}$  from the following table based on your values for  $\beta$  and  $\gamma$ , using linear interpolation to find intermediate values:

TABLE 2 OF § 1065.640— $C_{fCFV}$  VERSUS  $\beta$  AND  $\gamma$  FOR CFV FLOW METERS

$\beta$	$C_{fCFV}$	
	$\gamma_{exh} = 1.385$	$\gamma_{dexh} = \gamma_{air} = 1.399$
0.000	0.6822	0.6846
0.400	0.6857	0.6881
0.500	0.6910	0.6934
0.550	0.6953	0.6977
0.600	0.7011	0.7036
0.625	0.7047	0.7072
0.650	0.7089	0.7114
0.675	0.7137	0.7163
0.700	0.7193	0.7219
0.720	0.7245	0.7271
0.740	0.7303	0.7329
0.760	0.7368	0.7395
0.770	0.7404	0.7431
0.780	0.7442	0.7470
0.790	0.7483	0.7511
0.800	0.7527	0.7555
0.810	0.7573	0.7602
0.820	0.7624	0.7652
0.830	0.7677	0.7707
0.840	0.7735	0.7765
0.850	0.7798	0.7828

(ii) For any CFV or SSV flow meter, you may use the following equation to calculate  $C_f$ :

$$C_f = \left[ \frac{2 \cdot \gamma \cdot \left( r^{\frac{\gamma-1}{\gamma}} - 1 \right)}{(\gamma-1) \cdot \left( \beta^4 - r^{\frac{-2}{\gamma}} \right)} \right]^{\frac{1}{2}}$$

Eq. 1065.640-6

Where:

$$M_{mix} = M_{air} \cdot (1 - x_{H_2O}) + M_{H_2O} \cdot x_{H_2O}$$

Eq. 1065.640-9

$$M_{mix} = 28.96559 \cdot (1 - 0.0169) + 18.01528 \cdot 0.0169$$

$$M_{mix} = 28.7805 \text{ g/mol}$$

$\gamma$  = isentropic exponent. For an ideal gas, this is the ratio of specific heats of the gas mixture,  $C_p/C_v$ .

$r$  = pressure ratio, as determined in paragraph (c)(3) of this section.

$\beta$  = ratio of venturi throat to inlet diameters.

(3) Calculate  $r$  as follows:

(i) For SSV systems only, calculate  $r_{SSV}$  using the following equation:

$$r_{SSV} = 1 - \frac{\Delta p_{SSV}}{p_{in}}$$

Eq. 1065.640-7

Where:

$\Delta p_{SSV}$  = Differential static pressure; venturi inlet minus venturi throat.

(ii) For CFV systems only, calculate  $r_{CFV}$  iteratively using the following equation:

$$r_{CFV}^{\frac{1-\gamma}{\gamma}} + \left( \frac{\gamma-1}{2} \right) \cdot \beta^4 \cdot r_{CFV}^{\frac{2}{\gamma}} = \frac{\gamma+1}{2}$$

Eq. 1065.640-8

(4) You may make any of the following simplifying assumptions of the governing equations, or you may use good engineering judgment to develop more appropriate values for your testing:

(i) For emission testing over the full ranges of raw exhaust, diluted exhaust and dilution air, you may assume that the gas mixture behaves as an ideal gas:  $Z = 1$ .

(ii) For the full range of raw exhaust you may assume a constant ratio of specific heats of  $\gamma = 1.385$ .

(iii) For the full range of diluted exhaust and air (e.g., calibration air or dilution air), you may assume a constant ratio of specific heats of  $\gamma = 1.399$ .

(iv) For the full range of diluted exhaust and air, you may assume the molar mass of the mixture is a function only of the amount of water in the dilution air or calibration air,  $x_{H_2O}$ , determined as described in § 1065.645, as follows:

(v) For the full range of diluted exhaust and air, you may assume a constant molar mass of the mixture,

$M_{mix}$ , for all calibration and all testing as long as your assumed molar mass differs no more than  $\pm 1\%$  from the estimated minimum and maximum molar mass during calibration and testing. You may assume this, using good engineering judgment, if you sufficiently control the amount of water in calibration air and in dilution air or if you remove sufficient water from both calibration air and dilution air. The following table gives examples of permissible ranges of dilution air dewpoint versus calibration air dewpoint:

TABLE 3 OF § 1065.640—EXAMPLES OF DILUTION AIR AND CALIBRATION AIR DEWPOINTS AT WHICH YOU MAY ASSUME A CONSTANT  $M_{mix}$

If calibration $T_{dew}$ ( $^{\circ}C$ ) is . . . .	assume the following constant $M_{mix}$ (g/mol) . . . .	for the following ranges of $T_{dew}$ ( $^{\circ}C$ ) during emission tests <sup>a</sup>
dry . . . . .	28.96559	dry to 18.
0 . . . . .	28.89263	dry to 21.
5 . . . . .	28.86148	dry to 22.
10 . . . . .	28.81911	dry to 24.
15 . . . . .	28.76224	dry to 26.
20 . . . . .	28.68685	– 8 to 28.
25 . . . . .	28.58806	12 to 31.
30 . . . . .	28.46005	23 to 34.

<sup>a</sup> Range valid for all calibration and emission testing over the atmospheric pressure range (80.000 to 103.325) kPa.

(5) The following example illustrates the use of the governing equations to

calculate the discharge coefficient,  $C_d$  of an SSV flow meter at one reference flow meter value. Note that calculating  $C_d$  for a CFV flow meter would be similar, except that  $C_f$  would be determined from Table 2 of this section or calculated iteratively using values of  $\beta$  and  $\gamma$  as described in paragraph (c)(2) of this section.

*Example:*

$\dot{n}_{ref} = 57.625$  mol/s  
 $Z = 1$   
 $M_{mix} = 28.7805$  g/mol = 0.0287805 kg/mol  
 $R = 8.314472$  J/(mol·K) = 8.314472 (m<sup>2</sup>·kg)/(s<sup>2</sup>·mol·K)  
 $T_{in} = 298.15$  K  
 $A_t = 0.01824$  m<sup>2</sup>  
 $p_{in} = 99.132$  kPa = 99132.0 Pa = 99132 kg/(m·s<sup>2</sup>)  
 $\gamma = 1.399$   
 $\beta = 0.8$   
 $\Delta p = 2.312$  kPa

$$R = 8.314472 \text{ J}/(\text{mol}\cdot\text{K}) = 8.314472 \text{ (m}^2\cdot\text{kg)}/(\text{s}^2\cdot\text{mol}\cdot\text{K})$$

$$T_{in} = 298.15 \text{ K}$$

$$A_t = 0.01824 \text{ m}^2$$

$$p_{in} = 99.132 \text{ kPa} = 99132.0 \text{ Pa} = 99132 \text{ kg}/(\text{m}\cdot\text{s}^2)$$

$$\gamma = 1.399$$

$$\beta = 0.8$$

$$\Delta p = 2.312 \text{ kPa}$$

$$r_{SSV} = 1 - \frac{2.312}{99.132} = 0.977$$

$$C_f = \left[ \frac{2 \cdot 1.399 \cdot \left( 0.977^{\frac{1.399-1}{1.399}} - 1 \right)}{(1.399 - 1) \cdot \left( 0.8^4 - 0.977^{\frac{-2}{1.399}} \right)} \right]^{\frac{1}{2}}$$

$$C_f = 0.274$$

$$C_d = 57.625 \cdot \frac{\sqrt{1 \cdot 0.0287805 \cdot 8.314472 \cdot 298.15}}{0.274 \cdot 0.01824 \cdot 99132.0}$$

$$C_d = 0.982$$

(d) *SSV calibration.* Perform the following steps to calibrate an SSV flow meter:

(1) Calculate the Reynolds number,  $Re^{\#}$ , for each reference molar flow rate,  $\dot{n}_{ref}$ , using the throat diameter of the

venturi,  $d_t$ . Because the dynamic viscosity,  $\mu$ , is needed to compute  $Re^{\#}$ , you may use your own fluid viscosity model to determine  $\mu$  for your calibration gas (usually air), using good

engineering judgment. Alternatively, you may use the Sutherland three-coefficient viscosity model to approximate  $\mu$ , as shown in the following sample calculation for  $Re^{\#}$ :

$$Re^{\#} = \frac{4 \cdot M_{mix} \cdot \dot{n}_{ref}}{\pi \cdot d_t \cdot \mu}$$

Eq. 1065.640-10

Where, using the Sutherland three-coefficient viscosity model:

$$\mu = \mu_0 \cdot \left(\frac{T_{in}}{T_0}\right)^{\frac{3}{2}} \cdot \left(\frac{T_0 + S}{T_{in} + S}\right)$$

Eq. 1065.640-11

Where:

$\mu_0$  = Sutherland reference viscosity.

$T_0$  = Sutherland reference temperature.

$S$  = Sutherland constant.

TABLE 4 OF § 1065.640—SUTHERLAND THREE-COEFFICIENT VISCOSITY MODEL PARAMETERS

Gas <sup>a</sup>	$\mu_0$ kg/(m·s)	$T_0$ K	$S$ K	Temp range within ±2% error <sup>b</sup> K	Pressure limit <sup>b</sup> kPa
Air .....	$1.716 \cdot 10^{-5}$	273	111	170 to 1900	≤1800
CO <sub>2</sub> .....	$1.370 \cdot 10^{-5}$	273	222	190 to 1700	≤3600
H <sub>2</sub> O .....	$1.12 \cdot 10^{-5}$	350	1064	360 to 1500	≤10000
O <sub>2</sub> .....	$1.919 \cdot 10^{-5}$	273	139	190 to 2000	≤2500
N <sub>2</sub> .....	$1.663 \cdot 10^{-5}$	273	107	100 to 1500	≤1600

<sup>a</sup> Use tabulated parameters only for the pure gases, as listed. Do not combine parameters in calculations to calculate viscosities of gas mixtures.

<sup>b</sup> The model results are valid only for ambient conditions in the specified ranges.

Example:

$$\mu_0 = 1.716 \cdot 10^{-5} \text{ kg/(m·s)}$$



$$T_0 = 273 \text{ K}$$

$$S = 111 \text{ K}$$

$$\mu = 1.716 \cdot 10^{-5} \cdot \left( \frac{298.15}{273} \right)^{\frac{3}{2}} \cdot \left( \frac{273 + 111}{298.15 + 111} \right)$$

$$\mu = 1.838 \cdot 10^{-5} \text{ kg/(m}\cdot\text{s)}$$

$$M_{\text{mix}} = 28.7805 \text{ g/mol}$$

$$\dot{n}_{\text{ref}} = 57.625 \text{ mol/s}$$

$$d_t = 152.4 \text{ mm} = 0.1524 \text{ m}$$

$$T_{\text{in}} = 298.15 \text{ K}$$

$$Re^{\#} = \frac{4 \cdot 28.7805 \cdot 57.625}{3.14159 \cdot 0.1524 \cdot 1.838 \cdot 10^{-5}}$$

$$Re^{\#} = 7.538 \cdot 10^8$$

(2) Create an equation for  $C_d$  as a function of  $Re^{\#}$ , using paired values of the two quantities. The equation may involve any mathematical expression, including a polynomial or a power series. The following equation is an example of a commonly used mathematical expression for relating  $C_d$  and  $Re^{\#}$ :

$$C_d = a_0 - a_1 \cdot \sqrt{\frac{10^6}{Re^{\#}}}$$

Eq. 1065.640-12

(3) Perform a least-squares regression analysis to determine the best-fit coefficients for the equation and calculate the equation's regression statistic, *SEE*, according to § 1065.602.

(4) If the equation meets the criterion of  $SEE \leq 0.5\% \cdot C_{d\text{max}}$ , you may use the equation to determine  $C_d$  for emission tests, as described in § 1065.642.

(5) If the equation does not meet the specified statistical criterion, you may use good engineering judgment to omit

calibration data points; however you must use at least seven calibration data points to demonstrate that you meet the statistical criterion. This will usually involve narrowing the range of flow rates for a better curve fit.

(6) Take corrective action if the equation does not meet the specified statistical criterion even after omitting calibration data points. For example, select another mathematical expression for the  $C_d$  versus  $Re^{\#}$  equation, check for

leaks, or repeat the calibration process. If you must repeat the process, we recommend applying tighter tolerances to measurements and allowing more time for flows to stabilize.

(7) Once you have an equation that meets the specified statistical criterion, you may use the equation only for the corresponding range of  $Re^{\#}$ .

(e) *CFV calibration*. Some CFV flow meters consist of a single venturi and some consist of multiple venturis,

where different combinations of venturis are used to meter different flow rates. For CFV flow meters that consist of multiple venturis, either calibrate each venturi independently to determine a separate discharge coefficient,  $C_d$ , for each venturi, or calibrate each combination of venturis as one venturi. In the case where you calibrate a combination of venturis, use the sum of the active venturi throat areas as  $A_t$ , the square root of the sum of the squares of the active venturi throat diameters as  $d_t$ , and the ratio of the venturi throat to inlet diameters as the ratio of the square root of the sum of the active venturi throat diameters ( $d_t$ ) to the diameter of the common entrance to all the venturis. (D). To determine the  $C_d$  for a single venturi or a single combination of venturis, perform the following steps:

(1) Use the data collected at each calibration set point to calculate an individual  $C_d$  for each point using Eq. 1065.640-4.

(2) Calculate the mean and standard deviation of all the  $C_d$  values according to Eqs. 1065.602-1 and 1065.602-2.

(3) If the standard deviation of all the  $C_d$  values is less than or equal to 0.3% of the mean  $C_d$ , use the mean  $C_d$  in Eq. 1065.642-4, and use the CFV only up to the highest  $r$  measured during calibration using the following equation:

$$r = 1 - \frac{\Delta p_{\text{CFV}}}{P_{\text{in}}}$$

#### Eq. 1065.640-13

Where:

$\Delta p_{\text{CFV}}$  = Differential static pressure; venturi inlet minus venturi outlet.

(4) If the standard deviation of all the  $C_d$  values exceeds 0.3% of the mean  $C_d$ , omit the  $C_d$  value corresponding to the data point collected at the highest  $r$  measured during calibration.

(5) If the number of remaining data points is less than seven, take corrective action by checking your calibration data or repeating the calibration process. If you repeat the calibration process, we recommend checking for leaks, applying tighter tolerances to measurements and allowing more time for flows to stabilize.

(6) If the number of remaining  $C_d$  values is seven or greater, recalculate the mean and standard deviation of the remaining  $C_d$  values.

(7) If the standard deviation of the remaining  $C_d$  values is less than or equal to 0.3% of the mean of the remaining  $C_d$ , use that mean  $C_d$  in Eq. 1065.642-4, and use the CFV values only up to the highest  $r$  associated with the remaining  $C_d$ .

(8) If the standard deviation of the remaining  $C_d$  still exceeds 0.3% of the mean of the remaining  $C_d$  values, repeat

the steps in paragraph (e)(4) through (8) of this section.

■ 304. Section 1065.642 is revised to read as follows:

#### § 1065.642 SSV, CFV, and PDP molar flow rate calculations.

This section describes the equations for calculating molar flow rates from various flow meters. After you calibrate a flow meter according to § 1065.640, use the calculations described in this section to calculate flow during an emission test.

(a) *PDP molar flow rate*. Based upon the speed at which you operate the PDP for a test interval, select the corresponding slope,  $a_1$ , and intercept,  $a_0$ , as calculated in § 1065.640, to calculate molar flow rate,  $\dot{n}$  as follows:

$$\dot{n} = f_{\text{nPDP}} \cdot \frac{P_{\text{in}} \cdot V_{\text{rev}}}{R \cdot T_{\text{in}}}$$

#### Eq. 1065.642-1

Where:

$$V_{\text{rev}} = \frac{a_1}{f_{\text{nPDP}}} \cdot \sqrt{\frac{p_{\text{out}} - p_{\text{in}}}{p_{\text{out}}}} + a_0$$

#### Eq. 1065.642-2

*Example:*

$$a_1 = 0.8405 \text{ (m}^3\text{/s)}$$

$$f_{n\text{PDP}} = 12.58 \text{ r/s}$$

$$p_{\text{out}} = 99.950 \text{ kPa}$$

$$p_{\text{in}} = 98.575 \text{ kPa} = 98575 \text{ Pa} = 98575 \text{ kg}/(\text{m}\cdot\text{s}^2)$$

$$a_0 = 0.056 \text{ (m}^3\text{/r)}$$

$$R = 8.314472 \text{ J}/(\text{mol}\cdot\text{K}) = 8.314472 \text{ (m}^2\cdot\text{kg)}\text{}/(\text{s}^2\cdot\text{mol}\cdot\text{K})$$

$$T_{\text{in}} = 323.5 \text{ K}$$

$$V_{\text{rev}} = \frac{0.8405}{12.58} \cdot \sqrt{\frac{99.950 - 98.575}{99.950}} + 0.056$$

$$V_{\text{rev}} = 0.06383 \text{ m}^3\text{/r}$$

$$\dot{n} = 12.58 \cdot \frac{98575 \cdot 0.06383}{8.314472 \cdot 323.5}$$

$$\dot{n} = 29.428 \text{ mol/s}$$

(b) SSV molar flow rate. Based on the  $C_d$  versus  $Re^\#$  equation you determined according to § 1065.640, calculate SSV molar flow rate,  $\dot{n}$  during an emission test as follows:

$$\dot{n} = C_d \cdot C_f \cdot \frac{A_t \cdot p_{\text{in}}}{\sqrt{Z \cdot M_{\text{mix}} \cdot R \cdot T_{\text{in}}}}$$

Eq. 1065.642-3

*Example:*

$$A_t = 0.01824 \text{ m}^2$$

$$p_{\text{in}} = 99.132 \text{ kPa} = 99132 \text{ Pa} = 99132 \text{ kg}/(\text{m}\cdot\text{s}^2)$$

$$Z = 1$$

$$M_{\text{mix}} = 28.7805 \text{ g/mol} = 0.0287805 \text{ kg/mol}$$

$$R = 8.314472 \text{ J}/(\text{mol}\cdot\text{K}) = 8.314472 \text{ (m}^2\cdot\text{kg)}\text{}/(\text{s}^2\cdot\text{mol}\cdot\text{K})$$

$$T_{\text{in}} = 298.15 \text{ K}$$

$$Re^\# = 7.232 \cdot 10^5$$

$$\gamma = 1.399$$

$$\beta = 0.8$$

$$\Delta p = 2.312 \text{ kPa}$$

Using Eq. 1065.640-7,

$$r_{\text{ssv}} = 0.997$$

Using Eq. 1065.640-6,

$$C_f = 0.274$$

Using Eq. 1065.640-5,

$$C_d = 0.990$$

$$\dot{n} = 0.990 \cdot 0.274 \cdot \frac{0.01824 \cdot 99132}{\sqrt{1 \cdot 0.0287805 \cdot 8.314472 \cdot 298.15}}$$

$$\dot{n} = 58.173 \text{ mol/s}$$

(c) *CFV molar flow rate.* Some CFV flow meters consist of a single venturi and some consist of multiple venturis, where different combinations of venturis are used to meter different flow rates. If you use multiple venturis and you calibrated each venturi independently to determine a separate discharge coefficient,  $C_d$  (or calibration coefficient,  $K_v$ ), for each venturi, calculate the individual molar flow rates

through each venturi and sum all their flow rates to determine  $\dot{n}$ . If you use multiple venturis and you calibrated each combination of venturis, calculate  $\dot{n}$  using the sum of the active venturi throat areas as  $A_t$ , the square root of the sum of the squares of the active venturi throat diameters as  $d_t$ , and the ratio of the venturi throat to inlet diameters as the ratio of the square root of the sum of the active venturi throat diameters

( $d_i$ ) to the diameter of the common entrance to all the venturis ( $D$ ).

(1) To calculate the molar flow rate through one venturi or one combination of venturis, use its respective mean  $C_d$  and other constants you determined according to § 1065.640 and calculate its molar flow rate  $\dot{n}$  during an emission test, as follows:

$$\dot{n} = C_d \cdot C_f \cdot \frac{A_t \cdot P_{in}}{\sqrt{Z \cdot M_{mix} \cdot R \cdot T_{in}}}$$

Eq. 1065.642-4

*Example:*

$$C_d = 0.985$$

$$C_f = 0.7219$$

$$A_t = 0.00456 \text{ m}^2$$

$$P_{in} = 98.836 \text{ kPa} = 98836 \text{ Pa} = 98836 \text{ kg}/(\text{m} \cdot \text{s}^2)$$

$$Z = 1$$

$$M_{mix} = 28.7805 \text{ g/mol} = 0.0287805 \text{ kg/mol}$$

$$R = 8.314472 \text{ J}/(\text{mol} \cdot \text{K}) = 8.314472 \text{ (m}^2 \cdot \text{kg)} / (\text{s}^2 \cdot \text{mol} \cdot \text{K})$$

$$T_{in} = 378.15 \text{ K}$$

$$\dot{n} = 0.985 \cdot 0.7219 \cdot \frac{0.00456 \cdot 98836}{\sqrt{1 \cdot 0.0287805 \cdot 8.314472 \cdot 378.15}}$$

$$\dot{n} = 33.690 \text{ mol/s}$$

(2) To calculate the molar flow rate through one venturi or a combination of venturis, you may use its respective

mean,  $K_v$ , and other constants you determined according to § 1065.640 and calculate its molar flow rate during an

emission test. Note that if you follow the permissible ranges of dilution air dewpoint versus calibration air

dewpoint in Table 3 of § 1065.640, you may set  $M_{\text{mix-cal}}$  and  $M_{\text{mix}}$  equal to 1. Calculate  $\dot{n}$  as follows:

$$\dot{n} = \frac{K_v \cdot P_{\text{in}}}{\sqrt{T_{\text{in}}}} \cdot \frac{P_{\text{std}}}{T_{\text{std}} \cdot R} \cdot \frac{\sqrt{M_{\text{mix-cal}}}}{\sqrt{M_{\text{mix}}}}$$

Eq. 1065.642-5

Where:

$$K_v = \frac{V_{\text{stdref}} \cdot \sqrt{T_{\text{in-cal}}}}{P_{\text{in-cal}}}$$

Eq. 1065.642-6

$V_{\text{stdref}}$  = volume flow rate of the standard at reference conditions of 293.15 K and 101.325 kPa.

$T_{\text{in-cal}}$  = venturi inlet temperature during calibration.

$P_{\text{in-cal}}$  = venturi inlet pressure during calibration.

$M_{\text{mix-cal}}$  = molar mass of gas mixture used during calibration.

$M_{\text{mix}}$  = molar mass of gas mixture during the emission test calculated using Equation 1065.640-9.

Example:

$V_{\text{stdref}} = 0.4895 \text{ m}^3$

$T_{\text{in-cal}} = 302.52 \text{ K}$

$P_{\text{in-cal}} = 99.654 \text{ kPa} = 99654 \text{ Pa} = 99654 \text{ kg/}$   
(m·s<sup>2</sup>)

$P_{\text{in}} = 98.836 \text{ kPa} = 98836 \text{ Pa} = 98836 \text{ kg/}$   
(m·s<sup>2</sup>)

$P_{\text{std}} = 101.325 \text{ kPa} = 101325 \text{ Pa} = 101325 \text{ kg/}$   
(m·s<sup>2</sup>)

$M_{\text{mix-cal}} = 28.9656 \text{ g/mol} = 0.0289656 \text{ kg/mol}$

$M_{\text{mix}} = 28.7805 \text{ g/mol} = 0.0287805 \text{ kg/mol}$

$T_{\text{in}} = 353.15 \text{ K}$

$T_{\text{std}} = 293.15 \text{ K}$

$R = 8.314472 \text{ J/(mol·K)} = 8.314472 \text{ (m}^2\cdot\text{kg)/}$   
(s<sup>2</sup>·mol·K)

$$R = 8.314472 \text{ J/(mol·K)} = 8.314472 \text{ (m}^2\cdot\text{kg)/(s}^2\cdot\text{mol·K)}$$

$$K_v = \frac{0.4895 \cdot \sqrt{302.52}}{99654} = 0.000074954 \text{ m}^4 \cdot \text{s} \cdot \text{K}^{0.5} / \text{kg}$$

$$\dot{n} = \frac{0.000074954 \cdot 98936}{\sqrt{353.15}} \cdot \frac{101325}{293.15 \cdot 8.314472} \cdot \frac{\sqrt{0.0289656}}{\sqrt{0.0287805}}$$

$$\dot{n} = 16.457 \text{ mol/s}$$

■ 305. Section 1065.644 is revised to read as follows:

**§ 1065.644 Vacuum-decay leak rate.**

This section describes how to calculate the leak rate of a vacuum-decay leak verification, which is described in § 1065.345(e). Use the following equation to calculate the leak rate  $\dot{n}_{\text{leak}}$ , and compare it to the criterion specified in § 1065.345(e):

$$\dot{n}_{\text{leak}} = \frac{V_{\text{vac}}}{R} \cdot \frac{\left( \frac{p_2}{T_2} - \frac{p_1}{T_1} \right)}{(t_2 - t_1)}$$

Eq. 1065.644-1

Where:

$V_{\text{vac}}$  = geometric volume of the vacuum-side of the sampling system.

$R$  = molar gas constant.

$p_2$  = vacuum-side absolute pressure at time  $t_2$ .

$T_2$  = vacuum-side absolute temperature at time  $t_2$ .

$p_1$  = vacuum-side absolute pressure at time  $t_1$ .

$T_1$  = vacuum-side absolute temperature at time  $t_1$ .

$t_2$  = time at completion of vacuum-decay leak verification test.

$t_1$  = time at start of vacuum-decay leak verification test.

Example:

$V_{\text{vac}} = 2.0000 \text{ L} = 0.00200 \text{ m}^3$

$R = 8.314472 \text{ J/(mol·K)} = 8.314472 \text{ (m}^2\cdot\text{kg)/}$   
(s<sup>2</sup>·mol·K)

$p_2 = 50.600 \text{ kPa} = 50600 \text{ Pa} = 50600 \text{ kg/(m·s}^2)$

$T_2 = 293.15 \text{ K}$

$p_1 = 25.300 \text{ kPa} = 25300 \text{ Pa} = 25300 \text{ kg/(m·s}^2)$

$T_1 = 293.15 \text{ K}$

$t_2 = 10:57:35 \text{ a.m.}$

$t_1 = 10:56:25 \text{ a.m.}$

$$\dot{n}_{\text{leak}} = \frac{0.0002}{8.314472} \cdot \frac{\left( \frac{50600}{293.15} - \frac{25300}{293.15} \right)}{(10:57:35 - 10:56:25)}$$

$$\dot{n}_{\text{leak}} = \frac{0.00200}{8.314472} \cdot \frac{86.304}{70}$$

$$\dot{n}_{\text{leak}} = 0.00030 \text{ mol/s}$$

■ 306. Section 1065.645 is amended by revising the introductory text and paragraph (a) and adding paragraph (d) to read as follows:

**§ 1065.645 Amount of water in an ideal gas.**

This section describes how to determine the amount of water in an ideal gas, which you need for various performance verifications and emission

calculations. Use the equation for the vapor pressure of water in paragraph (a) of this section or another appropriate equation and, depending on whether you measure dewpoint or relative humidity, perform one of the calculations in paragraph (b) or (c) of this section. Paragraph (d) of this section provides an equation for determining dewpoint from relative humidity and dry bulb temperature measurements. The equations for the vapor pressure of water as presented in this section are derived from equations in “Saturation Pressure of Water on the New Kelvin Temperature Scale” (Goff, J.A., Transactions American Society of Heating and Air-Conditioning Engineers, Vol. 63, No. 1607, pages 347–

354). Note that the equations were originally published to derive vapor pressure in units of atmospheres and have been modified to derive results in units of kPa by converting the last term in each equation.

(a) *Vapor pressure of water.* Calculate the vapor pressure of water for a given saturation temperature condition,  $T_{\text{sat}}$ , as follows, or use good engineering judgment to use a different relationship of the vapor pressure of water to a given saturation temperature condition:

(1) For humidity measurements made at ambient temperatures from (0 to 100) °C, or for humidity measurements made over super-cooled water at ambient temperatures from (–50 to 0) °C, use the following equation:

$$\log_{10}(p_{\text{H}_2\text{O}}) = 10.79574 \cdot \left(1 - \frac{273.16}{T_{\text{sat}}}\right) - 5.02800 \cdot \log_{10}\left(\frac{T_{\text{sat}}}{273.16}\right) + 1.50475 \cdot 10^{-4} \cdot \left(1 - 10^{-8.2969 \cdot \left(\frac{T_{\text{sat}}}{273.16} - 1\right)}\right) \\ + 0.42873 \cdot 10^{-3} \cdot \left(10^{4.76955 \cdot \left(1 - \frac{273.16}{T_{\text{sat}}}\right)} - 1\right) - 0.2138602$$

Eq. 1065.645-1

Where:

$p_{\text{H}_2\text{O}}$  = vapor pressure of water at saturation temperature condition, kPa.

$T_{\text{sat}}$  = saturation temperature of water at measured conditions, K.

*Example:*

$$T_{\text{sat}} = 9.5 \text{ }^\circ\text{C} = 282.65 \text{ K}$$

$$\log_{10}(p_{\text{H}_2\text{O}}) = 10.79574 \cdot \left(1 - \frac{273.16}{282.65}\right) - 5.02800 \cdot \log_{10}\left(\frac{282.65}{273.16}\right) + 1.50475 \cdot 10^{-4} \cdot \left(1 - 10^{-8.2969 \cdot \left(\frac{282.65}{273.16} - 1\right)}\right) \\ + 0.42873 \cdot 10^{-3} \cdot \left(10^{4.76955 \cdot \left(1 - \frac{273.16}{282.65}\right)} - 1\right) - 0.2138602$$

$$\log_{10}(p_{\text{H}_2\text{O}}) = 0.074297$$

$$p_{\text{H}_2\text{O}} = 10^{0.074297} = 1.186581 \text{ kPa}$$

(2) For humidity measurements over ice at ambient temperatures from (−100 to 0) °C, use the following equation:

$$\log_{10}(p_{\text{H}_2\text{O}}) = -9.096853 \cdot \left( \frac{273.16}{T_{\text{sat}}} - 1 \right) - 3.566506 \cdot \log_{10} \left( \frac{273.16}{T_{\text{sat}}} \right) \\ + 0.876812 \cdot \left( 1 - \frac{T_{\text{sat}}}{273.16} \right) - 0.2138602$$

Eq. 1065.645-2

*Example:*

$$T_{\text{ice}} = -15.4 \text{ }^\circ\text{C} = 257.75 \text{ K}$$

$$\log_{10}(p_{\text{H}_2\text{O}}) = -9.096853 \cdot \left( \frac{273.16}{257.75} - 1 \right) - 3.566506 \cdot \log_{10} \left( \frac{273.16}{257.75} \right) \\ + 0.876812 \cdot \left( 1 - \frac{257.75}{273.16} \right) - 0.2138602$$

$$\log_{10}(p_{\text{H}_2\text{O}}) = -0.798207$$

$$p_{\text{H}_2\text{O}} = 10^{-0.79821} = 0.159145 \text{ kPa}$$

\* \* \* \* \*

(d) *Dewpoint determination from relative humidity and dry bulb temperature.* This paragraph (d) describes how to calculate dewpoint temperature from relative humidity, *RH%*. This is based on "ITS-90

Formulations for Vapor Pressure, Frostpoint Temperature, Dewpoint Temperature, and Enhancement Factors in the Range -100 to +100 °C" (Hardy, B., The Proceedings of the Third International Symposium on Humidity & Moisture, Teddington, London,

England, April 1998). Calculate  $p_{\text{H}_2\text{Osat}}$  as described in paragraph (a) of this section based on setting  $T_{\text{sat}}$  equal to  $T_{\text{amb}}$ . Calculate  $p_{\text{H}_2\text{Oscaled}}$  by multiplying  $p_{\text{H}_2\text{Osat}}$  by *RH%*. Calculate the dewpoint,  $T_{\text{dew}}$ , from  $p_{\text{H}_2\text{O}}$  using the following equation:

$$T_{\text{dew}} = \frac{2.0798233 \cdot 10^2 - 2.0156028 \cdot 10^1 \cdot \ln(p_{\text{H}_2\text{O}}) + 4.6778925 \cdot 10^{-1} \cdot \ln(p_{\text{H}_2\text{O}})^2 - 9.2288067 \cdot 10^{-6} \cdot \ln(p_{\text{H}_2\text{O}})^3}{1 - 1.3319669 \cdot 10^{-1} \cdot \ln(p_{\text{H}_2\text{O}}) + 5.6577518 \cdot 10^{-3} \cdot \ln(p_{\text{H}_2\text{O}})^2 - 7.5172865 \cdot 10^{-5} \cdot \ln(p_{\text{H}_2\text{O}})^3}$$

Eq. 1065.645-5

Where:

$\ln(p_{\text{H}_2\text{O}})$  = the natural log of  $p_{\text{H}_2\text{Oscaled}}$ , which is the water vapor pressure scaled to the relative humidity at the location of the

relative humidity measurement,  $T_{\text{sat}} = T_{\text{amb}}$ .



Example:

$$RH \% = 39.61 \%$$

$$T_{\text{sat}} = T_{\text{amb}} = 20.00 \text{ }^\circ\text{C} = 293.15\text{K}$$

Using Eq. 1065.645-1,

$$p_{\text{H}_2\text{O}_{\text{sat}}} = 2.3371 \text{ kPa}$$

$$p_{\text{H}_2\text{O}_{\text{scaled}}} = (39.61 \% \cdot 2.3371) = 0.925717 \text{ kPa} = 925.717 \text{ Pa}$$

$$T_{\text{dew}} = \frac{2.0798233 \cdot 10^2 - 2.0156028 \cdot 10^1 \cdot \ln(925.717) + 4.6778925 \cdot 10^{-1} \cdot \ln(925.717)^2 - 9.2288067 \cdot 10^{-6} \cdot \ln(925.717)^3}{1 - 1.3319669 \cdot 10^{-1} \cdot \ln(925.717) + 5.6577518 \cdot 10^{-3} \cdot \ln(925.717)^2 - 7.5172865 \cdot 10^{-5} \cdot \ln(925.717)^3}$$

$$T_{\text{dew}} = 279.00 \text{ K} = 5.85 \text{ }^\circ\text{C}$$

■ 307. Section 1065.650 is amended by revising paragraphs (c)(1)(i), (c)(1)(ii), and (f)(4) to read as follows:

**§ 1065.650 Emission calculations.**

\* \* \* \* \*

(c) \* \* \*  
(1) \* \* \*

(i) Correct all gaseous emission analyzer concentration readings, including continuous readings, sample bag readings, and dilution air background readings, for drift as described in § 1065.672. Note that you must omit this step where brake-specific emissions are calculated without the drift correction for performing the drift

validation according to § 1065.550(b). When applying the initial THC and CH<sub>4</sub> contamination readings according to § 1065.520(f), use the same values for both sets of calculations. You may also use as-measured values in the initial set of calculations and corrected values in the drift-corrected set of calculations as described in § 1065.520(g)(7).

(ii) Correct all THC and CH<sub>4</sub> concentrations for initial contamination as described in § 1065.660(a), including continuous readings, sample bags readings, and dilution air background readings.

\* \* \* \* \*

(f) \* \* \*

(4) Example. The following example shows how to calculate mass of emissions using proportional values:

- N = 3000
- f<sub>record</sub> = 5 Hz
- e<sub>fuel</sub> = 285 g/(kW·hr)
- w<sub>fuel</sub> = 0.869 g/g
- M<sub>c</sub> = 12.0107 g/mol
- $\tilde{n}_1 = 3.922 \text{ mol/s} = 14119.2 \text{ mol/hr}$
- $\chi_{\text{Ccombdry1}} = 91.634 \text{ mmol/mol} = 0.091634 \text{ mol/mol}$
- $\chi_{\text{H}_2\text{Oexh1}} = 27.21 \text{ mmol/mol} = 0.02721 \text{ mol/mol}$
- Using Eq. 1065.650–5,
- $\Delta t = 0.2 \text{ s}$

$$\tilde{W} = \frac{12.0107 \left( \frac{3.922 \cdot 0.091634}{1 + 0.02721} + \frac{\tilde{n}_2 \cdot \chi_{\text{Ccombdry2}}}{1 + \chi_{\text{H}_2\text{Oexh2}}} + \dots + \frac{\tilde{n}_{3000} \cdot \chi_{\text{Ccombdry3000}}}{1 + \chi_{\text{H}_2\text{Oexh3000}}} \right) \cdot 0.2}{285 \cdot 0.869}$$

$$\tilde{W} = 5.09 \text{ (kW·hr)}$$

$$\tilde{W} = 5.09 \text{ (kW·hr)}$$

\* \* \* \* \*

■ 308. Section 1065.655 is amended by revising paragraphs (c) introductory text, (c)(3), (d), (e), and (f)(2) to read as follows:

**§ 1065.655 Chemical balances of fuel, intake air, and exhaust.**

\* \* \* \* \*

(c) Chemical balance procedure. The calculations for a chemical balance involve a system of equations that require iteration. We recommend using a computer to solve this system of equations. You must guess the initial

values of up to three quantities: The amount of water in the measured flow,  $\chi_{\text{H}_2\text{Oexh}}$ , fraction of dilution air in diluted exhaust,  $x_{\text{dil/exh}}$ , and the amount of products on a C<sub>1</sub> basis per dry mole of dry measured flow,  $\chi_{\text{Ccombdry}}$ . You may use time-weighted mean values of combustion air humidity and dilution air humidity in the chemical balance; as long as your combustion air and dilution air humidities remain within tolerances of  $\pm 0.0025 \text{ mol/mol}$  of their respective mean values over the test interval. For each emission concentration,  $\chi$ , and amount of water,  $\chi_{\text{H}_2\text{Oexh}}$ , you must determine their

completely dry concentrations,  $\chi_{\text{dry}}$  and  $\chi_{\text{H}_2\text{Oexhdry}}$ . You must also use your fuel's atomic hydrogen-to-carbon ratio,  $\alpha$ , oxygen-to-carbon ratio,  $\beta$ , sulfur-to-carbon ratio,  $\gamma$ , and nitrogen-to-carbon ratio,  $\delta$ . You may calculate  $\alpha$ ,  $\beta$ ,  $\gamma$ , and  $\delta$  based on measured fuel composition as described in paragraph (d)(1) or (d)(2) of this section, or you may use default values for a given fuel as described in paragraph (d)(3) of this section. Use the following steps to complete a chemical balance:

\* \* \* \* \*

(3) Use the following symbols and subscripts in the equations for this paragraph (c):

$\chi_{\text{dil/exh}}$  = amount of dilution gas or excess air per mole of exhaust.

$\chi_{\text{H}_2\text{Oexh}}$  = amount of H<sub>2</sub>O in exhaust per mole of exhaust.

$\chi_{\text{Ccombdry}}$  = amount of carbon from fuel in the exhaust per mole of dry exhaust.

$\chi_{\text{H}_2\text{dry}}$  = amount of H<sub>2</sub> in exhaust per amount of dry exhaust.

$K_{\text{H}_2\text{Ogas}}$  = water-gas reaction equilibrium coefficient. You may use 3.5 or calculate your own value using good engineering judgment.

$\chi_{\text{H}_2\text{Oexhdry}}$  = amount of H<sub>2</sub>O in exhaust per dry mole of dry exhaust.

$\chi_{\text{prod/intdry}}$  = amount of dry stoichiometric products per dry mole of intake air.

$\chi_{\text{dil/exhdry}}$  = amount of dilution gas and/or excess air per mole of dry exhaust.

$\chi_{\text{int/exhdry}}$  = amount of intake air required to produce actual combustion products per mole of dry (raw or diluted) exhaust.

$\chi_{\text{raw/exhdry}}$  = amount of undiluted exhaust, without excess air, per mole of dry (raw or diluted) exhaust.

$\chi_{\text{O}_2\text{int}}$  = amount of intake air O<sub>2</sub> per mole of intake air.

$\chi_{\text{CO}_2\text{intdry}}$  = amount of intake air CO<sub>2</sub> per mole of dry intake air. You may use  $\chi_{\text{CO}_2\text{intdry}}$

= 375  $\mu\text{mol/mol}$ , but we recommend measuring the actual concentration in the intake air.

$\chi_{\text{H}_2\text{Ointdry}}$  = amount of intake air H<sub>2</sub>O per mole of dry intake air.

$\chi_{\text{CO}_2\text{int}}$  = amount of intake air CO<sub>2</sub> per mole of intake air.

$\chi_{\text{CO}_2\text{dil}}$  = amount of dilution gas CO<sub>2</sub> per mole of dilution gas.

$\chi_{\text{CO}_2\text{dildry}}$  = amount of dilution gas CO<sub>2</sub> per mole of dry dilution gas. If you use air as diluent, you may use  $\chi_{\text{CO}_2\text{dildry}} = 375 \mu\text{mol/mol}$ , but we recommend measuring the actual concentration in the intake air.

$\chi_{\text{H}_2\text{Odildry}}$  = amount of dilution gas H<sub>2</sub>O per mole of dry dilution gas.

$\chi_{\text{H}_2\text{Odil}}$  = amount of dilution gas H<sub>2</sub>O per mole of dilution gas.

$\chi_{\text{[emission]meas}}$  = amount of measured emission in the sample at the respective gas analyzer.

$\chi_{\text{[emission]dry}}$  = amount of emission per dry mole of dry sample.

$\chi_{\text{H}_2\text{O[emission]meas}}$  = amount of H<sub>2</sub>O in sample at emission-detection location. Measure or estimate these values according to § 1065.145(e)(2).

$\chi_{\text{H}_2\text{Oint}}$  = amount of H<sub>2</sub>O in the intake air, based on a humidity measurement of intake air.

$\alpha$  = atomic hydrogen-to-carbon ratio of the mixture of fuel(s) being combusted, weighted by molar consumption.

$\beta$  = atomic oxygen-to-carbon ratio of the mixture of fuel(s) being combusted, weighted by molar consumption.

$\gamma$  = atomic sulfur-to-carbon ratio of the mixture of fuel(s) being combusted, weighted by molar consumption.

$\delta$  = atomic nitrogen-to-carbon ratio of the mixture of fuel(s) being combusted, weighted by molar consumption.

\* \* \* \* \*

(d) *Carbon mass fraction and fuel composition.* Determine carbon mass fraction of fuel,  $w_c$ , and fuel composition represented by  $\alpha$ ,  $\beta$ ,  $\gamma$ , and  $\delta$  using one of the following methods:

(1) You may calculate  $w_c$  as described in this paragraph (d)(1) based on measured fuel properties. To do so, you must determine values for  $\alpha$  and  $\beta$  in all cases, but you may set  $\gamma$  and  $\delta$  to zero if the default value listed in Table 1 of this section is zero. Calculate  $w_c$  using the following equation:

$$w_c = \frac{1 \cdot M_C}{1 \cdot M_C + \alpha \cdot M_H + \beta \cdot M_O + \gamma \cdot M_S + \delta \cdot M_N}$$

Eq. 1065.655-19

Where:

$w_c$  = carbon mass fraction of fuel.

$M_C$  = molar mass of carbon.

$\alpha$  = atomic hydrogen-to-carbon ratio of the mixture of fuel(s) being combusted, weighted by molar consumption.

$M_H$  = molar mass of hydrogen.

$\beta$  = atomic oxygen-to-carbon ratio of the mixture of fuel(s) being combusted, weighted by molar consumption.

$M_O$  = molar mass of oxygen.

$\gamma$  = atomic sulfur-to-carbon ratio of the mixture of fuel(s) being combusted, weighted by molar consumption.

$M_S$  = molar mass of sulfur.

$\delta$  = atomic nitrogen-to-carbon ratio of the mixture of fuel(s) being combusted, weighted by molar consumption.

$M_N$  = molar mass of nitrogen.

*Example:*

$$\alpha = 1.8$$

$$\beta = 0.05$$

$$\gamma = 0.0003$$

$$\delta = 0.0001$$

$$M_C = 12.0107$$

$$M_H = 1.00794$$

$$M_O = 15.9994$$

$$M_S = 32.065$$

$$M_N = 14.0067$$

$$w_c = \frac{1 \cdot 12.0107}{1 \cdot 12.0107 + 1.8 \cdot 1.00794 + 0.05 \cdot 15.9994 + 0.0003 \cdot 32.065 + 0.0001 \cdot 14.0067}$$

$$w_c = 0.8206$$

(2) Determine a fuel's elemental mass fractions and values for  $\alpha$ ,  $\beta$ ,  $\gamma$ , and  $\delta$  as follows:

(i) For gaseous fuels, use the default values for  $\alpha$ ,  $\beta$ ,  $\gamma$ , and  $\delta$  in Table 1 of this section or use good engineering judgment to determine those values based on measurement.

(ii) Determine mass fractions of liquid fuels as follows:

(A) You may determine the carbon and hydrogen mass fractions according to ASTM D5291 (incorporated by reference in § 1065.1010). When using

ASTM D5291 to determine carbon and hydrogen mass fractions of gasoline (with or without blended ethanol), use good engineering judgment to adapt the method as appropriate.

(B) Determine oxygen mass fraction of gasoline (with or without blended ethanol) according to ASTM D5599 (incorporated by reference in § 1065.1010). For all other liquid fuels, determine the oxygen mass fraction using good engineering judgment.

(C) Determine the nitrogen mass fraction according to ASTM D4629 or

ASTM D5762 (incorporated by reference in § 1065.1010) for all liquid fuels. Select the correct method based on the expected nitrogen content.

(D) Determine the sulfur mass fraction according to subpart H of this part.

(iii) For liquid fuels, use the default values for  $\alpha$ ,  $\beta$ ,  $\gamma$ , and  $\delta$  in Table 1 of this section, or you may determine the value for any of these parameters based on measurement. Calculate these values using the following equations:

$$\alpha = \frac{w_H \cdot M_C}{w_C \cdot M_H}$$

Eq. 1065.655-20

$$\beta = \frac{w_O \cdot M_C}{w_C \cdot M_O}$$

Eq. 1065.655-21

Where:

$w_C$  = carbon mass fraction of fuel.

$w_H$  = hydrogen mass fraction of fuel.

$w_O$  = oxygen mass fraction of fuel.

$w_S$  = sulfur mass fraction of fuel.

$w_N$  = nitrogen mass fraction of fuel.

$$\gamma = \frac{w_S \cdot M_C}{w_C \cdot M_S}$$

Eq. 1065.655-22

$$\delta = \frac{w_N \cdot M_C}{w_C \cdot M_N}$$

Eq. 1065.655-23

Where:

$w_C$  = carbon mass fraction of fuel.

$w_H$  = hydrogen mass fraction of fuel.

$w_O$  = oxygen mass fraction of fuel.

$w_S$  = sulfur mass fraction of fuel.

$w_N$  = nitrogen mass fraction of fuel.

*Example:*

$w_C = 0.8206$

$w_H = 0.1239$

$w_O = 0.0547$

$w_S = 0.00066$

$w_N = 0.000095$

$M_C = 12.0107$

$M_H = 1.00794$

$M_O = 15.9994$

$$M_S = 32.065$$

$$M_N = 14.0067$$

$$\alpha = \frac{0.1239 \cdot 12.0107}{0.8206 \cdot 1.00794}$$

$$\beta = \frac{0.0547 \cdot 12.0107}{0.8206 \cdot 15.9994}$$

$$\gamma = \frac{0.00066 \cdot 12.0107}{0.8206 \cdot 32.065}$$

$$\delta = \frac{0.000095 \cdot 12.0107}{0.8206 \cdot 14.0067}$$

$$\alpha = 1.8$$

$$\beta = 0.05$$

$$\gamma = 0.0003$$

$$\delta = 0.0001$$

TABLE 1 OF § 1065.655—DEFAULT VALUES OF  $\alpha$ ,  $\beta$ ,  $\gamma$ ,  $\delta$ , AND  $w_c$ , FOR VARIOUS FUELS

Fuel	Atomic hydrogen, oxygen, sulfur, and nitrogen-to-carbon ratios $CH_\alpha O_\beta S_\gamma N_\delta$	Carbon mass fraction, $w_c$ g/g
Gasoline .....	$CH_{1.85}O_0S_0N_0$ .....	0.866
E10 Gasoline .....	$CH_{1.92}O_{0.03}S_0N_0$ .....	0.833
E15 Gasoline .....	$CH_{1.95}O_{0.05}S_0N_0$ .....	0.817
E85 Gasoline .....	$CH_{2.73}O_{0.38}S_0N_0$ .....	0.576
#1 Diesel .....	$CH_{1.93}O_0S_0N_0$ .....	0.861
#2 Diesel .....	$CH_{1.80}O_0S_0N_0$ .....	0.869
Liquefied petroleum gas .....	$CH_{2.64}O_0S_0N_0$ .....	0.819
Natural gas .....	$CH_{3.78}O_{0.016}S_0N_0$ .....	0.747
E100 Ethanol .....	$CH_3O_{0.5}S_0N_0$ .....	0.521
M100 Methanol .....	$CH_4O_1S_0N_0$ .....	0.375
Residual fuel blends .....	Must be determined by measured fuel properties as described in paragraph (d)(1) of this section.	

(e) *Calculated raw exhaust molar flow rate from measured intake air molar flow rate or fuel mass flow rate.* You may calculate the raw exhaust molar flow rate from which you sampled emissions,  $\dot{n}_{\text{exh}}$ , based on the measured intake air molar flow rate,  $\dot{n}_{\text{int}}$ , or the measured fuel mass flow rate,  $\dot{m}_{\text{fuel}}$ , and the values calculated using the chemical balance in paragraph (c) of this section. The chemical balance must be based on raw exhaust gas concentrations. Solve for the chemical balance in paragraph (c) of this section at the same frequency

that you update and record or  $\dot{n}_{\text{int}}$  or  $\dot{m}_{\text{fuel}}$ . For laboratory tests, calculating raw exhaust molar flow rate using measured fuel mass flow rate is valid only for steady-state testing. See § 1065.915(d)(5)(iv) for application to field testing.

(1) *Crankcase flow rate.* If engines are not subject to crankcase controls under the standard-setting part, you may calculate raw exhaust flow based on  $\dot{n}_{\text{int}}$  or  $\dot{m}_{\text{fuel}}$  using one of the following:

(i) You may measure flow rate through the crankcase vent and subtract it from the calculated exhaust flow.

(ii) You may estimate flow rate through the crankcase vent by engineering analysis as long as the uncertainty in your calculation does not adversely affect your ability to show that your engines comply with applicable emission standards.

(iii) You may assume your crankcase vent flow rate is zero.

(2) Intake air molar flow rate calculation. Calculate  $\dot{n}_{\text{exh}}$  based on  $\dot{n}_{\text{int}}$  using the following equation:

$$\dot{n}_{\text{exh}} = \frac{\dot{n}_{\text{int}}}{\left(1 + \frac{(x_{\text{int/exhdry}} - x_{\text{raw/exhdry}})}{(1 + x_{\text{H}_2\text{Oexhdry}})}\right)}$$

Eq. 1065.655-24

$$\dot{n}_{\text{exh}} = \frac{3.780}{\left(1 + \frac{(0.69021 - 1.10764)}{(1 + 0.10764)}\right)}$$

$$\dot{n}_{\text{exh}} = 6.066 \text{ mol/s}$$

Where:

$\dot{n}_{\text{exh}}$  = raw exhaust molar flow rate from which you measured emissions.  
 $\dot{n}_{\text{int}}$  = intake air molar flow rate including humidity in intake air.

Example:

$\dot{n}_{\text{int}} = 3.780 \text{ mol/s}$   
 $x_{\text{int/exhdry}} = 0.69021 \text{ mol/mol}$   
 $x_{\text{raw/exhdry}} = 1.10764 \text{ mol/mol}$   
 $x_{\text{H}_2\text{Oexhdry}} = 107.64 \text{ mmol/mol} = 0.10764 \text{ mol/mol}$

(3) Fuel mass flow rate calculation. This calculation may be used only for steady-state laboratory testing. See § 1065.915(d)(5)(iv) for application to field testing. Calculate

$\dot{n}_{\text{exh}}$  based on  $\dot{m}_{\text{fuel}}$  using the following equation:

$$\dot{n}_{\text{exh}} = \frac{\dot{m}_{\text{fuel}} \cdot w_c \cdot (1 + x_{\text{H}_2\text{Oexhdry}})}{M_c \cdot x_{\text{Ccombdry}}}$$

Eq. 1065.655-25

Where:

$\dot{n}_{\text{exh}}$  = raw exhaust molar flow rate from which you measured emissions.  
 $\dot{m}_{\text{fuel}}$  = fuel mass flow rate.

Example:

$\dot{m}_{\text{fuel}} = 7.559 \text{ g/s}$   
 $w_c = 0.869 \text{ g/g}$   
 $M_c = 12.0107 \text{ g/mol}$

$x_{\text{Ccombdry}} = 99.87 \text{ mmol/mol} = 0.09987 \text{ mol/mol}$

$x_{\text{H}_2\text{Oexhdry}} = 107.64 \text{ mmol/mol} = 0.10764 \text{ mol/mol}$

$$\dot{n}_{\text{exh}} = \frac{7.559 \cdot 0.869 \cdot (1 + 0.10764)}{12.0107 \cdot 0.09987}$$

$\dot{n}_{\text{exh}} = 6.066 \text{ mol/s}$

(f) \* \* \*

(2) Dilute exhaust and intake air molar flow rate calculation. Calculate  $\dot{n}_{\text{exh}}$  as follows:

$$\dot{n}_{\text{exh}} = (x_{\text{raw/exhdry}} - x_{\text{int/exhdry}}) \cdot (1 - x_{\text{H}_2\text{Oexh}}) \cdot \dot{n}_{\text{dexh}} + \dot{n}_{\text{int}}$$

Eq. 1065.655-26

Example:

$\dot{n}_{\text{int}} = 7.930 \text{ mol/s}$   
 $x_{\text{raw/exhdry}} = 0.1544 \text{ mol/mol}$   
 $x_{\text{int/exhdry}} = 0.1451 \text{ mol/mol}$   
 $x_{\text{H}_2\text{O/exh}} = 32.46 \text{ mmol/mol} = 0.03246 \text{ mol/mol}$   
 $\dot{n}_{\text{dexh}} = 49.02 \text{ mol/s}$   
 $\dot{n}_{\text{exh}} = (0.1544 - 0.1451) \cdot (1 - 0.03246) \cdot 49.02 + 7.930 = 0.4411 + 7.930 = 8.371 \text{ mol/s}$

■ 309. Section 1065.659 is amended by revising paragraphs (a) and (d) to read as follows:

**§ 1065.659 Removed water correction.**

(a) If you remove water upstream of a concentration measurement,  $x$ , correct for the removed water. Perform this correction based on the amount of water

at the concentration measurement,  $x_{\text{H}_2\text{O}[\text{emission}]_{\text{meas}}}$ , and at the flow meter,  $x_{\text{H}_2\text{Oexh}}$ , whose flow is used to determine the mass emission rate or total mass over a test interval. For continuous analyzers downstream of a sample dryer for transient and ramped-modal cycles, you must apply this correction on a continuous basis over the test interval,

even if you use one of the options in § 1065.145(e)(2) that results in a constant value for  $x_{\text{H}_2\text{O}[\text{emission}]_{\text{meas}}}$  because  $x_{\text{H}_2\text{O}_{\text{exh}}}$  varies over the test interval. For batch analyzers, determine the flow-weighted average based on the continuous  $x_{\text{H}_2\text{O}_{\text{exh}}}$  values determined as

described in paragraph (c) of this section. For batch analyzers, you may determine the flow-weighted average  $x_{\text{H}_2\text{O}_{\text{exh}}}$  based on a single value of  $x_{\text{H}_2\text{O}_{\text{exh}}}$  determined as described in paragraphs (c)(2) and (3) of this section,

using flow-weighted average or batch concentration inputs.

\* \* \* \* \*

(d) Perform a removed water correction to the concentration measurement using the following equation:

$$x = x_{[\text{emission}]_{\text{meas}}} \cdot \left( \frac{1 - x_{\text{H}_2\text{O}_{\text{exh}}}}{1 - x_{\text{H}_2\text{O}[\text{emission}]_{\text{meas}}}} \right)$$

Eq. 1065.659-1

*Example:*

$$x_{\text{CO}_{\text{meas}}} = 29.0 \text{ } \mu\text{mol/mol}$$

$$x_{\text{H}_2\text{O}_{\text{CO}_{\text{meas}}}} = 8.601 \text{ mmol/mol} = 0.008601 \text{ mol/mol}$$

$$x_{\text{H}_2\text{O}_{\text{exh}}} = 34.04 \text{ mmol/mol} = 0.03404 \text{ mol/mol}$$

$$x_{\text{CO}} = 29.0 \cdot \left( \frac{1 - 0.03404}{1 - 0.008601} \right)$$

$$x_{\text{CO}} = 28.3 \text{ } \mu\text{mol/mol}$$

■ 310. Section 1065.665 is revised to read as follows:

**§ 1065.665 THCE and NMHCE determination.**

(a) If you measured an oxygenated hydrocarbon's mass concentration, first calculate its molar concentration in the

exhaust sample stream from which the sample was taken (raw or diluted exhaust), and convert this into a C<sub>1</sub>-equivalent molar concentration. Add these C<sub>1</sub>-equivalent molar concentrations to the molar concentration of non-oxygenated total hydrocarbon (NOTHC). The result is the

molar concentration of total hydrocarbon equivalent (THCE). Calculate THCE concentration using the following equations, noting that Eq. 1065.665-3 is required only if you need to convert your oxygenated hydrocarbon (OHC) concentration from mass to moles:

$$x_{\text{THCE}} = x_{\text{NOTHC}} + \sum_{i=1}^N (x_{\text{OHC}_i} - x_{\text{OHC}_i\text{-init}})$$

Eq. 1065.665-1

$$x_{\text{NOTHC}} = x_{\text{THC}[\text{THC-FID}]_{\text{cor}}} - \sum_{i=1}^N ((x_{\text{OHC}_i} - x_{\text{OHC}_i\text{-init}}) \cdot RF_{\text{OHC}_i[\text{THC-FID}]})$$

Eq. 1065.665-2

$$x_{\text{OHC}_i} = \frac{\frac{m_{\text{dexhOHC}_i}}{M_{\text{OHC}_i}}}{\frac{m_{\text{dexh}}}{M_{\text{dexh}}}} = \frac{n_{\text{dexhOHC}_i}}{n_{\text{dexh}}}$$

Eq. 1065.665-3

Where:

$x_{\text{THCE}}$  = The sum of the C<sub>1</sub>-equivalent concentrations of non-oxygenated hydrocarbons, alcohols, and aldehydes.

$x_{\text{NOTHC}}$  = The sum of the C<sub>1</sub>-equivalent concentrations of NOTHC.

$x_{\text{OHC}_i}$  = The C<sub>1</sub>-equivalent concentration of oxygenated species *i* in diluted exhaust, not corrected for initial contamination.

$x_{\text{OHC}_i\text{-init}}$  = The C<sub>1</sub>-equivalent concentration of the initial system contamination (optional) of oxygenated species *i*, dry-to-wet corrected.

$x_{\text{THC}[\text{THC-FID}]_{\text{cor}}}$  = The C<sub>1</sub>-equivalent response to NOTHC and all OHC in diluted exhaust, HC contamination and dry-to-wet corrected, as measured by the THC-FID.

$RF_{\text{OHC}_i[\text{THC-FID}]}$  = The response factor of the FID to species *i* relative to propane on a C<sub>1</sub>-equivalent basis.

*C* = the mean number of carbon atoms in the particular compound.

$M_{\text{dexh}}$  = The molar mass of diluted exhaust as determined in § 1065.340.

$m_{\text{dexhOHC}_i}$  = The mass of oxygenated species *i* in dilute exhaust.

$M_{\text{OHC}_i}$  = The C<sub>1</sub>-equivalent molecular weight of oxygenated species *i*.

$m_{\text{dexh}}$  = The mass of diluted exhaust.

$n_{\text{dexhOHC}_i}$  = The number of moles of oxygenated species *i* in total diluted exhaust flow.

$n_{\text{dexh}}$  = The total diluted exhaust flow.

(b) If we require you to determine nonmethane hydrocarbon equivalent (NMHCE), use the following equation:

$$x_{\text{NMHCE}} = x_{\text{THCE}} - RF_{\text{CH}_4[\text{THC-FID}]} \cdot x_{\text{CH}_4}$$

Eq. 1065.665-4

Where:

$x_{\text{NMHCE}}$  = The sum of the C<sub>1</sub>-equivalent concentrations of nonoxygenated nonmethane hydrocarbon (NONMHC), alcohols, and aldehydes.

$RF_{\text{CH}_4[\text{THC-FID}]}$  = response factor of THC-FID to CH<sub>4</sub>.

$x_{\text{CH}_4}$  = concentration of CH<sub>4</sub>, HC contamination (optional) and dry-to-wet corrected, as measured by the gas chromatograph FID.

(c) The following example shows how to determine NMHCE emissions based on ethanol (C<sub>2</sub>H<sub>5</sub>OH), methanol (CH<sub>3</sub>OH), acetaldehyde (C<sub>2</sub>H<sub>4</sub>O), and formaldehyde (CH<sub>2</sub>O) as C<sub>1</sub>-equivalent molar concentrations:

$$x_{\text{THC}[\text{THC-FID}]_{\text{cor}}} = 145.6 \text{ } \mu\text{mol/mol}$$

$$x_{\text{CH}_4} = 18.9 \text{ } \mu\text{mol/mol}$$

$$x_{\text{C}_2\text{H}_5\text{OH}} = 100.8 \text{ } \mu\text{mol/mol}$$

$$x_{\text{CH}_3\text{OH}} = 1.1 \text{ } \mu\text{mol/mol}$$

$$x_{\text{C}_2\text{H}_4\text{O}} = 19.1 \text{ } \mu\text{mol/mol}$$

$$x_{\text{CH}_2\text{O}} = 1.3 \text{ } \mu\text{mol/mol}$$

$$RF_{\text{CH}_4[\text{THC-FID}]} = 1.07$$

$$RF_{\text{C}_2\text{H}_5\text{OH}[\text{THC-FID}]} = 0.76$$

$$RF_{\text{CH}_3\text{OH}[\text{THC-FID}]} = 0.74$$

$$RF_{\text{H}_2\text{H}_4\text{O}[\text{THC-FID}]} = 0.50$$

$$RF_{\text{CH}_2\text{O}[\text{THC-FID}]} = 0.0$$

$$x_{\text{NMHCE}} = x_{\text{THC}[\text{THC-FID}]_{\text{cor}}} - (x_{\text{C}_2\text{H}_5\text{OH}} \cdot$$

$$RF_{\text{C}_2\text{H}_5\text{OH}[\text{THC-FID}]} + x_{\text{CH}_3\text{OH}} \cdot$$

$$RF_{\text{CH}_3\text{OH}[\text{THC-FID}]} + x_{\text{C}_2\text{H}_4\text{O}} \cdot$$

$$RF_{\text{C}_2\text{H}_4\text{O}[\text{THC-FID}]} + x_{\text{CH}_2\text{O}} \cdot$$

$$RF_{\text{CH}_2\text{O}[\text{THC-FID}]} + x_{\text{C}_2\text{H}_5\text{OH}} + x_{\text{CH}_3\text{OH}} +$$

$$x_{\text{C}_2\text{H}_4\text{O}} + x_{\text{CH}_2\text{O}} - (RF_{\text{CH}_4[\text{THC-FID}]} \cdot x_{\text{CH}_4})$$

$$x_{\text{NMHCE}} = 145.6 - (100.8 \cdot 0.76 + 1.1 \cdot 0.74 + 19.1 \cdot 0.50 + 1.3 \cdot 0) + 100.8 + 1.1 + 19.1 + 1.3 - (1.07 \cdot 18.9)$$

$$x_{\text{NMHCE}} = 160.71 \text{ } \mu\text{mol/mol}$$

■ 311. Section 1065.690 is amended by revising paragraph (e) to read as follows:

**§ 1065.690 Buoyancy correction for PM sample media.**

\* \* \* \* \*

(e) *Correction calculation.* Correct the PM sample media for buoyancy using the following equations:

$$m_{\text{cor}} = m_{\text{uncor}} \cdot \left( \frac{1 - \frac{\rho_{\text{air}}}{\rho_{\text{weight}}}}{1 - \frac{\rho_{\text{air}}}{\rho_{\text{media}}}} \right)$$

Eq. 1065.690-1

Where:

$m_{\text{cor}}$  = PM mass corrected for buoyancy.

$m_{\text{uncor}}$  = PM mass uncorrected for buoyancy.

$\rho_{\text{air}}$  = density of air in balance environment.

$\rho_{\text{weight}}$  = density of calibration weight used to span balance.

$\rho_{\text{media}}$  = density of PM sample media, such as a filter.

$$\rho_{\text{air}} = \frac{p_{\text{abs}} \cdot M_{\text{mix}}}{R \cdot T_{\text{amb}}}$$

Eq. 1065.690-2

Where:

$p_{\text{abs}}$  = absolute pressure in balance environment.

$M_{\text{mix}}$  = molar mass of air in balance environment.

$R$  = molar gas constant.

$T_{\text{amb}}$  = absolute ambient temperature of balance environment.



Example:

$$p_{\text{abs}} = 99.980 \text{ kPa}$$

$$T_{\text{sat}} = T_{\text{dew}} = 9.5 \text{ }^\circ\text{C}$$

Using Eq. 1065.645-1,

$$p_{\text{H}_2\text{O}} = 1.1866 \text{ kPa}$$

Using Eq. 1065.645-3,

$$x_{\text{H}_2\text{O}} = 0.011868 \text{ mol/mol}$$

Using Eq. 1065.640-9,

$$M_{\text{mix}} = 28.83563 \text{ g/mol}$$

$$R = 8.314472 \text{ J/(mol}\cdot\text{K)}$$

$$T_{\text{amb}} = 20 \text{ }^\circ\text{C}$$

$$\rho_{\text{air}} = \frac{99.980 \cdot 28.83563}{8.314472 \cdot 293.15}$$

$$\rho_{\text{air}} = 1.18282 \text{ kg/m}^3$$

$$m_{\text{uncorr}} = 100.0000 \text{ mg}$$

$$\rho_{\text{weight}} = 8000 \text{ kg/m}^3$$

$$\rho_{\text{media}} = 920 \text{ kg/m}^3$$

$$m_{\text{cor}} = 100.0000 \cdot \left( \frac{1 - \frac{1.18282}{8000}}{1 - \frac{1.18282}{920}} \right)$$

$$m_{\text{cor}} = 100.1139 \text{ mg}$$

■ 312. Section 1065.695 is amended by revising paragraph (c)(4)(i) and adding paragraph (c)(6)(x) to read as follows:

**§ 1065.695 Data requirements.**

- \* \* \* \*
- (c) \* \* \*
- (4) \* \* \*
- (i) Linearity verification.
- \* \* \* \*
- (6) \* \* \*
- (x) Number and type of preconditioning cycles.
- \* \* \* \*

**Subpart H—[Amended]**

■ 313. Section 1065.701 is amended by revising paragraphs (a), (d), and (f) to read as follows:

**§ 1065.701 General requirements for test fuels.**

(a) *General.* For all emission measurements, use test fuels that meet the specifications in this subpart, unless the standard-setting part directs otherwise. Section 1065.10(c)(1) does not apply with respect to test fuels. Note that the standard-setting parts generally require that you design your emission controls to function properly when using commercially available fuels, even if they differ from the test fuel. Where we specify multiple grades of a certain fuel type (such as diesel fuel with different sulfur concentrations), see the

standard-setting part to determine which grade to use.

\* \* \* \*

(d) *Fuel specifications.* Specifications in this section apply as follows:

(1) Measure and calculate values as described in the appropriate reference procedure. Record and report final values expressed to at least the same number of decimal places as the applicable limit value. The right-most digit for each limit value is significant unless specified otherwise. For example, for a specified distillation temperature of 60 °C, determine the test fuel's value to at least the nearest whole number.

(2) The fuel parameters specified in this subpart depend on measurement procedures that are incorporated by reference. For any of these procedures, you may instead rely upon the procedures identified in 40 CFR part 80 for measuring the same parameter. For example, we may identify different reference procedures for measuring gasoline parameters in 40 CFR 80.46.

\* \* \* \*

(f) *Service accumulation and field testing fuels.* If we do not specify a service-accumulation or field-testing fuel in the standard-setting part, use an appropriate commercially available fuel such as those meeting minimum specifications from the following table:

TABLE 1 OF § 1065.701—EXAMPLES OF SERVICE-ACCUMULATION AND FIELD-TESTING FUELS

Fuel category	Subcategory	Reference procedure <sup>1</sup>
Diesel	Light distillate and light blends with residual	ASTM D975
	Middle distillate	ASTM D6985
	Biodiesel (B100)	ASTM D6751
Intermediate and residual fuel	All	See § 1065.705
Gasoline	Automotive gasoline	ASTM D4814
	Automotive gasoline with ethanol concentration up to 10 volume %..	ASTM D4814
Alcohol	Ethanol (E51–83)	ASTM D5798
	Methanol (M70–M85)	ASTM D5797
Aviation fuel	Aviation gasoline	ASTM D910
	Gas turbine	ASTM D1655
Gas turbine fuel	Jet B wide cut	ASTM D6615
	General	ASTM D2880

<sup>1</sup> ASTM specifications are incorporated by reference in § 1065.1010.

■ 314. Section 1065.703 is amended by revising paragraph (b), transferring Table 1 from paragraph (c) to paragraph

(b), and revising Table 1 to read as follows:

**§ 1065.703 Distillate diesel fuel.**

\* \* \* \*

(b) There are three grades of #2 diesel fuel specified for use as a test fuel. See the standard-setting part to determine which grade to use. If the standard-

setting part does not specify which grade to use, use good engineering judgment to select the grade that represents the fuel on which the engines

will operate in use. The three grades are specified in the following table:

TABLE 1 OF § 1065.703—TEST FUEL SPECIFICATIONS FOR DISTILLATE DIESEL FUEL

Property	Unit	Ultra low sulfur	Low sulfur	High sulfur	Reference procedure <sup>1</sup>
Cetane Number .....	— .....	40–50	40–50	40–50	ASTM D613.
Distillation range:					
Initial boiling point .....	°C .....	171–204	171–204	171–204	ASTM D86.
10 pct. point .....	.....	204–238	204–238	204–238	ASTM D86.
50 pct. point .....	.....	243–282	243–282	243–282	ASTM D86.
90 pct. point .....	.....	293–332	293–332	293–332	ASTM D86.
Endpoint .....	.....	321–366	321–366	321–366	ASTM D86.
Gravity .....	°API .....	32–37	32–37	32–37	ASTM D4052.
Total sulfur, ultra low sulfur .....	mg/kg .....	7–15	.....	.....	See 40 CFR 80.580.
Total sulfur, low and high sulfur .....	mg/kg .....	.....	300–500	800–2500	ASTM D2622 or alternatives as allowed under 40 CFR 80.580.
Aromatics, min. (Remainder shall be paraffins, naphthenes, and olefins).	g/kg .....	100	100	100	ASTM D5186.
Flashpoint, min. ....	°C .....	54	54	54	ASTM D93.
Kinematic Viscosity .....	cSt .....	2.0–3.2	2.0–3.2	2.0–3.2	ASTM D445.

<sup>1</sup> ASTM procedures are incorporated by reference in § 1065.1010. See § 1065.701(d) for other allowed procedures.

\* \* \* \* \*

■ 315. Section 1065.705 is revised to read as follows:

**§ 1065.705 Residual and intermediate residual fuel.**

This section describes the specifications for fuels meeting the definition of residual fuel in 40 CFR 80.2, including fuels marketed as intermediate fuel. Residual fuels for service accumulation and any testing must meet the following specifications:

(a) The fuel must be a commercially available fuel that is representative of the fuel that will be used by the engine in actual use.

(b) The fuel must be free of used lubricating oil. Demonstrate this by showing that the fuel meets at least one of the following specifications.

(1) Zinc is at or below 15 mg per kg of fuel based on the procedures specified in IP470, IP501, or ISO 8217 (incorporated by reference in § 1065.1010).

(2) Phosphorus is at or below 15 mg per kg of fuel based on the procedures specified in IP500, IP501, or ISO 8217 (incorporated by reference in § 1065.1010).

(3) Calcium is at or below 30 mg per kg of fuel based on the procedures specified in IP470, IP501, or ISO 8217 (incorporated by reference in § 1065.1010).

(c) The fuel must meet the specifications for one of the categories in the following table:

TABLE 1 OF § 1065.705—SERVICE ACCUMULATION AND TEST FUEL SPECIFICATIONS FOR RESIDUAL FUEL

Property	Unit	Category ISO-F–									Reference Procedure <sup>1</sup>
		RMA 30	RMB 30	RMD 80	RME 180	RMF 180	RMG 380	RMH 380	RMK 380	RMH 700	
Density at 15 °C, max.	kg/m <sup>3</sup> .....	960.0	975.0	980.0	991.0	991.0	991.0	1010.0	991.0	1010.0	ISO 3675 or ISO 12185 (see also ISO 8217).
Kinematic viscosity at 50 °C, max.	cSt .....	30.0	30.0	80.0	180.0	180.0	380.0	380.0	700.0	700.0	ISO 3104.
Flash point, min.	°C .....	60	60	60	60	60	60	60	60	60	ISO 2719 (see also ISO 8217).
Pour point (upper):	°C .....	0	24	30	30	30	30	30	30	30	ISO 3016.

TABLE 1 OF § 1065.705—SERVICE ACCUMULATION AND TEST FUEL SPECIFICATIONS FOR RESIDUAL FUEL—Continued

Property	Unit	Category ISO-F-										Reference Procedure <sup>1</sup>
		RMA 30	RMB 30	RMD 80	RME 180	RMF 180	RMG 380	RMH 380	RMK 380	RMH 700	RMK 700	
Carbon residue, max.	(kg/kg) % ..	10	14	15	20	18	22	22				ISO 10370.
Ash, max .....	(kg/kg) % ..	0.10	0.10	0.10	0.15	0.15		0.15				ISO 6245.
Water, max ....	(m <sup>3</sup> /m <sup>3</sup> ) %	0.5	0.5	0.5		0.5		0.5				ISO 3733.
Sulfur, max ....	(kg/kg) % ..	3.50	4.00	4.50		4.50		4.50				ISO 8754 or ISO 14596 (see also ISO 8217).
Vanadium, max.	mg/kg .....	150	350	200	500	300	600		600			ISO 14597 or IP 501 or IP 470 (see also ISO 8217).
Total sediment potential, max.	(kg/kg) % ..	0.10	0.10	0.10		0.10		0.10				ISO 10307-2 (see also ISO 8217).
Aluminum plus silicon, max.	mg/kg .....	80	80	80		80		80				ISO 10478 or IP 501 or IP 470 (see also ISO 8217:2012).

<sup>1</sup> ISO procedures are incorporated by reference in § 1065.1010. See § 1065.701(d) for other allowed procedures.

■ 316. Section 1065.710 is revised to read as follows:

**§ 1065.710 Gasoline.**

(a) This section specifies test fuel properties for gasoline with ethanol (low-level blend only) and for gasoline without ethanol. Note that the “fuel type” for the fuels specified in paragraphs (b) and (c) of this section is considered to be gasoline. In contrast, fuels with higher ethanol concentrations, such as fuel containing 82 percent ethanol, are considered to be ethanol fuels rather than gasoline. We specify some test fuel parameters that apply uniquely for low-temperature

testing and for testing at altitudes above 1,219 m. For all other testing, use the test fuel parameters specified for general testing. Unless the standard-setting part specifies otherwise, use the fuel specified in paragraph (c) of this section for general testing.

(b) The following specifications apply for a blended gasoline test fuel that has nominally 10% ethanol (commonly called E10 test fuel):

(1) Prepare the blended test fuel from typical refinery gasoline blending components. You may not use pure compounds, except as follows:

(i) You may use neat ethanol as a blendstock.

(ii) You may adjust the test fuel’s vapor pressure by adding butane.

(iii) You may adjust the test fuel’s benzene content by adding benzene.

(iv) You may adjust the test fuel’s sulfur content by adding sulfur compounds that are representative of those found with in-use fuels.

(2) Table 1 of this section identifies limit values consistent with the units in the reference procedure for each fuel property. These values are generally specified in international units. Values presented in parentheses are for information only. Table 1 follows:

TABLE 1 OF § 1065.710—TEST FUEL SPECIFICATIONS FOR A LOW-LEVEL ETHANOL-GASOLINE BLEND

Property	Unit	Specification			Reference procedure <sup>1</sup>
		General testing	Low-temperature testing	High altitude testing	
Antiknock Index (R+M)/2 .....	.....	87.0—88.4 <sup>2</sup>		87.0 Minimum.	ASTM D2699 and D2700.
Sensitivity (R-M) .....	.....	7.5 Minimum			ASTM D2699 and D2700.
Dry Vapor Pressure Equivalent (DVPE) <sup>3,4</sup> ...	kPa (psi) .....	60.0–63.4 ... (8.7–9.2) .....	77.2–81.4 ... (11.2–11.8) .....	52.4–55.2 ... (7.6–8.0) .....	ASTM D5191.
Distillation <sup>4</sup> .....	°C (°F) .....	49–60 .....	43–54 .....	49–60 .....	ASTM D86.
10% evaporated .....		(120–140) ...	(110–130) ...	(120–140)	

TABLE 1 OF § 1065.710—TEST FUEL SPECIFICATIONS FOR A LOW-LEVEL ETHANOL-GASOLINE BLEND—Continued

Property	Unit	Specification			Reference procedure <sup>1</sup>
		General testing	Low-temperature testing	High altitude testing	
50% evaporated .....	°C (°F) .....		88–99 (190–210).		ASTM D5769.
90% evaporated .....	°C (°F) .....		157–168 (315–335).		
Evaporated final boiling point .....	°C (°F) .....		193–216 (380–420).		
Residue .....	milliliter .....		2.0 Maximum.		
Total Aromatic Hydrocarbons .....	volume % .....		21.0–25.0		
C6 Aromatics (benzene) .....	volume % .....		0.5–0.7.		
C7 Aromatics (toluene) .....	volume % .....		5.2–6.4.		
C8 Aromatics .....	volume % .....		5.2–6.4.		
C9 Aromatics .....	volume % .....		5.2–6.4.		
C10+ Aromatics .....	volume % .....		4.4–5.6.		
Olefins <sup>5</sup> .....	mass % .....		4.0–10.0		ASTM D6550.
Ethanol blended .....	volume % .....		9.6–10.0		See paragraph (b)(3) of this section.
Ethanol confirmatory <sup>6</sup> .....	volume % .....		9.4–10.2		ASTM D4815 or D5599.
Total Content of Oxygenates Other than Ethanol <sup>6</sup> .	volume % .....		0.1 Maximum		ASTM D4815 or D5599.
Sulfur .....	mg/kg .....		8.0–11.0		ASTM D2622, D5453 or D7039.
Lead .....	g/liter .....		0.0026 Maximum		ASTM D3237.
Phosphorus .....	g/liter .....		0.0013 Maximum		ASTM D3231.
Copper Corrosion .....			No. 1 Maximum		ASTM D130.
Solvent-Washed Gum Content .....	mg/100 milliliter .....		3.0 Maximum		ASTM D381.
Oxidation Stability .....	minute .....		1000 Minimum		ASTM D525.

<sup>1</sup> ASTM procedures are incorporated by reference in § 1065.1010. See § 1065.701(d) for other allowed procedures.

<sup>2</sup> Octane specifications apply only for testing related to exhaust emissions. For engines or vehicles that require the use of premium fuel, as described in paragraph (d) of this section, the adjusted specification for antiknock index is a minimum value of 91.0; no maximum value applies. All other specifications apply for this high-octane fuel.

<sup>3</sup> Calculate dry vapor pressure equivalent, *DVPE*, based on the measured total vapor pressure,  $p_T$ , using the following equation:  $DVPE$  (kPa) =  $0.956 \cdot p_T - 2.39$  or  $DVPE$  (psi) =  $0.956 \cdot p_T - 0.347$ . *DVPE* is intended to be equivalent to Reid Vapor Pressure using a different test method.

<sup>4</sup> Parenthetical values are shown for informational purposes only.

<sup>5</sup> The reference procedure prescribes measurement of olefin concentration in mass %. Multiply this result by 0.857 and round to the first decimal place to determine the olefin concentration in volume %.

<sup>6</sup> ASTM D5599 prescribes concentration measurements for ethanol and other oxygenates in mass %. Convert results to volume % as specified in Section 14.3 of ASTM D4815.

(3) The ethanol-blended specification in Table 1 of this section is based on the volume % ethanol content of the fuel as determined during blending by the fuel supplier and as stated by the supplier at the time of fuel delivery. Use good engineering judgment to determine the

volume % of ethanol based on the volume of each blendstock. We recommend using a flow-based or gravimetric procedure that has an accuracy and repeatability of  $\pm 0.1\%$ .

(c) The specifications of this paragraph (c) apply for testing with neat

gasoline. This is sometimes called indolene or E0 test fuel. Gasoline for testing must have octane values that represent commercially available fuels for the appropriate application. Test fuel specifications apply as follows:

TABLE 2 OF § 1065.710—TEST FUEL SPECIFICATIONS FOR NEAT (E0) GASOLINE

Property	Unit	Specification		Reference procedure <sup>1</sup>
		General testing	Low-temperature testing	
Distillation Range:				
Evaporated initial boiling point .....	°C .....	24–35 <sup>2</sup> .....	24–36 .....	ASTM D86.
10% evaporated .....		49–57 .....	37–48..	
50% evaporated .....		93–110 .....	82–101..	
90% evaporated .....		149–163 .....	158–174..	
Evaporated final boiling point .....		Maximum, 213 .....	Maximum, 212..	
Hydrocarbon composition:				
Olefins .....	volume % .....	Maximum, 0.10 .....	Maximum, 0.175 .....	ASTM D1319.
Aromatics .....		Maximum, 0.35 .....	Maximum, 0.304..	
Saturates .....		Remainder .....	Remainder..	
Lead .....	g/liter .....	Maximum, 0.013 .....	Maximum, 0.013 .....	ASTM D3237.
Phosphorous .....	g/liter .....	Maximum, 0.0013 .....	Maximum, 0.005 .....	ASTM D3231.
Total sulfur .....	mg/kg .....	Maximum, 80 .....	Maximum, 80 .....	ASTM D2622.
Dry vapor pressure equivalent <sup>3</sup> .....	kPa .....	60.0–63.4 <sup>2,4</sup> .....	77.2–81.4 .....	ASTM D5191.

<sup>1</sup> ASTM procedures are incorporated by reference in § 1065.1010. See § 1065.701(d) for other allowed procedures.

<sup>2</sup>For testing at altitudes above 1219 m, the specified initial boiling point range is (23.9 to 40.6) °C and the specified volatility range is (52.0 to 55.2) kPa.

<sup>3</sup>Calculate dry vapor pressure equivalent, *DVPE*, based on the measured total vapor pressure,  $p_T$ , in kPa using the following equation:  $DVPE$  (kPa) =  $0.956 \cdot p_T - 2.39$  or  $DVPE$  (psi) =  $0.956 \cdot p_T - 0.347$ . *DVPE* is intended to be equivalent to Reid Vapor Pressure using a different test method.

<sup>4</sup>For testing unrelated to evaporative emissions, the specified range is (55.2 to 63.4) kPa.

(d) Use the high-octane gasoline specified in paragraph (b) of this section only for engines or vehicles for which the manufacturer conditions the

warranty on the use of premium gasoline.

■ 317. Section 1065.715 is amended by revising paragraph (a) to read as follows:

**§ 1065.715 Natural gas.**

(a) Except as specified in paragraph (b) of this section, natural gas for testing must meet the specifications in the following table:

TABLE 1 OF § 1065.715—TEST FUEL SPECIFICATIONS FOR NATURAL GAS

Property	Value <sup>1</sup>
Methane, CH <sub>4</sub> .....	Minimum, 0.87 mol/mol.
Ethane, C <sub>2</sub> H <sub>6</sub> .....	Maximum, 0.055 mol/mol.
Propane, C <sub>3</sub> H <sub>8</sub> .....	Maximum, 0.012 mol/mol.
Butane, C <sub>4</sub> H <sub>10</sub> .....	Maximum, 0.0035 mol/mol.
Pentane, C <sub>5</sub> H <sub>12</sub> .....	Maximum, 0.0013 mol/mol.
C <sub>6</sub> and higher .....	Maximum, 0.001 mol/mol.
Oxygen .....	Maximum, 0.001 mol/mol.
Inert gases (sum of CO <sub>2</sub> and N <sub>2</sub> ) .....	Maximum, 0.051 mol/mol.

<sup>1</sup>Demonstrate compliance with fuel specifications based on the reference procedures in ASTM D1945 (incorporated by reference in § 1065.1010), or on other measurement procedures using good engineering judgment. See § 1065.701(d) for other allowed procedures.

\* \* \* \* \*

**§ 1065.720 Liquefied petroleum gas.**

gas for testing must meet the specifications in the following table:

■ 318. Section 1065.720 is amended by revising paragraph (a) to read as follows:

(a) Except as specified in paragraph (b) of this section, liquefied petroleum

TABLE 1 OF § 1065.720—TEST FUEL SPECIFICATIONS FOR LIQUEFIED PETROLEUM GAS

Property	Value	Reference procedure <sup>1</sup>
Propane, C <sub>3</sub> H <sub>8</sub> .....	Minimum, 0.85 m <sup>3</sup> /m <sup>3</sup> .....	ASTM D2163.
Vapor pressure at 38 °C .....	Maximum, 1400 kPa .....	ASTM D1267 or D2598. <sup>2</sup>
Volatility residue (evaporated temperature, 35 °C) .....	Maximum, -38 °C .....	ASTM D1837.
Butanes .....	Maximum, 0.05 m <sup>3</sup> /m <sup>3</sup> .....	ASTM D2163.
Butenes .....	Maximum, 0.02 m <sup>3</sup> /m <sup>3</sup> .....	ASTM D2163.
Pentenenes and heavier .....	Maximum, 0.005 m <sup>3</sup> /m <sup>3</sup> .....	ASTM D2163.
Propene .....	Maximum, 0.1 m <sup>3</sup> /m <sup>3</sup> .....	ASTM D2163.
Residual matter (residue on evaporation of 100 ml oil stain observation) ...	Maximum, 0.05 ml pass <sup>3</sup> .....	ASTM D2158.
Corrosion, copper strip .....	Maximum, No. 1 .....	ASTM D1838.
Sulfur .....	Maximum, 80 mg/kg .....	ASTM D2784.
Moisture content .....	pass .....	ASTM D2713.

<sup>1</sup>ASTM procedures are incorporated by reference in § 1065.1010. See § 1065.701(d) for other allowed procedures.

<sup>2</sup>If these two test methods yield different results, use the results from ASTM D1267.

<sup>3</sup>The test fuel must not yield a persistent oil ring when you add 0.3 ml of solvent residue mixture to a filter paper in 0.1 ml increments and examine it in daylight after two minutes.

\* \* \* \* \*

■ 319. A new § 1065.725 is added to subpart H to read as follows:

**§ 1065.725 High-level ethanol-gasoline blends.**

For testing vehicles capable of operating on a high-level ethanol-gasoline blend, create a test fuel as follows:

(a) Add ethanol to an E10 fuel meeting the specifications described in § 1065.710 until the ethanol content of the blended fuel is between 80 and 83 volume %.

(b) You may alternatively add ethanol to a gasoline base fuel with no ethanol if you can demonstrate that such a base

fuel blended with the proper amount of ethanol would meet all the specifications for E10 test fuel described in § 1065.710, other than the ethanol content.

(c) The ethanol used for blending must be either denatured ethanol meeting the specifications in 40 CFR 80.1610, or fuel-grade ethanol with no denaturant. Account for the volume of any denaturant when calculating volumetric percentages.

(d) The blended test fuel must have a dry vapor pressure equivalent between 41.5 and 45.1 kPa (6.0 and 6.5 psi) when measured using the procedure specified in § 1065.710. You may add commercial

grade butane as needed to meet this specification.

■ 320. Section 1065.750 is amended by revising the introductory text and paragraph (a) to read as follows:

**§ 1065.750 Analytical gases.**

Analytical gases must meet the accuracy and purity specifications of this section, unless you can show that other specifications would not affect your ability to show that you comply with all applicable emission standards.

(a) Subparts C, D, F, and J of this part refer to the following gas specifications:

(1) Use purified gases to zero measurement instruments and to blend

with calibration gases. Use gases with contamination no higher than the highest of the following values in the gas cylinder or at the outlet of a zero-gas generator:

(i) 2% contamination, measured relative to the flow-weighted mean concentration expected at the standard. For example, if you would expect a flow-weighted CO concentration of 100.0 μmol/mol, then you would be

allowed to use a zero gas with CO contamination less than or equal to 2.000 μmol/mol.

(ii) Contamination as specified in the following table:

TABLE 1 OF § 1065.750—GENERAL SPECIFICATIONS FOR PURIFIED GASES <sup>1</sup>

Constituent	Purified air	Purified N <sub>2</sub>
THC (C <sub>1</sub> -equivalent)	≤ 0.05 μmol/mol	≤ 0.05 μmol/mol.
CO	≤ 1 μmol/mol	≤ 1 μmol/mol.
CO <sub>2</sub>	≤ 10 μmol/mol	≤ 10 μmol/mol.
O <sub>2</sub>	0.205 to 0.215 mol/mol	≤ 2 μmol/mol.
NO <sub>x</sub>	≤ 0.02 μmol/mol	≤ 0.02 μmol/mol.
N <sub>2</sub> O <sup>2</sup>	≤ 0.02 μmol/mol	≤ 0.02 μmol/mol.

<sup>1</sup> We do not require these levels of purity to be NIST-traceable.

<sup>2</sup> The N<sub>2</sub>O limit applies only if the standard-setting part requires you to report N<sub>2</sub>O or certify to an N<sub>2</sub>O standard.

(2) Use the following gases with a FID analyzer:

(i) *FID fuel*. Use FID fuel with a stated H<sub>2</sub> concentration of (0.39 to 0.41) mol/mol, balance He or N<sub>2</sub>, and a stated total hydrocarbon concentration of 0.05 μmol/mol or less. For GC-FIDs that measure methane (CH<sub>4</sub>) using a FID fuel that is balance N<sub>2</sub>, perform the CH<sub>4</sub> measurement as described in SAE J1151 (incorporated by reference in § 1065.1010).

(ii) *FID burner air*. Use FID burner air that meets the specifications of purified air in paragraph (a)(1) of this section. For field testing, you may use ambient air.

(iii) *FID zero gas*. Zero flame-ionization detectors with purified gas that meets the specifications in paragraph (a)(1) of this section, except that the purified gas O<sub>2</sub> concentration may be any value. Note that FID zero balance gases may be any combination of purified air and purified nitrogen. We recommend FID analyzer zero gases that contain approximately the expected flow-weighted mean concentration of O<sub>2</sub> in the exhaust sample during testing.

(iv) *FID propane span gas*. Span and calibrate THC FID with span concentrations of propane, C<sub>3</sub>H<sub>8</sub>. Calibrate on a carbon number basis of one (C<sub>1</sub>). For example, if you use a C<sub>3</sub>H<sub>8</sub> span gas of concentration 200 μmol/mol, span a FID to respond with a value of 600 μmol/mol. Note that FID span balance gases may be any combination of purified air and purified nitrogen. We recommend FID analyzer span gases that contain approximately the flow-weighted mean concentration of O<sub>2</sub> expected during testing. If the expected O<sub>2</sub> concentration in the exhaust sample is zero, we recommend using a balance gas of purified nitrogen.

(v) *FID CH<sub>4</sub> span gas*. If you always span and calibrate a CH<sub>4</sub> FID with a nonmethane cutter, then span and

calibrate the FID with span concentrations of CH<sub>4</sub>. Calibrate on a carbon number basis of one (C<sub>1</sub>). For example, if you use a CH<sub>4</sub> span gas of concentration 200 μmol/mol, span a FID to respond with a value of 200 μmol/mol. Note that FID span balance gases may be any combination of purified air and purified nitrogen. We recommend FID analyzer span gases that contain approximately the expected flow-weighted mean concentration of O<sub>2</sub> in the exhaust sample during testing. If the expected O<sub>2</sub> concentration in the exhaust sample is zero, we recommend using a balance gas of purified nitrogen.

(3) Use the following gas mixtures, with gases traceable within ±1% of the NIST-accepted value or other gas standards we approve:

(i) CH<sub>4</sub>, balance purified air and/or N<sub>2</sub> (as applicable).

(ii) C<sub>2</sub>H<sub>6</sub>, balance purified air and/or N<sub>2</sub> (as applicable).

(iii) C<sub>3</sub>H<sub>8</sub>, balance purified air and/or N<sub>2</sub> (as applicable).

(iv) CO, balance purified N<sub>2</sub>.

(v) CO<sub>2</sub>, balance purified N<sub>2</sub>.

(vi) NO, balance purified N<sub>2</sub>.

(vii) NO<sub>2</sub>, balance purified air.

(viii) O<sub>2</sub>, balance purified N<sub>2</sub>.

(ix) C<sub>3</sub>H<sub>8</sub>, CO, CO<sub>2</sub>, NO, balance purified N<sub>2</sub>.

(x) C<sub>3</sub>H<sub>8</sub>, CH<sub>4</sub>, CO, CO<sub>2</sub>, NO, balance purified N<sub>2</sub>.

(xi) N<sub>2</sub>O, balance purified air and/or N<sub>2</sub> (as applicable).

(4) You may use gases for species other than those listed in paragraph (a)(3) of this section (such as methanol in air, which you may use to determine response factors), as long as they are traceable to within ±3% of the NIST-accepted value or other similar standards we approve, and meet the stability requirements of paragraph (b) of this section.

(5) You may generate your own calibration gases using a precision

blending device, such as a gas divider, to dilute gases with purified N<sub>2</sub> or purified air. If your gas divider meets the specifications in § 1065.248, and the gases being blended meet the requirements of paragraphs (a)(1) and (3) of this section, the resulting blends are considered to meet the requirements of this paragraph (a).

\* \* \* \* \*

**Subpart I—[Amended]**

■ 321. Section 1065.805 is amended by revising paragraphs (d) and (f) to read as follows:

**§ 1065.805 Sampling system.**

\* \* \* \* \*

(d) You may bubble a sample of the exhaust through water to collect alcohols for later analysis. You may also use a photoacoustic analyzer to quantify ethanol and methanol in an exhaust sample as described in § 1065.269.

\* \* \* \* \*

(f) You may sample alcohols or carbonyls using “California Non-Methane Organic Gas Test Procedures” (incorporated by reference in § 1065.1010). If you use this method, follow its calculations to determine the mass of the alcohol/carbonyl in the exhaust sample, but follow subpart G of this part for all other calculations (40 CFR part 1066, subpart G, for vehicle testing).

\* \* \* \* \*

■ 322. Section 1065.845 is revised to read as follows:

**§ 1065.845 Response factor determination.**

Since FID analyzers generally have an incomplete response to alcohols and carbonyls, determine each FID analyzer’s alcohol/carbonyl response factor (RF<sub>OHCI(THC-FID)</sub>) after FID optimization to subtract those responses from the FID reading. Use the most

recently determined alcohol/carbonyl response factors to compensate for alcohol/carbonyl response. You are not required to determine the response factor for a compound unless you will subtract its response to compensate for a response.

(a) You may generate response factors as described in paragraph (b) of this section, or you may use the following default response factors, consistent with good engineering judgment:

TABLE 1 OF § 1065.845—DEFAULT VALUES FOR THC FID RESPONSE FACTOR RELATIVE TO PROPANE ON A C<sub>+1</sub>-EQUIVALENT BASIS

Compound	Response factor (RF)
acetaldehyde .....	0.50
ethanol .....	0.75
formaldehyde .....	0.00
methanol .....	0.63
propanol .....	0.85

(b) Determine the alcohol/carbonyl response factors as follows:

(1) Select a C<sub>3</sub>H<sub>8</sub> span gas that meets the specifications of § 1065.750. Note that FID zero and span balance gases may be any combination of purified air or purified nitrogen that meets the specifications of § 1065.750. We recommend FID analyzer zero and span gases that contain approximately the flow-weighted mean concentration of O<sub>2</sub> expected during testing. Record the C<sub>3</sub>H<sub>8</sub> concentration of the gas.

(2) Select or prepare an alcohol/carbonyl calibration gas that meets the specifications of § 1065.750 and has a concentration typical of the peak concentration expected at the hydrocarbon standard. Record the calibration concentration of the gas.

(3) Start and operate the FID analyzer according to the manufacturer's instructions.

(4) Confirm that the FID analyzer has been calibrated using C<sub>3</sub>H<sub>8</sub>. Calibrate on a carbon number basis of one (C<sub>1</sub>). For example, if you use a C<sub>3</sub>H<sub>8</sub> span gas of

concentration 200 μmol/mol, span the FID to respond with a value of 600 μmol/mol.

(5) Zero the FID. Note that FID zero and span balance gases may be any combination of purified air or purified nitrogen that meets the specifications of § 1065.750. We recommend FID analyzer zero and span gases that contain approximately the flow-weighted mean concentration of O<sub>2</sub> expected during testing.

(6) Span the FID with the C<sub>3</sub>H<sub>8</sub> span gas that you selected under paragraph (a)(1) of this section.

(7) Introduce at the inlet of the FID analyzer the alcohol/carbonyl calibration gas that you selected under paragraph (a)(2) of this section.

(8) Allow time for the analyzer response to stabilize. Stabilization time may include time to purge the analyzer and to account for its response.

(9) While the analyzer measures the alcohol/carbonyl concentration, record 30 seconds of sampled data. Calculate the arithmetic mean of these values.

(10) Divide the mean measured concentration by the recorded span concentration of the alcohol/carbonyl calibration gas on a C<sub>1</sub>-equivalent basis. The result is the FID analyzer's response factor for alcohol/carbonyl,  $RF_{OHC1(THC-FID)}$  on a C<sub>1</sub>-equivalent basis.

(c) Alcohol/carbonyl calibration gases must remain within ±2% of the labeled concentration. You must demonstrate the stability based on a quarterly measurement procedure with a precision of ±2% percent or another method that we approve. Your measurement procedure may incorporate multiple measurements. If the true concentration of the gas changes deviates by more than ±2%, but less than ±10%, the gas may be relabeled with the new concentration.

■ 323. Section 1065.850 is revised to read as follows:

**§ 1065.850 Calculations.**

Use the calculations specified in § 1065.665 to determine THCE or

NMHCE and the calculations specified in 40 CFR 1066.635 to determine NMOG.

**Subpart J—[Amended]**

■ 324. Section 1065.905 is amended by revising paragraphs (a) and (d)(2)(i)(A) to read as follows:

**§ 1065.905 General provisions.**

(a) *General.* Unless the standard-setting part specifies deviations from the provisions of this subpart, field testing and laboratory testing with PEMS must conform to the provisions of this subpart. Use good engineering judgment when testing with PEMS to ensure proper function of the instruments under test conditions. For example, this may require additional maintenance or calibration for field testing or may require verification after moving the PEMS unit.

\* \* \* \* \*

(d) \* \* \*

(2) \* \* \*

(i) \* \* \*

(A) Use good engineering judgment to control dilution air temperature. If you choose to directly and actively control dilution air temperature, set the temperature to 25 °C.

\* \* \* \* \*

■ 325. Section 1065.915 is amended by revising paragraph (a) to read as follows:

**§ 1065.915 PEMS instruments.**

(a) *Instrument specifications.* We recommend that you use PEMS that meet the specifications of subpart C of this part. For unrestricted use of PEMS in a laboratory or similar environment, use a PEMS that meets the same specifications as each lab instrument it replaces. For field testing or for testing with PEMS in a laboratory or similar environment, under the provisions of § 1065.905(b), the specifications in the following table apply instead of the specifications in Table 1 of § 1065.205.

TABLE 1 OF § 1065.915—RECOMMENDED MINIMUM PEMS MEASUREMENT INSTRUMENT PERFORMANCE

Measurement	Measured quantity symbol	Rise time, $t_{10-90}$ , and fall time, $t_{90-10}$	Recording update frequency	Accuracy <sup>1</sup>	Repeat-ability <sup>1</sup>	Noise <sup>1</sup>
Engine speed transducer .....	$f_n$ .....	1 s	1 Hz means	5% of pt. or 1% of max.	2% of pt. or 1% of max.	0.5% of max.
Engine torque estimator, BSFC (This is a signal from an engine's ECM).	$T$ or BSFC .....	1 s	1 Hz means	8% of pt. or 5% of max.	2% of pt. or 1% of max.	1% of max.
General pressure transducer (not a part of another instrument).	$p$ .....	5 s	1 Hz .....	5% of pt. or 5% of max.	2% of pt. or 0.5% of max.	1% of max.
Atmospheric pressure meter .....	$p_{atmos}$ .....	50 s	0.1 Hz .....	250 Pa .....	200 Pa .....	100 Pa.
General temperature sensor (not a part of another instrument).	$T$ .....	5 s	1 Hz .....	1% of pt. K or 5 K.	0.5% of pt. K or 2 K.	0.5% of max 0.5 K.

TABLE 1 OF § 1065.915—RECOMMENDED MINIMUM PEMS MEASUREMENT INSTRUMENT PERFORMANCE—Continued

Measurement	Measured quantity symbol	Rise time, $t_{10-90}$ , and fall time, $t_{90-10}$	Recording update frequency	Accuracy <sup>1</sup>	Repeatability <sup>1</sup>	Noise <sup>1</sup>
General dewpoint sensor .....	$T_{dew}$ .....	50 s	0.1 Hz .....	3 K .....	1 K .....	1 K.
Exhaust flow meter .....	$\dot{n}$ .....	1 s	1 Hz means	5% of pt. or 3% of max.	2% of pt .....	2% of max.
Dilution air, inlet air, exhaust, and sample flow meters.	$\dot{n}$ .....	1 s	1 Hz means	2.5% of pt. or 1.5% of max.	1.25% of pt. or 0.75% of max.	1% of max.
Continuous gas analyzer .....	$x$ .....	5 s	1 Hz .....	4% of pt. or 4% of meas.	2% of pt. or 2% of meas.	1% of max.
Gravimetric PM balance .....	$m_{PM}$ .....	.....	.....	See § 1065.790.	0.5 µg.	
Inertial PM balance .....	$m_{PM}$ .....	.....	.....	4% of pt. or 4% of meas.	2% of pt. or 2% of meas.	1% of max.

<sup>1</sup> Accuracy, repeatability, and noise are all determined with the same collected data, as described in § 1065.305, and based on absolute values. “pt.” refers to the overall flow-weighted mean value expected at the standard; “max.” refers to the peak value expected at the standard over any test interval, not the maximum of the instrument’s range; “meas” refers to the actual flow-weighted mean measured over any test interval.

\* \* \* \* \*

■ 326. Section 1065.920 is amended by revising paragraphs (a), (b) introductory text, and (b)(7) introductory text to read as follows:

**§ 1065.920 PEMS calibrations and verifications.**

(a) *Subsystem calibrations and verifications.* Use all the applicable calibrations and verifications in subpart D of this part, including the linearity verifications in § 1065.307, to calibrate and verify PEMS. Note that a PEMS does not have to meet the system-response and updating-recording verifications of § 1065.308 and § 1065.309 if it meets the overall verification described in paragraph (b) of this section or if it measures PM using any method other than that described in § 1065.170(c)(1). This section does not apply to ECM signals. Note that because the regulations of this part require you to use good engineering judgment, it may be necessary to perform additional verifications and analysis. It may also be necessary to limit the range of conditions under which the PEMS can be used or to include specific additional maintenance to ensure that it functions properly under the test conditions. As provided in 40 CFR 1068.5, we will deem your system to not meet the requirements of this section if we determine that you did not use good engineering judgment to verify the measurement equipment. We may also deem your system to meet these requirements only under certain test conditions. If we ask for it, you must send us a summary of your verifications. We may also ask you to provide additional information or analysis to support your conclusions.

(b) *Overall verification.* This paragraph (b) specifies methods and criteria for verifying the overall performance of systems not fully compliant with requirements that apply for laboratory testing. Maintain records to show that the particular make, model, and configuration of your PEMS meets this verification. You may rely on data and other information from the PEMS manufacturer. However, we recommend that you generate your own records to show that your specific PEMS meets this verification. If you upgrade or change the configuration of your PEMS, your record must show that your new configuration meets this verification. The verification required by this section consists of operating an engine over a duty cycle in the laboratory and statistically comparing data generated and recorded by the PEMS with data simultaneously generated and recorded by laboratory equipment as follows:

(7) The PEMS passes the verification of this paragraph (b) if any one of the following are true for each constituent:

**Subpart K—[Amended]**

- 327. Section 1065.1001 is amended as follows:
  - a. By removing the definition for “C<sub>1</sub> equivalent (or basis)”.
  - b. By adding a definition for “C<sub>1</sub>-equivalent (or basis)” in alphabetical order.
  - c. By removing the definition for “Engine”.
  - d. By revising the definitions for “HEPA filter”, “Hydrocarbon (HC)”, “Oxygenated fuels”, and “Precision”.
  - e. By adding a definition for “Purified air” in alphabetical order.

**§ 1065.1001 Definitions.**

\* \* \* \* \*

*C<sub>1</sub>-equivalent (or basis)* means a convention of expressing HC concentrations based on the total number of carbon atoms present, such that the C<sub>1</sub> equivalent of a molar HC concentration equals the molar concentration multiplied by the mean number of carbon atoms in each HC molecule. For example, the C<sub>1</sub> equivalent of 10 µmol/mol of propane (C<sub>3</sub>H<sub>8</sub>) is 30 µmol/mol. C<sub>1</sub> equivalent molar values may be denoted as “ppmC” in the standard-setting part. Molar mass may also be expressed on a C<sub>1</sub> basis. Note that calculating HC masses from molar concentrations and molar masses is only valid where they are each expressed on the same carbon basis.

\* \* \* \* \*

*HEPA filter* means high-efficiency particulate air filters that are rated to achieve a minimum initial particle-removal efficiency of 99.97% using ASTM F1471 (incorporated by reference in § 1065.1010).

\* \* \* \* \*

*Hydrocarbon (HC)* means THC, THCE, NMHC, NMOG, or NMHCE, as applicable. Hydrocarbon generally means the hydrocarbon group on which the emission standards are based for each type of fuel and engine.

\* \* \* \* \*

*Oxygenated fuels* means fuels composed of at least 25% oxygen-containing compounds, such as ethanol or methanol. Testing engines that use oxygenated fuels generally requires the use of the sampling methods in subpart I of this part. However, you should read the standard-setting part and subpart I



of this part to determine appropriate sampling methods.

\* \* \* \* \*

*Precision* means two times the standard deviation of a set of measured values of a single zero or reference quantity. See also the related definitions of *noise* and *repeatability* in this section.

\* \* \* \* \*

*Purified air* means air meeting the specifications for purified air in § 1065.750. Purified air may be produced by purifying ambient air. The

purification may occur at the test site or at another location (such as at a gas supplier's facility). Alternatively, purified air may be synthetically generated, using good engineering judgment, from purified oxygen and nitrogen. The addition of other elements normally present in purified ambient air (such as Ar) is not required.

\* \* \* \* \*

■ 328. Section 1065.1005 is revised to read as follows:

**§ 1065.1005 Symbols, abbreviations, acronyms, and units of measure.**

The procedures in this part generally follow the International System of Units (SI), as detailed in NIST Special Publication 811, which we incorporate by reference in § 1065.1010. See § 1065.20 for specific provisions related to these conventions. This section summarizes the way we use symbols, units of measure, and other abbreviations.

(a) *Symbols for quantities.* This part uses the following symbols and units of measure for various quantities:

Symbol	Quantity	Unit	Unit symbol	Units in terms of SI base units
$\alpha$ .....	atomic hydrogen-to-carbon ratio .....	mole per mole .....	mol/mol .....	1
$A$ .....	area .....	square meter .....	m <sup>2</sup> .....	m <sup>2</sup>
$a_0$ .....	intercept of least squares regression.			
$a_1$ .....	slope of least squares regression.			
$a_g$ .....	acceleration of Earth's gravity .....	meter per square second ....	m/s <sup>2</sup> .....	m/s <sup>2</sup>
$\beta$ .....	ratio of diameters .....	meter per meter .....	m/m .....	1
$\beta$ .....	atomic oxygen-to-carbon ratio .....	mole per mole .....	mol/mol .....	1
$C_{\#}$ .....	number of carbon atoms in a molecule.			
$C_d$ .....	discharge coefficient.			
$C_f$ .....	flow coefficient.			
$\delta$ .....	atomic nitrogen-to-carbon ratio .....	mole per mole .....	mol/mol .....	1
$d$ .....	Diameter .....	meter .....	m .....	m
$DR$ .....	dilution ratio .....	mole per mole .....	mol/mol .....	1
$\epsilon$ .....	error between a quantity and its reference.			
$e$ .....	brake-specific emission or fuel consumption.	gram per kilowatt hour .....	g/(kW·hr) .....	g·3.6 <sup>-1</sup> ·10 <sup>6</sup> ·m <sup>-2</sup> ·kg·s <sup>-2</sup>
$F$ .....	F-test statistic.			
$f$ .....	frequency .....	hertz .....	Hz .....	s <sup>-1</sup>
$f_n$ .....	angular speed (shaft) .....	revolutions per minute .....	r/min .....	2· $\pi$ ·60 <sup>-1</sup> ·m·m <sup>-1</sup> ·s <sup>-1</sup>
$\gamma$ .....	ratio of specific heats .....	(joule per kilogram kelvin) per (joule per kilogram kelvin).	(J/(kg·K))/(J/(kg·K)) .....	1
$\gamma$ .....	atomic sulfur-to-carbon ratio .....	mole per mole .....	mol/mol .....	1
$K$ .....	correction factor .....			1
$K_v$ .....	calibration coefficient .....		m <sup>4</sup> ·s·K <sup>0.5</sup> /kg .....	m <sup>4</sup> ·s·K <sup>0.5</sup> ·kg <sup>-1</sup>
$l$ .....	length .....	meter .....	m .....	m
$\mu$ .....	viscosity, dynamic .....	pascal second .....	Pa·s .....	m <sup>-1</sup> ·kg·s <sup>-1</sup>
$M$ .....	molar mass <sup>1</sup> .....	gram per mole .....	g/mol .....	10 <sup>-3</sup> ·kg·mol <sup>-1</sup>
$m$ .....	mass .....	kilogram .....	kg .....	kg
$\dot{m}$ .....	mass rate .....	kilogram per second .....	kg/s .....	kg·s <sup>-1</sup>
$\nu$ .....	viscosity, kinematic .....	meter squared per second ..	m <sup>2</sup> /s .....	m <sup>2</sup> ·s <sup>-1</sup>
$N$ .....	total number in series.			
$n$ .....	amount of substance .....	mole .....	mol .....	mol
$\dot{n}$ .....	amount of substance rate .....	mole per second .....	mol/s .....	mol·s <sup>-1</sup>
$P$ .....	power .....	kilowatt .....	kW .....	10 <sup>3</sup> ·m <sup>2</sup> ·kg·s <sup>-3</sup>
$PF$ .....	penetration fraction.			
$p$ .....	pressure .....	pascal .....	Pa .....	m <sup>-1</sup> ·kg·s <sup>-2</sup>
$\rho$ .....	mass density .....	kilogram per cubic meter ...	kg/m <sup>3</sup> .....	kg·m <sup>-3</sup>
$\Delta p$ .....	differential static pressure .....	pascal .....	Pa .....	m <sup>-1</sup> ·kg·s <sup>-2</sup>
$r$ .....	ratio of pressures .....	pascal per pascal .....	Pa/Pa .....	1
$r^2$ .....	coefficient of determination.			
$Ra$ .....	average surface roughness .....	micrometer .....	$\mu$ m .....	10 <sup>-6</sup> m
$Re^{\#}$ .....	Reynolds number.			
$RF$ .....	response factor.			
$RH$ .....	relative humidity.			
$\sigma$ .....	non-biased standard deviation.			
$S$ .....	Sutherland constant .....	kelvin .....	K .....	K
$SEE$ .....	standard estimate of error.			
$T$ .....	absolute temperature .....	kelvin .....	K .....	K
$T$ .....	Celsius temperature .....	degree Celsius .....	°C .....	K - 273.15
$T$ .....	torque (moment of force) .....	newton meter .....	N·m .....	m <sup>2</sup> ·kg·s <sup>-2</sup>
$\theta$ .....	plane angle .....	degrees .....	° .....	rad
$t$ .....	time .....	second .....	s .....	s
$\Delta t$ .....	time interval, period, 1/frequency .....	second .....	s .....	s
$V$ .....	volume .....	cubic meter .....	m <sup>3</sup> .....	m <sup>3</sup>
$\dot{V}$ .....	volume rate .....	cubic meter per second .....	m <sup>3</sup> /s .....	m <sup>3</sup> ·s <sup>-1</sup>

Symbol	Quantity	Unit	Unit symbol	Units in terms of SI base units
W .....	work .....	kilowatt hour .....	kW-hr .....	$3.6 \cdot 10^{-6} \cdot \text{m}^2 \cdot \text{kg} \cdot \text{s}^{-2}$
w <sub>c</sub> .....	carbon mass fraction .....	gram per gram .....	g/g .....	1
x .....	amount of substance mole fraction <sup>2</sup> .....	mole per mole .....	mol/mol .....	1
$\bar{x}$ .....	flow-weighted mean concentration .....	mole per mole .....	mol/mol .....	1
y .....	generic variable.			
Z .....	compressibility factor.			

<sup>1</sup> See paragraph (f)(2) of this section for the values to use for molar masses. Note that in the cases of NO<sub>x</sub> and HC, the regulations specify effective molar masses based on assumed speciation rather than actual speciation.

<sup>2</sup> Note that mole fractions for THC, THCE, NMHC, NMHCE, and NOTHC are expressed on a C<sub>1</sub> equivalent basis.

(b) *Symbols for chemical species.* This part uses the following symbols for chemical species and exhaust constituents:

Symbol	Species
Ar .....	argon.
C .....	carbon.
CH <sub>2</sub> O .....	formaldehyde.
CH <sub>3</sub> OH .....	methanol.
CH <sub>4</sub> .....	methane.
C <sub>2</sub> H <sub>4</sub> O .....	acetaldehyde.
C <sub>2</sub> H <sub>5</sub> OH .....	ethanol.
C <sub>2</sub> H <sub>6</sub> .....	ethane.
C <sub>3</sub> H <sub>7</sub> OH .....	propanol.
C <sub>3</sub> H <sub>8</sub> .....	propane.
C <sub>4</sub> H <sub>10</sub> .....	butane.
C <sub>5</sub> H <sub>12</sub> .....	pentane.
CO .....	carbon monoxide.
CO <sub>2</sub> .....	carbon dioxide.
H .....	atomic hydrogen.
H <sub>2</sub> .....	molecular hydrogen.
H <sub>2</sub> O .....	water.
H <sub>2</sub> SO <sub>4</sub> .....	sulfuric acid.
HC .....	hydrocarbon.
He .....	helium.
<sup>85</sup> Kr .....	krypton 85.
N <sub>2</sub> .....	molecular nitrogen.
NH <sub>3</sub> .....	ammonia.
NMHC .....	nonmethane hydrocarbon.
NMHCE .....	nonmethane hydrocarbon equivalent.
NO .....	nitric oxide.
NO <sub>2</sub> .....	nitrogen dioxide.
NO <sub>x</sub> .....	oxides of nitrogen.
N <sub>2</sub> O .....	nitrous oxide.
NMOG .....	nonmethane organic gases.
NONMHC .....	non-oxygenated nonmethane hydrocarbon.
NOTHC .....	non-oxygenated total hydrocarbon.
O <sub>2</sub> .....	molecular oxygen.
OHC .....	oxygenated hydrocarbon.
<sup>210</sup> Po .....	polonium 210.
PM .....	particulate matter.
S .....	sulfur.
SVOC .....	semi-volatile organic compound.
THC .....	total hydrocarbon.
THCE .....	total hydrocarbon equivalent.
ZrO <sub>2</sub> .....	zirconium dioxide.

(c) *Prefixes.* This part uses the following prefixes to define a quantity:

Symbol	Quantity	Value
μ .....	micro .....	10 <sup>-6</sup>
m .....	milli .....	10 <sup>-3</sup>
c .....	centi .....	10 <sup>-2</sup>
k .....	kilo .....	10 <sup>3</sup>
M .....	mega .....	10 <sup>6</sup>

(d) *Superscripts.* This part uses the following superscripts to define a quantity:

Super-script	Quantity
overbar (such as $\bar{y}$ ).	arithmetic mean.
overdot (such as $\dot{y}$ ).	quantity per unit time.

(e) *Subscripts.* This part uses the following subscripts to define a quantity:

Subscript	Quantity
abs .....	absolute quantity.
act .....	actual condition.
air .....	air, dry.
amb .....	ambient.
atmos .....	atmospheric.
bkgnd .....	background.
cal .....	calibration quantity.
CFV .....	critical flow venturi.
comb .....	combined.
composite .....	composite value.
cor .....	corrected quantity.
dil .....	dilution air.
dew .....	dewpoint.
dexh .....	diluted exhaust.
dry .....	dry condition.
dutycycle .....	duty cycle.
exh .....	raw exhaust.
exp .....	expected quantity.
fn .....	feedback speed.
frict .....	friction.

Subscript	Quantity
fuel .....	fuel consumption.
hi, idle .....	condition at high-idle.
i .....	an individual of a series.
idle .....	condition at idle.
in .....	quantity in.
init .....	initial quantity, typically before an emission test.
int .....	intake air.
j .....	an individual of a series.
mapped .....	conditions over which an engine can operate.
max .....	the maximum (i.e., peak) value expected at the standard over a test interval; not the maximum of an instrument range.
meas .....	measured quantity.
media .....	PM sample media.
mix .....	mixture of diluted exhaust and air.
norm .....	normalized.
out .....	quantity out.
P .....	power.
part .....	partial quantity.
PDP .....	positive-displacement pump.
post .....	after the test interval.
pre .....	before the test interval.
prod .....	stoichiometric product.
record .....	record rate.
ref .....	reference quantity.
rev .....	revolution.
sat .....	saturated condition.
s .....	slip.
span .....	span quantity.
SSV .....	subsonic venturi.
std .....	standard condition.
stroke .....	engine strokes per power stroke.
T .....	torque.
test .....	test quantity.
test, alt .....	alternate test quantity.
uncor .....	uncorrected quantity.
vac .....	vacuum side of the sampling system.
weight .....	calibration weight.
zero .....	zero quantity.

(f) *Constants.* (1) This part uses the following constants for the composition of dry air:

Symbol	Quantity	mol/mol
χ <sub>Arair</sub> .....	amount of argon in dry air .....	0.00934
χ <sub>CO2air</sub> .....	amount of carbon dioxide in dry air .....	0.000375
χ <sub>N2air</sub> .....	amount of nitrogen in dry air .....	0.78084
χ <sub>O2air</sub> .....	amount of oxygen in dry air .....	0.209445

(2) This part uses the following molar masses or effective molar masses of chemical species:

Symbol	Quantity	g/mol (10 <sup>-3</sup> .kg.mol <sup>-1</sup> )
M <sub>air</sub> .....	molar mass of dry air <sup>1</sup> .....	28.96559
M <sub>Ar</sub> .....	molar mass of argon .....	39.948
M <sub>C</sub> .....	molar mass of carbon .....	12.0107
M <sub>CH<sub>3</sub>OH</sub> .....	molar mass of methanol .....	32.04186
M <sub>C<sub>2</sub>H<sub>5</sub>OH</sub> .....	molar mass of ethanol .....	46.06844
M <sub>C<sub>2</sub>H<sub>4</sub>O</sub> .....	molar mass of acetaldehyde .....	44.05256
M <sub>C<sub>3</sub>H<sub>8</sub></sub> .....	molar mass of propane .....	44.09562
M <sub>C<sub>3</sub>H<sub>7</sub>OH</sub> .....	molar mass of propanol .....	60.09502
M <sub>CO</sub> .....	molar mass of carbon monoxide .....	28.0101
M <sub>CH<sub>4</sub></sub> .....	molar mass of methane .....	16.0425
M <sub>CO<sub>2</sub></sub> .....	molar mass of carbon dioxide .....	44.0095
M <sub>H</sub> .....	molar mass of atomic hydrogen .....	1.00794
M <sub>H<sub>2</sub></sub> .....	molar mass of molecular hydrogen .....	2.01588
M <sub>H<sub>2</sub>O</sub> .....	molar mass of water .....	18.01528
M <sub>CH<sub>2</sub>O</sub> .....	molar mass of formaldehyde .....	30.02598
M <sub>He</sub> .....	molar mass of helium .....	4.002602
M <sub>N</sub> .....	molar mass of atomic nitrogen .....	14.0067
M <sub>N<sub>2</sub></sub> .....	molar mass of molecular nitrogen .....	28.0134
M <sub>NH<sub>3</sub></sub> .....	molar mass of ammonia .....	17.03052
M <sub>NMHC</sub> .....	effective C <sub>1</sub> molar mass of nonmethane hydrocarbon <sup>2</sup> .....	13.875389
M <sub>NMHCE</sub> .....	effective C <sub>1</sub> molar mass of nonmethane hydrocarbon equivalent <sup>2</sup> .....	13.875389
M <sub>NO<sub>x</sub></sub> .....	effective molar mass of oxides of nitrogen <sup>3</sup> .....	46.0055
M <sub>N<sub>2</sub>O</sub> .....	molar mass of nitrous oxide .....	44.0128
M <sub>O</sub> .....	molar mass of atomic oxygen .....	15.9994
M <sub>O<sub>2</sub></sub> .....	molar mass of molecular oxygen .....	31.9988
M <sub>S</sub> .....	molar mass of sulfur .....	32.065
M <sub>THC</sub> .....	effective C <sub>1</sub> molar mass of total hydrocarbon <sup>2</sup> .....	13.875389
M <sub>THCE</sub> .....	effective C <sub>1</sub> molar mass of total hydrocarbon equivalent <sup>2</sup> .....	13.875389

<sup>1</sup> See paragraph (f)(1) of this section for the composition of dry air.

<sup>2</sup> The effective molar masses of THC, THCE, NMHC, and NMHCE are defined on a C<sub>1</sub> basis and are based on an atomic hydrogen-to-carbon ratio, α, of 1.85 (with β, γ, and δ equal to zero).

<sup>3</sup> The effective molar mass of NO<sub>x</sub> is defined by the molar mass of nitrogen dioxide, NO<sub>2</sub>.

(3) This part uses the following molar gas constant for ideal gases:

Symbol	Quantity	J/(mol·K) (m <sup>2</sup> .kg.s <sup>-2</sup> .mol <sup>-1</sup> .K <sup>-1</sup> )
R .....	molar gas constant .....	8.314472

(4) This part uses the following ratios of specific heats for dilution air and diluted exhaust:

Symbol	Quantity	[J/(kg·K)]/[J/(kg·K)]
γ <sub>air</sub> .....	ratio of specific heats for intake air or dilution air .....	1.399
γ <sub>dil</sub> .....	ratio of specific heats for diluted exhaust .....	1.399
γ <sub>exh</sub> .....	ratio of specific heats for raw exhaust .....	1.385

(g) *Other acronyms and abbreviations.* This part uses the following additional abbreviations and acronyms:

ABS .....	acrylonitrile-butadiene-styrene.	CI .....	compression-ignition.	FTIR .....	Fourier transform infrared.
ASTM .....	American Society for Testing and Materials.	CITT .....	Curb Idle Transmission Torque.	GC .....	gas chromatograph.
BMD .....	bag mini-diluter.	CLD .....	chemiluminescent detector.	GC-ECD	gas chromatograph with an electron-capture detector.
BSFC .....	brake-specific fuel consumption.	CVS .....	constant-volume sampler.	GC-FID ..	gas chromatograph with a flame ionization detector.
CARB .....	California Air Resources Board.	DF .....	deterioration factor.	HEPA .....	high-efficiency particulate air.
CFR .....	Code of Federal Regulations.	ECM .....	electronic control module.	IBP .....	initial boiling point.
CFV .....	critical-flow venturi.	EFC .....	electronic flow control.	IBR .....	incorporated by reference.
		e.g .....	for example.	i.e .....	in other words.
		EGR .....	exhaust gas recirculation.	ISO .....	International Organization for Standardization.
		EPA .....	Environmental Protection Agency.		
		FEL .....	Family Emission Limit.		
		FID .....	flame-ionization detector.		

LPG .....	liquefied petroleum gas.
MPD .....	magnetopneumatic detection.
NDIR .....	nondispersive infrared.
NDUV .....	nondispersive ultraviolet.
NIST .....	National Institute for Standards and Technology.
NMC .....	nonmethane cutter.
PDP .....	positive-displacement pump.
PEMS .....	portable emission measurement system.
PFD .....	partial-flow dilution.
PLOT .....	porous layer open tubular.
PMD .....	paramagnetic detection.
PMP .....	Polymethylpentene.
pt .....	a single point at the mean value expected at the standard.
psi .....	pounds per square inch.
PTFE .....	polytetrafluoroethylene (commonly known as Teflon™).
RE .....	rounding error.
RESS .....	rechargeable energy storage system.
RFPF .....	response factor penetration fraction.
RMC .....	ramped-modal cycle.
rms .....	root-mean square.
RTD .....	resistive temperature detector.
SAW .....	surface acoustic wave.
SEE .....	standard estimate of error.
SSV .....	subsonic venturi.
SI .....	spark-ignition.
THC-FID .....	total hydrocarbon flame ionization detector.
TINV .....	inverse student <i>t</i> -test function in Microsoft Excel.
UCL .....	upper confidence limit.
UFM .....	ultrasonic flow meter.
U.S.C .....	United States Code.

■ 329. Section 1065.1010 is revised to read as follows:

**§ 1065.1010 Incorporation by reference.**

(a) Certain material is incorporated by reference into this part with the approval of the Director of the Federal Register under 5 U.S.C. 552(a) and 1 CFR part 51. To enforce any edition other than that specified in this section, a document must be published in the **Federal Register** and the material must be available to the public. All approved materials are available for inspection at the Air and Radiation Docket and Information Center (Air Docket) in the EPA Docket Center (EPA/DC) at Rm. 3334, EPA West Bldg., 1301 Constitution Ave. NW., Washington, DC. The EPA/DC Public Reading Room hours of operation are 8:30 a.m. to 4:30 p.m., Monday through Friday, excluding legal holidays. The telephone number of the EPA/DC Public Reading Room is (202) 566-1744, and the telephone number for the Air Docket is (202) 566-1742. These approved materials are also available for inspection at the National Archives and Records Administration (NARA). For information on the availability of this material at NARA, call (202) 741-6030 or go to [http://www.archives.gov/federal\\_register/](http://www.archives.gov/federal_register/)

*code\_of\_federal\_regulations/ibr\_locations.html*. In addition, these materials are available from the sources listed below.

(b) *ASTM material*. The following standards are available from ASTM International, 100 Barr Harbor Dr., P.O. Box C700, West Conshohocken, PA 19428-2959, (877) 909-ASTM, or <http://www.astm.org>:

(1) ASTM D86-12, Standard Test Method for Distillation of Petroleum Products at Atmospheric Pressure, approved December 1, 2012, IBR approved for §§ 1065.703(b) and 1065.710(b) and (c).

(2) ASTM D93-13, Standard Test Methods for Flash Point by Pensky-Martens Closed Cup Tester, approved July 15, 2013, IBR approved for § 1065.703(b).

(3) ASTM D130-12, Standard Test Method for Corrosiveness to Copper from Petroleum Products by Copper Strip Test, approved November 1, 2012, IBR approved for § 1065.710(b).

(4) ASTM D381-12, Standard Test Method for Gum Content in Fuels by Jet Evaporation, approved April 15, 2012, IBR approved for § 1065.710(b).

(5) ASTM D445-12, Standard Test Method for Kinematic Viscosity of Transparent and Opaque Liquids (and Calculation of Dynamic Viscosity), approved April 15, 2012, IBR approved for § 1065.703(b).

(6) ASTM D525-12a, Standard Test Method for Oxidation Stability of Gasoline (Induction Period Method), approved September 1, 2012, IBR approved for § 1065.710(b).

(7) ASTM D613-13, Standard Test Method for Cetane Number of Diesel Fuel Oil, approved December 1, 2013, IBR approved for § 1065.703(b).

(8) ASTM D910-13a, Standard Specification for Aviation Gasolines, approved December 1, 2013, IBR approved for § 1065.701(f).

(9) ASTM D975-13a, Standard Specification for Diesel Fuel Oils, approved December 1, 2013, IBR approved for § 1065.701(f).

(10) ASTM D1267-12, Standard Test Method for Gage Vapor Pressure of Liquefied Petroleum (LP) Gases (LP-Gas Method), approved November 1, 2012, IBR approved for § 1065.720(a).

(11) ASTM D1319-13, Standard Test Method for Hydrocarbon Types in Liquid Petroleum Products by Fluorescent Indicator Adsorption, approved May 1, 2013, IBR approved for § 1065.710(c).

(12) ASTM D1655-13a, Standard Specification for Aviation Turbine Fuels, approved December 1, 2013, IBR approved for § 1065.701(f).

(13) ASTM D1837-11, Standard Test Method for Volatility of Liquefied Petroleum (LP) Gases, approved October 1, 2011, IBR approved for § 1065.720(a).

(14) ASTM D1838-12a, Standard Test Method for Copper Strip Corrosion by Liquefied Petroleum (LP) Gases, approved December 1, 2012, IBR approved for § 1065.720(a).

(15) ASTM D1945-03 (Reapproved 2010), Standard Test Method for Analysis of Natural Gas by Gas Chromatography, approved January 1, 2010, IBR approved for § 1065.715(a).

(16) ASTM D2158-11, Standard Test Method for Residues in Liquefied Petroleum (LP) Gases, approved January 1, 2011, IBR approved for § 1065.720(a).

(17) ASTM D2163-07, Standard Test Method for Determination of Hydrocarbons in Liquefied Petroleum (LP) Gases and Propane/Propene Mixtures by Gas Chromatography, approved December 1, 2007, IBR approved for § 1065.720(a).

(18) ASTM D2598-12, Standard Practice for Calculation of Certain Physical Properties of Liquefied Petroleum (LP) Gases from Compositional Analysis, approved November 1, 2012, IBR approved for § 1065.720(a).

(19) ASTM D2622-10, Standard Test Method for Sulfur in Petroleum Products by Wavelength Dispersive X-ray Fluorescence Spectrometry, approved February 15, 2010, IBR approved for §§ 1065.703(b) and 1065.710(b) and (c).

(20) ASTM D2699-13b, Standard Test Method for Research Octane Number of Spark-Ignition Engine Fuel, approved October 1, 2013, IBR approved for § 1065.710(b).

(21) ASTM D2700-13b, Standard Test Method for Motor Octane Number of Spark-Ignition Engine Fuel, approved October 1, 2013, IBR approved for § 1065.710(b).

(22) ASTM D2713-13, Standard Test Method for Dryness of Propane (Valve Freeze Method), approved October 1, 2013, IBR approved for § 1065.720(a).

(23) ASTM D2784-11, Standard Test Method for Sulfur in Liquefied Petroleum Gases (Oxy-Hydrogen Burner or Lamp), approved January 1, 2011, IBR approved for § 1065.720(a).

(24) ASTM D2880-13b, Standard Specification for Gas Turbine Fuel Oils, approved November 15, 2013, IBR approved for § 1065.701(f).

(25) ASTM D2986-95a, Standard Practice for Evaluation of Air Assay Media by the Monodisperse DOP (Diethyl Phthalate) Smoke Test, approved September 10, 1995, IBR approved for § 1065.170(c). (Note: This standard was withdrawn by ASTM.)

(26) ASTM D3231–13, Standard Test Method for Phosphorus in Gasoline, approved June 15, 2013, IBR approved for § 1065.710(b) and (c).

(27) ASTM D3237–12, Standard Test Method for Lead in Gasoline By Atomic Absorption Spectroscopy, approved June 1, 2012, IBR approved for § 1065.710(b) and (c).

(28) ASTM D4052–11, Standard Test Method for Density, Relative Density, and API Gravity of Liquids by Digital Density Meter, approved October 15, 2011, IBR approved for § 1065.703(b).

(29) ASTM D4629–12, Standard Test Method for Trace Nitrogen in Liquid Petroleum Hydrocarbons by Syringe/ Inlet Oxidative Combustion and Chemiluminescence Detection, approved April 15, 2012, IBR approved for § 1065.655(d).

(30) ASTM D4814–13b, Standard Specification for Automotive Spark-Ignition Engine Fuel, approved December 1, 2013, IBR approved for § 1065.701(f).

(31) ASTM D4815–13, Standard Test Method for Determination of MTBE, ETBE, TAME, DIPE, tertiary-Amyl Alcohol and C<sub>1</sub> to C<sub>4</sub> Alcohols in Gasoline by Gas Chromatography, approved October 1, 2013, IBR approved for § 1065.710(b).

(32) ASTM D5186–03 (Reapproved 2009), Standard Test Method for Determination of the Aromatic Content and Polynuclear Aromatic Content of Diesel Fuels and Aviation Turbine Fuels By Supercritical Fluid Chromatography, approved April 15, 2009, IBR approved for § 1065.703(b).

(33) ASTM D5191–13, Standard Test Method for Vapor Pressure of Petroleum Products (Mini Method), approved December 1, 2013, IBR approved for § 1065.710(b) and (c).

(34) ASTM D5291–10, Standard Test Methods for Instrumental Determination of Carbon, Hydrogen, and Nitrogen in Petroleum Products and Lubricants, approved May 1, 2010, IBR approved for § 1065.655(d).

(35) ASTM D5453–12, Standard Test Method for Determination of Total Sulfur in Light Hydrocarbons, Spark Ignition Engine Fuel, Diesel Engine Fuel, and Engine Oil by Ultraviolet Fluorescence, approved November 1, 2012, IBR approved for § 1065.710(b).

(36) ASTM D5599–00 (Reapproved 2010), Standard Test Method for Determination of Oxygenates in Gasoline by Gas Chromatography and Oxygen Selective Flame Ionization Detection, approved October 1, 2010, IBR approved for §§ 1065.655(d) and 1065.710(b).

(37) ASTM D5762–12 Standard Test Method for Nitrogen in Petroleum and

Petroleum Products by Boat-Inlet Chemiluminescence, approved April 15, 2012, IBR approved for § 1065.655(d).

(38) ASTM D5769–10, Standard Test Method for Determination of Benzene, Toluene, and Total Aromatics in Finished Gasolines by Gas Chromatography/Mass Spectrometry, approved May 1, 2010, IBR approved for § 1065.710(b).

(39) ASTM D5797–13, Standard Specification for Fuel Methanol (M70-M85) for Automotive Spark-Ignition Engines, approved June 15, 2013, IBR approved for § 1065.701(f).

(40) ASTM D5798–13a, Standard Specification for Ethanol Fuel Blends for Flexible Fuel Automotive Spark-Ignition Engines, approved June 15, 2013, IBR approved for § 1065.701(f).

(41) ASTM D6550–10, Standard Test Method for Determination of Olefin Content of Gasolines by Supercritical-Fluid Chromatography, approved October 1, 2010, IBR approved for § 1065.710(b).

(42) ASTM D6615–11a, Standard Specification for Jet B Wide-Cut Aviation Turbine Fuel, approved October 1, 2011, IBR approved for § 1065.701(f).

(43) ASTM D6751–12, Standard Specification for Biodiesel Fuel Blend Stock (B100) for Middle Distillate Fuels, approved August 1, 2012, IBR approved for § 1065.701(f).

(44) ASTM D6985–04a, Standard Specification for Middle Distillate Fuel Oil—Military Marine Applications, approved November 1, 2004, IBR approved for § 1065.701(f). (Note: This standard was withdrawn by ASTM.)

(45) ASTM D7039–13, Standard Test Method for Sulfur in Gasoline, Diesel Fuel, Jet Fuel, Kerosine, Biodiesel, Biodiesel Blends, and Gasoline-Ethanol Blends by Monochromatic Wavelength Dispersive X-ray Fluorescence Spectrometry, approved September 15, 2013, IBR approved for § 1065.710(b).

(46) ASTM F1471–09, Standard Test Method for Air Cleaning Performance of a High-Efficiency Particulate Air Filter System, approved March 1, 2009, IBR approved for § 1065.1001.

(c) *California Air Resources Board material.* The following documents are available from the California Air Resources Board, Haagen-Smit Laboratory, 9528 Telstar Ave., El Monte, CA 91731–2908, (800) 242–4450, or <http://www.arb.ca.gov>:

(1) California Non-Methane Organic Gas Test Procedures, Amended July 30, 2002, Mobile Source Division, California Air Resources Board, IBR approved for § 1065.805(f).

(2) [Reserved]

(d) *Institute of Petroleum material.* The following documents are available from the Energy Institute, 61 New Cavendish St., London, W1G 7AR, UK, or by calling +44–(0)20–7467–7100, or at <http://www.energyinst.org>:

(1) IP–470, 2005, Determination of aluminum, silicon, vanadium, nickel, iron, calcium, zinc, and sodium in residual fuels by atomic absorption spectrometry, IBR approved for § 1065.705(b).

(2) IP–500, 2003, Determination of the phosphorus content of residual fuels by ultra-violet spectrometry, IBR approved for § 1065.705(b).

(3) IP–501, 2005, Determination of aluminum, silicon, vanadium, nickel, iron, sodium, calcium, zinc and phosphorus in residual fuel oil by ashing, fusion and inductively coupled plasma emission spectrometry, IBR approved for § 1065.705(b).

(e) *ISO material.* The following standards are available from the International Organization for Standardization, 1, ch. de la Voie-Creuse, CP 56, CH–1211 Geneva 20, Switzerland, 41–22–749–01–11, or <http://www.iso.org>:

(1) ISO 2719:2002, Determination of flash point—Pensky-Martens closed cup method, IBR approved for § 1065.705(c).

(2) ISO 3016:1994, Petroleum products—Determination of pour point, IBR approved for § 1065.705(c).

(3) ISO 3104:1994/Cor 1:1997, Petroleum products—Transparent and opaque liquids—Determination of kinematic viscosity and calculation of dynamic viscosity, IBR approved for § 1065.705(c).

(4) ISO 3675:1998, Crude petroleum and liquid petroleum products—Laboratory determination of density—Hydrometer method, IBR approved for § 1065.705(c).

(5) ISO 3733:1999, Petroleum products and bituminous materials—Determination of water—Distillation method, IBR approved for § 1065.705(c).

(6) ISO 6245:2001, Petroleum products—Determination of ash, IBR approved for § 1065.705(c).

(7) ISO 8217:2012(E), Petroleum products—Fuels (class F)—Specifications of marine fuels, Fifth edition, August 15, 2012, IBR approved for § 1065.705(b) and (c).

(8) ISO 8754:2003, Petroleum products—Determination of sulfur content—Energy-dispersive X-ray Fluorescence spectrometry, IBR approved for § 1065.705(c).

(9) ISO 10307–2(E):2009, Petroleum products—Total sediment in residual fuel oils—Part 2: Determination using standard procedures for ageing, Second Ed., February 1, 2009, as modified by

ISO 10307-2:2009/Cor.1:2010(E), Technical Corrigendum 1, published May 15, 2010, IBR approved for § 1065.705(c).

(10) ISO 10370:1993/Cor 1:1996, Petroleum products—Determination of carbon residue—Micro method, IBR approved for § 1065.705(c).

(11) ISO 10478:1994, Petroleum products—Determination of aluminium and silicon in fuel oils—Inductively coupled plasma emission and atomic absorption spectroscopy methods, IBR approved for § 1065.705(c).

(12) ISO 12185:1996/Cor 1:2001, Crude petroleum and petroleum products—Determination of density—Oscillating U-tube method, IBR approved for § 1065.705(c).

(13) ISO 14596:2007, Petroleum products—Determination of sulfur content—Wavelength-dispersive X-ray fluorescence spectrometry, IBR approved for § 1065.705(c).

(14) ISO 14597:1997, Petroleum products—Determination of vanadium and nickel content—Wavelength dispersive X-ray fluorescence spectrometry, IBR approved for § 1065.705(c).

(15) ISO 14644-1:1999, Cleanrooms and associated controlled environments, IBR approved for § 1065.190(b).

(f) *NIST material*. The following documents are available from National Institute of Standards and Technology, 100 Bureau Drive, Stop 1070, Gaithersburg, MD 20899-1070, (301) 975-6478, or [www.nist.gov](http://www.nist.gov):

(1) NIST Special Publication 811, 2008 Edition, Guide for the Use of the International System of Units (SI), March 2008, IBR approved for §§ 1065.20(a) and 1065.1005.

(2) NIST Technical Note 1297, 1994 Edition, Guidelines for Evaluating and Expressing the Uncertainty of NIST Measurement Results, IBR approved for § 1065.1001.

(g) *SAE International material*. The following standards are available from SAE International, 400 Commonwealth Dr., Warrendale, PA 15096-0001, (724) 776-4841, or <http://www.sae.org>:

(1) SAE 770141, 1977, Optimization of Flame Ionization Detector for Determination of Hydrocarbon in Diluted Automotive Exhausts, Glenn D. Reschke, IBR approved for § 1065.360(c).

(2) SAE J1151, Methane Measurement Using Gas Chromatography, stabilized September 2011, IBR approved for §§ 1065.267(b) and 1065.750(a).

■ 330. A new subpart L consisting of § 1065.1101 through § 1065.1111 is added to part 1065 to read as follows:

#### Subpart L—Methods for Unregulated and Special Pollutants

Sec.

1065.1101 Applicability.

Semi-Volatile Organic Compounds

1065.1103 General provisions for SVOC measurement.

1065.1105 Sampling system design.

1065.1107 Sample media and sample system preparation; sampler assembly.

1065.1109 Post-test sampler disassembly and sample extraction.

1065.1111 Sample analysis.

#### Subpart L—Methods for Unregulated and Special Pollutants

##### § 1065.1101 Applicability.

This subpart specifies procedures that may be used to measure emission constituents that are not measured (or not separately measured) by the test procedures in the other subparts of this part. These procedures are included to facilitate consistent measurement of unregulated pollutants for purposes other than compliance with emission standards. Unless otherwise specified in the standard-setting part, use of these procedures is optional and does not replace any requirements in the rest of this part.

Semi-Volatile Organic Compounds

##### § 1065.1103 General provisions for SVOC measurement.

The provisions of §§ 1065.1103 through 1065.1111 specify procedures for measuring semi-volatile organic compounds (SVOC) along with PM. These sections specify how to collect a sample of the SVOCs during exhaust emission testing, as well as how to use wet chemistry techniques to extract SVOCs from the sample media for analysis. Note that the precise method you use will depend on the category of SVOCs being measured. For example, the method used to measure polynuclear aromatic hydrocarbons (PAHs) will differ slightly from the method used to measure dioxins. Follow standard analytic chemistry methods for any aspects of the analysis that are not specified.

(a) Laboratory cleanliness is especially important throughout SVOC testing. Thoroughly clean all sampling system components and glassware before testing to avoid sample contamination. For the purposes of this subpart, the sampling system is defined as sample pathway from the sample probe inlet to the downstream most point where the sample is captured (in this case the condensate trap).

(b) We recommend that media blanks be analyzed for each batch of sample media (sorber, filters, etc.) prepared for testing. Blank sorber modules (i.e.,

field blanks) should be stored in a sealed environment and should periodically accompany the test sampling system throughout the course of a test, including sampling system and sorber module disassembly, sample packaging, and storage. Use good engineering judgment to determine the frequency with which you should generate field blanks. The field blank sample should be close to the sampler during testing.

(c) We recommend the use of isotope dilution techniques, including the use of isotopically labeled surrogate, internal, alternate, and injection standards.

(d) If your target analytes degrade when exposed to ultraviolet radiation, such as nitropolynuclear aromatic hydrocarbons (nPAHs), perform these procedures in the dark or with ultraviolet filters installed over the lights.

(e) The following definitions and abbreviations apply for SVOC measurements:

(1) *Soxhlet extraction* means the extraction method invented by Franz von Soxhlet, in which the sample is placed in a thimble and rinsed repeatedly with a recycle of the extraction solvent.

(2) *XAD-2* means a hydrophobic crosslinked polystyrene copolymer resin adsorbent known commercially as Amberlite® XAD®-2, or an equivalent adsorbent like XAD-4.

(3) *Semi-volatile organic compound (SVOC)* means an organic compound that is sufficiently volatile to exist in vapor form in engine exhaust, but that readily condenses to liquid or solid form under atmospheric conditions. Most SVOCs have at least 14 carbon atoms per molecule or they have a boiling point between (240 and 400) °C. SVOCs include dioxin, quinone, and nitro-PAH compounds. They may be a natural byproduct of combustion or they may be created post-combustion. Note that SVOCs may be included in measured values of hydrocarbons and/or PM using the procedures specified in this part.

(4) *Kuderna-Danish concentrator* means laboratory glassware known by this name that consists of an air-cooled condenser on top of an extraction bulb.

(5) *Dean-Stark trap* means laboratory glassware known by this name that uses a reflux condenser to collect water from samples extracted under reflux.

(6) *PUF* means polyurethane foam.

(7) *Isotopically labeled* means relating to a compound in which either all the hydrogen atoms are replaced with the atomic isotope hydrogen-2 (deuterium) or one of the carbon atoms at a defined

position in the molecule is replaced with the atomic isotope carbon-13.

#### § 1065.1105 Sampling system design.

(a) *General.* We recommend that you design your SVOC batch sampler to extract sample from undiluted emissions to maximize the sampled SVOC quantity. To the extent practical, adjust sampling times based on the emission rate of target analytes from the engine to obtain analyte concentrations above the detection limit. In some instances you may need to run repeat test cycles without replacing the sample media or disassembling the batch sampler.

(b) *Sample probe, transfer lines, and sample media holder design and construction.* The sampling system should consist of a sample probe, transfer line, PM filter holder, cooling coil, sorbent module, and condensate trap. Construct sample probes, transfer lines, and sample media holders that have inside surfaces of nickel, titanium or another nonreactive material capable of withstanding raw exhaust gas temperatures. Seal all joints in the hot zone of the system with gaskets made of nonreactive material similar to that of the sampling system components. You may use teflon gaskets in the cold zone. We recommend locating all components as close to probes as practical to shorten sampling system length and minimize the surface exposed to engine exhaust.

(c) *Sample system configuration.* This paragraph (c) specifies the components necessary to collect SVOC samples, along with our recommended design parameters. Where you do not follow our recommendations, use good engineering judgment to design your sampling system so it does not result in loss of SVOC during sampling. The sampling system should contain the following components in series in the order listed:

(1) Use a sample probe similar to the PM sample probe specified in subpart B of this part.

(2) Use a PM filter holder similar to the holder specified in subpart B of this part, although you will likely need to use a larger size to accommodate the high sample flow rates. We recommend using a 110 mm filter for testing spark ignition engines or engines that utilize exhaust aftertreatment for PM removal and a 293 mm filter for other engines. If you are not analyzing separately for SVOCs in gas and particle phases, you do not have to control the temperature of the filter holder. Note that this differs from normal PM sampling procedures, which maintain the filter at a much lower temperature to capture a significant fraction of exhaust SVOC on

the filter. In this method, SVOCs that pass through the filter will be collected on the downstream sorbent module. If you are collecting SVOCs in gas and particle phases, control your filter face temperature according to § 1065.140(e)(4).

(3) Use good engineering judgment to design a cooling coil that will drop the sample temperature to approximately 5 °C. Note that downstream of the cooling coil, the sample will be a mixture of vapor phase hydrocarbons in CO<sub>2</sub>, air, and a primarily aqueous liquid phase.

(4) Use a hydrophobic sorbent in a sealed sorbent module. Note that this sorbent module is intended to be the final stage for collecting the SVOC sample and should be sized accordingly. We recommend sizing the module to hold 40 g of XAD-2 along with PUF plugs at either end of the module, noting that you may vary the mass of XAD used for testing based on the anticipated SVOC emission rate.

(5) Include a condensate trap to separate the aqueous liquid phase from the gas stream. We recommend using a peristaltic pump to remove water from the condensate trap over the course of the test to prevent build-up of the condensate. Note that for some tests it may be appropriate to collect this water for analysis.

(d) *Sampler flow control.* For testing using the recommended filter and sorbent module sizes, we recommend targeting an average sample flow rate of 70 liters per minute to maximize SVOC collection. The sampler must be designed to maintain proportional sampling throughout the test. Verify proportional sampling after an emission test as described in § 1065.545.

(e) *Water bath.* Design the sample system with a water bath in which the cooling coil, sorbent module, and condensate trap will be submerged. Use a heat exchanger or ice to maintain the bath temperature at (3 to 7) °C.

#### § 1065.1107 Sample media and sample system preparation; sample system assembly.

This section describes the appropriate types of sample media and the cleaning procedure required to prepare the media and wetted sample surfaces for sampling.

(a) *Sample media.* The sampling system uses two types of sample media in series: The first to simultaneously capture the PM and associated particle phase SVOCs, and a second to capture SVOCs that remain in the gas phase, as follows:

(1) For capturing PM, we recommend using pure quartz filters with no binder. Select the filter diameter to minimize

filter change intervals, accounting for the expected PM emission rate, sample flow rate, and number of repeat tests. Note that when repeating test cycles to increase sample mass, you may replace the filter without replacing the sorbent or otherwise disassembling the batch sampler. In those cases, include all filters in the extraction.

(2) For capturing gaseous SVOCs, utilize XAD-2 resin contained between two PUF plugs.

(b) *Sample media and sampler preparation.* Prepare pre-cleaned PM filters and pre-cleaned PUF plugs/XAD-2 as needed. Store sample media in containers protected from light and ambient air if you do not use them immediately after cleaning.

(1) Pre-clean the filters via Soxhlet extraction with methylene chloride for 24 hours and dry over dry nitrogen in a low-temperature vacuum oven.

(2) Pre-clean PUF and XAD-2 with a series of Soxhlet extractions: 8 hours with water, 22 hours with methanol, 22 hours with methylene chloride, and 22 hours with toluene, followed by drying with nitrogen.

(3) Clean sampler components, including the probe, filter holder, condenser, sorbent module, and condensate collection vessel by rinsing three times with methylene chloride and then three times with toluene. Prepare pre-cleaned aluminum foil for capping the probe inlet of the sampler after the sampling system has been assembled.

(c) *Sorbent spiking.* Use good engineering judgment to verify the extent to which your extraction methods recover SVOCs absorbed on the sample media. We recommend spiking the XAD-2 resin with a surrogate standard before testing with a carbon-13 or hydrogen-2 isotopically labeled standard for each of the class of analytes targeted for analysis. Perform this spiking as follows:

(1) Insert the lower PUF plug into the bottom of the sorbent module.

(2) Add half of one portion of XAD-2 resin to the module and spike the XAD-2 in the module with the standard.

(3) Wait 1 hour for the solvent from the standard(s) to evaporate, add the remaining 20 g of the XAD-2 resin to the module, and then insert a PUF plug in the top of the sorbent module.

(4) Cover the inlet and outlet of the sorbent module with pre-cleaned aluminum foil.

(d) *Sampling system assembly.* After preparing the sample media and the sampler, assemble the condensate trap, cooling coil, filter holder with filter, sample probe, and sorbent module, then

lower the assembly into the reservoir. Cover the probe inlet with pre-cleaned aluminum foil.

**§ 1065.1109 Post-test sampler disassembly and sample extraction.**

This section describes the process for disassembling and rinsing the sampling system and extracting and cleaning up the sample.

*(a) Sampling system disassembly.*

Disassemble the sampling system in a clean environment as follows after the test:

(1) Remove the PM filter, PUF plugs, and all the XAD-2 from the sampling system and place them into a Soxhlet extraction thimble. Store them at or below 37 °C until analysis.

(2) Rinse sampling system wetted surfaces upstream of the condensate trap with acetone followed by toluene (or a comparable solvent system), ensuring that all the solvent remaining in liquid phase is collected (note that a fraction of the acetone and toluene will likely be lost to evaporation during mixing). Rinse with solvent volumes that are sufficient to cover all the surfaces exposed to the sample during testing. We recommend three fresh solvent rinses with acetone and two with toluene. We recommend rinse volumes of 60 ml per rinse for all sampling system components except the condenser coil, of which you should use 200 ml per rinse. Keep the acetone rinsate separate from the toluene rinsate to the extent practicable. Rinsate fractions should be stored separately in glass bottles that have been pre-rinsed with acetone, hexane, and toluene (or purchase pre-cleaned bottles).

(3) Use good engineering judgment to determine if you should analyze the aqueous condensate phase for SVOCs. If you determine that analysis is necessary, use toluene to perform a liquid-liquid extraction of the SVOCs from the collected aqueous condensate using a separatory funnel or an equivalent method. Add the toluene from this aqueous extraction to the toluene rinsate fraction described in paragraph (a)(2) of this section.

(4) Reduce rinsate solvent volumes as needed using a Kuderna-Danish concentrator or rotary evaporator and retain these rinse solvents for reuse during sample media extraction for the same test. Be careful to avoid loss of low molecular weight analytes when concentrating with rotary evaporation.

*(b) Sample extraction.* Extract the SVOCs from the sorbent using Soxhlet extraction as described in this paragraph (b). Two 16 hour extractions are necessary to accommodate the Soxhlet extractions of all SVOCs from a single

sample. This reduces the possibility of losing low molecular weight SVOCs and promotes water removal. We recommend performing the first extraction with acetone/hexane and the second using toluene (or an equivalent solvent system). You may alternatively use an equivalent method such as an automated solvent extractor.

(1) We recommend equipping the Soxhlet extractor with a Dean-Stark trap to facilitate removal of residual water from the sampling system rinse. The Soxhlet apparatus must be large enough to allow extraction of the PUF, XAD-2, and filter in a single batch. Include in the extractor setup a glass thimble with a coarse or extra coarse sintered glass bottom. Pre-clean the extractor using proper glass-cleaning procedures. We recommend that the Soxhlet apparatus be cleaned with a (4 to 8) hour Soxhlet extraction with methylene chloride at a cycling rate of three cycles per hour. Discard the solvent used for pre-cleaning (no analysis is necessary).

(2) Load the extractor thimble before placing it in the extractor by first rolling the PM filter around the inner circumference of the thimble, with the sampled side facing in. Push one PUF plug down into the bottom of the thimble, add approximately half of the XAD-2, and then spike the XAD-2 in the thimble with the isotopically labeled extraction standards of known mass. Target the center of the XAD-2 bed for delivering the extraction standard. We recommend using multiple isotopically labeled extraction standards that cover the range of target analytes. This generally means that you should use isotopically labeled standards at least for the lowest and highest molecular weight analytes for each category of compounds (such as PAHs and dioxins). These extraction standards monitor the efficiency of the extraction and are also used to determine analyte concentrations after analysis. Upon completion of spiking, add the remaining XAD-2 to the thimble, insert the remaining PUF plug, and place the thimble into the extractor. Note that if you are collecting and analyzing for SVOCs in gas and particle phases, perform separate extractions for the filter and XAD-2.

(3) For the initial extraction, combine the concentrated acetone rinses (from the sampling system in paragraph (a) of this section) with enough hexane to bring the solvent volume up to the target level of 700 ml. Assemble the extractor and turn on the heating controls and cooling water. Allow the sample to reflux for 16 hours with the rheostat adjusted to cycle the extraction at a rate of (3.0 ± 0.5) cycles per hour. Drain the

water from the Dean-Stark trap as it accumulates by opening the stopcock on the trap. Set aside the water for analysis or discard it. In most cases, any water present will be removed within approximately 2 hours after starting the extraction.

(4) After completing the initial extraction, remove the solvent and concentrate it to (4.0 ± 0.5) ml using a Kuderna-Danish concentrator that includes a condenser such as a three-ball Snyder column with venting dimples and a graduated collection tube. Using this concentrator will minimize evaporative loss of analytes with lower molecular weight.

(i) Rinse the round bottom flask of the extractor with (60 to 100) ml of hexane and add the rinsate to this concentrated extract.

(ii) Concentrate the mixture to (4 ± 0.5) ml using a Kuderna-Danish concentrator or similar apparatus.

(iii) Repeat the steps in paragraphs (b)(4)(i) and (ii) of this section three times, or as necessary to remove all the residual solvent from the round bottom flask of the extractor, concentrating the final rinsate to (4 ± 0.5) ml.

(5) For the second extraction, combine the toluene rinses (from the sampling system in paragraph (a) of this section) with any additional toluene needed to bring the solvent volume up to the target level of 700 ml. As noted in paragraph (a) of this section, you may need to concentrate the rinsate before adding it to the extraction apparatus if the rinsate solvent volume is too large. Allow the sample to reflux for 16 hours with the rheostat adjusted to cycle the extraction at a rate of (3.0 ± 0.5) cycles per hour. Check the Dean-Stark trap for water during the first 2 hours of the extraction (though little or no water should be present during this stage).

(6) Upon completion of the second extraction, remove the solvent and concentrate it to (4 ± 0.5) ml as described in paragraph (b)(4) of this section. Using hexane from paragraph (b)(4) of this section as the rinse solvent effectively performs a solvent exchange of toluene with hexane.

(7) Combine the concentrated extract from paragraph (b)(4) of this section with the concentrated extract from paragraph (b)(6) of this section. Divide the extract into a number of fractions based on the number of analyses you need to perform. Perform the separate sample clean-up described in paragraph (c) of this section as needed for each fraction.

*(c) Sample clean-up.* This paragraph (c) describes how to perform sample cleaning to remove from the sample extract any solids and any SVOCs that



will not be analyzed. This process, known as “sample clean-up”, reduces the potential for interference or co-elution of peaks during analytical analysis. Before performing the sample clean-up, spike the extract with an alternate standard that contains a known mass of isotopically labeled compounds that are identical to the target analytes (except for the labeling). The category of the target analyte compounds (such as PAHs or dioxin) will determine the number of compounds that make up the standard. For example, PAHs require the use of four compounds in the alternate standard to cover the four basic ring structures of PAHs (2-ring, 3-ring, 4-ring, and 5-ring structures). These alternate standards are used to monitor the efficiency of the clean-up procedure. Before sample clean-up, concentrate the fractionated sample to about 2 ml with a Kuderna-Danish concentrator or rotary evaporator, and then transfer the extract to an 8 ml test tube with hexane rinse. Concentrate it to a volume of about 1 ml using a Kuderna-Danish concentrator. Use good engineering judgment to select an appropriate column chromatographic clean-up option for your target analytes. Note that these clean-up techniques generally remove compounds based on their polarity. The following procedures are examples of clean-up techniques for PAHs and nPAHs.

(1) *PAH clean-up.* The following method is appropriate for clean-up of extracts intended for analysis of PAHs:

(i) Pack a glass gravity column (250 mm x 10 mm recommended) by inserting a clean glass wool plug into the bottom of the column and add 10 g of activated silica gel in methylene chloride. Tap the column to settle the silica gel and then add a 1 cm layer of anhydrous sodium sulfate. Verify the volume of solvent required to completely elute all the PAHs and adjust the weight of the silica gel accordingly to account for variations among batches of silica gel that may affect the elution volume of the various PAHs.

(ii) Elute the column with 40 ml of hexane. The rate for all elutions should be about 2 ml/min. You may increase the elution rate by using dry air or nitrogen to maintain the headspace slightly above atmospheric pressure. Discard the eluate just before exposing the sodium sulfate layer to the air or nitrogen and transfer the 1 ml sample extract onto the column using two additional 2 ml rinses of hexane. Just before exposing the sodium sulfate layer to the air or nitrogen, begin elution of the column with 25 ml of hexane followed by 25 ml of 40 volume %

methylene chloride in hexane. Collect the entire eluate and concentrate it to about 5 ml using the Kuderna-Danish concentrator or a rotary evaporator. Make sure not to evaporate all the solvent from the extract during the concentration process. Transfer the eluate to a small sample vial using a hexane rinse and concentrate it to 100 µl using a stream of nitrogen without violently disturbing the solvent. Store the extracts in a refrigerator at or below 4 °C, and away from light.

(2) *nPAH clean up.* The following procedure, adapted from “Determination and Comparison of Nitrated-Polycyclic Aromatic Hydrocarbons Measured in Air and Diesel Particulate Reference Materials” (Bamford, H.A., *et al*, Chemosphere, Vol. 50, Issue 5, pages 575–587), is an appropriate method to clean up extracts intended for analysis of nPAHs:

(i) Condition an aminopropyl solid phase extraction (SPE) cartridge by eluting it with 20 ml of 20 volume % methylene chloride in hexane. Transfer the extract quantitatively to the SPE cartridge with at least two methylene chloride rinses. Elute the extract through the SPE cartridge by using 40 ml of 20 volume % methylene chloride in hexane to minimize potential interference of polar constituents, and then reduce the extract to 0.5 ml in hexane and subject it to normal-phase liquid chromatography using a pre-prepared 9.6 mm x 25 cm semi-preparative Chromegabond® amino/cyano column (5 µm particle size) to isolate the nPAH fraction. The mobile phase is 20 volume % methylene chloride in hexane at a constant flow rate of 5 ml per minute. Back-flash the column with 60 ml of methylene chloride and then condition it with 200 ml of 20 volume % methylene chloride in hexane before each injection. Collect the effluent and concentrate it to about 2 ml using the Kuderna-Danish concentrator or a rotary evaporator. Transfer it to a minivial using a hexane rinse and concentrate it to 100 µl using a gentle stream of nitrogen. Store the extracts at or below 4 °C, and away from light.

(ii) [Reserved]

#### § 1065.1111 Sample analysis.

This subpart does not specify chromatographic or analytical methods to analyze extracts, because the appropriateness of such methods is highly dependent on the nature of the target analytes. However, we recommend that you spike the extract with an injection standard that contains a known mass of an isotopically labeled compound that is identical to one of the

target analytes (except for labeling). This injection standard allows you to monitor the efficiency of the analytical process by verifying the volume of sample injected for analysis.

■ 331. Part 1066 is revised to read as follows:

### PART 1066—VEHICLE-TESTING PROCEDURES

#### Subpart A—Applicability and General Provisions

Sec.

- 1066.1 Applicability.
- 1066.2 Submitting information to EPA under this part.
- 1066.5 Overview of this part 1066 and its relationship to the standard-setting part.
- 1066.10 Other procedures.
- 1066.15 Overview of test procedures.
- 1066.20 Units of measure and overview of calculations.
- 1066.25 Recordkeeping.

#### Subpart B—Equipment, Measurement Instruments, Fuel, and Analytical Gas Specifications

- 1066.101 Overview.
- 1066.105 Ambient controls and vehicle cooling fans.
- 1066.110 Equipment specifications for emission sampling systems.
- 1066.120 Measurement instruments.
- 1066.125 Data updating, recording, and control.
- 1066.130 Measurement instrument calibrations and verifications.
- 1066.135 Linearity verification.
- 1066.140 Diluted exhaust flow calibration.
- 1066.145 Test fuel, engine fluids, analytical gases, and other calibration standards.
- 1066.150 Analyzer interference and quench verification limit.

#### Subpart C—Dynamometer Specifications

- 1066.201 Dynamometer overview.
- 1066.210 Dynamometers.
- 1066.215 Summary of verification procedures for chassis dynamometers.
- 1066.220 Linearity verification for chassis dynamometer systems.
- 1066.225 Roll runout and diameter verification procedure.
- 1066.230 Time verification procedure.
- 1066.235 Speed verification procedure.
- 1066.240 Torque transducer verification.
- 1066.245 Response time verification.
- 1066.250 Base inertia verification.
- 1066.255 Parasitic loss verification.
- 1066.260 Parasitic friction compensation evaluation.
- 1066.265 Acceleration and deceleration verification.
- 1066.270 Unloaded coastdown verification.
- 1066.275 Daily dynamometer readiness verification.
- 1066.290 Verification of speed accuracy for the driver’s aid.

#### Subpart D—Coastdown

- 1066.301 Overview of coastdown procedures.
- 1066.305 Coastdown procedures for motor vehicles at or below 14,000 pounds GVWR.

- 1066.310 Coastdown procedures for vehicles above 14,000 pounds GVWR.  
1066.315 Dynamometer road-load setting.

#### Subpart E—Preparing Vehicles and Running an Exhaust Emission Test

- 1066.401 Overview.  
1066.405 Vehicle preparation and preconditioning.  
1066.410 Dynamometer test procedure.  
1066.415 Vehicle operation.  
1066.420 Test preparation.  
1066.425 Performing emission tests.

#### Subpart F—Electric Vehicles and Hybrid Electric Vehicles

- 1066.501 Overview.

#### Subpart G—Calculations

- 1066.601 Overview.  
1066.605 Mass-based and molar-based exhaust emission calculations.  
1066.610 Dilution air background correction.  
1066.615 NO<sub>x</sub> intake-air humidity correction.  
1066.620 Removed water correction.  
1066.625 Flow meter calibration calculations.  
1066.630 PDP, SSV, and CFV flow rate calculations.  
1066.635 NMOG determination.  
1066.695 Data requirements.

#### Subpart H—Cold Temperature Test Procedures

- 1066.701 Applicability and general provisions.  
1066.710 Cold temperature testing procedures for measuring CO and NMHC emissions and determining fuel economy.

#### Subpart I—Exhaust Emission Test Procedures for Motor Vehicles

- 1066.801 Applicability and general provisions.  
1066.805 Road-load power, test weight, and inertia weight class determination.  
1066.810 Vehicle preparation.  
1066.815 Exhaust emission test procedures for FTP testing.  
1066.816 Vehicle preconditioning for FTP testing.  
1066.820 Composite calculations for FTP exhaust emissions.  
1066.830 Supplemental Federal Test Procedures; overview.  
1066.831 Exhaust emission test procedures for aggressive driving.  
1066.835 Exhaust emission test procedure for SC03 emissions.  
1066.840 Highway fuel economy test procedure.  
1066.845 AC17 air conditioning efficiency test procedure.

#### Subpart J—Evaporative Emission Test Procedures

- 1066.901 Applicability and general provisions.  
Test Equipment and Calculations for Evaporative and Refueling Emissions  
1066.910 SHED enclosure specifications.  
1066.915 Enclosures; auxiliary systems and equipment.  
1066.920 Enclosure calibrations.

- 1066.925 Enclosure calculations for evaporative and refueling emissions.  
1066.930 Equipment for point-source measurement of running losses.  
Evaporative and Refueling Emission Test Procedures for Motor Vehicles  
1066.950 Fuel temperature profile.  
1066.955 Diurnal emission test.  
1066.960 Running loss test.  
1066.965 Hot soak test.  
1066.970 Refueling test for liquid fuels.  
1066.971 Vehicle and canister preconditioning for the refueling test.  
1066.975 Refueling test for LPG.  
1066.980 Fuel dispensing spitback procedure.  
1066.985 Fuel storage system leak test procedure.

#### Subpart K—Definitions and Other Reference Material

- 1066.1001 Definitions.  
1066.1005 Symbols, abbreviations, acronyms, and units of measure.  
1066.1010 Incorporation by reference.

Authority: 42 U.S.C. 7401–7671q.

#### Subpart A—Applicability and General Provisions

##### § 1066.1 Applicability.

(a) This part describes the emission measurement procedures that apply to testing we require for the following vehicles:

(1) Model year 2014 and later heavy-duty highway vehicles we regulate under 40 CFR part 1037 that are not subject to chassis testing for exhaust emissions under 40 CFR part 86.

(2) Model year 2022 and later motor vehicles (light-duty and heavy-duty) that are subject to chassis testing for exhaust emissions under 40 CFR part 86, other than highway motorcycles. See 40 CFR part 86 for provisions describing how to implement this part 1066.

(b) The procedures of this part may apply to other types of vehicles, as described in this part and in the standard-setting part.

(c) The testing in this part 1066 is designed for measuring exhaust, evaporative, and refueling emissions. Procedures for measuring evaporative and refueling emissions for motor vehicles are in some cases integral with exhaust measurement procedures as described in § 1066.801. Subpart J of this part describes provisions that are unique to evaporative and refueling emission measurements. Other subparts in this part are written with a primary focus on measurement of exhaust emissions.

(d) The term “you” means anyone performing testing under this part other than EPA.

(1) This part is addressed primarily to manufacturers of vehicles, but it applies equally to anyone who does testing under this part for such manufacturers.

(2) This part applies to any manufacturer or supplier of test equipment, instruments, supplies, or any other goods or services related to the procedures, requirements, recommendations, or options in this part.

(e) Paragraph (a) of this section identifies the parts of the CFR that define emission standards and other requirements for particular types of vehicles. In this part, we refer to each of these other parts generically as the “standard-setting part.” For example, 40 CFR part 1037 is the standard-setting part for heavy-duty highway vehicles and parts 86 and 600 are the standard-setting parts for light-duty vehicles. For vehicles subject to 40 CFR part 86, subpart S, treat subpart I and subpart J of this part as belonging to 40 CFR part 86. This means that references to the standard-setting part include subpart I and subpart J of this part.

(f) Unless we specify otherwise, the terms “procedures” and “test procedures” in this part include all aspects of vehicle testing, including the equipment specifications, calibrations, calculations, and other protocols and procedural specifications needed to measure emissions.

(g) For additional information regarding these test procedures, visit our Web site at [www.epa.gov](http://www.epa.gov), and in particular <http://www.epa.gov/nvfel/testing/regulations.htm>.

##### § 1066.2 Submitting information to EPA under this part.

(a) You are responsible for statements and information in your applications for certification, requests for approved procedures, selective enforcement audits, laboratory audits, production-line test reports, or any other statements you make to us related to this part 1066. If you provide statements or information to someone for submission to EPA, you are responsible for these statements and information as if you had submitted them to EPA yourself.

(b) In the standard-setting part and in 40 CFR 1068.101, we describe your obligation to report truthful and complete information and the consequences of failing to meet this obligation. See also 18 U.S.C. 1001 and 42 U.S.C. 7413(c)(2). This obligation applies whether you submit this information directly to EPA or through someone else.

(c) We may void any certificates or approvals associated with a submission of information if we find that you intentionally submitted false, incomplete, or misleading information. For example, if we find that you intentionally submitted incomplete

information to mislead EPA when requesting approval to use alternate test procedures, we may void the certificates for all engine families certified based on emission data collected using the alternate procedures. This would also apply if you ignore data from incomplete tests or from repeat tests with higher emission results.

(d) We may require an authorized representative of your company to approve and sign the submission, and to certify that all the information submitted is accurate and complete. This includes everyone who submits information, including manufacturers and others.

(e) See 40 CFR 1068.10 for provisions related to confidential information. Note however that under 40 CFR 2.301, emission data are generally not eligible for confidential treatment.

(f) Nothing in this part should be interpreted to limit our ability under Clean Air Act section 208 (42 U.S.C. 7542) to verify that vehicles conform to the regulations.

#### § 1066.5 Overview of this part 1066 and its relationship to the standard-setting part.

(a) This part specifies procedures that can apply generally to testing various categories of vehicles. See the standard-setting part for directions in applying specific provisions in this part for a particular type of vehicle. Before using this part's procedures, read the standard-setting part to answer at least the following questions:

(1) What drive schedules must I use for testing?

(2) Should I warm up the test vehicle before measuring emissions, or do I need to measure cold-start emissions during a warm-up segment of the duty cycle?

(3) Which exhaust constituents do I need to measure? Measure all exhaust constituents that are subject to emission standards, any other exhaust constituents needed for calculating emission rates, and any additional exhaust constituents as specified in the standard-setting part. See 40 CFR 1065.5 regarding requests to omit measurement of N<sub>2</sub>O and CH<sub>4</sub> for vehicles not subject to an N<sub>2</sub>O or CH<sub>4</sub> emission standard.

(4) Do any unique specifications apply for test fuels?

(5) What maintenance steps may I take before or between tests on an emission-data vehicle?

(6) Do any unique requirements apply to stabilizing emission levels on a new vehicle?

(7) Do any unique requirements apply to test limits, such as ambient temperatures or pressures?

(8) What requirements apply for evaporative and refueling emissions?

(9) Are there any emission standards specified at particular operating conditions or ambient conditions?

(10) Do any unique requirements apply for durability testing?

(b) The testing specifications in the standard-setting part may differ from the specifications in this part. In cases where it is not possible to comply with both the standard-setting part and this part, you must comply with the specifications in the standard-setting part. The standard-setting part may also allow you to deviate from the procedures of this part for other reasons.

(c) The following table shows how this part divides testing specifications into subparts:

TABLE 1 OF § 1066.5—DESCRIPTION OF PART 1066 SUBPARTS

This subpart	Describes these specifications or procedures
Subpart A ....	Applicability and general provisions.
Subpart B ....	Equipment for testing.
Subpart C ....	Dynamometer specifications.
Subpart D ....	Coastdowns for testing.
Subpart E ....	How to prepare your vehicle and run an emission test.
Subpart F ....	How to test electric vehicles and hybrid electric vehicles.
Subpart G ....	Test procedure calculations.
Subpart H ....	Cold temperature testing.
Subpart I .....	Exhaust emission test procedures for motor vehicles.
Subpart J .....	Evaporative and refueling emission test procedures.
Subpart K ....	Definitions and reference material.

#### § 1066.10 Other procedures.

(a) *Your testing.* The procedures in this part apply for all testing you do to show compliance with emission standards, with certain exceptions noted in this section. In some other sections in this part, we allow you to use other procedures (such as less precise or less accurate procedures) if they do not affect your ability to show that your vehicles comply with the applicable emission standards. This generally requires emission levels to be far enough below the applicable emission standards so that any errors caused by greater imprecision or inaccuracy do not affect your ability to state unconditionally that the engines meet all applicable emission standards.

(b) *Our testing.* These procedures generally apply for testing that we do to determine if your vehicles comply with applicable emission standards. We may perform other testing as allowed by the Act.

(c) *Exceptions.* We may allow or require you to use procedures other than

those specified in this part as described in 40 CFR 1065.10(c). All the test procedures noted as exceptions to the specified procedures are considered generically as "other procedures." Note that the terms "special procedures" and "alternate procedures" have specific meanings; "special procedures" are those allowed by 40 CFR 1065.10(c)(2) and "alternate procedures" are those allowed by 40 CFR 1065.10(c)(7). If we require you to request approval to use other procedures under this paragraph (c), you may not use them until we approve your request.

#### § 1066.15 Overview of test procedures.

This section outlines the procedures to test vehicles that are subject to emission standards.

(a) The standard-setting part describes the emission standards that apply. Evaporative and refueling emissions are generally in the form of grams total hydrocarbon equivalent per test. We set exhaust emission standards in g/mile (or g/km), for the following constituents:

- (1) Total oxides of nitrogen, NO<sub>x</sub>.
- (2) Hydrocarbons, HC, which may be expressed in the following ways:
  - (i) Total hydrocarbons, THC.
  - (ii) Nonmethane hydrocarbons, NMHC, which results from subtracting methane, CH<sub>4</sub>, from THC.
  - (iii) Total hydrocarbon-equivalent, THCE, which results from adjusting THC mathematically to be equivalent on a carbon-mass basis.
  - (iv) Nonmethane hydrocarbon-equivalent, NMHCE, which results from adjusting NMHC mathematically to be equivalent on a carbon-mass basis.

(v) Nonmethane organic gases, NMOG, which are calculated either from fully or partially speciated measurement of hydrocarbons including oxygenates, or by adjusting measured NMHC values based on fuel oxygenate properties.

- (3) Particulate matter, PM.
- (4) Carbon monoxide, CO.
- (5) Carbon dioxide, CO<sub>2</sub>.
- (6) Methane, CH<sub>4</sub>.
- (7) Nitrous oxide, N<sub>2</sub>O.
- (8) Formaldehyde, CH<sub>2</sub>O.

(b) Note that some vehicles may not be subject to standards for all the exhaust emission constituents identified in paragraph (a) of this section. Note also that the standard-setting part may include standards for pollutants not listed in paragraph (a) of this section.

(c) The provisions of this part apply for chassis dynamometer testing where vehicle speed is controlled to follow a prescribed duty cycle while simulating vehicle driving through the dynamometer's road-load settings. We generally set exhaust emission

standards over test intervals and/or drive schedules, as follows:

(1) *Vehicle operation.* Testing involves measuring emissions and miles travelled while operating the vehicle on a chassis dynamometer. Refer to the definitions of “duty cycle” and “test interval” in § 1066.1001. Note that a single drive schedule may have multiple test intervals and require weighting of results from multiple test intervals to calculate a composite distance-based emission value to compare to the standard.

(2) *Constituent determination.* Determine the total mass of each exhaust constituent over a test interval by selecting from the following methods:

(i) *Continuous sampling.* In continuous sampling, measure the exhaust constituent’s concentration continuously from raw or dilute exhaust. Multiply this concentration by the continuous (raw or dilute) flow rate at the emission sampling location to determine the constituent’s flow rate. Sum the constituent’s flow rate continuously over the test interval. This sum is the total mass of the emitted constituent.

(ii) *Batch sampling.* In batch sampling, continuously extract and store a sample of raw or dilute exhaust for later measurement. Extract a sample proportional to the raw or dilute exhaust flow rate, as applicable. You may extract and store a proportional sample of exhaust in an appropriate container, such as a bag, and then measure NO<sub>x</sub>, HC, CO, CO<sub>2</sub>, CH<sub>4</sub>, N<sub>2</sub>O, and CH<sub>2</sub>O concentrations in the container after the test interval. You may deposit PM from proportionally extracted exhaust onto an appropriate substrate, such as a filter. In this case, divide the PM by the amount of filtered exhaust to calculate the PM concentration. Multiply batch sampled concentrations by the total (raw or dilute) flow from which it was extracted during the test interval. This product is the total mass of the emitted constituent.

(iii) *Combined sampling.* You may use continuous and batch sampling simultaneously during a test interval, as follows:

(A) You may use continuous sampling for some constituents and batch sampling for others.

(B) You may use continuous and batch sampling for a single constituent, with one being a redundant measurement, subject to the provisions of 40 CFR 1065.201.

(d) Refer to subpart G of this part and the standard-setting part for calculations to determine g/mile emission rates.

(e) You must use good engineering judgment for all aspects of testing under this part. While this part highlights several specific cases where good engineering judgment is especially relevant, the requirement to use good engineering judgment is not limited to those provisions where we specifically re-state this requirement.

#### § 1066.20 Units of measure and overview of calculations.

(a) *System of units.* The procedures in this part follow both conventional English units and the International System of Units (SI), as detailed in NIST Special Publication 811, which we incorporate by reference in § 1066.1010. Except where specified, equations work with either system of units. Where the equations depend on the use of specific units, the regulation identifies the appropriate units.

(b) *Units conversion.* Use good engineering judgment to convert units between measurement systems as needed. For example, if you measure vehicle speed as kilometers per hour and we specify a precision requirement in terms of miles per hour, convert your measured kilometer per hour value to miles per hour before comparing it to our specification. The following conventions are used throughout this document and should be used to convert units as applicable:

(1) 1 hp = 33,000 ft·lbf/min = 550 ft·lbf/s = 0.7457 kW.

(2) 1 lbf = 32.174 ft·lbf/s<sup>2</sup> = 4.4482 N.

(3) 1 inch = 25.4 mm.

(4) 1 mile = 1609.344 m.

(5) For ideal gases, 1 μmol/mol = 1 ppm.

(6) For ideal gases, 10 mmol/mol = 1%.

(c) *Temperature.* We generally designate temperatures in units of degrees Celsius (°C) unless a calculation requires an absolute temperature. In that case, we designate temperatures in units of Kelvin (K). For conversion purposes throughout this part, 0 °C equals 273.15 K. Unless specified otherwise, always use absolute temperature values for multiplying or dividing by temperature.

(d) *Absolute pressure.* Measure absolute pressure directly or calculate it as the sum of atmospheric pressure plus a differential pressure that is referenced to atmospheric pressure. Always use absolute pressure values for multiplying or dividing by pressure.

(e) *Rounding.* The rounding provisions of 40 CFR 1065.20 apply for calculations in this part. This generally specifies that you round final values but not intermediate values. Use good engineering judgment to record the

appropriate number of significant digits for all measurements.

(f) *Interpretation of ranges.* Interpret a range as a tolerance unless we explicitly identify it as an accuracy, repeatability, linearity, or noise specification. See 40 CFR 1065.1001 for the definition of tolerance. In this part, we specify two types of ranges:

(1) Whenever we specify a range by a single value and corresponding limit values above and below that value (such as X ± Y), target the associated control point to that single value (X). Examples of this type of range include “±10% of maximum pressure”, or “(30 ± 10) kPa”. In these examples, you would target the maximum pressure or 30 kPa, respectively.

(2) Whenever we specify a range by the interval between two values, you may target any associated control point to any value within that range. An example of this type of range is “(40 to 50) kPa”.

(g) *Scaling of specifications with respect to an applicable standard.* Because this part 1066 applies to a wide range of vehicles and emission standards, some of the specifications in this part are scaled with respect to a vehicle’s applicable standard or weight. This ensures that the specification will be adequate to determine compliance, but not overly burdensome by requiring unnecessarily high-precision equipment. Many of these specifications are given with respect to a “flow-weighted mean” that is expected at the standard or during testing. Flow-weighted mean is the mean of a quantity after it is weighted proportional to a corresponding flow rate. For example, if a gas concentration is measured continuously from the raw exhaust of an engine, its flow-weighted mean concentration is the sum of the products of each recorded concentration times its respective exhaust flow rate, divided by the sum of the recorded flow rates. As another example, the bag concentration from a CVS system is the same as the flow-weighted mean concentration, because the CVS system itself flow-weights the bag concentration.

#### § 1066.25 Recordkeeping.

(a) The procedures in this part include various requirements to record data or other information. Refer to the standard-setting part and § 1066.695 regarding specific recordkeeping requirements.

(b) You must promptly send us organized, written records in English if we ask for them. We may review them at any time.

(c) We may waive specific reporting or recordkeeping requirements we

determine to be unnecessary for the purposes of this part and the standard-setting part. Note that while we will generally keep the records required by this part, we are not obligated to keep records we determine to be unnecessary for us to keep. For example, while we require you to keep records for invalid tests so we may verify that your invalidation was appropriate, it is not necessary for us to keep records for our own invalid tests.

### Subpart B—Equipment, Measurement Instruments, Fuel, and Analytical Gas Specifications

#### § 1066.101 Overview.

(a) This subpart addresses equipment related to emission testing, as well as test fuels and analytical gases.

(b) The provisions of 40 CFR part 1065 specify engine-based procedures for measuring emissions. Except as specified otherwise in this part, the provisions of 40 CFR part 1065 apply for testing required by this part as follows:

(1) The provisions of 40 CFR part 1065, subpart B, describe equipment specifications for exhaust dilution and sampling systems; these specifications apply for testing under this part as described in § 1066.110.

(2) The provisions of 40 CFR part 1065, subpart C, describe specifications for measurement instruments; these specifications apply for testing under this part as described in § 1066.120.

(3) The provisions of 40 CFR part 1065, subpart D, describe specifications for measurement instrument calibrations and verifications; these specifications apply for testing under this part as described in § 1066.130.

(4) The provisions of 40 CFR part 1065, subpart H, describe specifications for fuels, engine fluids, and analytical gases; these specifications apply for testing under this part as described in § 1066.145.

(5) The provisions of 40 CFR part 1065, subpart I, describe specifications for testing with oxygenated fuels; these specifications apply for NMOG determination as described in § 1066.635.

(c) The provisions of this subpart are intended to specify systems that can

very accurately and precisely measure emissions from motor vehicles such as light-duty vehicles. To the extent that this level of accuracy or precision is not necessary for testing highway motorcycles or nonroad vehicles, we may waive or modify the specifications and requirements of this part for testing these other vehicles, consistent with good engineering judgment. For example, it may be appropriate to allow the use of a hydrokinetic dynamometer that is not able to meet all the performance specifications described in this subpart.

#### § 1066.105 Ambient controls and vehicle cooling fans.

(a) *Ambient conditions.* Dynamometer testing under this part generally requires that you maintain the test cell within a specified range of ambient temperature and humidity. Use good engineering judgment to maintain relatively uniform temperatures throughout the test cell before testing. You are generally not required to maintain uniform temperatures throughout the test cell while the vehicle is running due to the heat generated by the vehicle. Measured humidity values must represent the conditions to which the vehicle is exposed, which includes intake air; other than the intake air, humidity does not affect emissions, so humidity need not be uniform throughout the test cell.

(b) *General requirements for cooling fans.* Use good engineering judgment to select and configure fans to cool the test vehicle in a way that meets the specifications of paragraph (c) of this section and simulates in-use operation. If you demonstrate that the specified fan configuration is impractical for special vehicle designs, such as vehicles with rear-mounted engines, or it does not provide adequate cooling to properly represent in-use operation, you may ask us to approve increasing fan capacity or using additional fans.

(c) *Allowable cooling fans for vehicles at or below 14,000 pounds GVWR.* Cooling fan specifications for vehicles at or below 14,000 pounds GVWR depend on the test cycle. Paragraph (c)(1) of this section summarizes the cooling fan specifications for the different test cycles; the detailed specifications are

described in paragraphs (c)(2) through (5) of this section. See § 1066.410 for instruction regarding how to use the fans during testing.

(1) Cooling fan specifications for different test cycles are summarized as follows:

(i) For the FTP test cycle, the allowable cooling fan configurations are described in paragraphs (c)(2) and (3) of this section.

(ii) For the HFET test cycle, the allowable cooling fan configurations are described in paragraphs (c)(2) and (3) of this section.

(iii) For the US06 test cycle, the allowable cooling fan configurations are described in paragraphs (c)(2) and (4) of this section.

(iv) For the LA-92 test cycle, the allowable cooling fan configurations are described in paragraphs (c)(2) and (4) of this section.

(v) For SC03 and AC17 test cycles, the allowable cooling fan configuration is described in paragraph (c)(5) of this section.

(2) You may use a road-speed modulated fan system meeting the specifications of this paragraph (c)(2) for anything other than SC03 and AC17 testing. Use a road-speed modulated fan that achieves a linear speed of cooling air at the blower outlet that is within  $\pm 3.0$  mph ( $\pm 1.3$  m/s) of the corresponding roll speed when vehicle speeds are between 5 and 30 mph, and within  $\pm 6.5$  mph ( $\pm 2.9$  m/s) of the corresponding roll speed at higher vehicle speeds; however you may limit the fan's maximum linear speed to 70 mph. We recommend that the cooling fan have a minimum opening of  $0.2 \text{ m}^2$  and a minimum width of 0.8 m.

(i) Verify the air flow velocity for fan speeds corresponding to vehicle speeds of 20 and 40 mph using an instrument that has an accuracy of  $\pm 2\%$  of the measured air flow speed.

(ii) For fans with rectangular outlets, divide the fan outlet into sections as shown in Figure 1 of this section. As illustrated by the "+" in the following figure, measure flow from the center of each section; do not measure the flow from the center section.

Figure 1 of § 1066.105—Rectangular fan outlet grid

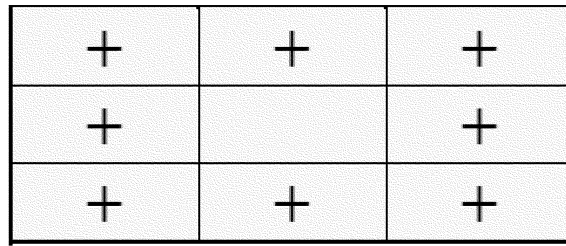

(iii) For fans with circular outlets, divide the fan outlet into 8 equal sections as shown in Figure 2 of this

section. As illustrated by the “+” in the following figure, measure flow on the radial centerline of each section, at a

radius of two-thirds of the fan’s total radius.

Figure 2 of § 1066.105—Circular fan outlet grid

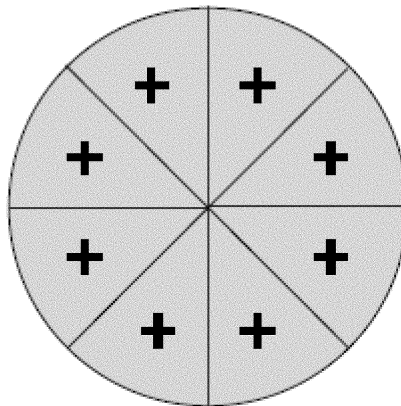

(iv) Verify that the uniformity of the fan’s axial flow is constant across the discharge area within a tolerance of  $\pm 4.0$  mph of the vehicle’s speed at fan speeds corresponding to 20 mph, and within  $\pm 8.0$  mph at fan speeds corresponding to 40 mph. For example, at a vehicle speed of 20.2 mph, axial flow at all locations denoted by the “+” across the discharge nozzle must be between 16.2 and 24.2 mph. When measuring the axial air flow velocity, use good engineering judgment to determine the distance from the nozzle outlet at each point of the fan outlet grid. Use these values to calculate a mean air flow velocity across the discharge area at each speed setting. The instrument used to verify the air velocity must have an accuracy of  $\pm 2\%$  of the measured air flow velocity.

(v) Use a multi-axis flow meter or another method to verify that the fan’s air flow perpendicular to the axial air flow is less than 15% of the axial air flow, consistent with good engineering judgment. Demonstrate this by comparing the perpendicular air flow velocity to the mean air flow velocities determined in paragraph (c)(2)(iv) of

this section at vehicle speeds of 20 and 40 mph.

(3) You may use a fixed-speed fan with a maximum capacity up to 2.50  $m^3/s$  for FTP and HFET testing.

(4) You may use a fixed-speed fan with a maximum capacity up to 7.10  $m^3/s$  for US06 and LA-92 testing.

(5) For SC03 and AC17 testing, use a road-speed modulated fan with a minimum discharge area that is equal to or exceeds the vehicle’s frontal inlet area. We recommend using a fan with a discharge area of 1.7  $m^2$ .

(i) Air flow volumes must be proportional to vehicle speed. Select a fan size that will produce a flow volume of approximately 45  $m^3/s$  at 60 mph. If this fan is also the only source of test cell air circulation or if fan operational mechanics make the 0 mph air flow requirement impractical, air flow of 2 mph or less at 0 mph vehicle speed is allowed.

(ii) Verify the uniformity of the fan’s axial flow as described in paragraph (c)(2)(iv) of this section, except that you must measure the axial air flow velocity 60 cm from the nozzle outlet at each point of the discharge area grid.

(iii) Use a multi-axis flow meter or another method to verify that the fan’s air flow perpendicular to the axial air flow is less than 10% of the axial air flow, consistent with good engineering judgment. Demonstrate this by comparing the perpendicular air flow velocity to the mean air flow velocities determined in paragraph (c)(2)(iv) of this section at vehicle speeds of 20 and 40 mph.

(iv) In addition to the road-speed modulated fan, we may approve the use of one or more fixed-speed fans to provide proper cooling to represent in-use operation, but only up to a total of 2.50  $m^3/s$  for all additional fans.

(d) *Allowable cooling fans for vehicles above 14,000 pounds GVWR. For all testing, use a road-speed modulated fan system that achieves a linear speed of cooling air at the blower outlet that is within  $\pm 3.0$  mph ( $\pm 1.3$  m/s) of the corresponding roll speed when vehicle speeds are between 5 and 30 mph, and within  $\pm 10$  mph ( $\pm 4.5$  m/s) of the corresponding roll speed at higher vehicle speeds. For vehicles above 19,500 pounds GVWR, we recommend that the cooling fan have a minimum*

opening of 2.75 m<sup>2</sup>, a minimum flow rate of 60 m<sup>3</sup>/s at a fan speed of 50 mph, and a minimum speed profile in the free stream flow, across the duct, that is  $\pm 15\%$  of the target flow rate.

**§ 1066.110 Equipment specifications for emission sampling systems.**

(a) This section specifies equipment related to emission testing, other than measurement instruments. This equipment includes dynamometers (described further in subpart C of this part) and various emission-sampling hardware.

(b) The following equipment specifications apply for testing under this part:

(1) Connect a vehicle's exhaust system to any dilution stage as follows:

(i) Minimize lengths of laboratory exhaust tubing. You may use a total length of laboratory exhaust tubing up to 4 m without needing to heat or insulate the tubing. However, you may use a total length of laboratory exhaust tubing up to 10 m if you insulate and/or heat the tubing to minimize the temperature difference between the exhaust gas and the whole tubing wall over the course of the emission test. The laboratory exhaust tubing starts at the end of the vehicle's tailpipe and ends at the first sample point or the first dilution point. The laboratory exhaust tubing may include flexible sections, but we recommend that you limit the amount of flexible tubing to the extent practicable. For multiple-tailpipe configurations where the tailpipes combine into a single flow path for emission sampling, the start of the laboratory exhaust tubing may be taken at the last joint where the exhaust flow first becomes a single, combined flow.

(ii) You may insulate or heat any laboratory exhaust tubing.

(iii) Use laboratory exhaust tubing materials that are smooth-walled and not chemically reactive with exhaust constituents. (For purposes of this paragraph (b)(1), nominally smooth spiral-style and accordion-style flexible tubing are considered to be smooth-walled.) For measurements involving PM, tubing materials must also be electrically conductive. Stainless steel is an acceptable material for any testing. You may use short sections of nonconductive flexible tubing to connect a PM sampling system to the vehicle's tailpipe; use good engineering judgment to limit the amount of nonconductive surface area exposed to the vehicle's exhaust.

(iv) We recommend that you use laboratory exhaust tubing that has either a wall thickness of less than 2 mm or is air gap-insulated to minimize

temperature differences between the wall and the exhaust.

(v) You must seal your system to the extent necessary to ensure that any remaining leaks do not affect your ability to demonstrate compliance with the applicable standards. We recommend that you seal all known leaks.

(vi) Electrically ground the entire exhaust system, with the exception of nonconductive flexible tubing, as allowed under paragraph (b)(1)(iii) of this section.

(vii) For vehicles with multiple tailpipes, route the exhaust into a single flow. To ensure mixing of the multiple exhaust streams before emission sampling, we recommend a minimum Reynolds number,  $Re_{num}$ , of 4000 for the combined exhaust stream, where  $Re_{num}$  is based on the inside diameter of the combined flow at the first sampling point. You may configure the exhaust system with turbulence generators, such as orifice plates or fins, to achieve good mixing; this may be necessary for good mixing if  $Re_{num}$  is less than 4000.  $Re_{num}$  is defined in 40 CFR 1065.640.

(2) Use equipment specifications in 40 CFR 1065.140 through 40 CFR 1065.190, except as follows:

(i) For PM background measurement, the following provisions apply instead of the analogous provisions in 40 CFR 1065.140(b):

(A) You need not measure PM background for every test. You may apply PM background correction for a single site or multiple sites using a moving-average background value as long as your background PM sample media (e.g., filters) were all made by the same manufacturer from the same material. Use good engineering judgment to determine how many background samples make up the moving average and how frequently to update those values. For example, you might take one background sample per week and average that sample into previous background values, maintaining five observations for each calculated average value. Background sampling time should be representative of the duration of the test interval to which the background correction is applied.

(B) You may sample background PM from the dilution tunnel at any time before or after an emission test using the same sampling system used during the emission test. For this background sampling, the dilution tunnel blower must be turned on, the vehicle must be disconnected from the laboratory exhaust tubing, and the laboratory exhaust tubing must be capped.

(C) The duration of your background sample may be different than that of the test cycle in which you are applying the background correction, consistent with good engineering judgment.

(D) Your PM background correction may not exceed 5  $\mu\text{g}$  or 5% of the net PM mass expected at the standard, whichever is greater.

(ii) The provisions of 40 CFR 1065.140(d)(2)(iv) do not apply.

(iii) For PM samples, configure dilution systems using the following limits:

(A) Control the dilution air temperature as described in 40 CFR 1065.140(e)(1), except that the temperature may be set to (15 to 52) °C. Use good engineering judgment to control PM sample temperature as required under 40 CFR 1065.140(e)(4).

(B) Apply the provisions of this paragraph (b)(2)(iii)(B) instead of 40 CFR 1065.140(e)(2). Add dilution air to the raw exhaust such that the overall dilution factor of diluted exhaust to raw exhaust, as shown in Eq. 1066.610–2 or 1066.610–3, is within the range of (7:1 to 20:1). Compliance with this dilution factor range may be determined for an individual test interval or as a time-weighted average over the entire duty cycle as determined in Eq. 1066.610–4. The maximum dilution factor limit of 20:1 does not apply for hybrid electric vehicles (HEVs), since the dilution factor is infinite when the engine is off; however we strongly recommend that you stay under the specified maximum dilution factor limit when the engine is running. For partial-flow sampling systems, determine dilution factor using Eq. 1066.610–3. To determine the overall dilution factor for PM samples utilizing secondary dilution air, multiply the dilution factor from the CVS by the dilution ratio of secondary dilution air to primary diluted exhaust.

(iv) In addition to the allowances in 40 CFR 1065.140(c)(6), you may heat the dilution air as described in paragraph (b)(2)(iii)(A) of this section to prevent or limit aqueous condensation.

(v) If you choose to dilute the exhaust by using a remote mix tee, which dilutes the exhaust at the tailpipe, you may use the following provisions consistent with good engineering judgment, as long as they do not affect your ability to demonstrate compliance with the applicable standards:

(A) You may use smooth-walled flexible tubing (including accordion-style) in the dilution tunnel upstream of locations for flow measurement or gaseous emission measurement.

(B) You may use smooth-walled electrically conductive flexible tubing in



the dilution tunnel upstream of the location for PM emission measurements.  
 (C) All inside surfaces upstream of emission sampling must be made of 300 series stainless steel or polymer-based materials.

(D) Use good engineering judgment to ensure that the materials you choose do not cause significant loss of PM from your sample.  
 (vi) Paragraph (b)(1)(vi) of this section applies instead of 40 CFR 1065.145(b).

(vii) Vehicles other than HEVs that apply technology involving engine shutdown during idle may apply the sampling provisions of § 1066.501(c).  
 (c) The following table summarizes the requirements of paragraph (b)(2) of this section:

TABLE 1 OF § 1066.110—SUMMARY OF EQUIPMENT SPECIFICATIONS FROM 40 CFR PART 1065, SUBPART B, THAT APPLY FOR CHASSIS TESTING

40 CFR part 1065 references	Applicability for chassis testing under this part
40 CFR 1065.140.	Use all except as noted: 40 CFR 1065.140(b) applies as described in this section. Use 40 CFR 1065.140(c)(6), with the additional allowance described in this section.
40 CFR 1065.145 .....	Do not use 40 CFR 1065.140(d)(2)(iv). Use 40 CFR 1065.140(e)(1) as described in this section. Do not use 40 CFR 1065.140(e)(2).
40 CFR 1065.150 through 1065.190 .....	Use all except 40 CFR 1065.145(b). Use all.

**§ 1066.120 Measurement instruments.**

The measurement instrument requirements in 40 CFR part 1065, subpart C, apply with the following exceptions:

- (a) The provisions of § 1066.125 apply instead of 40 CFR 1065.202.
- (b) The provisions of 40 CFR 1065.210 and 1065.295 do not apply.

**§ 1066.125 Data updating, recording, and control.**

This section specifies criteria that your test system must meet for updating and recording data. It also specifies criteria for controlling the systems related to driver demand, the dynamometer, sampling equipment, and measurement instruments.

(a) Read and record values and calculate mean values relative to a specified frequency as follows:  
 (1) This paragraph (a)(1) applies where we specify a minimum command and control frequency that is greater than the minimum recording frequency, such as for sample flow rates from a CVS that does not have a heat exchanger. For these measurements, the rate at which you read and interpret the signal must be at least as frequent as the minimum command and control frequency. You may record values at the same frequency, or you may record them as mean values, as long as the frequency of the mean values meets the minimum recording frequency. You must use all read values, either by recording them or using them to calculate mean values. For example, if

your system reads and controls the sample flow rate at 10 Hz, you may record these values at 10 Hz, record them at 5 Hz by averaging pairs of consecutive points together, or record them at 1 Hz by averaging five consecutive points together.  
 (2) For all other measured values covered by this section, you may record the values instantaneously or as mean values, consistent with good engineering judgment.  
 (3) You may not use rolling averages of measured values where a given measured value is included in more than one recorded mean value.  
 (b) Use data acquisition and control systems that can command, control, and record at the following minimum frequencies:

TABLE 1 OF § 1066.125—DATA RECORDING AND CONTROL MINIMUM FREQUENCIES

Applicable section	Measured values	Minimum command and control frequency <sup>a</sup>	Minimum recording frequency <sup>b, c</sup>
§ 1066.310 .....	Vehicle speed .....	.....	10 Hz.
§ 1066.315 .....	.....	.....	.....
§ 1066.425 .....	Continuous concentrations of raw or dilute analyzers .....	.....	1 Hz.
§ 1066.425 .....	Power analyzer .....	.....	1 Hz.
§ 1066.501 .....	.....	.....	.....
§ 1066.425 .....	Bag concentrations of raw or dilute analyzers .....	.....	1 mean value per test interval.
40 CFR 1065.545 .....	Diluted exhaust flow rate from a CVS with a heat exchanger upstream of the flow measurement.	.....	1 Hz.
§ 1066.425 .....	.....	.....	.....
40 CFR 1065.545 .....	Diluted exhaust flow rate from a CVS without a heat exchanger upstream of the flow measurement.	5 Hz .....	1 Hz means.
§ 1066.425 .....	.....	.....	.....
40 CFR 1065.545 .....	Dilution air flow if actively controlled (for example, a partial-flow PM sampling system) <sup>d</sup> .	5 Hz .....	1 Hz means.
§ 1066.425 .....	.....	.....	.....
40 CFR 1065.545 .....	Sample flow from a CVS that has a heat exchanger .....	1 Hz .....	1 Hz.
§ 1066.425 .....	.....	.....	.....
40 CFR 1065.545 .....	Sample flow from a CVS that does not have a heat exchanger.	5 Hz .....	1 Hz means.
§ 1066.425 .....	.....	.....	.....
§ 1066.420 .....	Ambient temperature .....	.....	1 Hz. <sup>e</sup>
§ 1066.420 .....	Ambient humidity .....	.....	1 Hz. <sup>e</sup>



TABLE 1 OF § 1066.125—DATA RECORDING AND CONTROL MINIMUM FREQUENCIES—Continued

Applicable section	Measured values	Minimum command and control frequency <sup>a</sup>	Minimum recording frequency <sup>b, c</sup>
§ 1066.420 .....	Heated sample system temperatures, including PM filter face.	.....	1 Hz.

<sup>a</sup> CFVs that are not using active control are exempt from meeting this requirement due to their operating principle.  
<sup>b</sup> 1 Hz means are data reported from the instrument at a higher frequency, but recorded as a series of 1 s mean values at a rate of 1 Hz.  
<sup>c</sup> For CFVs in a CVS, the minimum recording frequency is 1 Hz. For CFVs used to control sampling from a CFV CVS, the minimum recording frequency is not applicable.  
<sup>d</sup> This is not applicable to CVS dilution air.  
<sup>e</sup> Unless specified elsewhere in this part or the standard-setting part. Note that this provision does not apply to soak periods where recording frequencies are not specified. For these instances, we recommend a recording frequency of ≥ 0.016 Hz.

**§ 1066.130 Measurement instrument calibrations and verifications.**

The measurement instrument calibration and verification requirements in 40 CFR part 1065, subpart D, apply with the following exceptions:

(a) The calibration and verification provisions of 40 CFR 1065.303 do not apply for engine speed, torque, fuel rate, or intake air flow.

(b) The linearity verification provisions of 40 CFR 1065.307 do not apply for engine speed, torque, fuel rate,

or intake air flow. Section 1066.135 specifies additional linearity verification provisions that apply specifically for chassis testing.

(c) The provisions of § 1066.220 apply instead 40 CFR 1065.310.

(d) The provisions of 40 CFR 1065.320, 1065.325, and 1065.395 do not apply.

(e) If you are measuring flow volumetrically (rather than measuring based on molar values), the provisions of § 1066.140 apply instead of 40 CFR 1065.340.

(f) The provisions of § 1066.150 apply instead 40 CFR 1065.350(c), 1065.355(c), 1065.370(c), and 1065.375(c).

(g) Table 1 of this section summarizes the required and recommended calibrations and verifications that are unique to testing under this part and indicates when these must be performed. Perform other required or recommended calibrations and verifications as described in 40 CFR 1065.303, with the exceptions noted in this section. Table 1 follows:

TABLE 1 OF § 1066.130—SUMMARY OF REQUIRED CALIBRATIONS AND VERIFICATIONS

Type of calibration or verification	Minimum frequency <sup>a</sup>
40 CFR 1065.307: Linearity verification.	The linearity verifications from 40 CFR part 1065 do not apply under this part for engine speed, torque, fuel rate, or intake air flow; the linearity verification described in § 1066.135 applies for the following measurements: Dynamometer speed: See § 1066.220. Dynamometer torque: See § 1066.220.
40 CFR 1065.310: Torque .....	This calibration does not apply for testing under this part; see § 1066.220.
40 CFR 1065.320: Fuel flow .....	This calibration does not apply for testing under this part.
40 CFR 1065.325: Intake flow .....	This calibration does not apply for testing under this part.
40 CFR 1065.340: CVS calibration	This calibration does not apply for CVS flow meters calibrated volumetrically as described in § 1066.140.
40 CFR 1065.345: Vacuum leak ....	Required upon initial installation of the sampling system; recommended within 35 days before the start of an emissions test and after maintenance such as pre-filter changes.
40 CFR 1065.350(c), 1065.355(c), 1065.370(c), and 1065.375(c).	These provisions do not apply for testing under this part; see § 1066.150.
40 CFR 1065.395: Inertial PM balance and weighing.	These verifications do not apply for testing under this part.

<sup>a</sup> Perform calibrations and verifications more frequently if needed to conform to the measurement system manufacturer's instructions and good engineering judgment.

**§ 1066.135 Linearity verification.**

This section describes requirements for linearity verification that are unique to testing under this part. (Note: See the definition of “linearity” in 40 CFR 1065.1001, where we explain that linearity means the degree to which measured values agree with respective reference values and that the term “linearity” is not used to refer to the shape of a measurement instrument's unprocessed response curve.) Perform other required or recommended calibrations and verifications as described in 40 CFR 1065.307, with the exceptions noted in this section.

(a) For gas analyzer linearity, use one of the following options:

(1) Use instrument manufacturer recommendations and good engineering judgment to select at least ten reference values,  $y_{refi}$ , that cover the range of values that you expect during testing (to prevent extrapolation beyond the verified range during emission testing). We recommend selecting zero as one of your reference values. For each range calibrated, if the deviation from a least-squares best-fit straight line is 2% or less of the value at each data point, concentration values may be calculated by use of a straight-line curve fit for that

range. If the deviation exceeds 2% at any point, use the best-fit nonlinear equation that represents the data to within 2% of each test point to determine concentration. If you use a gas divider to blend calibration gases, verify that the calibration curve produced names a calibration gas within 2% of its certified concentration. Perform this verification between 15 and 50% of the full-scale analyzer range.

(2) Use the linearity requirements of 40 CFR 1065.307, except for CO<sub>2</sub> measurements used for determining fuel economy and GHG emissions for motor

vehicles at or below 14,000 pounds GVWR. If you choose this linearity option, you must use the provisions of 40 CFR 1065.672 to check for drift and make appropriate drift corrections.

(b) For dilution air, diluted exhaust, and raw exhaust sample flow, use a reference flow meter with a blower or pump to simulate flow rates. Use a restrictor, diverter valve, variable-speed blower, or variable-speed pump to control the range of flow rates. Use the reference meter's response for the reference values.

(1) *Reference flow meters.* Because of the large range in flow requirements, we allow a variety of reference meters. For example, for diluted exhaust flow for a full-flow dilution system, we recommend a reference subsonic venturi flow meter with a restrictor valve and a blower to simulate flow rates. For dilution air, diluted exhaust for partial-flow dilution, and raw exhaust, we allow reference meters such as critical flow orifices, critical flow venturis, laminar flow elements, master mass flow standards, or Roots meters. Make sure the reference meter is calibrated and its calibration is NIST-traceable. If you use the difference of two flow measurements to determine a net flow rate, you may use one of the measurements as a reference for the other.

(2) *Reference flow values.* Because the reference flow is not absolutely constant, sample and record values of  $Q_{ref}$  for 30 seconds and use the arithmetic mean of the values,  $\bar{Q}_{ref}$ , as the reference value. Refer to 40 CFR 1065.602 for an example of calculating an arithmetic mean.

(3) *Linearity criteria.* The values measured during linearity verification for flow meters must meet the following criteria:  $|x_{min}(a_1 - 1) + a_0| \leq 1\% \cdot Q_{max}$ ;  $a_1 = 0.98 - 1.02$ ;  $SEE \leq 2\% \cdot Q_{max}$ ; and  $r^2 \geq 0.990$ .

(c) Perform linearity verifications for the following temperature measurements instead of those specified at 40 CFR 1065.307(e)(7):

(1) Test cell ambient air.  
 (2) Dilution air for PM sampling, including CVS, double-dilution, and partial-flow systems.

(3) PM sample.  
 (4) Chiller sample, for gaseous sampling systems that use thermal chillers to dry samples, and that use chiller temperature to calculate dewpoint at the chiller outlet. For testing, if you choose to use the high alarm temperature setpoint for the chiller temperature as a constant value in determining the amount of water removed from the emission sample, you may verify the accuracy of the high

alarm temperature setpoint using good engineering judgment without following the linearity verification for chiller temperature. We recommend that you input a simulated reference temperature signal below the alarm setpoint, increase this signal until the high alarm trips, and verify that the alarm setpoint value is no less than 2 °C below the reference value at the trip point.

(5) CVS flow meter inlet temperature.  
 (d) Perform linearity verifications for the following pressure measurements instead of those specified at 40 CFR 1065.307(e)(8):

(1) Exhaust back pressure at the tailpipe exit.  
 (2) Barometric pressure.  
 (3) CVS flow meter inlet pressure.  
 (4) Sample dryer, for gaseous sampling systems that use either osmotic-membrane dryers or thermal chillers to dry samples. For your testing, if you choose to use a low alarm pressure setpoint for the sample dryer pressure as a constant value in determining the amount of water removed from the emission sample, you may verify the accuracy of the low alarm pressure setpoint using good engineering judgment without following the linearity verification for sample dryer pressure. We recommend that you input a reference pressure signal above the alarm setpoint, decrease this signal until the low alarm trips, and verify that the alarm setpoint value is no more than 4 kPa above the reference value at the trip point.

(e) When following procedures or practices that we incorporate by reference in § 1066.1010, you must meet the linearity requirements given by the procedure or practice for any analytical instruments not covered under 40 CFR 1065.307, such as GC-FID or HPLC.

#### § 1066.140 Diluted exhaust flow calibration.

(a) *Overview.* This section describes how to calibrate flow meters for diluted exhaust constant-volume sampling (CVS) systems. We recommend that you also use this section to calibrate flow meters that use a subsonic venturi or ultrasonic flow to measure raw exhaust flow. You may follow the molar flow calibration procedures in 40 CFR 1065.340 instead of the procedures in this section.

(b) *Scope and frequency.* Perform this calibration while the flow meter is installed in its permanent position, except as allowed in paragraph (c) of this section. Perform this calibration after you change any part of the flow configuration upstream or downstream of the flow meter that may affect the flow-meter calibration. Perform this

calibration upon initial CVS installation and whenever corrective action does not resolve a failure to meet the diluted exhaust flow verification (i.e., propane check) in 40 CFR 1065.341.

(c) *Ex-situ CFV and SSV calibration.* You may remove a CFV or SSV from its permanent position for calibration as long as the flow meter meets the requirements in 40 CFR 1065.340(c).

(d) *Reference flow meter.* Calibrate each CVS flow meter using a reference flow meter such as a subsonic venturi flow meter, a long-radius ASME/NIST flow nozzle, a smooth approach orifice, a laminar flow element, or an ultrasonic flow meter. Use a reference flow meter that reports quantities that are NIST-traceable within  $\pm 1\%$  uncertainty. Use this reference flow meter's response to flow as the reference value for CVS flow-meter calibration.

(e) *Configuration.* Calibrate the system with any upstream screens or other restrictions that will be used during testing and that could affect the flow ahead of the reference flow meter. You may not use any upstream screen or other restriction that could affect the flow ahead of the reference flow meter, unless the flow meter has been calibrated with such a restriction.

(f) *PDP calibration.* Calibrate each positive-displacement pump (PDP) to determine a flow-versus-PDP speed equation that accounts for flow leakage across sealing surfaces in the PDP as a function of PDP inlet pressure. Determine unique equation coefficients for each speed at which you operate the PDP. Calibrate a PDP flow meter as follows:

(1) Connect the system as shown in Figure 1 of this section.  
 (2) Leaks between the calibration flow meter and the PDP must be less than 0.3% of the total flow at the lowest calibrated flow point; for example, at the highest restriction and lowest PDP-speed point.

(3) While the PDP operates, maintain a constant temperature at the PDP inlet within  $\pm 2\%$  of the mean absolute inlet temperature,  $T_{in}$ .

(4) Set the PDP speed to the first speed point at which you intend to calibrate.

(5) Set the variable restrictor to its wide-open position.

(6) Operate the PDP for at least 3 min to stabilize the system. Continue operating the PDP and record the mean values of at least 30 seconds of sampled data of each of the following quantities:

(i) The mean flow rate of the reference flow meter,  $\bar{Q}_{ref}$ . This may include several measurements of different quantities, such as reference meter

pressures and temperatures, for calculating  $\bar{Q}_{ref}$ .

(ii) The mean temperature at the PDP inlet,  $\bar{T}_{in}$ .

(iii) The mean static absolute pressure at the PDP inlet,  $\bar{P}_{in}$ .

(iv) The mean static absolute pressure at the PDP outlet,  $\bar{P}_{out}$ .

(v) The mean PDP speed,  $\bar{f}_{nPDP}$ .

(7) Incrementally close the restrictor valve to decrease the absolute pressure at the inlet to the PDP,  $P_{in}$ .

(8) Repeat the steps in paragraphs (f)(6) and (7) of this section to record data at a minimum of six restrictor positions ranging from the wide-open restrictor position to the minimum expected pressure at the PDP inlet.

(9) Calibrate the PDP by using the collected data and the equations in § 1066.625(a).

(10) Repeat the steps in paragraphs (f)(6) through (9) of this section for each speed at which you operate the PDP.

(11) Use the equations in § 1066.630(a) to determine the PDP flow equation for emission testing.

(12) Verify the calibration by performing a CVS verification (i.e., propane check) as described in 40 CFR 1065.341.

(13) Ensure that the lowest inlet pressure tested during calibration is at least as low as the lowest PDP inlet pressure that will occur during emission testing. You may not use the PDP below the lowest inlet pressure tested during calibration.

(g) *SSV calibration.* Calibrate each subsonic venturi (SSV) to determine its discharge coefficient,  $C_d$ , for the expected range of inlet pressures. Calibrate an SSV flow meter as follows:

(1) Configure your calibration system as shown in Figure 1 of this section.

(2) Verify that any leaks between the calibration flow meter and the SSV are less than 0.3% of the total flow at the highest restriction.

(3) Start the blower downstream of the SSV.

(4) While the SSV operates, maintain a constant temperature at the SSV inlet within  $\pm 2\%$  of the mean absolute inlet temperature,  $\bar{T}_{in}$ .

(5) Set the variable restrictor or variable-speed blower to a flow rate greater than the greatest flow rate expected during testing. You may not extrapolate flow rates beyond calibrated values, so we recommend that you make sure the Reynolds number,  $Re^{\#}$ , at the SSV throat at the greatest calibrated flow rate is greater than the maximum  $Re^{\#}$  expected during testing.

(6) Operate the SSV for at least 3 min to stabilize the system. Continue

operating the SSV and record the mean of at least 30 seconds of sampled data of each of the following quantities:

(i) The mean flow rate of the reference flow meter,  $\bar{Q}_{ref}$ . This may include several measurements of different quantities for calculating  $\bar{Q}_{ref}$ , such as reference meter pressures and temperatures.

(ii) The mean temperature at the venturi inlet,  $\bar{T}_{in}$ .

(iii) The mean static absolute pressure at the venturi inlet,  $\bar{p}_{in}$ .

(iv) Mean static differential pressure between the static pressure at the venturi inlet and the static pressure at the venturi throat,  $\Delta\bar{p}_{ssv}$ .

(7) Incrementally close the restrictor valve or decrease the blower speed to decrease the flow rate.

(8) Repeat the steps in paragraphs (g)(6) and (7) of this section to record data at a minimum of ten flow rates.

(9) Determine an equation to quantify  $C_d$  as a function of  $Re^{\#}$  by using the collected data and the equations in § 1066.625(b). Section 1066.625 also includes statistical criteria for validating the  $C_d$  versus  $Re^{\#}$  equation.

(10) Verify the calibration by performing a CVS verification (i.e., propane check) as described in 40 CFR 1065.341 using the new  $C_d$  versus  $Re^{\#}$  equation.

(11) Use the SSV only between the minimum and maximum calibrated flow rates. If you want to use the SSV at a higher or lower flow rate, you must recalibrate the SSV.

(12) Use the equations in § 1066.630(b) to determine SSV flow during a test.

(h) *CFV calibration.* The calibration procedure described in this paragraph (h) establishes the value of the calibration coefficient,  $K_v$ , at measured values of pressure, temperature and air flow. Calibrate the CFV at the lowest expected static differential pressure between the CFV inlet and outlet. Calibrate the CFV as follows:

(1) Configure your calibration system as shown in Figure 1 of this section.

(2) Verify that any leaks between the calibration flow meter and the CFV are less than 0.3% of the total flow at the highest restriction.

(3) Start the blower downstream of the CFV.

(4) While the CFV operates, maintain a constant temperature at the CFV inlet within  $\pm 2\%$  of the mean absolute inlet temperature,  $\bar{T}_{in}$ .

(5) Set the variable restrictor to its wide-open position. Instead of a variable restrictor, you may alternately

vary the pressure downstream of the CFV by varying blower speed or by introducing a controlled leak. Note that some blowers have limitations on nonloaded conditions.

(6) Operate the CFV for at least 3 min to stabilize the system. Continue operating the CFV and record the mean values of at least 30 seconds of sampled data of each of the following quantities:

(i) The mean flow rate of the reference flow meter,  $\bar{Q}_{ref}$ . This may include several measurements of different quantities, such as reference meter pressures and temperatures, for calculating  $\bar{Q}_{ref}$ .

(ii) The mean temperature at the venturi inlet,  $\bar{T}_{in}$ .

(iii) The mean static absolute pressure at the venturi inlet,  $\bar{p}_{in}$ .

(iv) The mean static differential pressure between the CFV inlet and the CFV outlet,  $\Delta\bar{p}_{CFV}$ .

(7) Incrementally close the restrictor valve or decrease the downstream pressure to decrease the differential pressure across the CFV,  $\Delta\bar{p}_{CFV}$ .

(8) Repeat the steps in paragraphs (h)(6) and (7) of this section to record mean data at a minimum of ten restrictor positions, such that you test the fullest practical range of  $\Delta\bar{p}_{CFV}$  expected during testing. We do not require that you remove calibration components or CVS components to calibrate at the lowest possible restriction.

(9) Determine  $K_v$  and the lowest allowable pressure ratio,  $r$ , according to § 1066.625.

(10) Use  $K_v$  to determine CFV flow during an emission test. Do not use the CFV below the lowest allowed  $r$ , as determined in § 1066.625.

(11) Verify the calibration by performing a CVS verification (i.e., propane check) as described in 40 CFR 1065.341.

(12) If your CVS is configured to operate multiple CFVs in parallel, calibrate your CVS using one of the following methods:

(i) Calibrate every combination of CFVs according to this section and § 1066.625(c). Refer to § 1066.630(c) for instructions on calculating flow rates for this option.

(ii) Calibrate each CFV according to this section and § 1066.625. Refer to § 1066.630 for instructions on calculating flow rates for this option.

(i) [Reserved]

(j) *Ultrasonic flow meter calibration.* [Reserved]

Figure 1 of § 1066.140—CVS calibration configurations

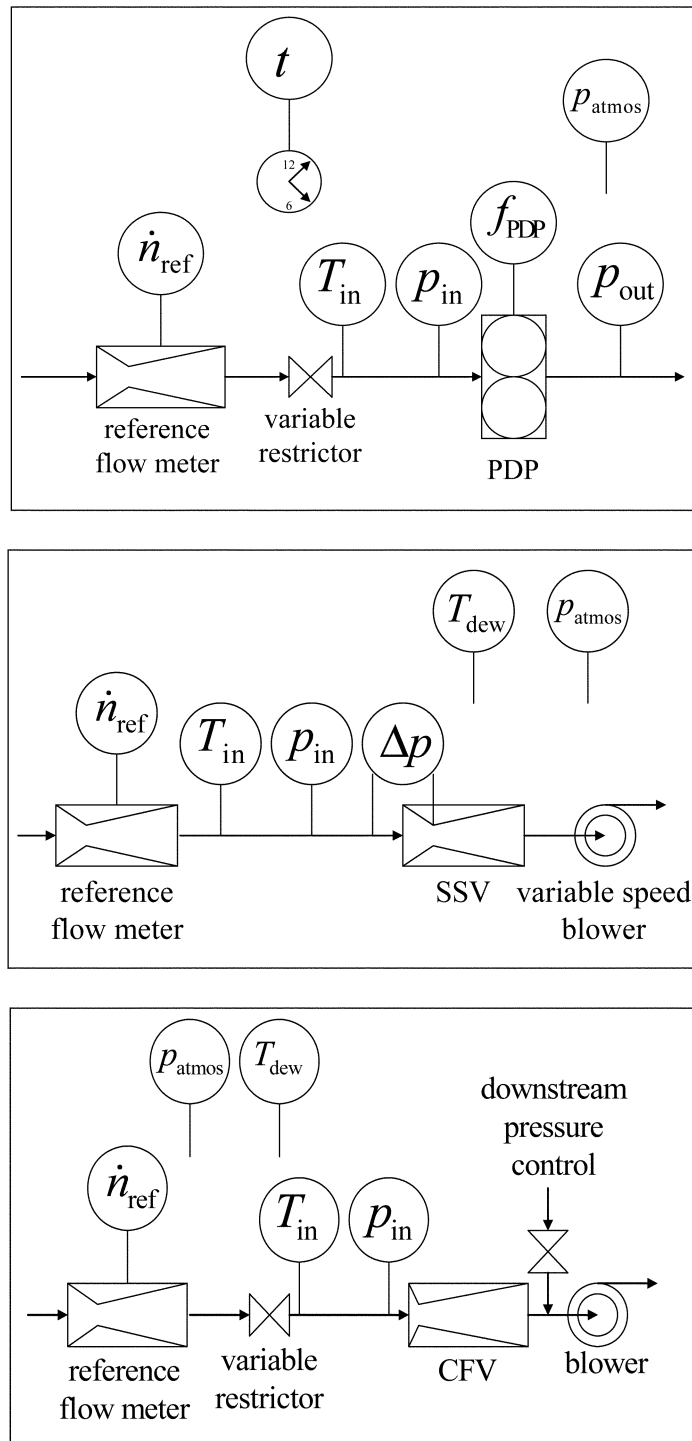

**§ 1066.145 Test fuel, engine fluids, analytical gases, and other calibration standards.**

(a) *Test fuel.* Use test fuel as specified in the standard-setting part, or as specified in 40 CFR part 1065, subpart H, if it is not specified in the standard-setting part.

(b) *Lubricating oil.* Use lubricating oil as specified in 40 CFR 1065.740. For

two-stroke engines that involve a specified mixture of fuel and lubricating oil, mix the lubricating oil with the fuel according to the manufacturer's specifications.

(c) *Coolant.* For liquid-cooled engines, use coolant as specified in 40 CFR 1065.745.

(d) *Analytical gases.* Use analytical gases that meet the requirements of 40 CFR 1065.750.

(e) *Mass standards.* Use mass standards that meet the requirements of 40 CFR 1065.790.

**§ 1066.150 Analyzer interference and quench verification limit.**

Analyzers must meet the interference and quench verification limits in the following table on the lowest, or most representative, instrument range that will be used during emission testing, instead of those specified in 40 CFR part 1065, subpart D:

TABLE 1 OF § 1066.150—ANALYZER INTERFERENCE AND QUENCH VERIFICATION LIMITS

Verification	Limit
40 CFR 1065.350	±2% of full scale.
40 CFR 1065.355	±2% of full scale.
40 CFR 1065.370	±2% of full scale.
40 CFR 1065.375	±2% of the flow-weighted mean concentration of N <sub>2</sub> O expected at the standard.

**Subpart C—Dynamometer Specifications****§ 1066.201 Dynamometer overview.**

This subpart addresses chassis dynamometers and related equipment.

**§ 1066.210 Dynamometers.**

(a) *General requirements.* A chassis dynamometer typically uses electrically generated load forces combined with its rotational inertia to recreate the mechanical inertia and frictional forces

that a vehicle exerts on road surfaces (known as “road load”). Load forces are calculated using vehicle-specific coefficients and response characteristics. The load forces are applied to the vehicle tires by rolls connected to motor/absorbers. The dynamometer uses a load cell to measure the forces the dynamometer rolls apply to the vehicle’s tires.

(b) *Accuracy and precision.* The dynamometer’s output values for road load must be NIST-traceable. We may determine traceability to a specific national or international standards organization to be sufficient to demonstrate NIST-traceability. The force-measurement system must be capable of indicating force readings as follows:

(1) For dynamometer testing of vehicles at or below 20,000 pounds GVWR, the dynamometer force-measurement system must be capable of indicating force readings during a test to a resolution of ±0.05% of the maximum load-cell force simulated by the dynamometer or ±9.8 N (±2.2 lbf), whichever is greater.

(2) For dynamometer testing of vehicles above 20,000 pounds GVWR, the force-measurement system must be capable of indicating force readings during a test to a resolution of ±0.05% of the maximum load-cell force simulated by the dynamometer or ±39.2 N (±8.8 lbf), whichever is greater.

(c) *Test cycles.* The dynamometer must be capable of fully simulating vehicle performance over applicable test cycles for the vehicles being tested as referenced in the corresponding standard-setting part, including operation at the combination of inertial and road-load forces corresponding to maximum road-load conditions and maximum simulated inertia at the highest acceleration rate experienced during testing.

(d) *Component requirements.* The following specifications apply:

(1) The nominal roll diameter must be 120 cm or greater. The dynamometer must have an independent drive roll for each drive axle as tested under § 1066.410(g), except that two drive axles may share a single drive roll. Use good engineering judgment to ensure that the dynamometer roll diameter is large enough to provide sufficient tire-roll contact area to avoid tire overheating and power losses from tire-roll slippage.

(2) Measure and record force and speed at 10 Hz or faster. You may convert measured values to 1-Hz, 2-Hz, or 5-Hz values before your calculations, using good engineering judgment.

(3) The load applied by the dynamometer simulates forces acting on the vehicle during normal driving according to the following equation:

$$FR_i = A + B \cdot v_i + C \cdot v_i^2 + M \cdot \frac{v_i - v_{i-1}}{t_i - t_{i-1}}$$

Eq. 1066.210-1

Where:

*FR* = total road-load force to be applied at the surface of the roll. The total force is the sum of the individual tractive forces applied at each roll surface.

*i* = a counter to indicate a point in time over the driving schedule. For a dynamometer operating at 10-Hz intervals over a 600-second driving schedule, the maximum value of *i* should be 6,000.

*A* = a vehicle-specific constant value representing the vehicle’s frictional load in lbf or newtons. See subpart D of this part.

*B* = a vehicle-specific coefficient representing load from drag and rolling resistance, which are a function of vehicle speed, in lbf/mph or N·s/m. See subpart D of this part.

*v* = linear speed at the roll surfaces as measured by the dynamometer, in mph or m/s. Let  $v_{i-1} = 0$  for  $i = 0$ .

*C* = a vehicle-specific coefficient representing aerodynamic effects, which are a function of vehicle speed squared, in lbf/

mph<sup>2</sup> or N·s<sup>2</sup>/m<sup>2</sup>. See subpart D of this part.

*M* = mass of the vehicle in lbm or kg based on its test weight, including the effect of rotating axles as specified in § 1066.310(b)(7), divided by the acceleration due to gravity as specified in 40 CFR 1065.630.

*t* = elapsed time in the driving schedule as measured by the dynamometer, in seconds. Let  $t_{i-1} = 0$  for  $i = 0$ .

(4) We recommend that a dynamometer capable of testing vehicles at or below 20,000 pounds GVWR be designed to apply an actual road-load force within ±1% or ±9.8 N (±2.2 lbf) of the reference value, whichever is greater. Note that slightly higher errors may be expected during highly transient operation for vehicles above 8,500 pounds GVWR.

(e) *Dynamometer manufacturer instructions.* This part specifies that you

follow the dynamometer manufacturer’s recommended procedures for things such as calibrations and general operation. If you perform testing with a dynamometer that you manufactured or if you otherwise do not have these recommended procedures, use good engineering judgment to establish the additional procedures and specifications we specify in this part, unless we specify otherwise. Keep records to describe these recommended procedures and how they are consistent with good engineering judgment, including any quantified error estimates.

**§ 1066.215 Summary of verification procedures for chassis dynamometers.**

(a) *Overview.* This section describes the overall process for verifying and calibrating the performance of chassis dynamometers.

(b) *Scope and frequency.* The following table summarizes the required and recommended calibrations and verifications described in this subpart and indicates when they must occur:

TABLE 1 OF § 1066.215—SUMMARY OF REQUIRED DYNAMOMETER VERIFICATIONS

Type of verification	Minimum frequency <sup>a</sup>
§ 1066.220: Linearity verification .....	Speed: Upon initial installation, within 370 days before testing, and after major maintenance. Torque (load): Upon initial installation and after major maintenance.
§ 1066.225: Roll runout and diameter verification.	Upon initial installation and after major maintenance.
§ 1066.230: Time verification .....	Upon initial installation and after major maintenance.
§ 1066.235: Speed measurement verification ....	Upon initial installation, within 370 days before testing, and after major maintenance.
§ 1066.240: Torque (load) transducer verification.	Upon initial installation, within 7 days of testing, and after major maintenance.
§ 1066.245: Response time verification .....	Upon initial installation, within 370 days before testing, and after major maintenance.
§ 1066.250: Base inertia verification .....	Upon initial installation and after major maintenance.
§ 1066.255: Parasitic loss verification .....	Upon initial installation, after major maintenance, and upon failure of a verification in § 1066.270 or § 1066.275.
§ 1066.260: Parasitic friction compensation verification.	Upon initial installation, after major maintenance, and upon failure of a verification in § 1066.270 or § 1066.275.
§ 1066.265: Acceleration and deceleration verification.	Upon initial installation and after major maintenance.
§ 1066.270: Unloaded coastdown verification ....	Upon initial installation, within 7 days of testing, and after major maintenance.
§ 1066.275 Dynamometer readiness verification	Upon initial installation, within 1 day before testing, and after major maintenance.

<sup>a</sup> Perform calibrations and verifications more frequently, according to measurement system manufacturer instructions and good engineering judgment.

(c) *Automated dynamometer verifications and calibrations.* In some cases, dynamometers are designed with internal diagnostic and control features to accomplish the verifications and calibrations specified in this subpart. You may use these automated functions instead of following the procedures we specify in this subpart to demonstrate compliance with applicable requirements, consistent with good engineering judgment.

(d) *Sequence of verifications and calibrations.* Upon initial installation and after major maintenance, perform the verifications and calibrations in the same sequence as noted in Table 1 of this section, except that you may perform speed linearity verification after the verifications in §§ 1066.225 and 1066.230. At other times, you may need to perform specific verifications or calibrations in a certain sequence, as noted in this subpart. If you perform major maintenance on a specific component, you are required to perform verifications and calibrations only on components or parameters that are affected by the maintenance.

(e) *Corrections.* Unless the regulation directs otherwise, if the dynamometer fails to meet any specified calibration or verification, make any necessary adjustments or repairs such that the dynamometer meets the specification before running a test. Repairs required to meet specifications are generally considered major maintenance under this part.

**§ 1066.220 Linearity verification for chassis dynamometer systems.**

(a) *Scope and frequency.* Perform linearity verification for dynamometer speed and torque at least as frequently as indicated in Table 1 of § 1066.215. The intent of linearity verification is to determine that the system responds accurately and proportionally over the measurement range of interest. Linearity verification generally consists of introducing a series of at least 10 reference values to a measurement system. The measurement system quantifies each reference value. The measured values are then collectively compared to the reference values by using a least-squares linear regression and the linearity criteria specified in Table 1 of this section.

(b) *Performance requirements.* If a measurement system does not meet the applicable linearity criteria in Table 1 of this section, correct the deficiency by recalibrating, servicing, or replacing components as needed. Repeat the linearity verification after correcting the deficiency to ensure that the measurement system meets the linearity criteria. Before you may use a measurement system that does not meet linearity criteria, you must demonstrate to us that the deficiency does not adversely affect your ability to demonstrate compliance with the applicable standards.

(c) *Procedure.* Use the following linearity verification protocol, or use good engineering judgment to develop a different protocol that satisfies the

intent of this section, as described in paragraph (a) of this section:

(1) In this paragraph (c), the letter “y” denotes a generic measured quantity, the superscript over-bar denotes an arithmetic mean (such as  $\bar{y}$ ), and the subscript “<sub>ref</sub>” denotes the known or reference quantity being measured.

(2) Operate the dynamometer system at the specified operating conditions. This may include any specified adjustment or periodic calibration of the dynamometer system.

(3) Set dynamometer speed and torque to zero.

(4) Verify the dynamometer speed or torque signal based on the dynamometer manufacturer’s recommendations.

(5) After verification, check for zero speed and torque. Use good engineering judgment to determine whether or not to rezero or re-verify speed and torque before continuing.

(6) For both speed and torque, use the dynamometer manufacturer’s recommendations and good engineering judgment to select reference values,  $y_{refi}$ , that cover a range of values that you expect would prevent extrapolation beyond these values during emission testing. We recommend selecting zero speed and zero torque as reference values for the linearity verification.

(7) Use the dynamometer manufacturer’s recommendations and good engineering judgment to select the order in which you will introduce the series of reference values. For example, you may select the reference values randomly to avoid correlation with previous measurements and to avoid the

influence of hysteresis; you may select reference values in ascending or descending order to avoid long settling times of reference signals; or you may select values to ascend and then descend to incorporate the effects of any instrument hysteresis into the linearity verification.

(8) Set the dynamometer to operate at a reference condition.

(9) Allow time for the dynamometer to stabilize while it measures the reference values.

(10) At a recording frequency of at least 1 Hz, measure speed and torque values for 30 seconds and record the arithmetic mean of the recorded values. Refer to 40 CFR 1065.602 for an example of calculating an arithmetic mean.

(11) Repeat the steps in paragraphs (c)(8) through (10) of this section until you measure speeds and torques at each of the reference settings.

(12) Use the arithmetic means,  $\bar{y}_i$ , and reference values,  $y_{refi}$ , to calculate least-

squares linear regression parameters and statistical values to compare to the minimum performance criteria specified in Table 1 of this section. Use the calculations described in 40 CFR 1065.602. Using good engineering judgment, you may weight the results of individual data pairs (i.e.,  $(y_{refi}, \bar{y}_i)$ ), in the linear regression calculations. Table 1 follows:

TABLE 1 OF § 1066.220—DYNAMOMETER MEASUREMENT SYSTEMS THAT REQUIRE LINEARITY VERIFICATIONS

Measurement system	Quantity	Linearity criteria			
		$ y_{min} \cdot (a_1 - 1) + a_0 $	$a_1$	SEE	$r^2$
Speed .....	$v$	$\leq 0.05\% \cdot v_{max}$ .....	0.98–1.02	$\leq 2\% \cdot v_{max}$ .....	$\geq 0.990$
Torque (load) .....	$T$	$\leq 1\% \cdot T_{max}$ .....	0.99–1.01	$\leq 1\% \cdot T_{max}$ .....	$\geq 0.990$

(d) *Reference signals.* Generate reference values for the linearity-verification protocol in paragraph (c) of this section as described for speed and torque in 40 CFR 1065.307(d).

**§ 1066.225 Roll runout and diameter verification procedure.**

(a) *Overview.* This section describes the verification procedure for roll runout and roll diameter. Roll runout is a measure of the variation in roll radius around the circumference of the roll.

(b) *Scope and frequency.* Perform these verifications upon initial installation and after major maintenance that could affect roll surface finish or dimensions (such as resurfacing or polishing).

(c) *Roll runout procedure.* Verify roll runout based on the following procedure, or an equivalent procedure based on good engineering judgment:

(1) Perform this verification with laboratory and dynamometer temperatures stable and at equilibrium. Release the roll brake and shut off power to the dynamometer. Remove any dirt, rubber, rust, and debris from the roll surface. Mark measurement locations on the roll surface using a marker. Mark the roll at a minimum of four equally spaced locations across the roll width; we recommend taking measurements every 150 mm across the roll. Secure the marker to the deck plate adjacent to the roll surface and slowly rotate the roll to mark a clear line around the roll circumference. Repeat this process for all measurement locations.

(2) Measure roll runout using an indicator with a probe that allows for measuring the position of the roll surface relative to the roll centerline as it turns through a complete revolution.

The indicator must have some means of being securely mounted adjacent to the roll. The indicator must have sufficient range to measure roll runout at all points, with a minimum accuracy of  $\pm 0.025$  mm. Calibrate the indicator according to the instrument manufacturer's instructions.

(3) Position the indicator adjacent to the roll surface at the desired measurement location. Position the shaft of the indicator perpendicular to the roll such that the point of the indicator is slightly touching the surface of the roll and can move freely through a full rotation of the roll. Zero the indicator according to the instrument manufacturer's instructions. Avoid distortion of the runout measurement from the weight of a person standing on or near the mounted dial indicator.

(4) Slowly turn the roll through a complete rotation and record the maximum and minimum values from the indicator. Calculate runout as the difference between these maximum and minimum values.

(5) Repeat the steps in paragraphs (c)(3) and (4) of this section for all measurement locations.

(6) The roll runout must be less than 0.254 mm (0.0100 inches) at all measurement locations.

(d) *Diameter procedure.* Verify roll diameter based on the following procedure, or an equivalent procedure based on good engineering judgment:

(1) Prepare the laboratory and the dynamometer as specified in paragraph (c)(1) of this section.

(2) Measure roll diameter using a Pi Tape®. Orient the Pi Tape® to the marker line at the desired measurement location with the Pi Tape® hook pointed outward. Temporarily secure the Pi Tape® to the roll near the hook end with

adhesive tape. Slowly turn the roll, wrapping the Pi Tape® around the roll surface. Ensure that the Pi Tape® is flat and adjacent to the marker line around the full circumference of the roll. Attach a 2.26-kg weight to the hook of the Pi Tape® and position the roll so that the weight dangles freely. Remove the adhesive tape without disturbing the orientation or alignment of the Pi Tape®.

(3) Overlap the gage member and the vernier scale ends of the Pi Tape® to read the diameter measurement to the nearest 0.01 mm. Follow the manufacturer's recommendation to correct the measurement to 20 °C, if applicable.

(4) Repeat the steps in paragraphs (d)(2) and (3) of this section for all measurement locations.

(5) The measured roll diameter must be within  $\pm 0.254$  mm of the specified nominal value at all measurement locations. You may revise the nominal value to meet this specification, as long as you use the corrected nominal value for all calculations in this subpart.

**§ 1066.230 Time verification procedure.**

(a) *Overview.* This section describes how to verify the accuracy of the dynamometer's timing device.

(b) *Scope and frequency.* Perform this verification upon initial installation and after major maintenance.

(c) *Procedure.* Perform this verification using one of the following procedures:

(1) *WWV method.* You may use the time and frequency signal broadcast by NIST from radio station WWV as the time standard if the trigger for the dynamometer timing circuit has a frequency decoder circuit, as follows:

(i) Contact station WWV by telephone by dialing (303) 499-7111 and listen for the time announcement. Verify that the trigger started the dynamometer timer. Use good engineering judgment to minimize error in receiving the time and frequency signal.

(ii) After at least 1000 seconds, re-dial station WWV and listen for the time announcement. Verify that the trigger stopped the dynamometer timer.

(iii) Compare the measured elapsed time,  $y_{act}$ , to the corresponding time standard,  $y_{ref}$ , to determine the time error,  $y_{error}$ , using the following equation:

$$y_{error} = \frac{y_{act} - y_{ref}}{y_{ref}} \cdot 100 \%$$

### Eq. 1066.230-1

(2) *Ramping method.* You may use an operator-defined ramp function to serve as the time standard as follows:

(i) Set up a signal generator to output a marker voltage at the peak of each ramp to trigger the dynamometer timing circuit. Output the designated marker voltage to start the verification period.

(ii) After at least 1000 seconds, output the designated marker voltage to end the verification period.

(iii) Compare the measured elapsed time between marker signals,  $y_{act}$ , to the corresponding time standard,  $y_{ref}$ , to determine the time error,  $y_{error}$ , using Eq. 1066.230-1.

(3) *Dynamometer coastdown method.* You may use a signal generator to output a known speed ramp signal to the dynamometer controller to serve as the time standard as follows:

(i) Generate upper and lower speed values to trigger the start and stop functions of the coastdown timer circuit. Use the signal generator to start the verification period.

(ii) After at least 1000 seconds, use the signal generator to end the verification period.

(iii) Compare the measured elapsed time between trigger signals,  $y_{act}$ , to the corresponding time standard,  $y_{ref}$ , to determine the time error,  $y_{error}$ , using Eq. 1066.230-1.

(d) *Performance evaluation.* The time error determined in paragraph (c) of this section may not exceed  $\pm 0.001\%$ .

### § 1066.235 Speed verification procedure.

(a) *Overview.* This section describes how to verify the accuracy of the dynamometer speed determination. When performing this verification, you must also ensure the dynamometer speed at any devices used to display or

record vehicle speed (such as a driver's aid) is representative of the speed input from the dynamometer speed determination.

(b) *Scope and frequency.* Perform this verification upon initial installation, within 370 days before testing, and after major maintenance.

(c) *Procedure.* Use one of the following procedures to verify the accuracy and resolution of the dynamometer speed simulation:

(1) *Pulse method.* Connect a universal frequency counter to the output of the dynamometer's speed-sensing device in parallel with the signal to the dynamometer controller. The universal frequency counter must be calibrated according to the counter manufacturer's instructions and be capable of measuring with enough accuracy to perform the procedure as specified in this paragraph (c)(1). Make sure the instrumentation does not affect the signal to the dynamometer control circuits. Determine the speed error as follows:

(i) Set the dynamometer to speed-control mode. Set the dynamometer speed to a value of approximately 4.5 m/s (10 mph); record the output of the frequency counter after 10 seconds. Determine the roll speed,  $v_{act}$ , using the following equation:

$$x_{THCE} = x_{NOTHC} + \sum_{i=1}^N (x_{OHCi} - x_{OHCi-init})$$

### Eq. 1065.665-1

$$x_{NOTHC} = x_{THC[THC-FID]cor} - \sum_{i=1}^N ((x_{OHCi} - x_{OHCi-init}) \cdot RF_{OHCi[THC-FID]})$$

### Eq. 1065.665-2

$$x_{OHCi} = \frac{\frac{m_{dexhOHCi}}{M_{OHCi}}}{\frac{m_{dexh}}{M_{dexh}}} = \frac{n_{dexhOHCi}}{n_{dexh}}$$

### Eq. 1065.665-3

Where:

$f$  = frequency of the dynamometer speed sensing device, accurate to at least four significant figures.

$d_{roll}$  = nominal roll diameter, accurate to the nearest 1.0 mm, consistent with § 1066.225(d).

$n$  = the number of pulses per revolution from the dynamometer roll speed sensor.

Example:

$f = 2.9231 \text{ Hz} = 2.9231 \text{ s}^{-1}$

$d_{roll} = 904.40 \text{ mm} = 0.90440 \text{ m}$

$n = 1 \text{ pulse/rev}$

$$v_{act} = \frac{2.9231 \cdot 0.90440 \cdot \pi}{1}$$

$$v_{act} = 8.3053 \text{ m/s}$$



(ii) Repeat the steps in paragraph (c)(1)(i) of this section for the maximum speed expected during testing and at least two additional evenly spaced speed points between the starting speed and the maximum speed point.

(iii) Compare the calculated roll speed,  $v_{act}$ , to each corresponding speed set point,  $v_{ref}$ , to determine values for speed error at each set point,  $v_{error}$ , using the following equation:

$$v_{error} = v_{act} - v_{ref}$$

Eq. 1066.235-2

Example:

$$v_{act} = 8.3053 \text{ m/s}$$

$$v_{ref} = 8.3000 \text{ m/s}$$

$$v_{error} = 8.3053 - 8.3000 = 0.0053 \text{ m/s}$$

(2) *Frequency method.* Install a piece of tape in the shape of an arrowhead on the surface of the dynamometer roll near the outer edge. Put a reference mark on the deck plate in line with the tape. Install a stroboscope or photo tachometer on the deck plate and direct the flash toward the tape on the roll. The stroboscope or photo tachometer must be calibrated according to the instrument manufacturer's instructions and be capable of measuring with enough accuracy to perform the

procedure as specified in this paragraph (c)(2). Determine the speed error as follows:

(i) Set the dynamometer to speed-control mode. Set the dynamometer speed to a speed value of approximately 4.5 m/s (10 mph). Tune the stroboscope or photo tachometer until the signal matches the dynamometer roll speed. Record the frequency. Determine the roll speed,  $y_{act}$ , using Eq. 1066.235-1, using the stroboscope or photo tachometer's frequency for  $f$ .

(ii) Repeat the steps in paragraph (c)(2)(i) of this section for the maximum speed expected during testing and at least two additional evenly spaced speed points between the starting speed and the maximum speed point.

(iii) Compare the calculated roll speed,  $v_{act}$ , to each corresponding speed set point,  $v_{ref}$ , to determine values for speed error at each set point,  $y_{error}$ , using Eq. 1066.235-2.

(d) *Performance evaluation.* The speed error determined in paragraph (c) of this section may not exceed  $\pm 0.02$  m/s at any speed set point.

#### § 1066.240 Torque transducer verification.

Verify torque-measurement systems by performing the verifications described in §§ 1066.270 and 1066.275.

#### § 1066.245 Response time verification.

(a) *Overview.* This section describes how to verify the dynamometer's response time to a step change in tractive force.

(b) *Scope and frequency.* Perform this verification upon initial installation, within 370 days before testing (i.e., annually), and after major maintenance.

(c) *Procedure.* Use the dynamometer's automated process to verify response time. You may perform this test either at two different inertia settings corresponding approximately to the minimum and maximum vehicle weights you expect to test or using base inertia and two acceleration rates that cover the range of acceleration rates experienced during testing (such as 0.5 and 8 mph/s). Use good engineering judgment to select road-load coefficients representing vehicles of the appropriate weight. Determine the dynamometer's settling response time,  $t_s$ , based on the point at which there are no measured results more than 10% above or below the final equilibrium value, as illustrated in Figure 1 of this section. The observed settling response time must be less than 100 milliseconds for each inertia setting.

Figure 1 of § 1066.245—Example of a settling response time diagram

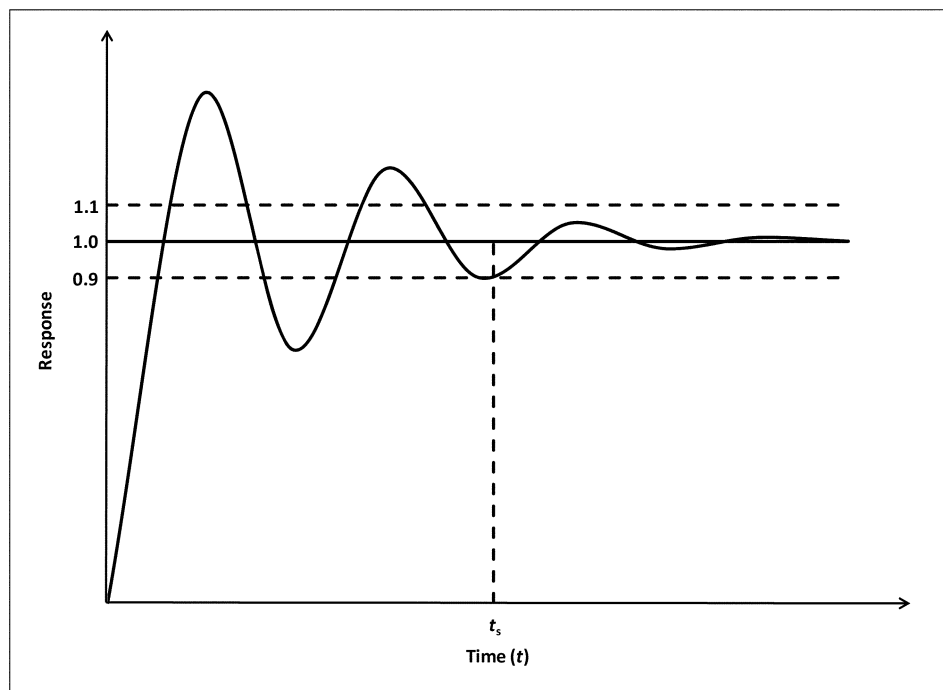

**§ 1066.250 Base inertia verification.**

(a) *Overview.* This section describes how to verify the dynamometer's base inertia.

(b) *Scope and frequency.* Perform this verification upon initial installation and after major maintenance, such as maintenance that could affect roll inertia.

(c) *Procedure.* Verify the base inertia using the following procedure:

(1) Warm up the dynamometer according to the dynamometer manufacturer's instructions. Set the dynamometer's road-load inertia to zero, turning off any electrical simulation of road load and inertia so that the base inertia of the dynamometer is the only inertia present. Motor the rolls to 5 mph. Apply a constant force to accelerate the roll at a nominal rate of 1 mph/s. Measure the elapsed time to accelerate from 10 to 40 mph, noting the corresponding speed and time points to the nearest 0.01 mph and 0.01 s. Also determine average force over the measurement interval.

(2) Starting from a steady roll speed of 45 mph, apply a constant force to the roll to decelerate the roll at a nominal rate of 1 mph/s. Measure the elapsed time to decelerate from 40 to 10 mph, noting the corresponding speed and time points to the nearest 0.01 mph and 0.01 s. Also determine average force over the measurement interval.

(3) Repeat the steps in paragraphs (c)(1) and (2) of this section for a total of five sets of results at the nominal acceleration rate and the nominal deceleration rate.

(4) Use good engineering judgment to select two additional acceleration and deceleration rate pairs that cover the middle and upper rates expected during testing. Repeat the steps in paragraphs (c)(1) through (3) of this section at each of these additional acceleration and deceleration rates.

(5) Determine the base inertia,  $I_b$ , for each measurement interval using the following equation:

$$I_b = \frac{F}{\left| \frac{v_{\text{final}} - v_{\text{init}}}{\Delta t} \right|}$$

Eq. 1066.250-1

Where:

$F$  = average dynamometer force over the measurement interval as measured by the dynamometer.

$v_{\text{final}}$  = roll surface speed at the end of the measurement interval to the nearest 0.01 mph.

$v_{\text{init}}$  = roll surface speed at the start of the measurement interval to the nearest 0.01 mph.

$\Delta t$  = elapsed time during the measurement interval to the nearest 0.01 s.

*Example:*

$$F = 1.500 \text{ lbf} = 48.26 \text{ ft}\cdot\text{lbf}/\text{s}^2$$

$$v_{\text{final}} = 40.00 \text{ mph} = 58.67 \text{ ft/s}$$

$$v_{\text{init}} = 10.00 \text{ mph} = 14.67 \text{ ft/s}$$

$$\Delta t = 30.00 \text{ s}$$

$$I_b = \frac{48.26}{\left| \frac{58.67 - 14.67}{30.00} \right|}$$

$$I_b = 32.90 \text{ lbf}$$

(6) Calculate the base inertia error,  $I_{\text{berror}}$ , for each of the thirty measured base inertia values,  $I_b$ , by comparing it to the manufacturer's stated base inertia,  $I_{\text{bref}}$ , using the following equation:

$$I_{\text{berror}} = \frac{I_{\text{bref}} - I_{\text{bact}}}{I_{\text{bref}}} \cdot 100 \%$$

Eq. 1066.250-2

*Example:*

$I_{\text{bref}} = 32.96 \text{ lbf}$

$I_{\text{bact}} = 32.90 \text{ lbf}$  (from paragraph (c)(5) of this section)

$$I_{\text{berror}} = \frac{32.96 - 32.90}{32.96} \cdot 100 \%$$

$$I_{\text{berror}} = 0.18 \%$$

(7) Determine the base inertia mean value  $\bar{I}_b$ , from the ten acceleration and deceleration interval base inertia values for each of the three acceleration/ deceleration rates. Then determine the base inertia mean value,  $\bar{I}_b$ , from the base inertia values corresponding to acceleration/ deceleration rates. Calculate base inertia mean values as described in 40 CFR 1065.602(b)

(8) Calculate the inertia error for the final base inertia mean value from paragraph (c)(7) of this section. Use Eq. 1066.250-2, substituting the final base inertia mean value from paragraph (c)(7) of this section for the individual base inertia.

(d) *Performance evaluation.* The dynamometer must meet the following

specifications to be used for testing under this part:

(1) All base inertia errors determined under paragraph (c)(6) of this section may not exceed  $\pm 1.0\%$ .

(2) The inertia error for the final base inertia mean value determined under paragraph (c)(8) of this section may not exceed  $\pm 0.20\%$ .

**§ 1066.255 Parasitic loss verification.**

(a) *Overview.* Verify the dynamometer's parasitic loss as described in this section, and correct as necessary. This procedure determines the dynamometer's internal losses that it must overcome to simulate road load. Characterize these losses in a parasitic loss curve that the dynamometer uses to apply compensating forces to maintain the desired road-load force at the roll surface.

(b) *Scope and frequency.* Perform this verification upon initial installation, after major maintenance, and upon failure of a verification in either § 1066.270 or § 1066.275.

(c) *Procedure.* Perform this verification by following the dynamometer manufacturer's specifications to establish a parasitic loss curve, taking data at fixed speed intervals to cover the range of vehicle speeds that will occur during testing. You may zero the load cell at a selected speed if that improves your ability to determine the parasitic loss. Parasitic loss forces may never be negative. Note that the torque transducers must be zeroed and spanned prior to performing this procedure.

(d) *Performance evaluation.* Some dynamometers automatically update the parasitic loss curve for further testing. If this is not the case, compare the new parasitic loss curve to the original parasitic loss curve from the dynamometer manufacturer or the most recent parasitic loss curve you programmed into the dynamometer. You may reprogram the dynamometer to accept the new curve in all cases, and you must reprogram the dynamometer if any point on the new curve departs from the earlier curve by more than  $\pm 9.0 \text{ N}$  for dynamometers capable of testing vehicles at or below 20,000 pounds GVWR, or  $\pm 36.0 \text{ N}$  ( $\pm 8.0 \text{ lbf}$ ) for dynamometers not capable of testing vehicles at or below 20,000 pounds GVWR.

**§ 1066.260 Parasitic friction compensation evaluation.**

(a) *Overview.* This section describes how to verify the accuracy of the dynamometer's friction compensation.

(b) *Scope and frequency.* Perform this verification upon initial installation,

after major maintenance, and upon failure of a verification in either § 1066.270 or § 1066.275. Note that this procedure relies on proper verification of speed and torque, as described in §§ 1066.235 and 1066.240. You must also first verify the dynamometer's parasitic loss curve as specified in § 1066.255.

(c) *Procedure.* Use the following procedure to verify the accuracy of the dynamometer's friction compensation:

(1) Warm up the dynamometer as specified by the dynamometer manufacturer.

(2) Perform a torque verification as specified by the dynamometer manufacturer. For torque verifications relying on shunt procedures, if the results do not conform to specifications, recalibrate the dynamometer using NIST-traceable standards as appropriate until the dynamometer passes the torque verification. Do not change the dynamometer's base inertia to pass the torque verification.

(3) Set the dynamometer inertia to the base inertia with the road-load coefficients A, B, and C set to 0. Set the dynamometer to speed-control mode with a target speed of 50 mph or a higher speed recommended by the dynamometer manufacturer. Once the speed stabilizes at the target speed, switch the dynamometer from speed-control to torque-control and allow the roll to coast for 60 seconds. Record the initial and final speeds and the corresponding start and stop times. If friction compensation is executed perfectly, there will be no change in speed during the measurement interval.

(4) Calculate the power equivalent of friction compensation error,  $FC_{\text{error}}$ , using the following equation:

$$FC_{\text{error}} = \frac{I}{2 \cdot t} \cdot (v_{\text{init}}^2 - v_{\text{final}}^2)$$

Eq. 1066.260-1

Where:

$I$  = dynamometer inertia setting.

$t$  = duration of the measurement interval, accurate to at least 0.01 s.

$v_{\text{init}}$  = the roll speed corresponding to the start of the measurement interval, accurate to at least 0.05 mph.

$v_{\text{final}}$  = the roll speed corresponding to the end of the measurement interval, accurate to at least 0.05 mph.

*Example:*

$$I = 2000 \text{ lbm} = 62.16 \text{ lbf} \cdot \text{s}^2/\text{ft}$$

$$t = 60.0 \text{ s}$$

$$v_{\text{init}} = 9.2 \text{ mph} = 13.5 \text{ ft/s}$$

$$v_{\text{final}} = 10.0 \text{ mph} = 14.7 \text{ ft/s}$$

$$FC_{\text{error}} = \frac{62.16}{2 \cdot 60.00} \cdot (13.5^2 - 14.7^2)$$

$$FC_{\text{error}} = -16.5 \text{ ft} \cdot \text{lbf/s} = -0.031 \text{ hp}$$

(5) The friction compensation error may not exceed  $\pm 0.15$  hp for dynamometers capable of testing vehicles at or below 20,000 pounds GVWR, or  $\pm 0.6$  hp for dynamometers not capable of testing vehicles at or below 20,000 pounds GVWR.

#### § 1066.265 Acceleration and deceleration verification.

(a) *Overview.* This section describes how to verify the dynamometer's ability to achieve targeted acceleration and deceleration rates. Paragraph (c) of this section describes how this verification applies when the dynamometer is programmed directly for a specific acceleration or deceleration rate. Paragraph (d) of this section describes how this verification applies when the dynamometer is programmed with a calculated force to achieve a targeted acceleration or deceleration rate.

(b) *Scope and frequency.* Perform this verification or an equivalent procedure upon initial installation and after major maintenance that could affect acceleration and deceleration accuracy. Note that this procedure relies on proper verification of speed as described in § 1066.235.

(c) *Verification of acceleration and deceleration rates.* Activate the dynamometer's function generator for measuring roll revolution frequency. If the dynamometer has no such function generator, set up a properly calibrated external function generator consistent with the verification described in this paragraph (c). Use the function generator to determine actual acceleration and deceleration rates as the dynamometer traverses speeds between 10 and 40 mph at various nominal acceleration and deceleration rates. Verify the dynamometer's acceleration and deceleration rates as follows:

(1) Set up start and stop frequencies specific to your dynamometer by identifying the roll-revolution frequency,  $f$ , in revolutions per second (or Hz) corresponding to 10 mph and 40 mph vehicle speeds, accurate to at least four significant figures, using the following equation:

$$f = \frac{v \cdot n}{d_{\text{roll}} \cdot \pi}$$

Eq. 1066.265-1

Where:

$v$  = the target roll speed, in inches per second (corresponding to drive speeds of 10 mph or 40 mph).

$n$  = the number of pulses from the dynamometer's roll-speed sensor per roll revolution.

$d_{\text{roll}}$  = roll diameter, in inches.

(2) Program the dynamometer to accelerate the roll at a nominal rate of 1 mph/s from 10 mph to 40 mph. Measure the elapsed time to reach the target speed, to the nearest 0.01 s. Repeat this measurement for a total of five runs. Determine the actual acceleration rate for each run,  $a_{\text{act}}$ , using the following equation:

$$a_{\text{act}} = \frac{v_{\text{final}} - v_{\text{init}}}{t}$$

Eq. 1066.265-2

Where:

$a_{\text{act}}$  = acceleration rate (decelerations have negative values).

$v_{\text{final}}$  = the target value for the final roll speed.

$v_{\text{init}}$  = the setpoint value for the initial roll speed.

$t$  = time to accelerate from  $v_{\text{init}}$  to  $v_{\text{final}}$ .

Example:

$v_{\text{final}} = 40 \text{ mph}$

$$v_{\text{init}} = 10 \text{ mph}$$

$$t = 30.003 \text{ s}$$

$$a_{\text{act}} = \frac{40.00 - 10.00}{30.03}$$

$$a_{\text{act}} = 0.999 \text{ mph/s}$$

(3) Program the dynamometer to decelerate the roll at a nominal rate of 1 mph/s from 40 mph to 10 mph. Measure the elapsed time to reach the target speed, to the nearest 0.01 s. Repeat this measurement for a total of five runs. Determine the actual acceleration rate,  $a_{\text{act}}$ , using Eq. 1066.265-2.

(4) Repeat the steps in paragraphs (c)(2) and (3) of this section for additional acceleration and deceleration rates in 1 mph/s increments up to and including one increment above the maximum acceleration rate expected during testing. Average the five repeat runs to calculate a mean acceleration rate,  $\bar{a}_{act}$ , at each setting.

(5) Compare each mean acceleration rate,  $\bar{a}_{act}$ , to the corresponding nominal acceleration rate,  $a_{ref}$ , to determine values for acceleration error,  $a_{error}$ , using the following equation:

$$a_{error} = \frac{\bar{a}_{act} - a_{ref}}{a_{ref}} \cdot 100\%$$

Eq. 1066.265-3

Example:

$\bar{a}_{act} = 0.999$  mph/s

$a_{ref} = 1$  mph/s

$$a_{error} = \frac{0.999 - 1}{1} \cdot 100\%$$

$$a_{error} = -0.100\%$$

(d) *Verification of forces for controlling acceleration and deceleration.* Program the dynamometer with a calculated force value and determine actual acceleration and deceleration rates as the dynamometer traverses speeds between 10 and 40 mph at various nominal acceleration and deceleration rates. Verify the dynamometer's ability to achieve certain acceleration and deceleration rates with a given force as follows:

(1) Calculate the force setting,  $F$ , using the following equation:

$$F = I_b \cdot |a|$$

Eq. 1066.265-4

Where:

$I_b$  = the dynamometer manufacturer's stated base inertia, in lbf·s<sup>2</sup>/ft.

$a$  = nominal acceleration rate, in ft/s<sup>2</sup>.

Example:

$I_b = 2967$  lbm = 92.217 lbf·s<sup>2</sup>/ft

$a = 1$  mph/s = 1.4667 ft/s<sup>2</sup>

$F = 92.217 \cdot |1.4667|$

$F = 135.25$  lbf

(2) Set the dynamometer to road-load mode and program it with a calculated force to accelerate the roll at a nominal rate of 1 mph/s from 10 mph to 40 mph. Measure the elapsed time to reach the target speed, to the nearest 0.01 s. Repeat this measurement for a total of five runs. Determine the actual acceleration rate,  $a_{act}$ , for each run using Eq. 1066.265-2. Repeat this step to

determine measured "negative acceleration" rates using a calculated force to decelerate the roll at a nominal rate of 1 mph/s from 40 mph to 10 mph. Average the five repeat runs to calculate a mean acceleration rate,  $\bar{a}_{act}$ , at each setting.

(3) Repeat the steps in paragraph (d)(2) of this section for additional acceleration and deceleration rates as specified in paragraph (c)(4) of this section.

(4) Compare each mean acceleration rate,  $\bar{a}_{act}$ , to the corresponding nominal acceleration rate,  $a_{ref}$ , to determine values for acceleration error,  $a_{error}$ , using Eq. 1066.265-3.

(e) *Performance evaluation.* The acceleration error from paragraphs (c)(5) and (d)(4) of this section may not exceed  $\pm 1.0\%$ .

#### § 1066.270 Unloaded coastdown verification.

(a) *Overview.* Use force measurements to verify the dynamometer's settings based on coastdown procedures.

(b) *Scope and frequency.* Perform this verification upon initial installation, within 7 days of testing, and after major maintenance.

(c) *Procedure.* This procedure verifies the dynamometer's settings derived from coastdown testing. For dynamometers that have an automated process for this procedure, perform this evaluation by setting the initial speed, final speed, inertial coefficients, and road-load coefficients as required for each test, using good engineering judgment to ensure that these values properly represent in-use operation. Use the following procedure if your dynamometer does not perform this verification with an automated process:

(1) Warm up the dynamometer as specified by the dynamometer manufacturer.

(2) With the dynamometer in coastdown mode, set the dynamometer inertia for the smallest vehicle weight that you expect to test and set A, B, and C road-load coefficients to values typical of those used during testing. Program the dynamometer to coast down over the dynamometer operational speed range (typically from a speed of 80 mph through a minimum speed at or below 10 mph). Perform at least one coastdown over this speed range, collecting data over each 10 mph interval.

(3) Repeat the steps in paragraph (c)(2) of this section with the dynamometer inertia and road-load coefficients set for the largest vehicle weight that you expect to test.

(4) Determine the average coastdown force,  $F$ , for each speed and inertia

setting for each of the coastdowns performed using the following equation:

$$F = \frac{I \cdot (v_{init} - v_{final})}{t}$$

Eq. 1066.270-1

Where:

$F$  = the average force measured during the coastdown for each speed interval and inertia setting, expressed in lbf·s<sup>2</sup>/ft and rounded to four significant figures.

$I$  = the dynamometer's inertia setting, in lbf·s<sup>2</sup>/ft.

$v_{init}$  = the speed at the start of the coastdown interval, expressed in ft/s to at least four significant figures.

$v_{final}$  = the speed at the end of the coastdown interval, expressed in ft/s to at least four significant figures.

$t$  = coastdown time for each speed interval and inertia setting, accurate to at least 0.01 s.

Example:

$$I = 2000 \text{ lbm} = 65.17 \text{ lbf}\cdot\text{s}^2/\text{ft}$$

$$v_{init} = 25 \text{ mph} = 36.66 \text{ ft/s}$$

$$v_{final} = 15 \text{ mph} = 22.0 \text{ ft/s}$$

$$t = 5.00 \text{ s}$$

$$F = \frac{65.17 \cdot (36.66 - 22.0)}{5.00}$$

$$F = 191.1 \text{ lbf}$$

(5) Calculate the target value of coastdown force,  $F_{ref}$ , based on the applicable dynamometer parameters for each speed interval and inertia setting.

(6) Compare the mean value of the coastdown force measured for each speed interval and inertia setting,  $\bar{F}_{act}$ , to the corresponding  $F_{ref}$  to determine values for coastdown force error,  $F_{error}$ , using the following equation:

$$F_{error} = \left| \frac{\bar{F}_{act} - F_{ref}}{F_{ref}} \right| \cdot 100\%$$

Eq. 1066.270-2

*Example:*

$$F_{\text{ref}} = 192 \text{ lbf}$$

$$\bar{F}_{\text{act}} = 191 \text{ lbf}$$

$$F_{\text{error}} = \left| \frac{191 - 192}{192} \right| \cdot 100 \%$$

$$F_{\text{error}} = 0.5 \%$$

(d) *Performance evaluation.* The coastdown force error determined in paragraph (c) of this section may not exceed the following:

(1) For vehicles at or below 20,000 pounds GVWR, calculate  $F_{\text{errormax}}$  for all speed and inertia settings from the following formula:

$$F_{\text{errormax}} (\%) = (2.2 \text{ lbf}/F_{\text{ref}}) \cdot 100$$

Eq. 1066.270-3

*Example:*

$$F_{\text{ref}} = 192 \text{ lbf}$$

$$F_{\text{errormax}} (\%) = (2.2/192) \cdot 100 = 1.14 \%$$

(2) For vehicles above 20,000 pounds GVWR, the maximum allowable error,  $F_{\text{errormax}}$ , for all speed intervals and inertia settings is  $\pm 1.0\%$  or  $\pm 39.2 \text{ N}$ , whichever is greater.

(e) *Remedy for nonconforming dynamometers.* If the dynamometer is not able to meet this requirement, diagnose and repair the dynamometer before continuing with emission testing. Diagnosis should include performing the verifications in § 1066.255 and § 1066.260.

#### § 1066.275 Daily dynamometer readiness verification.

(a) *Overview.* This section describes how to verify that the dynamometer is ready for emission testing.

(b) *Scope and frequency.* Perform this verification upon initial installation, within 1 day before testing, and after major maintenance.

(c) *Procedure.* For dynamometers that have an automated process for this verification procedure, perform this evaluation by setting the initial speed and final speed and the inertial and road-load coefficients as required for the test, using good engineering judgment to ensure that these values properly represent in-use operation. Use the following procedure if your dynamometer does not perform this verification with an automated process:

(1) With the dynamometer in coastdown mode, set the dynamometer inertia to the base inertia with the road-

load coefficient A set to 20 lbf (or a force that results in a coastdown time of less than 10 minutes) and coefficients B and C set to 0. Program the dynamometer to coast down for one 10 mph interval from 55 mph down to 45 mph. If your dynamometer is not capable of performing one discrete coastdown, then coast down with preset 10 mph intervals that include a 55 mph to 45 mph interval.

(2) Perform the coastdown.

(3) Determine the coastdown force and coastdown force error using Eqs. 1066.270-1 and 1066.270-2.

(d) *Performance evaluation.* The coastdown force error determined in paragraph (c) of this section may not exceed the following:

(1) For vehicles at or below 20,000 pounds GVWR,  $\pm 1.0\%$  or  $\pm 9.8 \text{ N}$  ( $\pm 2.2 \text{ lbf}$ ), whichever is greater.

(2) For vehicles above 20,000 pounds GVWR,  $\pm 1.0\%$  or  $\pm 39.2 \text{ N}$  ( $\pm 8.8 \text{ lbf}$ ), whichever is greater.

(e) *Remedy for nonconforming dynamometers.* If the verification results fail to meet the performance criteria in paragraph (d) of this section, perform the procedure up to two additional times. If the dynamometer is consistently unable to meet the performance criteria, diagnose and repair the dynamometer before continuing with emission testing. Diagnosis should include performing the verifications in § 1066.255 and § 1066.260.

#### § 1066.290 Verification of speed accuracy for the driver's aid.

Use good engineering judgment to provide a driver's aid that facilitates compliance with the requirements of § 1066.425. Verify the speed accuracy of the driver's aid as described in § 1066.235.

### Subpart D—Coastdown

#### § 1066.301 Overview of coastdown procedures.

(a) The coastdown procedures described in this subpart are used to determine the load coefficients (A, B, and C) for the simulated road-load equation in § 1066.210(d)(3).

(b) The general procedure for performing coastdown tests and calculating load coefficients is described in SAE J1263 and SAE J2263 (incorporated by reference in § 1066.1010). This subpart specifies certain deviations from those procedures for certain applications.

(c) Use good engineering judgment for all aspects of coastdown testing. For example, minimize the effects of grade by performing coastdown testing on

reasonably level surfaces and determining coefficients based on average values from vehicle operation in opposite directions over the course.

#### § 1066.305 Coastdown procedures for motor vehicles at or below 14,000 pounds GVWR.

For motor vehicles at or below 14,000 pounds GVWR, develop representative road-load coefficients to characterize each test vehicle. Calculate road-load coefficients by performing coastdowns using the provisions of SAE J1263 and SAE J2263 (incorporated by reference in § 1066.1010). Perform coastdowns at a starting speed as specified in SAE J2263, or at the highest speed from the range of applicable duty cycles. Use the same road-load coefficients for all duty cycles. However, if your test conditions are substantially different from the conditions represented by your road-load coefficients, such as cold temperature testing, you may use good engineering judgment to develop separate road-load coefficients.

#### § 1066.310 Coastdown procedures for vehicles above 14,000 pounds GVWR.

This section describes coastdown procedures that are unique to vehicles above 14,000 pounds GVWR. These procedures are valid for calculating road-load coefficients for chassis and post-transmission powerpack testing and for calculating drag area ( $C_{DA}$ ) for use in the GEM simulation tool under 40 CFR part 1037.

(a) Determine road-load coefficients by performing a minimum of 16 valid coastdown runs (8 in each direction).

(b) Follow the provisions of Sections 1 through 9 of SAE J1263 and SAE J2263 (incorporated by reference in § 1066.1010), except as described in this paragraph (b). The terms and variables identified in this paragraph (b) have the meaning given in SAE J1263 or J2263 unless specified otherwise.

(1) The test condition specifications of SAE J1263 apply except as follows for wind and road conditions:

(i) We recommend that you do not perform coastdown testing on days for which winds are forecast to exceed 6.0 mph.

(ii) The grade of the test track or road must not be excessive (considering factors such as road safety standards and effects on the coastdown results). Road conditions should follow Section 7.4 of SAE J1263, except that road grade may exceed 0.5%. If road grade is greater than 0.02% over the length of the test surface, you must incorporate into the analysis road grade as a function of distance along the length of the test surface. Use Section 11.5 of SAE J2263 to calculate the force due to grade.

(2) Operate the vehicle at a top speed above 70 mph, or at its maximum achievable speed if it cannot reach 70 mph. If a vehicle is equipped with a vehicle speed limiter that is set for a maximum speed below 70 mph, you must disable the vehicle speed limiter. Start the test at or above 70 mph, or at the vehicle's maximum achievable speed if it cannot reach 70 mph. Collect data through a minimum speed at or below 15 mph. Data analysis for valid coastdown runs must include the range of vehicle speeds specified in this paragraph (b)(2).

(3) Gather data regarding wind speed and direction, in coordination with time-of-day data, using at least one stationary electro-mechanical anemometer and suitable data loggers meeting the specifications of SAE J1263, as well as the following additional specifications for the anemometer placed adjacent to the test surface:

(i) Calibrate the equipment by running the zero-wind and zero-angle calibrations within 24 hours before conducting the coastdown procedures. If the coastdown procedures are not complete 24 hours after calibrating the equipment, repeat the calibration for another 24 hours of data collection.

(ii) Record the location of the anemometer using a GPS measurement device adjacent to the test surface (approximately) at the midway distance along the test surface used for coastdowns.

(iii) Position the anemometer such that it will be at least 2.5 but not more than 3.0 vehicle widths from the test vehicle's centerline as the test vehicle passes the anemometer.

(iv) Mount the anemometer at a height that is within 6 inches of half the test vehicle's maximum height.

(v) Place the anemometer at least 50 feet from the nearest tree and at least 25 feet from the nearest bush (or equivalent roadside features).

(vi) The height of the grass surrounding the stationary anemometer may not exceed 10% of the anemometer's mounted height, within a radius equal to the anemometer's mounted height.

(4) You may split runs as per Section 9.3.1 of SAE J2263, but we recommend whole runs. If you split a run, analyze each portion separately, but count the split runs as one run with respect to the minimum number of runs required.

(5) You may perform consecutive runs in a single direction, followed by consecutive runs in the opposite direction, consistent with good engineering judgment. Harmonize starting and stopping points to the

extent practicable to allow runs to be paired.

(6) All valid coastdown run times in each direction must be within 2.0 standard deviations of the mean of the valid coastdown run times (from the specified maximum speed down to 15 mph) in that direction. Eliminate runs outside this range. After eliminating these runs you must have at least eight valid runs in each direction. You may use coastdown run times that do not meet these standard deviation requirements if we approve it in advance. In your request, describe why the vehicle is not able to meet the specified standard deviation requirements and propose an alternative set of requirements.

(7) Analyze data for chassis and post-transmission powerpack testing or for use in the GEM simulation tool as follows:

(i) Follow the procedures specified in Section 10 of SAE J1263 or Section 11 of SAE J2263 to calculate coefficients for chassis and post-transmission powerpack testing.

(ii) Determine drag area,  $C_D A$ , as follows instead of using the procedure specified in Section 10 of SAE J1263:

(A) Measure vehicle speed at fixed intervals over the coastdown run (generally at 10 Hz), including speeds at or above 15 mph and at or below the specified maximum speed. Establish the elevation corresponding to each interval as described in SAE J2263 if you need to incorporate the effects of road grade.

(B) Calculate the vehicle's effective mass,  $M_e$ , in kg by adding 56.7 kg to the measured vehicle mass for each tire making road contact. This accounts for the rotational inertia of the wheels and tires.

(C) Calculate the road-load force for each measurement interval,  $F_i$ , using the following equation:

$$F_i = -M_e \cdot \frac{v_i - v_{i-1}}{\Delta t}$$

Eq. 1066.310-1

Where:

$i$  = an interval counter, starting with  $i=1$  for the first interval. The designation ( $i-1$ ) corresponds to the end of the previous interval or, for the first interval, to the start of the test run.

$M_e$  = the vehicle's effective mass, expressed to at least the nearest 0.1 kg.

$v$  = vehicle speed at the beginning and end of the measurement interval.

$\Delta t$  = elapsed time over the measurement interval, in seconds.

(D) Plot the data from all the coastdown runs on a single plot of  $F_i$  vs.

$v_i^2$  to determine the slope correlation,  $D$ , based on the following equation:

$$F_i - M_e \cdot g \cdot \frac{\Delta h}{\Delta s} = A_m + D \cdot v_i^2$$

Eq. 1066.310-2

Where:

$g$  = gravitational acceleration = 9.81 m/s<sup>2</sup>.

$\Delta h$  = change in elevation over the measurement interval, in m. Assume  $\Delta h = 0$  if you are not correcting for grade.

$\Delta s$  = distance the vehicle travels down the road during the measurement interval, in m.

$A_m$  = the calculated value of the y-intercept based on the curve-fit.

(E) Calculate drag area,  $C_D A$ , in m<sup>2</sup> using the following equation:

$$C_D A = \frac{2 \cdot D_{adj}}{\rho}$$

Eq. 1066.310-3

Where:

$\rho$  = air density at reference conditions = 1.17 kg/m<sup>3</sup>.

$$D_{adj} = D \cdot \left( \frac{\bar{T}}{293} \right) \cdot \left( \frac{98.21}{\bar{p}_{act}} \right)$$

Eq. 1066.310-4

$\bar{T}$  = mean ambient absolute temperature during testing, in K.

$\bar{p}_{act}$  = average ambient pressuring during the test, in kPa.

(8) Determine the A, B, and C coefficients identified in § 1066.210 as follows:

(i) For chassis and post-transmission powerpack testing, follow the procedures specified in Section 10 of SAE J1263 or Section 12 of SAE J2263.

(ii) For the GEM simulation tool, use the following values:

A =  $A_m$

B = 0

C =  $D_{adj}$

#### § 1066.315 Dynamometer road-load setting.

Determine dynamometer road-load settings for chassis testing by following SAE J2264 (incorporated by reference in § 1066.1010).

#### Subpart E—Preparing Vehicles and Running an Exhaust Emission Test

##### § 1066.401 Overview.

(a) Use the procedures detailed in this subpart to measure vehicle emissions

over a specified drive schedule. Different procedures may apply for criteria pollutants and greenhouse gas emissions as described in the standard-setting part. This subpart describes how to—

- (1) Determine road-load power, test weight, and inertia class.
- (2) Prepare the vehicle, equipment, and measurement instruments for an emission test.
- (3) Perform pre-test procedures to verify proper operation of certain equipment and analyzers and to prepare them for testing.
- (4) Record pre-test data.
- (5) Sample emissions.
- (6) Record post-test data.
- (7) Perform post-test procedures to verify proper operation of certain equipment and analyzers.
- (8) Weigh PM samples.

(b) The overall test generally consists of prescribed sequences of fueling, parking, and driving at specified test conditions. An exhaust emission test generally consists of measuring emissions and other parameters while a vehicle follows the drive schedules specified in the standard-setting part. There are two general types of test cycles:

(1) *Transient cycles.* Transient test cycles are typically specified in the standard-setting part as a second-by-second sequence of vehicle speed commands. Operate a vehicle over a transient cycle such that the speed follows the target values. Proportionally sample emissions and other parameters and calculate emission rates as specified in subpart G of this part to calculate emissions. The standard-setting part may specify three types of transient testing based on the approach to starting the measurement, as follows:

- (i) A cold-start transient cycle where you start to measure emissions just before starting an engine that has not been warmed up.
- (ii) A hot-start transient cycle where you start to measure emissions just before starting a warmed-up engine.
- (iii) A hot-running transient cycle where you start to measure emissions after an engine is started, warmed up, and running.

(2) *Cruise cycles.* Cruise test cycles are typically specified in the standard-setting part as a discrete operating point that has a single speed command.

(i) Start a cruise cycle as a hot-running test, where you start to measure emissions after the engine is started and warmed up and the vehicle is running at the target test speed.

(ii) Sample emissions and other parameters for the cruise cycle in the same manner as a transient cycle, with

the exception that the reference speed value is constant. Record instantaneous and mean speed values over the cycle.

**§ 1066.405 Vehicle preparation and preconditioning.**

Prepare the vehicle for testing (including measurement of evaporative and refueling emissions if appropriate), as described in the standard-setting part.

**§ 1066.410 Dynamometer test procedure.**

(a) Dynamometer testing may consist of multiple drive cycles with both cold-start and hot-start portions, including prescribed soak times before each test interval. The standard-setting part identifies the driving schedules and the associated sample intervals, soak periods, engine startup and shutdown procedures, and operation of accessories, as applicable. Not every test interval includes all these elements.

(b) Place the vehicle onto the dynamometer without starting the engine (for cold-start test cycles) or drive the vehicle onto the dynamometer (for hot-start and hot-running cycles only) and position a fan that directs cooling air to the vehicle during dynamometer operation as described in this paragraph (b). This generally requires squarely positioning the fan in front of the vehicle and directing the airflow to the vehicle's radiator. Use good engineering judgment to design and configure fans to cool the test vehicle in a way that properly simulates in-use operation, consistent with the specifications of § 1066.105. Except for the following special cases, use a road-speed modulated fan meeting the requirements of § 1066.105(c)(2) that is placed within 90 cm of the front of the vehicle and ensure that the engine compartment cover (i.e., hood) is closed:

(1) For vehicles above 14,000 pounds GVWR, use a fan meeting the requirements of § 1066.105(d) that is placed within 90 cm of the front of the vehicle and ensure that the engine compartment cover is closed.

(2) For FTP, LA-92, US06, or HFET testing of vehicles at or below 14,000 pounds GVWR, you may use a fixed-speed fan as specified in the following table, with the engine compartment cover open:

**TABLE 1 OF § 1066.410—FIXED-SPEED FAN CAPACITY AND POSITION SPECIFICATIONS FOR VEHICLES AT OR BELOW 14,000 POUNDS GVWR**

Test cycle	Maximum fan capacity	Approximate distance from the front of the vehicle
FTP ...	Up to 2.50 m <sup>3</sup> /s .....	0 to 30 cm.

**TABLE 1 OF § 1066.410—FIXED-SPEED FAN CAPACITY AND POSITION SPECIFICATIONS FOR VEHICLES AT OR BELOW 14,000 POUNDS GVWR—Continued**

Test cycle	Maximum fan capacity	Approximate distance from the front of the vehicle
US06	Up to 7.10 m <sup>3</sup> /s .....	0 to 60 cm.
LA-92	Up to 7.10 m <sup>3</sup> /s .....	0 to 60 cm.
HFET	Up to 2.50 m <sup>3</sup> /s .....	0 to 30 cm.

(3) For SC03 and AC17 testing, use a road-speed modulated fan meeting the requirements of § 1066.105(c)(5) that is placed within 60 to 90 cm of the front of the vehicle and ensure that the engine compartment cover is closed. Position the discharge nozzle such that its lowest point is not more than 16 cm above the floor of the test cell.

(c) Record the vehicle's speed trace based on the time and speed data from the dynamometer at the recording frequencies given in Table 1 of § 1066.125. Record speed to at least the nearest 0.01 mph and time to at least the nearest 0.1 s.

(d) You may perform practice runs for operating the vehicle and the dynamometer controls to meet the driving tolerances specified in § 1066.425 or adjust the emission sampling equipment. Verify that the accelerator pedal allows for enough control to closely follow the prescribed driving schedule. We recommend that you verify your ability to meet the minimum dilution factor requirements of § 1066.110(b)(2)(iii)(B) during these practice runs.

(e) Inflate tires on drive wheels according to the vehicle manufacturer's specifications. The tire pressure for drive wheels must be the same for dynamometer operation and for dynamometer coastdown procedures used for determining road-load coefficients. Report these measured tire pressure values with the test results.

(f) Tie down or load the test vehicle as needed to provide a normal force at the tire and dynamometer roll interface to prevent wheel slip. For vehicles above 14,000 pounds GVWR, report this measured force with the test results.

(g) Use good engineering judgment when testing vehicles in four-wheel drive or all-wheel drive mode. (For purposes of this paragraph (g), the term four-wheel drive includes other multiple drive-axle configurations.) This may involve testing on a dynamometer with a separate dynamometer roll for each drive axle; or two drive axles may use a single roll, as described in

§ 1066.210(d)(1); or you may deactivate the second set of drive wheels and operate the vehicle on a single roll. For all vehicles at or below 14,000 GVWR, we will test your vehicle using the same dynamometer roll arrangement that you used. We may also test your vehicle using another dynamometer roll arrangement for information-gathering purposes. If we choose to perform additional testing that requires vehicle modifications, we will ask you to configure the vehicle appropriately.

(h) Determine test weight as follows:

(1) For vehicles at or below 14,000 pounds GVWR, determine ETW as described in § 1066.805. Set dynamometer vehicle inertia, *I*, based on dynamometer type, as follows:

(i) For two-wheel drive dynamometers, set  $I = ETW$ .

(ii) For four-wheel drive dynamometers, set  $I = 0.985 \cdot ETW$ .

(2) For vehicles above 14,000 pounds GVWR, determine the vehicle's effective mass as described in § 1066.310 and use this as the test weight.

(i) Warm up the dynamometer as recommended by the dynamometer manufacturer.

(j) Following the test, determine the actual driving distance by counting the number of dynamometer roll or shaft revolutions, or by integrating speed over the course of testing from a high-resolution encoder system.

#### § 1066.415 Vehicle operation.

This section describes how to test a conventionally configured vehicle (vehicles with transmission shifters, foot pedal accelerators, etc). You may ask us to modify these procedures for vehicles that do not have these control features.

(a) Start the vehicle as follows:

(1) At the beginning of the test cycle, start the vehicle according to the procedure described in the owners manual. In the case of HEVs, this would generally involve activating vehicle systems such that the engine will start when the vehicle's control algorithms determine that the engine should provide power instead of or in addition to power from the rechargeable energy storage system (RESS). Unless we specify otherwise, engine starting throughout this part generally refers to this step of activating the system on HEVs, whether or not that causes the engine to start running.

(2) Place the transmission in gear as described by the test cycle in the standard-setting part. During idle operation, apply the brakes if necessary to keep the drive wheels from turning.

(b) If the vehicle does not start after your recommended maximum cranking time, wait and restart cranking

according to your recommended practice. If you do not recommend such a cranking procedure, stop cranking after 10 seconds, wait for 10 seconds, then start cranking again for up to 10 seconds. You may repeat this for up to three start attempts. If the vehicle does not start after three attempts, you must determine and record the reason for failure to start. Shut off sampling systems and either turn the CVS off or disconnect the laboratory exhaust tubing from the tailpipe during the diagnostic period to prevent flow through the exhaust system. Reschedule the vehicle for testing. This may require performing vehicle preparation and preconditioning if the testing needs to be rerun from a cold start. If failure to start occurs during a hot-start test, you may reschedule the hot-start test without repeating the cold-start test, as long as you bring the vehicle to a hot-start condition before starting the hot-start test.

(c) Repeat the recommended starting procedure if the engine has a false start (i.e., an incomplete start).

(d) Take the following steps if the engine stalls:

(1) If the engine stalls during an idle period, restart the engine immediately and continue the test. If you cannot restart the engine soon enough to allow the vehicle to follow the next acceleration, stop the driving schedule indicator and reactivate it when the vehicle restarts.

(2) Void the test if the vehicle stalls during vehicle operation. If this happens, remove the vehicle from the dynamometer, take corrective action, and reschedule the vehicle for testing. Record the reason for the malfunction (if determined) and any corrective action. See the standard-setting part for instructions about reporting these malfunctions.

(e) Operate vehicles during testing as follows:

(1) Where we do not give specific instructions, operate the vehicle according to the recommendations in the owners manual, unless those recommendations are unrepresentative of what may reasonably be expected for in-use operation.

(2) If vehicles have features that preclude dynamometer testing, you may modify these features as necessary to allow testing, consistent with good engineering judgment, as long as it does not affect your ability to demonstrate that your vehicles comply with the applicable standards. Send us written notification describing these changes along with supporting rationale.

(3) Operate vehicles during idle as follows:

(i) For vehicles with automatic transmission, operate at idle with the transmission in "Drive" with the wheels braked, except that you may shift to "Neutral" for the first idle period and for any idle period longer than one minute. If you put the vehicle in "Neutral" during an idle, you must shift the vehicle into "Drive" with the wheels braked at least 5 seconds before the end of the idle period. Note that this does not preclude vehicle designs involving engine shutdown during idle.

(ii) For vehicles with manual transmission, operate at idle with the transmission in gear with the clutch disengaged, except that you may shift to "Neutral" with the clutch engaged for the first idle period and for any idle period longer than one minute. If you put the vehicle in "Neutral" during idle, you must shift to first gear with the clutch disengaged at least 5 seconds before the end of the idle period. Note that this does not preclude vehicle designs involving engine operation with shutdown during idle.

(4) Operate the vehicle with the appropriate accelerator pedal movement necessary to follow the scheduled speeds in the driving schedule. Avoid smoothing speed variations and unnecessary movement of the accelerator pedal.

(5) Operate the vehicle smoothly, following representative shift speeds and procedures. For manual transmissions, the operator shall release the accelerator pedal during each shift and accomplish the shift without delay. If the vehicle cannot accelerate at the specified rate, operate it at maximum available power until the vehicle speed reaches the value prescribed in the driving schedule.

(6) Decelerate as follows:

(i) For vehicles with automatic transmission, use the brakes or accelerator pedal as necessary, without manually changing gears, to maintain the desired speed.

(ii) For vehicles with manual transmission, shift gears in a way that represents reasonable shift patterns for in-use operation, considering vehicle speed, engine speed, and any other relevant variables. Disengage the clutch when the speed drops below 15 mph, when engine roughness is evident, or when good engineering judgment indicates the engine is likely to stall. Manufacturers may recommend shift guidance in the owners manual that differs from the shift schedule used during testing, as long as both shift schedules are described in the application for certification; in this case, we may shift during testing as described in the owners manual.



**§ 1066.420 Test preparation.**

(a) Follow the procedures for PM sample preconditioning and tare weighing as described in 40 CFR 1065.590 if you need to measure PM emissions.

(b) For vehicles above 14,000 pounds GVWR with compression-ignition engines, verify the amount of nonmethane hydrocarbon contamination as described in 40 CFR 1065.520(g).

(c) Unless the standard-setting part specifies different tolerances, verify at some point before the test that ambient conditions are within the tolerances

specified in this paragraph (c). For purposes of this paragraph (c), “before the test” means any time from a point just prior to engine starting (excluding engine restarts) to the point at which emission sampling begins.

(1) Ambient temperature must be (20 to 30) °C. See § 1066.425(h) for circumstances under which ambient temperatures must remain within this range during the test.

(2) Dilution air conditions must meet the specifications in § 1066.110(b)(2). We recommend verifying dilution air conditions just before starting each test interval.

(d) Control test cell ambient air humidity as follows:

(1) For vehicles at or below 14,000 pounds GVWR, follow the humidity requirements in Table 1 of this section, unless the standard-setting part specifies otherwise. When complying with humidity requirements in the table, where no tolerance is specified, use good engineering judgment to maintain the humidity level near the specified value within the limitations of your test facility.

(2) For vehicles above 14,000 pounds GVWR, you may test vehicles at any humidity.

TABLE 1 OF § 1066.420—TEST CELL HUMIDITY REQUIREMENTS

Test cycle	Humidity requirement (grains H <sub>2</sub> O per pound dry air)	Tolerance (grains H <sub>2</sub> O per pound dry air)
AC17 .....	69	± 5 average, ± 10 instantaneous.
FTP <sup>1</sup> and LA-92 .....	50	
HFET .....	50	± 5.
SC03 .....	100	
US06 .....	50	

<sup>1</sup> FTP humidity requirement does not apply for cold (−7°C), intermediate (10 °C), and hot (35 °C) temperature testing.

(e) You may perform a final calibration of proportional-flow control systems, which may include performing practice runs.

(f) You may perform the following procedure to precondition sampling systems:

(1) Operate the vehicle over the test cycle.

(2) Operate any dilution systems at their expected flow rates. Prevent aqueous condensation in the dilution systems as described in 40 CFR 1065.140(c)(6), taking into account allowances given in § 1066.110(b)(2)(iv).

(3) Operate any PM sampling systems at their expected flow rates.

(4) Sample PM using any sample media. You may change sample media during preconditioning. You must discard preconditioning samples without weighing them.

(5) You may purge any gaseous sampling systems during preconditioning.

(6) You may conduct calibrations or verifications on any idle equipment or analyzers during preconditioning.

(g) Take the following steps before emission sampling begins:

(1) For batch sampling, connect clean storage media, such as evacuated bags or tare-weighed filters.

(2) Start all measurement instruments according to the instrument manufacturer’s instructions and using good engineering judgment.

(3) Start dilution systems, sample pumps, and the data-collection system.

(4) Pre-heat or pre-cool heat exchangers in the sampling system to within their operating temperature tolerances for a test.

(5) Allow heated or cooled components such as sample lines, filters, chillers, and pumps to stabilize at their operating temperatures.

(6) Adjust the sample flow rates to desired levels using bypass flow, if desired.

(7) Zero or re-zero any electronic integrating devices before the start of any test interval.

(8) Select gas analyzer ranges. You may not switch the gain of an analyzer’s analog operational amplifier(s) during a test. However, you may switch (automatically or manually) gas analyzer ranges during a test if such switching changes only the range over which the digital resolution of the instrument is applied. For batch analyzers, select ranges before final bag analysis.

(9) Zero and span all continuous gas analyzers using gases that meet the specifications of 40 CFR 1065.750. For FID analyzers, you may account for the carbon number of your span gas either during the calibration process or when calculating your final emission value. For example, if you use a C<sub>3</sub>H<sub>8</sub> span gas of concentration 200 ppm (μmol/mol), you may span the FID to respond with a value of 600 ppm (μmol/mol) of carbon or 200 ppm of propane.

However, if your FID response is equivalent to propane, include a factor of three to make the final calculated hydrocarbon mass consistent with a molar mass of 13.875389. When utilizing an NMC-FID, span the FID analyzer consistent with the determination of their respective response factors, *RF*, and penetration fractions, *PF*, according to 40 CFR 1065.365.

(10) We recommend that you verify gas analyzer responses after zeroing and spanning by sampling a calibration gas that has a concentration near one-half of the span gas concentration. Based on the results, use good engineering judgment to decide whether or not to re-zero, re-span, or re-calibrate a gas analyzer before starting a test.

(11) If you correct for dilution air background concentrations of associated engine exhaust constituents, start sampling and recording background concentrations at the same time you start sampling exhaust gases.

(12) Turn on cooling fans immediately before starting the test.

(h) Proceed with the test sequence described in § 1066.425.

**§ 1066.425 Performing emission tests.**

(a) See the standard-setting part for drive schedules. These are defined by a smooth fit of a specified speed vs. time sequence.

(b) The driver must attempt to follow the target schedule as closely as

possible, consistent with the specifications in paragraph (b) of this section. Instantaneous speeds must stay within the following tolerances:

(1) The upper limit is 2.0 mph higher than the highest point on the trace within 1.0 s of the given point in time.

(2) The lower limit is 2.0 mph lower than the lowest point on the trace within 1.0 s of the given point in time.

(3) The same limits apply for vehicle operation without exhaust measurements, such as vehicle preconditioning and warm-up, except that the upper and lower limits for speed values are  $\pm 4.0$  mph. In addition, up to three occurrences of speed variations greater than the tolerance are acceptable for vehicle operation in which no exhaust emission standards apply, as long as they occur for less than 15 seconds on any occasion and are

clearly documented as to the time and speed at that point of the driving schedule.

(4) Void the test if you do not maintain speed values as specified in this paragraph (b), except as allowed by this paragraph (b)(4). Speed variations (such as may occur during gear changes or braking spikes) may occur as follows, as long as such variations are clearly documented, including the time and speed values and the reason for the deviation:

(i) Speed variations greater than the specified limits are acceptable for up to 2.0 seconds on any occasion.

(ii) For vehicles that are not able to maintain acceleration as specified in § 1066.415(e)(5), do not count the insufficient acceleration as being outside the specified limits.

(5) We may approve an alternate test cycle and cycle-validation criteria for vehicles that do not have enough power to follow the specified driving trace. The alternate driving specifications must be based on making best efforts to maintain acceleration and speed to follow the specified test cycle. We must approve these alternate driving specifications before you perform this testing.

(c) Figure 1 and Figure 2 of this section show the range of acceptable speed tolerances for typical points during testing. Figure 1 of this section is typical of portions of the speed curve that are increasing or decreasing throughout the 2-second time interval. Figure 2 of this section is typical of portions of the speed curve that include a maximum or minimum value.

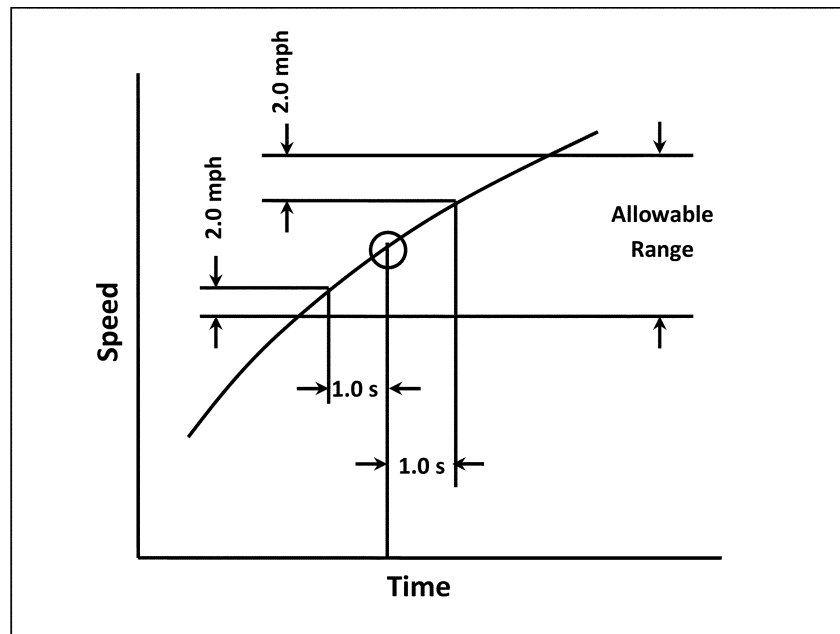

Figure 1 of § 1066.425—Example of the allowable ranges for the driver's trace

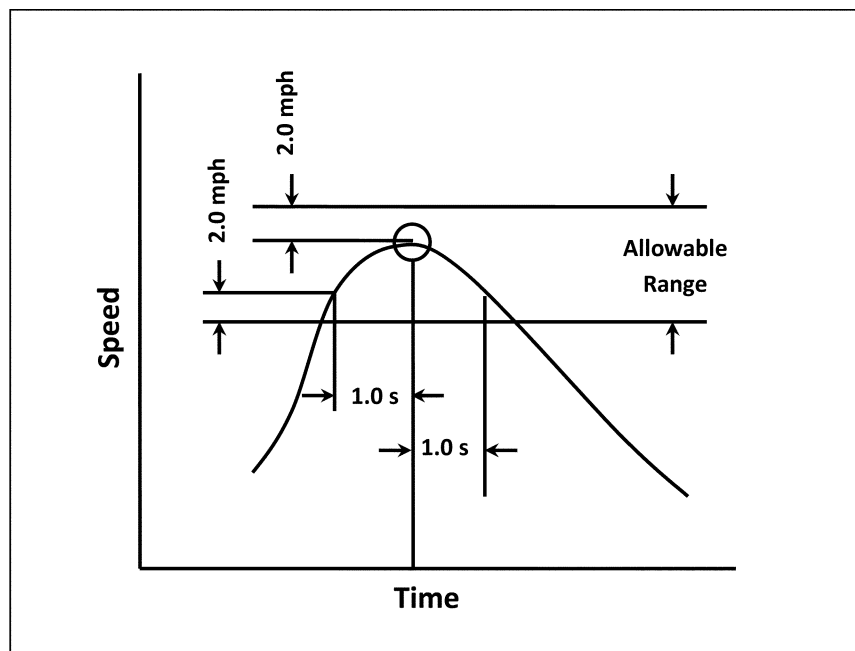

Figure 2 of § 1066.425—Example of the allowable ranges for the driver's trace

(d) Start testing as follows:

(1) If a vehicle is already running and warmed up, and starting is not part of the test cycle, operate the vehicle as follows:

(i) For transient test cycles, control vehicle speeds to follow a drive schedule consisting of a series of idles, accelerations, cruises, and decelerations.

(ii) For cruise test cycles, control the vehicle operation to match the speed of the first interval of the test cycle. Follow the instructions in the standard-setting part to determine how long to stabilize the vehicle during each interval, how long to sample emissions at each interval, and how to transition between intervals.

(2) If engine starting is part of the test cycle, start recording continuous data, turn on any electronic integrating devices, and start batch sampling before starting the engine. Initiate the driver's trace when the engine starts.

(e) Perform the following at the end of each test interval, except as specified in standard-setting part:

(1) Shut down the vehicle if it is part of the test cycle or if testing is complete.

(2) Continue to operate all sampling and dilution systems to allow the response times to elapse. Then stop all sampling and recording, including background sampling. Finally, stop any integrating devices and indicate the end of the duty cycle in the recorded data.

(f) If testing involves engine shutdown followed by another test interval, start a timer for the vehicle soak when the engine shuts down. Turn off cooling

fans, close the engine compartment cover (if applicable), and turn off the CVS or disconnect the exhaust tube from the vehicle's tailpipe(s) unless otherwise instructed in the standard-setting part. If testing is complete, disconnect the laboratory exhaust tubing from the vehicle's tailpipe(s) and drive the vehicle from the dynamometer.

(g) Take the following steps after emission sampling is complete:

(1) For any proportional batch sample, such as a bag sample or PM sample, verify that proportional sampling was maintained according to 40 CFR 1065.545. Void any samples that did not maintain proportional sampling according to those specifications.

(2) Place any used PM samples into covered or sealed containers and return them to the PM-stabilization environment. Follow the PM sample post-conditioning and total weighing procedures in 40 CFR 1065.595.

(3) As soon as practical after the interval or test cycle is complete, or optionally during the soak period if practical, perform the following:

(i) Begin drift check for all continuous gas analyzers as described in paragraph (g)(5) of this section and zero and span all batch gas analyzers as soon as practical before any batch sample analysis. You may perform this batch analyzer zero and span before the end of the test interval.

(ii) Analyze any conventional gaseous batch samples (HC, CH<sub>4</sub>, CO, NO<sub>x</sub>, and CO<sub>2</sub>) no later than 30 minutes after a test interval is complete, or during the soak

period if practical. Analyze background samples no later than 60 minutes after the test interval is complete.

(iii) Analyze nonconventional gaseous batch samples (including background), such as NMHCE, N<sub>2</sub>O, or NMOG sampling with ethanol, as soon as practicable using good engineering judgment.

(4) If an analyzer operated above 100% of its range at any time during the test, perform the following steps:

(i) For batch sampling, re-analyze the sample using the lowest analyzer range that results in a maximum instrument response below 100%. Report the result from the lowest range from which the analyzer operates below 100% of its range.

(ii) For continuous sampling, repeat the entire test using the next higher analyzer range. If the analyzer again operates above 100% of its range, repeat the test using the next higher range. Continue to repeat the test until the analyzer consistently operates at less than 100% of its range. Keep records of any tests where the analyzer exceeds its range. We may consider these results to determine that the test vehicle exceeded an emission standard, consistent with good engineering judgment.

(5) After quantifying exhaust gases, verify drift as follows:

(i) For batch and continuous gas analyzers, record the mean analyzer value after stabilizing a zero gas to the analyzer. Stabilization may include time to purge the analyzer of any sample gas, plus any additional time to account for analyzer response.

(ii) Record the mean analyzer value after stabilizing the span gas to the analyzer. Stabilization may include time to purge the analyzer of any sample gas, plus any additional time to account for analyzer response.

(iii) Use these data to verify that analyzer drift does not exceed 2.0% of the analyzer full scale.

(h) Measure and record ambient pressure. Measure and record ambient temperature continuously to verify that it remains within the temperature range specified in § 1066.420(c)(1) throughout the test. Also measure humidity if required, such as for correcting NO<sub>x</sub> emissions, or meeting the requirements of § 1066.420(d).

(i) [Reserved]

(j) For vehicles at or below 14,000 pounds GVWR, determine overall driver accuracy as follows:

(1) Compare the following drive-cycle metrics, based on measured vehicle speeds, to a reference value based on the target cycle that would have been generated by driving exactly to the target trace as described in SAE J2951 (incorporated by reference in § 1066.1010):

(i) Determine the Energy Economy Rating as described in Section 5.4 of SAE J2951.

(ii) Determine the Absolute Speed Change Rating as described in Section 5.5 of SAE J2951.

(iii) Determine the Inertia Work Rating as described in Section 5.6 of SAE J2951.

(iv) Determine the phase-weighted composite Energy Based Drive Metrics for the criteria specified in this paragraph (j)(1) as described in Section 5.7 of SAE J2951.

(2) The standard-setting part may require you to give us 10 Hz data to characterize both target and actual values for cycle energy. Calculate target values based on the vehicles speeds from the specified test cycle.

#### Subpart F—Electric Vehicles and Hybrid Electric Vehicles

##### § 1066.501 Overview.

Use the following procedures to test EVs and HEVs (including PHEVs):

(a) Correct the results for Net Energy Change of the RESS as follows:

(1) For all sizes of EVs, follow SAE J1634 (incorporated by reference in § 1066.1010).

(2) For HEVs at or below 14,000 pounds GVWR, follow SAE J1711 (incorporated by reference in § 1066.1010) except as described in this paragraph (a). Disregard provisions of SAE J1711 that differ from this part or the standard-setting part if they are not

specific to HEVs. Apply the following adjustments and clarifications to SAE J1711:

(i) If the procedure calls for charge-sustaining operation, start the drive with a State of Charge that is appropriate to ensure charge-sustaining operation for the duration of the drive. Take steps other than emission measurements to confirm that vehicles are in charge-sustaining mode for the duration of the drive.

(ii) We may approve the use of the alternate End-of-Test criterion in Section 3.9.1 of SAE J1711 and the Net Energy Change correction in Appendix C of SAE J1711 if the specified criterion and correction are insufficient or inappropriate for establishing the transition between charge-depleting and charge-sustaining operation.

(iii) Appendix C of SAE J1711 may be used to correct final fuel economy values, CO<sub>2</sub> emissions, and carbon-related exhaust emissions, but may not be used to correct measured values for criteria pollutant emissions.

(iv) You may test subject to a measurement accuracy of ±0.3% of full scale in place of the measurement accuracy specified in Section 4.2a of SAE J1711.

(3) For HEVs above 14,000 pounds GVWR, follow SAE J2711 (incorporated by reference in § 1066.1010) for requirements related to charge-sustaining operation.

(4) Use an integration frequency of 1 to 20 Hz for power analyzers to verify compliance with current and voltage specifications.

(b) This paragraph (b) applies for vehicles that include an engine-powered generator or other auxiliary power unit that provides motive power. For example, this would include a vehicle that has a small gasoline engine that generates electricity to charge batteries. Unless we approve otherwise, measure emissions for all test cycles when such an engine is operating. For each test cycle for which emissions are not measured, you must validate that such engines are not operating at any time during the test cycle.

(c) You may stop emission sampling anytime the engine is turned off, consistent with good engineering judgment. This is intended to allow for higher concentrations of dilute exhaust gases and more accurate measurements. Take steps to account for exhaust transport delay in the sampling system, and be sure to integrate over the actual sampling duration when determining  $V_{mix}$ .

#### Subpart G—Calculations

##### § 1066.601 Overview.

(a) This subpart describes calculations used to determine emission rates. See the standard-setting part and the other provisions of this part to determine which equations apply for your testing. This subpart describes how to—

(1) Use the signals recorded before, during, and after an emission test to calculate distance-specific emissions of each regulated pollutant.

(2) Perform calculations for calibrations and performance checks.

(3) Determine statistical values.

(b) You may use data from multiple systems to calculate test results for a single emission test, consistent with good engineering judgment. You may also make multiple measurements from a single batch sample, such as multiple weighing of a PM filter or multiple readings from a bag sample. Although you may use an average of multiple measurements from a single test, you may not use test results from multiple emission tests to report emissions. We allow weighted means where appropriate, such as for sampling onto a PM filter over the FTP. You may discard statistical outliers, but you must report all results.

##### § 1066.605 Mass-based and molar-based exhaust emission calculations.

(a) Calculate your total mass of emissions over a test cycle as specified in paragraph (c) of this section or in 40 CFR part 1065, subpart G, as applicable.

(b) See the standard-setting part for composite emission calculations over multiple test intervals and the corresponding weighting factors.

(c) Perform the following sequence of preliminary calculations to correct recorded concentration measurements before calculating mass emissions in paragraphs (d) and (e) of this section:

(1) For vehicles above 14,000 pounds GVWR, correct all THC and CH<sub>4</sub> concentrations for initial contamination as described in 40 CFR 1065.660(a), including continuous readings, sample bag readings, and dilution air background readings. This correction is optional for vehicles at or below 14,000 pounds GVWR.

(2) Correct all concentrations measured on a “dry” basis to a “wet” basis, including dilution air background concentrations.

(3) Calculate all NMHC and CH<sub>4</sub> concentrations, including dilution air background concentrations, as described in 40 CFR 1065.660.

(4) For vehicles at or below 14,000 pounds GVWR, calculate HC concentrations, including dilution air

background concentrations, as described in this section, and as described in § 1066.635 for NMOG. For emission testing of vehicles above 14,000 pounds GVWR, with fuels that contain 25% or more oxygenated compounds by volume, calculate THCE and NMHC concentrations, including dilution air

background concentrations, as described in 40 CFR part 1065, subpart I.

(5) Correct NO<sub>x</sub> emission values for intake-air humidity as described in § 1066.615.

(6) Correct all gaseous concentrations for dilution air background as described in § 1066.610.

(7) Correct all PM filter masses for sample media buoyancy as described in 40 CFR 1065.690.

(d) Calculate the emission mass of each gaseous pollutant using the following equation:

$$m_{[\text{emission}]} = V_{\text{mix}} \cdot \rho_{[\text{emission}]} \cdot x_{[\text{emission}]} \cdot c$$

Eq. 1066.605-1

Where:

$m_{[\text{emission}]}$  = emission mass over the test interval.

$V_{\text{mix}}$  = total dilute exhaust volume over the test interval, corrected to standard reference conditions, and corrected for any volume removed for emission sampling and for any volume change from adding secondary dilution air.

$\rho_{[\text{emission}]}$  = density of the appropriate chemical species as given in § 1066.1005(f).

$x_{[\text{emission}]}$  = measured emission concentration in the sample, after dry-to-wet and background corrections.

$c = 10^{-2}$  for emission concentrations in %, and  $10^{-6}$  for emission concentrations in ppm.

*Example:*

$V_{\text{mix}} = 170.878 \text{ m}^3$  (from paragraph (f) of this section)

$\rho \text{ NO}_x = 1913 \text{ g/m}^3$

$x \text{ NO}_x = 0.9721 \text{ ppm}$

$c = 10^{-6}$

$m \text{ NO}_x = 170.878 \cdot 1913 \cdot 0.9721 \cdot 10^{-6} = 0.3177 \text{ g}$

(e) Calculation of the emission mass of PM,  $m_{\text{PM}}$ , is dependent on how many PM filters you use, as follows:

(1) Except as specified in paragraphs (e)(2) and (3) of this section, calculate  $m_{\text{PM}}$  using the following equation:

$$m_{\text{PM}} = \left( \frac{V_{\text{mix}}}{V_{\text{PMstd}} - V_{\text{sdastd}}} \right) \cdot (m_{\text{PMfil}} - m_{\text{PMbkgnd}})$$

Eq. 1066.605-2

Where:

$m_{\text{PM}}$  = mass of particulate matter emissions over the test interval, as described in § 1066.815(b)(1), (2), and (3).

$V_{\text{mix}}$  = total dilute exhaust volume over the test interval, corrected to standard reference conditions, and corrected for

any volume removed for emission sampling and for any volume change from adding secondary dilution air.

$V_{\text{sdastd}}$  = total volume of secondary dilution air sampled through the filter over the test interval, corrected to standard temperature and pressure.

$m_{\text{PMfil}}$  = mass of particulate matter emissions on the filter over the test interval.

$m_{\text{PMbkgnd}}$  = mass of particulate matter on the background filter.

*Example:*

$$V_{\text{mix}} = 170.878 \text{ m}^3 \text{ (from paragraph (f) of this section)}$$

$$V_{\text{PMstd}} = 0.925 \text{ m}^3 \text{ (from paragraph (f) of this section)}$$

$$V_{\text{sdastd}} = 0.527 \text{ m}^3 \text{ (from paragraph (f) of this section)}$$

$$m_{\text{PMfil}} = 0.0000045 \text{ g}$$

$$m_{\text{PMbkgnd}} = 0.0000014 \text{ g}$$

$$m_{\text{PM}} = \left( \frac{170.878}{0.925 - 0.527} \right) \cdot (0.0000045 - 0.0000014) = 0.00133 \text{ g}$$

(2) If you sample PM onto a single filter as described in § 1066.815(b)(4), calculate  $m_{\text{PM}}$  using the following equation:

$$m_{\text{PM}} = \left( \frac{V_{\text{mix}}}{\frac{(V_{\text{ct-PMstd}} - V_{\text{ct-sdastd}})}{0.43} + (V_{\text{s-PMstd}} - V_{\text{s-sdastd}}) + \frac{(V_{\text{ht-PMstd}} - V_{\text{ht-sdastd}})}{0.57}} \right) \cdot (m_{\text{PMfil}} - m_{\text{PMbkgnd}})$$

Eq. 1066.605-3

Where:

$m_{\text{PM}}$  = mass of particulate matter emissions over the entire FTP as sampled according to § 1066.815(b)(4).

$V_{\text{mix}}$  = total dilute exhaust volume over the test interval, corrected to standard reference conditions, and corrected for any volume removed for emission

sampling and for any volume change from adding secondary dilution air.

$V_{\text{[interval]-PMstd}}$  = total volume of dilute exhaust sampled through the filter over the test interval (ct = cold transient, s = stabilized, ht = hot transient), corrected to standard reference conditions.

$V_{\text{[interval]-sdastd}}$  = total volume of secondary dilution air sampled through the filter

over the test interval (ct = cold transient, s = stabilized, ht = hot transient), corrected to standard reference conditions.

$m_{\text{PMfil}}$  = mass of particulate matter emissions on the filter over the test interval.

$m_{\text{PMbkgnd}}$  = mass of particulate matter on the background filter over the test interval.

*Example:*

$$V_{\text{mix}} = 633.691 \text{ m}^3$$

$$V_{\text{ct-PMstd}} = 0.925 \text{ m}^3$$

$$V_{\text{ct-sdastd}} = 0.527 \text{ m}^3$$

$$V_{\text{s-PMstd}} = 1.967 \text{ m}^3$$

$$V_{\text{s-sdastd}} = 1.121 \text{ m}^3$$

$$V_{\text{ht-PMstd}} = 1.122 \text{ m}^3$$

$$V_{\text{ht-sdastd}} = 0.639 \text{ m}^3$$

$$m_{\text{PMfil}} = 0.0000106 \text{ g}$$

$$m_{\text{PMbkgnd}} = 0.0000014 \text{ g}$$

$$m_{\text{PM}} = \left( \frac{633.691}{\frac{(0.925 - 0.527)}{0.43} + (1.967 - 1.121) + \frac{(1.122 - 0.639)}{0.57}} \right) \cdot (0.0000106 - 0.0000014)$$

$$m_{\text{PM}} = 0.00222 \text{ g}$$

(3) If you sample PM onto a single filter as described in § 1066.815(b)(5),

calculate  $m_{\text{PM}}$  using the following equation:

$$m_{\text{PM}} = \left( \frac{V_{\text{mix}}}{\frac{(V_{\text{ct-PMstd}} - V_{\text{ct-sdastd}}) + (V_{\text{cs-PMstd}} - V_{\text{cs-sdastd}})}{0.43} + \frac{(V_{\text{ht-PMstd}} - V_{\text{ht-sdastd}}) + (V_{\text{hs-PMstd}} - V_{\text{hs-sdastd}})}{0.57}} \right) \cdot (m_{\text{PMfil}} - m_{\text{PMbkgnd}})$$

Eq. 1066.605-4

Where:

$m_{\text{PM}}$  = mass of particulate matter emissions over the entire FTP as sampled according to § 1066.815(b)(5).

$V_{\text{mix}}$  = total dilute exhaust volume over the test interval, corrected to standard reference conditions, and corrected for any volume removed for emission

sampling and for any volume change from secondary dilution air.

$V_{[\text{interval}]\text{-PMstd}}$  = total volume of dilute exhaust sampled through the filter over the test interval (ct = cold transient, cs = cold stabilized, ht = hot transient, hs = hot stabilized), corrected to standard reference conditions.

$V_{[\text{interval}]\text{-sdastd}}$  = total volume of secondary dilution air sampled through the filter

over the test interval (ct = cold transient, cs = cold stabilized, ht = hot transient, hs = hot stabilized), corrected to standard reference conditions.

$m_{\text{PMfil}}$  = mass of particulate matter emissions on the filter over the test interval.

$m_{\text{PMbkgnd}}$  = mass of particulate matter on the background filter over the test interval.

*Example:*

$$V_{\text{mix}} = 972.121 \text{ m}^3$$

$$V_{\text{ct-PMstd}} = 0.925 \text{ m}^3$$

$$V_{\text{ct-sdastd}} = 0.529 \text{ m}^3$$

$$V_{\text{cs-PMstd}} = 1.968 \text{ m}^3$$

$$V_{\text{cs-sdastd}} = 1.123 \text{ m}^3$$

$$V_{\text{ht-PMstd}} = 1.122 \text{ m}^3$$

$$V_{\text{ht-sdastd}} = 0.641 \text{ m}^3$$

$$V_{\text{hs-PMstd}} = 1.967 \text{ m}^3$$

$$V_{\text{hs-sdastd}} = 1.121 \text{ m}^3$$

$$m_{\text{PMfil}} = 0.0000229 \text{ g}$$

$$m_{\text{PMbkgnd}} = 0.0000014 \text{ g}$$

$$m_{\text{PM}} = \left( \frac{972.121}{\frac{(0.925 - 0.529) + (1.968 - 1.123)}{0.43} + \frac{(1.122 - 0.641) + (1.967 - 1.121)}{0.57}} \right) \cdot (0.0000229 - 0.0000014)$$

$$m_{\text{PM}} = 0.00401 \text{ g}$$

(f) This paragraph (f) describes how to correct flow and flow rates to standard reference conditions and provides an example for determining  $V_{\text{mix}}$  based on CVS total flow and the removal of

sample flow from the dilute exhaust gas. You may use predetermined nominal values for removed sample volumes, except for flows used for batch sampling.

(1) Correct flow and flow rates to standard reference conditions as needed using the following equation:

$$V_{[\text{flow}]_{\text{std}}} = \frac{V_{[\text{flow}]_{\text{act}}} \cdot p_{\text{in}} \cdot T_{\text{std}}}{p_{\text{std}} \cdot T_{\text{in}}}$$

Eq. 1066.605-5

Where:

$V_{[\text{flow}]_{\text{std}}}$  = total flow volume at the flow meter, corrected to standard reference conditions.

$V_{[\text{flow}]_{\text{act}}}$  = total flow volume at the flow meter at test conditions.

$p_{\text{in}}$  = absolute static pressure at the flow meter inlet, measured directly or calculated as the sum of atmospheric pressure plus a differential pressure referenced to atmospheric pressure.

$T_{\text{std}}$  = standard temperature.

$p_{\text{std}}$  = standard pressure.

$T_{\text{in}}$  = temperature of the dilute exhaust sample at the flow meter inlet.



*Example:*

$$V_{\text{PMact}} = 1.071 \text{ m}^3$$

$$p_{\text{in}} = 101.7 \text{ kPa}$$

$$T_{\text{std}} = 293.15 \text{ K}$$

$$p_{\text{std}} = 101.325 \text{ kPa}$$

$$T_{\text{in}} = 340.5 \text{ K}$$

$$V_{\text{PMstd}} = \frac{1.071 \cdot 101.7 \cdot 293.15}{101.325 \cdot 340.5} = 0.925 \text{ m}^3$$

(2) The following example provides a determination of  $V_{\text{mix}}$  based on CVS total flow and the removal of sample flow from one dilute exhaust gas analyzer and one PM sampling system

that is utilizing secondary dilution. Note that your  $V_{\text{mix}}$  determination may vary from Eq. 1066.605-6 based on the number of flows that are removed from your dilute exhaust gas and whether

your PM sampling system is using secondary dilution. For this example,  $V_{\text{mix}}$  is governed by the following equation:

$$V_{\text{mix}} = V_{\text{CVSstd}} + V_{\text{gasstd}} + V_{\text{PMstd}} - V_{\text{sdastd}}$$

Eq. 1066.605-6

Where:

$V_{\text{CVSstd}}$  = total dilute exhaust volume over the test interval at the flow meter, corrected to standard reference conditions.

$V_{\text{gasstd}}$  = total volume of sample flow through the gaseous emission bench over the test interval, corrected to standard reference conditions.

$V_{\text{PMstd}}$  = total volume of dilute exhaust sampled through the filter over the test interval, corrected to standard reference conditions.

$V_{\text{sdastd}}$  = total volume of secondary dilution air flow sampled through the filter over the test interval, corrected to standard reference conditions.

*Example:*

Using Eq. 1066.605-5

$V_{\text{CVSstd}} = 170.451 \text{ m}^3$ , where  $V_{\text{CVSact}} = 170.721 \text{ m}^3$ ,  $p_{\text{in}} = 101.7 \text{ kPa}$ , and  $T_{\text{in}} = 294.7 \text{ K}$

Using Eq. 1066.605-5

$V_{\text{gasstd}} = 0.028 \text{ m}^3$ , where  $V_{\text{gasact}} = 0.033 \text{ m}^3$ ,  $p_{\text{in}} = 101.7 \text{ kPa}$ , and  $T_{\text{in}} = 340.5 \text{ K}$

Using Eq. 1066.605-5

$V_{\text{PMstd}} = 0.925 \text{ m}^3$ , where  $V_{\text{PMact}} = 1.071 \text{ m}^3$ ,  $p_{\text{in}} = 101.7 \text{ kPa}$ , and  $T_{\text{in}} = 340.5 \text{ K}$

Using Eq. 1066.605-5

$V_{\text{sdastd}} = 0.527 \text{ m}^3$ , where  $V_{\text{sdaact}} = 0.531 \text{ m}^3$ ,

$p_{\text{in}} = 101.7 \text{ kPa}$ , and  $T_{\text{in}} = 296.3 \text{ K}$   
 $V_{\text{mix}} = 170.451 + 0.028 + 0.925 - 0.527 = 170.878 \text{ m}^3$

(g) Calculate total flow volume over a test interval,  $V_{\text{[flow]}}$ , for a CVS or exhaust gas sampler as follows:

(1) *Varying versus constant flow rates.* The calculation methods depend on differentiating varying and constant flow, as follows:

(i) We consider the following to be examples of varying flows that require a continuous multiplication of concentration times flow rate: raw exhaust, exhaust diluted with a constant flow rate of dilution air, and CVS dilution with a CVS flow meter that does not have an upstream heat exchanger or electronic flow control.

(ii) We consider the following to be examples of constant exhaust flows:

CVS diluted exhaust with a CVS flow meter that has an upstream heat exchanger, an electronic flow control, or both.

(2) *Continuous sampling.* For continuous sampling, you must frequently record a continuously updated flow signal. This recording requirement applies for both varying and constant flow rates.

(i) *Varying flow rate.* If you continuously sample from a varying exhaust flow rate, calculate  $V_{\text{[flow]}}$  using the following equation:

$$V_{\text{[flow]}} = \sum_{i=1}^N \dot{Q}_i \cdot \Delta t$$

Eq. 1066.605-7

Where:

$$\Delta t = 1/f_{\text{record}} \quad \text{Eq. 1066.605-8}$$

*Example:*

$$N = 505$$

$$\dot{Q}_{CVS1} = 0.276 \text{ m}^3/\text{s}$$

$$\dot{Q}_{CVS2} = 0.294 \text{ m}^3/\text{s}$$

$$f_{\text{record}} = 1 \text{ Hz}$$

Using Eq. 1066.605-8,

$$\Delta t = 1/1 = 1 \text{ s}$$

$$V_{CVS} = (0.276 + 0.294 + \dots + \dot{Q}_{CVS505}) \cdot 1$$

$$V_{CVS} = 170.721 \text{ m}^3$$

(ii) *Constant flow rate.* If you continuously sample from a constant exhaust flow rate, use the same calculation described in paragraph (g)(2)(i) of this section or calculate the mean flow recorded over the test interval and treat the mean as a batch sample, as described in paragraph (g)(3)(ii) of this section.

(3) *Batch sampling.* For batch sampling, calculate total flow by integrating a varying flow rate or by determining the mean of a constant flow rate, as follows:

(i) *Varying flow rate.* If you proportionally collect a batch sample

from a varying exhaust flow rate, integrate the flow rate over the test interval to determine the total flow from which you extracted the proportional sample, as described in paragraph (g)(2)(i) of this section.

(ii) *Constant flow rate.* If you batch sample from a constant exhaust flow rate, extract a sample at a proportional or constant flow rate and calculate  $V_{[\text{flow}]}$  from the flow from which you extract the sample by multiplying the mean flow rate by the time of the test interval using the following equation:

$$V_{[\text{flow}]} = \bar{Q} \cdot \Delta t$$

Eq. 1066.605-9

*Example:*

$$\bar{Q}_{CVS} = 0.338 \text{ m}^3/\text{s}$$

$$\Delta t = 505 \text{ s}$$

$$V_{CVS} = 0.338 \cdot 505$$

$$V_{CVS} = 170.69 \text{ m}^3$$

**§ 1066.610 Dilution air background correction.**

(a) Correct the emissions in a gaseous sample for background using the following equation:

$$x_{[\text{emission}]} = x_{[\text{emission}]\text{dexh}} - x_{[\text{emission}]\text{bkngnd}} \cdot \left(1 - \left(\frac{1}{DF}\right)\right)$$

Eq. 1066.610-1

Where:

$x_{[\text{emission}]\text{dexh}}$  = measured emission concentration in dilute exhaust (after dry-to-wet correction, if applicable).

$x_{[\text{emission}]\text{bkngnd}}$  = measured emission concentration in the dilution air (after dry-to-wet correction, if applicable).

$DF$  = dilution factor, as determined in paragraph (b) of this section.

*Example:*

$$x_{\text{NOx dexh}} = 1.08305 \text{ ppm}$$

$$x_{\text{NOx bkngnd}} = 0.12456 \text{ ppm}$$

$$DF = 9.14506$$

$$x_{\text{NOx}} = 1.08305 - 0.12456 \cdot \left(1 - \left(\frac{1}{9.14506}\right)\right) = 0.97211 \text{ ppm}$$

(b) Except as specified in paragraph (c) of this section, determine the dilution factor,  $DF$ , over the test interval using the following equation:

$$DF = \frac{1}{\left(1 + \frac{\alpha}{2} + 3.76 \cdot \left(1 + \frac{\alpha}{4} - \frac{\beta}{2}\right)\right) \cdot (x_{\text{CO}_2} + x_{\text{NMHC}} + x_{\text{CH}_4} + x_{\text{CO}})}$$

Eq. 1066.610-2

Where:

$x_{\text{CO}_2}$  = amount of  $\text{CO}_2$  measured in the sample over the test interval.

$x_{\text{NMHC}}$  = amount of  $\text{C}_1$ -equivalent NMHC measured in the sample over the test interval.

$x_{\text{CH}_4}$  = amount of  $\text{CH}_4$  measured in the sample over the test interval.  
 $x_{\text{CO}}$  = amount of  $\text{CO}$  measured in the sample over the test interval.  
 $\alpha$  = atomic hydrogen-to-carbon ratio of the test fuel. You may measure  $\alpha$  or use

default values from Table 1 of 40 CFR 1065.655.  
 $\beta$  = atomic oxygen-to-carbon ratio of the test fuel. You may measure  $\beta$  or use default values from Table 1 of 40 CFR 1065.655.

*Example:*

$$x_{\text{CO}_2} = 1.456 \% = 0.01456$$

$$x_{\text{NMHC}} = 0.84 \text{ ppm} = 0.00000084$$

$$x_{\text{CH}_4} = 0.26 \text{ ppm} = 0.00000026$$

$$x_{\text{CO}} = 80.4 \text{ ppm} = 0.0000804$$

$$\alpha = 1.92$$

$$\beta = 0.03$$

$$DF = \frac{1}{\left(1 + \frac{1.92}{2} + 3.76 \cdot \left(1 + \frac{1.92}{4} - \frac{0.03}{2}\right)\right) \cdot (0.01456 + 0.00000084 + 0.00000026 + 0.0000804)} = 9.14506$$

(c) Determine the dilution factor,  $DF$ , over the test interval for partial-flow dilution sample systems using the following equation:

$$DF = \frac{V_{\text{dexhstd}}}{V_{\text{exhstd}}}$$

Eq. 1066.610-3

Where:

$V_{\text{dexhstd}}$  = total dilute exhaust volume sampled over the test interval, corrected to standard reference conditions.

$V_{\text{exhstd}}$  = total exhaust volume sampled from the vehicle, corrected to standard reference conditions.

*Example:*

$$V_{\text{dexhstd}} = 170.9 \text{ m}^3$$

$$V_{\text{exhstd}} = 15.9 \text{ m}^3$$

$$DF = \frac{170.9}{15.4} = 11.1$$

(d) Determine the time-weighted dilution factor,  $DF_w$ , over the duty cycle using the following equation:

$$DF_w = \frac{\sum_{i=1}^N t_i}{\sum_{i=1}^N \frac{1}{DF_i} \cdot t_i}$$

Eq. 1066.610-4

Where:

$N$  = number of test intervals.

$i$  = test interval number

$t$  = duration of the test interval.

$DF$  = dilution factor over the test interval.

*Example:*

$$N = 3$$

$$DF_1 = 14.40$$

$$t_1 = 505 \text{ s}$$

$$DF_2 = 24.48$$

$$t_2 = 867 \text{ s}$$

$$DF_3 = 17.28$$

$$t_3 = 505 \text{ s}$$

$$DF_w = \frac{505 + 867 + 505}{\left(\frac{1}{14.40} \cdot 505\right) + \left(\frac{1}{24.48} \cdot 867\right) + \left(\frac{1}{17.28} \cdot 505\right)} = 18.82$$

**§ 1066.615 NO<sub>x</sub> intake-air humidity correction.**

You may correct NO<sub>x</sub> emissions for intake-air humidity as described in this section if the standard-setting part allows it. See § 1066.605(c)(1) for the proper sequence for applying the NO<sub>x</sub> intake-air humidity correction.

(a) For vehicles at or below 14,000 pounds GVWR, apply a correction for vehicles with reciprocating engines

operating over specific test cycles as follows:

(1) Calculate a humidity correction using a time-weighted mean value for ambient humidity over the test interval. Calculate absolute ambient humidity,  $H$ , using the following equation:

$$H = \frac{1000 \cdot M_{\text{H}_2\text{O}} \cdot p_d \cdot RH\%}{M_{\text{air}} \cdot (p_{\text{atmos}} - p_d \cdot RH\%)}$$

Eq. 1066.615-1

Where:

$M_{\text{H}_2\text{O}}$  = molar mass of H<sub>2</sub>O.

$p_d$  = saturated vapor pressure at the ambient dry bulb temperature.

$RH$  = relative humidity of ambient air

$M_{\text{air}}$  = molar mass of air.

$p_{\text{atmos}}$  = atmospheric pressure.

*Example:*

$$M_{\text{H}_2\text{O}} = 18.01528 \text{ g/mol}$$

$$p_d = 2.93 \text{ kPa}$$

$$RH = 37.5 \%$$

$$M_{\text{air}} = 28.96559 \text{ g/mol}$$

$$p_{\text{atmos}} = 96.71 \text{ kPa}$$

$$H = \frac{1000 \cdot 18.01528 \cdot 2.93 \cdot 37.5 \cdot 0.01}{28.96559 \cdot (96.71 - 2.93 \cdot 37.5 \cdot 0.01)} = 7.14741 \text{ g H}_2\text{O vapor/kg dry air}$$

(2) Use the following equation to correct measured concentrations to a reference condition of 10.71 grams H<sub>2</sub>O vapor per kilogram of dry air for the FTP, US06, LA-92, SC03, and HFET test cycles:

$$x_{\text{NO}_{\text{Xdexhcor}}} = x_{\text{NO}_{\text{Xdexh}}} \cdot \frac{H_s}{1 - 0.0329 \cdot (H - 10.71)}$$

Eq. 1066.615-2

Where:

$x_{\text{NO}_{\text{Xdexh}}}$  = measured dilute NO<sub>x</sub> emissions.

$H_s$  = humidity scale. Set = 1 for FTP, US06, LA-92, and HFET test cycles. Set = 0.8825 for the SC03 test cycle.

$H$  = ambient humidity, as determined in paragraph (a)(1) of this section.

*Example:*

$$H = 7.14741 \text{ g H}_2\text{O vapor/kg dry air time weighted over the FTP test cycle}$$

$$x_{\text{NO}_{\text{Xdexh}}} = 1.21 \text{ ppm}$$

$$x_{\text{NO}_{\text{Xdexhcor}}} = 1.21 \cdot \frac{1}{1 - 0.0329 \cdot (7.14741 - 10.71)} = 1.08305 \text{ ppm}$$

(b) For vehicles above 14,000 pounds GVWR, apply correction factors as described in 40 CFR 1065.670.

**§ 1066.620 Removed water correction.**

Correct for removed water if water removal occurs upstream of a concentration measurement and downstream of a flow meter used to determine mass emissions over a test interval. Perform this correction based on the amount of water at the concentration measurement and on the amount of water at the flow meter.

**§ 1066.625 Flow meter calibration calculations.**

This section describes how to calibrate various flow meters based on mass flow rates. Calibrate your flow meter according to 40 CFR 1065.640 instead if you calculate emissions based on molar flow rates.

(a) *PDP calibration.* Perform the following steps to calibrate a PDP flow meter:

(1) Calculate PDP volume pumped per revolution,  $V_{rev}$ , for each restrictor position from the mean values determined in § 1066.140:

$$V_{rev} = \frac{\bar{Q}_{ref} \cdot \bar{T}_{in} \cdot p_{std}}{\bar{f}_{nPDP} \cdot \bar{p}_{in} \cdot T_{std}}$$

Eq. 1066.625-1

Where:

$\bar{Q}_{ref}$  = mean flow rate of the reference flow meter.  
 $\bar{T}_{in}$  = mean temperature at the PDP inlet.  
 $p_{std}$  = standard pressure = 101.325 kPa.  
 $\bar{f}_{nPDP}$  = mean PDP speed.  
 $\bar{p}_{in}$  = mean static absolute pressure at the PDP inlet.  
 $T_{std}$  = standard temperature = 293.15 K.  
*Example:*  
 $\bar{Q}_{ref}$  = 0.1651 m<sup>3</sup>/s  
 $\bar{T}_{in}$  = 299.5 K  
 $p_{std}$  = 101.325 kPa  
 $\bar{f}_{nPDP}$  = 1205.1 r/min = 20.085 r/s  
 $\bar{p}_{in}$  = 98.290 kPa

$$T_{std} = 293.15 \text{ K}$$

$$V_{rev} = \frac{0.1651 \cdot 299.5 \cdot 101.3}{20.085 \cdot 98.290 \cdot 293.15}$$

$$V_{rev} = 0.00866 \text{ m}^3/\text{r}$$

(2) Calculate a PDP slip correction factor,  $K_s$  for each restrictor position from the mean values determined in § 1066.140:

$$K_s = \frac{1}{\bar{f}_{nPDP}} \cdot \sqrt{\frac{\bar{p}_{out} - \bar{p}_{in}}{\bar{p}_{out}}}$$

Eq. 1066.625-2

Where:

$\bar{f}_{nPDP}$  = mean PDP speed.

$\bar{P}_{out}$  = mean static absolute pressure at the PDP outlet.  
 $\bar{P}_{in}$  = mean static absolute pressure at the PDP inlet.

*Example:*

$$\bar{f}_{nPDP} = 1205.1 \text{ r/min} = 20.085 \text{ r/s}$$

$$\bar{p}_{out} = 100.103 \text{ kPa}$$

$$\bar{p}_{in} = 98.290 \text{ kPa}$$

$$K_s = \frac{1}{20.085} \cdot \sqrt{\frac{100.103 - 98.290}{100.103}}$$

$$K_s = 0.006700 \text{ s/r}$$

(3) Perform a least-squares regression of  $V_{rev}$ , versus  $K_s$ , by calculating slope,  $a_1$ , and intercept,  $a_0$ , as described in 40 CFR 1065.602.

(4) Repeat the procedure in paragraphs (a)(1) through (3) of this section for every speed that you run your PDP.

(5) The following example illustrates a range of typical values for different PDP speeds:

TABLE 1 OF § 1066.625—EXAMPLE OF PDP CALIBRATION DATA

$\bar{f}_{nPDP}$ (revolution/s)	$a_1$ (m <sup>3</sup> /s)	$a_0$ (m <sup>3</sup> /revolution)
12.6 .....	0.841	0.056
16.5 .....	0.831	-0.013
20.9 .....	0.809	0.028
23.4 .....	0.788	-0.061

(6) For each speed at which you operate the PDP, use the appropriate regression equation from this paragraph (a) to calculate flow rate during emission testing as described in § 1066.630.

(b) *SSV calibration.* The equations governing SSV flow assume one-dimensional isentropic inviscid flow of an ideal gas, except that the equations can account for compressible flow. Paragraph (b)(2)(iv) of this section

describes other assumptions that may apply. If good engineering judgment dictates that you account for gas compressibility, you may either use an appropriate equation of state to determine values of  $Z$  as a function of measured pressure and temperature, or you may develop your own calibration equations based on good engineering judgment. Note that the equation for the flow coefficient,  $C_f$ , is based on the ideal gas assumption that the isentropic

exponent,  $\gamma$ , is equal to the ratio of specific heats,  $C_p/C_v$ . If good engineering judgment dictates using a real gas isentropic exponent, you may either use an appropriate equation of state to determine values of  $\gamma$  as a function of measured pressure and temperature, or you may develop your own calibration equations based on good engineering judgment.

(1) Calculate volume flow rate,  $\bar{Q}$ , as follows

$$\dot{Q} = C_d \cdot C_f \cdot \frac{A_t \cdot R \cdot p_{in} \cdot T_{std}}{p_{std} \cdot \sqrt{Z \cdot M_{mix} \cdot R \cdot T_{in}}}$$

Eq. 1066.625-3

Where:

$C_d$  = discharge coefficient, as determined in paragraph (b)(2)(i) of this section.

$C_f$  = flow coefficient, as determined in paragraph (b)(2)(ii) of this section.

$A_t$  = cross-sectional area at the venturi throat.

$R$  = molar gas constant.

$p_{in}$  = static absolute pressure at the venturi inlet.

$T_{std}$  = standard temperature.

$p_{std}$  = standard pressure.

$Z$  = compressibility factor.

$M_{mix}$  = molar mass of gas mixture.

$T_{in}$  = absolute temperature at the venturi inlet.

(2) Perform the following steps to calibrate an SSV flow meter:

(i) Using the data collected in § 1066.140, calculate  $C_d$  for each flow rate using the following equation:

$$C_d = \dot{Q}_{ref} \cdot \frac{p_{std} \cdot \sqrt{Z \cdot M_{mix} \cdot R \cdot T_{in}}}{C_f \cdot A_t \cdot R \cdot p_{in} \cdot T_{std}}$$

Eq. 1066.625-4

Where:

$\dot{Q}_{ref}$  = measured volume flow rate from the reference flow meter.

(ii) Use the following equation to calculate  $C_f$  for each flow rate:

$$C_f = \left[ \frac{2 \cdot \gamma \cdot \left( r^{\frac{\gamma-1}{\gamma}} - 1 \right)}{(\gamma - 1) \cdot \left( \beta^4 - r^{\frac{2}{\gamma}} \right)} \right]^{\frac{1}{2}}$$

Where:

$\gamma$  = isentropic exponent. For an ideal gas, this is the ratio of specific heats of the gas mixture,  $C_p/C_v$ .

$r$  = pressure ratio, as determined in paragraph (b)(2)(iii) of this section.

$\beta$  = ratio of venturi throat diameter to inlet diameter.

(iii) Calculate  $r$  using the following equation:

$$r = 1 - \frac{\Delta p}{p_{in}}$$

Eq. 1066.625-6

Where:

$\Delta p$  = differential static pressure, calculated as venturi inlet pressure minus venturi throat pressure.

(iv) You may apply any of the following simplifying assumptions or develop other values as appropriate for



your test configuration, consistent with good engineering judgment:

(A) For raw exhaust, diluted exhaust, and dilution air, you may assume that the gas mixture is incompressible and therefore behaves as an ideal gas ( $Z=1$ ).

(B) For raw exhaust, you may assume  $\gamma=1.385$ .

(C) For diluted exhaust and dilution air, you may assume  $\gamma=1.399$ .

(D) For diluted exhaust and dilution air, you may assume  $M_{mix}$  is a function

only of the amount of water in the dilution air or calibration air, as follows:

$$M_{mix} = M_{air} \cdot (1 - x_{H_2O}) + M_{H_2O} \cdot x_{H_2O}$$

Eq. 1066.625-7

Where:

$M_{air} = 28.96559$  g/mol

$x_{H_2O}$  = amount of  $H_2O$  in the dilution air or calibration air, determined as described in 40 CFR 1065.645.

$M_{H_2O} = 18.01528$  g/mol

Example:

$x_{H_2O} = 0.0169$  mol/mol

$M_{mix} = 28.96559 \cdot (1 - 0.0169) + 18.01528 \cdot 0.0169$

$M_{mix} = 28.7805$  g/mol

(E) For diluted exhaust and dilution air, you may assume a constant molar mass of the mixture,  $M_{mix}$ , for all calibration and all testing if you control the amount of water in dilution air and in calibration air, as illustrated in the following table:

TABLE 2 OF § 1066.625—EXAMPLES OF DILUTION AIR AND CALIBRATION AIR DEWPOINTS AT WHICH YOU MAY ASSUME A CONSTANT  $M_{mix}$

If calibration $T_{dew}$ (°C) is . . .	assume the following constant $M_{mix}$ (g/mol) . . .	for the following ranges of $T_{dew}$ (°C) during emission tests <sup>a</sup>
≤ 0	28.96559	≤ 18
0	28.89263	≤ 21
5	28.86148	≤ 22
10	28.81911	≤ 24
15	28.76224	≤ 26
20	28.68685	− 8 to 28
25	28.58806	12 to 31
30	28.46005	23 to 34

<sup>a</sup> The specified ranges are valid for all calibration and emission testing over the atmospheric pressure range (80.000 to 103.325) kPa.

(v) The following example illustrates the use of the governing equations to calculate  $C_d$  of an SSV flow meter at one reference flow meter value:

Example:

$\dot{Q}_{ref} = 2.395$  m<sup>3</sup>/s

$Z = 1$

$M_{mix} = 28.7805$  g/mol = 0.0287805 kg/mol

$R = 8.314472$  J/(mol·K) = 8.314472 (m<sup>2</sup>·kg)/(s<sup>2</sup>·mol·K)

$T_{in} = 298.15$  K

$A_t = 0.01824$  m<sup>2</sup>

$p_{in} = 99.132$  kPa = 99132 Pa = 99132 kg/(m·s<sup>2</sup>)

$\gamma = 1.399$

$\beta = 0.8$

$\Delta p = 7.653$  kPa

$$r = 1 - \frac{2.312}{99.132} = 0.922$$

$$C_f = \left[ \frac{2 \cdot 1.399 \cdot \left( 0.922^{\frac{1.399-1}{1.399}} - 1 \right)}{(1.399-1) \cdot \left( 0.8^4 - 0.922^{\frac{2}{1.399}} \right)} \right]^{\frac{1}{2}}$$

$$C_f = 0.472$$

$$C_d = 2.395 \cdot \frac{101325 \cdot \sqrt{1 \cdot 0.0287805 \cdot 8.314472 \cdot 298.15}}{0.472 \cdot 0.01824 \cdot 8.314472 \cdot 99132 \cdot 293.15}$$

$$C_d = 0.985$$

(vi) Calculate the Reynolds number,  $Re^{\#}$ , for each reference flow rate,  $\dot{Q}_{\text{ref}}$ , using the throat diameter of the venturi,  $d_t$ , and the uncorrected air density,  $\rho$ . Because the dynamic viscosity,  $\mu$ , is needed to compute  $Re^{\#}$ , you may use your own fluid viscosity model to determine  $\mu$  for your calibration gas (usually air), using good engineering judgment. Alternatively, you may use the Sutherland three-coefficient viscosity model to approximate  $\mu$ , as shown in the following sample calculation for  $Re^{\#}$ :

$$Re^{\#} = \frac{4 \cdot \rho \cdot \dot{Q}_{\text{ref}}}{\pi \cdot d_t \cdot \mu}$$

Eq. 1066.625-8

Where, using the Sutherland three-coefficient viscosity model:

$$\mu = \mu_0 \cdot \left( \frac{T_{\text{in}}}{T_0} \right)^{\frac{3}{2}} \cdot \left( \frac{T_0 + S}{T_{\text{in}} + S} \right)$$

Eq. 1066.625-9

Where:  
 $\mu_0$  = Sutherland reference viscosity.

$T_0$  = Sutherland reference temperature.  
 $S$  = Sutherland constant.

TABLE 3 OF § 1066.625—SUTHERLAND THREE-COEFFICIENT VISCOSITY MODEL PARAMETERS

Gas <sup>a</sup>	$\mu_0$	$T_0$	$S$	Temperature range within $\pm 2\%$ error <sup>b</sup>	Pressure limit <sup>b</sup>
	kg/(m·s)	K	K		
Air .....	$1.716 \cdot 10^{-5}$	273	111	170 to 1900 .....	$\leq 1800$
CO <sub>2</sub> .....	$1.370 \cdot 10^{-5}$	273	222	190 to 1700 .....	$\leq 3600$
H <sub>2</sub> O .....	$1.12 \cdot 10^{-5}$	350	1064	360 to 1500 .....	$\leq 10000$
O <sub>2</sub> .....	$1.919 \cdot 10^{-5}$	273	139	190 to 2000 .....	$\leq 2500$
N <sub>2</sub> .....	$1.663 \cdot 10^{-5}$	273	107	100 to 1500 .....	$\leq 1600$

<sup>a</sup> Use tabulated parameters only for the pure gases, as listed. Do not combine parameters in calculations to calculate viscosities of gas mixtures.

<sup>b</sup> The model results are valid only for ambient conditions in the specified ranges.

*Example:*

$$\mu_0 = 1.716 \cdot 10^{-5} \text{ kg/(m}\cdot\text{s)}$$

$$T_0 = 273 \text{ K}$$

$$S = 111 \text{ K}$$

$$\mu = 1.716 \cdot 10^{-5} \cdot \left( \frac{298.15}{273} \right)^2 \cdot \left( \frac{273 + 111}{298.15 + 111} \right)$$

$$\mu = 1.838 \cdot 10^{-5} \text{ kg/(m}\cdot\text{s)}$$

$$T_{\text{in}} = 298.15 \text{ K}$$

$$d_t = 152.4 \text{ mm} = 0.1524 \text{ m}$$

$$\rho = 1.1509 \text{ kg/m}^3$$

$$Re^{\#} = \frac{4 \cdot 1.1509 \cdot 2.395}{3.14159 \cdot 0.1524 \cdot 1.838 \cdot 10^{-5}}$$

$$Re^{\#} = 1.2531 \cdot 10^6$$

(vii) Calculate  $\rho$  using the following equation:

$$\rho = \frac{P_{in} \cdot MW_{mix}}{R \cdot T_{in}}$$

Eq. 1066.625-10

*Example:*

$$\rho = \frac{99132 \cdot 0.0287805}{8.314472 \cdot 298.15}$$

$$\rho = 1.1509 \text{ kg/m}^3$$

(viii) Create an equation for  $C_d$  as a function of  $Re^{\#}$ , using paired values of the two quantities. The equation may involve any mathematical expression, including a polynomial or a power series. The following equation is an example of a commonly used mathematical expression for relating  $C_d$  and  $Re^{\#}$ :

$$C_d = a_0 - a_1 \cdot \sqrt{\frac{10^6}{Re^{\#}}}$$

Eq. 1066.625-11

(ix) Perform a least-squares regression analysis to determine the best-fit coefficients for the equation and calculate *SEE* as described in 40 CFR 1065.602.

(x) If the equation meets the criterion of  $SEE \leq 0.5\% \cdot C_{dmax}$ , you may use the equation for the corresponding range of  $Re^{\#}$ , as described in § 1066.630(b).

(xi) If the equation does not meet the specified statistical criteria, you may use good engineering judgment to omit calibration data points; however, you must use at least seven calibration data points to demonstrate that you meet the criterion. For example, this may involve narrowing the range of flow rates for a better curve fit.

(xii) Take corrective action if the equation does not meet the specified statistical criterion even after omitting calibration data points. For example, select another mathematical expression for the  $C_d$  versus  $Re^{\#}$  equation, check for leaks, or repeat the calibration process. If you must repeat the calibration

process, we recommend applying tighter tolerances to measurements and allowing more time for flows to stabilize.

(xiii) Once you have an equation that meets the specified statistical criterion, you may use the equation only for the corresponding range of flow rates.

(c) *CFV calibration.* Some CFV flow meters consist of a single venturi and some consist of multiple venturis where different combinations of venturis are used to meter different flow rates. For CFV flow meters that consist of multiple venturis, either calibrate each venturi independently to determine a separate calibration coefficient,  $K_v$ , for each venturi, or calibrate each combination of venturis as one venturi by determining  $K_v$  for the system.

(1) To determine  $K_v$  for a single venturi or a combination of venturis, perform the following steps:

(i) Calculate an individual  $K_v$  for each calibration set point for each restrictor position using the following equation:

$$K_v = \frac{\bar{Q}_{refstd} \cdot \sqrt{\bar{T}_{in}}}{\bar{P}_{in}}$$

Eq. 1066.625-12

Where:

$\bar{Q}_{refstd}$  = mean flow rate from the reference flow meter, corrected to standard reference conditions.

$\bar{T}_{in}$  = mean temperature at the venturi inlet.

$\bar{P}_{in}$  = mean static absolute pressure at the venturi inlet.

(ii) Calculate the mean and standard deviation of all the  $K_v$  values (see 40

CFR 1065.602). Verify choked flow by plotting  $K_v$  as a function of  $\bar{P}_{in}$ .  $K_v$  will have a relatively constant value for choked flow; as vacuum pressure increases, the venturi will become unchoked and  $K_v$  will decrease. Paragraphs (c)(1)(iii) through (viii) of this section describe how to verify your range of choked flow.

(iii) If the standard deviation of all the  $K_v$  values is less than or equal to 0.3% of the mean  $K_v$ , use the mean  $K_v$  in Eq. 1066.630-7, and use the CFV only up to the highest venturi pressure ratio,  $r$ , measured during calibration using the following equation:

$$r = 1 - \frac{\Delta p_{CFV}}{\bar{P}_{in}}$$

Eq. 1066.625-13

Where:

$\Delta p_{CFV}$  = differential static pressure; venturi inlet minus venturi outlet.

(iv) If the standard deviation of all the  $K_v$  values exceeds 0.3% of the mean  $K_v$ , omit the  $K_v$  value corresponding to the data point collected at the highest  $r$  measured during calibration.

(v) If the number of remaining data points is less than seven, take corrective action by checking your calibration data or repeating the calibration process. If you repeat the calibration process, we recommend checking for leaks, applying tighter tolerances to measurements and allowing more time for flows to stabilize.

(vi) If the number of remaining  $K_v$  values is seven or greater, recalculate

the mean and standard deviation of the remaining  $K_v$  values.

(vii) If the standard deviation of the remaining  $K_v$  values is less than or equal to 0.3% of the mean of the remaining  $K_v$ , use that mean  $K_v$  in Eq 1066.630-7, and use the CFV values only up to the highest  $r$  associated with the remaining  $K_v$ .

(viii) If the standard deviation of the remaining  $K_v$  still exceeds 0.3% of the mean of the remaining  $K_v$  values, repeat the steps in paragraph (c)(1)(iv) through (vii) of this section.

(2) During exhaust emission tests, monitor sonic flow in the CFV by monitoring  $r$ . Based on the calibration data selected to meet the standard deviation criterion in paragraphs (c)(1)(iv) and (vii) of this section, in which  $K_v$  is constant, select the data values associated with the calibration

point with the lowest absolute venturi inlet pressure to determine the  $r$  limit. Calculate  $r$  during the exhaust emission test using Eq. 1066.625-8 to demonstrate that the value of  $r$  during all emission tests is less than or equal to the  $r$  limit derived from the CFV calibration data.

#### § 1066.630 PDP, SSV, and CFV flow rate calculations.

This section describes the equations for calculating flow rates from various flow meters. After you calibrate a flow meter according to § 1066.625, use the calculations described in this section to calculate flow during an emission test. Calculate flow according to 40 CFR 1065.642 instead if you calculate emissions based on molar flow rates.

(a) *PDP*. (1) Based on the speed at which you operate the PDP for a test

interval, select the corresponding slope,  $a_1$ , and intercept,  $a_0$ , as determined in § 1066.625(a), to calculate PDP flow rate,  $\dot{Q}$ , as follows:

$$\dot{Q} = f_{n\text{PDP}} \cdot \frac{V_{\text{rev}} \cdot T_{\text{std}} \cdot p_{\text{in}}}{T_{\text{in}} \cdot p_{\text{std}}}$$

#### Eq. 1066.630-1

Where:

$f_{n\text{PDP}}$  = pump speed.

$V_{\text{rev}}$  = PDP volume pumped per revolution, as determined in paragraph (a)(2) of this section.

$T_{\text{std}}$  = standard temperature = 293.15 K.

$p_{\text{in}}$  = static absolute pressure at the PDP inlet.

$T_{\text{in}}$  = absolute temperature at the PDP inlet.

$p_{\text{std}}$  = standard pressure = 101.325 kPa.

(2) Calculate  $V_{\text{rev}}$  using the following equation:

$$V_{\text{rev}} = \frac{a_1}{f_{n\text{PDP}}} \cdot \sqrt{\frac{p_{\text{out}} - p_{\text{in}}}{p_{\text{out}}}} + a_0$$

#### Eq. 1066.630-2

$p_{\text{out}}$  = static absolute pressure at the PDP outlet.

Where:

$C_d$  = discharge coefficient, as determined based on the  $C_d$  versus  $Re^{\#}$  equation in § 1066.625(b)(2)(viii).

$C_f$  = flow coefficient, as determined in § 1066.625(b)(2)(ii).

$A_t$  = venturi throat cross-sectional area.

$R$  = molar gas constant.

$p_{\text{in}}$  = static absolute pressure at the venturi inlet.

$T_{\text{std}}$  = standard temperature.

$p_{\text{std}}$  = standard pressure.

$Z$  = compressibility factor.

$M_{\text{mix}}$  = molar mass of gas mixture.

$T_{\text{in}}$  = absolute temperature at the venturi inlet.

*Example:*

$$C_d = 0.890$$

$$C_f = 0.472$$

$$A_t = 0.01824 \text{ m}^2$$

$$R = 8.314472 \text{ J}/(\text{mol}\cdot\text{K}) = 8.314472 \text{ (m}^2\cdot\text{kg)} / (\text{s}^2\cdot\text{mol}\cdot\text{K})$$

$$p_{\text{in}} = 98.496 \text{ kPa}$$

$$T_{\text{std}} = 293.15 \text{ K}$$

$$p_{\text{std}} = 101.325 \text{ kPa}$$

$$Z = 1$$

$$M_{\text{mix}} = 28.7789 \text{ g/mol} = 0.0287789 \text{ kg/mol}$$

$$T_{\text{in}} = 296.85 \text{ K}$$

$$\dot{Q} = 0.89 \cdot 0.472 \cdot \frac{0.01824 \cdot 8.314472 \cdot 98.496 \cdot 293.15}{101.325 \cdot \sqrt{1 \cdot 0.0287805 \cdot 8.314472 \cdot 296.85}}$$

$$\dot{Q} = 2.155 \text{ m}^3/\text{s}$$

(c) *CFV*. If you use multiple venturis and you calibrated each venturi independently to determine a separate calibration coefficient,  $K_v$ , for each venturi, calculate the individual volume flow rates through each venturi and sum all their flow rates to determine CFV flow rate,  $\dot{Q}$ . If you use multiple venturis and you calibrated venturis in combination, calculate  $\dot{Q}$  using the  $K_v$  that was determined for that combination of venturis.

(1) To calculate  $\dot{Q}$  through one venturi or a combination of venturis, use the mean  $K_v$  you determined in § 1066.625(c) and calculate the appropriate quantity for  $\dot{Q}$  as follows:

$$\dot{Q} = \frac{K_v \cdot p_{\text{in}}}{\sqrt{T_{\text{in}}}}$$

Eq. 1066.630-7

Where:

$K_v$  = flow meter calibration coefficient.

$T_{\text{in}}$  = temperature at the venturi inlet.

$p_{\text{in}}$  = absolute static pressure at the venturi inlet.

*Example:*

$$K_v = 0.074954 \text{ m}^3 \cdot \text{K}^{0.5} / (\text{kPa} \cdot \text{s})$$

$$p_{\text{in}} = 99.654 \text{ kPa}$$

$$T_{\text{in}} = 353.15 \text{ K}$$

$$\dot{Q} = \frac{0.074954 \cdot 99.654}{\sqrt{353.15}}$$

$$\dot{Q} = 0.39748 \text{ m}^3/\text{s}$$

(2) [Reserved]

#### § 1066.635 NMOG determination.

For vehicles subject to an NMOG standard, determine NMOG as described in paragraph (a) of this section. Except as specified in the standard-setting part, you may alternatively calculate NMOG results based on measured NMHC emissions as described in paragraphs (c) through (f) of this section.

(a) Determine NMOG by independently measuring alcohols and carbonyls as described in 40 CFR 1065.805 and 1065.845. Use good engineering judgment to determine which alcohols and carbonyls you need to measure. This would typically require you to measure all alcohols and carbonyls that you expect to contribute 1% or more of total NMOG. Calculate the mass of NMOG in the exhaust,  $m_{\text{NMOG}}$ , with the following equation, using density values specified in § 1066.1005(f):

$$m_{\text{NMOG}} = m_{\text{NMHC}} - \rho_{\text{NMHC}} \cdot \sum_{i=1}^N \frac{m_{\text{OHC}_i}}{\rho_{\text{OHC}_i}} \cdot RF_{\text{OHC}_i[\text{THC-FID}]} + \sum_{i=1}^N m_{\text{OHC}_i}$$

Eq. 1066.635-1

Where:

$m_{\text{NMHC}}$  = the mass of NMHC and all oxygenated hydrocarbons (OHCs) in the exhaust, as determined using Eq. 1066.605-1. Calculate NMHC mass based on  $\rho_{\text{NMHC}}$ .

$\rho_{\text{NMHC}}$  = the effective C<sub>1</sub>-equivalent density of NMHC as specified in § 1066.1005(f).

$m_{\text{OHC}_i}$  = the mass of oxygenated species  $i$  in the exhaust calculated using Eq. 1066.605-1.

$\rho_{\text{OHC}_i}$  = the C<sub>1</sub>-equivalent density of oxygenated species  $i$ .

$RF_{\text{OHC}_i[\text{THC-FID}]}$  = the response factor of a THC-FID to oxygenated species  $i$  relative to propane on a C<sub>1</sub>-equivalent basis as determined in 40 CFR 1065.845.

(b) The following example shows how to determine NMOG as described in paragraph (a) of this section for (OHC) compounds including ethanol (C<sub>2</sub>H<sub>5</sub>OH), methanol (CH<sub>3</sub>OH), acetaldehyde (C<sub>2</sub>H<sub>4</sub>O), and formaldehyde (CH<sub>2</sub>O) as C<sub>1</sub>-equivalent concentrations:

$m_{\text{NMHC}} = 0.0125$  g

$m_{\text{CH}_3\text{OH}} = 0.0002$  g

$m_{\text{C}_2\text{H}_5\text{OH}} = 0.0009$  g

$m_{\text{CH}_2\text{O}} = 0.0001$  g

$m_{\text{C}_2\text{H}_4\text{O}} = 0.00005$  g

$RF_{\text{CH}_3\text{OH}[\text{THC-FID}]} = 0.63$

$RF_{\text{C}_2\text{H}_5\text{OH}[\text{THC-FID}]} = 0.75$

$RF_{\text{CH}_2\text{O}[\text{THC-FID}]} = 0.00$

$RF_{\text{C}_2\text{H}_4\text{O}[\text{THC-FID}]} = 0.50$

$\rho_{\text{NMHC-liq}} = 576.816$  g/m<sup>3</sup>

$\rho_{\text{CH}_3\text{OH}} = 1332.02$  g/m<sup>3</sup>

$\rho_{\text{C}_2\text{H}_5\text{OH}} = 957.559$  g/m<sup>3</sup>

$\rho_{\text{CH}_2\text{O}} = 1248.21$  g/m<sup>3</sup>

$\rho_{\text{C}_2\text{H}_4\text{O}} = 915.658$  g/m<sup>3</sup>

$$m_{\text{NMOG}} = 0.0125 - 576.816 \cdot \left( \frac{0.0002}{1332.02} \cdot 0.63 + \frac{0.0009}{957.559} \cdot 0.75 + \frac{0.0001}{1248.21} \cdot 0.00 + \frac{0.00005}{915.658} \cdot 0.5 \right) +$$

$$0.0002 + 0.0009 + 0.0001 + 0.00005$$

$$m_{\text{NMOG}} = 0.013273$$

(c) For ethanol-gasoline blends with less than 25% ethanol by volume, you may calculate NMOG from measured NMHC emissions as follows:

(1) For hot-start and hot-running test cycles or intervals other than the FTP, you may determine NMOG based on the NMHC emission rate using the following equation:

$$e_{\text{NMOGh}} = e_{\text{NMHC}_h} \cdot 1.03$$

Eq. 1066.635-2

Where:

$e_{\text{NMOGh}}$  = mass emission rate of NMOG from the hot-running test cycle.

$e_{\text{NMHC}_h}$  = mass emission rate of NMHC from the hot-running test cycle, calculated using  $\rho_{\text{NMHC-liq}}$ .

Example:

$e_{\text{NMHC}_h} = 0.025$  g/mi

$e_{\text{NMOGh}} = 0.025 \cdot 1.03 = 0.026$  g/mi

(2) You may determine weighted composite NMOG for FTP testing based on the weighted composite NMHC emission rate and the volume percent of ethanol in the fuel using the following equation:

$$e_{\text{NMOGcomp}} = e_{\text{NMHCcomp}} \cdot (1.0302 + 0.0071 \cdot VP_{\text{EtOH}})$$

Eq. 1066.635-3

Where:

$e_{\text{NMOGcomp}}$  = weighted FTP composite mass emission rate of NMOG.

$e_{\text{NMHCcomp}}$  = weighted FTP composite mass emission rate of NMHC, calculated using  $\rho_{\text{NMHC-liq}}$ .

$VP_{\text{EtOH}}$  = volume percentage of ethanol in the test fuel. Use good engineering judgment to determine this value either as

specified in 40 CFR 1065.710 or based on blending volumes, taking into account any denaturant.

Example:

$e_{\text{NMHCcomp}} = 0.025$  g/mi

$VP_{\text{EtOH}} = 10.1\%$

$e_{\text{NMOGcomp}} = 0.025 \cdot (1.0302 + 0.0071 \cdot 10.1) = 0.0275$  g/mi

(3) You may determine NMOG for the transient portion of the FTP cold-start test for use in fuel economy and CREE calculations based on the NMHC emission rate for the test interval and the volume percent of ethanol in the fuel using the following equation:

$$e_{\text{NMOG-FTPct}} = e_{\text{NMHC-FTPct}} \cdot (1.0246 + 0.0079 \cdot VP_{\text{EtOH}})$$

Eq. 1066.635-4

Where:

$e_{\text{NMOG-FTPct}}$  = mass emission rate of NMOG from the transient portion of the FTP cold-start test (generally known as bag 1).  
 $e_{\text{NMHC-FTPct}}$  = mass emission rate of NMHC from the transient portion of the FTP cold-start test (bag 1), calculated using  $\rho_{\text{NMHC-liq}}$ .

Example:

$e_{\text{NMHC-FTPct}} = 0.052 \text{ g/mi}$   
 $VP_{\text{EtOH}} = 10.1\%$   
 $e_{\text{NMOG-FTPct}} = 0.052 \cdot (1.0246 + 0.0079 \cdot 10.1) = 0.0574 \text{ g/mi}$   
 (4) You may determine NMOG for the stabilized portion of the FTP test for

either the cold-start test or the hot-start test (bag 2 or bag 4) for use in fuel economy and CREE calculations based on the corresponding NMHC emission rate and the volume percent of ethanol in the fuel using the following equation:

$$e_{\text{NMOG-FTPcs-hs}} = e_{\text{NMHC-FTPcs-hs}} \cdot (1.1135 + 0.001 \cdot VP_{\text{EtOH}})$$

Eq. 1066.635-5

Where:

$e_{\text{NMOG-FTPcs-hs}}$  = mass emission rate of NMOG from the stabilized portion of the FTP test (bag 2 or bag 4).  
 $e_{\text{NMHC-FTPcs-hs}}$  = mass emission rate of NMHC from the stabilized portion of the FTP

test (bag 2 or bag 4), calculated using  $\rho_{\text{NMHC-liq}}$ .  
 (5) You may determine NMOG for the transient portion of the FTP hot-start test for use in fuel economy and CREE

calculations based on the NMHC emission rate for the test interval and the volume percent of ethanol in the fuel using the following equation:

$$e_{\text{NMOG-FTPht}} = e_{\text{NMHC-FTPht}} \cdot (1.0195 + 0.0031 \cdot VP_{\text{EtOH}})$$

Eq. 1066.635-6

Where:

$e_{\text{NMOG-FTPht}}$  = mass emission rate of NMOG from the transient portion of the FTP hot-start test (bag 3).  
 $e_{\text{NMHC-FTPht}}$  = mass emission rate of NMHC from the transient portion of the FTP hot-start test (bag 3), calculated using  $\rho_{\text{NMHC-liq}}$ .

(d) You may take the following alternative steps when determining fuel economy and CREE under 40 CFR Part 600 for testing with ethanol-gasoline blends that have up to 25% ethanol by volume:

(1) Calculate NMOG by test interval using Eq. 1066.635-3 for individual bag measurements from the FTP.

(2) For HEVs, calculate NMOG for two-bag FTPs using Eq. 1066.635-3 as described in 40 CFR 600.114.

(e) We consider NMOG values for diesel-fueled vehicles, CNG-fueled vehicles, LNG-fueled vehicles, and LPG-fueled vehicles to be equivalent to NMHC emission values for all test cycles.

(f) For all fuels not covered by paragraphs (c) and (e) of this section, manufacturers may propose a methodology to calculate NMOG results from measured NMHC emissions. We will approve adjustments based on comparative testing that demonstrates how to properly represent NMOG based on measured NMHC emissions.

#### § 1066.695 Data requirements.

Record information for each test as follows:

(a) Test number.

(b) A brief description of the test vehicle (or other system/device tested).

(c) Date and time of day for each part of the test sequence.

(d) Test results. Also include a validation of driver accuracy as described in § 1066.425(j).

(e) Driver and equipment operators.

(f) Vehicle information as applicable, including identification number, model year, applicable emission standards (including bin standards or family emission limits, as applicable), vehicle model, vehicle class, test group, durability group, engine family, evaporative/refueling emission family, basic engine description (including displacement, number of cylinders, turbocharger/supercharger used, and catalyst type), fuel system (type of fuel injection and fuel tank capacity and location), engine code, GVWR, applicable test weight, inertia weight class, actual curb weight at zero miles, actual road load at 50 mph, transmission class and configuration, axle ratio, odometer reading, idle rpm, and measured drive wheel tire pressure.

(g) Dynamometer identification, inertia weight setting, indicated power absorption setting, and records to verify compliance with the driving distance and cycle-validation criteria as calculated from measured roll or shaft revolutions.

(h) Analyzer bench identification, analyzer ranges, recordings of analyzer output during zero, span, and sample readings.

(i) Associate the following information with the test record: test number, date, vehicle identification, vehicle and equipment operators, and identification of the measurements recorded.

(j) Test cell barometric pressure and humidity. You may use a central laboratory barometer if the barometric pressure in each test cell is shown to be within  $\pm 0.1\%$  of the barometric pressure at the central barometer location.

(k) Records to verify compliance with the ambient temperature requirements throughout the test procedure and records of fuel temperatures during the running loss test.

(l) [Reserved]

(m) For CVS systems, record dilution factor for each test interval and the following additional information:

(1) For CFV and SSV testing,  $V_{\text{mix}}$  for each interval of the exhaust test.

(2) For PDP testing, test measurements required to calculate  $V_{\text{mix}}$  for each test interval.

(n) The humidity of the dilution air, if you remove  $\text{H}_2\text{O}$  from an emission sample before measurement.

(o) Temperature of the dilute exhaust mixture and secondary dilution air (in the case of a double-dilution system) at the inlet to the respective gas meter or flow instrumentation used for PM sampling. Determine minimum values, maximum values, mean values, and percent of time outside of the tolerance over each test interval.

(p) The maximum exhaust gas temperature over the course of the test



interval within 20 cm upstream or downstream of PM sample media.

(q) If applicable, the temperatures of the heated FID, the gas in the heated sample line, and the heated filter.

Determine minimum values, maximum values, average values, and percent of time outside of the tolerance over each test interval.

(r) Gas meter or flow measurement instrumentation readings used for batch sampling over each test interval.

Determine minimum, maximum, and average values over each test interval.

(s) The stabilized pre-test weight and post-test weight of each particulate sample media (e.g., filter).

(t) Continuous temperature and humidity of the ambient air in which the PM sample media are stabilized. Determine minimum values, maximum values, average values, and percent of time outside of the tolerance over each test interval.

(u) For vehicles fueled by natural gas, the test fuel composition, including all carbon-containing compounds (including CO<sub>2</sub>, but excluding CO). Record C<sub>1</sub> and C<sub>2</sub> compounds

individually. You may record C<sub>3</sub> through C<sub>5</sub> hydrocarbons together, and you may record C<sub>6</sub> and heavier hydrocarbon compounds together.

(v) For vehicles fueled by liquefied petroleum gas, the test fuel composition, including all carbon-containing compounds (including CO<sub>2</sub>, but excluding CO). Record C<sub>1</sub> through C<sub>4</sub> compounds individually. You may record C<sub>5</sub> and heavier hydrocarbons together.

(w) For the AC17 test in § 1066.845, interior volume, climate control system type and characteristics, refrigerant used, compressor type, and evaporator/condenser characteristics.

(x) Additional information related to evaporative emissions. [Reserved]

(y) Additional information related to refueling emissions. [Reserved]

#### **Subpart H—Cold Temperature Test Procedures**

##### **§ 1066.701 Applicability and general provisions.**

(a) The procedures of this part 1066 may be used for testing at any ambient

temperature. Section 1066.710 describes the provisions that apply for testing vehicles at a nominal temperature of 20 °C (68 °F); these procedures apply for motor vehicles as described in 40 CFR Part 86, subpart S, and 40 CFR Part 600. For other vehicles, see the standard-setting part to determine if your vehicle is required to meet emission standards outside the normal (20 to 30) °C ((68 to 86) °F) temperature range.

(b) Do not apply the humidity correction factor in § 1066.615(a) for cold temperature testing.

##### **§ 1066.710 Cold temperature testing procedures for measuring CO and NMHC emissions and determining fuel economy.**

This section describes procedures for measuring carbon monoxide (CO) and nonmethane hydrocarbon (NMHC) emissions and determining fuel economy on a cold day using the FTP test cycle (see § 1066.801). The following figure illustrates the test procedure:

Figure 1 of § 1066.710— Cold temperature testing sequence for measuring CO and NMHC emissions and determining fuel economy

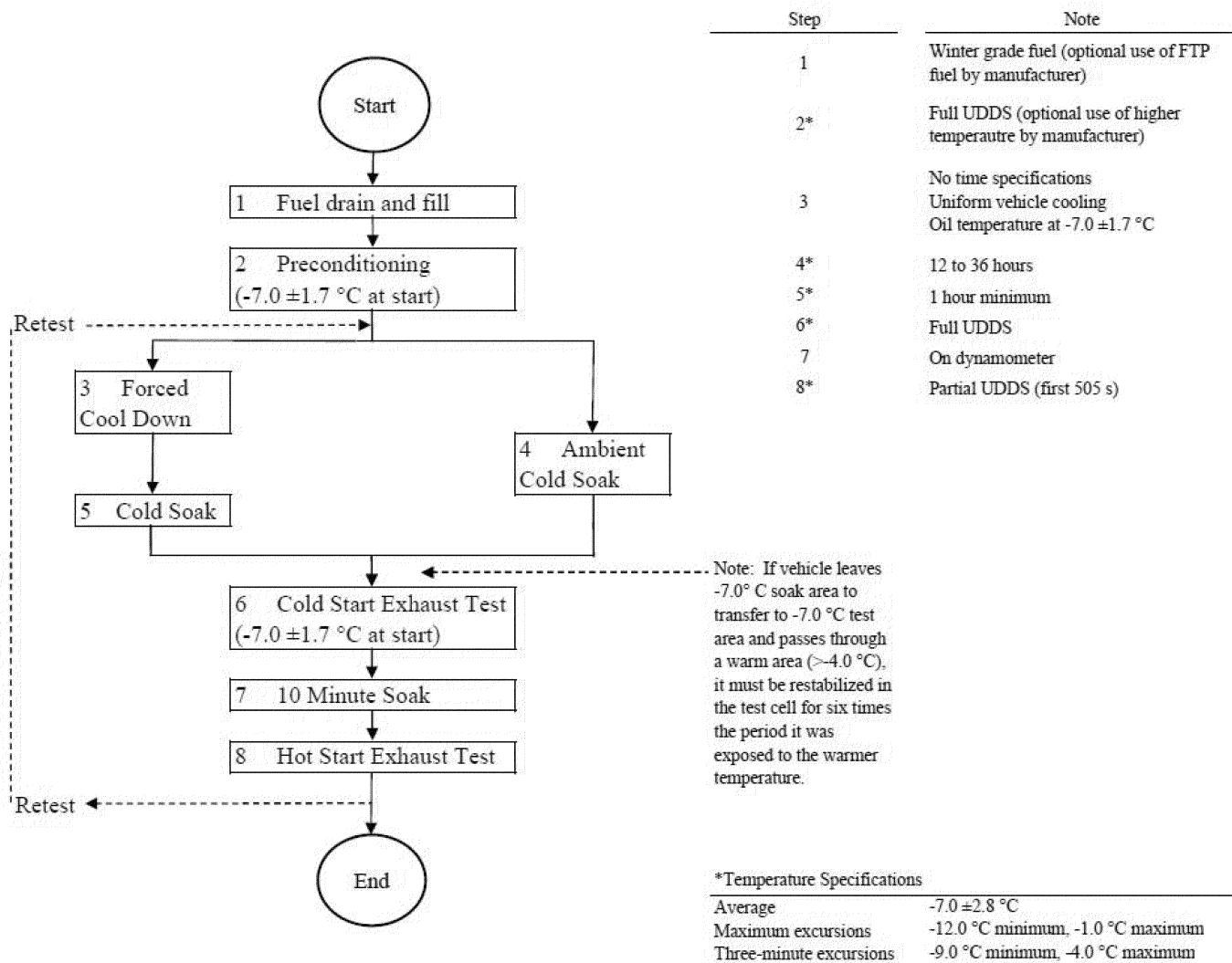

(a) Follow the exhaust emission measurement procedures specified in §§ 1066.410 through 1066.425 and § 1066.815(d), subject to the following exceptions and additional provisions:

(1) Measure and control ambient conditions as specified in paragraph (b) of this section.

(2) Use the vehicle's heater and defroster as specified in paragraph (c) of this section.

(3) Precondition and stabilize the vehicle as specified in paragraphs (d) and (e) of this section. Ensure that there is no precipitation or dew on the vehicle before the emission test.

(4) For dynamometers that have independently heated bearings, start the emission test within 20 minutes after warming up the dynamometer; for other types of dynamometers, start the emission test within 10 minutes after warming up the dynamometer.

(5) Adjust the dynamometer to simulate vehicle operation on the road at  $-7^{\circ}\text{C}$ . Base this adjustment on the road-load force profile at  $-7^{\circ}\text{C}$ , or on a 10 percent decrease in the target coastdown time used for FTP testing.

(6) Analyze samples for NMHC, CO, and CO<sub>2</sub>. You do not need to analyze samples for other pollutants.

(b) Maintain ambient conditions as follows instead of following the specifications in subpart E of this part:

(1) *Ambient temperature for emission tests.* Measure and record ambient temperature in the test cell at least once every 60 seconds during the sampling period. The temperature must be ( $-7.0 \pm 1.7$ ) °C at the start of the test and average temperature must be ( $-7.0 \pm 2.8$ ) °C during the test. Instantaneous temperature values may be above  $-4.0^{\circ}\text{C}$  or below  $-9.0^{\circ}\text{C}$ , but not for more than 3 minutes at a time during the test.

(2) *Ambient temperature for preconditioning.* Instantaneous ambient temperature values may be above  $-4.0^{\circ}\text{C}$  or below  $-9.0^{\circ}\text{C}$  but not for more than 3 minutes at a time during the preconditioning period. At no time may the ambient temperatures be below  $-12.0^{\circ}\text{C}$  or above  $-1.0^{\circ}\text{C}$ . The average ambient temperature during preconditioning must be ( $-7.0 \pm 2.8$ ) °C. You may precondition vehicles at temperatures above  $-7.0^{\circ}\text{C}$  or with a temperature tolerance greater than that described in this section (or both) if you determine that this will not cause NMHC, CO, or CO<sub>2</sub> emissions to decrease; if you modify the temperature specifications for vehicle preconditioning, adjust the procedures described in this section appropriately for your testing.

(3) *Ambient humidity.* Maintain humidity low enough to prevent condensation on the dynamometer rolls during testing.

(c) *Heater and defroster.* During the test, operate the vehicle's interior climate control system with the heat on and set to primarily defrost the front window. Turn air conditioning off. You may not use any supplemental auxiliary heat during this testing. You may set the heater to any temperature and fan setting during vehicle preconditioning.

(1) *Manually controlled systems.* (i) Prior to the first acceleration, 20 seconds after the start of the UDDS, set the climate control as follows (these settings may be initiated prior to starting the vehicle if allowed by the vehicle's climate control system):

(A) *Temperature.* Set controls to maximum heat.

(B) *Fan speed.* Set the fan speed to full off or the lowest available speed if a full off position is not available.

(C) *Airflow direction.* Direct airflow to the front window (window defrost mode).

(D) *Air source.* If independently controllable, set the system to draw in outside air.

(ii) At the second idle of the test cycle, which occurs 125 seconds after the start of the test, set the fan speed to maximum. Complete by 130 seconds after the start of the test. Leave temperature and air source settings unchanged.

(iii) At the sixth idle of the test interval, which occurs at the deceleration to zero miles per hour 505 seconds after the start of the test, set the fan speed to the lowest setting that maintains air flow. Complete these changes by 510 seconds after the start of the test. You may use different vent and fan speed settings for the remainder of the test. Leave the temperature and air source settings unchanged.

(2) *Automatic control systems.* For vehicles with automatic control systems, you may follow the provisions of paragraph (c)(1) of this section or you may set the temperature to 72 °F and the air flow control to the front window defrost mode for the whole test.

(3) *Multiple-zone systems.* For vehicles that have separate driver and passenger controls or separate front and rear controls, you must set all temperature and fan controls as described in paragraphs (c)(1) and (2) of this section, except that rear controls need not be set to defrost the front window.

(4) *Alternative test procedures.* We may approve the use of other settings under 40 CFR 86.1840 if a vehicle's

climate control system is not compatible with the provisions of this section.

(d) Take the following steps to prepare and precondition vehicles for testing under this section:

(1) Prepare the vehicle as described in § 1066.810(a).

(2) Fill the fuel tank to approximately 40% of the manufacturer's nominal fuel tank capacity with the appropriate test fuel for cold temperature testing as specified 40 CFR Part 1065, subpart H. The temperature of the dispensed test fuel must be at or below  $15.5^{\circ}\text{C}$ . If the leftover fuel in the fuel tank before the refueling event does not meet these specifications, drain the fuel tank before refueling. You may operate the vehicle prior to the preconditioning drive to eliminate fuel effects on adaptive memory systems.

(3) You may start the preconditioning drive once the fuel in the fuel tank reaches ( $12.6$  to  $-1.4$ ) °C. Precondition the vehicle as follows:

(i) Push or drive the vehicle onto the dynamometer.

(ii) Operate the vehicle over one UDDS. You may perform additional vehicle preconditioning with repeated driving over the UDDS, subject to our advance approval.

(iii) Turn off the test vehicle and any cooling fans within 5 minutes after completing the preconditioning drive. Ambient temperature must be between ( $-12.0$  and  $-1.0$ ) °C in the 5 minutes following the preconditioning drive.

(iv) Do not manually purge or load the evaporative canister.

(e) Soak the vehicle for (12 to 36) hours to stabilize it at test temperatures before starting the emission test as described in this paragraph (e). If you move a stabilized vehicle through a warm area when transporting it to the dynamometer for testing, you must restabilize the vehicle by holding it at an ambient temperature within the range specified in paragraph (b)(1) of this section for at least six times as long as the vehicle was exposed to warmer temperatures. Use one of the following methods to reach a stabilized condition:

(1) *Cold storage.* Measure and record ambient temperature in the test cell at least once every 60 seconds during the ambient cold soak period. These ambient temperatures may be above  $-4.0^{\circ}\text{C}$  or below  $-9.0^{\circ}\text{C}$ , but not for more than 3 minutes at a time. Use measured values to calculate an hourly average temperature. Each hourly average temperature must be ( $-7.0 \pm 2.8$ ) °C.

(2) *Forced-cooling or warming.* Position fans to blow temperature-controlled air onto the vehicle to stabilize the vehicle at the specified

temperatures for emission testing. Position fans to target the vehicle's drive train, engine block, and radiator rather than the oil pan. You may not place fans under the vehicle. You may consider the vehicle to be stabilized at the test temperature when the bulk oil temperature reaches (−8.7 to −5.3) °C; measure oil temperature at one or more points away from the side or bottom surfaces of the oil pan. Each oil temperature measurement must be within the specified range before stabilization is complete. Once the vehicle reaches this stabilized condition, cold soak the vehicle within the stabilized temperature range for at least one hour before starting the emission test. During this time, keep the ambient temperature within the range specified in paragraph (b)(1) of this section.

### Subpart I—Exhaust Emission Test Procedures for Motor Vehicles

#### § 1066.801 Applicability and general provisions.

This subpart I specifies how to apply the test procedures of this part for light-duty vehicles, light-duty trucks, and heavy-duty vehicles at or below 14,000 pounds GVWR that are subject to chassis testing for exhaust emissions under 40 CFR Part 86, subpart S. For these vehicles, references in this part 1066 to the standard-setting part include this subpart I.

(a) Use the procedures detailed in this subpart to measure vehicle emissions over a specified drive schedule in conjunction with subpart E of this part. Where the procedures of subpart E of this part differ from this subpart I, the provisions in this subpart I take precedence.

(b) Collect samples of every pollutant for which an emission standard applies, unless specified otherwise.

(c) This subpart covers the following test procedures:

(1) The Federal Test Procedure (FTP), which includes the general driving cycle. This procedure is also used for measuring evaporative emissions. This may be called the conventional test since it was adopted with the earliest emission standards.

(i) The FTP consists of one Urban Dynamometer Driving Schedule (UDDS) as specified in paragraph (a) of Appendix I of 40 CFR Part 86, followed by a 10-minute soak with the engine off and repeat driving through the first 505 seconds of the UDDS. Note that the UDDS represents about 7.5 miles of driving in an urban area. Engine startup (with all accessories turned off), operation over the initial UDDS, and

engine shutdown make a complete cold-start test. The hot-start test consists of the first 505 seconds of the UDDS following the 10-minute soak and a hot-running portion of the UDDS after the first 505 seconds. The first 505 seconds of the UDDS is considered the transient portion; the remainder of the UDDS is considered the stabilized (or hot-stabilized) portion. The hot-stabilized portion for the hot-start test is generally measured during the cold-start test; however, in certain cases, the hot-start test may involve a second full UDDS following the 10-minute soak, rather than repeating only the first 505 seconds. See §§ 1066.815 and 1066.820.

(ii) Evaporative emission testing includes a preconditioning drive with the UDDS and a full FTP cycle, including exhaust measurement, followed by evaporative emission measurements. In the three-day diurnal test sequence, the exhaust test is followed by a running loss test consisting of a UDDS, then two New York City Cycles as specified in paragraph (e) of Appendix I of 40 CFR Part 86, followed by another UDDS; see 40 CFR 86.134. Note that the New York City Cycle represents about 1.18 miles of driving in a city center. The running loss test is followed by a high-temperature hot soak test as described in 40 CFR 86.138 and a three-day diurnal emission test as described in 40 CFR 86.133. In the two-day diurnal test sequence, the exhaust test is followed by a low-temperature hot soak test as described in 40 CFR 86.138–96(k) and a two-day diurnal emission test as described in 40 CFR 86.133–96(p).

(iii) Refueling emission tests for vehicles that rely on integrated control of diurnal and refueling emissions includes vehicle operation over the full FTP test cycle corresponding to the three-day diurnal test sequence to precondition and purge the evaporative canister. For non-integrated systems, there is a preconditioning drive over the UDDS and a refueling event, followed by repeated UDDS driving to purge the evaporative canister. The refueling emission test procedures are described in 40 CFR 86.150 through 86.157.

(2) The Supplemental Federal Test Procedure (SFTP) measures the emission effects from aggressive driving and operation with the vehicle's air conditioner. The SFTP is based on a composite of three different test elements. In addition to the FTP, vehicles generally operate over the US06 and SC03 driving schedules as specified in paragraphs (g) and (h) of Appendix I of 40 CFR Part 86, respectively. In the case of heavy-duty vehicles above 10,000 pounds GVWR

and at or below 14,000 pounds GVWR, SFTP testing involves additional driving over the LA–92 driving schedule specified in paragraph (c) of 40 CFR Part 86, Appendix I, instead of the US06 driving schedule. Note that the US06 driving schedule represents about 8.0 miles of relatively aggressive driving; the SC03 driving schedule represents about 3.6 miles of urban driving with the air conditioner operating; and the LA–92 driving schedule represents about 9.8 miles of relatively aggressive driving for commercial trucks. See §§ 1066.815 and 1066.820.

(3) The Highway Fuel Economy Test (HFET) is specified in Appendix I of 40 CFR Part 600. Note that the HFET represents about 10.2 miles of rural and freeway driving with an average speed of 48.6 mph and a maximum speed of 60.0 mph. See § 1066.840.

(4) Cold temperature standards apply for CO and NMHC emissions when vehicles operate over the FTP at a nominal temperature of −7 °C. See 40 CFR Part 86, subpart C, and subpart H of this part.

(5) Emission measurement to determine air conditioning credits for greenhouse gas standards. In this optional procedure, manufacturers operate vehicles over repeat runs of the AC17 test sequence to allow for calculating credits as part of demonstrating compliance with CO<sub>2</sub> emission standards. The AC17 test sequence consists of a UDDS preconditioning drive, followed by emission measurements over the SC03 and HFET driving schedules. See § 1066.845.

(d) The following provisions apply for all testing:

(1) Ambient temperatures encountered by the test vehicle must be (20 to 30) °C, unless otherwise specified. Where ambient temperature specifications apply before or between test measurements, the vehicle may be exposed to temperatures outside of the specified range for up to 10 minutes to account for vehicle transport or other actions to prepare for testing. The temperatures monitored during testing must be representative of those experienced by the test vehicle. For example, do not measure ambient temperatures near a heat source.

(2) Do not operate or store the vehicle at an incline if good engineering judgment indicates that it would affect emissions.

(3) If a test is void after collecting emission data from previous test segments, the test may be repeated to collect only those data points needed to complete emission measurements. You may combine emission measurements

from different test runs to demonstrate compliance with emission standards.

(4) Prepare vehicles for testing as described in § 1066.810.

(e) The following figure illustrates the FTP test sequence for measuring exhaust and evaporative emissions:

Figure 1 of § 1066.801—FTP test sequence

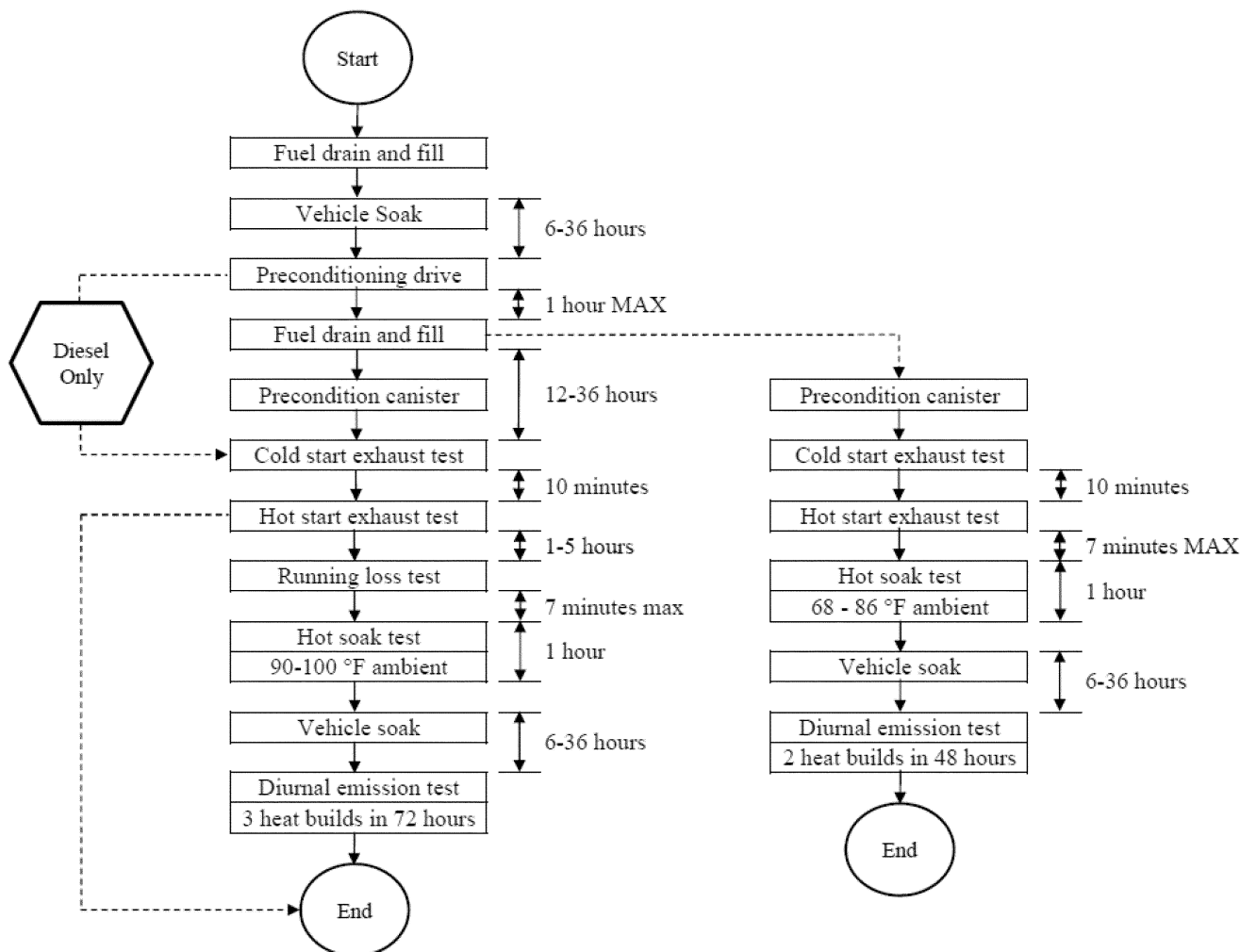

**§ 1066.805 Road-load power, test weight, and inertia weight class determination.**

(a) Simulate a vehicle's test weight on the dynamometer using the appropriate equivalent test weight shown in Table 1 of this section. Equivalent test weights are established according to each vehicle's test weight basis, as described in paragraph (b) of this section. Table 1 also specifies the inertia weight class corresponding to each equivalent test weight; the inertia weight class allows for grouping vehicles with a range of equivalent test weights. Table 1 follows:

TABLE 1 OF § 1066.805—EQUIVALENT TEST WEIGHTS (POUNDS)

Test weight	Equivalent test	Inertia weight
Up to 1062 .....	1000	1000
1063 to 1187 ....	1125	1000
1188 to 1312 ....	1250	1250
1313 to 1437 ....	1375	1250
1438 to 1562 ....	1500	1500
1563 to 1687 ....	1625	1500
1688 to 1812 ....	1750	1750
1813 to 1937 ....	1875	1750
1938 to 2062 ....	2000	2000
2063 to 2187 ....	2125	2000
2188 to 2312 ....	2250	2250
2313 to 2437 ....	2375	2250
2438 to 2562 ....	2500	2500
2563 to 2687 ....	2625	2500
2688 to 2812 ....	2750	2750
2813 to 2937 ....	2875	2750
2938 to 3062 ....	3000	3000

TABLE 1 OF § 1066.805—EQUIVALENT TEST WEIGHTS (POUNDS)—Continued

Test weight	Equivalent test	Inertia weight
3063 to 3187 ....	3125	3000
3188 to 3312 ....	3250	3000
3313 to 3437 ....	3375	3500
3438 to 3562 ....	3500	3500
3563 to 3687 ....	3625	3500
3688 to 3812 ....	3750	3500
3813 to 3937 ....	3875	4000
3938 to 4125 ....	4000	4000
4126 to 4375 ....	4250	4000
4376 to 4625 ....	4500	4500
4626 to 4875 ....	4750	4500
4876 to 5125 ....	5000	5000
5126 to 5375 ....	5250	5000
5376 to 5750 ....	5500	5500
5751 to 6250 ....	6000	6000
6251 to 6750 ....	6500	6500
6751 to 7250 ....	7000	7000

TABLE 1 OF § 1066.805—EQUIVALENT TEST WEIGHTS (POUNDS)—Continued

Test weight	Equivalent test	Inertia weight
7251 to 7750 ....	7500	7500
7751 to 8250 ....	8000	8000
8251 to 8750 ....	8500	8500
8751 to 9250 ....	9000	9000
9251 to 9750 ....	9500	9500
9751 to 10250 ..	10000	10000
10251 to 10750	10500	10500
10751 to 11250	11000	11000
11251 to 11750	11500	11500
11751 to 12250	12000	12000
12251 to 12750	12500	12500
12751 to 13250	13000	13000
13251 to 13750	13500	13500
13751 to 14000	14000	14000

(b) The test weight basis for non-MDPV heavy-duty vehicles is “adjusted loaded vehicle weight”. For all other vehicles, the test weight basis for establishing equivalent test weight is “loaded vehicle weight”. These load terms are defined in 40 CFR 86.1803.

(c) For FTP, SFTP, New York City Cycle, HFET, and LA-92 testing, determine road-load forces for each test vehicle at speeds between 9.3 and 71.5 miles per hour. The road-load force must represent vehicle operation on a smooth, level road with no wind or calm winds, no precipitation, an ambient temperature of approximately 20 °C, and atmospheric pressure of 98.21 kPa. You may extrapolate road-load force for speeds below 9.3 mph.

#### § 1066.810 Vehicle preparation.

(a) Include additional fittings and adapters as required to accommodate a fuel drain at the lowest point possible in the tank(s) as installed on the vehicle.

(b) For preconditioning that involves loading an evaporative emission canister with butane, provide valving or other means to allow for purging and loading the canister.

(c) For vehicles to be tested for running loss emissions (40 CFR 86.134), prepare the fuel tank for measuring temperature and pressure as specified in 40 CFR 86.107–98(e) and (f) and 40 CFR 86.134. Vapor temperature measurement is optional during the running loss test.

(d) For vehicles to be tested for running loss emissions, prepare the exhaust system by sealing or plugging all detectable sources of exhaust gas leaks. Inspect or test the exhaust system to ensure that there are no leaks that would cause exhaust hydrocarbon emissions to be detected as running losses.

(e) The following provisions apply for preconditioning steps to reduce nonfuel emissions to normal vehicle background levels for vehicles subject to Tier 3

evaporative emission standards under 40 CFR 86.1813:

(1) You must notify us in advance if you plan to perform such preconditioning. This notice must include a detailed description of the intended procedures and any measurements or thresholds for determining when stabilization is complete. You need not repeat this notification for additional vehicle testing in the same or later model years as long as your preconditioning practice conforms to these procedures.

(2) You may precondition a vehicle as described in paragraph (e)(1) of this section only within 12 months after the vehicle’s original date of manufacture, except that you may ask us to approve further preconditioning steps for any testing to address identifiable sources of nonfuel emissions beyond what would generally occur with an appropriately aged in-use vehicle. For example, you may clean up fluid leaks and you may perform further off-vehicle preconditioning for tires or other replacement parts that are less than 12 months old. You may also replace the spare tire with an aged spare tire, and you may replace the windshield washer fluid with water.

#### § 1066.815 Exhaust emission test procedures for FTP testing.

(a) *General.* The FTP exhaust emission test sequence consists of a cold-start test and a hot-start test as described in § 1066.801.

(b) *PM sampling options.* Collect PM using any of the procedures specified in paragraphs (b)(1) through (5) of this section and use the corresponding equation in § 1066.820 to calculate FTP composite emissions. Testing must meet the requirements related to filter face velocity as described in 40 CFR 1065.170(c)(1)(vi), except as specified in paragraphs (b)(4) and (5) of this section. For procedures involving flow weighting, set the filter face velocity to a weighting target of 1.0 to meet the requirements of 40 CFR 1065.170(c)(1)(vi). Allow filter face velocity to decrease as a percentage of the weighting factor if the weighting factor is less than 1.0. Use the appropriate equations in § 1066.610 to show that you meet the dilution factor requirements of § 1066.110(b)(2)(iii)(B).

(1) You may collect a separate PM sample for transient and stabilized portions of the cold-start UDDS and the hot-start UDDS. This may either be done by sampling with three bags or four bags. You may omit the stabilized portion of the hot-start test (bag 4) and use the stabilized portion of the cold-start test (bag 2) in its place.

(2) You may collect PM on one filter over the cold-start UDDS and on a separate filter over the hot-start UDDS.

(3) You may collect PM on one filter over the cold-start UDDS (bag 1 and bag 2) and on a separate filter over the 867 seconds of the stabilized portion of the cold-start UDDS and the first 505 seconds of the hot-start UDDS (bag 2 and bag 3). Note that this option involves duplicate measurements during the stabilized portion of the cold-start UDDS.

(4) You may collect PM on a single filter over the cold-start UDDS and the first 505 seconds of the hot-start UDDS. If you use this method, adjust your sampling system flow rate to weight the filter face velocity over the three intervals of the FTP based on weighting targets of 0.43 for bag 1, 1.0 for bag 2, and 0.57 for bag 3.

(5) You may collect PM on a single filter over the cold-start UDDS and the full hot-start UDDS. If you use this method, adjust your sampling system flow rate to weight the filter face velocity based on weighting targets of 0.75 for the cold-start UDDS and 1.0 for the hot-start UDDS.

(c) *Gaseous sampling options.* Collect gaseous samples using any of the following procedures:

(1) You may collect a single sample for a full UDDS (cold-start or hot-start).

(2) You may sample emissions separately for transient and stabilized portions of any UDDS.

(3) You may omit the stabilized portion of the hot-start test (bag 4) and use the stabilized portion of the cold-start test (bag 2) in its place.

(d) *Test sequence.* Follow the exhaust emission measurement procedures specified in §§ 1066.410 through 1066.425, subject to the following exceptions and additional provisions:

(1) Take the following steps for the cold-start test:

(i) Precondition the vehicle as described in § 1066.816. Initiate the cold-start test following the 12 to 36 hour soak period.

(ii) Start sampling and recording simultaneously with starting the vehicle. Place the vehicle in gear 15 seconds after engine starting, which is 5 seconds before the first acceleration.

(iii) At the end of the deceleration scheduled to occur 505 seconds into the cold-start UDDS, simultaneously switch all the sample flows from the cold-start transient interval to the stabilized interval, stopping all cold-start transient interval sampling and recording, including background sampling. Reset integrating devices for the stabilized interval and indicate the end of the cold-start interval in the recorded data.

Operate the vehicle over the remainder of the UDDS. Turn the engine off 2 seconds after the end of the last deceleration in the stabilized interval (1,369 seconds after the start of the driving schedule).

(iv) Five seconds after the engine stops running, stop all stabilized interval sampling and recording, including background sampling. Stop any integrating devices for the stabilized interval and indicate the end of the stabilized interval in the recorded data. Note that the 5 second delay is intended to account for sampling system transport.

(2) Take the following steps for the hot-start test:

(i) Initiate the hot-start test (9 to 11) minutes after the end of the sample period for the cold-start UDDS.

(ii) Repeat the steps in paragraph (d)(1)(ii) of this section. Operate the vehicle over the first 505 seconds of the UDDS. At the end of the deceleration scheduled to occur 505 seconds into the hot-start UDDS, turn off the engine and simultaneously stop all hot-start sampling and recording, including background sampling, and any integrating devices.

(iii) For tests that do not include bag 4 operation, turn the engine off. To include bag 4 measurement, operate the vehicles over the remainder of the UDDS and conclude the testing as described in paragraphs (d)(1)(iii) and (iv) of this section.

(3) This completes the procedure for measuring FTP exhaust emissions. See § 1066.801 and subpart J of this part for

continuing the test sequence to measure evaporative or refueling emissions.

#### § 1066.816 Vehicle preconditioning for FTP testing.

Precondition the test vehicle before the FTP exhaust measurement as described in 40 CFR 86.132.

#### § 1066.820 Composite calculations for FTP exhaust emissions.

(a) Determine the mass of exhaust emissions of each pollutant for each FTP test interval as described in § 1066.605.

(b) Calculate the final composite gaseous test results as a mass-weighted value,  $e_{[\text{emission}]-\text{FTPcomp}}$ , in grams per mile using the following equation:

$$e_{[\text{emission}]-\text{FTPcomp}} = 0.43 \cdot \left( \frac{m_c}{D_{ct} + D_{cs}} \right) + 0.57 \cdot \left( \frac{m_h}{D_{ht} + D_{hs}} \right)$$

Eq. 1066.820-1

Where:

$m_c$  = the combined mass emissions determined from the cold-start UDDS test interval (generally known as bag 1 and bag 2), in grams.

$D_{ct}$  = the measured driving distance from the transient portion of the cold-start test (bag 1), in miles.

$D_{cs}$  = the measured driving distance from the stabilized portion of the cold-start test (bag 2), in miles.

$m_h$  = the combined mass emissions determined from the hot-start UDDS test interval in grams. This is the hot-stabilized portion from either the first or second UDDS (bag 2, unless you measure bag 4), in addition to the hot transient portion (bag 3).

$D_{ht}$  = the measured driving distance from the transient portion of the hot-start test (bag 3), in miles.

$D_{hs}$  = the measured driving distance from the stabilized portion of the hot-start test

(bag 4), in miles. Set  $D_{hs} = D_{cs}$  for testing where the hot-stabilized portion of the UDDS is not run.

(c) Calculate the final composite PM test results as a mass-weighted value,  $e_{\text{PM-FTPcomp}}$ , in grams per mile as follows:

(1) Use the following equation for PM measured as described in § 1066.815(b)(1), (2), or (3):

$$e_{\text{PM-FTPcomp}} = 0.43 \cdot \left( \frac{m_{\text{PM-cUDDS}}}{D_{ct} + D_{cs}} \right) + 0.57 \cdot \left( \frac{m_{\text{PM-hUDDS}}}{D_{ht} + D_{hs}} \right)$$

Eq. 1066.820-2

Where:

$m_{\text{PM-cUDDS}}$  = the combined PM mass emissions determined from the cold-start UDDS test interval (bag 1 and bag 2), in grams, as calculated using Eq. 1066.605-2.

$m_{\text{PM-hUDDS}}$  = the combined PM mass emissions determined from the hot-start UDDS test interval (bag 3 and bag 4), in grams, as calculated using Eq. 1066.605-2. This is the hot-stabilized portion from either the first or second UDDS (bag 2,

unless you measure bag 4), in addition to the hot transient portion (bag 3).

(2) Use the following equation for PM measured as described in § 1066.815(b)(4):

$$e_{\text{PM-FTPcomp}} = \frac{m_{\text{PM}}}{(0.43 \cdot D_{ct}) + D_{cs} + (0.57 \cdot D_{ht})}$$

Eq. 1066.820-3

Where:

$m_{\text{PM}}$  = the combined PM mass emissions determined from the cold-start UDDS test

interval and the first 505 seconds of the hot-start UDDS test interval (bag 1, bag 2, and bag

3), in grams, as calculated using Eq. 1066.605–3.

(3) Use the following equation for PM measured as described in § 1066.815(b)(5):

$$e_{\text{PM-FTPcomp}} = \frac{m_{\text{PM}}}{0.43 \cdot (D_{\text{ct}} + D_{\text{cs}}) + 0.57 \cdot (D_{\text{ht}} + D_{\text{hs}})}$$

### Eq. 1066.820-4

Where:

$m_{\text{PM}}$  = the combined PM mass emissions determined from the cold-start UDDS test interval and the hot-start UDDS test interval (bag 1, bag 2, bag 3, and bag 4), in grams, as calculated using Eq. 1066.605–4.

#### § 1066.830 Supplemental Federal Test Procedures; overview.

Sections 1066.831 and 1066.835 describe the detailed procedures for the Supplemental Federal Test Procedure (SFTP). This testing applies for all vehicles subject to the SFTP standards in 40 CFR part 86, subpart S. The SFTP test procedure consists of FTP testing and two additional test elements—a sequence of vehicle operation with more aggressive driving and a sequence of vehicle operation that accounts for the impact of the vehicle's air conditioner.

(a) The SFTP standard applies as a composite representing the three test elements. The emission results from the aggressive driving test element (§ 1066.831), the air conditioning test element (§ 1066.835), and the FTP test element (§ 1066.820) are analyzed according to the calculation methodology and compared to the applicable SFTP emission standards as described in 40 CFR part 86, subpart S.

(b) The test elements of the SFTP may be run in any sequence that includes the specified preconditioning steps.

#### § 1066.831 Exhaust emission test procedures for aggressive driving.

(a) This section describes how to test using the US06 or LA–92 driving schedule. The US06 driving schedule can be divided into two test intervals—the US06 City cycle comprises the combined portions of the cycle from 1 to 130 seconds and from 495 to 596 seconds, and the US06 Highway cycle comprises the portion of the cycle between 130 and 495 seconds. See § 1066.801 for further information on the driving schedules.

(b) Take the following steps to precondition vehicles for testing under this section:

(1) Drain and refill the vehicle's fuel tank(s) in any of the following cases:

(i) For aggressive-driving tests that do not follow FTP or HFET testing.

(ii) For a test element that starts more than 72 hours after the most recent FTP or HFET measurement (with or without evaporative emission measurements).

(iii) For testing in which the test vehicle has not remained in an area where ambient temperatures were within the range specified for testing since the previous FTP or HFET.

(2) Keep ambient temperatures within the ranges specified for test measurements throughout the preconditioning sequence.

(3) Warm up the vehicle to a stabilized condition as follows:

(i) Push or drive the vehicle onto the dynamometer.

(ii) Operate the vehicle one time over one of the driving schedules specified in this paragraph (b)(3)(ii). You may ask us to use a particular preconditioning driving schedule if that is related to fuel effects on adaptive memory systems. For our testing, we will generally operate the vehicle over the same preconditioning cycle that will be used for testing in this section. You may exercise your sampling equipment, but you may not determine emissions results during preconditioning. Choose from the following driving schedules:

(A) The first 505 seconds of the UDDS (bag 1).

(B) The last 867 seconds of the UDDS (bag 2).

(C) The HFET driving schedule.

(D) US06 driving schedule or, for heavy-duty vehicles above 10,000 pounds GVWR with a power-to-weight ratio at or below 0.024 hp/lbm, just the highway portion of the US06 driving schedule.

(E) The SC03 driving schedule.

(F) The LA–92 driving schedule.

(4) Allow the vehicle to idle for (1 to 2) minutes. This leads directly into the test measurements described in paragraph (c) of this section.

(c) For testing involving the full US06 driving schedule, you may collect emissions from separate city and highway test intervals (see 40 CFR part 600), or you may collect emissions over the full US06 driving schedule as a single test interval. Take the following steps to measure emissions over separate city and highway test intervals:

(1) At 130 seconds, simultaneously stop all US06 City, and start all US06 Highway sampling, recording, and integrating (including background sampling). At 136 seconds (before the acceleration), record the measured dynamometer roll revolutions.

(2) At 495 seconds, simultaneously stop all US06 Highway, and start all US06 City sampling, recording, and integrating (including background sampling). At 500 seconds (before the acceleration), record the measured dynamometer roll revolutions.

(3) Except as specified in paragraph (c)(4) of this section, treat the emissions from the first and second portions of the US06 City test interval as a single sample.

(4) If you collect gaseous emissions over separate city and highway test intervals, you may still collect PM over the full US06 driving schedule as a single test interval. If you do this, calculate a composite dilution factor based on city and highway emissions using Eq. 1066.610–4 to show that you meet the dilution factor requirements of § 1066.110(b)(2)(iii)(B).

(d) For diesel-fueled vehicles, measure THC emissions on a continuous basis as described in 40 CFR part 1065. For separate measurement of the city and highway test intervals as described in paragraph (c) of this section, perform separate calculations for each portion of the test cycle.

(e) Follow the exhaust emission measurement procedures specified in §§ 1066.410 through 1066.425, subject to the following exceptions and additional provisions:

(1) Following the preconditioning specified in paragraph (b) of this section, place the vehicle in gear and simultaneously start sampling and recording. Begin the first acceleration 5 seconds after placing the vehicle in gear.

(2) Operate the vehicle over the full US06 driving schedule, except as follows:

(i) For heavy-duty vehicles above 10,000 pounds GVWR, operate the vehicle over the LA–92 driving schedule.

(ii) Heavy-duty vehicles at or below 10,000 pounds GVWR with a power-to-



weight ratio at or below 0.024 hp/lbm may be certified using only the highway portion of the US06 driving schedule as described in 40 CFR 86.1816.

(iii) All heavy-duty vehicles shall be tested at their adjusted loaded vehicle weight as described in 40 CFR 86.1816.

(3) Turn the engine off 2 seconds after the end of the last deceleration. Five seconds after the engine stops running, stop all sampling and recording, including background sampling. Stop any integrating devices and indicate the end of the test cycle in the recorded data. Note that the 5 second delay is intended to account for sampling system transport.

(4) Correct calculated NO<sub>x</sub> emissions as described in § 1066.615(a)(1).

#### § 1066.835 Exhaust emission test procedure for SC03 emissions.

This section describes how to test using the SC03 driving schedule (see § 1066.801). This procedure is designed to determine gaseous exhaust emissions while simulating an urban trip on a hot summer day. The provisions of 40 CFR part 86 and 40 CFR part 600 waive SC03 testing for some vehicles; in those cases, calculate SFTP composite emissions by adjusting the weighting calculation as specified in 40 CFR part 86, subpart S.

(a) Drain and refill the vehicle's fuel tank(s) if testing starts more than 72 hours after the last drain and fill operation.

(b) Keep the vehicle in an environment meeting the conditions described in paragraph (f) of this section throughout the preconditioning sequence.

(c) Warm up the vehicle to a stabilized condition as follows:

(1) Push or drive the test vehicle onto the dynamometer.

(2) Close the vehicle's windows before testing.

(3) The test cell and equipment must meet the specifications in paragraph (e) of this section. Measure and control ambient conditions as specified in paragraph (f) of this section.

(4) Set the vehicle's air conditioning controls by selecting A/C mode and "maximum", setting airflow to "recirculate" (if so equipped), selecting the highest fan setting, and turning the A/C temperature to full cold (or 72 °F for automatic systems). Turn the control to the "on" position before testing so the air conditioning system is active whenever the engine is running.

(5) Perform a preconditioning drive by operating the test vehicle one time over the first 505 seconds of the UDDS (bag 1), the last 867 seconds of the UDDS (bag 2), or the SC03 driving schedule. If the air conditioning test sequence starts

more than 2 hours after a different exhaust emission test, you may instead operate the vehicle one time over the full UDDS.

(6) Following the preconditioning drive, turn off the test vehicle and the vehicle cooling fan(s) and allow the vehicle to soak for (9 to 11) minutes.

(d) Follow the exhaust emission measurement procedures specified in §§ 1066.410 through 1066.425, subject to the following exceptions and additional provisions:

(1) Place the vehicle in gear 15 seconds after engine starting, which is 3 seconds before the first acceleration. Follow the SC03 driving schedule.

(2) Turn the engine off 2 seconds after the end of the last deceleration. Five seconds after the engine stops running, stop all sampling and recording, including background sampling. Stop any integrating devices any indicate the end of the test cycle in the recorded data. Note that the 5 second delay is intended to account for sampling system transport.

(3) Correct calculated NO<sub>x</sub> emissions as described in § 1066.615(a)(2).

(e) The following requirements apply for the test cell and cooling fan configuration:

(1) *Minimum test cell size.* The test cell must be at least 20 feet wide, 40 feet long, and 10 feet high, unless we approve the use of a smaller test cell. We will approve this only if you demonstrate that the smaller test cell is capable of meeting all the requirements of this section.

(2) *Vehicle frontal air flow.* Verify that the fan configuration meets the requirements of § 1066.105(c)(3).

(f) Maintain ambient conditions as follows:

(1) *Ambient temperature and humidity.* Measure and record ambient temperature and humidity in the test cell at least once every 30 seconds during the sampling period. Alternatively, if you collect data of at least once every 12 seconds, you may use a moving average of up to 30 second intervals to measure and record ambient temperature and humidity. Control ambient temperature throughout the test sequence to 35.0 ± 3.0 °C. Control ambient temperature during emission sampling to (33.6 to 36.4) °C on average. Control ambient humidity during emission sampling as described in § 1066.420(d).

(2) *Conditions before and after testing.* Use good engineering judgment to demonstrate that you meet the specified instantaneous temperature and humidity tolerances in paragraphs (f)(1) of this section at all times before and between emission measurements.

(3) *Solar heat load.* Simulate solar heating as follows:

(i) You may use a metal halide lamp, a sodium lamp, or a quartz halogen lamp with dichroic mirrors as a radiant energy emitter. We may also approve the use of a different type of radiant energy emitter if you demonstrate that it meets the requirements of this section.

(ii) We recommend achieving radiant heating with spectral distribution characteristics as described in the following table:

TABLE 1 OF § 1066.835—RECOMMENDED SPECTRAL DISTRIBUTION

Band width (nm)	Percent of total spectrum	
	Lower limit (%)	Upper limit (%)
<320 <sup>a</sup> .....	.....	0
320–400 .....	0	7
400–780 .....	45	55
>780 .....	35	53

<sup>a</sup>Note that you may need to filter the UV region between 280 and 320 nm.

(iii) Determine radiant energy intensity experienced by the vehicle as the average value between two measurements along the vehicle's centerline, one at the base of the windshield and the other at the bottom of the rear window (or equivalent location for vehicles without a rear window). This value must be 850 ± 45 W/m<sup>2</sup>. Instruments for measuring radiant energy intensity must meet the following minimum specifications:

(A) Sensitivity of 9 microvolts per W/m<sup>2</sup>.

(B) Response time of 5 seconds. For purposes of this requirement, "response time" means the time for the instrument to reach 95 percent of its equilibrium response after a step change in radiant intensity.

(C) Cosine response error of no more than ±1% for 0–70 degree zenith angles. The cosine response error is the percentage difference between the intensity measured at a given angle and a reference value, where the reference value is the intensity predicted from the zero-degree intensity and the cosine of the incident angle.

(D) When comparing measured values for radiant energy to reference values, each measured value over the full range of measurement may not deviate from the corresponding reference value by more than ±0.5% of the analyzer range's maximum value.

(iv) Check the uniformity of radiant energy intensity at least every 500 hours of emitter usage or every 6 months, whichever is sooner, and after any major modifications affecting the solar

simulation. Determine uniformity by measuring radiant energy intensity as described in paragraph (f)(4)(iii) of this section at each point of a 0.5 m grid over the vehicle's full footprint, including the edges of the footprint, at an elevation 1 m above the floor. Measured values of radiant energy intensity must be between (722 and 978) W/m<sup>2</sup> at all points.

**§ 1066.840 Highway fuel economy test procedure.**

This section describes the procedure for the highway fuel economy test (HFET). This test involves emission sampling and fuel economy measurement for certain vehicles as described in 40 CFR part 86, subpart S, and in 40 CFR part 600. See § 1066.801 for further information on the driving schedules. Follow the exhaust emission measurement procedures specified in §§ 1066.410 through 1066.425, subject to the following exceptions and additional provisions:

(a) Perform the HFET immediately following the FTP when this is practical. If the HFET procedure starts more than 3 hours after an FTP (including evaporative emission measurements, if applicable), operate it over one UDDS to precondition the vehicle. We may approve additional preconditioning in unusual circumstances.

(b) Operate the vehicle over the HFET driving schedule for preconditioning. Allow the vehicle to idle for 15 seconds (with the vehicle in gear), then start a repeat run of the HFET driving schedule and simultaneously start sampling and recording.

(c) Turn the engine off at the end of the HFET driving schedule and stop all sampling and recording, including background. Stop any integrating devices and indicate the end of the test cycle in the recorded data.

**§ 1066.845 AC17 air conditioning efficiency test procedure.**

(a) *Overview.* This section describes a voluntary procedure for measuring the net impact of air conditioner operation on CO<sub>2</sub> emissions. See 40 CFR 86.1868 for provisions describing how to use these procedures to calculate credits and otherwise comply with emission standards.

(b) *Test cell.* Operate the vehicle in a test cell meeting the specifications described in § 1066.835(e). You may add airflow up to a maximum of 4 miles per hour during engine idling and when the engine is off if that is needed to meet ambient temperature or humidity requirements.

(c) *Ambient conditions.* Measure and control ambient conditions as specified in § 1066.835(f), except that you must control ambient temperature during emission sampling to (22.0 to 28.0) °C throughout the test and (23.5 to 26.5) °C on average. These tolerances apply to the combined SC03 and HFET drive cycles during emission sampling. Note that you must set the same ambient temperature target for both the air conditioning on and off portions of emission sampling. Control ambient temperature during the preconditioning cycle and 30 minute soak to 25.0 ± 5.0 °C. For these same modes with no emission sampling, target the specified ambient humidity levels, but you do not need to meet the humidity tolerances. Note that solar heating is disabled for certain test intervals as described in this section.

(d) *Interior air temperature measurement.* Measure and record the vehicle's interior air temperature at least once every 5 seconds during the sampling period. Measure temperature at the outlet of the center-most duct on the dashboard, and approximately 30 mm behind the driver's headrest and passenger's headrest.

(e) *Air conditioning system settings.* For testing that requires the air conditioning to be operating, set the vehicle's air conditioning controls as follows:

(1) For automatic systems, set the temperature control to 72 °F (22 °C).

(2) For manual systems, select A/C mode, set the temperature to full cold and "maximum", set airflow to "recirculate" (if so equipped), and select the highest fan setting. During the first idle period of the SC03 driving schedule (between 186 and 204 seconds), reduce the fan speed setting to nominally 50% of maximum fan speed, set airflow to "fresh air" (if so equipped), and adjust the temperature setting to target a temperature of 55 °F (13 °C) at the dashboard air outlet. Maintain these settings for the remainder of the test.

You may rely on prior temperature measurements to determine the temperature setting; however, if the system is unable to meet the 55 °F (13 °C) target, you may instead set airflow to "fresh air" and temperature to full cold. If the vehicle is equipped with technology that defaults to recirculated air at ambient temperatures above 75 °F (22 °C), that technology should remain enabled throughout the test; this may mean not setting the airflow to "recirculate" at the start and not setting the airflow to "fresh air" during the first idle period of the SC03 driving schedule.

(f) *Test procedure.* Follow the exhaust emission measurement procedures specified in §§ 1066.410 through 1066.425, subject to the following exceptions and additional provisions:

(1) Prepare each test vehicle for a series of tests according to 40 CFR 86.132–00(a) through (g). If the vehicle has been tested within the last 36 hours concluding with a 12 to 36 hour soak, continue to paragraph (f)(2) of this section; otherwise perform an additional UDDS preconditioning cycle that concludes with a 12 to 36 hour soak. You may use a forced cooldown system to bring critical vehicle temperatures to within soak temperature limits. Critical temperatures include transmission oil, engine oil, engine coolant, and cabin air temperatures.

(2) Open the vehicle's windows and operate the vehicle over a preconditioning UDDS with no solar heating and with the air conditioning off. At the end of the preconditioning drive, turn off the test vehicle and all cooling fans.

(3) Turn on solar heating within one minute after turning off the engine. Once the solar energy intensity reaches 805 W/m<sup>2</sup>, let the vehicle soak for 30 ± 1 minutes. You may alternatively rely on prior measurements to start the soak period after a defined period of warming up to the specified solar heat load. Close the vehicle's windows at the start of the soak period; ensure that the windows are adequately closed where instrumentation and wiring pass through to the interior.

(4) Turn the air conditioning control to the "on" position before testing so the air conditioning system is active whenever the engine is running. Place the vehicle in gear 15 seconds after engine starting, which is 3 seconds before the first acceleration. At the end of the driving schedule, simultaneously switch all the sampling, recording, and integrating from SC03 to HFET, including background sampling. Indicate the end of the test cycle in the recorded data. Record the measured dynamometer roll revolutions corresponding to the SC03 driving schedule.

(5) Directly following the SC03 driving schedule, operate the vehicle over the HFET driving schedule. Turn the vehicle off at the end of the driving schedule and simultaneously stop all sampling, recording, and integrating, including background sampling. Indicate the end of the test cycle in the recorded data. Record the measured dynamometer roll revolutions corresponding to the HFET drive schedule. Turn off the solar heating.

(6) Allow the vehicle to remain on the dynamometer for (10 to 15) minutes after emission sampling has concluded. Repeat the testing described in paragraphs (f)(1) through (5) of this section and turn off the vehicle's air conditioner and the solar heating throughout the test run. The windows may be open or closed.

(g) *Calculations.* (1) Determine the mass of CO<sub>2</sub> emissions for each of the two test intervals as described in § 1066.605.

(2) Calculate the composite mass-weighted emissions of CO<sub>2</sub>,  $e_{\text{CO}_2\text{-AC17comp}}$ , representing the average of the SC03 and HFET emissions, in grams per mile using the following equation:

$$a_{\text{error}} = \frac{0.999 - 1}{1} \cdot 100 \%$$

$$a_{\text{error}} = -0.100 \%$$

Where:

$m_{\text{SC03}}$  = mass emissions from the SC03 test interval, in grams.

$D_{\text{SC03}}$  = measured driving distance during the SC03 test interval, in miles.

$m_{\text{HFET}}$  = mass emissions from the HFET test interval, in grams.

$D_{\text{HFET}}$  = measured driving distance during the HFET test interval, in miles.

## Subpart J—Evaporative Emission Test Procedures

### § 1066.901 Applicability and general provisions.

This subpart describes how to measure evaporative and refueling emissions from test vehicles. The provisions of §§ 1066.910 through 1066.930 include general provisions for equipment and calculations related to evaporative and refueling emissions. The provisions of §§ 1066.950 through 1066.985 describe provisions that apply specifically to motor vehicles subject to standards under 40 CFR part 86, subpart S, or 40 CFR part 1037.

Test Equipment and Calculations for Evaporative and Refueling Emissions

### § 1066.910 SHED enclosure specifications.

Enclosures for evaporative and refueling emissions must meet the specifications described in 40 CFR 86.106–96, 86.107–96(a), and 86.107–98(a).

### § 1066.915 Enclosures; auxiliary systems and equipment.

Enclosures for evaporative and refueling emissions must be equipped with fans, blowers, and measurement and data recording equipment as

described in 40 CFR 86.107–98(b) through (h) and (j).

### § 1066.920 Enclosure calibrations.

Enclosures for evaporative and refueling emissions must meet the calibration specifications described in 40 CFR 86.116–94 and 86.117–96.

### § 1066.925 Enclosure calculations for evaporative and refueling emissions.

Calculate emissions for evaporative emissions as described in 40 CFR 86.143–96. Calculate emissions for refueling emissions as described in 40 CFR 86.143–96 and 86.156–98.

### § 1066.930 Equipment for point-source measurement of running losses.

For point-source measurement of running loss emissions, use equipment meeting the specifications in 40 CFR 86.107–96(i)

Evaporative and Refueling Emission Test Procedures for Motor Vehicles

### § 1066.950 Fuel temperature profile.

Develop fuel temperature profiles for running loss testing as described in 40 CFR 86.129–94(d).

### § 1066.955 Diurnal emission test.

Test vehicles for diurnal emissions as described in 40 CFR 86.133–96.

### § 1066.960 Running loss test.

Test vehicles for running loss emissions as described in 40 CFR 86.134–96.

### § 1066.965 Hot soak test.

Test vehicles for hot soak emissions as described in 40 CFR 86.138–96.

### § 1066.970 Refueling test for liquid fuels.

Except as described in § 1066.975, test vehicles for refueling emissions as described in 40 CFR 86.150–98, 86.151–98, 86.152–98, and 86.154–98. Keep records as described in 40 CFR 86.155–98.

### § 1066.971 Vehicle and canister preconditioning for the refueling test.

Precondition vehicles for the refueling emission test as described in 40 CFR 86.153–98.

### § 1066.975 Refueling test for LPG.

For vehicles designed to operate on liquefied petroleum gas, measure refueling emissions as described in 40 CFR 86.157–98.

### § 1066.980 Fuel dispensing spitback procedure.

Test vehicles for spitback emissions as described in 40 CFR 86.146–96.

### § 1066.985 Fuel storage system leak test procedure.

(a) *Scope.* Perform this test as required in the standard-setting part to verify that there are no significant leaks in your fuel storage system.

(b) *Measurement principles.* Leaks are detected by measuring pressure, temperature, and flow to calculate an equivalent orifice diameter for the system. Use good engineering judgment to develop and implement leak test equipment. You may not tighten fittings or connections in the vehicle's fuel system to prepare the vehicle for testing.

(c) *Measurement equipment.* Your leak test equipment must meet the following requirements:

(1) Pressure, temperature, and flow sensors must be calibrated with NIST-traceable standards.

(2) Correct flow measurements to standard reference conditions.

(3) Leak test equipment must have the ability to pressurize fuel storage systems to at least 4.1 kPa and have an internal leak rate of less than 0.20 standard liters per minute.

(4) You must be able to attach the test equipment to the vehicle without permanent alteration of the fuel storage or evaporative emission control systems. For any testing that involves pressurizing the fuel system and detecting leaks at access points away from the fuel fill pipe, the gas cap must be installed in the production configuration. For the test point at or near the fuel fill pipe, attaching the test equipment may involve adding an extension to the fuel fill pipe that incorporates the access point to the fuel system. If the extension apparatus has a fixed cap, the vehicle's gas cap must be tested separately as described in paragraph (d)(9) of this section. This separate testing is not required if the extension apparatus incorporates the vehicle's gas cap.

(5) The point of attachment to the fuel storage system must allow pressurization to test system integrity of the fuel tank and of fuel lines and vapor lines reaching up to and including the gas cap and the evaporative canister. The evaporative system test port available on some vehicles is an example of an effective attachment point.

(d) *Leak test procedure.* Test a vehicle's fuel storage system for leaks as follows:

(1) Refuel vehicle to 40% of its nominal fuel tank capacity.

(2) Soak the vehicle for 6 to 24 hours at a temperature between (20 and 30) °C; record this setpoint temperature and maintain temperatures throughout the

leak test at this setpoint temperature within a tolerance  $\pm 2$  °C.

(3) Before performing the test, purge the fuel storage system of any residual pressure, bringing the system into equilibrium with ambient pressure.

(4) Seal the evaporative canister's vent to atmosphere and ensure that the vehicle's purge valve is closed.

(5) Attach the leak test equipment to the vehicle.

(6) Pressurize the fuel storage system with N<sub>2</sub> or another inert gas to at least 2.4 kPa. Use good engineering judgment to avoid overpressurizing the system.

(7) Maintain gas flow through the system for at least 180 seconds, ensuring

that the flow reading is stable for an effective leak diameter of  $\pm 0.002$  inches.

(8) Use the following equation, or a different equation you develop based on good engineering judgment, to calculate the effective leak diameter,  $d_{\text{eff}}$ :

$$d_{\text{eff}} = 7.844 \cdot \left( \frac{V_{\text{gas}}}{\sqrt{(p_{\text{in}} - p_{\text{atmos}}) \cdot (p_{\text{in}} + p_{\text{atmos}})} \cdot SG_{\text{N}_2} \cdot T} \right)^{0.5057}$$

Where:

$d_{\text{eff}}$  = effective leak diameter, in inches, expressed to at least two decimal places.

$V_{\text{gas}}$  = volumetric flow of gas, in m<sup>3</sup>/s.

$p_{\text{in}}$  = inlet pressure to orifice, in kPa.

$p_{\text{atmos}}$  = atmospheric pressure, in kPa.

$SG_{\text{N}_2}$  = specific gravity of N<sub>2</sub> relative to air at 101.325 kPa and 15.5 °C = 0.967.

$T$  = temperature of flowing medium, in K.

(9) Repeat the test described in this paragraph (c) for each access point described in the application for certification. Use each test result (without averaging) to determine whether the vehicle passes the leak standard.

(10) Gas caps may need to be tested separately for leaks as described in paragraph (c)(4) of this section. Test the gas caps using commercially available flow equipment such as that used for inspection-and-maintenance programs for motor vehicles to determine a leak rate in cubic centimeters per minute resulting from a sustained tank pressure of 7.5 kPa. Correct the leak rate to standard reference conditions, based on the measured leak rate corresponding to atmospheric pressure. The corrected leak value may not exceed 60 cubic centimeters per minute.

(11) You may use special or alternative test procedures as described in 40 CFR 1065.10(c).

(e) *Equipment calibration.* Use good engineering judgment to calibrate the leak check device.

## Subpart K—Definitions and Other Reference Material

### § 1066.1001 Definitions.

The definitions in this section apply to this part. The definitions apply to all subparts unless we note otherwise. Other terms have the meaning given in 40 CFR part 1065. The definitions follow:

*Average* means the arithmetic mean of a sample.

*Bag 1* means relating to the first 505 seconds of the FTP cold-start test interval.

Note that the term bag 1 may also apply to measurement of constituents that are not collected in a bag, such as PM and continuously measured THC.

*Bag 2* means relating to the last 867 seconds of the FTP cold-start test interval.

*Bag 3* means relating to the first 505 seconds of the FTP hot-start test interval.

*Bag 4* means relating to the last 867 seconds of the FTP hot-start test interval, if run. Note that bag 2 is generally used in place of bag 4.

*Base inertia* means a value expressed in mass units to represent the rotational inertia of the rotating dynamometer components between the vehicle driving tires and the dynamometer torque-measuring device, as specified in § 1066.250.

*C<sub>1</sub>-equivalent* means a convention of expressing HC concentrations based on the total number of carbon atoms present, such that the C<sub>1</sub>-equivalent of an HC concentration equals the concentration multiplied by the mean number of carbon atoms in each HC molecule. For example, the C<sub>1</sub>-equivalent of 10 ppm of propane (C<sub>3</sub>H<sub>8</sub>) is 30 ppm. C<sub>1</sub>-equivalent concentration values may be denoted as "ppmC" in the standard-setting part. Densities may also be expressed on a C<sub>1</sub> basis. Note that calculating HC masses from concentrations and densities is only valid where they are each expressed on the same carbon basis.

*Driving schedule* means a series of vehicle speeds that a vehicle must follow during a test. Driving schedules are specified in the standard-setting

part. A driving schedule may consist of multiple test intervals.

*Duty cycle* means a set of weighting factors and the corresponding test cycles, where the weighting factors are used to combine the results of multiple test intervals into a composite result.

*FTP* means one of the following:

(1) The test cycle consisting of one UDDS as specified in paragraph (a) of Appendix I of 40 CFR part 86, followed by a 10-minute soak with the engine off and repeat driving through the first 505 seconds of the UDDS. See § 1066.801(c)(1).

(2) The entire test procedure for measuring exhaust and/or evaporative emissions as described in § 1066.801(c).

*Footprint* has the meaning given in the standard-setting part.

*HFET* means the test cycle specified in Appendix I of 40 CFR part 600.

*LA-92* means the test cycle specified in Appendix I, paragraph (c), of 40 CFR part 86.

*Nonmethane organic gas (NMOG)* means the combination of organic gases other than methane as calculated in § 1066.635. Note that for this part, the organic gases are summed on a mass basis without any adjustment for photochemical reactivity.

*Parts-per-million (ppm)* means ppm on a molar basis. For hydrocarbon concentrations including HC, THC, NMHC, and NMOG, ppm means ppm on a C<sub>1</sub>-equivalent molar basis.

*Road-load coefficients* means sets of A, B, and C road-load force coefficients that are used in the dynamometer road-load simulation, where road-load force at speed  $v$  equals  $A + B \cdot v + C \cdot v^2$ .

*SC03* means the test cycle specified in Appendix I, paragraph (h), of 40 CFR part 86.

*SFTP* means the collection of test cycles as given in 1066.801(c)(2).

*Standard reference conditions* means the following:

(1) *Standard pressure* is 101.325 kPa.  
 (2) *Standard temperature* is 293.15 K.

*Test interval* means a period over which a vehicle's emission rates are determined separately. For many standards, compliance with the standard is based on a weighted average of the mass emissions from multiple test intervals. For example, the standard-setting part may specify a complete duty cycle as a cold-start test interval and a hot-start test interval. In cases where multiple test intervals occur over a duty cycle, the standard-setting part may specify additional calculations that weight and combine results to arrive at

composite values for comparison against the applicable standards.

*Test weight* has the meaning given in §§ 1066.410(b) or 1066.805.

*UDDS* means the test cycle specified in Appendix I, paragraph (a), of 40 CFR part 86.

*US06* means the test cycle specified in Appendix I, paragraph (g), of 40 CFR part 86.

*Unloaded coastdown* means a dynamometer coastdown run with the vehicle wheels removed from the roll surface.

*We (us, our)* means the Administrator of the Environmental Protection Agency and any authorized representatives.

**§ 1066.1005 Symbols, abbreviations, acronyms, and units of measure.**

The procedures in this part generally follow either the International System of Units (SI) or the United States customary units, as detailed in NIST Special Publication 811, which we incorporate by reference in § 1066.1010. See 40 CFR 1065.20 for specific provisions related to these conventions. This section summarizes the way we use symbols, units of measure, and other abbreviations.

(a) *Symbols for quantities.* This part uses the following symbols and units of measure for various quantities:

Symbol	Quantity	Unit	Unit symbol	Unit in terms of SI base units
$\alpha$ .....	atomic hydrogen to carbon ratio .....	mole per mole .....	mol/mol .....	1
$A$ .....	area .....	square meter .....	m <sup>2</sup> .....	m <sup>2</sup>
$A$ .....	vehicle frictional load .....	pound force or newton .....	lbf or N .....	kg·s <sup>-2</sup>
$A_m$ .....	calculated vehicle frictional load .....	pound force or newton .....	lbf or N .....	kg·s <sup>-2</sup>
$a_0$ .....	intercept of least squares regression.			
$a_1$ .....	slope of least squares regression.			
$a$ .....	acceleration .....	feet per second squared or meters per second squared.	ft/s <sup>2</sup> or m/s <sup>2</sup> .....	m·s <sup>-2</sup>
$B$ .....	vehicle load from drag and rolling resistance.	pound force per mile per hour or newton second per meter.	lbf/mph or N·s/m .....	kg·s <sup>-1</sup> ·m <sup>-1</sup>
$\beta$ .....	ratio of diameters .....	meter per meter .....	m/m .....	1
$\beta$ .....	atomic oxygen to carbon ratio .....	mole per mole .....	mol/mol .....	1
$c$ .....	conversion factor.			
$C$ .....	vehicle-specific aerodynamic effects ...	pound force per mile per hour squared or newton second squared per meter squared.	lbf/mph <sup>2</sup> or N·s <sup>2</sup> /m <sup>2</sup> ...	kg·m <sup>-2</sup>
$C_{\#}$ .....	number of carbon atoms in a molecule	$C_{\#}$ .....	number of carbon atoms in a molecule.	$C_{\#}$
$C_d$ .....	discharge coefficient.			
$C_D A$ .....	drag area .....	meter squared .....	m <sup>2</sup> .....	m <sup>2</sup>
$C_f$ .....	flow coefficient.			
$C_p$ .....	heat capacity at constant pressure .....	joule per kelvin .....	J/K .....	J·K <sup>-1</sup>
$C_v$ .....	heat capacity at constant volume .....	joule per kelvin .....	J/K .....	J·K <sup>-1</sup>
$d$ .....	diameter .....	meters .....	m .....	m
$D$ .....	distance .....	miles or meters .....	mi or m .....	m
$D$ .....	slope correlation .....	pound force per mile per hour squared or newton second squared per meter squared.	lbf/mph <sup>2</sup> or N·s <sup>2</sup> /m <sup>2</sup> ...	kg·m <sup>-2</sup>
$DF$ .....	dilution factor .....			1
$e$ .....	mass weighted emission result .....	grams/mile .....	g/mi.	
$F$ .....	force .....	pound force or newton .....	lbf or N .....	kg·s <sup>-2</sup>
$f$ .....	frequency .....	hertz .....	Hz .....	s <sup>-1</sup>
$f_n$ .....	angular speed (shaft) .....	revolutions per minute .....	r/min .....	2· $\pi$ ·60 <sup>-1</sup> ·m·m <sup>-1</sup> ·s <sup>-1</sup>
$FC$ .....	friction compensation error .....	horsepower or watt .....	W .....	kg·m <sup>2</sup> ·s <sup>-3</sup>
$FR$ .....	Road-load force .....	pound force or newton .....	lbf or N .....	kg·s <sup>-2</sup>
$g$ .....	gravitational acceleration .....	meters per second squared .....	m/s <sup>2</sup> .....	m·s <sup>-2</sup>
$\gamma$ .....	ratio of specific heats .....	(joule per kilogram kelvin) per (joule per kilogram kelvin).	(J/(kg·K))/(J/(kg·K)) ....	1
$H$ .....	ambient humidity .....	grams water vapor per kilogram dry air	g H <sub>2</sub> O vapor/kg dry air.	g H <sub>2</sub> O vapor/kg dry air
$\Delta h$ .....	change in height .....	meters .....	m .....	m
$I$ .....	inertia .....	pound mass or kilogram .....	lbm or kg .....	kg
$I$ .....	current .....	ampere .....	A .....	A
$i$ .....	indexing variable.			
$IR$ .....	inertia work rating.			
$K$ .....	correction factor .....			1
$K_v$ .....	calibration coefficient .....		m <sup>4</sup> ·s·K <sup>0.5</sup> /kg .....	m <sup>4</sup> ·s·K <sup>0.5</sup> ·kg <sup>-1</sup>
$\mu$ .....	viscosity, dynamic .....	pascal second .....	Pa·s .....	m <sup>-1</sup> ·kg·s <sup>-1</sup>
$M$ .....	molar mass .....	gram per mole .....	g/mol .....	10 <sup>-3</sup> ·kg·mol <sup>-1</sup>
$M_e$ .....	effective mass .....	kilogram .....	kg .....	kg
$m$ .....	mass .....	pound mass or kilogram .....	lbm or kg .....	kg
$N$ .....	total number in series.			
$n$ .....	total number of pulses in a series.			
$p$ .....	pressure .....	pascal .....	Pa .....	m <sup>-1</sup> ·kg·s <sup>-2</sup>

Symbol	Quantity	Unit	Unit symbol	Unit in terms of SI base units
$\Delta p$ .....	differential static pressure .....	pascal .....	Pa .....	$m^{-1}.kg.s^{-2}$
$p_a$ .....	saturated vapor pressure at ambient dry bulb temperature.	kilopascal .....	kPa .....	$m^{-1}.kg.s^{-2}$
$PF$ .....	penetration fraction.			
$Q$ .....	flow .....	cubic feet or cubic meter .....	ft <sup>3</sup> or m <sup>3</sup> .....	m <sup>3</sup>
$\dot{Q}$ .....	flow rate .....	cubic feet per minute or cubic meter per second.	ft <sup>3</sup> /min or m <sup>3</sup> /s .....	m <sup>3</sup> /s
$\rho$ .....	mass density .....	kilogram per cubic meter .....	kg/m <sup>3</sup> .....	kg.m <sup>-3</sup>
$R$ .....	dynamometer roll revolutions .....	revolutions per minute .....	rpm .....	$2.\pi.60^{-1}.m.m^{-1}.s^{-1}$
$r$ .....	ratio of pressures .....	pascal per pascal .....	Pa/Pa .....	1
$r^2$ .....	coefficient of determination.			
$Re^\#$ .....	Reynolds number.			
$RF$ .....	response factor.			
$RH$ .....	relative humidity.			
$S$ .....	Sutherland constant .....	kelvin .....	K .....	K
$SEE$ .....	standard estimate of error.			
$SG$ .....	specific gravity.			
$\Delta s$ .....	distance traveled during measurement interval.	meters .....	m .....	m
$T$ .....	absolute temperature .....	kelvin .....	K .....	K
$T$ .....	Celsius temperature .....	degree Celsius .....	°C .....	K - 273.15
$T$ .....	torque (moment of force) .....	newton meter .....	N.m .....	$m^2.kg.s^{-2}$
$t$ .....	time .....	second .....	s .....	s
$\Delta t$ .....	time interval, period, 1/frequency .....	second .....	s .....	s
$U$ .....	voltage .....	volt .....	V .....	$m^2.kg.s^{-3}.A^{-1}$
$v$ .....	speed .....	miles per hour or meters per second ..	mph or m/s .....	$m.s^{-1}$
$V$ .....	volume .....	cubic meter .....	m <sup>3</sup> .....	m <sup>3</sup>
$VP$ .....	volume percent.			
$x$ .....	concentration of emission over a test interval.	part per million .....	ppm.	
$y$ .....	generic variable.			
$Z$ .....	compressibility factor .....	Z .....	compressibility factor	Z

(b) *Symbols for chemical species.* This part uses the following symbols for chemical species and exhaust constituents:

Symbol	Species
CH <sub>4</sub> .....	methane.
CH <sub>3</sub> OH ...	methanol.
CH <sub>2</sub> O ....	formaldehyde.
C <sub>2</sub> H <sub>4</sub> O ....	acetaldehyde.
C <sub>2</sub> H <sub>5</sub> OH ..	ethanol.
C <sub>2</sub> H <sub>6</sub> .....	ethane.
C <sub>3</sub> H <sub>7</sub> OH ..	propanol.
C <sub>3</sub> H <sub>8</sub> .....	propane.
C <sub>4</sub> H <sub>10</sub> ....	butane.
C <sub>5</sub> H <sub>12</sub> ....	pentane.
CO .....	carbon monoxide.
CO <sub>2</sub> .....	carbon dioxide.
H <sub>2</sub> O .....	water.
HC .....	hydrocarbon.
N <sub>2</sub> .....	molecular nitrogen.
NMHC ....	nonmethane hydrocarbon.
NMHCe ..	nonmethane hydrocarbon equivalent.
NMOG ....	nonmethane organic gas.
NO .....	nitric oxide.
NO <sub>2</sub> .....	nitrogen dioxide.
NO <sub>x</sub> .....	oxides of nitrogen.
N <sub>2</sub> O .....	nitrous oxide.
O <sub>2</sub> .....	molecular oxygen.
OHC .....	oxygenated hydrocarbon.
PM .....	particulate matter.
THC .....	total hydrocarbon.
THCE ....	total hydrocarbon equivalent.

(c) *Superscripts.* This part uses the following superscripts to define a quantity:

Superscript	Quantity
overbar (such as $\bar{y}$ ) ...	arithmetic mean.
overdot (such as $\dot{y}$ ) ...	quantity per unit time.

(d) *Subscripts.* This part uses the following subscripts to define a quantity:

Subscript	Quantity
0 .....	reference.
abs .....	absolute quantity.
AC17 .....	air conditioning 2017 test interval.
act .....	actual or measured condition.
actint .....	actual or measured condition over the speed interval.
adj .....	adjusted.
air .....	air, dry.
atmos .....	atmospheric.
b .....	base.
bkgnd .....	background.
c .....	cold.
comp .....	composite.
cor .....	corrected.
cs .....	cold stabilized.
ct .....	cold transient.
cUDDS ...	cold-start UDDS.
D .....	driven.
dew .....	dewpoint.
dexh .....	dilute exhaust quantity.
dil .....	dilute.
e .....	effective.

Subscript	Quantity
emission .....	emission specie.
error .....	error.
EtOH .....	ethanol.
exh .....	raw exhaust quantity.
exp .....	expected quantity.
fil .....	filter.
final .....	final.
flow .....	flow measurement device type.
gas .....	gaseous.
h .....	hot.
HFET .....	highway fuel economy test.
hs .....	hot stabilized.
ht .....	hot transient.
hUDDS ...	hot-start UDDS.
i .....	an individual of a series.
ID .....	driven inertia.
in .....	inlet.
int .....	intake.
init .....	initial quantity, typically before an emission test.
IT .....	target inertia.
liq .....	liquid.
max .....	the maximum (i.e. peak) value expected at the standard over a test interval; not the maximum of an instrument range.
meas .....	measured quantity.
mix .....	dilute exhaust gas mixture.
out .....	outlet.
PM .....	particulate matter.
record ....	record.
ref .....	reference quantity.
rev .....	revolution.
roll .....	dynamometer roll.
s .....	settling.
s .....	slip.

Subscript	Quantity	CFR .....	Code of Federal Regulations.	MDPV ....	medium-duty passenger vehicle.
s .....	stabilized.	CFV .....	critical-flow venturi.	NIST .....	National Institute for Standards and Technology.
sat .....	saturated condition.	CNG .....	compressed natural gas.	NMC .....	nonmethane cutter.
SC03 .....	air conditioning driving schedule.	CVS .....	constant-volume sampler.	PDP .....	positive-displacement pump.
span .....	span quantity.	EPA .....	Environmental Protection Agency.	PHEV .....	plug-in hybrid electric vehicle.
sda .....	secondary dilution air.	ETW .....	equivalent test weight.	PM .....	particulate matter.
std .....	standard conditions.	EV .....	electric vehicle.	RESS .....	rechargeable energy storage system.
T .....	target.	FID .....	flame-ionization detector.	ppm .....	parts per million.
t .....	throat.	FTP .....	Federal test procedure.	SAE .....	Society of Automotive Engineers.
test .....	test quantity.	GC .....	gas chromatograph.	SC03 .....	air conditioning driving schedule.
uncor .....	uncorrected quantity.	GEM .....	greenhouse gas emissions model.	SEA .....	selective enforcement audit.
w .....	weighted.	GHG .....	greenhouse gas (including CO <sub>2</sub> , N <sub>2</sub> O, and CH <sub>4</sub> ).	SFTP .....	supplemental federal test procedure.
zero .....	zero quantity.	GPS .....	global positioning system.	SI .....	International System of Units.
		GVWR .....	gross vehicle weight rating.	SSV .....	subsonic venturi.
		HEV .....	hybrid electric vehicle, including plug-in hybrid electric vehicles.	UDDS .....	urban dynamometer driving schedule.
		HFET .....	highway fuel economy test.	US06 .....	aggressive driving schedule.
		HLDT .....	heavy light-duty truck.	U.S.C. ....	United States Code.
		HPLC .....	high pressure liquid chromatography.	WWV .....	NIST radio station call sign.
		IBR .....	incorporated by reference.		
		LA-92 .....	Los Angeles 1992 driving schedule.		

(e) *Other acronyms and abbreviations.* This part uses the following additional abbreviations and acronyms:

A/C .....	air conditioning.
AC17 .....	air conditioning 2017 test interval.
ALVW .....	adjusted loaded vehicle weight.
ASME .....	American Society of Mechanical Engineers.

(f) This part uses the following densities of chemical species:

Symbol	Quantity <sup>1 2</sup>	g/m <sup>3</sup>	g/ft <sup>3</sup>
ρ <sub>CH4</sub> .....	density of methane .....	666.905	18.8847
ρ <sub>CH3OH</sub> .....	density of methanol .....	1332.02	37.7185
ρ <sub>C2H5OH</sub> .....	C <sub>1</sub> -equivalent density of ethanol .....	957.559	27.1151
ρ <sub>C2H4O</sub> .....	C <sub>1</sub> -equivalent density of acetaldehyde .....	915.658	25.9285
ρ <sub>C3H8</sub> .....	density of propane .....	611.035	17.3026
ρ <sub>C3H7OH</sub> .....	C <sub>1</sub> -equivalent density of propanol .....	832.74	23.5806
ρ <sub>CO</sub> .....	density of carbon monoxide .....	1164.41	32.9725
ρ <sub>CO2</sub> .....	density of carbon dioxide .....	1829.53	51.8064
ρ <sub>HC-gas</sub> .....	effective density of hydrocarbon—gaseous fuel <sup>3</sup> .....	(see 3)	(see 3)
ρ <sub>CH2O</sub> .....	density of formaldehyde .....	1248.21	35.3455
ρ <sub>HC-liq</sub> .....	effective density of hydrocarbon—liquid fuel <sup>4</sup> .....	576.816	16.3336
ρ <sub>NMHC-gas</sub> .....	effective density of nonmethane hydrocarbon—gaseous fuel <sup>3</sup> .....	(see 3)	(see 3)
ρ <sub>NMHC-liq</sub> .....	effective density of nonmethane hydrocarbon—liquid fuel <sup>4</sup> .....	576.816	16.3336
ρ <sub>NMHCE-gas</sub> .....	effective density of nonmethane equivalent hydrocarbon—gaseous fuel <sup>3</sup> .....	(see 3)	(see 3)
ρ <sub>NMHCE-liq</sub> .....	effective density of nonmethane equivalent hydrocarbon—liquid fuel <sup>4</sup> .....	576.816	16.3336
ρ <sub>NOx</sub> .....	effective density of oxides of nitrogen <sup>5</sup> .....	1912.5	54.156
ρ <sub>N2O</sub> .....	density of nitrous oxide .....	1829.66	51.8103
ρ <sub>THC-liq</sub> .....	effective density of total hydrocarbon—liquid fuel <sup>4</sup> .....	576.816	16.3336
ρ <sub>THCE-liq</sub> .....	effective density of total equivalent hydrocarbon—liquid fuel <sup>4</sup> .....	576.816	16.3336

<sup>1</sup> Densities are given at 20 °C and 101.325 kPa.

<sup>2</sup> Densities for all hydrocarbon containing quantities are given in g/m<sup>3</sup>-carbon atom and g/ft<sup>3</sup>-carbon atom.

<sup>3</sup> The effective density for natural gas fuel and liquefied petroleum gas fuel are defined by an atomic hydrogen-to-carbon ratio, α, of the hydrocarbon components of the test fuel. ρ<sub>HCgas</sub> = 41.57·(12.011 + (α·1.008)).

<sup>4</sup> The effective density for gasoline and diesel fuel are defined by an atomic hydrogen-to-carbon ratio, α, of 1.85.

<sup>5</sup> The effective density of NO<sub>x</sub> is defined by the molar mass of nitrogen dioxide, NO<sub>2</sub>.

(g) *Constants.* (1) This part uses the following constants for the composition of dry air:

Symbol	Quantity	mol/mol
χ <sub>Arair</sub> .....	amount of argon in dry air .....	0.00934
χ <sub>CO2air</sub> .....	amount of carbon dioxide in dry air .....	0.000375
χ <sub>N2air</sub> .....	amount of nitrogen in dry air .....	0.78084
χ <sub>O2air</sub> .....	amount of oxygen in dry air .....	0.209445

(2) This part uses the following molar masses or effective molar masses of chemical species:

Symbol	Quantity	g/mol (10 <sup>-3</sup> ·kg·mol <sup>-1</sup> )
$M_{\text{air}}$ .....	molar mass of dry air <sup>1</sup> .....	28.96559
$M_{\text{H}_2\text{O}}$ .....	molar mass of water .....	18.01528

<sup>1</sup> See paragraph (g)(1) of this section for the composition of dry air.

(3) This part uses the following molar gas constant for ideal gases:

Symbol	Quantity	J/(mol·K) (m <sup>2</sup> ·kg·s <sup>-2</sup> ·mol <sup>-1</sup> ·K <sup>-1</sup> )
$R$ .....	molar gas constant .....	8.314472

(h) *Prefixes.* This part uses the following prefixes to define a quantity:

Symbol	Quantity	Value
$\mu$ .....	micro .....	10 <sup>-6</sup>
$m$ .....	milli .....	10 <sup>-3</sup>
$c$ .....	centi .....	10 <sup>-2</sup>
$k$ .....	kilo .....	10 <sup>3</sup>
$M$ .....	mega .....	10 <sup>6</sup>
$n$ .....	nano .....	10 <sup>-9</sup>

**§ 1066.1010 Incorporation by reference.**

(a) Certain material is incorporated by reference into this part with the approval of the Director of the Federal Register under 5 U.S.C. 552(a) and 1 CFR part 51. To enforce any edition other than that specified in this section, a document must be published in the **Federal Register** and the material must be available to the public. All approved material is available for inspection at U.S. EPA, Air and Radiation Docket and Information Center, 1301 Constitution Ave. NW., Room B102, EPA West Building, Washington, DC 20460, (202) 202-1744, and is available from the sources listed below. It is also available for inspection at the National Archives and Records Administration (NARA). For information on the availability of this material at NARA, call 202-741-6030, or go to <http://www.archives.gov/>

*federal\_register/code\_of\_federal\_regulations/ibr\_locations.html.*

To enforce any edition other than that specified in this section, a document must be published in the **Federal Register** and the material must be available to the public.

(b) *SAE International material.* The following standards are available from SAE International, 400 Commonwealth Dr., Warrendale, PA 15096-0001, (877) 606-7323 (U.S. and Canada) or (724) 776-4970 (outside the U.S. and Canada), or <http://www.sae.org>:

(1) SAE J1263, Road Load Measurement and Dynamometer Simulation Using Coastdown Techniques, revised March 2010, IBR approved for §§ 1066.301(b), 1066.305, and 1066.310(b).

(2) SAE J1634, Battery Electric Vehicle Energy Consumption and Range Test Procedure, revised October 2012, IBR approved for § 1066.501(a).

(3) SAE J1711, Recommended Practice for Measuring the Exhaust Emissions and Fuel Economy of Hybrid-Electric Vehicles, Including Plug-In Hybrid Vehicles, revised June 2010, IBR approved for § 1066.501(a).

(4) SAE J2263, Road Load Measurement Using Onboard Anemometry and Coastdown Techniques, revised December 2008,

IBR approved for §§ 1066.301(b), 1066.305, and 1066.310(b).

(5) SAE J2264, Chassis Dynamometer Simulation of Road Load Using Coastdown Techniques, revised January 2014, IBR approved for § 1066.315.

(6) SAE J2711, Recommended Practice for Measuring Fuel Economy and Emissions of Hybrid-Electric and Conventional Heavy-Duty Vehicles, issued September 2002, IBR approved for § 1066.501(a).

(7) SAE J2951, Drive Quality Evaluation for Chassis Dynamometer Testing, revised January 2014, IBR approved for § 1066.425(j).

(c) National Institute of Standards and Technology material. The following documents are available from National Institute of Standards and Technology, 100 Bureau Drive, Stop 1070, Gaithersburg, MD 20899-1070, (301) 975-6478, or [www.nist.gov](http://www.nist.gov):

(1) NIST Special Publication 811, 2008 Edition, Guide for the Use of the International System of Units (SI), Physics Laboratory, March 2008, IBR approved for §§ 1066.20(a) and 1066.1005.

(2) [Reserved]

[FR Doc. 2014-06954 Filed 4-25-14; 8:45 am]

BILLING CODE 6560-50-P