

ENVIRONMENTAL PROTECTION AGENCY

40 CFR Parts 9, 85, 86, 89, 92, 94, 1033, 1039, 1042, 1065, and 1068

[EPA-HQ-OAR-2003-0190; FRL-8545-3]

RIN 2060-AM06

Control of Emissions of Air Pollution From Locomotive Engines and Marine Compression-Ignition Engines Less Than 30 Liters per Cylinder

AGENCY: Environmental Protection Agency (EPA).

ACTION: Final rule.

SUMMARY: EPA is adopting a comprehensive program to dramatically reduce pollution from locomotives and marine diesel engines. The controls will apply to all types of locomotives, including line-haul, switch, and passenger, and all types of marine diesel engines below 30 liters per cylinder displacement, including commercial and recreational, propulsion and auxiliary. The near-term emission standards for newly-built engines will phase in starting in 2009. The near-term program also includes new emission limits for existing locomotives and marine diesel engines that apply when they are remanufactured, and take effect as soon as certified remanufacture systems are available, as early as 2008. The long-term emissions standards for newly-built locomotives and marine diesel engines are based on the application of high-efficiency catalytic aftertreatment technology. These

standards begin to take effect in 2015 for locomotives and in 2014 for marine diesel engines. We estimate particulate matter (PM) reductions of 90 percent and nitrogen oxides (NO_x) reductions of 80 percent from engines meeting these standards, compared to engines meeting the current standards.

We project that by 2030, this program will reduce annual emissions of NO_x and PM by 800,000 and 27,000 tons, respectively. EPA projects these reductions will annually prevent up to 1,100 PM-related premature deaths, 280 ozone-related premature deaths, 120,000 lost work days, 120,000 school day absences, and 1.1 million minor restricted-activity days. The annual monetized health benefits of this rule in 2030 will range from \$9.2 billion to \$11 billion, assuming a 3 percent discount rate, or between \$8.4 billion to \$10 billion, assuming a 7% discount rate. The estimated annual social cost of the program in 2030 is projected to be \$740 million, significantly less than the estimated benefits.

DATES: This rule is effective on July 7, 2008. The incorporation by reference of certain publications listed in this regulation is approved by the Director of the Federal Register as of July 7, 2008.

ADDRESSES: EPA has established a docket for this action under Docket ID No. EPA-HQ-2003-0190. All documents in the docket are listed on the www.regulations.gov web site. Although listed in the index, some information is not publicly available, e.g., CBI or other information whose disclosure is restricted by statute.

Certain other material, such as copyrighted material, is not placed on the Internet and will be publicly available only in hard copy form. Publicly available docket materials are available either electronically through www.regulations.gov or in hard copy at the Air Docket, EPA/DC, EPA West, Room 3334, 1301 Constitution Ave., NW., Washington, DC. The Public Reading Room is open from 8:30 a.m. to 4:30 p.m., Monday through Friday, excluding legal holidays. The telephone number for the Public Reading Room is (202) 566-1744, and the telephone number for the Air Docket is (202) 566-1742.

FOR FURTHER INFORMATION CONTACT: John Mueller, U.S. EPA, Office of Transportation and Air Quality, Assessment and Standards Division (ASD), Environmental Protection Agency, 2000 Traverwood Drive, Ann Arbor, MI 48105; telephone number: (734) 214-4275; fax number: (734) 214-4816; e-mail address: Mueller.John@epa.gov, or Assessment and Standards Division Hotline; telephone number: (734) 214-4636.

SUPPLEMENTARY INFORMATION:

Does This Action Apply to Me?

- *Locomotives*

Entities potentially affected by this action are those that manufacture, remanufacture or import locomotives or locomotive engines; and those that own or operate locomotives. Regulated categories and entities include:

Category	NAICS code ¹	Examples of potentially affected entities
Industry	333618, 336510	Manufacturers, remanufacturers and importers of locomotives and locomotive engines.
Industry	482110, 482111, 482112	Railroad owners and operators.
Industry	488210	Engine repair and maintenance.

This table is not intended to be exhaustive, but rather provides a guide for readers regarding entities likely to be regulated by this action. This table lists the types of entities that EPA is now aware could potentially be regulated by this action. Other types of entities not listed in the table could also be regulated. To determine whether your company is regulated by this action, you

should carefully examine the applicability criteria in 40 CFR 92.1, 1033.1, 1065.1, and 1068.1. If you have questions, consult the person listed in the preceding **FOR FURTHER INFORMATION CONTACT** section.

- *Marine Engines and Vessels*

Entities potentially affected by this action are companies and persons that

manufacture, sell, or import into the United States new marine compression-ignition engines, companies and persons that rebuild or maintain these engines, companies and persons that make vessels that use such engines, and the owners/operators of such vessels. Affected categories and entities include:

Category	NAICS code ¹	Examples of potentially affected entities
Industry	333618	Manufacturers of new marine diesel engines.
Industry	33661 and 346611	Ship and boat building; ship building and repairing.

¹North American Industry Classification System (NAICS).

Category	NAICS code ¹	Examples of potentially affected entities
Industry	811310	Engine repair, remanufacture, and maintenance.
Industry	483	Water transportation, freight and passenger.
Industry	487210	and Sightseeing Transportation, Water.
Industry	4883	Support Activities for Water Transportation.
Industry	1141	Fishing.
Industry	336612	Boat building (watercraft not built in shipyards and typically of the type suitable or intended for personal use).

This table is not intended to be exhaustive, but rather provides a guide for readers regarding entities likely to be regulated by this action. This table lists the types of entities that EPA is now aware could potentially be regulated by this action. Other types of entities not listed in the table could also be regulated. To determine whether your company is regulated by this action, you should carefully examine the applicability criteria in 40 CFR 94.1, 1042.1, 1065.1, and 1068.1. If you have questions, consult the person listed in the preceding **FOR FURTHER INFORMATION CONTACT** section.

Outline of This Preamble

- I. Overview
 - A. What Is EPA Finalizing and How Does It Differ From the Proposal?
 - B. Why Is EPA Taking This Action?
- II. Air Quality and Health Impacts
 - A. Overview
 - B. Public Health Impacts
 - C. Environmental Impacts
 - D. Other Criteria Pollutants Affected by This Final Rule
 - E. Emissions from Locomotive and Marine Diesel Engines
- III. Emission Standards
 - A. What Locomotives and Marine Engines Are Covered?
 - B. What Standards Are We Adopting?
 - C. Are the Standards Feasible?
- IV. Certification and Compliance Program
 - A. Issues Common to Locomotives and Marine Engines
 - B. Compliance Issues Specific to Locomotives
 - C. Compliance Issues Specific to Marine Engines
- V. Costs and Economic Impacts
 - A. Engineering Costs
 - B. Cost Effectiveness
 - C. EIA
- VI. Benefits
- VII. Alternative Program Options
 - A. Summary of Alternatives
 - B. Summary of Results
- VIII. Public Participation
- IX. Statutory and Executive Order Reviews
 - A. Executive Order 12866: Regulatory Planning and Review
 - B. Paperwork Reduction Act
 - C. Regulatory Flexibility Act
 - D. Unfunded Mandates Reform Act
 - E. Executive Order 13132 (Federalism)
 - F. Executive Order 13175 (Consultation and Coordination With Indian Tribal Governments)
 - G. Executive Order 13045: Protection of Children From Environmental Health and Safety Risks

- H. Executive Order 13211: Actions That Significantly Affect Energy Supply, Distribution, or Use
- I. National Technology Transfer Advancement Act
- J. Executive Order 12898: Federal Actions to Address Environmental Justice in Minority Populations and Low-Income Populations
- K. Congressional Review Act
- X. Statutory Provisions and Legal Authority

I. Overview

This final rule completes an important step in EPA's ongoing National Clean Diesel Campaign (NCDC) by adding new programs for locomotives and marine diesel engines to the clean diesel initiatives we have already undertaken for highway, other nonroad, and stationary diesel engines. As detailed below, it significantly strengthens the locomotive and marine diesel programs we proposed last year (72 FR 15938, April 3, 2007), especially in controlling emissions during the critical early years through the early introduction of advanced technologies and the more complete coverage of existing engines. When fully implemented, this coordinated set of new programs will reduce harmful diesel engine emissions to a small fraction of their previous levels.

The new programs address all types of diesel locomotives—line-haul, switch, and passenger rail, and all types of marine diesel engines below 30 liters per cylinder displacement (hereafter referred to as “marine diesel engines”).² These engines are used to power a wide variety of vessels, from small fishing and recreational boats to large tugs and Great Lakes freighters. They are also used to generate auxiliary vessel power, including on ocean-going ships.

² Marine diesel engines at or above 30 liters per cylinder, called Category 3 engines, are typically used for propulsion power on ocean-going ships. EPA is addressing Category 3 engines through separate actions, including a planned rulemaking for a new tier of federal standards (see Advance Notice of Proposed Rulemaking published December 7, 2007 at 72 FR 69522) and participation on the U.S. delegation to the International Maritime Organization for negotiations of new international standards (see <http://www.epa.gov/otaq/oceanvessels.com> for information on both of those actions), as well as EPA's Clean Ports USA Initiative (see <http://www.epa.gov/cleandiesel/ports/index.htm>).

Emissions of fine particulate matter (PM_{2.5}) and nitrogen oxides (NO_x) from these diesel engines contribute to nonattainment of the National Ambient Air Quality Standards (NAAQS) for PM_{2.5} and ozone. Today, locomotives and marine diesel engines account for about 20 percent of mobile source NO_x emissions and 25 percent of mobile source diesel PM_{2.5} emissions in the U.S. Absent this final action, by 2030 the relative contributions of NO_x and PM_{2.5} from these engines would have grown to 35 and 65 percent, respectively.

We are finalizing a comprehensive three-part program to address this problem. First, we are adopting stringent emission standards for existing locomotives and for existing commercial marine diesel engines above 600 kilowatt (kW) (800 horsepower (hp)). These standards apply when the engines are remanufactured. This part of the program will take effect as soon as certified remanufacture systems are available, for some engines as early as a few months from now. Under our existing program, locomotives have been certified to one of three tiers of standards: Tier 0 for locomotives originally built between 1973 and 2001, Tier 1 for those built between 2002 and 2004, and Tier 2 for those built in or after 2005. Under this new program, certified locomotive remanufacture systems must be made available by 2010 for Tier 0 and Tier 1 locomotives, and by 2013 for Tier 2 locomotives. Remanufacture systems that are certified for use in marine engine remanufactures are likewise required to be used. We are not, however, setting a specific compliance date for certified marine diesel remanufacture systems because we expect that engine manufacturers will be well motivated by the market opportunity to certify emissions-compliant systems.

Second, we are adopting a set of near-term emission standards, referred to as Tier 3, for newly-built locomotives and marine engines. The Tier 3 standards reflect the application of technologies to reduce engine-out particulate matter (PM) and NO_x.

Third, we are adopting longer-term standards, referred to as Tier 4, for newly-built locomotives and marine

engines. Tier 4 standards reflect the application of high-efficiency catalytic aftertreatment technology enabled by the availability of ultra-low sulfur diesel fuel (ULSD). These standards take effect in 2015 for locomotives, and phase in over time for marine engines, beginning in 2014. Finally, we are adopting provisions in all three parts of the

program to eliminate emissions from unnecessary locomotive idling. Locomotives and marine diesel engines designed to these Tier 4 standards will achieve PM reductions of 90 percent and NO_x reductions of 80 percent, compared to engines meeting the current Tier 2 standards. The new standards will also yield sizeable reductions in emissions of nonmethane hydrocarbons (NMHC), carbon

monoxide (CO), and hazardous compounds known as air toxics. Table I-1 summarizes the PM and NO_x emission reductions for the new standards compared to today's (Tier 2) emission standards; for remanufactured engines, the comparison is to the current standards for each tier of locomotives covered, and to typical unregulated levels for marine engines.

TABLE I-1.—REDUCTIONS FROM LEVELS OF EXISTING STANDARDS

Sector	Standards tier	PM (percent)	NO _x (percent)
Locomotives	Remanufactured Tier 0	60	15–20.
	Remanufactured Tier 1	50	
	Remanufactured Tier 2	50	
	Tier 3	50	
	Tier 4	90	
Marine Diesel Engines ^a	All tiers—idle emissions	50	50.
	Remanufactured Engines	25–60	Up to 20.
	Tier 3	50	20.
	Tier 4	90	80.

Note: (a) Standards vary by displacement and within power categories. Reductions indicated are typical.

On a nationwide annual basis, these reductions will amount to 800,000 tons of NO_x and 27,000 tons of PM by 2030, resulting annually in the prevention of up to 1,100 PM-related premature deaths, 280 ozone-related premature deaths, 120,000 lost work days, 120,000 school day absences, and 1.1 million minor restricted-activity days. We estimate the annual monetized health benefits of this rule in 2030 will range from \$9.2 billion to \$11 billion, assuming a 3 percent discount rate, or between \$8.4 billion to \$10 billion, assuming a 7% discount rate.³ The estimated annual social cost of the program in 2030 is projected to be \$740 million, significantly less than the estimated benefits.

A. What Is EPA Finalizing and How Does it Differ From the Proposal?

This final rule makes a number of important changes to the program set out in our Notice of Proposed Rulemaking (NPRM). Among these are changes that will yield significantly greater overall NO_x and PM reductions, especially in the critical early years of the program: The adoption of standards for remanufactured marine engines and a 2-year pull-ahead of the Tier 4 NO_x requirements for line-haul locomotives

and for 2000–3700 kW (2760–4900 hp) marine engines.

The major elements of the final program are summarized below. We are also revising existing testing, certification, and compliance provisions to better ensure emissions control in use. Detailed provisions and our justifications for them are discussed in sections III and IV. Section VII of this preamble describes a number of alternatives that we considered in developing the rule. After evaluating the alternatives, we believe that our new program provides the best opportunity for achieving timely and very substantial emissions reductions from locomotive and marine diesel engines. It balances a number of key factors: (1) Achieving very significant emissions reductions as early as possible, (2) providing appropriate lead time to develop and apply advanced control technologies, and (3) coordinating requirements in this final rule with existing highway and nonroad diesel engine programs. The provisions we are finalizing that are different from the proposed program are:

- The adoption of standards for remanufactured marine diesel engines to address emissions from the existing fleet (this was presented as one of the proposal alternatives),
- Inclusion of Tier 4 NO_x controls on 2015–2016 model year locomotives at initial build rather than at first remanufacture,
- A two-year pull-ahead of the Tier 4 NO_x standard for 2000–3700 kW marine engines to 2014,

- Inclusion of Class II railroads in the remanufactured locomotives program,

- No Tier 4 standards for the small fleet of large recreational vessels at this time,

- A revised approach to migratory vessels that spend part of their time overseas,

- Credit for locomotive design measures that reduce emissions as part of efforts to improve efficiency,

- A number of changes to test and compliance requirements detailed in sections III and IV.

Overall, our comprehensive three-part approach to setting standards for locomotives and marine diesel engines will provide very large reductions in PM, NO_x, and toxic compounds, both in the near-term (as early as 2008), and in the long-term. These reductions will be achieved in a manner that: (1) Leverages technology developments in other diesel sectors, (2) aligns well with the clean diesel fuel requirements already being implemented, and (3) provides the lead time needed to deal with the significant engineering design workload that is involved.

(1) Locomotive Emission Standards

We are setting stringent exhaust emission standards for newly-built and remanufactured locomotives, furthering the initiative for cleaner locomotives started in 2004 with the establishment of the ULSD locomotive fuel program, and adding this important category of engines to the highway and nonroad diesel applications already covered

³ Low and high benefits estimates are derived from a range of ozone-related premature mortality studies (including an assumption of no causality) and PM_{2.5}-related premature mortality based on the ACS study (Pope et al., 2002). Benefits also include PM_{2.5}- and ozone-related morbidity benefits. See section VI for a complete discussion and analysis of benefits associated with the final rule.

under EPA's National Clean Diesel Campaign.

Briefly, for newly-built line-haul locomotives we are setting a new Tier 3 PM standard of 0.10 grams per brake horsepower-hour (g/bhp-hr), based on improvements to existing engine designs. This standard will take effect in 2012. We are also setting new Tier 4 standards of 0.03 g/bhp-hr for PM and 1.3 g/bhp-hr for NO_x, based on the evolution of high-efficiency catalytic aftertreatment technologies now being developed and introduced in the highway diesel sector. The Tier 4 standards will take effect in 2015. We are requiring that remanufactured Tier 2 locomotives meet a PM standard of 0.10 g/bhp-hr, based on the same engine design improvements as Tier 3 locomotives, and that remanufactured Tier 0 and Tier 1 locomotives meet a 0.22 g/bhp-hr PM standard. We are also requiring that remanufactured Tier 0 locomotives meet a NO_x standard of 7.4 g/bhp-hr, the same level as current Tier 1 locomotives, or 8.0 g/bhp-hr if the locomotive is not equipped with a separate loop intake air cooling system. Section III provides a detailed discussion of these new standards, and section IV details improvements being made to the applicable test, certification, and compliance programs.

In setting our original locomotive emission standards in 1998, the historic pattern of transitioning older line-haul locomotives to road- and yard-switcher service resulted in our making little distinction between line-haul and switch locomotives. Because of the increase in the size of new locomotives in recent years, that pattern cannot be sustained by the railroad industry, as today's 4000+ hp (3000+ kW) locomotives are poorly suited for switcher duty. Furthermore, although there is still a fairly sizeable legacy fleet of older smaller line-haul locomotives that could find their way into the switcher fleet, essentially the only newly-built switchers put into service over the last two decades have been of radically different design, employing one to three smaller high-speed diesel engines designed for use in nonroad applications. We are establishing new standards and special certification provisions for newly-built and remanufactured switch locomotives that take these factors into account.

Locomotives spend a substantial amount of time idling, during which they emit harmful pollutants, consume fuel, create noise, and increase maintenance costs. We are requiring that idle controls, such as Automatic Engine Stop/Start Systems (AESS), be included on all newly-built Tier 3 and

Tier 4 locomotives. We also are requiring that they be installed on all existing locomotives that are subject to the new remanufactured engine standards, at the point of first remanufacture under the standards, unless already equipped with idle controls. Additional idle emissions control beyond AESS is encouraged in our program by factoring it into the certification test program.

(2) Marine Engine Emission Standards

We are setting emissions standards for newly-built and remanufactured marine diesel engines with displacements up to 30 liters per cylinder (referred to as Category 1 and 2, or C1 and C2, engines). Newly-built engines subject to the new standards include those used in commercial, recreational, and auxiliary power applications, and those below 37 kW (50 hp) that were previously regulated in our nonroad diesel program.

The new marine diesel engine standards include stringent engine-based Tier 3 standards for newly-built marine diesel engines that phase in beginning in 2009. These are followed by aftertreatment-based Tier 4 standards for engines above 600 kW (800 hp) that phase in beginning in 2014. The specific levels and implementation dates for the Tier 3 and Tier 4 standards vary by engine size and power. This yields an array of emission standards levels and start dates that help ensure the most stringent standards feasible at the earliest possible time for each group of newly-built marine engines, while helping engine and vessel manufacturers implement the program in a manner that minimizes their costs for emission reductions. The new standards and implementation schedules, as well as their technological feasibility, are described in detail in section III of this preamble.

We are also adopting standards to address the considerable impact of emissions from large marine diesel engines installed in vessels in the existing fleet. These standards apply to commercial marine diesel engines above 600 kW when these engines are remanufactured, and take effect as soon as certified remanufacture systems are available. The final requirements are different from the programmatic alternative on which we sought comment in that there is no mandatory date by which marine remanufacture systems must be made available. However, systems for the larger Category 2 marine diesel engines are expected to become available at the same time as the locomotive remanufacture systems for similar

engines, as early as 2008, because Category 2 marine diesel engines are often derived from locomotive engines. This new marine remanufacture program is described in more detail in section III.B(2)(b). We intend to revisit this program in the future to evaluate the extent to which remanufacture systems are being introduced into the market without a mandatory requirement, and to determine if the program should be extended to small commercial and recreational engines as well.

Taken together, the program elements described above constitute a comprehensive program that addresses the problems caused by locomotive and marine diesel emissions from both a near-term and long-term perspective. It does this while providing for an orderly and cost-effective implementation schedule for the railroads, vessel owners, manufacturers, and remanufacturers.

B. Why Is EPA Taking This Action?

(1) Locomotives and Marine Diesels Contribute to Serious Air Pollution Problems

As we discuss extensively in both the proposal and today's action, EPA strongly believes it is appropriate to take steps now to reduce future emissions from locomotive and marine diesel engines. Emissions from these engines generate significant emissions of PM_{2.5} and NO_x that contribute to nonattainment of the National Ambient Air Quality Standards for PM_{2.5} and ozone. NO_x is a key precursor to ozone and secondary PM formation. These engines also emit hazardous air pollutants or air toxics, which are associated with serious adverse health effects. Finally, emissions from locomotive and marine diesel engines cause harm to public welfare, including contributing to visibility impairment and other harmful environmental impacts across the U.S.

The health and environmental effects associated with these emissions are a classic example of a negative externality (an activity that imposes uncompensated costs on others). With a negative externality, an activity's social cost (the cost borne to society imposed as a result of the activity taking place) exceeds its private cost (the cost to those directly engaged in the activity). In this case, as described below and in section II, emissions from locomotives and marine diesel engines and vessels impose public health and environmental costs on society. However, these added costs are not reflected in the costs of those using

these engines and equipment. The current market and regulatory scheme do not correct this externality because firms in the market are rewarded for minimizing their production costs, including the costs of pollution control, and do not benefit from reductions in emissions. In addition, firms that may take steps to use equipment that reduces air pollution may find themselves at a competitive disadvantage compared to firms that do not. The emission standards that EPA is finalizing help address this market failure and reduce the negative externality from these emissions by providing a regulatory incentive for engine and locomotive manufacturers to produce engines and locomotives that emit fewer harmful pollutants and for railroads and vessel builders and owners to use those cleaner engines.

Emissions from locomotive and marine diesel engines account for substantial portions of the country's current ambient PM_{2.5} and NO_x levels. We estimate that today these engines account for about 20 percent of mobile source NO_x emissions and about 25 percent of mobile source diesel PM_{2.5} emissions. Under this rulemaking, by 2030, NO_x emissions from these diesel engines will be reduced annually by 800,000 tons and PM_{2.5} emissions by 27,000 tons, and these reductions will grow beyond 2030 as fleet turnover to the cleanest engines continues.

EPA has already taken steps to bring emissions levels from highway and nonroad diesel vehicles and engines to very low levels over the next decade, while the per horsepower-hour emission levels for locomotive and marine diesel engines remain at much higher levels—comparable to the emissions for highway trucks in the early 1990s.

Both ozone and PM_{2.5} contribute to serious public health problems, including premature mortality, aggravation of respiratory and cardiovascular disease (as indicated by increased hospital admissions and emergency room visits, school absences, loss work days, and restricted activity days), changes in lung function and increased respiratory symptoms, altered respiratory defense mechanisms, and chronic bronchitis. Diesel exhaust is of special public health concern, and since 2002 EPA has classified exposure to diesel exhaust as likely to be carcinogenic to humans by inhalation from environmental exposures.⁴ Recent

⁴ U.S. EPA (2002) Health Assessment Document for Diesel Engine Exhaust. EPA/600/8-90/057F. Office of Research and Development, Washington DC. This document is available electronically at <http://cfpub.epa.gov/ncea/cfm/recordisplay.cfm?deid=29060>.

studies are showing that populations living near large diesel emission sources such as major roadways, rail yards, and marine ports are likely to experience greater diesel exhaust exposure levels than the overall U.S. population, putting them at greater health risks.^{5,6}

EPA recently conducted an initial screening-level analysis⁷ of selected marine port areas and rail yards to better understand the populations that are exposed to diesel particulate matter (DPM) emissions from these facilities.^{8,9} This screening-level analysis focused on a representative selection of national marine ports and rail yards.¹⁰ Of the 47 marine ports and 37 rail yards selected, the results indicate that at least 13 million people, including a disproportionate number of low-income households, African-Americans, and Hispanics, living in the vicinity of these facilities, are being exposed to ambient DPM levels that are 2.0 µg/m³ and 0.2 µg/m³ above levels found in areas

⁵ Kinnee, E.J.; Touman, J.S.; Mason, R.; Thurman, J.; Beidler, A.; Bailey, C.; Cook, R. (2004) Allocation of onroad mobile emissions to road segments for air toxics modeling in an urban area. *Transport. Res. Part D* 9: 139–150.

⁶ State of California Air Resources Board. Roseville Rail Yard Study. Stationary Source Division, October 14, 2004. This document is available electronically at: <http://www.arb.ca.gov/diesel/documents/rystudy.htm> and State of California Air Resources Board. Diesel Particulate Matter Exposure Assessment Study for the Ports of Los Angeles and Long Beach, April 2006. This document is available electronically at: <http://www.arb.ca.gov/regact/marine2005/portstudy0406.pdf>.

⁷ This type of screening-level analysis is an inexact tool and not appropriate for regulatory decisionmaking; it is useful in beginning to understand potential impacts and for illustrative purposes. Additionally, the emissions inventories used as inputs for the analyses are not official estimates and likely underestimate overall emissions because they are not inclusive of all emission sources at the individual ports in the sample. For example, most inventories included emissions from ocean-going vessels (powered by Category 3 engines), as well as some commercial vessel categories, including harbor crafts, (powered by Category 1 and 2 engines), cargo handling equipment, locomotives, and heavy-duty vehicles. This final rule will not address emissions from ocean-going vessels, cargo handling equipment or heavy-duty vehicles.

⁸ ICF International. September 28, 2007. Estimation of diesel particulate matter concentration isopleths for marine harbor areas and rail yards. Memorandum to EPA under Work Assignment Number 0-3, Contract Number EP-C-06-094. This memo is available in Docket EPA-HQ-OAR-2003-0190.

⁹ ICF International. September 28, 2007. Estimation of diesel particulate matter population exposure near selected harbor areas and rail yards. Memorandum to EPA under Work Assignment Number 0-3, Contract Number EP-C-06-094. This memo is available in Docket EPA-HQ-OAR-2003-0190.

¹⁰ The Agency selected a representative sample of the top 150 U.S. ports including coastal, inland, and Great Lake ports. In selecting a sample of rail yards the Agency identified a subset from the hundreds of rail yards operated by Class I Railroads.

further from these facilities. Because those populations exposed to DPM emissions from marine ports and rail yards are more likely to be low-income and minority residents, these populations will benefit from the controls being finalized in this action. The detailed findings of this study are available in the public docket for this rulemaking.

Today, millions of Americans continue to live in areas that do not meet existing air quality standards. Currently, ozone concentrations exceeding the 8-hour ozone NAAQS occur over wide geographic areas, including most of the nation's major population centers. As of October 10, 2007, approximately 88 million people live in 39 designated areas (which include all or part of 208 counties) that either do not meet the current PM_{2.5} NAAQS or contribute to violations in other counties, and 144 million people live in 81 areas (which include all or part of 368 counties) designated as not in attainment for the 8-hour ozone NAAQS. These numbers do not include the people living in areas where there is a significant future risk of failing to maintain or achieve either the current or future PM_{2.5} or ozone NAAQS.

In addition to public health impacts, there are public welfare and environmental impacts associated with ozone and PM_{2.5} emissions. Ozone causes damage to vegetation which leads to crop and forestry economic losses, as well as harm to national parks, wilderness areas, and other natural systems. NO_x and direct emissions of PM_{2.5} can contribute to the impairment of visibility in many parts of the U.S., where people live, work, and recreate, including national parks, wilderness areas, and mandatory class I federal areas. The deposition of airborne particles can also reduce the aesthetic appeal of buildings and culturally important objects through soiling and can contribute directly (or in conjunction with other pollutants) to structural damage by means of corrosion or erosion. Finally, NO_x emissions from diesel engines contribute to the acidification, nitrification, and eutrophication of water bodies.

While EPA has already adopted many emission control programs that are expected to reduce ambient ozone and PM_{2.5} levels, including the Clean Air Interstate Rule (CAIR) (70 FR 25162, May 12, 2005) and the Clean Air Nonroad Diesel Rule (69 FR 38957, June 29, 2004), the Heavy Duty Engine and Vehicle Standards and Highway Diesel Fuel Sulfur Control Requirements (66 FR 5002, Jan. 18, 2001), and the Tier 2 Vehicle and Gasoline Sulfur Program

(65 FR 6698, Feb. 10, 2000), the additional PM_{2.5} and NO_x emission reductions resulting from this rule will assist states in attaining and maintaining the Ozone and the PM_{2.5} NAAQS both near term and in the decades to come.

In September 2006, EPA finalized revised PM_{2.5} NAAQS standards and over the next few years the EPA will undergo the process of designating areas that do not meet this new standard. EPA modeling, conducted as part of finalizing the revised NAAQS, projects that in 2015 up to 52 counties with 53 million people may violate either the daily or annual standards for PM_{2.5} (or both), while an additional 27 million people in 54 counties may live in areas that have air quality measurements within 10 percent of the revised NAAQS. Even in 2020 up to 48 counties, with 54 million people, may still not be able to meet the revised PM_{2.5} NAAQS and an additional 25 million people, living in 50 counties, are projected to have air quality measurements within 10 percent of the revised standards. The locomotive and marine diesel PM_{2.5} reductions resulting from this rulemaking are needed by a number of states to both attain and maintain the revised PM_{2.5} NAAQS.

State and local governments continue working to protect the health of their citizens and comply with requirements of the Clean Air Act (CAA or "the Act"). As part of this effort they recognize the need to secure additional major reductions in both diesel PM_{2.5} and NO_x emissions by undertaking numerous state-level actions.¹¹ However, they have also urged Agency action to finalize a strong locomotive and marine diesel engine program that will provide crucial emission reductions both in the near and long-term.

The federal program finalized today results in earlier and significantly greater NO_x and PM reductions from the locomotive and marine sector than the proposed program because of the first-ever national standards for remanufactured marine engines and the starting of Tier 4 NO_x requirements for line-haul locomotives and for 2000–3700 kW (2760–4900 hp) marine engines two years earlier than proposed. These changes reflect important cooperative efforts by the regulated

industry to implement cleaner technology as early as possible. While the program finalized today will help many states and communities achieve cleaner air, for some areas, such as the South Coast of California, the reductions achieved through this rule will not alone enable them to meet their near-term ozone and PM air quality goals. This was also the case for our 1998 locomotive rulemaking, where the State of California worked with Class I railroads operating in southern California to develop a Memoranda of Understanding (MOU) ensuring that the cleanest technologies enabled by federal rules were expeditiously introduced in areas of California with greatest air quality improvement needs. EPA continues to support California's efforts to reconcile likely future growth in the locomotive and marine sector with the public health protection needs of the area, and today's final rule includes provisions which are well-suited to encouraging early deployment of cleaner technologies through the development of similar programs.

In addition to these new standards, EPA has a number of voluntary programs that help enable government, industry, and local communities to address challenging air quality problems. The EPA SmartWay program has worked with railroads to encourage them to reduce unnecessary locomotive idling and will continue to promote the use of innovative idle reduction technologies that can substantially reduce locomotive emissions while reducing fuel consumption. EPA's National Clean Diesel Campaign, through its Clean Ports USA program is working with port authorities, terminal operators, and trucking and rail companies to promote cleaner diesel technologies and emission reduction strategies through education, incentives, and financial assistance. Part of these efforts involves voluntary retrofit programs that can further reduce emissions from the existing fleet of diesel engines. Finally, EPA is implementing a new Sustainable Ports Strategy which will allow EPA to partner with ports, business partners, communities and other stakeholders to become world leaders in sustainability, including achieving cleaner air. This new strategy builds on the success of collaborative work EPA has been doing in partnership with the American Association of Port Authorities (AAPA), and through port related efforts of Clean Ports USA, SmartWay, EPA's Regional Diesel Collaboratives and other programs. Together these approaches augment the regulations being finalized

today, helping states and communities achieve larger reductions sooner in the areas of our country that need them the most.

(2) Advanced Technologies Can Be Applied

Air pollution from locomotive and marine diesel exhaust is a challenging problem. However, we believe it can be addressed effectively through a combination of engine-out emission reduction technologies and high-efficiency catalytic aftertreatment technologies. As discussed in greater detail in section III.C, the development of these aftertreatment technologies for highway and nonroad diesel applications has advanced rapidly in recent years, so that new engines can achieve very large emission reductions in PM and NO_x (in excess of 90 and 80 percent, respectively).

High-efficiency PM control technologies are being broadly used in many parts of the world and are being used domestically to comply with EPA's heavy-duty truck standards that started taking effect in the 2007 model year. These technologies are highly durable and robust in use and have proved extremely effective in reducing exhaust hydrocarbon (HC) and carbon monoxide emissions.

Control of NO_x emissions from locomotive and marine diesel engines can also be achieved with high-efficiency exhaust emission control technologies. Such technologies are expected to be used to meet the stringent NO_x standards included in EPA's heavy-duty highway diesel and nonroad Tier 4 programs and have been in production for heavy-duty trucks in Europe since 2005 and in many stationary source applications throughout the world.

Section III.C discusses additional engineering challenges in applying these technologies to newly-built locomotive and marine engines, as well as the development steps that we expect to be taken to resolve the challenges. With the lead time available and the assurance of ULSD for the locomotive and marine sectors in 2012, as provided by our 2004 final rule for nonroad engines and fuel, we are confident the application of advanced technology to locomotives and marine diesel engines will proceed at a reasonable rate of progress and will result in systems capable of achieving the new standards on time.

(3) Basis for Action Under the Clean Air Act

Authority for the actions promulgated in this document is granted to the EPA

¹¹ Two examples of state and local actions are: California Air Resources Board (2006). Emission Reduction Plan for Ports and Goods Movements (April 2006). Available electronically at www.arb.ca.gov/gmp/docs/finalgmpplan090905.pdf; Connecticut Department of Environmental Protection (2006). Connecticut's Clean Diesel Plan (January 2006). See <http://www.dep.state.ct.us/air2/diesel/index.htm> for description of initiative.

by sections 114, 203, 205, 206, 207, 208, 213, 216, and 301(a) of the Clean Air Act as amended in 1990 (42 U.S.C. 7414, 7522, 7524, 7525, 7541, 7542, 7547, 7550 and 7601(a)).

Authority to Set Standards. EPA is promulgating emissions standards for new marine diesel engines pursuant to its authority under section 213(a)(3) and (4) of the CAA. EPA is promulgating emission standards for new locomotives and new engines used in locomotives pursuant to its authority under section 213(a)(5) of the CAA.

EPA has previously determined that certain existing locomotive engines, when they are remanufactured, are returned to as-new condition and are expected to have the same performance, durability, and reliability as freshly-manufactured locomotive engines. Consequently we set emission standards for these remanufactured engines that apply at the time of remanufacture (defined as “to replace, or inspect and qualify, each and every power assembly of a locomotive or locomotive engine, whether during a single maintenance event or cumulatively within a five-year period * * *” (see 61 FR 53102, October 4, 1996; 40 CFR 92.2)). In this action we are adopting new tiers of standards for both freshly manufactured and remanufactured locomotives and locomotive engines.

In the proposal for this rulemaking we also discussed applying a similar approach to marine diesel engines. Many marine diesel engines, particularly those above 600 kW (800 hp), periodically undergo a maintenance process that returns them to as-new condition. A full rebuild that brings an engine back to as-new condition includes a complete overhaul of the engine, including piston, rings, liners, turbocharger, heads, bearings, and geartrain/camshaft removal and replacement. Engine manufacturers typically provide instructions for such a full rebuild. Marine diesel engine owners complete this process to maintain engine reliability, durability, and performance over the life of their vessel, and to avoid the need to repower (replace the engine) before their vessel wears out. A commercial marine vessel can be in operation in excess of 40 years, which means that a marine diesel engine may be remanufactured to as-new condition three or more times before the vessel is scrapped.

Because these remanufactured engines are returned to as-new condition, section 213(a)(3) and (4) give EPA the authority to set emission standards for those engines. We are adopting requirements for remanufactured marine diesel engines,

described in section III.B(2)(b) of this action. For the purpose of this program, we are defining remanufacture as the replacement of all cylinder liners, either in one maintenance event or over the course of five years (for the purpose of this program, “replacement” includes the removing, inspecting and requalifying a liner). While replacement of cylinder liners is only one element of a full rebuild, it is common to all rebuilds. Marine diesel engines that do not have their cylinder liners replaced all at once or within a five-year period, or that do not perform cylinder liner replacement at all, are not considered to be returned to as-new condition and therefore are not considered to be remanufactured. Those engines will not be subject to the marine remanufacture requirements.

Pollutants That Can Be Regulated. CAA section 213(a)(3) directs the Administrator to set NO_x, volatile organic compounds (VOCs), or carbon monoxide standards for classes or categories of engines such as marine diesel engines that contribute to ozone or carbon monoxide concentrations in more than one nonattainment area. These “standards shall achieve the greatest degree of emission reduction achievable through the application of technology which the Administrator determines will be available for the engines or vehicles, giving appropriate consideration to cost, lead time, noise, energy, and safety factors associated with the application of such technology.”

CAA section 213(a)(4) authorizes the Administrator to establish standards to control emissions of pollutants which “may reasonably be anticipated to endanger public health and welfare” where the Administrator determines, as it has done for emissions of PM, that nonroad engines as a whole contribute significantly to such air pollution. The Administrator may promulgate regulations that are deemed appropriate, taking into account costs, noise, safety, and energy factors, for classes or categories of new nonroad vehicles and engines which cause or contribute to such air pollution.

Level of the Standards. CAA section 213(a)(5) directs EPA to adopt emission standards for new locomotives and new engines used in locomotives that achieve the “greatest degree of emissions reductions achievable through the use of technology that the Administrator determines will be available for such vehicles and engines, taking into account the cost of applying such technology within the available time period, the noise, energy, and safety factors associated with the

applications of such technology.” Section 213(a)(5) does not require any review of the contribution of locomotive emissions to pollution, though EPA does provide such information in this rulemaking. As described in section III of this preamble and in chapter 4 of the final Regulatory Impact Analysis (RIA), EPA has evaluated the available information to determine the technology that will be available for locomotives and engines subject to EPA standards.

Certification and Implementation. EPA is also acting under its authority to implement and enforce both the marine diesel emission standards and the locomotive emission standards. Section 213(d) provides that the standards EPA adopts for both new locomotive and marine diesel engines “shall be subject to sections 206, 207, 208, and 209” of the Clean Air Act, with such modifications that the Administrator deems appropriate to the regulations implementing these sections. In addition, the locomotive and marine standards “shall be enforced in the same manner as [motor vehicle] standards prescribed under section 202” of the Act. Section 213(d) also grants EPA authority to promulgate or revise regulations as necessary to determine compliance with, and enforce, standards adopted under section 213.

Technological Feasibility and Cost of Standards. The evidence provided in section III.C of this Preamble and in chapter 4 of the RIA indicates that the stringent emission standards we are setting today for newly-built and remanufactured locomotive and marine diesel engines are feasible and reflect the greatest degree of emission reduction achievable through the use of technology that will be available in the model years to which they apply. We have given appropriate consideration to costs in setting these standards. Our review of the costs and cost-effectiveness of these standards indicate that they will be reasonable and comparable to the cost-effectiveness of other emission reduction strategies that EPA has required in prior rulemakings. We have also reviewed and given appropriate consideration to the energy factors of this rule in terms of fuel efficiency as well as any safety and noise factors associated with these standards.

Health and Environmental Need for the Standards. The information in section II of this Preamble and chapter 2 of the RIA regarding air quality and public health impacts provides strong evidence that emissions from marine diesel engines and locomotives significantly and adversely impact public health or welfare. EPA has

already found in previous rules that emissions from new marine diesel engines contribute to ozone and carbon monoxide concentrations in more than one area which has failed to attain the ozone and carbon monoxide NAAQS (64 FR 73300, December 29, 1999). EPA has also previously determined that it is appropriate to establish PM standards for marine diesel engines under section 213(a)(4), and the additional information on the carcinogenicity of exposure to diesel exhaust noted above reinforces this finding. In addition, we have already found that emissions from nonroad engines as a whole significantly contribute to air pollution that may reasonably be anticipated to endanger public welfare due to regional haze and visibility impairment (67 FR 68241, Nov. 8, 2002). We find here, based on the information in the NPRM and in section II of this preamble and Chapters 2 and 3 of the final RIA, that emissions from the new marine diesel engines likewise contribute to regional haze and to visibility impairment.

The PM and NO_x emission reductions resulting from these standards are important to states' efforts in attaining and maintaining the ozone and the PM_{2.5} NAAQS in the near term and in the decades to come. As noted above, the risk to human health and welfare will be significantly reduced by the standards finalized in today's action.

II. Air Quality and Health Impacts

The locomotive and marine diesel engines subject to this final rule generate significant emissions of particulate matter (PM) and nitrogen oxides (NO_x) that contribute to nonattainment of the National Ambient Air Quality Standards (NAAQS) for PM_{2.5} and ozone. These engines also emit hazardous air pollutants or air

toxics that are associated with serious adverse health effects and contribute to visibility impairment and other harmful environmental impacts across the U.S.

By 2030, these standards are expected to reduce annual locomotive and marine diesel engine PM_{2.5} emissions by 27,000 tons; NO_x emissions by 800,000 tons; and volatile organic compound (VOC) emissions by 43,000 tons as well as reducing carbon monoxide (CO) and toxic compounds known as air toxics.¹²

We project that reductions of PM_{2.5}, NO_x, and VOC emissions from locomotive and marine diesel engines will produce nationwide air quality improvements. According to air quality modeling performed in conjunction with this rule, all 39 current PM_{2.5} nonattainment areas will experience a decrease in their projected 2030 design values. Likewise the 133 mandatory class I federal areas that EPA modeled will all see improvements in their visibility. This rule will also result in nationwide ozone benefits. In 2030, 573 counties (of 579 that have monitored data) experience at least a 0.1 ppb decrease in their ozone design values.

A. Overview

From a public health perspective, we are concerned with locomotive and marine diesel engines' contributions to atmospheric levels of particulate matter in general, diesel PM_{2.5} in particular, various gaseous air toxics, and ozone. Today, locomotive and marine diesel engine emissions represent a substantial

portion of the U.S. mobile source diesel PM_{2.5} and NO_x inventories, approximately 20 percent of mobile source NO_x and 25 percent of mobile source diesel PM_{2.5}. Over time, the relative contribution of these diesel engines to air quality problems is expected to increase as the emission contribution from other mobile sources decreases and the usage of locomotives and marine vessels increases. By 2030, without the additional emissions controls finalized in today's rule, locomotive and marine diesel engines will emit about 65 percent of the total mobile source diesel PM_{2.5} emissions and 35 percent of the total mobile source NO_x emissions.

Based on the most recent data available for this rule, air quality problems continue to persist over a wide geographic area of the United States. As of October 10, 2007 there are approximately 88 million people living in 39 designated areas (which include all or part of 208 counties) that either do not meet the current PM_{2.5} NAAQS or contribute to violations in other counties, and 144 million people living in 81 areas (which include all or part of 366 counties) designated as not in attainment for the 8-hour ozone NAAQS. These numbers do not include the people living in areas where there is a significant future risk of failing to maintain or achieve either the current or future PM_{2.5} or ozone NAAQS. Figure II-1 illustrates the widespread nature of these problems. This figure depicts counties which are currently designated nonattainment for either or both the 8-hour ozone NAAQS and PM_{2.5} NAAQS. It also shows the location of mandatory class I federal areas for visibility.

BILLING CODE 6560-50-P

¹²Nationwide locomotive and marine diesel engines comprise approximately 3 percent of the nonroad mobile sources hydrocarbon inventory. EPA National Air Quality and Emissions Trends Report 1999. March 2001, Document Number: EPA 454/R-004. This document is available in Docket EPA-HQ-OAR-2003-0190. This document is available electronically at: <http://www.epa.gov/air/airtrends/aqtrnd99/>.

Figure II-1 Air Quality Problems are Widespread

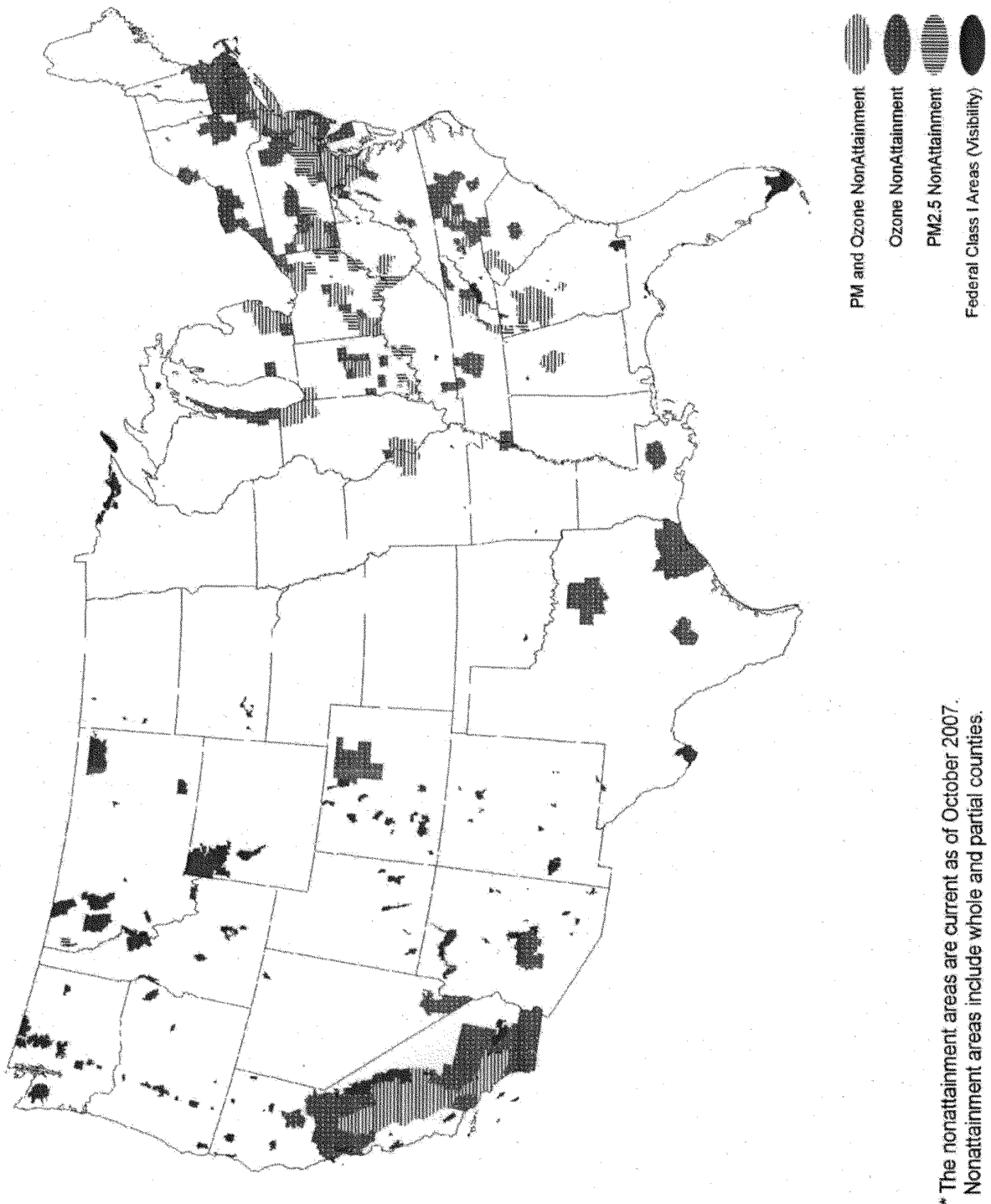

* The nonattainment areas are current as of October 2007.
Nonattainment areas include whole and partial counties.

The engine standards finalized in this rule will help reduce emissions of PM, NO_x, VOCs, CO, and air toxics and their associated health and environmental effects. Emissions from locomotives and diesel marine engines contribute to PM and ozone concentrations in many, if not all, of these nonattainment areas.¹³ The engine standards being finalized today will become effective as early as 2008, making the expected PM_{2.5}, NO_x, and VOC inventory reductions from this rulemaking critical to a number of states as they seek to either attain or maintain the current PM_{2.5} or ozone NAAQS.

Beyond the impact locomotive and marine diesel engines have on our nation's ambient air quality the diesel exhaust emissions from these engines are also of particular concern since exposure to diesel exhaust is classified as likely to be carcinogenic to humans by inhalation from environmental levels of exposure.¹⁴ Many people spend a large portion of time in or near areas of concentrated locomotive or marine diesel emissions, near rail yards, marine ports, railways, and waterways. Recent studies show that populations living near large diesel emission sources such as major roadways,¹⁵ rail yards¹⁶ and marine ports¹⁷ are likely to experience

greater diesel exhaust exposure levels than the overall U.S. population, putting them at a greater health risk.

EPA recently conducted an initial screening-level analysis¹⁸ of selected marine port areas and rail yards to better understand the populations that are exposed to diesel particulate matter (DPM) emissions from these facilities.^{19, 20} This screening-level analysis focused on a representative selection of national marine ports and rail yards.²¹ Of the 47 marine ports and 37 rail yards selected, the results indicate that at least 13 million people, including a disproportionate number of low-income households, African-Americans, and Hispanics, living in the vicinity of these facilities, are being exposed to ambient DPM levels that are 2.0 µg/m³ and 0.2 µg/m³ above levels found in areas further from these facilities. Because those populations exposed to DPM emissions from marine ports and rail yards are more likely to be low-income and minority residents, these populations will benefit from the

Angeles and Long Beach. State of California Air Resources Board.

¹⁸ This type of screening-level analysis is an inexact tool and not appropriate for regulatory decision-making; it is useful in beginning to understand potential impacts and for illustrative purposes. Additionally, the emissions inventories used as inputs for the analyses are not official estimates and likely underestimate overall emissions because they are not inclusive of all emission sources at the individual ports in the sample. For example, most inventories included emissions from ocean-going vessels (powered by Category 3 engines), as well as some commercial vessel categories, including harbor crafts (powered by Category 1 and 2 engines), cargo handling equipment, locomotives, and heavy-duty vehicles. This final rule will not address emissions from ocean-going vessels, cargo handling equipment or heavy-duty vehicles.

¹⁹ ICF International. September 28, 2007. Estimation of diesel particulate matter concentration isopleths for marine harbor areas and rail yards. Memorandum to EPA under Work Assignment Number 0-3, Contract Number EP-C-06-094. This memo is available in Docket EPA-HQ-OAR-2003-0190.

²⁰ ICF International. September 28, 2007. Estimation of diesel particulate matter population exposure near selected harbor areas and rail yards. Memorandum to EPA under Work Assignment Number 0-3, Contract Number EP-C-06-094. This memo is available in Docket EPA-HQ-OAR-2003-0190.

²¹ The Agency selected a representative sample of the top 150 U.S. ports including coastal, inland and Great Lake ports. In selecting a sample of rail yards the Agency identified a subset from the hundreds of rail yards operated by Class I Railroads.

controls being finalized in this action. The detailed findings of this study are available in the public docket for this rulemaking.

In the following sections we review important public health effects linked to pollutants emitted from locomotive and marine diesel engines. First, the human health effects caused by the pollutants and their current and projected ambient levels are discussed. Following the discussion of health effects, the modeled air quality benefits resulting from this action and the welfare effects associated with emissions from diesel engines are presented. Finally, the locomotive and marine engine emission inventories for the primary pollutants affected by this rule are provided. In summary, the emission reductions from this rule will contribute to controlling the health and welfare problems associated with ambient PM and ozone levels and with diesel-related air toxics.

Taken together, the materials in this section and in the proposal describe the need for tightened emission standards for both locomotive and marine diesel engines and the air quality and public health benefits resulting from this program. This section is not an exhaustive treatment of these issues. For a fuller understanding of the topics treated here, you should refer to the extended presentations in Chapter 2, 3 and 5 of the Regulatory Impact Analysis (RIA) accompanying this final rule.

B. Public Health Impacts

(1) Particulate Matter

The locomotive and marine engine standards detailed in this action will result in significant reductions in primary (directly emitted) PM_{2.5} emissions. In addition, the standards finalized today will reduce emissions of NO_x and VOCs, which contribute to the formation of secondary PM_{2.5}. Locomotive and marine diesel engines emit high levels of NO_x, which react in the atmosphere to form secondary PM_{2.5} (namely ammonium nitrate). These engines also emit SO₂ and VOC, which react in the atmosphere to form secondary PM_{2.5} composed of sulfates and organic carbonaceous PM_{2.5}. This rule will reduce both primary and secondary PM.

¹³ See section II.B.(1)(c) and II.B.(2)(c) for a summary of the impact emission reductions from locomotive and marine diesel engines will have on air quality in current PM_{2.5} and ozone nonattainment areas.

¹⁴ U.S. EPA (2002) Health Assessment Document for Diesel Engine Exhaust. EPA/600/8-90/057F. Office of Research and Development, Washington, DC. This document is available in Docket EPA-HQ-OAR-2003-0190. This document is available electronically at <http://cfpub.epa.gov/ncea/cfm/recordisplay.cfm?deid=29060>.

¹⁵ Kinnee, E.J.; Touma, J.S.; Mason, R.; Thurman, J.; Beidler, A.; Bailey, C.; Cook, R. (2004) Allocation of onroad mobile emissions to road segments for air toxics modeling in an urban area. Transport. Res. Part D 9:139-150; also see Cohen, J.; Cook, R.; Bailey, C.R.; Carr, E. (2005) Relationship between motor vehicle emissions of hazardous pollutants, roadway proximity, and ambient concentrations in Portland, Oregon. Environ. Modeling & Software 20: 7-12.

¹⁶ Hand, R.; Di, P.; Servin, A.; Hunsaker, L.; Suer, C. (2004) Roseville Rail Yard Study. California Air Resources Board. This document is available in Docket EPA-HQ-OAR-2003-0190. [Online at <http://www.arb.ca.gov/diesel/documents/rstudy.htm>].

¹⁷ Di P.; Servin, A.; Rosenkranz, K.; Schwehr, B.; Tran, H. (April 2006); Diesel Particulate Matter Exposure Assessment Study for the Ports of Los

(a) Background

Particulate matter (PM) represents a broad class of chemically and physically diverse substances. It can be principally characterized as discrete particles that exist in the condensed (liquid or solid) phase spanning several orders of magnitude in size. PM is further described by breaking it down into size fractions. PM₁₀ refers to particles generally less than or equal to 10 micrometers (µm) in diameter. PM_{2.5} refers to fine particles, generally less than or equal to 2.5 µm in diameter. Inhalable (or "thoracic") coarse particles refer to those particles generally greater than 2.5 µm but less than or equal to 10 µm in diameter. Ultrafine PM refers to particles less than 100 nanometers (0.1 µm) in diameter. Larger particles tend to be removed by the respiratory clearance mechanisms (e.g. coughing), whereas smaller particles are deposited deeper in the lungs.

Fine particles are produced primarily by combustion processes and by transformations of gaseous emissions (e.g., SO_x, NO_x and VOC) in the atmosphere. The chemical and physical properties of PM_{2.5} may vary greatly with time, region, meteorology, and source category. Thus, PM_{2.5} may include a complex mixture of different pollutants including sulfates, nitrates, organic compounds, elemental carbon and metal compounds. These particles can remain in the atmosphere for days to weeks and travel hundreds to thousands of kilometers.

The primary PM_{2.5} NAAQS includes a short-term (24-hour) and a long-term (annual) standard. The 1997 PM_{2.5} NAAQS established by EPA set the 24-hour standard at a level of 65 µg/m³ based on the 98th percentile concentration averaged over three years. The annual standard specifies an expected annual arithmetic mean not to exceed 15 µg/m³ averaged over three years.

EPA has recently amended the NAAQS for PM_{2.5} (71 FR 61144, October 17, 2006). The final rule, signed on September 21, 2006, addressed revisions to the primary and secondary NAAQS for PM to provide increased protection of public health and welfare, respectively. The level of the 24-hour PM_{2.5} NAAQS was revised from 65 µg/m³ to 35 µg/m³ and the level of the annual PM_{2.5} NAAQS was retained at 15 µg/m³. With regard to the secondary standards for PM_{2.5}, EPA has revised these standards to be identical in all respects to the revised primary standards.

(b) Health Effects of PM_{2.5}

Scientific studies show ambient PM is associated with a series of adverse health effects. These health effects are discussed in detail in the 2004 EPA Particulate Matter Air Quality Criteria Document (PM AQCD), and the 2005 PM Staff Paper.^{22, 23} Further discussion of health effects associated with PM can also be found in the RIA for this rule.

Health effects associated with short-term exposures (hours to days) to ambient PM include premature mortality, increased hospital admissions, heart and lung diseases, increased cough, adverse lower-respiratory symptoms, decrements in lung function and changes in heart rate rhythm and other cardiac effects. Studies examining populations exposed to different levels of air pollution over a number of years, including the Harvard Six Cities Study and the American Cancer Society Study, show associations between long-term exposure to ambient PM_{2.5} and both total and cardiovascular and respiratory mortality.²⁴ In addition, a reanalysis of the American Cancer Society Study shows an association between fine particle and sulfate concentrations and lung cancer mortality.²⁵

The health effects of PM_{2.5} have been further documented in local impact studies which have focused on health effects due to PM_{2.5} exposures measured on or near roadways. These studies take into account all air pollution sources, including both spark-ignition (gasoline) and diesel powered vehicles, and indicate that exposure to PM_{2.5} emissions near roadways, which are dominated by mobile sources, are associated with potentially serious health effects. For instance, a recent study found associations between concentrations of cardiac risk factors in the blood of healthy young police officers and PM_{2.5} concentrations

²² U.S. EPA (2004) Air Quality Criteria for Particulate Matter (Oct 2004), Volume I Document No. EPA600/P-99/002aF and Volume II Document No. EPA600/P-99/002bF. This document is available in Docket EPA-HQ-OAR-2003-0190.

²³ U.S. EPA (2005) Review of the National Ambient Air Quality Standard for Particulate Matter: Policy Assessment of Scientific and Technical Information. OAQPS Staff Paper. EPA-452/R-05-005. This document is available in Docket EPA-HQ-OAR-2003-0190.

²⁴ Dockery, DW; Pope, CA III; Xu, X; et al. 1993. An association between air pollution and mortality in six U.S. cities. *N Engl J Med* 329:1753-1759.

²⁵ Pope, C. A., III; Burnett, R. T.; Thun, M. J.; Calle, E. E.; Krewski, D.; Ito, K.; Thurston, G. D. (2002) Lung cancer, cardiopulmonary mortality, and long-term exposure to fine particulate air pollution. *J. Am. Med. Assoc.* 287:1132-1141.

measured in vehicles.²⁶ Also, a number of studies have shown associations between residential or school outdoor concentrations of some fine particle constituents that are found in motor vehicle exhaust, and adverse respiratory outcomes, including asthma prevalence in children who live near major roadways.^{27, 28, 29} Although the engines considered in this rule differ from those in these studies with respect to their applications and fuel qualities, these studies provide an indication of the types of health effects that might be expected to be associated with personal exposure to PM_{2.5} emissions from large marine diesel and locomotive engines.

Recent new studies from the State of California provide evidence that PM_{2.5} emissions within marine ports and rail yards can contribute significantly to elevated ambient concentrations near these sources.^{30, 31} A substantial number of people experience exposure to locomotive and marine diesel engine emissions, raising potential health concerns. The controls finalized in this action will help reduce exposure to PM_{2.5}, specifically exposure to marine port and rail yard related diesel PM_{2.5} sources. Additional information on marine port and rail yard emissions and ambient exposures can be found in Chapter 2 of the RIA.

(c) Current and Projected PM_{2.5} Levels

²⁶ Riediker, M.; Cascio, W.E.; Griggs, T.R.; et al. (2004) Particulate matter exposure in cars is associated with cardiovascular effects in healthy young men. *Am J Respir Crit Care Med* 169: 934-940.

²⁷ Van Vliet, P.; Knape, M.; de Hartog, J.; Janssen, N.; Harssema, H.; Brunekreef, B. (1997). Motor vehicle exhaust and chronic respiratory symptoms in children living near freeways. *Env. Research* 74: 122-132.

²⁸ Brunekreef, B., Janssen, N.A.H.; de Hartog, J.; Harssema, H.; Knape, M.; van Vliet, P. (1997). Air pollution from truck traffic and lung function in children living near roadways. *Epidemiology* 8:298-303.

²⁹ Kim, J.J.; Smorodinsky, S.; Lipsett, M.; Singer, B.C.; Hodgson, A.T.; Ostro, B. (2004). Traffic-related air pollution near busy roads: The East Bay children's respiratory health study. *Am. J. Respir. Crit. Care Med.* 170: 520-526.

³⁰ State of California Air Resources Board. Roseville Rail Yard Study. Stationary Source Division, October 14, 2004. This document is available in Docket EPA-HQ-OAR-2003-0190. This document is available electronically at: <http://www.arb.ca.gov/diesel/documents/rystudy.htm>.

³¹ State of California Air Resources Board. Diesel Particulate Matter Exposure Assessment Study for the Ports of Los Angeles and Long Beach, April 2006. This document is available in Docket EPA-HQ-OAR-2003-0190. This document is available electronically at: <ftp://ftp.arb.ca.gov/carbis/msprog/offroad/marinevess/documents/portstudy0406.pdf>.

PM_{2.5} concentrations exceeding the level of the PM_{2.5} NAAQS occur in many parts of the country.³² In 2005 EPA designated 39 nonattainment areas for the 1997 PM_{2.5} NAAQS (70 FR 943, January 5, 2005). These areas are

comprised of 208 full or partial counties with a total population exceeding 88 million. The 1997 PM_{2.5} NAAQS was recently revised and the 2006 PM_{2.5} NAAQS became effective on December 18, 2006. Table II–1 presents the

number of counties in areas currently designated as nonattainment for the 1997 PM_{2.5} NAAQS as well as the number of additional counties that have monitored data that is violating the 2006 PM_{2.5} NAAQS.

TABLE II–1.—FINE PARTICLE STANDARDS: CURRENT NONATTAINMENT AREAS AND OTHER VIOLATING COUNTIES

Nonattainment areas/other violating counties	Number of counties	Population ^a
1997 PM _{2.5} Standards: 39 areas currently designated	208	88,394,000
2006 PM _{2.5} Standards: counties with violating monitors ^b	49	18,198,676
Total	257	106,595,676

Notes:

(a) Population numbers are from 2000 census data.

(b) This table provides an estimate of the counties violating the 2006 PM_{2.5} NAAQS based on 2003–05 air quality data. The areas designated as nonattainment for the 2006 PM_{2.5} NAAQS will be based on 3 years of air quality data from later years. Also, the county numbers in the summary table includes only the counties with monitors violating the 2006 PM_{2.5} NAAQS. The monitored county violations may be an underestimate of the number of counties and populations that will eventually be included in areas with multiple counties designated nonattainment.

A number of state governments have told EPA that they need the reductions this rule will provide in order to meet and maintain the PM_{2.5} NAAQS. Areas designated as not attaining the 1997 PM_{2.5} NAAQS will need to attain the 1997 standards in the 2010 to 2015 time frame, and then maintain them thereafter. The attainment dates associated with the potential new 2006 PM_{2.5} nonattainment areas are likely to be in the 2015 to 2020 timeframe. The emission standards finalized in this action become effective as early as 2008 making the NO_x, PM, and VOC inventory reductions from this rulemaking useful to states in attaining or maintaining the PM_{2.5} NAAQS.

EPA has already adopted many emission control programs that are expected to reduce ambient PM_{2.5} levels and which will assist in reducing the number of areas that fail to achieve the PM_{2.5} NAAQS. Even so, our air quality modeling for this final rule projects that in 2020, with all current controls but excluding the reductions achieved through this rule, up to 11 counties with a population of 24 million may not attain the current annual PM_{2.5} standard of 15 µg/m³. These numbers do not account for additional areas that have air quality measurements within 10 percent of the annual PM_{2.5} standard. These areas, although not violating the standards, will also benefit from the additional reductions from this rule ensuring long-term maintenance of the PM_{2.5} NAAQS.

Air quality modeling performed for this final rule shows that in 2020 and 2030 all 39 current PM_{2.5} nonattainment areas will experience decreases in their PM_{2.5} design values. For areas with

current PM_{2.5} design values greater than 15 µg/m³ the modeled future-year population weighted PM_{2.5} design values are expected to decrease on average by 0.08 µg/m³ in 2020 and by 0.16 µg/m³ in 2030. The maximum decrease for future-year PM_{2.5} design values will be 0.38 µg/m³ in 2020 and 0.81 µg/m³ in 2030. The air quality modeling methodology and the projected reductions are discussed in more detail in Chapter 2 of the RIA.

(2) Ozone

The locomotive and marine engine standards finalized in this action are expected to result in significant reductions of NO_x and VOC emissions. NO_x and VOC contribute to the formation of ground-level ozone pollution or smog. People in many areas across the U.S. continue to be exposed to unhealthy levels of ambient ozone.

(a) Background

Ground-level ozone pollution is typically formed by the reaction of volatile organic compounds (VOC) and nitrogen oxides (NO_x) in the lower atmosphere in the presence of heat and sunlight. These pollutants, often referred to as ozone precursors, are emitted by many types of pollution sources, such as highway and nonroad motor vehicles and engines, power plants, chemical plants, refineries, makers of consumer and commercial products, industrial facilities, and smaller area sources.

The science of ozone formation, transport, and accumulation is complex.³³ Ground-level ozone is

produced and destroyed in a cyclical set of chemical reactions, many of which are sensitive to temperature and sunlight. When ambient temperatures and sunlight levels remain high for several days and the air is relatively stagnant, ozone and its precursors can build up and result in more ozone than typically occurs on a single high-temperature day. Ozone can also be transported into an area from pollution sources found hundreds of miles upwind, resulting in elevated ozone levels even in areas with low local VOC or NO_x emissions.

The current ozone NAAQS, established by EPA in 1997, has an 8-hour averaging time. The 8-hour ozone NAAQS is met at an ambient air quality monitoring site when the average of the annual fourth-highest daily maximum 8-hour average ozone concentration over three years is less than or equal to 0.084 ppm. On June 20, 2007, EPA proposed to strengthen the ozone NAAQS, the proposed revisions reflect new scientific evidence about ozone and its effects on people and public welfare.³⁴ The final

available in Docket EPA–HQ–OAR–2003–0190. This document may be accessed electronically at: http://www.epa.gov/ttn/naaqs/standards/ozone/s_o3_cr_cd.html.

³⁴ EPA proposed to set the 8-hour primary ozone standard to a level within the range of 0.070–0.075 ppm. The agency also requested comments on alternative levels of the 8-hour primary ozone standard, within a range from 0.060 ppm up to and including retention of the current standard (0.084 ppm). EPA also proposed two options for the secondary ozone standard. One option would establish a new form of standard designed specifically to protect sensitive plants from damage caused by repeated ozone exposure throughout the growing season. This cumulative standard would add daily ozone concentrations across a three-month period. EPA proposed to set the level of the cumulative standard within the range of 7 to 21 ppm-hours. The other option would follow the

³² A listing of the PM_{2.5} nonattainment areas is included in the RIA for this rule.

³³ U.S. EPA Air Quality Criteria for Ozone and Related Photochemical Oxidants (Final). U.S. Environmental Protection Agency, Washington, DC, EPA 600/R–05/004aF–cF, 2006. This document is

ozone NAAQS rule is scheduled for March 2008.

(b) Health Effects of Ozone

The health and welfare effects of ozone are well documented and are assessed in EPA's 2006 ozone Air Quality Criteria Document (ozone AQCD) and EPA Staff Paper.^{35, 36} Ozone can irritate the respiratory system, causing coughing, throat irritation, and/or uncomfortable sensation in the chest. Ozone can reduce lung function and make it more difficult to breathe deeply; breathing may also become more rapid and shallow than normal, thereby limiting a person's activity. Ozone can also aggravate asthma, leading to more asthma attacks that require medical attention and/or the use of additional medication. There is evidence of an elevated risk of mortality associated with acute exposure to ozone, especially in the summer or warm season when ozone levels are typically high. Animal toxicological evidence indicates that with repeated exposure, ozone can inflame and damage the lining of the lungs, which may lead to permanent changes in lung tissue and irreversible reductions in lung function. People who are more susceptible to effects associated with exposure to ozone can include children, the elderly, and individuals with respiratory disease such as asthma. Those with greater exposures to ozone, for instance due to time spent outdoors (e.g., children and outdoor workers), are also of particular concern.

The recent ozone AQCD also examined relevant new scientific information that has emerged in the past decade, including the impact of ozone exposure on such health effects as changes in lung structure and biochemistry, inflammation of the lungs, exacerbation and causation of asthma, respiratory illness-related school absence, hospital admissions and premature mortality. Animal toxicological studies have suggested potential interactions between ozone

current practice of making the secondary standard equal to the proposed 8-hour primary standard.

³⁵ U.S. EPA Air Quality Criteria for Ozone and Related Photochemical Oxidants (Final). U.S. Environmental Protection Agency, Washington, DC, EPA 600/R-05/004aF-cF, 2006. This document is available in Docket EPA-HQ-OAR-2003-0190. This document may be accessed electronically at: http://www.epa.gov/ttn/naaqs/standards/ozone/s_o3_cr_cd.html.

³⁶ U.S. EPA (2007) Review of the National Ambient Air Quality Standards for Ozone, Policy Assessment of Scientific and Technical Information. OAQPS Staff Paper. EPA-452/R-07-003. This document is available in Docket EPA-HQ-OAR-2003-0190. This document is available electronically at: http://www.epa.gov/ttn/naaqs/standards/ozone/s_o3_cr_cd.html.

and PM with increased responses observed to mixtures of the two pollutants compared to either ozone or PM alone. The respiratory morbidity observed in animal studies along with the evidence from epidemiologic studies supports a causal relationship between acute ambient ozone exposures and increased respiratory-related emergency room visits and hospitalizations in the warm season. In addition, there is suggestive evidence of a contribution of ozone to cardiovascular-related morbidity and non-accidental and cardiopulmonary mortality.

(c) Current and Projected Ozone Levels

Ozone concentrations exceeding the level of the 8-hour ozone NAAQS occur over wide geographic areas, including most of the nation's major population centers.³⁷ As of October 10, 2007, there were approximately 144 million people living in 81 areas (which include all or part of 366 counties) designated as not in attainment with the 8-hour ozone NAAQS. These numbers do not include the people living in areas where there is a future risk of failing to maintain or attain the 8-hour ozone NAAQS.

States with 8-hour ozone nonattainment areas are required to take action to bring those areas into compliance in the future. Based on the final rule designating and classifying 8-hour ozone nonattainment areas (69 FR 23951, April 30, 2004), most 8-hour ozone nonattainment areas will be required to attain the ozone NAAQS in the 2007 to 2013 time frame and then maintain the NAAQS thereafter.³⁸ Many of these nonattainment areas will need to adopt additional emission reduction programs and the NO_x and VOC reductions from this final action are particularly important for these states. In addition, EPA's review of the ozone NAAQS is currently underway with a final rule scheduled for March 2008. If the ozone NAAQS is revised then new nonattainment areas will be designated. While EPA is not relying on it for purposes of justifying this rule, the emission reductions from this rulemaking will also be helpful to states if EPA revises the ozone NAAQS to be more stringent.

EPA has already adopted many emission control programs that are expected to reduce ambient ozone levels. These control programs are described in section I.B.1 of this preamble. As a result of these programs, the number of areas that fail to meet the

³⁷ A listing of the 8-hour ozone nonattainment areas is included in the RIA for this rule.

³⁸ The Los Angeles South Coast Air Basin 8-hour ozone nonattainment area will have to attain before June 15, 2021.

8-hour ozone NAAQS in the future is expected to decrease. Based on the air quality modeling performed for this rule, which does not include any additional local controls, we estimate nine counties (where 22 million people are projected to live) will exceed the 8-hour ozone NAAQS in 2020.³⁹ An additional 39 counties (where 29 million people are projected to live) are expected to be within 10 percent of violating the 8-hour ozone NAAQS in 2020.

This rule results in reductions in nationwide ozone levels. The air quality modeling projects that in 2030, 573 counties (of 579 that have monitored data) experience at least a 0.1 ppb decrease in their ozone design values. There are three nonattainment areas in southern California, the Los Angeles-South Coast Air Basin nonattainment area, the Riverside Co. (Coachella Valley) nonattainment area and the Los Angeles—San Bernardino (W. Mojave) nonattainment area, which will experience 8-hour ozone design value increases due to the NO_x disbenefits which occur in these VOC-limited ozone nonattainment areas. Briefly, NO_x reductions at certain times and in some areas can lead to increased ozone levels. The air quality modeling methodology (Section 2.3), the projected reductions (Section 2.2.4), and the limited NO_x disbenefits (Section 2.2.4.2.1), are discussed in more detail in Chapter 2 of the RIA.

Results from the air quality modeling conducted for this final rule indicate that the locomotive and marine diesel engine emission reductions in 2020 and 2030 will improve both the average and population-weighted average ozone concentrations for the U.S. In addition, the air quality modeling shows that on average this final rule will help bring counties closer to ozone attainment as well as assist counties whose ozone concentrations are within ten percent below the standard. For example, in projected nonattainment counties, on a population-weighted basis, the 8-hour ozone design value will on average decrease by 0.13 ppb in 2020 and 0.62 ppb in 2030.⁴⁰

The impact of the reductions has also been analyzed with respect to those areas that have the highest design

³⁹ We expect many of the 8-hour ozone nonattainment areas to adopt additional emission reduction programs but we are unable to quantify or rely upon future reductions from additional state and local programs that have not yet been adopted.

⁴⁰ Ozone design values are reported in parts per million (ppm) as specified in 40 CFR part 50. Due to the scale of the design value changes in this action, results have been presented in parts per billion (ppb) format.

values, at or above 85 ppb, in 2020. We project there will be nine U.S. counties with design values at or above 85 ppb in 2020. After implementation of this rule, we project that one of these nine counties will drop below 85 ppb. Further, two of the nine counties will be at least 10 percent closer to a design value of less than 85 ppb, and on average all nine counties will be about 18 percent closer to a design value of less than 85 ppb.

(3) Air Toxics

People experience elevated risk of cancer and other noncancer health effects from exposure to the class of pollutants known collectively as "air toxics". Mobile sources are responsible for a significant portion of this exposure. According to the National Air Toxic Assessment (NATA) for 1999, mobile sources, including locomotive and marine diesel marine engines, were responsible for 44 percent of outdoor toxic emissions and almost 50 percent of the cancer risk among the 133 pollutants quantitatively assessed in the 1999 NATA. Benzene is the largest contributor to cancer risk of all the assessed pollutants and mobile sources were responsible for about 68 percent of all benzene emissions in 1999. Although the 1999 NATA did not quantify cancer risks associated with exposure to diesel exhaust, EPA has concluded that diesel exhaust ranks with other emissions that the national-scale assessment suggests pose the greatest relative risk.

According to the 1999 NATA, nearly the entire U.S. population was exposed to an average level of air toxics that has the potential for adverse respiratory noncancer health effects. This potential was indicated by a hazard index (HI) greater than 1.⁴¹ Mobile sources were responsible for 74 percent of the potential noncancer hazard from

⁴¹ To express chronic noncancer hazards, we used the RfC as part of a calculation called the hazard quotient (HQ), which is the ratio between the concentration to which a person is exposed and the RfC. (RfC is defined by EPA as, "an estimate of a continuous inhalation exposure to the human population, including sensitive subgroups, with uncertainty spanning perhaps an order of magnitude, which is likely to be without appreciable risks of deleterious noncancer effects during a lifetime.") A value of the HQ less than one indicates that the exposure is lower than the RfC and that no adverse health effects would be expected. Combined noncancer hazards were calculated using the hazard index (HI), defined as the sum of hazard quotients for individual air toxic compounds that affect the same target organ or system. As with the hazard quotient, a value of the HI at or below 1.0 will likely not result in adverse effects over a lifetime of exposure. However, a value of the HI greater than 1.0 does not necessarily suggest a likelihood of adverse effects. Furthermore, the HI cannot be translated into a probability that adverse effects will occur and is not likely to be proportional to risk.

outdoor air toxics in 1999. About 91 percent of this potential noncancer hazard was from acrolein;⁴² however, the confidence in the RfC for acrolein is medium⁴³ and confidence in NATA estimates of population noncancer hazard from ambient exposure to this pollutant is low.⁴⁴ It is important to note that NATA estimates of noncancer hazard do not include the adverse health effects associated with particulate matter identified in EPA's Particulate Matter Air Quality Criteria Document. Gasoline and diesel engine emissions contribute significantly to particulate matter concentration.

The NATA modeling framework has a number of limitations which prevent its use as the sole basis for setting regulatory standards. These limitations and uncertainties are discussed on the 1999 NATA website.⁴⁵ Even so, this modeling framework is very useful in identifying air toxic pollutants and sources of greatest concern, setting regulatory priorities, and informing the decision making process.

The following section provides a brief overview of air toxics which are associated with nonroad engines, including locomotive and marine diesel engines, and provides a discussion of the health risks associated with each air toxic.

(a) Diesel Exhaust (DE)

Locomotive and marine diesel engines emit diesel exhaust (DE), a complex mixture comprised of carbon dioxide, oxygen, nitrogen, water vapor, carbon monoxide, nitrogen compounds, sulfur compounds and numerous low-molecular-weight hydrocarbons. A number of these gaseous hydrocarbon components are individually known to be toxic, including aldehydes, benzene and 1,3-butadiene. The diesel particulate matter (DPM) present in diesel exhaust consists of fine particles (< 2.5 μm), including a subgroup with a large number of ultrafine particles (< 0.1 μm). These particles have a large surface area which makes them an excellent medium for adsorbing

⁴² U.S. EPA (2006) National-Scale Air Toxics Assessment for 1999. This material is available electronically at <http://www.epa.gov/ttn/atw/nata1999/risksum.html>.

⁴³ U.S. EPA (2003) Integrated Risk Information System File of Acrolein. National Center for Environmental Assessment, Office of Research and Development, Washington, D.C. 2003. This material is available electronically at <http://www.epa.gov/iris/subst/0364.htm>.

⁴⁴ U.S. EPA (2006) National-Scale Air Toxics Assessment for 1999. This material is available electronically at <http://www.epa.gov/ttn/atw/nata1999/risksum.html>.

⁴⁵ U.S. EPA (2006) National-Scale Air Toxics Assessment for 1999. <http://www.epa.gov/ttn/atw/nata1999>.

organics and their small size makes them highly respirable and able to reach the deep lung. Many of the organic compounds present on the particles and in the gases are individually known to have mutagenic and carcinogenic properties. Diesel exhaust varies significantly in chemical composition and particle sizes between different engine types (heavy-duty, light-duty), engine operating conditions (idle, accelerate, decelerate), and fuel formulations (high/low sulfur fuel). Also, there are emissions differences between on-road and nonroad engines because the nonroad engines are generally of older technology. This is especially true for locomotive and marine diesel engines.⁴⁶

After being emitted in the engine exhaust, diesel exhaust undergoes dilution as well as chemical and physical changes in the atmosphere. The lifetime for some of the compounds present in diesel exhaust ranges from hours to days.

(i) Diesel Exhaust: Potential Cancer Effects

In EPA's 2002 Diesel Health Assessment Document (Diesel HAD),⁴⁷ exposure to diesel exhaust was classified as likely to be carcinogenic to humans by inhalation from environmental exposures, in accordance with the revised draft 1996/1999 EPA cancer guidelines. A number of other agencies (National Institute for Occupational Safety and Health, the International Agency for Research on Cancer, the World Health Organization, California EPA, and the U.S. Department of Health and Human Services) have made similar classifications. However, EPA also concluded in the Diesel HAD that it is not possible currently to calculate a cancer unit risk for diesel exhaust due to a variety of factors that limit the current studies, such as limited quantitative exposure histories in occupational groups investigated for lung cancer.

For the Diesel HAD, EPA reviewed 22 epidemiologic studies on the subject of the carcinogenicity of workers exposed

⁴⁶ U.S. EPA (2002) Health Assessment Document for Diesel Engine Exhaust. EPA/600/8-90/057F Office of Research and Development, Washington DC. Pp1-1 1-2. This document is available electronically at <http://cfpub.epa.gov/ncea/cfm/recordisplay.cfm?deid=29060>. This document can be found in Docket EPA-HQ-OAR-2003-0190.

⁴⁷ U.S. EPA (2002) Health Assessment Document for Diesel Engine Exhaust. EPA/600/8-90/057F Office of Research and Development, Washington, DC. This document is available electronically at <http://cfpub.epa.gov/ncea/cfm/recordisplay.cfm?deid=29060>. This document can be found in Docket EPA-HQ-OAR-2003-0190.

to diesel exhaust in various occupations, finding increased lung cancer risk, although not always statistically significant, in 8 out of 10 cohort studies and 10 out of 12 case-control studies within several industries, including railroad workers. Relative risk for lung cancer associated with exposure ranged from 1.2 to 1.5, although a few studies show relative risks as high as 2.6. Additionally, the Diesel HAD also relied on two independent meta-analyses, which examined 23 and 30 occupational studies respectively, which found statistically significant increases in smoking-adjusted relative lung cancer risk associated with exposure to diesel exhaust, of 1.33 to 1.47. These meta-analyses demonstrate the effect of pooling many studies and in this case show the positive relationship between diesel exhaust exposure and lung cancer across a variety of diesel exhaust-exposed occupations.^{48, 49}

In the absence of a cancer unit risk, the Diesel HAD sought to provide additional insight into the significance of the diesel exhaust-cancer hazard by estimating possible ranges of risk that might be present in the population. An exploratory analysis was used to characterize a possible risk range by comparing a typical environmental exposure level for highway diesel sources to a selected range of occupational exposure levels. The occupationally observed risks were then proportionally scaled according to the exposure ratios to obtain an estimate of the possible environmental risk. A number of calculations are needed to accomplish this, and these can be seen in the EPA Diesel HAD. The outcome was that environmental risks from diesel exhaust exposure could range from a low of 10^{-4} to 10^{-5} to as high as 10^{-3} , reflecting the range of occupational exposures that could be associated with the relative and absolute risk levels observed in the occupational studies. Because of uncertainties, the analysis acknowledged that the risks could be lower than 10^{-4} or 10^{-5} , and a zero risk from diesel exhaust exposure was not ruled out.

Retrospective health studies of railroad workers have played an important part in determining that exposure to diesel exhaust is likely to be carcinogenic to humans by inhalation from environmental exposures. Key evidence of the diesel exhaust exposure

linkage to lung cancer comes from two retrospective case-control studies of railroad workers which are discussed at length in the Diesel HAD and summarized in Chapter 2 of the RIA.

(ii) Diesel Exhaust: Other Health Effects

Noncancer health effects of acute and chronic exposure to diesel exhaust emissions are also of concern to the EPA. EPA derived a diesel exhaust reference concentration (RfC) from consideration of four well-conducted chronic rat inhalation studies showing adverse pulmonary effects.^{50, 51, 52, 53} The RfC is $5 \mu\text{g}/\text{m}^3$ for diesel exhaust as measured by diesel PM. This RfC does not consider allergenic effects such as those associated with asthma or immunologic effects. There is growing evidence, discussed in the Diesel HAD, that exposure to diesel exhaust can exacerbate these effects, but the exposure-response data are presently lacking to derive an RfC. The EPA Diesel HAD states, "With DPM [diesel particulate matter] being a ubiquitous component of ambient PM, there is an uncertainty about the adequacy of the existing DE [diesel exhaust] noncancer database to identify all of the pertinent DE-caused noncancer health hazards." (p. 9–19). The Diesel HAD concludes "that acute exposure to DE [diesel exhaust] has been associated with irritation of the eye, nose, and throat, respiratory symptoms (cough and phlegm), and neurophysiological symptoms such as headache, lightheadedness, nausea, vomiting, and numbness or tingling of the extremities."⁵⁴

Exposure to diesel exhaust has also been shown to cause serious noncancer effects in occupational exposure studies. One study of railroad workers and electricians, cited in the Diesel HAD,⁵⁵ found that exposure to diesel exhaust

resulted in neurobehavioral impairments in one or more areas including reaction time, balance, blink reflex latency, verbal recall, and color vision confusion indices. Pulmonary function tests also showed that 10 of the 16 workers had airway obstruction and another group of 10 of 16 workers had chronic bronchitis, chest pain, tightness, and hyperactive airways. Finally, a variety of studies have been published subsequent to the completion of the Diesel HAD. One such study, published in 2006,⁵⁶ found that railroad engineers and conductors with diesel exhaust exposure from operating trains had an increased incidence of chronic obstructive pulmonary disease (COPD) mortality. The odds of COPD mortality increased with years on the job so that those who had worked more than 16 years as an engineer or conductor after 1959 had an increased risk of 1.61 (95% confidence interval, 1.12–2.30). EPA is assessing the significance of this study within the context of the broader literature.

(iii) Ambient PM_{2.5} Levels and Exposure to Diesel Exhaust PM

The Diesel HAD also briefly summarizes health effects associated with ambient PM and discusses the EPA's annual PM_{2.5} NAAQS of $15 \mu\text{g}/\text{m}^3$. There is a much more extensive body of human data showing a wide spectrum of adverse health effects associated with exposure to ambient PM, of which diesel exhaust is an important component. The PM_{2.5} NAAQS is designed to provide protection from the noncancer and premature mortality effects of PM_{2.5} as a whole.

(iv) Diesel Exhaust PM Exposures

Exposure of people to diesel exhaust depends on their various activities, the time spent in those activities, the locations where these activities occur, and the levels of diesel exhaust pollutants in those locations. The major difference between ambient levels of diesel particulate and exposure levels for diesel particulate is that exposure accounts for a person moving from location to location, proximity to the emission source, and whether the exposure occurs in an enclosed environment.

Occupational Exposures

Occupational exposures to diesel exhaust from mobile sources, including

⁴⁸ Bhatia, R., Lopipero, P., Smith, A. (1998) Diesel exposure and lung cancer. *Epidemiology* 9(1):84–91.

⁴⁹ Lipsett, M.; Campleman, S.; (1999) Occupational exposure to diesel exhaust and lung cancer: a meta-analysis. *Am J Public Health* 80(7): 1009–1017.

⁵⁰ Ishinishi, N; Kuwabara, N; Takaki, Y; et al. (1988) Long-term inhalation experiments on diesel exhaust. In: Diesel exhaust and health risks. Results of the HERP studies. Ibaraki, Japan: Research Committee for HERP Studies; pp. 11–84.

⁵¹ Heinrich, U; Fuhst, R; Rittinghausen, S; et al. (1995) Chronic inhalation exposure of Wistar rats and two different strains of mice to diesel engine exhaust, carbon black, and titanium dioxide. *Inhal. Toxicol.* 7:553–556.

⁵² Mauderly, JL; Jones, RK; Griffith, WC; et al. (1987) Diesel exhaust is a pulmonary carcinogen in rats exposed chronically by inhalation. *Fundam. Appl. Toxicol.* 9:208–221.

⁵³ Nikula, KJ; Snipes, MB; Barr, EB; et al. (1995) Comparative pulmonary toxicities and carcinogenicities of chronically inhaled diesel exhaust and carbon black in F344 rats. *Fundam. Appl. Toxicol.* 25:80–94.

⁵⁴ "Health Assessment Document for Diesel Engine Exhaust," U.S. Environmental Protection Agency, 600/8–90/057F, <http://www.epa.gov/ttn/atw/diesel/final.pdf>, May 2002, p. 9–9.

⁵⁵ Kilburn (2000) See HAD Chapter 5–7.

⁵⁶ Hart, JE; Laden F; Schenker, M.B.; and Garshick, E. Chronic Obstructive Pulmonary Disease Mortality in Diesel-Exposed Railroad Workers; *Environmental Health Perspective* July 2006: 1013–1016.

locomotive engines and marine diesel engines, can be several orders of magnitude greater than typical exposures in the non-occupationally exposed population.

Over the years, diesel particulate exposures have been measured for a number of occupational groups. A wide range of exposures have been reported, from 2 $\mu\text{g}/\text{m}^3$ to 1,280 $\mu\text{g}/\text{m}^3$, for a variety of occupations. Studies have shown that miners and railroad workers typically have higher diesel exposure levels than other occupational groups studied, including firefighters, truck dock workers, and truck drivers (both short and long haul).⁵⁷ As discussed in the Diesel HAD, the National Institute of Occupational Safety and Health (NIOSH) has estimated a total of 1,400,000 workers are occupationally exposed to diesel exhaust from on-road and nonroad vehicles including locomotive and marine diesel engines.

Elevated Concentrations and Ambient Exposures in Mobile Source-Impacted Areas

Regions immediately downwind of rail yards and marine ports may experience elevated ambient concentrations of directly-emitted $\text{PM}_{2.5}$ from diesel engines. Due to the unique nature of rail yards and marine ports, emissions from a large number of diesel engines are concentrated in a small area. Furthermore, emissions occur at or near ground level, allowing emissions of diesel engines to reach nearby receptors without fully mixing with background air.

A 2004 study conducted by the California Air Resources Board (CARB) examined the air quality impacts of railroad operations at the J.R. Davis Rail Yard, the largest service and maintenance rail facility in the western United States.⁵⁸ The yard occupies 950 acres along a one-quarter mile wide and four-mile long section of land in Roseville, CA. The study developed an emissions inventory for the facility for the year 2000 and modeled ambient concentrations of diesel PM using a well-accepted dispersion model (ISCST3). The study estimated substantially elevated diesel PM concentrations in an area 5,000 meters from the facility, with higher

concentrations closer to the rail yard. Using local meteorological data, annual average contributions from the rail yard to ambient diesel PM concentrations under prevailing wind conditions were 1.74, 1.18, 0.80, and 0.25 $\mu\text{g}/\text{m}^3$ at receptors located 200, 500, 1000, and 5000 meters from the yard, respectively. Several tens of thousands of people live within the area estimated to experience substantial increases in annual average ambient $\text{PM}_{2.5}$ as a result of these rail yard emissions.

Another study from CARB evaluated air quality impacts of diesel engine emissions within the Ports of Long Beach and Los Angeles in California, one of the largest ports in the U.S.⁵⁹ Like the earlier rail yard study, the port study employed the ISCST3 dispersion model. Using local meteorological data, annual average concentrations were substantially elevated over an area exceeding 200,000 acres. Because the ports are located near heavily-populated areas, the modeling indicated that over 700,000 people lived in areas with at least 0.3 $\mu\text{g}/\text{m}^3$ of port-related diesel PM in ambient air, about 360,000 people lived in areas with at least 0.6 $\mu\text{g}/\text{m}^3$ of diesel PM, and about 50,000 people lived in areas with at least 1.5 $\mu\text{g}/\text{m}^3$ of ambient diesel PM directly from the port. Most recently, CARB released several additional Railyard Health Risk Assessments which all show that diesel PM emissions result in significantly higher pollution risks in nearby communities.⁶⁰ Together these studies highlight the substantial contribution these facilities make to elevated ambient concentrations in populated areas.

As mentioned in section II.A of this preamble, EPA recently conducted an initial screening-level analysis of a representative selection of national marine port areas and rail yards to begin to better understand the populations that are exposed to DPM emissions from these facilities.^{61, 62} As part of this study,

⁵⁹ State of California Air Resources Board. Diesel Particulate Matter Exposure Assessment Study for the Ports of Los Angeles and Long Beach, April 2006. This document is available in Docket EPA-HQ-OAR-2003-0190. This document is available electronically at: <http://ftp.arb.ca.gov/carbis/msprog/offroad/marinevess/documents/portstudy0406.pdf>.

⁶⁰ These studies are available in Docket EPA-HQ-OAR-2003-0190. Studies are also available at <http://www.arb.ca.gov/railyard/hra/hra.htm>.

⁶¹ ICF International. September 28, 2007. Estimation of diesel particulate matter concentration isopleths for marine harbor areas and rail yards. Memorandum to EPA under Work Assignment Number 0-3, Contract Number EP-C-06-094. This memo is available in Docket EPA-HQ-OAR-2003-0190.

⁶² ICF International. September 28, 2007. Estimation of diesel particulate matter population exposure near selected harbor areas and rail yards.

a computer geographic information system (GIS) was used to identify the locations and property boundaries of 47 marine ports and 37 rail yard facilities.⁶³ Census information was used to estimate the size and demographic characteristics of the population living in the vicinity of the ports and rail yards. The results indicate that at least 13 million people, including a disproportionate number of low-income, African-Americans, and Hispanics, live in the vicinity of these facilities and are being exposed to ambient DPM levels that are 2.0 $\mu\text{g}/\text{m}^3$ and 0.2 $\mu\text{g}/\text{m}^3$ above levels found in areas further from these facilities. These populations will benefit from the controls being finalized in this action. This study is discussed in greater detail in chapter 2 of the RIA and detailed findings of this study are available in the public docket for this rulemaking.

(b) Other Air Toxics—benzene, 1,3-butadiene, formaldehyde, acetaldehyde, acrolein, POM, naphthalene

Locomotive and marine diesel engine exhaust emissions also contribute to ambient levels of other air toxics known or suspected as human or animal carcinogens, or that have noncancer health effects. These other air toxics include benzene, 1,3-butadiene, formaldehyde, acetaldehyde, acrolein, polycyclic organic matter (POM), and naphthalene. All of these compounds, except acetaldehyde, were identified as national or regional cancer risk or noncancer hazard drivers in the 1999 National-Scale Air Toxics Assessment (NATA) and have significant inventory contributions from mobile sources. That is, for a significant portion of the population, these compounds pose a significant portion of the total cancer and noncancer risk from breathing outdoor air toxics. The reductions in locomotive and marine diesel engine emissions finalized in this rulemaking will help reduce exposure to these harmful substances.

Benzene: EPA has characterized benzene as a known human carcinogen (causing leukemia) by all routes of exposure, and concludes that exposure is associated with additional health effects, including genetic changes in both humans and animals and increased proliferation of bone marrow cells in

Memorandum to EPA under Work Assignment Number 0-3, Contract Number EP-C-06-094. This memo is available in Docket EPA-HQ-OAR-2003-0190.

⁶³ The Agency selected a representative sample of the top 150 U.S. ports including coastal, inland, and Great Lake ports. In selecting a sample of rail yards the Agency identified a subset from the hundreds of rail yards operated by Class I Railroads.

⁵⁷ Diesel HAD Page 2-110, 8-12; Woskie, SR; Smith, TJ; Hammond, SK; et al. (1988a) Estimation of the DE exposures of railroad workers: II. National and historical exposures. Am J Ind Med 12:381-394.

⁵⁸ Hand, R.; Pingkuan, D.; Servin, A.; Hunsaker, L.; Suer, C. (2004) Roseville rail yard study. California Air Resources Board. [Online at <http://www.arb.ca.gov/diesel/documents/rstudy.htm>] This document can be found in Docket EPA-HQ-OAR-2003-0190.

mice.^{64, 65, 66} EPA states in its IRIS database that data indicate a causal relationship between benzene exposure and acute lymphocytic leukemia and suggests a relationship between benzene exposure and chronic non-lymphocytic leukemia and chronic lymphocytic leukemia. The IARC has determined that benzene is a human carcinogen and the U.S. DHHS has characterized benzene as a known human carcinogen.^{67, 68}

A number of adverse noncancer health effects including blood disorders, such as preleukemia and aplastic anemia, have also been associated with long-term exposure to benzene.^{69, 70} The most sensitive noncancer effect observed in humans, based on current data, is the depression of the absolute lymphocyte count in blood.^{71, 72} In addition, recent work, including studies sponsored by the Health Effects Institute (HEI), provides evidence that biochemical responses are occurring at lower levels of benzene exposure than previously known.^{73, 74, 75, 76} EPA's IRIS

⁶⁴ U.S. EPA. 2000. Integrated Risk Information System File for Benzene. This material is available electronically at <http://www.epa.gov/iris/subst/0276.htm>.

⁶⁵ International Agency for Research on Cancer (IARC). 1982. Monographs on the evaluation of carcinogenic risk of chemicals to humans, Volume 29, Some industrial chemicals and dyestuffs, World Health Organization, Lyon, France, p. 345–389.

⁶⁶ Irons, R.D.; Stillman, W.S.; Colagiovanni, D.B.; Henry, V.A. 1992. Synergistic action of the benzene metabolite hydroquinone on myelopoietic stimulating activity of granulocyte/macrophage colony-stimulating factor in vitro, *Proc. Natl. Acad. Sci.* 89:3691–3695.

⁶⁷ International Agency for Research on Cancer (IARC). 1987. Monographs on the evaluation of carcinogenic risk of chemicals to humans, Volume 29, Supplement 7, Some industrial chemicals and dyestuffs, World Health Organization, Lyon, France.

⁶⁸ U.S. Department of Health and Human Services National Toxicology Program 11th Report on Carcinogens available at: <http://ntp.niehs.nih.gov/go/16183>.

⁶⁹ Aksoy, M. (1989). Hematotoxicity and carcinogenicity of benzene. *Environ. Health Perspect.* 82: 193–197.

⁷⁰ Goldstein, B.D. (1988). Benzene toxicity. *Occupational medicine. State of the Art Reviews.* 3: 541–554.

⁷¹ Rothman, N., G.L. Li, M. Dosemeci, W.E. Bechtold, G.E. Marti, Y.Z. Wang, M. Linet, L.Q. Xi, W. Lu, M.T. Smith, N. Titenko-Holland, L.P. Zhang, W. Blot, S.N. Yin, and R.B. Hayes (1996) Hematotoxicity among Chinese workers heavily exposed to benzene. *Am. J. Ind. Med.* 29: 236–246.

⁷² U.S. EPA (2002) Toxicological Review of Benzene (Noncancer Effects). Environmental Protection Agency, Integrated Risk Information System (IRIS), Research and Development, National Center for Environmental Assessment, Washington DC. This material is available electronically at <http://www.epa.gov/iris/subst/0276.htm>.

⁷³ Qu, O.; Shore, R.; Li, G.; Jin, X.; Chen, C.L.; Cohen, B.; Melikian, A.; Eastmond, D.; Rappaport, S.; Li, H.; Rupa, D.; Suramaya, R.; Songnian, W.; Huifant, Y.; Meng, M.; Winnik, M.; Kwok, E.; Li, Y.; Mu, R.; Xu, B.; Zhang, X.; Li, K. (2003) HEI Report 115, Validation & Evaluation of Biomarkers in Workers Exposed to Benzene in China.

program has not yet evaluated these new data.

1,3-Butadiene: EPA has characterized 1,3-butadiene as carcinogenic to humans by inhalation.^{77, 78} The IARC has determined that 1, 3-butadiene is a human carcinogen and the U.S. DHHS has characterized 1,3-butadiene as a known human carcinogen.^{79, 80} There are numerous studies consistently demonstrating that 1,3-butadiene is metabolized into genotoxic metabolites by experimental animals and humans. The specific mechanisms of 1,3-butadiene-induced carcinogenesis are unknown; however, the scientific evidence strongly suggests that the carcinogenic effects are mediated by genotoxic metabolites. Animal data suggest that females may be more sensitive than males for cancer effects associated with 1,3-butadiene exposure; while there are insufficient data in humans from which to draw conclusions about sensitive subpopulations.

1,3-Butadiene also causes a variety of reproductive and developmental effects in mice; no human data on these effects are available. The most sensitive effect was ovarian atrophy observed in a lifetime bioassay of female mice.⁸¹

Formaldehyde: Since 1987, EPA has classified formaldehyde as a probable human carcinogen based on evidence in

⁷⁴ Qu, Q., R. Shore, G. Li, X. Jin, L.C. Chen, B. Cohen, et al. (2002) Hematological changes among Chinese workers with a broad range of benzene exposures. *Am. J. Industr. Med.* 42: 275–285.

⁷⁵ Lan, Qing, Zhang, L., Li, G., Vermeulen, R., et al. (2004) Hematotoxicity in Workers Exposed to Low Levels of Benzene. *Science* 306: 1774–1776.

⁷⁶ Turteltaub, K.W. and Mani, C. (2003) Benzene metabolism in rodents at doses relevant to human exposure from Urban Air. Research Reports Health Effect Inst. Report No.113.

⁷⁷ U.S. EPA (2002) Health Assessment of 1,3-Butadiene. Office of Research and Development, National Center for Environmental Assessment, Washington Office, Washington, DC. Report No. EPA600-P-98-001F. This document is available electronically at <http://www.epa.gov/iris/supdocs/buta-sup.pdf>.

⁷⁸ U.S. EPA (2002) Full IRIS Summary for 1,3-butadiene (CASRN 106–99–0). Environmental Protection Agency, Integrated Risk Information System (IRIS), Research and Development, National Center for Environmental Assessment, Washington, DC <http://www.epa.gov/iris/subst/0139.htm>.

⁷⁹ International Agency for Research on Cancer (IARC) (1999) Monographs on the evaluation of carcinogenic risk of chemicals to humans, Volume 71, Re-evaluation of some organic chemicals, hydrazine and hydrogen peroxide and Volume 97 (in preparation), World Health Organization, Lyon, France.

⁸⁰ U.S. Department of Health and Human Services (2005) National Toxicology Program 11th Report on Carcinogens available at: ntp.niehs.nih.gov/index.cfm?objectid=32BA9724-F1F6-975E-7FCE50709CB4C932.

⁸¹ Bevan, C.; Stadler, J.C.; Elliot, G.S.; et al. (1996) Subchronic toxicity of 4-vinylcyclohexene in rats and mice by inhalation. *Fundam. Appl. Toxicol.* 32:1–10.

humans and in rats, mice, hamsters, and monkeys.⁸² EPA is currently reviewing recently published epidemiological data. For instance, research conducted by the National Cancer Institute (NCI) found an increased risk of nasopharyngeal cancer and lymphohematopoietic malignancies such as leukemia among workers exposed to formaldehyde.^{83, 84} NCI is currently updating these studies. A recent National Institute of Occupational Safety and Health (NIOSH) study of garment workers also found increased risk of death due to leukemia among workers exposed to formaldehyde.⁸⁵ Extended follow-up of a cohort of British chemical workers did not find evidence of an increase in nasopharyngeal or lymphohematopoietic cancers, but a continuing statistically significant excess in lung cancers was reported.⁸⁶ Recently, the IARC re-classified formaldehyde as a human carcinogen (Group 1).⁸⁷

Formaldehyde exposure also causes a range of noncancer health effects, including irritation of the eyes (burning and watering of the eyes), nose and throat. Decreased pulmonary function has been observed in humans. Effects from repeated exposure in humans include respiratory tract irritation, chronic bronchitis and nasal epithelial lesions.⁸⁸

Acetaldehyde: EPA has characterized acetaldehyde as a probable human carcinogen, based on nasal tumors in rats.⁸⁹ Acetaldehyde is reasonably

⁸² U.S. EPA (1987) Assessment of Health Risks to Garment Workers and Certain Home Residents from Exposure to Formaldehyde. Office of Pesticides and Toxic Substances, April 1987.

⁸³ Hauptmann, M.; Lubin, J.H.; Stewart, P.A.; Hayes, R.B.; Blair, A. 2003. Mortality from lymphohematopoietic malignancies among workers in formaldehyde industries. *Journal of the National Cancer Institute* 95: 1615–1623.

⁸⁴ Hauptmann, M.; Lubin, J.H.; Stewart, P.A.; Hayes, R.B.; Blair, A. 2004. Mortality from solid cancers among workers in formaldehyde industries. *American Journal of Epidemiology* 159: 1117–1130.

⁸⁵ Pinkerton, L.E. 2004. Mortality among a cohort of garment workers exposed to formaldehyde: an update. *Occup. Environ. Med.* 61: 193–200.

⁸⁶ Coggon, D., EC Harris, J Poole, KT Palmer. 2003. Extended follow-up of a cohort of British chemical workers exposed to formaldehyde. *J National Cancer Inst.* 95:1608–1615.

⁸⁷ International Agency for Research on Cancer (IARC). 2006. Formaldehyde, 2-Butoxyethanol and 1-tert-Butoxypropan-2-ol. Volume 88. (in preparation), World Health Organization, Lyon, France.

⁸⁸ U.S. Department of Health and Human Services Agency for Toxic Substances and Disease Registry. 1999. Toxicological Profile for formaldehyde. Available at <http://www.atsdr.cdc.gov/toxprofiles/tp111.html>.

⁸⁹ U.S. EPA. 1991. Integrated Risk Information System File of Acetaldehyde. Research and Development, National Center for Environmental

anticipated to be a human carcinogen by the U.S. Department of Health and Human Services (DHHS) in the 11th Report on Carcinogens and is classified as possibly carcinogenic to humans (Group 2B) by the International Agency for Research on Carcinogens (IARC).^{90, 91} EPA is currently conducting a reassessment of cancer and noncancer risk from inhalation exposure to acetaldehyde.

The primary noncancer effects of exposure to acetaldehyde vapors include irritation of the eyes, skin, and respiratory tract.⁹² In short-term (4 week) rat studies, compound-related histopathological changes were observed only in the respiratory system at various concentration levels of exposure.^{93, 94} Data from these studies were used by EPA to develop an inhalation reference concentration. Some asthmatics have been shown to be a sensitive subpopulation to decrements in functional expiratory volume (FEV1 test) and bronchoconstriction upon acetaldehyde inhalation.⁹⁵

Acrolein: Acrolein is extremely acrid and irritating to humans when inhaled, with acute exposure resulting in upper respiratory tract irritation, mucus hypersecretion and congestion. Levels considerably lower than 1 ppm (2.3 mg/m³) elicit subjective complaints of eye and nasal irritation and a decrease in the respiratory rate.^{96, 97} Lesions to the

lungs and upper respiratory tract of rats, rabbits, and hamsters have been observed after subchronic exposure to acrolein. Based on animal data, individuals with compromised respiratory function (e.g., emphysema, asthma) are expected to be at increased risk of developing adverse responses to strong respiratory irritants such as acrolein. This was demonstrated in mice with allergic airway-disease by comparison to non-diseased mice in a study of the acute respiratory irritant effects of acrolein.⁹⁸ EPA is currently in the process of conducting an assessment of acute exposure effects for acrolein. The intense irritancy of this carbonyl has been demonstrated during controlled tests in human subjects who suffer intolerable eye and nasal mucosal sensory reactions within minutes of exposure.⁹⁹

EPA determined in 2003 that the human carcinogenic potential of acrolein could not be determined because the available data were inadequate. No information was available on the carcinogenic effects of acrolein in humans and the animal data provided inadequate evidence of carcinogenicity.¹⁰⁰ The IARC determined in 1995 that acrolein was not classifiable as to its carcinogenicity in humans.¹⁰¹

Polycyclic Organic Matter (POM): POM is generally defined as a large class of organic compounds which have multiple benzene rings and a boiling point greater than 100 degrees Celsius. Many of the compounds included in the class of compounds known as POM are classified by EPA as probable human carcinogens based on animal data. One of these compounds, naphthalene, is discussed separately below. Polycyclic aromatic hydrocarbons (PAHs) are a subset of POM that contain only hydrogen and carbon atoms. A number of PAHs are known or suspected carcinogens. Recent studies have found that maternal exposures to PAHs (a

subclass of POM) in a population of pregnant women were associated with several adverse birth outcomes, including low birth weight and reduced length at birth, as well as impaired cognitive development at age three.^{102, 103} EPA has not yet evaluated these recent studies.

Naphthalene: Naphthalene is found in small quantities in gasoline and diesel fuels but is primarily a product of combustion. EPA recently released an external review draft of a reassessment of the inhalation carcinogenicity of naphthalene.¹⁰⁴ The draft reassessment recently completed external peer review.¹⁰⁵ Based on external peer review comments received to date, additional analyses are being undertaken. This external review draft does not represent official agency opinion and was released solely for the purposes of external peer review and public comment. Once EPA evaluates public and peer reviewer comments, the document will be revised. The National Toxicology Program listed naphthalene as "reasonably anticipated to be a human carcinogen" in 2004 on the basis of bioassays reporting clear evidence of carcinogenicity in rats and some evidence of carcinogenicity in mice.¹⁰⁶ California EPA has released a new risk assessment for naphthalene, and the IARC has reevaluated naphthalene and re-classified it as Group 2B: Possibly carcinogenic to humans.¹⁰⁷ Naphthalene also causes a number of chronic non-cancer effects in animals, including

Assessment, Washington, DC. This material is available electronically at <http://www.epa.gov/iris/subst/0290.htm>.

⁹⁰ U.S. Department of Health and Human Services National Toxicology Program 11th Report on Carcinogens available at: ntp.niehs.nih.gov/index.cfm?objectid=32BA9724-F1F6-975E-7FCE50709CB4C932.

⁹¹ International Agency for Research on Cancer (IARC). 1999. Re-evaluation of some organic chemicals, hydrazine, and hydrogen peroxide. IARC Monographs on the Evaluation of Carcinogenic Risk of Chemical to Humans, Vol 71. Lyon, France.

⁹² U.S. EPA. 1991. Integrated Risk Information System File of Acetaldehyde. This material is available electronically at <http://www.epa.gov/iris/subst/0290.htm>.

⁹³ Appleman, L.M., R.A. Woutersen, V.J. Feron, R.N. Hooftman, and W.R.F. Notten. 1986. Effects of the variable versus fixed exposure levels on the toxicity of acetaldehyde in rats. *J. Appl. Toxicol.* 6: 331-336.

⁹⁴ Appleman, L.M., R.A. Woutersen, and V.J. Feron. 1982. Inhalation toxicity of acetaldehyde in rats. I. Acute and subacute studies. *Toxicology.* 23: 293-297.

⁹⁵ Myou, S.; Fujimura, M.; Nishi K.; Ohka, T.; and Matsuda, T. 1993. Aerosolized acetaldehyde induces histamine-mediated bronchoconstriction in asthmatics. *Am. Rev. Respir. Dis.* 148(4 Pt 1): 940-3.

⁹⁶ Weber-Tschopp, A; Fischer, T; Gierer, R; et al. (1977) Experimentelle reizwirkungen von Acrolein auf den Menschen. *Int Arch Occup Environ Hlth.* 40(2):117-130. In German.

⁹⁷ Sim, VM; Pattle, RE. (1957) Effect of possible smog irritants on human subjects. *J Am Med Assoc.* 165(15):1908-1913.

⁹⁸ Morris JB, Symanowicz PT, Olsen JE, et al. 2003. Immediate sensory nerve-mediated respiratory responses to irritants in healthy and allergic airway-diseased mice. *J Appl Physiol.* 94(4):1563-1571.

⁹⁹ Sim VM, Pattle RE. Effect of possible smog irritants on human subjects. *JAMA.* 165: 1980-2010, 1957.

¹⁰⁰ U.S. EPA. (2003). Integrated Risk Information System File of Acrolein. Research and Development, National Center for Environmental Assessment, Washington, DC. This material is available at <http://www.epa.gov/iris/subst/0364.htm>.

¹⁰¹ International Agency for Research on Cancer (IARC). 1995. Monographs on the evaluation of carcinogenic risk of chemicals to humans, Volume 63, Dry cleaning, some chlorinated solvents and other industrial chemicals. World Health Organization, Lyon, France.

¹⁰² Perera, F.P.; Rauh, V.; Tsai, W.-Y.; et al. (2002) Effect of transplacental exposure to environmental pollutants on birth outcomes in a multiethnic population. *Environ Health Perspect.* 111: 201-205.

¹⁰³ Perera, F.P.; Rauh, V.; Whyatt, R.M.; Tsai, W.Y.; Tang, D.; Diaz, D.; Hoepner, L.; Barr, D.; Tu, Y.H.; Camann, D.; Kinney, P. (2006) Effect of prenatal exposure to airborne polycyclic aromatic hydrocarbons on neurodevelopment in the first 3 years of life among inner-city children. *Environ Health Perspect.* 114: 1287-1292.

¹⁰⁴ U.S. EPA (2004) Toxicological Review of Naphthalene (Reassessment of the Inhalation Cancer Risk), Environmental Protection Agency, Integrated Risk Information System, Research and Development, National Center for Environmental Assessment, Washington, DC. This material is available electronically at <http://www.epa.gov/iris/subst/0436.htm>.

¹⁰⁵ Oak Ridge Institute for Science and Education (2004) External Peer Review for the IRIS Reassessment of the Inhalation Carcinogenicity of Naphthalene. August 2004. <http://cfpub.epa.gov/ncce/cfm/recordisplay.cfm?deid=84403>.

¹⁰⁶ National Toxicology Program (NTP). (2004). 11th Report on Carcinogens. Public Health Service, U.S. Department of Health and Human Services, Research Triangle Park, NC. Available from: <http://ntp-server.niehs.nih.gov>.

¹⁰⁷ International Agency for Research on Cancer (IARC) (2002) Monographs on the Evaluation of the Carcinogenic Risk of Chemicals for Humans. Vol. 82. Lyon, France.

abnormal cell changes and growth in respiratory and nasal tissues.¹⁰⁸

C. Environmental Impacts

There are a number of public welfare effects associated with the presence of ozone, NO_x and PM_{2.5} in the ambient air. In this section we discuss visibility, the impact of deposition on ecosystems and materials, and the impact of ozone on plants, including trees, agronomic crops and urban ornamentals.

(1) Visibility

Visibility can be defined as the degree to which the atmosphere is transparent to visible light. Airborne particles degrade visibility by scattering and absorbing light. Visibility is important because it has direct significance to people's enjoyment of daily activities in all parts of the country. Individuals value good visibility for the well-being it provides them directly, where they live and work and in places where they enjoy recreational opportunities. Visibility is also highly valued in significant natural areas such as national parks and wilderness areas and special emphasis is given to protecting visibility in these areas. For more information on visibility, see the final 2004 PM AQCD as well as the 2005 PM Staff Paper.^{109, 110}

EPA is pursuing a two-part strategy to address visibility. First, to address the welfare effects of PM on visibility, EPA has set secondary PM_{2.5} standards which act in conjunction with the establishment of a regional haze program. In setting this secondary standard, EPA has concluded that PM_{2.5} causes adverse effects on visibility in various locations, depending on PM concentrations and factors such as chemical composition and average relative humidity. Second, section 169 of the Clean Air Act provides additional authority to address existing visibility impairment and prevent future visibility impairment in the 156 national parks, forests and wilderness areas categorized as mandatory class I federal areas (62 FR

38680–81, July 18, 1997).¹¹¹ In July 1999, the regional haze rule (64 FR 35714) was put in place to protect the visibility in mandatory class I federal areas. Visibility can be said to be impaired in both PM_{2.5} nonattainment areas and mandatory class I federal areas.

Locomotives and marine engines contribute to visibility concerns in these areas through their primary PM_{2.5} emissions and their NO_x emissions which contribute to the formation of secondary PM_{2.5}.

Current Visibility Impairment

As of October 10, 2007, almost 90 million people live in nonattainment areas for the 1997 PM_{2.5} NAAQS. These populations, as well as large numbers of individuals who travel to these areas, are likely to experience visibility impairment. In addition, while visibility trends have improved in mandatory class I federal areas the most recent data show that these areas continue to suffer from visibility impairment.¹¹² In summary, visibility impairment is experienced throughout the U.S., in multi-state regions, urban areas, and remote mandatory class I federal areas.^{113, 114}

Future Visibility Impairment

Air quality modeling conducted for this final rule was used to project visibility conditions in 133 mandatory class I federal areas across the U.S. in 2020 and 2030. The results indicate that improvement in visibility will occur in all mandatory class I federal areas although all areas will continue to have annual average deciview levels above background in 2020 and 2030. Chapter 2 of the RIA contains more detail on the visibility portion of the air quality modeling.

(2) Plant and Ecosystem Effects of Ozone

Elevated ozone levels contribute to environmental effects, with impacts to plants and ecosystems being of most concern. Ozone can produce both acute and chronic injury in sensitive species

depending on the concentration level and the duration of the exposure. Ozone effects also tend to accumulate over the growing season of the plant, so that even low concentrations experienced for a longer duration have the potential to create chronic stress on vegetation. Ozone damage to plants includes visible injury to leaves and a reduction in food production through impaired photosynthesis, both of which can lead to reduced crop yields, forestry production, and use of sensitive ornamentals in landscaping. In addition, the reduced food production in plants and subsequent reduced root growth and storage below ground, can result in other, more subtle plant and ecosystems impacts. These include increased susceptibility of plants to insect attack, disease, harsh weather, interspecies competition and overall decreased plant vigor. The adverse effects of ozone on forest and other natural vegetation can potentially lead to species shifts and loss from the affected ecosystems, resulting in a loss or reduction in associated ecosystem goods and services. Lastly, visible ozone injury to leaves can result in a loss of aesthetic value in areas of special scenic significance like national parks and wilderness areas. The final 2006 Criteria Document presents more detailed information on ozone effects on vegetation and ecosystems.

As discussed above, locomotive and marine diesel engine emissions of NO_x contribute to ozone and therefore the NO_x standards will help reduce crop damage and stress on vegetation from ozone.

(3) Atmospheric Deposition

Wet and dry deposition of ambient particulate matter delivers a complex mixture of metals (e.g., mercury, zinc, lead, nickel, aluminum, cadmium), organic compounds (e.g., POM, dioxins, furans) and inorganic compounds (e.g., nitrate, sulfate) to terrestrial and aquatic ecosystems. The chemical form of the compounds deposited is impacted by a variety of factors including ambient conditions (e.g., temperature, humidity, oxidant levels) and the sources of the material. Chemical and physical transformations of the particulate compounds occur in the atmosphere as well as the media onto which they deposit. These transformations in turn influence the fate, bioavailability and potential toxicity of these compounds. Atmospheric deposition has been identified as a key component of the environmental and human health

¹⁰⁸ U.S. EPA (1998) Toxicological Review of Naphthalene, Environmental Protection Agency, Integrated Risk Information System, Research and Development, National Center for Environmental Assessment, Washington, DC. This material is available electronically at <http://www.epa.gov/iris/subst/0436.htm>.

¹⁰⁹ U.S. EPA (2004) Air Quality Criteria for Particulate Matter (Oct 2004), Volume I Document No. EPA600/P-99/002aF and Volume II Document No. EPA600/P-99/002bF. This document is available in Docket EPA-HQ-OAR-2003-0190.

¹¹⁰ U.S. EPA (2005) Review of the National Ambient Air Quality Standard for Particulate Matter: Policy Assessment of Scientific and Technical Information, OAQPS Staff Paper. EPA-452/R-05-005. This document is available in Docket EPA-HQ-OAR-2003-0190.

¹¹¹ These areas are defined in section 162 of the Act as those national parks exceeding 6,000 acres, wilderness areas and memorial parks exceeding 5,000 acres, and all international parks which were in existence on August 7, 1977.

¹¹² U.S. EPA (2002). Latest Findings on National Air Quality—2002 Status and Trends. EPA 454/K-03-001.

¹¹³ U.S. EPA. Air Quality Designations and Classifications for the Fine Particles (PM_{2.5}) National Ambient Air Quality Standards, December 17, 2004. (70 FR 943, Jan 5, 2005) This document is also available on the Web at: <http://www.epa.gov/pmdesignations/>.

¹¹⁴ U.S. EPA. Regional Haze Regulations, July 1, 1999. (64 FR 35714, July 1, 1999).

hazard posed by several pollutants including mercury, dioxin and PCBs.¹¹⁵

Adverse impacts on water quality can occur when atmospheric contaminants deposit to the water surface or when material deposited on the land enters a water body through runoff. Potential impacts of atmospheric deposition to water bodies include those related to both nutrient and toxic inputs. Adverse effects to human health and welfare can occur from the addition of excess particulate nitrate nutrient enrichment, which contributes to toxic algae blooms and zones of depleted oxygen, which can lead to fish kills, frequently in coastal waters. Particles contaminated with heavy metals or other toxins may lead to the ingestion of contaminated fish, ingestion of contaminated water, damage to the marine ecology, and limited recreational uses. Several studies have been conducted in U.S. coastal waters and in the Great Lakes Region in which the role of ambient PM deposition and runoff is investigated.^{116, 117, 118, 119, 120}

Adverse impacts on soil chemistry and plant life have been observed for areas heavily impacted by atmospheric deposition of nutrients, metals and acid species, resulting in species shifts, loss of biodiversity, forest decline and damage to forest productivity. Potential impacts also include adverse effects to human health through ingestion of contaminated vegetation or livestock (as in the case for dioxin deposition), reduction in crop yield, and limited use of land due to contamination.

The NO_x, VOC and PM standards finalized in this action will help reduce the environmental impacts of atmospheric deposition.

¹¹⁵ U.S. EPA (2000). Deposition of Air Pollutants to the Great Waters: Third Report to Congress. Office of Air Quality Planning and Standards. EPA-453/R-00-0005. This document is available in Docket EPA-HQ-OAR-2003-0190.

¹¹⁶ U.S. EPA (2004). National Coastal Condition Report II. Office of Research and Development/Office of Water. EPA-620/R-03/002. This document is available in Docket EPA-HQ-OAR-2003-0190.

¹¹⁷ Gao, Y., E.D. Nelson, M.P. Field, et al. 2002. Characterization of atmospheric trace elements on PM_{2.5} particulate matter over the New York-New Jersey harbor estuary. *Atmos. Environ.* 36: 1077-1086.

¹¹⁸ Kim, G., N. Hussain, J.R. Scudlark, and T.M. Church. 2000. Factors influencing the atmospheric depositional fluxes of stable Pb, 210Pb, and 7Be into Chesapeake Bay. *J. Atmos. Chem.* 36: 65-79.

¹¹⁹ Lu, R., R.P. Turco, K. Stolzenbach, et al. 2003. Dry deposition of airborne trace metals on the Los Angeles Basin and adjacent coastal waters. *J. Geophys. Res.* 108(D2, 4074): AAC 11-1 to 11-24.

¹²⁰ Marvin, C.H., M.N. Charlton, E.J. Reiner, et al. 2002. Surficial sediment contamination in Lakes Erie and Ontario: A comparative analysis. *J. Great Lakes Res.* 28(3): 437-450.

(4) Materials Damage and Soiling

The deposition of airborne particles can reduce the aesthetic appeal of buildings and culturally important articles through soiling, and can contribute directly (or in conjunction with other pollutants) to structural damage by means of corrosion or erosion.¹²¹ Particles affect materials principally by promoting and accelerating the corrosion of metals, by degrading paints, and by deteriorating building materials such as concrete and limestone. Particles contribute to these effects because of their electrolytic, hygroscopic, and acidic properties, and their ability to adsorb corrosive gases (principally sulfur dioxide). The rate of metal corrosion depends on a number of factors, including the deposition rate and nature of the pollutant; the influence of the metal protective corrosion film; the amount of moisture present; variability in the electrochemical reactions; the presence and concentration of other surface electrolytes; and the orientation of the metal surface.

The PM_{2.5} standards finalized in this action will help reduce the airborne particles that contribute to materials damage and soiling.

D. Other Criteria Pollutants Affected by This Final Rule

Locomotive and marine diesel engines account for about 1 percent of the mobile source carbon monoxide (CO) inventory. Carbon monoxide (CO) is a colorless, odorless gas produced through the incomplete combustion of carbon-based fuels. The current primary NAAQS for CO are 35 ppm for the 1-hour average and 9 ppm for the 8-hour average. These values are not to be exceeded more than once per year. As of October 10, 2007, there are 854 thousand people living in 4 areas (made up of 5 counties) that are designated as nonattainment for CO.

Carbon monoxide enters the bloodstream through the lungs, forming carboxyhemoglobin and reducing the delivery of oxygen to the body's organs and tissues. The health threat from CO is most serious for those who suffer from cardiovascular disease, particularly those with angina or peripheral vascular disease. Healthy individuals also are affected, but only at higher CO levels. Exposure to elevated CO levels is associated with impairment

¹²¹ U.S. EPA (2005). Review of the National Ambient Air Quality Standards for Particulate Matter: Policy Assessment of Scientific and Technical Information. OAQPS Staff Paper. This document is available in Docket EPA-HQ-OAR-2003-0190.

of visual perception, work capacity, manual dexterity, learning ability and performance of complex tasks. Carbon monoxide also contributes to ozone nonattainment since carbon monoxide reacts photochemically in the atmosphere to form ozone. Additional information on CO related health effects can be found in the Air Quality Criteria for Carbon Monoxide.¹²²

E. Emissions from Locomotive and Marine Diesel Engines

(1) Overview

The engine standards in this final rule will affect emissions of PM_{2.5}, NO_x, VOCs, CO, and air toxics for locomotive and marine diesel engines. Based on our analysis for this rulemaking, we estimate that in 2001 locomotive and marine diesel engines contributed almost 60,000 tons (18 percent) to the national mobile source diesel PM_{2.5} inventory and about 2.0 million tons (16 percent) to the mobile source NO_x inventory. In 2030, absent the standards finalized today, these engines will contribute about 50,000 tons (65 percent) to the mobile source diesel PM_{2.5} inventory and almost 1.6 million tons (35 percent) to the mobile source NO_x inventory. Under today's final standards, by 2030, annual NO_x emissions from these engines will be reduced by 800,000 tons, PM_{2.5} emissions by 27,000 tons, and VOC emissions by 43,000 tons.

Locomotive and marine diesel engine emissions are expected to continue to be a significant part of the mobile source emissions inventory, both nationally and in ozone and PM_{2.5} nonattainment areas, in the coming years. Absent the standards finalized today, we expect overall emissions from these engines to decrease modestly over the next ten to fifteen years then remain relatively flat through 2025 due to existing regulations such as lower fuel sulfur requirements, the phase-in of locomotive and marine diesel Tier 1 and Tier 2 engine standards, and the current Tier 0 locomotive remanufacturing requirements. Starting after 2025, emission inventories from these engines once again begin increasing due to growth in the locomotive and marine sectors, see Table II-2.

Each sub-section below discusses one of the affected pollutants, including expected emissions reductions associated with the final standards. Table II-2 summarizes the impacts of this rule for 2012, 2015, 2020, 2030 and

¹²² U.S. EPA (2000). Air Quality Criteria for Carbon Monoxide, EPA/600/P-99/001F. This document is available in Docket EPA-HQ-OAR-2003-0190.

2040. Further details on our inventory estimates are available in chapter 3 of the RIA.

BILLING CODE 6560-50-P

Table II- 2 Estimated National (50 State) Reductions in Emissions from Locomotive and Marine Diesel Engines

Pollutant [short tons]	2012	2015	2020	2030	2040
Direct PM_{2.5}					
PM _{2.5} Emissions Without Rule	53,000	48,000	46,000	46,000	49,000
PM _{2.5} Emissions with Rule	49,000	41,000	32,000	20,000	13,000
PM _{2.5} Reductions Resulting from Rule	4,000	7,000	14,000	27,000	37,000
NO_x					
NO _x Emissions Without Rule	1,678,000	1,635,000	1,584,000	1,584,000	1,708,000
NO _x Emissions with Rule	1,591,000	1,474,000	1,213,000	790,000	564,000
NO _x Reductions Resulting from Rule	87,000	161,000	371,000	795,000	1,144,000
VOC					
VOC Emissions Without Rule	71,000	70,000	70,000	71,000	76,000
VOC Emissions with Rule	63,000	55,000	42,000	28,000	21,000
VOC Reductions Resulting from Rule	8,000	15,000	28,000	43,000	55,000

BILLING CODE 6560-50-C

(2) PM_{2.5} Emission Reductions

As described earlier, EPA believes that reductions of diesel PM_{2.5} emissions are an important part of the nation's progress toward clean air. PM_{2.5} reductions resulting from this final rule will reduce hazardous air pollutants or air toxics from these engines, reduce diesel exhaust exposure in communities near these emissions sources, and help areas address visibility and other environmental impacts associated with PM_{2.5} emissions.

In 2001, annual emissions from locomotive and marine diesel engines totaled about 60,000 tons (18 percent) of the national mobile source diesel PM_{2.5} inventory and by 2030 these engines, absent this final rule, contribute about 50,000 tons (65 percent) of the mobile source diesel PM_{2.5} inventory. Both Table II-2 and Figure II-2 show that PM_{2.5} emissions are relatively flat through 2030 before beginning to rise again due to growth in these sectors.

Table II-2 and Figure II-2 present PM_{2.5} emission reductions from

locomotive and marine diesel engines with the final standards required in this rule. Emissions of PM_{2.5} drop in 2012 and 2015 by 4,200 and 7,300 tons respectively. By 2020, annual PM_{2.5} reductions total 14,500 tons and by 2030 emissions are reduced further by 27,000 tons annually. Significant reductions from these engines continue through 2040 when approximately 37,000 tons of PM_{2.5} are annually eliminated as a result of this rule.

BILLING CODE 6560-50-P

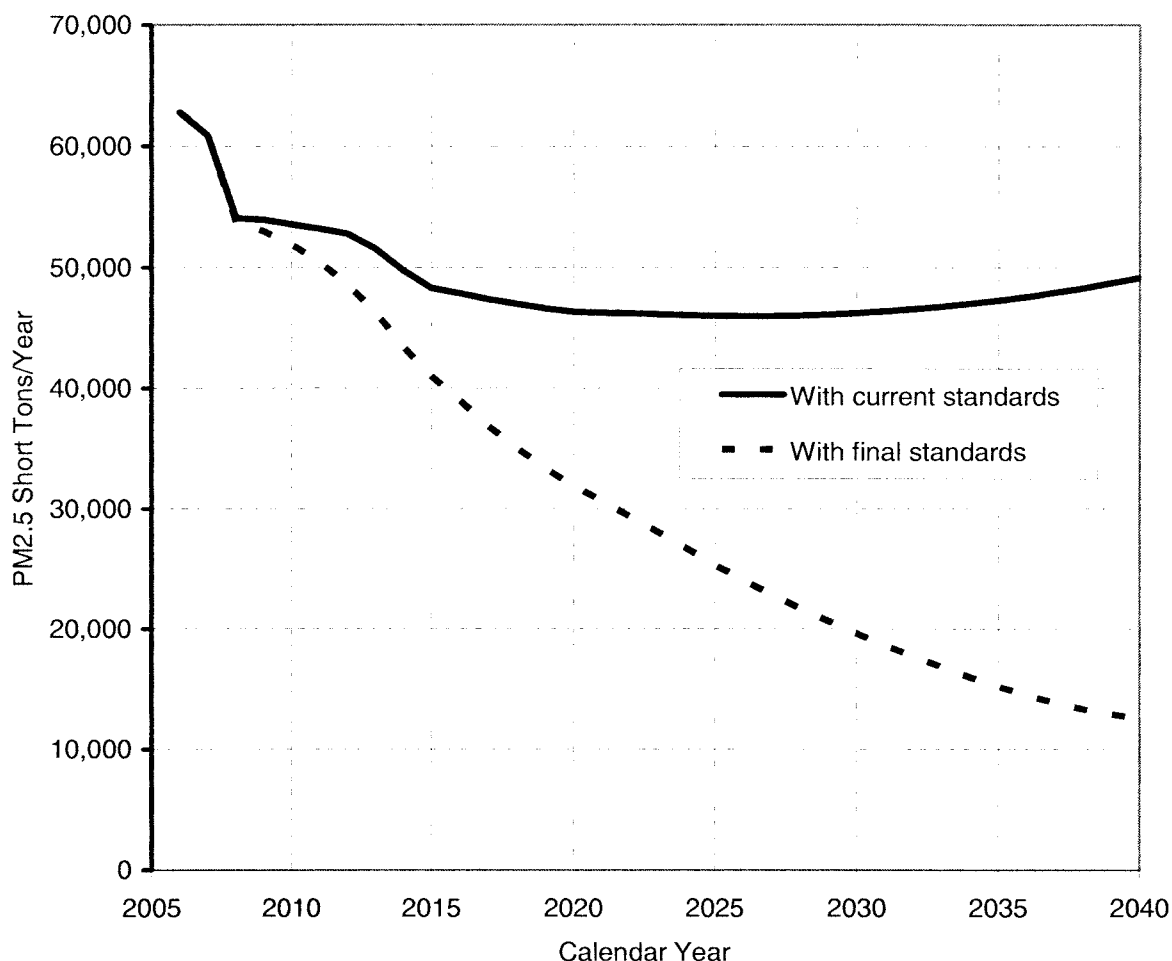
Figure II-2 PM_{2.5} Reductions from Final Rule

BILLING CODE 6560-50-C

(3) NO_x Emissions Reductions

In 2001 annual emissions from locomotive and marine diesel engines totaled about 2.0 million tons. Due to earlier engine standards for these engines, annual NO_x emissions drop to approximately 1.6 million tons in 2030. Both Table II-2 and Figure II-3 show NO_x emissions remaining fairly flat through 2030 before beginning to rise again due to growth in these sectors.

As shown in Table II-2 and Figure II-3, in the near term this rule reduces annual NO_x emissions from the current national inventory baseline by 87,000 tons in 2012 and 161,000 tons in 2015. By 2020, annual NO_x emissions are cut by 371,000 tons and by 2030—795,000 tons are eliminated. As with PM_{2.5} emissions, a yearly decline in NO_x emissions continues through 2040 when more than 1.1 million tons of NO_x are annually reduced from locomotive and marine diesel engines.

These numbers are comparable to emission reductions projected in 2030 for our already established Clean Air Nonroad Diesel (CAND) program. Table II-3 provides the 2030 NO_x emission reductions (and PM reductions) for this rule compared to the Heavy-Duty Highway rule and CAND rule. The 2030 NO_x reductions of about 738,000 tons for the CAND rule are slightly less than those from this rule.

BILLING CODE 6560-50-P

Figure II-3 NO_x Reductions from Rule

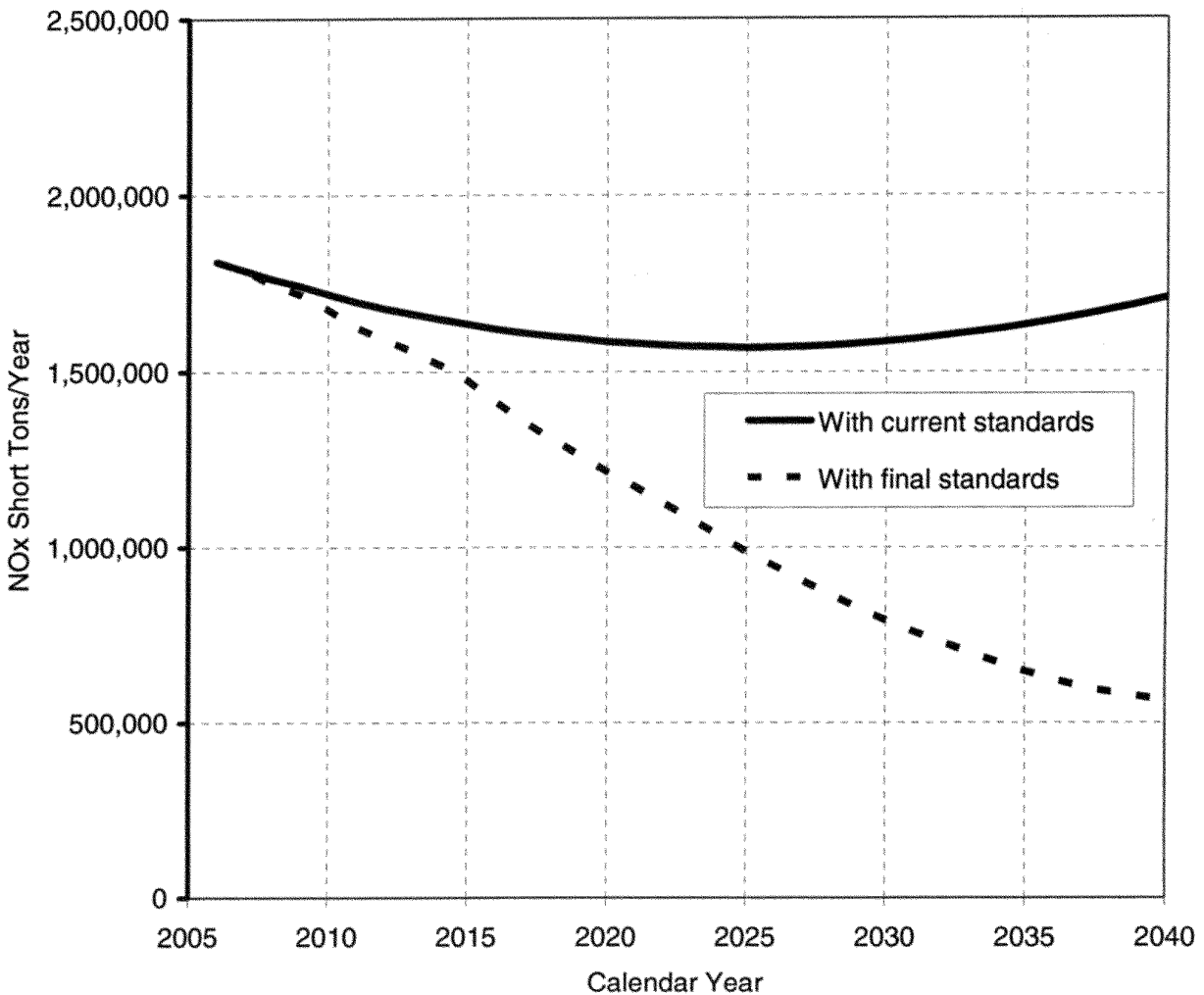

BILLING CODE 6560-50-C

TABLE II-3.—PROJECTED 2030 EMISSIONS REDUCTIONS FROM RECENT MOBILE SOURCE RULES [Short tons]

Rule	NO _x	PM _{2.5}
Locomotive and Marine	795,000	27,000
Clean Air Nonroad Diesel	738,000	129,000
Heavy-Duty Highway	2,600,000	109,000

(4) Volatile Organic Compounds Emissions Reductions

Emissions of volatile organic compounds (VOCs) from locomotive and marine diesel engines are shown in Table II-2, along with the estimates of the reductions we expect from the HC standard in our rule in 2012, 2015, 2020, 2030 and 2040. In 2012, 8,000 tons of VOCs are reduced and in 2015 15,000 tons are annually eliminated from the inventory. By 2020, reductions will expand to 28,000 tons annually from these engines. Over the next ten years, annual reductions from

controlled locomotive and marine diesel engines will produce annual VOC reductions of 43,000 tons in 2030 and 55,000 tons in 2040. Figure II-4 shows our estimate of VOC emissions between 2006 and 2040 both with and without this rule.

BILLING CODE 6560-50-P

Figure II-4 VOC Reductions from Rule

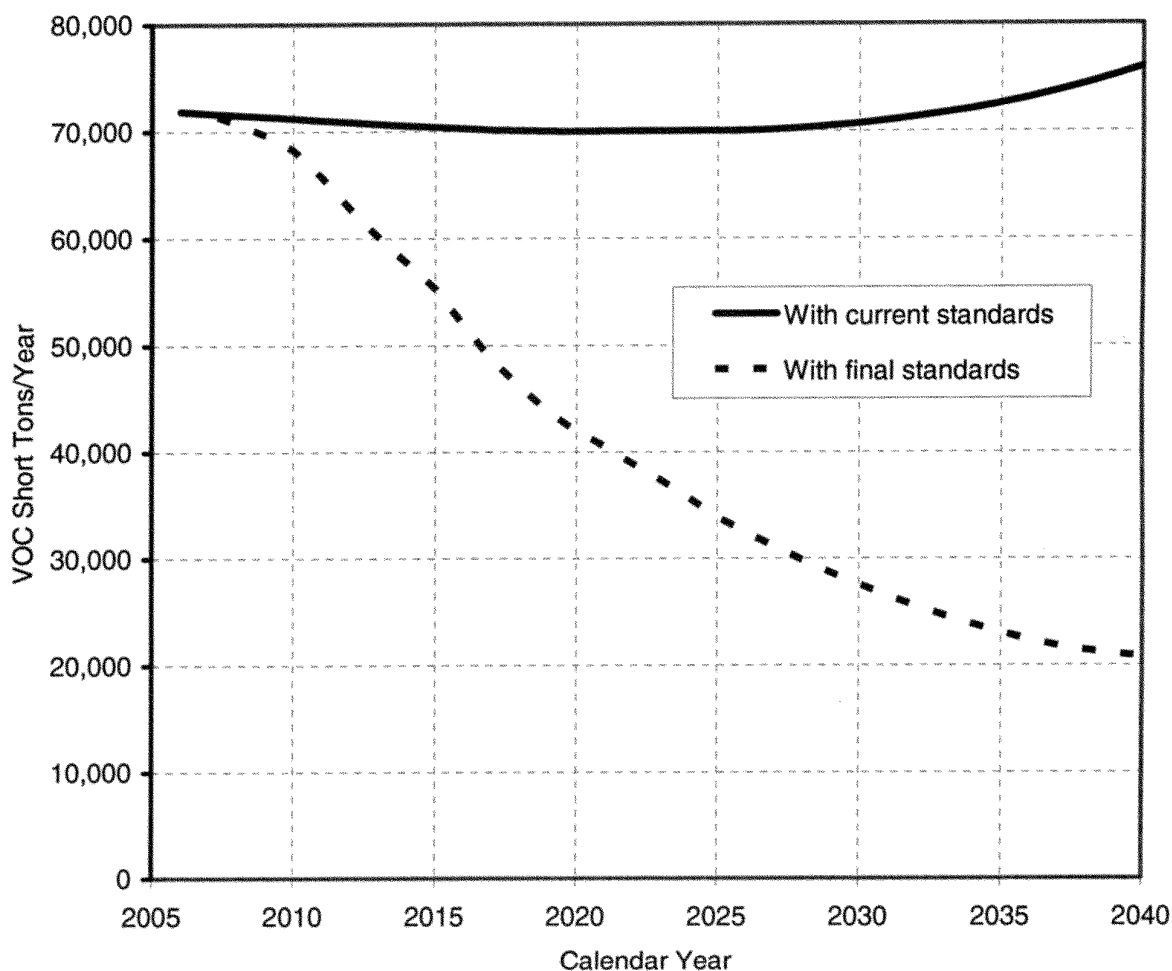

BILLING CODE 6560-50-C

III. Emission Standards

This section details the emission standards, implementation dates, and other major requirements of the new program. Following brief summaries of the types of locomotives and marine engines covered, we describe the provisions for:

- Standards for remanufactured Tier 0, 1, and 2 locomotives,
- Tier 3 and Tier 4 standards for newly-built line-haul locomotives,
- Standards and other provisions for switch locomotives,
- Requirements to reduce idling locomotive emissions,
- Tier 3 and Tier 4 standards for newly-built marine diesel engines, and
- Standards for remanufactured marine diesel engines.

An assessment of the technological feasibility of the standards follows the program description. To ensure that the benefits of the standards are realized throughout the useful life of these engines, and to incorporate lessons learned over the last few years from the existing test and compliance programs, we are also revising test procedures and related certification requirements, and adding comparable provisions for remanufactured marine diesel engines. These are described in section IV.

A. What Locomotives and Marine Engines Are Covered?

The regulations being adopted affect locomotives currently regulated under part 92 and marine diesel engines and vessels currently regulated under parts

89, 1039, and 94, as described below.¹²³ In addition, they apply to existing marine diesel engines above 600 kW (800 hp).

With some exceptions, the locomotive regulations apply for all locomotives originally built in or after 1973 that operate extensively within the United States. See section IV.B for a discussion of the exemption for locomotives that are used only incidentally within the U.S. The exceptions include historic steam-powered locomotives and locomotives powered solely by an external source of electricity. In addition, the regulations generally do not apply to some existing locomotives owned by small businesses. Furthermore, engines used in

¹²³ All of the regulatory parts referenced in this preamble are parts in Title 40 of the Code of Federal Regulations, unless otherwise noted.

locomotive-type vehicles with less than 750 kW (1006 hp) total power (used primarily for railway maintenance), engines used only for hotel power (for passenger railcar equipment), and engines that are used in self-propelled passenger-carrying railcars, are excluded from these regulations. The engines used in these smaller locomotive-type vehicles are generally subject to the nonroad engine requirements of Parts 89 and 1039.

The marine diesel engine program applies to all propulsion and auxiliary engines with per cylinder displacement up to 30 liters.¹²⁴ For purposes of these standards, these marine diesel engines are categorized both by per cylinder displacement and by maximum engine power.

According to our existing definitions, a marine engine is defined as an engine that is installed or intended to be installed on a marine vessel. Engines that are on a vessel but that are not “installed” are generally considered to be land-based nonroad engines and are regulated under 40 CFR part 89 or part 1039. Consistent with our current marine diesel engine program, the standards adopted in this rule apply to engines manufactured for sale in the United States or imported into the United States beginning with the

effective date of the standards. The standards also apply to any engine installed for the first time in a marine vessel after it has been used in another application subject to different emission standards. In other words, an existing nonroad diesel engine would become a new marine diesel engine, and subject to the marine diesel engine standards, when it is maritized for use in a marine application.

Consistent with our current program, the marine engine standards we are finalizing will not apply to marine diesel engines installed on foreign vessels. While we received many comments requesting that we extend the new standards to engines on foreign vessels operating in the United States, we have determined that it is appropriate to postpone this decision to our rulemaking for Category 3 marine diesel engines. This will allow us to consider all engines on an ocean-going vessel as a system; this may facilitate the application of advanced emission control technologies because these engines often share a common fuel and/or exhaust system. This approach is also consistent with the United States Government’s proposal to amend Annex VI of the International Convention for the Prevention of Pollution from Ships (MARPOL) currently under

consideration at the International Maritime Organization (IMO), which calls for significant emission reductions from all engines on ocean-going vessels.¹²⁵ EPA expects to finalize new Category 3 engine emission standards in late 2009.¹²⁶

B. What Standards Are We Adopting?

(1) Locomotive Standards

(a) Line-Haul Locomotives

We are setting new emission standards for newly-built and remanufactured line-haul locomotives. Our standards for newly-built line-haul locomotives will be implemented in two tiers: Tier 3, based on engine design improvements, and Tier 4, based on the application of the high-efficiency catalytic aftertreatment technologies now being developed and introduced in the highway diesel sector. Our standards for remanufactured line-haul locomotives apply to all Tier 0, 1, and 2 locomotives and are based on engine design improvements. Table III–1 summarizes the line-haul locomotive standards and implementation dates. The feasibility of the new standards and the technologies involved are discussed in detail in section III.C.

TABLE III.—1 LINE-HAUL LOCOMOTIVE STANDARDS
[g/bhp-hr]

Standards apply to	Take effect in year	PM	NO _x	HC
Remanufactured Tier 0 without separate loop intake air cooling.	2008 as Available, 2010 Required	0.22	8.0	1.00
Remanufactured Tier 0 with separate loop intake air cooling.	2008 as Available, 2010 Required	0.22	7.4	0.55
Remanufactured Tier 1	2008 as Available, 2010 Required	0.22	7.4	0.55
Remanufactured Tier 2	2008 as Available, 2013 Required	0.10	5.5	0.30
New Tier 3	2012	0.10	5.5	0.30
New Tier 4	2015	0.03	1.3	0.14

(i) Remanufactured Locomotives

As proposed, we are setting new standards for the existing fleet of Tier 0, Tier 1, and Tier 2 locomotives, to apply at the time of remanufacture. These standards will also apply at the first remanufacture of Tier 2 locomotives added to the fleet between now and the start of Tier 3.

Commenters have suggested that EPA adopt a naming convention for the standards tiers to avoid confusion over whether, for example, the terms “Tier 0 standards” and “Tier 0 locomotives” are referring to the “old” Tier 0 standards adopted in 1998 or the “new” Tier 0 standards promulgated in this rule. A similar confusion may exist for old and new Tier 1 and Tier 2 standards,

including for marine engines. The confusion is compounded by the fact that many of the locomotives previously subject to the old Tier 0 standards will now be subject to the new Tier 1 standards, and so a Tier 0 locomotive that is upgraded to meet them could fairly be called a Tier 1 locomotive, and likewise for Tier 2/Tier 3 standards.

¹²⁴ Marine diesel engines at or above 30 liters per cylinder, called Category 3 engines, are typically used for propulsion power on ocean-going ships. EPA is addressing Category 3 engines through separate actions, including a planned rulemaking for a new tier of federal standards (see Advance Notice of Proposed Rulemaking published December 7, 2007 at 72 FR 69522) and participation on the U.S. delegation to the International Maritime Organization for negotiations of new international

standards (see <http://www.epa.gov/otaq/oceanvessels.com> for information on both of those actions), as well as EPA’s Clean Ports USA Initiative (see <http://www.epa.gov/cleandiesel/ports/index.htm>).

¹²⁵ See “Revision of the MARPOL Annex VI, the NO_x Technical Code and Related Guidelines: Development of Standards for NO_x, PM, and SO_x,” submitted by the United States, BLG 11/15, Subcommittee on Bulk Liquids and Gases, 11th

Session, Agenda Item 5, February 9, 2007, Docket ID EPA-HQ-OAR-2007-0121-0034. This document, along with the U.S. Statement concerning the same, is also available on our Web site: www.epa.gov/otaq/oceanvessels.com.

¹²⁶ See 72 FR 68518, December 5, 2007 for the new regulatory deadline for the final rule for an additional tier of standards for Category 3 rulemaking (final rule by December 17, 2009).

In response, we are adopting a simple approach whereby a Tier 0 locomotive remanufactured under the more stringent Tier 0 standards we are adopting in this rule will be designated a Tier 0+ locomotive. A Tier 0 locomotive originally manufactured with a separate loop intake air cooling system that is remanufactured to the Tier 1+ standards will be designated as a Tier 1+ locomotive. We are adopting the same approach for Tier 1 and Tier 2 locomotives. That is, those remanufactured under the new standards would be called Tier 1+ and Tier 2+ locomotives, respectively. We are also suggesting that in many contexts, including a number of places in this final rule, there is really no need to make distinctions of this sort, as no ambiguity arises. In these contexts it would be perfectly acceptable to drop the "+" designation and simply refer to Tier 0, 1, and 2 locomotives and standards.

As described in section IV.B(3), the new Tier 0+, 1+, and 2+ standards (and corresponding switch-cycle standards) may apply when a Tier 0, 1, or 2 locomotive is remanufactured anytime after this final rule takes effect, if a certified remanufacture system is available. However, this early certification is voluntary on the part of the manufacturers, and so if no emissions control system is certified early for a locomotive, these standards will instead apply beginning January 1, 2010 for Tier 0 and 1, and no later than January 1, 2013 for Tier 2. We are also adopting the proposed reasonable cost provision, described in section IV.B(3), to protect against the unlikely event that the only certified systems made in the early program phase are exorbitantly priced.

Although under this approach, certification of new remanufacture systems in the early phase of the program is voluntary, we believe that developers will strive to certify systems to the new standards as early as possible, even in 2008, to establish these products in the market, especially for the locomotive models anticipated to have significant numbers coming due for remanufacture in the next few years. This focus on higher volume products also maximizes the potential for large emission reductions very early in this program, greatly offsetting the effect of slow turnover to new Tier 3 and Tier 4 locomotives inherent in this sector.

These remanufactured locomotive standards represent PM reductions of about 50 percent for Tier 0 and Tier 1 locomotives, and NO_x reductions of about 20 percent for Tier 0+ locomotives with separate loop aftercooling.

Significantly, these reductions will be substantial in the early years. This will be important to State Implementation Plans (SIPs) being developed to achieve attainment with the NAAQS, owing to the 2008 start date and relatively rapid remanufacture schedule (roughly every 7 years, though it varies by locomotive model and age).

Some commenters argued for delaying the remanufactured locomotive standards and some argued for accelerating them. However, little technical justification was provided on either side and, after reconsideration, we believe the proposed standards and dates are appropriate. However, based on the comments, we have identified two current Tier 0 locomotive models that are not likely to meet the new standards under the full range of required test conditions, owing to limitations in the original locomotive design. These are the General Electric (GE) Dash-8 locomotives not equipped with separate loop aftercooling, and the Electro-Motive Diesel (EMD) SD70MAC locomotives that are equipped with separate loop aftercooling. As a result, we are allowing an exception in ambient temperature and altitude conditions under which these models, when remanufactured, must meet the new standards, as detailed in the Part 1033 regulations. These exceptions are limited to the extent that it is technically feasible to meet the relevant standards under most in-use conditions.

(ii) Newly-Built Locomotives

We are adopting the proposed Tier 3 and Tier 4 line-haul locomotive standards but with an earlier start date for Tier 4 NO_x, along with an additional compliance flexibility option. We requested comment in the NPRM on whether additional NO_x emission reductions would be feasible and appropriate for Tier 3 locomotives in the 2012 timeframe, based on reoptimization of existing Tier 2 NO_x control technologies, or the addition of new engine-based technologies such as exhaust gas recirculation (EGR). Manufacturers submitted detailed technical comments indicating that achieving such reductions would result in a large fuel economy penalty, a major engine redesign that would hamper Tier 4 technology development, or both. Our own review of the technical options leads us to the same conclusion and we are therefore finalizing the Tier 3 emissions standards as proposed.

We proposed to allow manufacturers to defer meeting the Tier 4 NO_x standard on newly-built locomotives until the 2017 model year, in order to work through any implementation and

technological issues that might arise with advanced NO_x control technology. Even so, we expected that manufacturers would undertake a single comprehensive redesign program for Tier 4, relying on the same basic locomotive platform and overall emission control space allocations for all Tier 4 product years. With this in mind, we proposed that locomotives certified under Tier 4 in 2015 and 2016 without Tier 4 NO_x control systems should have these systems added when they undergo their first remanufacture and be subject to the Tier 4 NO_x standard thereafter.

We received many comments from state and local air quality agencies, and from environmental organizations, arguing that earlier implementation of these advanced technologies is technologically feasible and emphatically stating that they were needed to address the nation's air quality problems. Further review of the test data available for the proposed rule and of new test data available since the proposal supports the argument for earlier implementation of Tier 4 NO_x controls. This information is discussed in detail in section III.C. Consequently, after considering this data and industry comments regarding feasibility, we have concluded that the progress made in the development of NO_x aftertreatment technology has been such that this proposed allowance to defer NO_x control is not consistent with our obligation under section 213(a)(3) of the Clean Air Act to set standards that "achieve the greatest degree of emission reduction achievable through the application of technology which the Administrator determines will be available for the engines or vehicles, giving appropriate consideration to cost, lead time, noise, energy, and safety factors associated with the application of such technology."

We are therefore not adopting this allowance for deferred NO_x control in 2015–2016 Tier 4 locomotives, effectively advancing the Tier 4 NO_x standard for locomotives by two years. Besides meeting our obligation under the Clean Air Act, this change will simplify the certification and compliance program for all stakeholders by providing a single step for Tier 4 implementation. It will also provide substantial additional NO_x reductions during years that are important to some states for NAAQS attainment, thus helping to address what was arguably the most critical comment we received from state and local air agencies and environmental organizations.

We recognize that designing locomotives to meet the stringent Tier 4

standards in 2015 with the high levels of performance and reliability demanded by the railroad industry will be challenging. As in other recent EPA mobile source programs, we proposed and are finalizing several compliance flexibility measures to aid the transition to these very clean technologies. Specifically, we are adopting two distinct compliance flexibility options for NO_x that, while ensuring the earliest possible introduction of advanced emission control, will provide locomotive manufacturers some level of risk mitigation should the technology solutions prove to be less robust than we project. The first compliance flexibility is consistent with the flexibility program described in our NPRM providing an in-use compliance margin for NO_x of 1.3 g/bhp-hr at full useful life (*i.e.*, a 2.6 g/bhp-hr emissions cap for in-use testing) for the first three Tier 4 model years. See section IV.A(8) for details on this program.

The second flexibility provision is an alternative NO_x compliance option that reduces the in-use NO_x add-on to 0.6 g/bhp-hr (*i.e.*, a 1.9 g/bhp-hr emissions cap for any in-use testing) for model years 2015–2022. While significantly tightening the in-use emissions cap, the provision provides manufacturers with significantly more time to develop advanced NO_x emission control systems using real in-use experiences from the

locomotive fleet. Complementing this focus on improving technology through experience with the in-use fleet, this provision also allows manufacturers to substitute additional in-use tests on locomotives in lieu of the typical production line testing requirements of our locomotive regulations. This optional in-use testing would be in addition to the current in-use testing requirements of our locomotive certification program. See section IV.A(8) for details on this program.

For reasons explained in the NPRM, Tier 4 line-haul locomotives will not be required to meet standards on the switch cycle, but we are requiring that newly-built Tier 3 locomotives and Tier 0 through Tier 2 locomotives remanufactured under this program be subject to switch cycle standards, set at levels above the line-haul cycle standards. Section III.B(1)(b) provides details.

(b) Switch Locomotives

The NPRM discussed at some length the importance and challenges of turning over today’s large switch locomotive fleet to clean diesel. In response, we proposed standards and other provisions aimed at overcoming these challenges by encouraging the replacement of old high-emitting units with newly-built or refurbished locomotives powered by very clean

engines developed for the nonroad equipment market.

We are adopting the new standards for switch locomotives that we proposed. As proposed, we are also continuing the existing Part 92 policy of requiring Tier 0 switch locomotives to only meet standards on the switch cycle, while requiring Tier 1 and Tier 2 locomotives to meet the applicable standards on both the line-haul and switch cycles. This policy was adopted to ensure that manufacturers design emission controls to function broadly over all notches. The switch cycle standards shown in Table III–2 will require emission reductions equivalent to those required by our new standards that apply over the line-haul cycle. Note that these switch cycle standards also apply to the Tier 3 and earlier line-haul locomotives that are subject to compliance requirements on the switch cycle, as mentioned above and in Section III.B(1)(b).

We are also adopting the proposed Tier 3 and 4 emission standards for newly-built switch locomotives, as shown in Table III–2. These standards are slightly more stringent than the Tier 3 and Tier 4 line-haul standards. Given these more stringent switch cycle standards, it is not necessary to require to Tier 3 and 4 switchers to meet the line-haul standards over the line-haul cycle.

TABLE III.—2 EMISSION STANDARDS FOR SWITCH LOCOMOTIVES
[g/bhp-hr]

Switch locomotive standards apply to	Take effect in year	PM	NO _x	HC
Remanufactured Tier 0	2008 as available, 2010 required	0.26	11.8	2.10
Remanufactured Tier 1	2008 as available, 2010 required	0.26	11.0	1.20
Remanufactured Tier 2	2008 as available, 2013 required	0.13	8.1	0.60
Tier 3	2011	0.10	5.0	0.60
Tier 4	2015	0.03	1.3	0.14

We are also finalizing the proposed streamlined certification option to help in the early implementation of the switch locomotive program. As described in section IV.B(9), during a 10-year program start-up period aimed at encouraging the turnover of the existing switcher fleet to the new cleaner engines, switch locomotives may use nonroad-certified engines (Table III–3) without need for an additional certification under the locomotive program. In the years before

the nonroad Tier 4 start dates, we are making this provision available using pre-Tier 4 nonroad engines meeting today’s standards of 0.15 g/bhp-hr PM and 3.0/4.8 g/bhp-hr NO_x+NMHC (below/above 750 hp), because switchers built with these nonroad engines will still be much cleaner than those meeting the current switch locomotive Tier 2 standards of 0.24 and 8.1 g/bhp-hr PM and NO_x, respectively.

Commenters suggested that we allow the use of even earlier-tier nonroad

engines under this option, as these would still be substantially cleaner than the engines being replaced. However, we feel this would defeat the purpose of the program, and would not be justifiable on a feasibility basis, as current-tier nonroad engines will be available for incorporation into new switchers in any year of the program. We are adopting other compliance and ABT provisions relevant to switch locomotives as discussed in section IV.B(1), (2), (3), and (9).

TABLE III.—3 RELEVANT LARGE NONROAD ENGINE TIER 4 STANDARDS
[g/bhp-hr]

Engine power	Model year	PM	NO _x
At or Below 750 hp	2011	0.01	3.0 (NO _x +NMHC) ^a
	2014	0.01	
750–1200 hp	2011	0.075	2.6
	2015	0.02	0.50
Over 1200 hp	2011	0.075	0.50 genset; 2.6 non-genset
	2015	0.02	0.50

Note: (a) 0.30 NO_x for 50% of sales in 2011–2013, or alternatively 1.5 g NO_x for 100% of sales.

Finally, we are revising the definition of a switch locomotive to make clear that it is the total switch locomotive power rating (including power from any auxiliary engines that can operate when a main engine is operating), and not the individual engine power rating, that must be below 2300 hp to qualify, and to drop the unnecessary requirement that it be designed or used primarily for short distance operation. This clears up the ambiguity in the Part 92 definition over multi-engine switchers.

(c) Reduction of Locomotive Idling Emissions

We are adopting the proposed requirement that an Automatic Engine Stop/Start System (AESS) be used on all new Tier 3 and Tier 4 locomotives and installed on all existing locomotives that are subject to the new remanufactured engine standards, at the point of first remanufacture under the new standards. Locomotives equipped with an AESS device under this program must shut down the locomotive engine after no more than 30 continuous minutes of idling, and be able to stop and start the engine at least six times per day without causing engine damage or other serious problems. Continued idling is allowed under the following conditions: to prevent engine damage such as damage caused by coolant freezing, to maintain air pressure for brakes or starter systems, to recharge the locomotive battery, to perform necessary maintenance, or to otherwise comply with applicable government regulations.

Commenters also pointed out that it can sometimes be appropriate to allow a locomotive to idle to heat or cool the cab, and we are adopting regulations to allow it where necessary. Our implementation of this provision will rely on the strong incentive railroads have to limit idling to realize fuel cost savings after they have invested capital by installing an AESS system on a locomotive. We expect the railroads to appropriately develop policies instructing operators when it is acceptable to idle the locomotive to provide heating or cooling to the

locomotive cab. We do not believe that those individuals responsible for developing railroad policies have any incentive to encourage or allow unnecessary idling. It is our intention to stay abreast of how well this combination of idle control systems and railroad policies does in fact accomplish the intended goal of reducing unnecessary idling. In general, we may consider it to be circumvention of this provision for an individual operator to use the AESS system in a manner other than that for which the system was designed and implemented per a railroad's policy directive.

A further reduction in idling emissions can be achieved through the use of onboard auxiliary power units (APUs), either as standalone systems or in conjunction with an AESS. In contrast to AESS, which works to reduce unnecessary idling, the APU goes further by also reducing the amount of time when locomotive engine idling is necessary, especially in cold weather climates. APUs are small (less than 50 hp) diesel engines that stop and start themselves as needed to provide: heat to both the engine coolant and engine oil, power to charge the batteries, and power to run accessories such as those required for cab comfort. This allows the much larger locomotive engine to be shut down while the locomotive remains in a state of readiness, thereby reducing fuel consumption without the risk of the engine being damaged in cold weather. APUs are powered by nonroad engines compliant with EPA or State of California nonroad engine standards, and emit at much lower levels than an idling locomotive under current standards.

Some commenters suggested we require both an AESS and an APU. However, the amount of idle reduction an APU can provide is dependent on a number of variables, such as the function of the locomotive (e.g., a switcher or a line-haul), where it operates (i.e., geographical area), and its operating characteristics (e.g., number of hours per day that it operates). As we

stated in the NPRM, at this time we are not requiring that APUs be installed on every locomotive because it is not clear how much additional benefit they would provide outside of regions and times of the year where low temperatures or other factors that warrant the use of an APU exist and because they do involve some inherent design and operational complexities that could not be justified without such commensurate benefits. We are, however, adopting the proposed provision to encourage the additional use of APUs by providing in our test regulations, a process by which the manufacturer can appropriately account for the proven emission benefits of a more comprehensive idle reduction system.

In response to comment, we are adopting a more flexible approach that will allow the idle reduction requirement for remanufactured Tier 0+, 1+, and 2+ locomotives to be addressed in a separate certification apart from the certification of the full remanufacture system. Under this approach, remanufacturers will be allowed to obtain a certificate for a system that meets all of the requirements of part 1033 except for those of § 1033.115(g). However, since the idle controls would still need to be installed in a certified configuration before the remanufactured locomotive is returned to service, some other entity would need to obtain a certificate to cover the requirements of § 1033.115(g). (This separate certification approach is somewhat analogous to allowing a motor vehicle engine manufacturer to hold the certificate for exhaust emission standards and a motor vehicle manufacturer to hold the certificate for evaporative emission standards for a single motor vehicle.) Note that manufacturers of freshly manufactured locomotives and their customers will also have the choice as to whether the AESS is installed as part of the certified engine configuration at the factory or by an aftermarket company pursuant to a separate certification before the freshly manufactured locomotive is put into

service. These provisions will allow more companies to remain in the AESS manufacturing market and thus provide more choices to the railroads.

As described in Chapter 5 of the RIA, manufacturers of AESS, and demonstrations done in partnership between government and industry have shown that for most locomotives the fuel savings that result in the first few years after installation of an AESS system will offset the cost of adding the system to the locomotive. Given these short payback times for adding idle reduction technologies to a typical locomotive, normal market forces have led many railroads to retrofit a number of their locomotives with such controls. However, as is common with pollution, market prices generally do not account for the external social costs of the idling emissions, leading to an underinvestment in idling reduction systems. This rulemaking addresses those locomotives for which the railroads judge the fuel savings insufficient to justify the cost of the retrofit. We believe that applying AESS to these locomotives is appropriate when one also considers the significant emissions reductions that will result.

(2) Marine Diesel Engine Standards
(a) Newly-Built Marine Engines

We are adopting Tier 3 and Tier 4 emission standards for newly-built marine diesel engines with displacements under 30 liters per cylinder. Our analysis of the feasibility

of these standards is summarized in section III.C and detailed in the RIA.

We are retaining our existing per-cylinder displacement approach to establishing cutpoints for standards, but are revising and refining it in several places to ensure that the appropriate standards apply to every group of engines in this very diverse sector and to provide for an orderly phase-in of the program to spread out the redesign workload burden:

We are moving the C1/C2 cutpoint from 5 liters/cylinder to 7 liters/cylinder, because the latter is a more accurate cutpoint between today's high- and medium-speed diesels.

We are revising the per-cylinder displacement cutpoints within Category 1 to better define the application of standards.

An additional differentiation is made between high power density engines typically used in planing vessels and standard power density engines, with a cutpoint between them set at 35 kW/liter (47 hp/liter).

We are removing the distinction for marine diesels under 37 kW (50 hp) in Category 1, originally made because these were regulated under our nonroad engine program.

Finally, we will further group engines by maximum engine power, especially in regards to setting appropriate long-term aftertreatment-based standards.

Note that we are retaining the differentiation between recreational and non-recreational marine engines within Category 1 because there are differences

in their certification programs. Also, as discussed below, we are not finalizing Tier 4 standards for recreational marine engines at this time. Section IV.C(10) clarifies the definition of recreational marine diesel engine.

The new standards and implementation schedules are shown on Tables III-4 through 7. Briefly summarized, the marine diesel standards include stringent engine-based Tier 3 standards, phasing in over 2009-2014. They also include aftertreatment-based Tier 4 standards for commercial marine engines at or above 600 kW (800 hp), phasing in over 2014-2017. For engines of power levels not included in the Tier 3 and Tier 4 tables, the previous tier of standards (Tier 2 or Tier 3, respectively) continues to apply. These standards and implementation dates are the same as those proposed except: (1) Recreational marine engines are not subject to Tier 4 standards; (2) The Tier 4 NO_x standard for 2000-3700 kW engines has been pulled forward by two years; (3) The proposed optional Tier 4 approach coordinated with locomotive Tier 4 has been modified; and (4) based on comments we received, the Tier 3 standards for high power density engines in the 3.5 to 7 liter/cylinder category (Table III-5) have been adjusted slightly to better align them with standards in other categories. The first three of these changes are discussed in more detail below. See section 3.2.1.1 of the Summary and Analysis of Comments document for discussion of the fourth.

TABLE III-4.—TIER 3 STANDARDS FOR MARINE DIESEL C1 COMMERCIAL STANDARD POWER DENSITY

Maximum engine power	L/cylinder	PM g/bhp-hr (g/kW-hr)	NO _x +HC ^d g/bhp-hr (g/kW-hr)	Model year
<19 kW	<0.9	0.30 (0.40)	5.6 (7.5)	2009
19 to <75 kW	<0.9 ^a	0.22 (0.30) 0.22 (0.30) ^b	5.6 (7.5) 3.5 (4.7) ^b	2009 2014
75 to <3700 kW	<0.9 0.9-1.2 1.2-2.5 2.5-3.5 3.5-7.0	0.10 (0.14) 0.09 (0.12) 0.08 (0.11) ^c 0.08 (0.11) ^c 0.08 (0.11) ^c	4.0 (5.4) 4.0 (5.4) 4.2 (5.6) 4.2 (5.6) 4.3 (5.8)	2012 2013 2014 2013 2012

Notes:

- (a) <75 kW engines at or above 0.9 L/cylinder are subject to the corresponding 75-3700 kW standards.
- (b) Option: 0.15 g/bhp-hr (0.20 g/kW-hr) PM/4.3 g/bhp-hr (5.8 g/kW-hr) NO_x+HC in 2014.
- (c) This standard level drops to 0.07 g/bhp-hr (0.10 g/kW-hr) in 2018 for <600 kW engines.
- (d) Tier 3 NO_x+HC standards do not apply to 2000-3700 kW engines.

TABLE III-5.—TIER 3 STANDARDS FOR MARINE DIESEL C1 RECREATIONAL AND COMMERCIAL HIGH POWER DENSITY

Maximum engine power	L/cylinder	PM g/bhp-hr (g/kW-hr)	NO _x +HC g/bhp-hr (g/kW-hr)	Model year
<19 kW	<0.9	0.30 (0.40)	5.6 (7.5)	2009
19 to <75 kW	<0.9 ^a	0.22 (0.30)	5.6 (7.5)	2009

TABLE III-5.—TIER 3 STANDARDS FOR MARINE DIESEL C1 RECREATIONAL AND COMMERCIAL HIGH POWER DENSITY—Continued

Maximum engine power	L/cylinder	PM g/bhp-hr (g/kW-hr)	NO _x +HC g/bhp-hr (g/kW-hr)	Model year
		0.22 (0.30) ^b	3.5 (4.7) ^b	2014
75 to <3700 kW	<0.9	0.11 (0.15)	4.3 (5.8)	2012
	0.9–<1.2	0.10 (0.14)	4.3 (5.8)	2013
	1.2–<2.5	0.09 (0.12)	4.3 (5.8)	2014
	2.5–<3.5	0.09 (0.12)	4.3 (5.8)	2013
	3.5–<7.0	0.08 (0.11)	4.3 (5.8)	2012

Notes:

(a) <75 kW engines at or above 0.9 L/cylinder are subject to the corresponding 75–3700 kW standards.

(b) Option: 0.15 g/bhp-hr (0.20 g/kW-hr) PM/4.3 g/bhp-hr (5.8 g/kW-hr) NO_x+HC in 2014.TABLE III-6.—TIER 3 STANDARDS FOR MARINE DIESEL C2^a

Maximum engine power	L/cylinder	PM g/bhp-hr (g/kW-hr)	NO _x +HC ^b g/bhp-hr (g/kW-hr)	Model year
<3700 kW	7–<15	0.10 (0.14)	4.6 (6.2)	2013
	15–<20	0.20 (0.27) ^c	5.2 (7.0)	2014
	20–<25	0.20 (0.27)	7.3 (9.8)	2014
	25–<30	0.20 (0.27)	8.2 (11.0)	2014

Notes:

(a) See note (c) of Table III-7 for optional Tier 3/Tier 4 standards.

(b) Tier 3 NO_x+HC standards do not apply to 2000–3700 kW engines.

(c) For engines below 3300 kW in this group, the PM Tier 3 standard is 0.25g/bhp-hr (0.34 g/kW-hr).

TABLE III-7.—TIER 4 STANDARDS FOR MARINE DIESEL C1 AND C2

Maximum engine power	PM g/bhp-hr (g/kW-hr)	NO _x g/bhp-hr (g/kW-hr)	HC g/bhp-hr (g/kW-hr)	Model year
At or above 3700 kW	0.09 (0.12) ^a	1.3 (1.8)	0.14 (0.19)	^c 2014
	0.04 (0.06)	1.3 (1.8)	0.14 (0.19)	^{b, c} 2016
2000 to <3700 kW	0.03 (0.04)	1.3 (1.8)	0.14 (0.19)	^{c, d} 2014
1400 to <2000 kW	0.03 (0.04)	1.3 (1.8)	0.14 (0.19)	^c 2016
600 to <1400 kW	0.03 (0.04)	1.3 (1.8)	0.14 (0.19)	^b 2017

Notes:

(a) This standard is 0.19 g/bhp-hr (0.25 g/kW-hr) for engines with 15–30 liter/cylinder displacement.

(b) Optional compliance start dates can be used within these model years; see discussion below.

(c) Option for C2: Tier 3 PM/NO_x+HC at 0.10 / 5.8 g/bhp-hr (0.14/7.8 g/kW-hr) in 2012, and Tier 4 in 2015.

(d) The Tier 3 PM standards continue to apply for these engines in model years 2014 and 2015 only.

Engine manufacturers argued that modifying standard power density engines between 2000 and 3700 kW for Tier 3 NO_x, and again for Tier 4 NO_x shortly after would be too difficult. They argued that these engines could meet Tier 4 NO_x in 2014, two years earlier, if the Tier 3 NO_x+HC standard, proposed to apply in 2012, 2013, or 2014, depending on displacement, did not have to be met. We have analyzed this group of engines and agree that the suggested approach would be feasible and would have very little detrimental effect on NO_x reductions in 2012–2013, while providing significant additional NO_x reductions thereafter. We are therefore leaving the Tier 3/Tier 4 PM standards as proposed but revising the NO_x implementation schedule as suggested by the industry.

The Tier 3 standards for engines with maximum engine power less than 75 kW (100 hp) are based on the nonroad diesel Tier 2 and Tier 3 standards, because these smaller marine engines are largely derived from (and often nearly identical to) the nonroad engine designs. The relatively straightforward carry-over nature of this approach also allows for an early implementation schedule, in model year 2009, providing substantial early benefits to the program. However, some of the nonroad engines less than 75 kW are also subject to aftertreatment-based Tier 4 nonroad standards, and our new program does not carry these over into the marine sector, due to vessel design and operational constraints discussed in section III.C. Because of the widespread use of both direct- and indirect-injection diesel engines in the 19 to 75 kW (25–

100 hp) engine market today, we are making two options available to manufacturers for meeting Tier 3 standards on any engine in this range, as indicated in Table III-4. One option focuses on lower PM and the other on lower NO_x, though both require substantial reductions in both PM and NO_x and will take effect in 2014.

With important exceptions, we are subjecting marine diesel engines at or above 75 kW (100 hp) to new emissions standards in two steps, Tier 3 and Tier 4. The Tier 3 standards are based on the engine-out emission reduction potential (apart from the addition of exhaust aftertreatment) of the nonroad Tier 4 diesel engines that will be introduced beginning in 2011. The Tier 3 standards for C1 engines will phase in over 2012–2014. We believe it is appropriate to coordinate the marine Tier 3 standards

with the nonroad Tier 4 (rather than Tier 3) engine developments in this way because marine diesel engines are largely derived from land-based nonroad counterparts, and because the advanced fuel and combustion systems that we expect the Tier 4 nonroad engines to employ will allow approximately a 50 percent reduction in PM when compared to the reduction potential of the nonroad Tier 3 engines. Inserting an additional marine engine tier based on nonroad Tier 3 engines would result in overly short lead time and stability periods and/or a delay in stringent standards.

We are applying high-efficiency aftertreatment-based Tier 4 standards to all commercial and auxiliary C1 and C2 engines over 600 kW (800 hp). These standards will phase in over 2014–2017. Marine diesels over 600 kW, though fewer in number, are the workhorses of the inland waterway and intercoastal marine industry, running at high load factors, for many hours a day, over decades of heavy use. As a result they also account for the bulk of marine diesel engine emissions.

After considering the substantial number of comments received on the feasibility of extending Tier 4 standards to engines below 600 kW, we are not at this time setting Tier 4 standards for these engines. We may do so at some point in the future if further technology developments show a path to address the issues we identify in RIA chapter 4 with the application of aftertreatment technologies to smaller vessels.

We are also not extending the Tier 4 program to recreational marine diesel engines. In our proposal we indicated that at least some recreational vessels, those with engines above 2000 kW (2760 hp), have the space and design layout conducive to aftertreatment-based controls and professional crews who oversee engine operation and maintenance. This suggested that aftertreatment-based standards would be feasible for these larger recreational engines. While commenters on the proposal did not disagree with these views, they pointed out these very large recreational vessels often travel outside the United States, and, for tax reasons, flag outside the U.S. as well. Commenters argued that applying Tier 4 standards to large recreational marine diesel engines would further discourage U.S.-flagging because vessels with those engines would be limited to using only those foreign ports that make ULSD and reductant for NO_x aftertreatment available at recreational docking facilities, limiting their use and hurting the vessel's resale value. The aftertreatment devices used to meet Tier

4 are expected to be sensitive to sulfur in the exhaust and so ULSD must be used in these engines.

In general, we expect ULSD to become widely available worldwide, which would help reduce these concerns. However, there are areas such as Latin America and parts of the Caribbean that currently do not plan to require use of this fuel. Even in countries where ULSD is available for highway vehicles but not mandated for other mobile sources, recreational marinas may choose to not make ULSD and reductant available if demand is limited to a small number of vessels, especially if the storage and dispensing costs are high. To the extent the fuel requirements for Tier 4 engines encourage vessel owners to flag outside the United States, the results would be increased emissions since the international standards for these engines are equivalent to EPA's Tier 1 standards.

After considering the above, we conclude that it is preferable at this time to hold recreational engines marine diesel engines to the Tier 3 standards. We plan to revisit this decision when we consider the broader questions of the application of our national marine diesel engine standards to engines on foreign vessels that enter U.S. ports in the context of our Category 3 marine diesel engine rulemaking.

There is a group of commercial vessels that share some of the characteristics of recreational vessels in that they also operate outside the United States. However, the concerns that lead us to exclude recreational vessels from the Tier 4 standards (flagging or registering in a foreign country and thus avoiding all U.S. emission standards; resale value) do not generally apply to commercial vessels. Unlike recreational vessels, the majority of commercial vessels with C1 or C2 main propulsion engines that operate in the United States do not have the option of flagging offshore. This is because they are engaged full-time in harbor activities in U.S. ports or in transporting freight or otherwise operating only between two U.S. ports, and cabotage laws require such vessels be flagged in the United States. In addition, most of these vessels operate at or between U.S. ports, so ULSD availability is not expected to be a problem. Finally, the resale of U.S. commercial vessels on the world market is already affected by other U.S.-specific vessel design and operation requirements, and these standards are not expected to affect that situation.

Nevertheless, some commercial vessels are used in ways that could make the use of ULSD and even urea an intractable problem. These are commercial vessels that are routinely

operated outside of the United States for extended periods of time, including tug/barge cargo vessels operated on circle routes between the United States and Latin America that routinely refuel in places where ULSD is not available, and lift boats, utility boats, supply boats and crewboats that are used in the offshore drilling industry and are contracted to work in waters off Latin America or Western Africa for up to several years at a time without returning to the United States. Owners of these vessels informed us that requiring them to use Tier 4 engines will adversely impact their business in significant ways since they would have to arrange for ULSD and urea outside the United States, potentially at great additional cost, and that this in turn would affect their ability to compete with foreign transportation providers who do not face the same costs. These owners flag their vessels in the U.S. to maximize the flexibility of their business operations, but they informed us that they would consider segregating their fleets and flagging some elsewhere if they are required to use Tier 4 engines. Similar to the recreational marine case, the engines on reflagged vessels would not be subject to any U.S. emission controls or compliance requirements. In addition, there could be adverse impacts on associated industries that use these services, if there are fewer vessels available for use in the United States. For all of these reasons, these vessel owner/operators encouraged EPA to consider a provision that would not require these vessels to use Tier 4 engines.

We do not expect ULSD availability at foreign commercial ports to be a widespread problem. Many industrial nations already have or are expected to shift to ULSD in the near future, including Japan (by 2008), Singapore (in 2007), Mexico (in 2007 for "Northern border areas"), the EU member states (by 2009), and Australia (by 2009). Other countries may also make ULSD available by 2016, as refineries in other countries modify their production to supply ULSD to the U.S. markets even if they do not require it domestically. However, ULSD may be difficult to obtain in some areas of the world, notably Latin America and Africa. Therefore, it is reasonable to include a limited compliance exemption from the Tier 4 standards for the narrow set of vessels that are described above.

Because the decision of whether a Tier 4 engine is required must be made at the design phase of a vessel, and not after it goes into service, it is preferable to define such an exemption based on vessel design characteristics instead of

the owner's intentions for how the vessel may ultimately be used. After consulting with industry representatives, we concluded that the most obvious design feature that indicates the vessel is intended for extensive international use is compliance with international safety standards. We have concluded that the costs of obtaining and maintaining certification for the International Convention for the Safety of Life at Sea (SOLAS) are high enough to discourage owners of vessels that will not be used outside the United States to obtain certification to evade the Tier 4 standards. These costs can range from about \$250,000 to \$1 million in capital costs and from about \$50,000 to \$100,000 in annual operating costs. The Port State Information Exchange database maintained by the U.S. Coast Guard indicates that about 30 percent of offshore supply vessels built annually are SOLAS certified and that 3 percent or fewer passenger vessels and tugs built annually are SOLAS certified (based on new vessel construction, 1995–2006).¹²⁷ Therefore, to be eligible for the exemption, the owner will be required to obtain and maintain relevant international safety certification pursuant to the requirements of the United States Coast Guard and SOLAS for the vessel on which an exempted engine is installed.

Vessel owners will be required to petition EPA for an exemption for a particular vessel in order for an engine manufacturer to sell them an exempted engine; granting of the exemption will not be automatic. In evaluating a request for a Tier 4 exemption, we will consider the owner's projections of how and where the vessel will be used and the availability of ULSD in those areas, as well as the mix of SOLAS and non-SOLAS vessels in the owner's current fleet and the extent to which those vessels are being or have been operated outside the United States. In general, it is our expectation that fleets should first use existing pre-Tier 4 vessels for operations where ULSD may not be available. Therefore, we would not expect to grant an exemption for a vessel that will be part of a fleet that does not already have a significant percentage of Tier 4 vessels, since a fleet with a smaller percentage of Tier 4 vessels would likely have more pre-Tier 4 vessels that could be employed in the overseas application instead. For example, if 30 percent of an owner's current fleet has SOLAS certification,

we would expect that up to 70 percent of the vessels in that fleet could be Tier 4 compliant without changes in the operation of the fleet. We may also ask the petitioner to demonstrate that other vessels in the petitioner's fleet remain in service outside the United States and have not been placed into service domestically. EPA does not expect to approve applications for the Tier 4 exemption described in this paragraph prior to 2021; we expect that the existing fleet of Tier 3 vessels can be used for overseas operations during that time. If an owner petitions EPA for an exemption prior to that year, we may request additional information on the owner's expected operation plans for that vessel and a more complete explanation as to why another vessel in the existing fleet could not be redirected to the offshore application with the Tier 4 vessel under construction taking that vessel's place. Finally, a failure to maintain SOLAS certification for the vessel on which an exempted engine is installed would result in a finding of noncompliance and the owner would be liable for applicable fines and other penalties.

To address the situation in which an owner of a vessel with Tier 4 engines wants to use that vessel in a country that does not have ULSD available, we are also including a provision that will allow the owner to petition EPA to temporarily remove or disable the Tier 4 controls on vessels that are operated solely outside the United States for a given period of time. The petitioner will need to specify where the vessel will operate, how long the vessel will operate there, and why the owner will be unable to provide ULSD for the vessel. The petitioner will also be required to describe what actions will be taken to disable or disconnect the Tier 4 controls. Permission to disable or remove the Tier 4 controls will be allowed only for the period specified by the owner and agreed to by EPA; however, the owner may re-petition EPA at the end of that period for an extension. As part of the approval of such a petition, the petitioner will be required to agree to re-install or reconnect the Tier 4 emission control devices prior to re-entry into the United States, whether this occurs only at the end of the specified period or earlier.

These provisions for migratory vessels are intended to facilitate the use of vessels certified to the U.S. federal marine diesel emission standards while they are operated for extended periods in areas that may not have ULSD available. It should be noted that vessels that receive either limited exemptions or that petition EPA to remove or

disable Tier 4 controls will still be subject to the MARPOL emission limits when they are operated outside the United States. We may review these migratory vessel provisions in the context of our upcoming Category 3 marine diesel engine rulemaking. We may also revisit this program in the future if the number of exemption requests appears to be unreasonably high or if we find that significant numbers of vessels that have obtained exemptions from Tier 4 are, in fact, in use domestically.

Note that the implementation schedule in the above marine standards tables is expressed in terms of model years, consistent with past practice and the format of our regulations. However, in two cases we believe it is appropriate to provide a manufacturer the option to delay compliance somewhat, as long as the standards are implemented within the indicated model year. Specifically, we are allowing a manufacturer to delay Tier 4 compliance within the 2017 model year for 600–1000 kW (800–1300 hp) engines by up to 9 months (but no later than October 1, 2017) and, for Tier 4 PM, within the 2016 model year for engines at or above 3700 kW (4900 hp) by up to 12 months (but no later than December 31, 2016). We consider this option to delay implementation appropriate in order to give some flexibility in spreading the implementation workload and ensure a smooth transition to the long-term Tier 4 program.

The Tier 4 standards for locomotives and for C2 diesel marine engines of comparable size are at the same numerical levels but differ somewhat in implementation schedule: Locomotive Tier 4 standards start in 2015, while diesel marine Tier 4 standards start in 2016 for engines in the 1400–2000 kW (1900–2700 hp) range, and in 2014 for engines over 2000 kW (with final PM standards starting in 2016 for these engines). We consider these locomotive and marine diesel Tier 4 implementation schedules to be close enough to warrant our adopting a marine engine option based on the Tier 4 locomotive schedule, aimed at facilitating continuance of today's frequent practice of developing a common engine platform for both markets. Commenters on the proposal supported this marine engine option, but expressed concerns about competitiveness issues and argued that we should remove the proposed restriction to engines of 7–15 liter/cylinder displacement and under 3700 kW maximum engine power.

We are adopting this locomotive-based marine engine option, but with

¹²⁷ Memorandum to Docket EPA–HQ–OAR–2003–0190, Marine Vessels—SOLAS Certification, from Jean Marie Revelt, dated January 11, 2007.

some changes from the proposed approach to address potential competitiveness issues, as well as our own concern that this option be used only for the intended purpose of avoiding unnecessary dual design efforts. First, we are retaining some limits on its scope, specifically to engines above both a 7 liters per cylinder limit (Category 2 in the marine sector) and a 1400 kW (1900 hp) maximum engine power. Second, if the option is used, its standards must be met for all of a manufacturer's marine engines at or above 1400 kW (1900 hp) in the same displacement category (that is, 7–15, 15–20, 20–25, or 25–30 liters per cylinder) in all of the model years 2012 through 2016. This will help ensure the option is not gamed by artificially subdividing engine platforms. Because the switch locomotive program we are establishing already includes a similar streamlined option allowing the use of land-based nonroad engines, we are not extending this option to switchers.

We are adopting another provision to help ensure that this locomotive-based marine engine option is environmentally beneficial and is not used to gain a competitive advantage. We are requiring that marine engines under this option meet Tier 3 standards in 2012, the year Tier 3 starts for locomotives, with standards numerically corresponding to locomotive Tier 3 standards levels: 0.14 g/kW-hr (0.10 g/bhp-hr) PM and 7.8 g/kW-hr NO_x+HC (5.8 g/bhp-hr: that is, 5.5 + 0.30 g/bhp-hr combined NO_x and HC). Otherwise a manufacturer could take advantage of the later-starting marine Tier 3 schedule to generate credits or allow increased emissions from these engines until 2015 when the option requires Tier 4 compliance. This approach also deals fairly with the problem identified in the proposal regarding redesigning locomotive-based engine platforms to meet the numerically lower marine Tier 3 NO_x level.

Finally, we considered but are not adopting a provision that would set a total vessel power limit for the Tier 4 standards. The comments we received on this issue lead us to conclude that multiple-engine configurations are used in vessel designs for specific purposes and are not likely to be employed to evade the Tier 4 standards. We may consider this type of restriction in a future action, however, if multiple-engine vessels are built in applications that have typically used a different number of engines in the past.

(b) Remanufactured Marine Engines

In addition to the standards for newly-built engines, we are adopting for the first time emission standards for marine diesel engines on existing vessels. Many of these existing engines will remain in the fleet for 40 years or more, making them what would otherwise be a substantial source of air pollution. The marine remanufacture program will provide early PM reductions by reducing emissions from this legacy fleet sooner than would be the case from the retirement of old vessels in favor of new vessels with cleaner engines. Additional early NO_x reductions are expected to be achieved from the use of locomotive remanufacture systems recertified under this program for Category 2 engines.

The program we are finalizing is modified from what we described in the NPRM. In the NPRM we described a two-part program that would have applied to all commercial marine diesel engines above 600 kW when they are remanufactured. In the first part, which we considered beginning as early as 2008, vessel owners/operators and engine rebuilders who remanufacture engines would be required to use a certified remanufacture system when an engine is remanufactured (defined as replacement of all cylinder liners, either in one event or over a five-year period) if such a certified system is available. In the second part, which we considered beginning in 2013, a marine diesel engine identified by EPA as a high-sales volume engine model would have been required to meet specified emission requirements when it is remanufactured. Specifically, the remanufacturers or owners of such engines would have been required to use systems certified to meet the standard; if no certified system is available, they would have needed to either retrofit the engines with emission reduction technology that demonstrates at least a 25 percent reduction or replace the engines with new ones. For engines not identified as high-sales volume engines, Part 1 would have continued to apply.

Several commenters requested that EPA not finalize this program at this time but instead consider it in a separate rulemaking. They noted that this would allow additional time to consider the program and its requirements. Postponing the program, however, would also result in the loss of important emission reductions early in the program. Delay is also not necessary because the program we are adopting consists only of the first part of the program described in our proposal,

requiring the owner of a marine diesel engine to use a certified marine remanufacture system when the engine is remanufactured if such a system is available. We are not adopting a requirement for the mandatory availability of remanufacture systems. (Under the option discussed in the proposal, in certain circumstances, if a remanufacture system was not made available the owner would have been required to retrofit an emission control technology, repower the vessel (replace its engines) or scrap the vessel.)

The marine remanufacture program we are adopting applies to all commercial marine diesel engines with maximum engine power greater than 600 kW and manufactured in 1973 or later, through Tier 2. The beginning date of 1973 is based on our existing locomotive program; many of the techniques used to achieve those standards are expected to be applicable to marine diesel engines over 600 kW.

As described in more detail below, the program draws on aspects of our locomotive remanufacture and diesel retrofit programs with regard to the basic requirements that apply and how remanufacture systems are certified. The remainder of this section describes the main features of the program. The technological feasibility of this program is described in section III.C, and the certification requirements are set out in section IV. Small manufacturer, engine dresser, vessel builder, and operator flexibilities are set out in section IV.A(13)(b).

Similar to the locomotive program, the marine program we are finalizing applies when a marine diesel engine is remanufactured. Covered engines are those that are remanufactured to as-new condition. Based on discussions with engine manufacturers, we have determined that replacing all cylinder liners is a simple and clear indicator that the servicing being done is extensive enough for the engine to be considered functionally equivalent to a freshly manufactured engine, both mechanically and in terms of how it is used. Therefore, we are defining remanufacture as the removal and replacement of all cylinder liners, either during a single maintenance event or over a five-year period. It should be noted that marine diesel engines are not considered to be remanufactured if the rebuilding process falls short of this definition (i.e., the cylinder liners are removed and replaced over more than a five-year period). As with locomotives, remanufactured marine diesel engines are new until they are sold or placed into service.

For the purpose of this program, “replace” includes removing, inspecting, and requalifying a liner. This addresses the situation in which an engine experiences a cylinder failure prior to a scheduled rebuild: The owner might replace the failed cylinder right away and replace the others at rebuild; then, at the time of rebuild, the installer would likely inspect the cylinder that was a few months old to make sure it qualified for continued use according to the certificate holder’s instructions. We do not think that owners will fail to requalify cylinders to avoid the remanufacture requirements because requalification is done both to ensure the continued reliability and durability of the engine and as part of surveys necessary to retain vessel certification for safety and other purposes. The five-year provision was first adopted in the locomotive program to help ensure that the standards are not avoided through phased remanufacturing (i.e., not replacing the power assemblies all at once). It is reasonable to use this approach in the marine sector as most commercial engines are rebuilt all at once, although some owners may choose a rolling rebuild approach in which a certain number of cylinders are rebuilt every year. We may revisit the five-year limit after a few years of the program to evaluate whether this is the appropriate period and whether owners are adjusting their rebuild practices, particularly with respect to rolling rebuilds, to circumvent the regulations (see discussion of rolling rebuilds, below).

When an engine is remanufactured, it must be certified as meeting the emission standards for remanufactured engines (by using a certified remanufacture system) unless there is no certified remanufacturing system available for that engine. In other words, the owner/operator or installer of a covered engine would be required to use a certified marine remanufacture system when remanufacturing that engine if one is available. If there is no certified system available at that time, there is no requirement. Availability means not only that EPA has certified a system, but also that it can be obtained and installed in a timely manner consistent with normal business practices. For example, a system would generally not be considered to be available if it required that the engine be removed from the vessel and shipped to a factory to be remanufactured unless that is the normal rebuild process for that engine. Similarly, a system would not be considered to be available if the component parts are not available for

purchase in the period normally associated with a scheduled rebuild. If a certified system is not available there is no requirement to comply with this program until the next remanufacture, at which time the remanufacturer would need to check again to see if a system is available. Nonavailability due to inability to obtain parts may be demonstrated by a written record that shows a good faith effort to obtain parts.

Several states and localities have voluntary retrofit programs to reduce emissions from marine diesel engines. These programs encourage vessel owners to apply emission reduction strategies in return for a financial or operational incentive. Retrofit systems range from engine adjustments to installing different cylinders, fuel injectors, turbochargers, or other engine components. To receive the incentive, the owner must demonstrate the reduction, often through emission measurements. We received state agency comments expressing concern about the potential inconsistency between state and local retrofit programs and a potential marine remanufacture program. Specifically, a situation could be created in which a vessel owner who has already applied a retrofit device pursuant to a state or local retrofit program would be required to remove the voluntary retrofit device and install a certified marine remanufacture system. We do not want to negatively impact the positive benefits that arise from state and local retrofit programs, especially in those cases in which the retrofit achieves a greater reduction (e.g., retrofit of a SCR system) than a certified marine remanufacture system. We also do not want to discourage these programs especially in early years where states and local programs may achieve reductions before certified remanufacture systems become available.

Therefore, we are adopting a provision that will allow an owner/operator of an engine that is fit with a retrofit device prior to 2017 pursuant to a state or local retrofit program to request a qualified exemption from the marine remanufacture requirements for that engine. This qualified exemption will be available only to engines equipped with retrofit device under a state or local program before 2017. The owner/operator must request the exemption prior to a remanufacturing event that would otherwise trigger the requirement to use a certified remanufacture system. The request must include documentation that the vessel has been retrofit pursuant to a state or local retrofit program and a signed statement declaring that to be true.

Except for the initial request for a specific vessel and a specific retrofit, a request would be considered to be approved unless we notify the requestor otherwise within 30 days of the date that we receive the request. Note that the exemption does not apply where the sponsoring government specifies that inclusion in the retrofit program is not intended to provide an exemption from the requirements of this subpart. EPA’s granting of the exemption is conditioned upon the owner/operator’s continued use and maintenance of the retrofit kit that provides the basis for the exemption.

Beginning in 2017, this exemption will no longer be available for new retrofits. Engines included in state or local retrofit programs will be required to use a certified remanufacture system if one is available when the engine is remanufactured. In this case either the certified remanufacture system would be part of the retrofit or the vessel owner would use a certified remanufacture system the next time at the next remanufacture event.

At this time, we are adopting standards for remanufacture systems only for marine diesel engines over 600 kW. This 600 kW threshold is reasonable because of the long hours of use, often at high load, of engines above 600 kW, and their long services lives. These engines are also more likely to undergo regular full overhauls, returning them to as-new condition. Commercial marine diesel engines larger than 600 kW typically undergo periodic full, like-new rebuilds. These large engines are often installed on tugs, towboats, ferries, offshore supply vessels, lakers, and coasters, which require reliable power at all times. These vessels are often used for ten or more hours a day, every day of the year. As a result, these engines are typically subject to regular maintenance to ensure their dependability. In addition, many manufacturers provide guidance for a full rebuild to as-new condition. This might include replacing piston rings, heads, bearings, and gear train/camshaft as well as piston liners.¹²⁸ Rebuilding to as-new condition helps ensure smooth operation over the full maintenance interval. Owners of these vessels are also motivated to maintain their engines because it is very complicated and expensive to repower their vessels; replacing an engine may require major hull modifications. Because these vessels operate for decades, often 40 or

¹²⁸ See Note from Amy Kopin, Mechanical Engineer, to Jean Marie Revelt, EPS, Re: Marine Remanufacture Program. A copy of this Note is available in Docket OAR-2003-0190.

more years, their engines may be remanufactured to as-new condition anywhere from three to six or even more times before the vessel is scrapped.

We are not setting standards for marine remanufacture systems for engines below 600 kW because we currently do not have sufficient data to determine the extent that rebuilding of engines below 600kW qualifies as remanufacturing to an as new condition. Smaller commercial engines under 600 kW or recreational engines typically have shorter useful lives than the larger engines and do not see as much wear on an annual basis. This means it takes longer to acquire the hours between maintenance intervals. Engines on some smaller commercial or recreational marine vessels may not be rebuilt at all but, instead, are replaced or the vessel is scrapped. There may also be other technological and cost issues with applying remanufacture requirements to smaller commercial or recreational engines.

For these reasons, we are finalizing only standards for remanufactured commercial marine diesel engines above 600 kW. We may revisit this approach after implementing the program to evaluate whether other remanufactured marine diesel engines should be included in the program as well.

A certified marine remanufacture system must achieve a 25 percent reduction in PM emissions compared to the engine's measured baseline emissions level (the emission level of the engine as rebuilt according to the manufacturer's specification but before the installation of the remanufacture system) without increasing NO_x emissions (within 5 percent). We are not finalizing a 0.22 g/kW-hr PM cap, as proposed. The percent reduction is being adopted because the large range of engine platforms on existing marine diesel engines makes the selection of an effective numeric emission limit impractical. A more stringent emission limit may prevent the development of remanufacture systems for many engines, while a less stringent limit could allow manufacturers to certify remanufacture systems for engines that already meet the limit without any additional emission benefits. A percentage reduction has the advantage of allowing more engines to participate in the program while ensuring valid emission reductions.

We are not adopting the multi-step approach discussed in the proposal. This approach, based on the Urban Bus program, would have entailed setting standards based on reductions of 60 percent, 40 percent, and 20 percent, and requiring that a rebuild use the certified

kit meeting the most stringent of these three standards if available. Manufacturers expressed concern that such a requirement would discourage the development of remanufacture systems since they could rapidly become obsolete. Owners were concerned that they would be subject to a moving requirement that would complicate their engine maintenance and overhaul schedules and could result in identical engine models being required to use different remanufacture systems. They also were concerned that such an approach would mean they would have to use a different system every time they remanufacture, and the impacts on engines that are remanufactured over several maintenance events. For these reasons, instead of adopting the multi-step approach, we are adopting a single emission reduction requirement. If several certified systems are available, we will allow any of them to be used. However, states may develop incentive programs to encourage the use of the certified remanufacture system with the greatest reduction. Also, we may revisit the emission level in the future to determine if it should be modified to reflect advances in applying new PM reduction technologies to existing marine diesel engines.

We expect that this PM reduction will be met by using incrementally-improved components that are replaced when an engine is remanufactured, based on reduction technologies manufacturers are already using or will be using to achieve the Tier 3 PM standards. For example, a remanufacture system could reduce PM emissions by using different fuel injectors or different piston rings to reduce oil consumption. Remanufacturing systems may not adversely affect engine reliability, durability, or power.

Some engine manufacturers expressed concern about the potential for unintended adverse effects on engine performance, reliability, or durability that could occur if another entity develops a remanufacture system for their engines. They were particularly concerned about being held responsible for an emission failure if the remanufacture system does not perform as intended, or for an engine failure if the system causes other engine components to fail. To address this concern, the program we are finalizing requires any person who wishes to certify a remanufacture system for an engine not produced by that person to notify the original engine manufacturer and request their comments on the remanufacture system. Any comments received by the certifier are required to

be included in the certification application, as well as a description of how those comments were addressed.

As we described at proposal, this final rule includes a cost cap on marine diesel remanufacture systems of \$45,000 per ton of PM reduced, based on the incremental cost of the remanufacture system (the cost in excess of what a rebuild would otherwise cost). This cost cap is analogous to the reasonable cost limit in the current locomotive remanufacturing program and is intended to ensure that marine remanufacture systems do not impose excessively burdensome cost requirements on vessel owners that are not justified by the benefits of the reductions. The \$45,000 per ton of PM reduced is similar to the cost of a number of mobile source retrofit programs. This cap includes all costs to the vessel owner associated with the remanufacture system beyond those associated with an engine remanufactured without a certified system, such as labor for any special installation procedures and any modifications to the vessel or its operation (e.g., fuel consumption impacts).

It may not be possible for the certifier to predict the characteristics of all vessels that can use the remanufacture system and therefore provide a comprehensive estimate of the total incremental costs of installing the remanufacture system. Therefore, in addition to an estimate of the vessel-related installation costs that would apply to most vessels, the certifier must also provide an estimate of the amount of residual incremental costs that would be available for installation of the remanufacture system on a particular vessel without triggering the \$45,000 per ton PM threshold (i.e., the maximum amount installation may cost for a particular vessel after the cost of the remanufacture system is deducted from the \$45,000 maximum cost). This will guide vessel owners in determining if the cost of a certified remanufacture system will exceed the \$45,000 threshold for a particular vessel.

We are including a provision that will allow a vessel owner to request an exemption from EPA if the vessel owner can demonstrate to EPA's satisfaction that actual installation cost for his or her vessel will exceed the \$45,000 per ton PM threshold. This may be necessary, for example, if a vessel with external keel cooling cannot be modified to achieve required cooling levels required by the remanufacture system without extensive modifications to the vessel hull. We are also including a small business exemption as well as a

financial hardship provision (see Section IV.A.13(b)(vi and vii)) that would allow postponing the requirements for owners who can show financial hardship.

Marine remanufacture systems can be certified as soon as this rule goes into effect. A remanufacture system will be considered to be available 120 days after we issue a certificate of conformity for it or 90 days after we include it on our list of certified remanufacture systems, whichever is later. Prior to the end of that period, a kit will not be considered to be "available." This period allows time for owners to arrange for remanufacturing with a certified system once one that applies to the relevant engine has been certified. Once a marine remanufacture system is certified, as evidenced by an EPA-issued certificate of conformity, it will be considered to be available until it is withdrawn or the certificate holder fails to obtain a certificate of conformity for a subsequent year. We will maintain a list of available remanufacture systems and provide access to this list by posting it on our website. Owners should consult the list prior to any particular remanufacturing event to determine whether a certified system is available and therefore whether they are affected by the program. Uncertified systems purchased before that date can be used as long as they are consistent with the normal parts inventory practices of the owner or rebuild facility. Stockpiling of uncertified remanufacture systems to evade the requirements of the program is not allowed.

For engines on a rolling rebuild schedule (i.e., cylinder liners are not replaced all at once but are replaced in sets on a schedule of 5 or fewer years, for example 5 sets of 4 liners for a 20-cylinder engine on a 5-year schedule), the requirement is triggered at the time the remanufacture system becomes available, with the engine required to be in a certified configuration when the last set of cylinder liners is replaced. The remanufacturing requirements do not apply for cylinder-liner replacements that occurred before the remanufacture system becomes available. Any remanufacturing that occurs after the system is available needs to use the certified system, including remanufacturing that occurs on a rolling schedule over less than five years following the availability of the remanufacturing system. If the components of a certified remanufacture system are not compatible with the engine's current configuration, the program allows the owner to postpone the installation of the remanufacture system until the replacement of the last

set of cylinder-liners, which would occur no later than five years after the availability of the system. At that time, all engine components must be replaced according to the certified remanufacture system requirements.

Initially, we expect marine remanufacture systems to be certified for C2 engines that are derived from certified locomotive remanufacture systems. Some of these certified locomotive systems are already used on C2 marine diesel engines, or can be used with modification. The new Tier 0+, Tier 1+ and Tier 2+ certified locomotive remanufacture systems are likely to be capable of being used on marine diesel engines without much additional development when those certified locomotive systems become available, for additional reductions. To encourage this practice, we are providing a streamlined certification process for locomotive systems certified to the new Tier 0+, Tier 1+, or Tier 2+ standards for use on C2 engines. The streamlined certification will also be allowed for existing Tier 0 locomotive remanufacture systems (certified under part 92), but those systems can be used only on pre-Tier 1 (uncertified) C2 marine engines, and the use of these existing Tier 0 systems will not be permitted after systems certified to the new Tier 0+ (or Tier 1+ if applicable) locomotive standards are made available. The streamlined certification process will require only an engineering analysis demonstrating that the system would achieve emission reductions from marine engines similar to those from locomotives. The streamlined certification process will allow modifications to the previously certified locomotive system as necessary to install the system on a C2 marine engine. If the manufacturer of a locomotive remanufacture system chooses to modify that system in a substantive way, for example to remove NO_x emission controls (because the marine remanufacture program only requires PM reductions), then the system will have to be recertified as a marine remanufacture system based on measured values and subject to all of the other certification requirements of the marine remanufacture program (see section IV). We are not providing a similar streamlined certification process for C1 marine systems because there are currently no certified remanufacture systems for C1-equivalent engines through our other mobile source programs.

The program described above is engine-based in that it assumes that remanufacture systems will consist of changes to engine components or

operational settings. At least one user asked EPA to consider also allowing remanufacture systems consisting of the use of specified fuels or fuel additives. The program we are adopting will allow this type of remanufacture system, subject to the following constraints.

First, the use of a remanufacture system based on a fuel or fuel additive will not be mandatory if such a system is certified. Instead, the use of a fuel or fuel additive system will be allowed as an alternative compliance mechanism in place of an engine-based remanufacture system. In other words, if an engine-based remanufacture system is certified, owners of the affected engine models can either use that engine-based system or use a fuel or fuel additive system if one has also been certified; if there is no certified engine-based system, then there is no requirement to use the fuel or fuel additive remanufacture system. This requirement is necessary because, in contrast to an engine-based system, a fuel or fuel additive-based system requires positive action on the part of the owner to achieve the emission reductions. In the case of an engine-based system, the owner installs the replacement parts at the time of rebuild; installation of the parts will achieve the required reductions and there is little impact on the owner or the vessel's operations. In the case of a fuel or fuel additive system, however, the owner will be required to use the specified fuel or fuel additive at all times; if the owner does not take the required action, the "system" will not be in use. Because a fuel or fuel additive-based system will require the owner to do something on a continuous basis and require additional recording and recordkeeping, the success of the system requires a positive commitment on behalf of the owner/operator.

Second, the certifier of a remanufacture system based on a fuel or fuel additive will be required to show that use of the fuel or fuel additive meets the 25 percent PM reduction based on measured values, without increasing NO_x emissions, for all engines to which the system will apply. This will require testing an engine with and without the use of the specified fuel or fuel additive. Different engines may be combined into one engine family for the purpose of certification, based on EPA approval.

Third, any fuel or fuel additive for which certification is sought under the marine remanufacture program must first be registered under 40 CFR Part 79, Registration of Fuels and Fuel Additives. This is to ensure that the fuel or fuel additive does not contain

substances that are otherwise controlled by EPA.

Fourth, as part of the certification, the certifier will be required to provide a sampling procedure that can be used by EPA or other enforcement authorities to verify owner compliance onboard and for enforcement purposes. That procedure should explain how to detect if the appropriate level of fuel additive or if the appropriate fuel type is actually being used onboard on the basis of a fuel sample taken from a fuel tank on the vessel. In addition to being provided to EPA as part of the certification process, the certifier will be required to provide a copy of this procedure to the purchaser as part of the remanufacture system package and will be required to maintain a copy of the procedure on the internet to facilitate in-field compliance verification.

Fifth, the remanufacture system will require a notification to be placed at the appropriate fill location (either on the fuel tank inlet in the case of fuels or pre-blended fuel additives, or as specified on the engine in the case of fuel additives not blended in the fuel) that indicates the engine is outfitted with a fuel or fuel additive remanufacture system and that compliant fuel or additives must be used at all times.

Finally, when an owner agrees to use a fuel or fuel additive-based remanufacture system in lieu of an engine-based system, that owner must also agree to any recordkeeping requirements specified in the certification of that system. These may include keeping a record of the purchase of the specified fuel or fuel additive and, in the case of additives, the amounts and dates of the additive use. These requirements must be set out by the certifier as part of the kit, and the owner will be deemed to have agreed to them by affixing a label to the engine or appropriate fuel or fuel additive inlet indicating that it is certified with a fuel or fuel-additive remanufacture system.

If an owner or operator chooses a certified remanufacture system based on a particular fuel or fuel additive to meet these remanufacture requirements, the failure to use the fuel or fuel additive would be a violation of 1068.101(b)(1).

Allowing the use of fuel or fuel additive-based remanufacture systems is not intended to be a mechanism to require fuel switching for marine diesel engines, either to 15 ppm fuel earlier than required or to distillate from residual fuel for auxiliary engines on vessels with Category 3 marine diesel engines or for those smaller vessels than may currently use residual fuel in their C2 main propulsion engines. It is also not intended to prevent the use of off-

spec fuel in marine diesel engines. If there is no certified engine-based remanufacture system available for an engine, a fuel or fuel additive-based kit will not be required to be used even if one is certified.

EPA is committed to the development and successful operation of a marine remanufacture program. We intend to assess the effectiveness of this program as early as 2012 to ascertain the extent to which engine manufacturers are providing certified remanufacture systems. If remanufacture systems are not available or are not in the process of being developed and certified at that time for a significant number of engines, we may consider changes to the program. As part of that assessment, we may evaluate whether to include Part 2 of the program described in our proposal. Part 2 would require the owner/operator or installers of a marine diesel engine identified by EPA as a high-sales volume engine to either use a certified remanufacture system when the engine is remanufactured or, if no system is available, retrofit an emission reduction technology for the engine that meets the 25 percent PM reduction, or repower (replace the engine with a freshly manufactured engine). Part 2 was intended to create a market for marine remanufacture systems, to help ensure their development over the initial five years of the program. However, vessel owners were very concerned that a mandatory repower program would have the opposite impact, and would discourage certification of remanufacture systems in favor of mandatory repowers due to the higher value of a replacement engine compared to a remanufacture system. In evaluating the effectiveness of the remanufacture program in the future, EPA may revisit the need for Part 2, or something similar, to ensure emission reductions from the large marine legacy fleet are occurring in a timely and effective manner. We may also evaluate other aspects of the program, including the criteria that trigger a remanufacturing event (including the 5-year period for incremental remanufactures), and whether we should set remanufacture standards for engines less than 600 kW.

(3) Carbon Monoxide, Hydrocarbon, and Smoke Standards

We did not propose and are not setting new standards for CO. Emissions of CO are typically relatively low in diesel engines today compared to non-diesel pollution sources. Furthermore, among diesel application sectors, locomotives and marine diesel engines are already subject to relatively stringent

CO standards in Tier 2—essentially 1.5 and 3.7 g/bhp-hr, respectively, compared to the current heavy-duty highway diesel engine CO standard of 15.5 g/bhp-hr. Therefore, the Tier 3 and Tier 4 CO standards for all locomotives and marine diesel engines will remain at current Tier 2 levels and remanufactured Tier 0, 1 and 2 locomotives will likewise continue to be subject to the existing CO standards for each of these tiers. Although we are not setting more stringent standards for CO in Tier 4, we note that aftertreatment devices using precious metal catalysts that we project will be employed to meet Tier 4 PM, NO_x and HC standards will provide meaningful reductions in CO emissions as well.

As discussed in section II, HC emissions, often characterized as VOCs, are precursors to ozone formation, and include compounds that EPA considers to be air toxics. As with CO, emissions of HC are typically relatively low in diesel engines compared to non-diesel sources. However, in contrast to CO standards, the HC standard for Tier 2 line-haul locomotives (0.30 g/bhp-hr), though comparable to HC standards from other diesel applications in Tier 2 and Tier 3, is more than twice that of the long-term 0.14 g/bhp-hr standard set for both the heavy-duty highway 2007 and nonroad Tier 4 programs. For marine diesel engines, the Tier 2 HC standard is expressed as part of a combined NO_x+HC standard varying (by engine size) between 5.4 and 8.2 g/bhp-hr, which clearly allows for high HC levels. Our more stringent Tier 3 NO_x+HC standards for marine diesel engines will likely provide some reduction in HC emissions, but we expect that the catalyzed exhaust aftertreatment devices used to meet the Tier 4 locomotive and marine NO_x and PM standards will concurrently provide very sizeable reductions in HC emissions. Therefore, in accordance with the Clean Air Act section 213 provisions outlined in section I.B(3) of this preamble, we are applying a 0.14 g/hp-hr HC standard to locomotives and marine diesel engines in Tier 4. This level is the same as that adopted for highway and nonroad diesel engines equipped with high-efficiency aftertreatment.

We are retaining the existing form of the HC standards through Tier 3. That is, locomotive and marine HC standards will remain in the form of total hydrocarbons (THC), except for gaseous- and alcohol-fueled engines (See 40CFR § 92.8 and § 94.8). Likewise, the Tier 3 marine NO_x+HC standards are based on THC, except that Tier 3 standards for less than 75 kW (100 hp) engines are

based on NMHC, consistent with their basis in the nonroad engine program. Tier 4 HC standards are expressed as NMHC standards, consistent with aftertreatment-based standards adopted for highway and nonroad diesel engines.

As for other diesel mobile sources, we believe that locomotive smoke standards currently in place are of diminishing usefulness as PM emissions are reduced to very low levels, as these low-PM engines emit very little or no visible smoke. We are therefore not setting smoke standards for locomotives covered under the new 40 CFR Part 1033 created by this final rule, if the locomotives are certified to a PM family emission limit (FEL) or standard of 0.05 g/bhp-hr (0.07 g/kW-hr) or lower. Locomotives certified with PM at higher levels are subject to smoke standards equal to those established previously in Part 92. This allows manufacturers of locomotives certified to Tier 4 PM (or to an FEL slightly above Tier 4) to avoid the unnecessary expense of testing for smoke. Marine diesel engines currently have no smoke standards and we are not setting any in this rule.

Commenters suggested that smoke testing is superfluous for pre-Tier 4 engines as well, because a properly maintained engine meeting any tier of EPA emissions standards will also meet the smoke standards. Based on the available information, we remain unconvinced that this argument is valid in all cases and we are therefore retaining the smoke standards for locomotives with PM FELs above 0.05 g/bhp-hr. However, we do agree that this relationship generally holds true for engines designed to emission standards being set in this rule, and are therefore waiving the smoke test requirement from certification, production line, and in-use testing, unless there is visible evidence of excessive smoke emissions. This provides the test cost savings sought by the manufacturers but retains the EPA enforcement opportunity if smoke should become a problem in engines subject to this program.

C. Are the Standards Feasible?

In this section, we describe the feasibility of the various emission control technologies we project will be used to meet the standards we are finalizing today. Because of the range of engines and applications we cover in this rulemaking and because of the diversity in technologies that will be available for them, our standards span a range of emission levels. We have identified a number of different emission control technologies we expect will be used to meet these standards. The technologies range from

incremental improvement of existing engine components to highly advanced catalytic exhaust aftertreatment systems similar to those expected to be used to control emissions from heavy-duty diesel trucks and nonroad equipment.

We first describe the feasibility of emission control technologies we project will be used to meet the standards we are finalizing for existing locomotive and marine engines that are remanufactured as new (i.e., Tier 0, 1, 2 locomotives and marine diesel engines >600 kW). We next describe how these same technologies will be applied to meet the interim standards for freshly manufactured engines (i.e., Tier 3). We conclude this section with a discussion of catalytic exhaust aftertreatment technologies projected to be used to meet our Tier 4 standards. Throughout this section, we also address many of the comments submitted by stakeholders concerning the feasibility, applicability, performance, and durability of the emission control technologies we presented in the Notice of Proposed Rulemaking (NPRM). For a more detailed analysis of these technologies, issues related to their application to locomotive and marine diesel engines, and our response to public comments, we refer you to the Regulatory Impact Analysis (RIA) and Summary & Analysis of Comments documents associated with this rulemaking.

(1) Emission Control Technologies for Remanufacture of Existing Locomotives and Marine Diesel Engines >600 kW

In the locomotive sector, emissions standards already exist for engines that are remanufactured as new. Some of these engines were originally unregulated (i.e. Tier 0), and others were originally built to earlier emissions standards (Tier 1 and Tier 2). This rulemaking now requires more stringent standards for these engines whenever the locomotives are remanufactured as new. Our remanufactured engine standards apply to locomotive engines and marine engines >600 kW that were originally built as early as 1973.

We project that incremental improvements to existing engine components will make it feasible to meet both our locomotive and marine remanufactured engine standards for PM. In many cases, these improvements have already been implemented on newly built locomotives to meet our current locomotive standards. To meet the more stringent NO_x standard for the locomotive Tier 0+ and Tier 1+ remanufacturing program, we expect that improvements in fuel system design, engine calibration and

optimization of existing after-cooling systems will be used to reduce NO_x from the current 9.5 g/bhp-hr Tier 0 standard to the tightened Tier 1+ standard for NO_x of 7.4 g/bhp-hr. These are the same technologies used to meet the current Tier 1 emission standard of 7.4 g/bhp-hr. In essence, locomotive manufacturers will duplicate current Tier 1 locomotive NO_x and HC emission solutions and incorporate them into the portion of the existing Tier 0 fleet able to accommodate them (i.e. locomotives manufactured with separate-circuit cooling systems for intake air and engine coolant). For older Tier 0 locomotives without separate-circuit cooling systems, reaching the Tier 1 NO_x level will not be possible, and 8.0 g/hp-hr represents the lowest achievable NO_x emission level through the application of improved fuel system design.

To meet the more stringent PM standards for the Tier 0+, 1+, and 2+ locomotive and marine remanufacturing programs (as well as the new locomotive Tier 3 interim standards), we expect that lubricating oil consumption control technologies will be implemented. A significant fraction of the PM in today's medium-speed locomotive and locomotive-based marine engines is comprised of lubricating oil.¹²⁹ Engine design changes which reduce oil consumption also reduce the volatile organic fraction of the engine-out PM. Whether oil consumption is reduced through improvements in piston ring-pack design, improved closed crankcase ventilation systems, or a combination of both, lower PM emissions will result. We believe that use of existing low-oil-consumption piston ring-pack designs—in conjunction with improvements to closed crankcase ventilation systems—can provide the significant, near-term PM reductions required for these remanufacturing programs. These PM-reducing technologies can be applied to all medium-speed locomotive and locomotive-based marine engines—including those built as far back as 1973.

For the remanufacture of locomotive- and nonroad-based marine engines >600 kW, we believe that similar improvements to piston ring-pack designs, as well as turbocharger, fuel system, and closed crankcase ventilation system improvements can achieve the 25 percent PM reduction required in this program without the use of exhaust aftertreatment devices.

¹²⁹ Smith, B., Osborne, D., Fritz, S., "AAR Locomotive Emissions Testing 2006 Final Report," Association of American Railroads, Document #LA-023.

Turbocharger designs which increase engine airflow or charge air cooling system enhancements which reduce intake air temperatures can reduce PM levels. Fuel system changes such as increased injection pressure or improved injector tip design can enhance fuel atomization, improving combustion efficiency and reducing soot PM. Any combination of these improvements—or other technologies which achieve the 25 percent PM reduction—can become part of a certified marine remanufacture kit.

We believe that some fraction of the remanufacturing systems for locomotives can be developed and certified as early as this year, so we are requiring the usage of the new Tier 0+, Tier 1+ and Tier 2+ emission control systems as soon as they are available. However, we estimate that it will take approximately 2 years to complete the development and certification process for all of the Tier 0+ and Tier 1+ emission control systems, so full implementation of the Tier 0+ and Tier 1+ remanufactured engine standards is not anticipated until it is required in 2010. We base this lead time on the types of technology that we expect to be implemented and on the amount of lead time locomotive manufacturers needed to certify similar systems for our current remanufacturing program. The lead time required to implement the design changes necessary to meet the Tier 3 and remanufactured Tier 2 locomotive PM emission standards led to an implementation date of 2012 for new Tier 3 engines and 2013 for remanufactured Tier 2 engines. These engine changes include further improvements to ring pack designs (especially for two-stroke engines) and the implementation of high efficiency crankcase ventilation systems, which are described and illustrated in detail in Chapter 4 of the RIA.

(2) Emission Control Technologies for New Tier 3 Locomotive and Marine Diesel Engines

The new Tier 3 locomotive and marine diesel engine standards require PM reductions relative to current Tier 2 levels. Based upon our on-highway and nonroad clean diesel experience, we expect that the introduction of ULSD fuel into the locomotive and marine sectors will reduce sulfate PM formation and assist in meeting the PM standards for locomotives (both remanufactured Tier 2 and new Tier 3) and new marine diesel engines. We believe that the combination of reduced sulfate PM and incremental design changes that bring oil and crankcase emission control to near Tier 3 nonroad or 2007 heavy-duty

on-highway levels can provide at least a 50 percent reduction in PM emissions.

For Tier 3 marine diesel engines (which are, in almost all instances, a derivative of land-based nonroad and locomotive engines), the technologies and design changes needed to meet the more stringent NO_x and PM standards are already being developed for nonroad Tier 4 applications. In order to meet our nonroad Tier 4 emission levels, these engines, in the years before 2012, will see significant base engine improvements designed to reduce engine-out emissions. For details on the design, calibration, and hardware changes we expect will be used to meet the Tier 3 standards for lower horsepower marine engines, we refer you to our nonroad Tier 4 rulemaking.¹³⁰ For example, we expect that marine engines will utilize high-pressure, common-rail fuel injection systems or improvements in unit injector design. When such fuel system improvements are used in conjunction with engine mapping and calibration optimization, the marine Tier 3 diesel engine standards can be met. In the case of locomotive-based marine engines, we expect that manufacturers will transfer the technologies used to meet locomotive standards to the marine engine designs.

The 2009 Tier 3 start date for marine engines <75 kW constitutes a special case. We proposed this very early start date, matched with standard levels equal to the nonroad engine Tier 4 standard levels that take effect in 2008, based on our assessment that these engines are close derivatives of the nonroad engines on which they are based—in some cases, with no substantive modifications. The 2009 start date accounts for time needed to make the necessary modifications, prepare for and conduct the certification process, and deal with the large overall workload burden for diesel engine manufacturers. Although the manufacturers commented that this is a very aggressive schedule, at the limits of feasibility, they did not refute our assessment. Their objections to implementation of the not-to-exceed (NTE) standard on the same schedule, and our response, are discussed in section IV.A(3).

Because all of the aforementioned technologies to reduce NO_x and PM emissions can be developed for production, certified, and introduced into the marine engine sector without

extended lead-time, we believe these technologies can be implemented for some engines as early as 2009, and for all engines by 2014, on a schedule that very closely follows the nonroad Tier 4 engine changes.

(3) Catalytic Exhaust Aftertreatment Technologies for Tier 4 Locomotive and Marine Engines

For marine diesel engines in commercial service that are greater than 600 kW and for all locomotives, we are setting stringent Tier 4 standards based on the use of advanced catalytic exhaust aftertreatment systems to control both PM and NO_x emissions. There are four main issues to address when analyzing the application of this technology to these new sources: The efficacy of the fundamental catalyst technology in terms of the percent reduction in emissions given certain engine conditions such as exhaust temperature; its appropriateness in terms of packaging; its long-term durability; and whether the technology significantly impacts an industry's supply chain infrastructure—especially with respect to supplying urea reductant for NO_x aftertreatment on locomotives and marine vessels. We have carefully examined these points, and based upon our analysis (detailed in Chapter 4 of the RIA), we have identified robust PM and NO_x catalytic exhaust aftertreatment systems that are suitable for locomotives and marine engines that also pose a manageable impact on the rail and marine industries' infrastructure.

(a) Catalytic PM Emission Control Technology

The most effective exhaust aftertreatment used for diesel PM emission control is the diesel particulate filter (DPF). In Europe, more than one million light-duty diesel passenger cars are OEM-equipped with DPF systems, and worldwide, over 200,000 DPF retrofits to diesel engines have been completed.¹³¹ Broad application of catalyzed diesel particulate filter (CDPF) systems with greater than 90 percent PM control began with the successful introduction of 2007 model year heavy-duty diesel trucks in the United States. These systems use a combination of passive and active soot regeneration strategies. CDPF systems utilizing metal substrates are a further development that balances a degree of elemental carbon soot control with reduced

¹³⁰ "Final Regulatory Impact Analysis: Control of Emissions from Nonroad Diesel Engines," EPA420-R-04-007, May 2004, Docket EPA-HQ-OAR-2003-0012. The RIA is also available online at <http://epa.gov/nonroad-diesel/2004fr/420r04007.pdf>.

¹³¹ "Diesel Particulate Filter Maintenance: Current Practices and Experience", Manufacturers of Emission Controls Association, June 2005, online at http://meca.org/galleries/default-file/Filter_Maintenance_White_Paper_605_final.pdf.

backpressure, improved ability of the trap to clear oil ash, greater design freedom regarding filter size/shape, and greater system robustness. Metal-CDPFs were initially introduced as passive-regeneration retrofit technologies for diesel engines designed to achieve approximately 60 percent control of PM emissions. Recent data from development of these systems for Euro-4 truck applications has shown that metal-CDPF trapping efficiency for elemental carbon PM can exceed 70 percent for engines with inherently low elemental carbon emissions.¹³²

Data from locomotive testing confirms a relatively low elemental carbon fraction and relatively high organic fraction for PM emissions from medium-speed Tier 2 locomotive engines.¹³³ The use of an oxidizing catalyst with platinum group metals (PGM) coated directly to the CPDF combined with a diesel oxidation catalyst (DOC) mounted upstream of the CDPF will provide 95 percent or greater removal of HC, including the semi-volatile organic compounds that contribute to PM. Such systems will reduce overall PM emissions from a locomotive or marine diesel engine by approximately 90 percent from today's levels.

We believe that locomotive and marine diesel engine manufacturers will benefit from the extensive development taking place to implement DPF technologies in advance of the heavy-duty truck and nonroad PM standards in Europe and the United States. Given the steady-state operating characteristics of locomotive and marine engines, DPF regeneration strategies will certainly be capable of precisely controlling PM under all conditions and passively regenerating whenever the exhaust gas temperature is >250 °C. Therefore, we believe that the Tier 4 PM standards we are adopting for locomotive and marine diesel engines are technologically feasible. And given the level of activity in the on-highway and nonroad sectors to implement DPF technology, we have concluded that our implementation dates for locomotive and marine diesel engines are appropriate and achievable.

(b) Catalytic NO_x Emission Control Technology

We have analyzed a variety of technologies available for NO_x reduction to determine their applicability to diesel engines in the

locomotive and marine sectors. As described in more detail in Chapter 4 of the RIA, we expect locomotive and marine diesel engine manufacturers will choose to use Selective Catalytic Reduction (SCR) to comply with our new standards. SCR is a commonly-used aftertreatment device for meeting stricter NO_x emissions standards in diesel applications worldwide. Stationary power plants fueled with coal, diesel, and natural gas have used SCR for three decades as a means of controlling NO_x emissions, and currently European heavy-duty truck manufacturers are using this technology to meet Euro 5 emissions limits. To a lesser extent, SCR has been introduced on diesel engines in the U.S. market, but the applications have been largely limited to ferry boats and stationary electrical power generation demonstration projects in California and several of the Northeast states. However, several heavy-duty truck engine manufacturers have indicated that they will use SCR technology by 2010, when 100 percent of the heavy-duty diesel trucks are required to meet the NO_x limits of the 2007 heavy-duty highway rule.^{134, 135} Providing comment on our NPRM, locomotive and marine diesel engine manufacturers confirm that they expect to use urea-SCR catalyst systems to comply with our Tier 4 standards. While other promising NO_x-reducing technologies such as lean NO_x catalysts, NO_x adsorbers, and advanced combustion control continue to be developed (and may be viable approaches to the standards we are setting today), our analysis assumes that SCR will be the Tier 4 NO_x technology of choice in the locomotive and marine diesel engine sectors.

An SCR catalyst supports the chemical reactions which reduce nitrogen oxides in the exhaust stream to elemental nitrogen (N₂) and water by using ammonia (NH₃) as the reducing agent. The most-common method for supplying ammonia to the SCR catalyst is to inject an aqueous urea-water solution into the exhaust stream. In the presence of high-temperature exhaust gasses (>250 °C), the urea hydrolyzes to form NH₃ and CO₂. The NH₃ is stored on the surface of the SCR catalyst where it is used to complete the NO_x-reduction reaction. In theory, it is

possible to achieve 100 percent NO_x conversion if the NH₃-to-NO_x ratio (α) is 1:1 and the space velocity within the catalyst is not excessive. However, given the space limitations in packaging exhaust aftertreatment devices in mobile applications, an α of 0.85–1.0 is often used to balance the need for high NO_x conversion rates against the potential for NH₃ slip (where NH₃ passes through the catalyst unreacted). The urea dosing strategy and the desired α are dependent on the conditions present in the exhaust gas; namely temperature and the quantity of NO_x present (which can be determined by engine mapping, temperature sensors, and NO_x sensors). Overall NO_x conversion efficiency, especially under low-temperature exhaust gas conditions, can be improved by controlling the ratio of two NO_x species within the exhaust gas; NO₂ and NO. This can be accomplished through use of an oxidation catalyst upstream of the SCR catalyst to promote the conversion of NO to NO₂. The physical size and catalyst formulation of the oxidation catalyst are the principal factors that control the NO₂-to-NO ratio, and by extension, improve the low-temperature performance of the SCR catalyst.

Recent studies have shown that SCR systems are capable of providing well in excess of 80 percent NO_x reduction efficiency in high-power, diesel applications.^{136, 137, 138} SCR catalysts can achieve significant NO_x reduction throughout much of the exhaust gas temperature operating range observed in locomotive and marine applications. Collaborative research and development activities between diesel engine manufacturers, truck manufacturers, and SCR catalyst suppliers have also shown that SCR is a mature, cost-effective solution for NO_x reduction on diesel engines in other mobile sources. While many of the published studies have focused on highway truck applications, similar trends, operational characteristics, and NO_x reduction efficiencies have been reported for marine and stationary applications as well.¹³⁹ Given the preponderance of studies and data—and our analysis summarized here and detailed in Chapter 4 of the RIA—we have

¹³⁶ Walker, A.P. et al., "The Development and In-Field Demonstration of Highly Durable SCR Catalyst Systems," SAE 2004-01-1289.

¹³⁷ Conway, R. et al., "Combined SCR and DPF Technology for Heavy Duty Diesel Retrofit," SAE Technical Paper 2005-01-1862, 2005.

¹³⁸ "The Development and On-Road Performance and Durability of the Four-Way Emission Control SCRTM System," presented by Andy Walker, 9th DEER Conference, August 28, 2003.

¹³⁹ Telephone conversation with Gary Keefe, Argillon, June 6, 2006.

¹³² Jacob, E., Laëmmmerman, R., Pappenheimer, A., Rothe, D. "Exhaust Gas Aftertreatment System for Euro 4 Heavy-duty Engines", MTZ, June, 2006.

¹³³ Smith, B., Osborne, D., Fritz, S. "AAR Locomotive Emissions Testing 2006 Final Report" Association of American Railroads, Document #LA-023.

¹³⁴ "Review of SCR Technologies for Diesel Emission Control: European Experience and Worldwide Perspectives," presented by Dr. Emmanuel Joubert, 10th DEER Conference, July 2004.

¹³⁵ Lambert, C., "Technical Advantages of Urea SCR for Light-Duty and Heavy-Duty Diesel Vehicle Applications," SEA Technical Paper 2004-01-1292, 2004.

concluded that this technology is appropriate for locomotive and marine diesel applications. Furthermore, locomotive and marine diesel engine manufacturers will benefit from the extensive development taking place to implement SCR technologies in advance of the heavy-duty truck NO_x standards in Europe and the U.S. The urea dosing systems for SCR, already in widespread use across many different diesel applications, are expected to become more refined, robust, and reliable in advance of our Tier 4 locomotive and marine standards. Given the predominately steady-state operating characteristics of locomotive and marine engines, SCR NO_x control strategies will certainly be capable of precisely controlling NO_x under all conditions whenever the exhaust gas temperature is greater than 250 °C.

To ensure that we have the most up-to-date information on urea-SCR NO_x technologies and their application to locomotive and marine engines, we have met with a number of locomotive and marine engine manufacturers, as well as manufacturers of catalytic NO_x emission control systems. Through our discussions we have learned that some engine manufacturers perceive some risk regarding urea injection accuracy and long-term catalyst durability, both of which could result in either less efficient NO_x reduction or ammonia emissions. Comments on our NPRM, submitted by the Manufacturers of Emission Controls Association (MECA), provided additional information on the issues of urea dosing accuracy, catalyst durability, and system performance and their comments are consistent with our own analysis that urea-SCR technology can provide durable control of NO_x emissions. We have carefully investigated these issues for other diesel applications and conclude that precise urea injection systems and durable catalysts already exist and have been applied to urea-SCR NO_x emission control systems which are similar to those that we expect to be implemented in locomotive and marine applications.

Urea injection systems applied to on-highway diesel trucks and diesel electric power generators already ensure the precise injection of urea, and these applications have similar—if not more dynamic—engine operation as compared to locomotive and marine engine operation. To ensure precise urea injection across all engine operating conditions, these systems utilize NO_x sensors to maintain closed-loop feedback control of urea injection. These NO_x-sensor-based feedback control systems are similar to oxygen sensor-based systems that are used with

catalytic converters on virtually every gasoline vehicle on the road today. These systems, already developed for many diesel engines, are directly applicable to locomotive and marine engines as well.

(c) Durability of Catalytic PM and NO_x Emission Control Technology

Published studies indicate that SCR systems will experience very little deterioration in NO_x conversion throughout the life-cycle of a diesel engine.^{140, 141} The principal mechanism of deterioration in an SCR catalyst is thermal sintering—the loss of catalyst surface area due to the melting and growth of active catalyst sites under high-temperature conditions (as the active sites melt and combine, the total number of active sites at which catalysis can occur is reduced). This effect can be minimized by design of the SCR catalyst washcoat and substrate for the exhaust gas temperature window in which it will operate. Several commenters noted that locomotives are subject to consist operation in tunnels, which results in elevated exhaust gas temperatures. Further, they speculated that these elevated exhaust temperatures could reach 700 °C—a temperature that could lead to deterioration of catalyst performance over the useful life of a locomotive. To investigate this scenario, EPA conducted a study (in cooperation with locomotive manufacturers and the railroads) in August, 2007 on Union Pacific's Norden tunnel system (between Sparks, NV and Roseville, CA).¹⁴² We determined that the peak, post-turbine exhaust gas temperature observed in the 2 trailing units of a 4-unit lead consist was only 560 °C. In light of this new information, we are more confident that catalytic aftertreatment devices will be both effective and durable when used in locomotive service.

Another mechanism for catalyst deterioration is chemical poisoning—the plugging and/or chemical de-activation of active catalytic sites. Phosphorus from the engine oil and sulfur from diesel fuel are the primary components in the exhaust stream

¹⁴⁰ Conway, R. et al., “NO_x and PM Reduction Using Combined SCR and DPF Technology in Heavy Duty Diesel Applications,” SAE Technical Paper 2005-01-3548, 2005.

¹⁴¹ Searles, R.A., et al., “Investigation of the Feasibility of Achieving EURO V Heavy-Duty Emission Limits with Advanced Emission Control Systems,” 2007 AECC Conference—Belgium, Paper Code: F02E310.

¹⁴² “Locomotive Exhaust Temperatures During High Altitude Tunnel Operation In Donner Pass,” U.S. EPA, August 29, 2007. This document is available in Docket EPA-HQ-OAR-2003-0190-0736.

which can de-activate a catalytic site. The risk of catalyst deterioration due to sulfur poisoning will be all but eliminated with the 2012 implementation of ULSD fuel (<15 ppm S) for locomotive and marine applications. Locomotive and marine operators will already have several years of experience running ULSD fuel by the time NO_x aftertreatment technology is required. Catalyst deterioration due to chemical poisoning can also be reduced through the use of an engine oil with lower levels of sulfated ash, phosphorous, and sulfur (commonly referred to as “low-SAPS” oil). Such an oil formulation, designed for use in 2007 DPF- and DOC-equipped on-highway, heavy-duty engines was introduced in October 2006 and is specified by the American Petroleum Institute (API) as “CJ-4.”¹⁴³ This specification has new and/or lower limits on the amount of sulfated ash, phosphorous, and sulfur an oil may contain and was developed specifically for 2007 on-highway engines equipped with exhaust aftertreatment technologies running on ULSD fuel. Previous oil formulations for heavy-duty, on-highway engines, such as API CI-4, did not specify a limit for sulfur content, and allowed higher levels of phosphorous (0.14% vs. 0.12%) and ash (1.2~1.5% vs. 1.0%) content.¹⁴⁴

The migration of low-SAPS engine oil properties to future locomotive and marine oil formulations—while beneficial and directionally helpful in regards to the durability, performance, and maintenance of the exhaust aftertreatment components we reference—does not affect our feasibility analysis. European truck and marine applications have shown that SCR is a durable technology even without using a low-SAPS oil formulation. One commenter suggested that these newer, low-SAPS oil formulations, developed for use in on-highway and nonroad diesel engines, may not be appropriate for locomotive or marine applications. While we acknowledge that the exact oil formulation for locomotive and marine applications using ULSD fuel is not known today, we do believe that there is adequate time to develop an appropriate oil formulation. For example, in the State of California, all

¹⁴³ “API CJ-4 Performance Specifications,” American Petroleum Institute, online at http://apicj-4.org/performance_spec.html. This document is available in Docket EPA-HQ-OAR-2003-0190-0738.

¹⁴⁴ “CJ-4 Performance Specification: Frequently Asked Questions,” Lubrizol, online at <http://www.lubrizol.com/cj-4/faq.asp>. This document is available in Docket EPA-HQ-OAR-2003-0190-0741.

intra-state locomotives, marine vessels (in the SCAQMD), and nonroad engines have been operating with ULSD fuel since June, 2006—so there should already be field data/experience available today to begin developing an oil formulation for ULSD in advance of the implementation date for aftertreatment-forcing standards. In addition, the nonroad sector will have transitioned to ULSD fuel nationwide by June, 2010, followed by the locomotive sector in June, 2012—again, leaving ample time to develop an oil formulation which does not contain any more sulphated-ash than necessary to neutralize crankcase acids.

Thermal cycling, mechanical vibration, and shock loads are all factors which can affect the mechanical durability of exhaust system components. The stresses applied to the aftertreatment devices by these factors can be managed through the selection of proper materials and the design of support and mounting structures which are capable of withstanding the shock and vibration levels present in locomotive and marine applications. One commenter to our NPRM stated that shock loading for a locomotive catalyst is estimated to be 10–12 g. This level of shock loading is consistent with the levels that catalyst substrate manufacturers, catalyst canners, and exhaust system manufacturers are currently designing to (for OEM aftertreatment systems and components subject to the durability requirements of on-highway, marine, and nonroad applications). Nonroad applications such as logging equipment are subject to shock loads in excess of 10 g and on-highway applications can exceed 30 g (with some OEM applications specifying a 75 g shock load requirement).¹⁴⁵ In addition, the American Bureau of Shipping (ABS) specification for exhaust manifolds on diesel engines states that these parts may need to withstand vibration levels as high as ± 10 g at 600 °C for 90 minutes.¹⁴⁶ Given these examples of shock and vibration requirements for today's nonroad, on-highway, and marine environments, we believe that appropriate support structures can be designed and developed for the aftertreatment devices we expect to be used on Tier 4 locomotives.

¹⁴⁵ Correspondence from Adam Kotrba of Tenneco. This document is available in Docket EPA-HQ-OAR-2003-0190-0742.

¹⁴⁶ "ABS Rules for Building and Classing—Steel Vessels Under 90 Meters (295 Feet) In Length," Part 4—Vessel Systems and Machinery, American Bureau of Shipping, 2006.

(d) Packaging of Catalytic PM and NO_x Emission Control Technologies

Locomotive manufacturers will need to design the exhaust system components to accommodate the aftertreatment system. Our analysis, detailed in the RIA, shows that the packaging requirements for the aftertreatment system are such that they can be accommodated within the envelope defined by the Association of American Railroads (AAR) Plate "L" clearance diagram for freight locomotives.¹⁴⁷ The typical volume required for the SCR catalyst and post-SCR ammonia slip catalyst for Euro V and U.S. 2010 heavy-duty truck applications is approximately 2 times the engine displacement, and the upstream DOC/CDPF volume is approximately 1–1.5 times the engine displacement. Due to the longer useful life and maintenance intervals required for locomotive applications, we estimate that the SCR catalyst volume will be sized at approximately 2.5 times the engine displacement, and the combined DOC/CDPF volume will be approximately 1.7 times the engine displacement. For a typical locomotive engine with 6 ft³ of total cylinder displacement, the volume requirement for the aftertreatment components alone would be approximately 25 ft³ (of the 80 ft³ estimated to be available for packaging these components and their associated ducts/hardware above the engine).

EPA engineers have examined Tier 2 EMD and GE line-haul locomotives and acknowledge that packaging the necessary aftertreatment components will be a difficult task. However, this task should not be more difficult (and will quite likely be less so) than the packaging challenges faced by nonroad and on-highway applications. Given the space available on today's locomotives, we feel that packaging catalytic PM and NO_x emission control technologies onboard locomotives may be less challenging than packaging similar technologies onboard other mobile sources (such as light-duty vehicles, heavy-duty trucks, and nonroad equipment). Given that similar exhaust systems are either already implemented onboard these vehicles or will be implemented on these vehicles years before similar systems would be required onboard locomotives and marine vessels, we have concluded that any packaging issues will be successfully addressed early in the locomotive and marine vessel design

¹⁴⁷ "AAR Manual of Standards and Recommended Practices," Standard S-5510, Association of American Railroads.

process. Our analysis concludes that there is adequate space to package these components, as well as their associated ducts, transitions, and urea/exhaust mixing devices. This conclusion also applies to new switcher locomotives as well, which while being shorter in length than line-haul locomotives, are also equipped with smaller, less-powerful engines—resulting in smaller volume requirements for the aftertreatment components.

For commercial vessels which use marine diesel engines greater than 600 kW, we expect these vessels will be designed to accommodate the exhaust system components engine manufacturers specify as necessary to meet the new standards. Our discussions with marine architects and engineers, along with our review of vessel characteristics, leads us to conclude that for commercial marine vessels, adequate engine room space can be made available to package aftertreatment components. Packaging of these components, and analyzing their mass/placement effect on vessel characteristics, will become part of design process undertaken by marine architecture firms.¹⁴⁸

We did determine, however, that for recreational vessels and for vessels equipped with engines less than 600 kW, catalytic PM and NO_x exhaust aftertreatment systems were less practical from a packaging standpoint than for the larger, commercially operated vessels. We have identified catalytic emission control systems that would significantly reduce emissions from these smaller vessels. However, after taking into consideration costs, energy, safety, and other relevant factors, we found a number of reasons, detailed in the RIA, to not adopt any new exhaust aftertreatment-forcing standards at this time on these smaller vessels. One reason is that most of these vessels use seawater-cooled exhaust systems—and even seawater injection into their exhaust systems—to cool engine exhaust gases and prevent the overheating materials such as a fiberglass hull. This current practice of cooling and seawater injection could reduce the effectiveness of catalytic exhaust aftertreatment systems. This is significantly more challenging than for gasoline catalyst systems due to much larger relative catalyst sizes and cooler exhaust temperatures typical of diesel engines. In addition, because of these vessels' small size and their typical operation by planing high on the surface

¹⁴⁸ Telephone conversation between Brian King, Elliot Bay Design Group, and Brian Nelson, EPA, July 24, 2006.

of the water, catalytic exhaust aftertreatment systems pose several significant packaging and weight challenges. These challenges could be addressed by the use of lightweight hull and superstructure materials. But any solution which employs new, lightweight hull and superstructure materials would have to be developed, tested and approved by classifying organizations prior to their application on vessels using catalytic exhaust aftertreatment systems. Taken together, these factors led us to conclude that it is not prudent to set aftertreatment-forcing emission standards for marine diesel engines below 600 kW at this time.

(e) Infrastructure Impacts of Catalytic PM and NO_x Emission Control Technologies

For PM trap technology the rail and marine industries will experience minimal impacts on their infrastructures. Since PM trap technology relies on no separate reductant, any infrastructure impacts will be limited to some minor changes in maintenance practices and equipment at maintenance facilities. Such maintenance will be limited to the infrequent removal of ash buildup from within a PM trap. This type of maintenance may require that maintenance facilities periodically remove PM traps for ash cleaning and may involve the use of a crane or other lifting device. We understand that much of this kind of infrastructure already exists for other locomotive and marine engine maintenance practices. We have toured shipyards and locomotive maintenance facilities at rail switchyards, and we observed that such facilities are generally already adequate for any required PM trap removal and maintenance.

We do expect some impact on the railroad and marine sectors to accommodate the use of a separate reductant for use in a NO_x SCR system. For light-duty, heavy-duty, and nonroad applications, the commonly preferred reductant in an SCR system has been a 32.5 percent urea-water solution. The 32.5 percent solution, also known as the "eutectic" concentration, provides the lowest freezing point (−11 °C or 12 °F) and ensures that the ratio of urea-to-water will not change when the solution begins to freeze.¹⁴⁹ Heated urea storage tanks and insulation of the urea dosing hardware onboard the locomotive (urea storage tank, pump, and lines) may be

necessary to prevent freeze-up in northern climates. Locomotives and marine vessels are commonly refueled from large, centralized fuel storage tanks, tanker trucks, or tenders with long-term purchase agreements. Urea suppliers will be able to distribute urea to the locomotive and marine markets in a similar manner, or they may choose to employ multi-compartment diesel fuel/urea tanker trucks for delivery of both products simultaneously. The frequency that urea will need to be replenished is dependent on many factors; urea storage capacity, engine duty-cycle, and expected urea dosing rate for each application. We expect that locomotive manufacturers and marine vessel designers will size the urea storage tanks appropriate to the usage factors for each application plus some margin-of-safety (to reduce the probability that an engine will be operated without urea). Discussions concerning the urea infrastructure in North America and specifications for an emissions-grade urea solution are now under way amongst light- and heavy-duty on-highway diesel stakeholders.

Although an infrastructure for widespread transportation, storage, and dispensing of SCR-grade urea does not currently exist in the U.S., the affected stakeholders in the light- and heavy-duty on-highway and nonroad diesel sectors are expected to follow the European model, where diesel engine/truck manufacturers and fuel refiners/distributors have formed a collaborative working group known as "AdBlue." The goal of the AdBlue organization is to resolve potential problems with the supply, handling, and distribution of urea and to establish standards for product purity.¹⁵⁰ With regard to urea production capacity, the U.S. has more-than-sufficient capacity to meet the additional needs of the rail and marine industries. For example, in 2003, the total diesel fuel consumption for Class I railroads was approximately 3.8 billion gallons.¹⁵¹ If 100 percent of the Class I locomotive fleet were equipped with SCR catalysts, approximately 190 million gallons-per-year of 32.5 percent urea-water solution would be required.¹⁵² It is estimated that 190 million gallons of urea solution would require 0.28 million tons of dry urea (1

ton dry urea is needed to produce 667 gallons of 32.5 percent urea-water solution). Currently, the U.S. consumes 14.7 million tons of ammonia resources per year, and relies on imports for 41 percent of that total (of which, urea is the principal derivative). In 2005 domestic ammonia producers operated their plants at 66 percent of rated capacity, resulting in 4.5 million tons of reserve production capacity.¹⁵³ In the very long-term situation above, where 100 percent of the locomotive fleet required urea, only 6.2 percent of the reserve domestic capacity would be needed to satisfy the additional demand. A similar analysis for the marine industry, with a yearly diesel fuel consumption of 2.2 billion gallons per year, would not significantly impact the urea demand-to-reserve capacity equation. Since the rate at which urea-SCR technology is introduced to the railroad and marine markets will be gradual—and the reserve urea production capacity is more-than-adequate to meet the expected demand from all diesel markets in the 2017 timeframe—EPA does not project any urea cost or supply issues, beyond the costs estimated in the RIA, will result from implementing the Tier 4 standards.

(f) Unregulated Pollutants

There is potential for the formation of unregulated pollutants of significant concern to EPA any time engine technologies change, including when new emission control technologies are added. Some examples of these unregulated pollutants include N₂O and ammonia (NH₃). In addition, failure to dose urea in an SCR system while operating under load may cause elevated NO₂ emissions. Similarly, use of a CDPF that produces NO₂ in excess of what is needed for passive regeneration—and operated without a downstream SCR system—may lead to elevated NO₂ emissions. Such increased NO₂ emissions could be a concern for operation in enclosed environments such as locomotive operation in minimally ventilated or unventilated tunnels. Similarly, use of NO_x reduction catalysts with poor selectivity could result in elevated N₂O emissions. An aggressive urea dosing strategy within an SCR system (for high levels of NO_x control) without a properly designed/calibrated feedback control system, ammonia slip catalyst, or adequate exhaust/urea mixing could also result in elevated ammonia (NH₃) emissions.

¹⁵⁰ "Ensuring the Availability and Reliability of Urea Dosing for On-Road and Non-Road," presented by Glenn Barton, Terra Corp., 9th DEER Conference, August 28, 2003.

¹⁵¹ "National Transportation Statistics—2004," Table 4–5, U.S. Bureau of Transportation Statistics.

¹⁵² Assuming the dosing rate of 32.5 percent urea-water solution is 5 percent of the total fuel consumed; 3.8 billion gallons of diesel fuel * 0.05 = 190 million gallons of urea-water solution.

¹⁵³ "Mineral Commodity Summaries 2006," page 118, U.S. Geological Survey, online at www.minerals.usgs.gov/minerals/pubs/mcs/mcs2006.pdf.

¹⁴⁹ Miller, W. et al., "The Development of Urea-SCR Technology for US Heavy Duty Trucks," SAE Technical Paper 2000-01-0190, 2000.

These NH₃ emissions, which can be minimized through the use of closed-loop feedback and control of urea injection, can be all-but-eliminated through use of an oxidation catalyst downstream of the SCR catalyst. Such catalysts, commonly referred to as “slip catalysts,” are in use today and have been shown to be highly effective at eliminating ammonia emissions.¹⁵⁴

The issue of NH₃ emissions (or ammonia slip) was raised by several commenters, with claims that excessive NH₃ emissions are “inevitable”, and may reach 25 ppm during steady-state operation and 100 ppm during transient operation. We have assessed this issue and concluded that a properly-designed slip catalyst, with good selectivity to nitrogen (N₂), can convert most of the excess NH₃ released from the SCR catalyst into N₂ and water. Recent studies by Johnson Matthey and the Association for Emissions Control by Catalyst (AECC) have shown that an aged SCR system equipped with a slip catalyst can achieve tailpipe NH₃ levels of less than 10 ppm when tested on the European Stationary Cycle (ESC) and European Transient Cycle (ETC).^{154, 155} The SCR system in the Johnson Matthey study was aged on a cycle which included 400 hours of high-temperature operation at 650 °C (to simulate active DPF regeneration events). Our analysis of the locomotive engine operating conditions presumes a maximum, post-turbine exhaust temperature of 560 °C. This presumption is based on implementation of a “passive” DPF regeneration approach (in which NO₂ created by the oxidation catalyst is sufficient to oxidize trapped soot) and our own testing of locomotives during operation in non-ventilated tunnels.¹⁴² Under these conditions, we expect slip catalysts to be durable and effective in reducing NH₃ slip.

We expect manufacturers to be conscious of these possibilities and to take appropriate action to minimize or prevent the formation of unregulated pollutants when designing emission control systems. Manufacturers must comply with the “Prohibited Controls” section of 40 CFR 1033.115(c), which states:

“You may not design or produce your locomotives with emission control

devices, systems, or elements of design that cause or contribute to an unreasonable risk to public health, welfare, or safety while operating. For example, this would apply if the locomotive emits a noxious or toxic substance it would otherwise not emit that contributes to such an unreasonable risk.”

Emission control systems designed to meet the 2007 and 2010 heavy-duty truck and Tier 2 light-duty vehicle emission standards already take these unregulated pollutants into account through compliance with section 202(A)(4) of the Clean Air Act. CDPF systems that minimize formation of excess NO₂ while still relying primarily on passive regeneration have entered production for OEM and retrofit applications. Compact urea-SCR systems that have been developed to meet the U.S. 2010 heavy-duty truck standards use closed-loop controls that continuously monitor NO_x reduction performance. Such systems have the capability to control stack emissions of NH₃ to below 5 ppm during transient operation even without the use of an ammonia slip catalyst. We understand that such systems may still emit some very small level of uncontrolled pollutants and we would not generally consider a system that releases de minimis amounts of NH₃ or N₂O while employing technology consistent with limiting these emissions to be in violation of § 1033.115(c)—which is the same way we currently treat passenger cars and heavy-duty trucks with regard to N₂O and H₂S emissions.

(4) The New Standards Are Technologically Feasible

Our rulemaking involves a range of engines, and we have identified a range of technologically feasible emission control technologies that we project will be used to meet our new standards. Some of these technologies are incremental improvements to existing engine components, and many of these improved components have already been applied to similar engines. The other technologies we identified involve catalytic exhaust aftertreatment systems. For these technologies we carefully examined the catalyst technology, its applicability to locomotive and marine engine packaging constraints, its durability with respect to the lifetime of today’s locomotive and marine engines, and its impact on the infrastructure of the rail and marine industries. From our analysis, which is presented in detail in our RIA, we conclude that incremental improvements to engine components and the implementation of catalytic PM and NO_x exhaust aftertreatment

technology will be feasible to meet our new emissions standards.

IV. Certification and Compliance Program

This section describes the regulatory changes being finalized for the locomotive and marine compliance programs, beyond the standards discussed in section III. The most obvious change is that the regulations have been written in plain language. They are structured to contain the provisions that are specific to locomotives in a new part 1033 and the provisions that are specific to marine engines and vessels in a new part 1042. We also proposed to apply the general provisions of existing parts 1065 and 1068.¹⁵⁶ The plain language regulations, however, are not intended to significantly change the compliance program, except as specifically noted in today’s notice. These plain language regulations will supersede the regulations in part 92 and 94 (for Categories 1 and 2) as early as the 2008 model year. See section III for the starting dates for different engines. The changes from the existing programs are described below briefly along with other notable aspects of the compliance program. See the regulatory text for the detailed requirements and see the Summary and Analysis of Comments document for a more complete rationale for the changes being adopted. **Note:** The term manufacturer is used in this section to include locomotive and marine manufacturers and remanufacturers.

A. Issues Common to Locomotives and Marine

For many aspects of compliance, we are adopting similar provisions for marine engines and locomotives, which are discussed in this section. Several other issues are also included in this section, where we are specifying different provisions, but where the issues are similar in nature. The remaining compliance issues are discussed in sections IV.B. (for locomotives) and IV.C. (for marine).

(1) Test Procedures

(a) Incorporation of Part 1065 Test Procedures for Locomotive and Marine Diesel Engines

As part of our initiative to update the content, organization and writing style

¹⁵⁴ Smedler, Gudmund, “NO_x Emission Control Options”, 2007 HDD Emission Control Symposium—Gothenberg, Sweden, September 11, 2007.

¹⁵⁵ Searles, R.A., et al., “Investigation of Feasibility of Achieving EURO V Heavy-Duty Emission Limits with Advanced Emission Control Systems,” 2007 AECC Conference—Belgium, Paper Code: F02E310.

¹⁵⁶ We proposed modifications to the existing provisions of 40 CFR part 1068 on May 18, 2007 (72 FR 28097). Readers interested in the compliance provisions that will apply to locomotives and marine diesel engines should also read the actual regulatory changes in that will be finalized in that rulemaking.

of our regulations, we are revising our test procedures. We have grouped all of our engine dynamometer and field testing test procedures into one part entitled, "Part 1065: Test Procedures." For each engine or vehicle sector for which we have recently promulgated standards (such as land-based nonroad diesel engines or recreational vehicles), we identified an individual part as the standard-setting part for that sector. These standard-setting parts then refer to one common set of test procedures in part 1065. These programs regulate land-based on-highway heavy-duty engines, land-based nonroad diesel engines, recreational vehicles, and nonroad spark-ignition engines over 19 kW. In this rule, we are applying part 1065 to all locomotive and marine diesel engines, as part of a plan to eventually have all our engine programs refer to a common set of procedures.

In the past, each engine or vehicle sector had its own set of testing procedures. There are many similarities in test procedures across the various sectors. However, as we introduced new regulations for individual sectors, the more recent regulations featured test procedure updates and improvements that the other sectors did not have. As this process continued, we recognized that a single set of test procedures allows for improvements to occur simultaneously across engine and vehicle sectors. A single set of test procedures is easier to understand than trying to understand many different sets of procedures, and it is easier to move toward international test procedure harmonization if we only have one set of test procedures. We note that procedures that are particular for different types of engines or vehicles, for example, test schedules designed to reflect the conditions expected in use for particular types of vehicles or engines, remain separate and are reflected in the standard-setting parts of the regulations.

The part 1065 test procedures are organized and written to be clearer than locomotive- and marine-specific test procedures found in parts 92 and 94. In addition, part 1065 improves the content of the respective testing specifications, including the following:

- Specifications and calculations written in the international system of units (SI)
- Procedures by which manufacturers can demonstrate that alternate test procedures are equivalent to specified procedures
- Specifications for new measurement technology that has been shown to be equivalent or more accurate than existing technology

- Procedures that improve test repeatability
- Calculations that simplify emissions determination
- New procedures for field testing engines
- More comprehensive sets of definitions, references, and symbols
- Calibration and accuracy specifications that are scaled to the applicable standard, which allows us to adopt a single specification that applies to a wide range of engine sizes and applications.

We are adopting the lab-testing and field-testing specifications in part 1065 for all locomotive and marine diesel engines. These procedures replace those currently published in parts 92 and 94. We are making a gradual transition from the part 92 and 94 procedures. In general, we specify that manufacturers use the test procedures in 1065 when certifying under part 1033 or 1042. However, we will allow manufacturers to use a combination of the old and new test procedures through 2014, provided such use is done using good engineering judgment. Moreover, manufacturers may continue to rely on carryover test data based on part 92 or 94 procedures to recertify engine families that are not changing.

In the future, we may apply the test procedures specified in part 1065 to other types of engines, so we encourage companies involved in producing or testing other engines to stay informed of developments related to these test procedures.

(b) Revisions to Part 1065

Part 1065 was originally adopted on November 8, 2002 (67 FR 68242) and was initially applicable to standards regulating large nonroad spark-ignition engines and recreational vehicles under 40 CFR parts 1048 and 1051. The test procedures initially adopted in part 1065 were sufficient to conduct testing, but on July 13, 2005 (70 FR 11534) we promulgated a final rule that reorganized these procedures and added content to make various improvements. Today, we are finalizing additional modifications, largely as proposed. The reader is referred to the NPRM, the regulatory text, and the docket for more information about the changes being made to Part 1065 in this final rule. Note that since part 1065 applies for diesel engines subject to parts 86 and 1039, we are also making some minor revisions to those parts to reflect the changes being made to part 1065. (We are also making a technical correction to an equation in § 86.117-96.)

These changes will become effective July 7, 2008. Section 1065.10(c)(6) of the

existing regulations includes a provision that automatically allows manufacturers an additional 12 months beyond the effective date to revise their test procedures to comply with the new regulations. Since these changes will not affect the stringency of the standards, we also plan to use our authority under § 1065.10(c)(4) to allow the use of carryover data collected using the earlier procedures.

(2) Certification Fuel

It is well-established that measured emissions may be affected by the properties of the fuel used during the test. For this reason, we have historically specified allowable ranges for test fuel properties such as cetane and sulfur content. These specifications are intended to represent most typical fuels that are commercially available in use. This helps to ensure that the emissions reductions expected from the standards occur in use as well as during emissions testing.

In our previous regulation of in-use locomotive and marine diesel fuel, we established a 15 ppm sulfur standard at the refinery gate for locomotive and marine (LM) diesel fuel beginning June 1, 2012. However, since we intended to allow the sale, distribution, and use of higher sulfur LM diesel fuel (such as contaminated ULSD) to continue indefinitely, we did not set a "hard and fast" downstream requirement that only 15 ppm LM diesel may be sold and distributed in all areas of the country. Because refiners cannot intentionally produce off-specification fuel for locomotives, most in-use locomotive and marine diesel fuel will be ULSD (with a sulfur content of 15 ppm or less). Nevertheless, we expect that some fuel will be available with sulfur levels between 15 and 500 ppm, and our existing regulations require that such fuel be designated as 500 ppm sulfur diesel fuel. Note that fuel designated as 500 ppm sulfur is also known as low sulfur diesel fuel (LSD).

Because we have reduced the upper limit for locomotive and marine diesel fuel sulfur content for refiners to 15 ppm in 2012, we are establishing new ranges of allowable sulfur content for diesel test fuels. See section IV.C.(8) for information about testing marine engines designed to use residual fuel. For marine diesel engines, we are specifying the use of ULSD fuel as the test fuel for Tier 3 and later standards. We believe this will correspond to the fuels that these engines will see in use over the long term. We recognize that this approach will mean that some marine engines will use a test fuel that is lower in sulfur than in-use fuel

during the first few years and that other Tier 2 marine engines allowed to be produced after 2012 will use a test fuel that is higher in sulfur than fuel already available in use when they are produced. However, we believe that it is more important to align changes in marine test fuels with changes in the PM standards than strictly with changes in the in-use fuel. Nevertheless, we are allowing Tier 2 certification with fuel meeting the 7 to 15 ppm sulfur specification to simplify testing but will require that PM emissions be corrected to be equivalent to testing conducted with the specified fuel. This will ensure that the effective stringency of the Tier 2 standards will not be affected.

For locomotives, we will require that Tier 4 engines be certified based on ULSD test fuels. We are also requiring that these locomotives use ULSD in the field. We will continue to allow the use of 500 ppm LM diesel fuel, in older locomotives in the field.¹⁵⁷ Thus, we are requiring that remanufacture systems for Tier 0 and Tier 1 locomotives be certified on LSD test fuel. We are allowing the use of test fuels other than those specified here. Specifically, we will allow the use of ULSD during emission testing for locomotives otherwise required to use LSD, provided they do not use sulfur-sensitive technology (such as oxidation catalysts). However, as a condition of this allowance, the manufacturer will be required to add an additional amount to the measured PM emissions to make them equivalent to what would have been measured using LSD. For example, we will allow a manufacturer to test with ULSD if they adjusted the measured PM emissions upward by 0.01 g/bhp-hr (which would be a relatively conservative adjustment and would ensure that manufacturers would not gain an inappropriate advantage by testing on ULSD).

We are adopting special fuel provisions for Tier 3 locomotives and Tier 2 locomotive remanufacture systems. The final regulations specify that the test fuel for these be ULSD without sulfur correction since these locomotives will use ULSD in use for most of their service lives. However, unlike Tier 4 locomotives, we will not require them to be labeled to require the use of ULSD, unless they included sulfur sensitive technology.

We are adopting a new flexibility for locomotives and Category 2 marine

engines to reduce fuel costs for testing. Because these engines can consume 200 gallons of diesel fuel per hour at full load, fuel can represent a significant fraction of the testing cost, especially if the manufacturer must use specially blended fuel rather than commercially available fuel. To reduce this cost, we will allow manufacturers to immediately begin testing of locomotives and Category 2 marine engines with commercially available diesel fuel. We do not believe that this will change the effective stringency of the standards.

For both locomotive and marine engines, all of the specifications described above will apply to emission testing conducted for certification, production-line testing, and in-use, as well as any other testing for compliance purposes for engines in the designated model years. Any compliance testing of previous model year engines will be done with the fuels designated in our regulations for those model years.

(3) Supplemental Emission Standards

We are continuing the supplemental emission standards for locomotives and marine engines. For locomotives, this means we will continue to apply notch emission caps, based on the emission rates in each notch, as measured during certification testing. We recognize that for our Tier 4 standards it will not be practical to measure very low levels of PM emissions separately for each notch during testing, and thus we are changing the calculation of the PM notch cap for Tier 4 locomotives. All other notch caps will be determined and applied as they currently are under 40 CFR 92.8(c). See § 1033.101(e) of the regulations for the detailed calculation.

Marine engines will continue to be subject to not-to-exceed (NTE) standards; however, we are making certain changes to these standards based upon our understanding of in-use marine engine operation and based upon the underlying Tier 3 and Tier 4 duty cycle emissions standards. As background, we determine NTE compliance by first applying a multiplier to the duty-cycle emission standard, and then we compare to that value an emissions result that is recorded when an engine runs within a certain range of engine operation. This range of operation is called an NTE zone (see 40 CFR 94.106). The first regulation of ours that included NTE standards was the commercial marine diesel regulation, finalized in 1999. After we finalized that regulation, we promulgated other NTE regulations for both heavy-duty on-highway and nonroad diesel engines. We also

finalized a regulation that requires heavy-duty on-highway engine manufacturers to conduct field testing to demonstrate in-use compliance with the on-highway NTE standards. Throughout our development of these other regulations, we have learned many details about how best to specify NTE zones and multipliers that will ensure the greatest degree of in-use emissions control, while at the same time will avoid disproportionately stringent requirements for engine operation that has only a minor contribution to an engine's overall impact on the environment. Based upon the Tier 3 and Tier 4 standards—and our best information of in-use marine engine operation—we are making certain improvements to our marine NTE standards.

For marine engines we are broadening the NTE zones in order to better control emissions in regions of engine operation where an engine's emissions rates (i.e. grams/hour, tons/day) are greatest; namely at high engine speed and high engine load. This is especially important for commercial marine engines because they typically operate at steady-state at high-speed and high-load operation. This change also will make our marine NTE zones much more similar to our on-highway and nonroad NTE zones. Additionally, we analyzed different ways to define the marine NTE zones, and we determined a number of ways to improve and simplify the way we define and calculate the borders of these zones. We feel that these improvements will help clarify when an engine is operating within a marine NTE zone.

Note that we specify different duty cycles to which a marine engine may be certified, based upon the engine's specific application (e.g., fixed-pitch propeller, controllable-pitch propeller, constant speed, auxiliary, etc.). These duty cycles are described below in section IV.C.(9). Correspondingly, we also have a unique NTE zone for each of these duty cycles. These different NTE zones are intended to best reflect an engine's real-world range of operation for that particular application. One primary change in the NTE zones, compared to the NPRM, is for controllable-pitch propeller applications. Rather than using the nonroad NTE zone, as proposed, the final NTE zone for these engines has been revised to better reflect marine engine operation. Please refer to section 1042.101(c) of the new regulations for a description of our new NTE standards. In the cases where marine auxiliary engines use the same duty cycle as their land-based nonroad counterparts, we

¹⁵⁷ Under our existing fuel regulations (40 CFR 80.510(g)), 500 ppm LM diesel fuel may not be sold and/or distributed in the Northeast/Mid-Atlantic (NE/MA) area beginning October 1, 2012. Such fuel may no longer be used in the NE/MA area beginning December 1, 2012.

are adopting the same NTE standards as we have already finalized for nonroad engines in 40 CFR § 1039.101. As the standards for marine diesel engines under 75 kW are based on the corresponding nonroad engine standards, we are aligning the NTE standard start dates for these engines with the nonroad engine NTE start dates in 2012 and 2013.

We are also implementing new NTE multipliers. We have analyzed how the Tier 3 and Tier 4 emissions standards affect the stringency of the marine NTE standards, especially in comparison to the stringency of the underlying duty cycle standards. We recognized that in certain sub-regions of our new NTE zones, slightly higher multipliers are necessary because of the way that our more stringent Tier 3 and Tier 4 emissions standards will affect the stringency of the NTE standards. For comparison, Tier 2 marine NTE standards contain multipliers that range in magnitude from 1.2 to 1.5 times the corresponding duty cycle standard. The new multipliers range from 1.2 to 1.9 times the standard. Even with these slightly higher NTE multipliers, we are confident that our changes to the marine NTE standards will ensure the greatest degree of in-use emissions control. We are also confident that our changes to the marine NTE standards will continue to ensure proportional emissions reductions, across the full range of marine engine operation.

We are also adopting other NTE provisions for marine engines that are similar to our existing heavy-duty on-highway and nonroad diesel NTE standards. We are making these particular changes to account for the implementation of catalytic exhaust treatment devices on marine engines. One such provision is to account for when a marine engine rarely operates within a limited region of the NTE zone (i.e. less than 5 percent of in-use operation). Another provision allows small deficiencies in NTE compliance for a limited period of time. We feel that these provisions have been effective in our on-highway and nonroad NTE programs; therefore, we are adopting them for our marine NTE standards as well.

(4) Emission Control Diagnostics

We requested comment on a requirement that all Tier 4 engines include a simple engine diagnostic system to alert operators to general emission-related malfunctions. As is described in the S&A document, we are not adopting such general requirements today. (See section 0 of this Final Rule for related requirements involving SCR

systems.) We are, however, adopting special provisions for locomotives that include emission related diagnostics. First, we will require locomotive operators to respond to malfunction indicators by performing the required maintenance or inspection. Second, locomotive manufacturers will be allowed to repair such malfunctioning locomotives during in-use compliance testing (they would still be required to include a description of the malfunction in the in-use testing report.). This approach takes advantage of the unique market structure with two major manufacturers and only a few railroads buying nearly all of the freshly manufactured locomotives. These provisions create incentives for both the manufacturers and railroads to work together to develop a diagnostic system that would effectively reveal real emission malfunctions. Our current regulations already require that locomotive operators complete all manufacturer-specified emission-related maintenance, and this new requirement treats repairs indicated by diagnostic systems as such emission-related maintenance. Thus, the railroads will have a strong incentive to make sure that they only have to perform this additional maintenance when real malfunctions are occurring. On the other hand, manufacturers will want to have all emission malfunctions revealed so that when they test an in-use locomotive they can repair identified malfunctions before testing if the railroad has not yet done it.

(5) Monitoring and Reporting of Emissions Related Defects

We are applying the defect reporting requirements of § 1068.501 to replace the provisions of subparts E in parts 92 and 94. This will result in two significant changes for manufacturers. First, § 1068.501 obligates manufacturers to tell us when they learn that emission control systems are defective and to conduct investigations under certain circumstances to determine if an emission-related defect is present. Second, it changes the thresholds after which they must submit defect reports. See the text 40 CFR 1068.501 for details about this requirement.

(6) Rated Power

We are specifying in parts 1033 and 1042 how to determine maximum engine power in the regulations for both locomotives and marine engines. The term “maximum engine power” will be used for marine engines instead of previously undefined terms such as “rated power” or “power rating” to

specify the applicability of the standards. The addition of this definition is intended to allow for more objective applicability of the standards. More specifically, for marine engines, we define maximum engine power to mean the maximum brake power output on the nominal power curve for an engine.

For locomotives, the term “rated power” will continue to be used, but is explicitly defined to be the brakepower of the engine at notch 8. We will continue to use the term “rated power” because this definition is consistent with the commercial meaning of the term.

(7) In-Use Compliance for SCR Operation

As discussed in section III.C, we are projecting that manufacturers will use urea-based SCR systems to comply with the Tier 4 emission standards.¹⁵⁸ These systems are very effective at controlling NO_x emissions as long as the operator continues to supply urea of acceptable quality. Thus we considered concepts put forward by manufacturers in other mobile source sectors in dealing with this issue. These include design features to prevent an engine from being operated without urea if an operator ignores repeated warnings and allows the urea level to run too low. EPA has issued a guidance document for urea SCR systems discussing the use of such features on highway diesel vehicles.

We believe that the nature of the locomotive and large commercial marine sectors supports a different in-use compliance approach. This approach focuses on requirements for operators of locomotives and marine diesel engines that depend on urea SCR to meet EPA standards, aided by onboard alarm and logging mechanisms that engine manufacturers will be required to include in their engine designs. Except in the rare instance that operation without urea may be necessary, the regulatory provisions put no burden on the end-user beyond simply filling the urea tank with appropriate quality urea. Specifically, we are specifying:

- That it is illegal to operate without acceptable quality urea when the urea is needed to keep the SCR system functioning properly;
- That manufacturers must include clear and prominent instructions to the operator on the need for, and proper steps for, maintaining urea, including a

¹⁵⁸ The provisions described in this section will apply equally to SCR systems using reductants other than urea, except for systems using normal diesel fuel as the reductant.

statement that it is illegal to operate the engine without urea;

- That manufacturers must include visible and audible alarms at the operator's console to warn of low urea levels or inadequate urea quality;
- That engines and locomotives must be designed to track and log, in nonvolatile computer memory, all incidents of engine operation with inadequate urea injection or urea quality; and
- That operators must report to EPA in writing any incidence of operation with inadequate urea injection or urea quality within 30 days of each incident, and

- That, when requested, locomotive and vessel operators must provide EPA with access to, and assistance in obtaining information from, the electronic onboard incident logs.

We understand that in extremely rare circumstances, such as during a temporary emergency involving risk of personal injury, it may be necessary to operate a vessel or locomotive without adequate urea. We would intend such extenuating circumstances to be taken into account when considering what penalties or other actions are appropriate as a result of such operation. The information from SCR compliance monitoring systems described above may also be useful for state and local air quality agencies and ports to assist them in any marine engine compliance programs they implement.

Our new regulations specify that what constitutes acceptable urea solution quality be specified by the manufacturers in their maintenance instructions and require that the certified emission control system must meet the emissions standards with any urea solution within stated specifications. This could be facilitated by an industry standard for urea quality, which we expect will be generated in the future as these systems move closer to market. We recognize that this will

likely require automated sensing of some characteristic indicator such as urea concentration or exhaust NO_x concentration.

We believe these provisions can be an effective tool in ensuring urea use for locomotives and large commercial marine vessels because of the relatively small number of railroads and operators of large commercial vessels in the U.S., especially considering that the number of SCR-equipped locomotives and vessels will ramp up quite gradually over time. In-use compliance provisions of the sort we are adopting for locomotives and large commercial marine engines would be much less effective in other mobile source sectors such as highway vehicles because successful enforcement involving millions of vehicle owners would be extremely difficult. In addition, the highway and nonroad diesel sectors are characterized by a wide variety of applications and duty cycles, which further differentiate in-use compliance approaches that may make sense in the relatively uniform rail and marine sectors from those that would be effective in the highway and nonroad sectors.

(8) Temporary In-Use Compliance Margins

Consistent with the approach we took in the highway heavy-duty rule (66 FR 5113) and nonroad diesel rule (69 FR 38957), we are adopting a provision for in-use compliance flexibility in the initial years of the Tier 4 program. We proposed to allow adjusted in-use compliance standards for the first three model years of the Tier 4 locomotive standards to help assure the manufacturers that they will not face recall if they exceed standards by a small amount during this transition to advanced clean diesel technologies.

Commenters suggested that the reasons we gave for applying this provision to locomotives were valid for marine engines too. We agree and are

extending this provision to Tier 4 marine diesel engines. Commenters also argued that we over-emphasized the flexibility needed for NO_x technology compared to PM technology. In response, we have concluded that it is appropriate to provide an alternative set of margins available to manufacturers willing to accept more stringent in-use compliance levels for NO_x in exchange for somewhat less stringent levels for PM.

Table IV–1 shows the in-use adjustments that we will apply. These adjustments would be added to the appropriate standards or FELs in determining the in-use compliance level for a given in-use hours accumulation. Our intent is that these add-on levels be available only for highly-effective advanced technologies such as particulate traps and SCR, and so we will apply them only to engines certified at or below the Tier 4 standards without the use of credits, through the first three model years of the new standards. As part of the certification process, manufacturers will still be required to demonstrate compliance with the unadjusted Tier 4 certification standards using deteriorated emission rates. Therefore manufacturers will not be able to use these in-use adjustments in setting design targets for the engine. They need to project that engines will meet the standards in use without adjustment. The in-use adjustments merely provide some assurance that they will not be forced to recall engines because of some small miscalculation of the expected deterioration rates.

Also, to avoid what would essentially be a doubling up of the benefits of the two alternatives, contrary to their purpose, we are requiring that a manufacturer may only use the alternative set of add-ons for an engine family if this choice is indicated in the certification application and may not reverse this choice in carry-over certifications or certifications by design.

TABLE IV–1.—IN-USE ADD-ONS (g/bhp-hr)

For useful life fractions	Primary set		Alternative set	
	NO _x	PM	NO _x	PM
<50% UL	0.7	0.2	
50%–75% UL	1.0	0.01	0.3	0.03
>75% UL	1.3	0.4	

As discussed in section III.B(1)(a)(ii), in response to industry comments, we are providing another Tier 4 NO_x compliance option for line-haul locomotives with a reduced in-use NO_x

add-on of 0.6 g/bhp-hr. Under this option, for the first 8 model years of Tier 4 (2015–2022), a line-haul locomotive manufacturer may certify a locomotive to the 1.3 g/bhp-hr NO_x standard

without needing to calculate or apply a deterioration factor. These locomotives, when tested in-use, must comply with an in-use standard of 1.9 g/bhp-hr but

do not get the additional NO_x compliance margins discussed above.

Because this option is meant to address manufacturer concerns about manufacturing variability as well as catalyst durability, we are allowing manufacturers using this option to substitute an in-use locomotive test for each required production line test. These tests must be conducted on locomotives with more than 50 hours of accumulated operation, but at less than one-half of their useful life, and are in addition to normally-required manufacturer in-use testing. Furthermore, locomotives certified under this option may not generate credits under the ABT program because of their potentially higher in-use emissions. Also, of course, they may not be purposely designed to emit regulated pollutants at higher levels in use than at certification. This option will be available through the 2022 model year. It will not be available for the 2015–2022 model year locomotives when they are remanufactured in 2023 or later.

(9) Fuel Labels and Misfueling

The advanced emission controls that will be used to comply with many of the new standards will require the use of ULSD. Therefore, we are requiring that manufacturers notify each purchaser of a Tier 4 locomotive or marine engine that it must be fueled only with the ultra low-sulfur diesel fuel meeting our regulations. We are also applying this requirement for locomotives and engines having sulfur-sensitive technology and certified using ULSD. All of these locomotives and vessels must be labeled near the refueling inlet to say: “Ultra-Low Sulfur Diesel Fuel Only”. These labels are required to be affixed or updated any time any engine on a vessel is replaced after the new program goes into effect.

We are requiring the use of ULSD in locomotives and vessels labeled as requiring such use, including all Tier 4 locomotives and marine engines. More specifically, use of the wrong fuel for locomotives or marine engines would be a violation of 40 CFR 1068.101(b)(1) because use of the wrong fuel would have the effect of disabling the emission controls.

We addressed the supply of ultra-low sulfur fuel in our previous regulation of in-use locomotive and marine diesel fuel. Specifically, we established a 15 ppm sulfur standard at the refinery gate for locomotive and marine (LM) diesel fuel beginning June 1, 2012. However, since we allow the sale, distribution, and use of 500 ppm LM diesel fuel to continue indefinitely, we did not set a “hard and fast” downstream

requirement that only 15 ppm LM diesel may be sold and distributed in all areas of the country.¹⁵⁹ This was to allow the LM diesel fuel pool to remain an outlet for off-specification distillate product and interface/transmix material. Because refiners cannot intentionally produce off-specification fuel for locomotives—refiners will no longer be able to produce nonroad, locomotive, or marine diesel fuel above 15 ppm beginning June 1, 2012—most in-use locomotive and marine diesel fuel will be ULSD (with a sulfur content of 15 ppm or less). Nevertheless, we expect that some fuel will be available with sulfur levels between 15 and 500 ppm, and our regulations require such fuel to be designated as 500 ppm sulfur diesel fuel.

We received comments regarding the fact that we did not set a strict downstream requirement on the use of 15 ppm LM for the entire country. The commenters feared that while a port might receive deliveries of 15 ppm LM fuel, the port might keep its pump labeled as “500 ppm LM” to allow it to receive and dispense either 15 ppm or 500 ppm LM. (As part of the diesel fuel regulations, all pumps dispensing diesel fuel must be labeled with the type and maximum sulfur level of the diesel fuel being dispensed.) The commenters were concerned that if such practice were widespread, marine vessels that require ULSD could potentially have problems finding it.

We understand the commenters’ concerns and have discussed a few potential solutions to this problem. One possible option is to require large ports (i.e., ports over some certain size) to make 15 ppm LM diesel fuel available. This size requirement could be by volume of single sale or above some other specified volume. Under this requirement, those ports with multiple tanks could continue to offer 500 ppm LM diesel fuel in addition to the 15 ppm LM diesel fuel. Or, if a port (regardless of size) continues to sell 500 ppm LM diesel fuel, it must also sell 15 ppm LM diesel fuel. Another potential option would be to limit the sale of 500 ppm LM diesel fuel to small ports and locomotives only. However, these potential solutions would need to be discussed thoroughly with all stakeholders (including those in the fuel distribution and marketing industry) and put out for notice and comment. Therefore, we are merely noting

¹⁵⁹ However, in the Northeast/Mid-Atlantic (NE/MA) area, as defined at 40 CFR 80.510(g), 500 ppm LM diesel fuel may no longer be sold and/or distributed beginning October 1, 2012. Such fuel may no longer be used in the NE/MA area beginning December 1, 2012.

potential solutions in this final rule but we are committing to investigate this issue further and, if the facts warrant doing so, addressing it in a separate action.

(10) Deterioration Factor Plan Requirements

In this rulemaking, we are amending our deterioration factor (DF) provisions to include an explicit requirement that DF plans be submitted by manufacturers for our approval in advance of conducting engine durability testing, or in the case where no new durability testing is being conducted, in advance of submitting the engine certification application. We are not fundamentally changing either the locomotive or marine engine DF requirements with this provision, other than to require advance approval.

An advance submittal and approval format will allow us sufficient time to ensure consistency in DF procedures, without the need for manufacturers to repeat any durability testing or for us to deny an application for certification should we find the procedures to be inconsistent with the regulatory provisions. We expect that the DF plan would outline the amount of service accumulation to be conducted for each engine family, the design of the representative in-use duty cycle on which service will be accumulated, and the quantity of emission tests to be conducted over the service accumulation period.

(11) Production Line Testing

We proposed to continue the existing production line testing provisions that apply to manufacturers. Some manufacturers suggested that we should eliminate this requirement on the basis that very low noncompliance rates are being detected at a high expense. While we agree that compliance rates have been very good, we do not agree that they mean that the program has little or no value. As we move toward more stringent emission standards with this rulemaking, we anticipate that the margin of compliance with the standards for these engines is likely to decrease. Consequently, this places an even greater significance on the need to ensure little variation in production engines from the certification engine, which is often a prototype engine. For this reason, it is important to maintain our production line testing program.

However, the existing regulations allow manufacturers to develop alternate programs that provide equivalent assurance of compliance on the production line and to use such programs instead of the specified

production line testing program. For example, given the small sales volumes associated with marine engines it may be appropriate to include a production verification program for marine engines as part of a manufacturer's broader production verification programs for its non-marine engines. We believe these existing provisions already address the concerns raised to us by the manufacturers.

We are adding provisions to allow manufacturers to use special procedures for production line testing of catalyst-equipped engines. Under the existing Part 92 and Part 94 programs, a manufacturer of a catalyst-equipped locomotive or Category 2 marine engine would be required to assemble and test the engine with a complete catalyst system. At the manufacturer's choice, the engine could be broken in by operating it for up to 300 hours or it could be tested in a "green" state and its measured emissions adjusted by applying "green engine factors". The new regulations in Parts 1033 and 1042 will continue to allow these options, but will also include additional options.

For locomotives, the new regulations will allow a locomotive to be used in service for up to 1,000 hours before it is tested. This will be sufficient time to degreen a catalyst. We believe that this approach should work well for locomotives given the very close working relationships between the manufacturers and the major railroads. (See section IV.A.(8) for additional interim provisions related to production-line testing of locomotives.)

We do not believe this locomotive approach would work for marine engines because the marine market is much more diverse and the very close working relationships cannot be assumed. Therefore, we will rely on our general authority to approve alternate PLT programs. Should a consensus develop in the future about how to appropriately verify that engines and catalysts are produced to conform to the regulations, we may adopt specific regulatory provisions to address these marine engines.

(12) Evaporative Emission Requirements

While nearly all locomotives currently subject to part 92 are fueled with diesel fuel, § 92.7 includes evaporative emission provisions that would apply for locomotives fueled by a volatile liquid fuel such as gasoline or ethanol. These regulations do not specify test procedures or specific numerical limits, but rather set "good engineering" requirements. We are adopting these same requirements in part 1033.

We are also adopting similar requirements for marine engines and vessels that run on volatile fuels. We are not aware of any compression-ignition marine engines currently being produced that would be subject to these requirements but believe that it is appropriate to adopt these requirements now rather than waiting until such engines are produced. In this final rule, we are adopting requirements for controlling evaporative emissions that are identical to those for locomotives. As described in the proposal, we intend to apply to compression-ignition marine engines and vessels the same requirements we will be adopting for spark-ignition engines and vessels before the end of 2008 (as proposed at 72 FR 28098). We therefore intend to modify part 1042 in the final rule corresponding to that proposal related to spark-ignition marine engines and vessels. Specifically, if someone were to build a marine vessel with a compression-ignition engine that runs on a volatile liquid fuel, the engine would be subject to the exhaust emission standards of part 1042, but the fuel system would be subject to the evaporative emission requirements of the recently proposed part 1045.¹⁶⁰

(13) Small Business Provisions

There are a number of small businesses that will be subject to this rule because they are locomotive manufacturers/remanufacturers, railroads, marine engine manufacturers, post-manufacture marinizers, vessel builders, or vessel operators. We largely continue the existing provisions that were adopted previously for these small businesses in the 1998 Locomotive and Locomotive Engines Rule (April 16, 1998; 63 FR 18977); our 1999 Commercial Marine Diesel Engines Rule (December 29, 1999; 64 FR 73299) and our 2002 Recreational Diesel Marine program (November 8, 2002; 67 FR 68304). These provisions, which are discussed below, are designed to minimize regulatory burdens on small businesses needing added flexibility to comply with emission standards while still ensuring the greatest emissions reductions achievable. (See section IX.C of this rule for discussion of our outreach efforts with small entities.)

(a) Locomotive Sector

(i) Production-Line and In-Use Testing Does not Apply

Production-line and in-use testing requirements do not apply to small locomotive manufacturers until January

1, 2013, which is up to five calendar years after this program becomes effective.

In the 1998 Locomotive Rule (April 16, 1998; 63 FR 18977), the in-use testing exemption was provided to small remanufacturers with locomotives or locomotive engines that became new during the 5-year delay, and this exemption was applicable to these locomotives or locomotive engines for their entire useful life (the exemption was based on model years within the delay period, but not calendar years as we are promulgating today). As an amendment to the existing in-use testing exemption, small remanufacturers with these new locomotives or locomotive engines must now begin complying with the in-use testing requirements after the five-year delay on January 1, 2013 (exemption based on calendar years). Thus, they are no longer exempt from in-use testing for the entire useful life of a locomotive or a locomotive engine. We are finalizing this provision to ensure that small remanufacturers comply with our standards in-use, and subsequently, the public is assured they are receiving the air quality benefits of today's standards. In addition, this amendment provides a date certain for small remanufacturers when in-use testing requirements begin to apply.

We received a number of comments asking us to clarify whether or not we were still planning to require production-line audits or verification for small locomotive remanufacturers during this 5-year delay (until January 1, 2013). In response, we are clarifying that we did not intend to exempt small locomotive remanufacturers from production-line audits during the 5-year delay (our intent was to exempt these entities from production-line and in-use testing requirements). We believe this requirement is of minimal regulatory burden to small locomotive remanufacturers. Moreover, we have clarified the general auditing regulations to explicitly allow audits to be conducted by the owner/operator, which further minimizes the burden.

(ii) Class III Railroads Exempt From New Standards for Existing Fleets

EPA is limiting the category of small railroads which are exempt from the Tier 0, 1 and 2 remanufacturing requirements for existing fleets to those railroads that qualify as Class III railroads and that are not owned by a large parent company. Under the current Surface Transportation Board classification system, this exemption is limited to railroads having total revenue less than \$25.5 million per year. This change requires that all Class II

¹⁶⁰ Part 1045 was proposed on May 18, 2007 (72 FR 28097).

railroads, when remanufacturing their locomotives, meet the new standards finalized for existing fleets.

EPA had requested comment on whether the small railroads exemption from emissions standards for existing fleets had been effective and appropriate and whether they should continue under the new program finalized today. Under part 92, only railroads qualifying as "large" businesses, as defined by the Small Business Administration (SBA) were subject to the standards for their pre-existing fleet. The SBA definition of a large railroad is based on employment. For line-haul railroads the threshold is 1,500 or more employees, and for short-haul railroads it is 500 or more employees. Additionally, any railroad owned by a parent company that is large by SBA definition is also subject to the current existing fleet requirements. Although this excludes a majority of the more than 500 U.S. freight railroads, it addresses the vast majority of the emissions because it includes all Class I railroads.

The majority of comments supported revising the criterion for exempting railroads from emissions standards for existing fleets. While some of these commenter's felt that a revenue based approach exempting Class III railroads was appropriate, others disagreed, and argued that all railroads, regardless of classification or revenues should be subject to the new emission standards for existing fleets. These commenters felt no exemption would be legitimate because of both the extremely long operational life of these locomotive engines and the predominance of Class II and III railroads in various nonattainment areas of the country which contribute to air quality problems. Those commenters opposing any change to the existing exemption scheme argued that the current approach of exempting all small railroads should be retained because the costs involved in meeting new standards for existing fleets would impose a heavy financial burden on small railroads currently exempt from the program. Additionally, these commenters argued that small railroads' emissions are trivial and do not impact air quality.

In finalizing this new approach, EPA believes that continuing to exempt Class III railroads with annual revenues under \$25.5 million while including all Class II railroads in the existing fleet program is a reasonable approach that addresses both industry concerns regarding costs while also recognizing that small railroads do contribute to air pollution in areas they service including nonattainment areas throughout the U.S.

We are clarifying our definition that intercity passenger or commuter railroads are not included as railroads that are small businesses because they are typically governmental or are large businesses. Due to the nature of their business, these entities are largely funded through tax transfers and other subsidies. Thus, the only passenger railroads that could qualify for the small railroad provisions will be small passenger railroads related to tourism.

(iii) Small Railroads Excluded From In-Use Testing Program

The railroad in-use testing program continues to apply to Class I freight railroads only, and thus no small railroads are subject to this testing requirement. It is important to note many Class II and III freight railroads qualify as small businesses. This provision provides flexibility to all Class II and III railroads, which includes small railroads. All Class I freight railroads are large businesses.¹⁶¹

(iv) Hardship Provisions

Section 1068.245 of the existing regulations in title 40 contains hardship provisions for engine and equipment manufacturers, including those that are small businesses. We will apply this section for locomotives as described below.

Under the unusual circumstances hardship provision, locomotive manufacturers may apply for hardship relief if circumstances outside their control cause their failure to comply and if the failure to sell the subject locomotives will have a major impact on the company's solvency. An example of an unusual circumstance outside a manufacturer's control may be an "Act of God," a fire at the manufacturing plant, or the unforeseen shut down of a supplier with no alternative available. The terms and time frame of the relief depend on the specific circumstances of the company and the situation involved. As part of its application for hardship, a company is required to provide a compliance plan detailing when and how it will achieve compliance with the standards.

(b) Marine Sector

(i) Revised Definitions of Small-Volume Manufacturer and Small-Volume Boat Builder

As proposed, we are revising the definitions of small-volume

manufacturer (SVM) and small-volume boat builder to include worldwide production. Currently, an SVM is defined as a manufacturer with annual U.S.-directed production of fewer than 1,000 engines (marine and nonmarine engines), and a small-volume boat builder is defined as a boat manufacturer with fewer than 500 employees and with annual U.S.-directed production of fewer than 100 boats. By including worldwide production in these definitions, we prevent a manufacturer or boat builder with a large worldwide production of engines or boats, or a large worldwide presence, from receiving relief from the requirements of this program. The provisions that apply to small-volume manufacturers and small-volume boat builders as described below are intended to minimize the impact of this rule for those entities that do not have the financial resources to quickly respond to requirements in the rule.

(ii) Broader Engine Families and Testing Relief

Broader engine families: We are finalizing as proposed the provision that post-manufacture marinizers (PMMs) and SVMs be allowed to continue to group all commercial Category 1 engines into one engine family for certification purposes, all recreational engines into one engine family, and all Category 2 engines into one family. As with existing regulations, these entities are responsible for certifying based on the "worst-case" emitting engine. This approach minimizes certification testing because the marinizer and SVMs can use a single engine in the first year to certify their whole product line. In addition, marinizers and SVMs may then carry over data from year to year until changing engine designs in a way that might significantly affect emissions.

As described in the proposal, this broad engine family provision still requires a certification test and the associated burden for small-volume manufactures. We realize that the test costs are spread over low sales volumes, and we recognize that it may be difficult to determine the worst-case emitter without additional testing but we need a reliable, test-based, technical basis to issue a certificate for these engines. However, manufacturers will be able to use carryover test data to spread costs over multiple years of production.

Production-line and deterioration testing: In addition, as proposed, SVMs producing engines less than or equal to 600 kW (800 hp) are exempted from production-line and deterioration testing for the Tier 3 standards. We will assign a deterioration factor for use in

¹⁶¹ U.S. EPA, Assessment and Standards Division, Memorandum from Chester J. France to Alexander Cristofaro of U.S. EPA's Office of Policy, Economics, and Innovation, Locomotive and Marine Diesel RFA/SBREF A Screening Analysis, September 25, 2006.

calculating end-of-useful life emission factors for certification. This approach minimizes compliance testing since production-line and deterioration testing is more extensive than a single certification test. As described in the proposal, Tier 3 standards for these engines are not expected to require the use of aftertreatment—similar to the existing Tier 1 and Tier 2 standards. The Tier 4 standards for engines greater than 600 kW are expected to require aftertreatment emission-control devices. Currently, we are not aware of any SVMs that produce engines greater than 600 kW, except for one marinizer that plans to discontinue their production in the near future.¹⁶²

We are finalizing provisions that require SVMs to undertake production-line and deterioration testing in the future if they begin producing these larger engines due to the sophistication of manufacturers that produce engines with aftertreatment technology. We believe these manufacturers will have the resources to conduct both the design and development work for the aftertreatment emission-control technology, along with production-line and deterioration testing.

(iii) Delayed Standards

One-year delay: As described in the proposal, post-manufacture marinizers (PMMs) generally depend on engine manufacturers producing base engines for marinizing. This can delay the certification of the marinized engines. There may be situations in which, despite its best efforts, a marinizer cannot meet the implementation dates, even with the provisions described in this section. Such a situation may occur if an engine supplier without a major business interest in a marinizer were to change or drop an engine model very late in the implementation process or was not able to supply the marinizer with an engine in sufficient time for the marinizer to recertify the engine. Based on this concern, we are finalizing as proposed to allow a one-year delay in the implementation dates of the Tier 3 standards for post-manufacture marinizers qualifying as small businesses (the definition of small business, not SVM, used by EPA for these provisions for manufacturers of new marine diesel engines—or other engine equipment manufacturing—is 1,000 or fewer employees; as defined by the Small Business Administration's (SBA) regulations at 13 CFR 121.201)

and producing engines less than or equal to 600 kW (800 hp).

As described above and in the proposal, the Tier 4 standards for engines greater than 600 kW (800hp) are expected to require aftertreatment emission-control devices. We will not apply this one-year delay to small PMMs that begin marinizing these larger engines in the future due to the sophistication of entities that produce engines with aftertreatment technology. We expect that the large base engine manufacturer (with the needed resources), not the small PMM, will conduct both the design and development work for the aftertreatment emission-control technology and that they will also take on the certification responsibility in the future. Thus, the small PMM marinizing large engines will not need a one-year delay.

Three-year delay for not-to-exceed (NTE) requirements: As described in the proposal, additional lead time is also appropriate for PMMs to demonstrate compliance with NTE requirements. Their reliance on another company's base engines affects the time needed for the development and testing work needed to comply. Thus, as proposed, PMMs qualifying as small businesses and producing engines less than or equal to 600 kW (800hp) may also delay compliance with the NTE requirements by up to three years, for the Tier 3 standards. Three years of extra lead time (compared to one year for the primary certification standards) is appropriate considering their more limited resources. As described above and in the proposal, the Tier 4 standards for engines greater than 600 kW are expected to require aftertreatment emission-control devices. We do not apply this three-year delay to small PMMs that begin marinizing these larger engines in the future due to the sophistication of entities that produce engines with aftertreatment technology. We expect that the large base engine manufacturer (with the needed resources), not the small PMM, will conduct both the design and development work for the aftertreatment emission-control technology and that they will also take on the certification responsibility in the future. Thus, the small PMM marinizing large engines does not need a three-year delay for compliance with the NTE requirements.

Five-year delay for recreational engines: For recreational marine diesel engines, the existing regulations (2002 Recreational Diesel Marine program; November 8, 2002, 67 FR 68304) allow small-volume manufacturers up to a five-year delay for complying with the standards. However, as proposed, we

will not continue this provision. As discussed above and in the proposal, the Tier 3 standards for these engines are expected to be engine-out standards which do not require the use of aftertreatment—similar to the existing Tier 1 and Tier 2 standards. The Tier 4 standards will not apply to recreational engines. Also, Tier 3 engines are expected to require far less in terms of new hardware, and in fact, are expected to only require upgrades to existing hardware (i.e., new fuel systems). In addition, manufacturers have experience with engine-out standards from the existing Tier 1 and Tier 2 standards, and thus, they have learned how to comply with such standards. Thus, small-volume manufacturers of recreational marine diesel engines do not need more time to meet the new standards. For small PMMs of recreational marine diesel engines, the one-year delay described earlier will provide enough time for these entities to meet today's standards.

(iv) Engine Dressing Exemption

We are finalizing as proposed that marine engine dresser will continue to be exempt from certification and compliance requirements. As described in the proposal, many marine diesel engine manufacturers take a new, land-based engine and modify it for installation on a marine vessel. Some of these companies modifying an engine make no changes that might affect emissions. Instead, the modifications may consist of adding mounting hardware and a generator or reduction gears for propulsion. It can also involve installing a new marine cooling system that meets original manufacturer specifications and duplicates the cooling characteristics of the land-based engine but with a different cooling medium (such as sea water). In many ways, these manufacturers are similar to nonroad equipment manufacturers that purchase certified land-based nonroad engines to make auxiliary engines. This simplified approach of producing an engine can more accurately be described as dressing an engine for a particular application. As indicated above, engine dressers make changes to an engine without affecting the emission characteristics of the engine, which would include modifications that do not affect aftertreatment emission-control devices or systems (as stated earlier, Tier 4 standards for engines greater than 600 kW (800 hp) are expected to require aftertreatment).

Because the modified land-based engines are subsequently used on a marine vessel, however, these modified engines are considered marine diesel

¹⁶² U.S. EPA, Assessment and Standards Division, Memorandum from Chester J France to Alexander Cristofaro of U.S. EPA's Office of Policy, Economics, and Innovation, Locomotive and Marine Diesel RFA/SBREFA Screening Analysis, September 25, 2006.

engines, which then fall under these requirements. As described in the proposal, while we continue to consider them to be manufacturers of a marine diesel engine, they are not be required to obtain a certificate of conformity (as long as they ensure that the original label remains on the engine and report annually to EPA that the engine models that are exempt pursuant to this provision). This extends section 94.907 of the existing regulations. For further details of engine dressers responsibilities see section 1042.605 of the regulations.

(v) Vessel Builder Provisions

Current recreational marine engines regulations (2002 Recreational Diesel Marine program; November 8, 2002, 67 FR 68304) allow manufacturers with a written request from a small-volume boat builder to produce a limited number of uncertified engines (over a five year period)—an amount equal to 80 percent of the boat builders sales for one year. For builders with very small production volumes, this 80 percent allowance could be exceeded, as long as sales did not exceed 10 engines in any one year nor 20 total engines over five years and applied only to engines less than or equal to 2.5 liters per cylinder. We are not continuing this provision because recreational marine engines are subject only to the Tier 3 standards that are not expected to change the physical characteristics of engines (Tier 3 standards will not result in a larger engine or otherwise require any more space within a vessel). Because of the similarity to Tier 2 engine standards there will be no need for boat builders to redesign engine compartments thus eliminating the need for this 5 year delay provision.

(vi) Small Vessel Operators Exempt From New Standards for Existing Fleet

In the proposed rule, we requested comment on an alternative program option (Alternative 5: Existing Engines) that would for the first time set emission standards for marine diesel engines on existing vessels—the marine existing fleet or remanufacture program. As described earlier in section III.B.2.b, Remanufactured Marine Standards, we plan to finalize only the first part of this option requiring the owner of a marine diesel engine (vessel operator) to use a certified marine remanufacture system when the engine is remanufactured if such a system is available.

The marine existing fleet program will apply only to those commercial marine diesel engines (C1 and C2 engines) which meet the following criteria:

- Greater than 600 kW (800 hp);

- Tier 0 or Tier 1 engines for C1 engines;
- Tier 0, Tier 1 or Tier 2 engines for C2 engines;
- Built in model year 1973 or later; and
- Have a certified kit available at time of remanufacture.

We estimate that about 4 percent (or about 3,885 of 105,406 engines) of all C1 and C2 engines are subject to the existing fleet program and are likely to have certified kits available at the time of remanufacture. Thus, the percentage of vessels impacted by the remanufacture program is estimated to be similar.

Industry commented that a small portion of the vessel operators with engines greater than 600 kW (800 hp) are small businesses that would be significantly burdened by the existing fleet program. To address these comments, the requirements of the marine existing fleet program do not apply to owners of marine diesel engines or vessel operators with less than \$5 million in gross annual sales revenue. This threshold includes annual sales revenue from parent companies or affiliates of the owners/operators. (Small Business Administration's (SBA's) regulations at 13 CFR 121.103 describe how SBA determines affiliation.) If at some future date gross annual sales revenues are \$5 million or more, they become subject to the existing fleet program at that point. The \$5 million limit was chosen because a substantial sample of data for vessel operators—with vessels that have C1 and C2 engines greater than 600 kW—indicates that a significant portion of the total revenue for this sample set, about 80 percent, is generated by operators with \$5 million or more in annual sales revenue.¹⁶³

We expect that the amount of emissions from this sector correlates reasonably well with the amount of revenue generated (anticipate that revenue corresponds to activity which correlates well to emissions), and thus, most of the emissions from vessel operators (with engines greater than 600 kW (800 hp)) is obtained from those operators with \$5 million or greater in revenue. The \$5 million threshold for annual sales revenue is estimated to include about 8 percent less of the total vessel operator revenue compared to a \$10 million limit, while reflecting 15 percent more revenue than a \$1 million threshold. About 90 percent of all vessel operators with C1 and C2 engines have less than \$5 million in revenue. The

cost to remanufacture engines is a greater burden to the vessel operators with less than \$5 million in revenue (larger fraction of revenue, etc.) than those above this limit. Therefore, the \$5 million revenue threshold eliminates the regulatory burden for a substantial number of small vessel operators, while capturing a significant portion of the emissions from operators in the marine remanufacture program.

(vii) Hardship Provisions

Sections 1068.245, 1068.250 and 1068.255 of the existing title 40 regulations contain hardship provisions for engine and equipment manufacturers, including those that are small businesses. As proposed, we will apply these sections for marine applications such as PMMs, SVMs, and small-volume boat builders, which will effectively continue existing hardship provisions for these entities as described below.

In addition, for the marine existing fleet or remanufacture program, we are now providing these same hardship provisions to vessel operators or marine remanufacturers that qualify as small businesses. These provisions are described below.

Post-Manufacture Marinizers (PMMs), Small-Volume Manufacturers (SVMs), and Vessel Operators (or Marine Remanufacturers): As proposed, we are continuing two existing hardship provisions for PMMs and SVMs. In addition, we now extend these two provisions to small vessel operators or small marine remanufacturers for the marine existing fleet program. All of these entities may apply for this relief on an annual basis. First, under an economic hardship provision, PMMs, SVMs, and vessel operators (or marine remanufacturers) may petition us for additional lead time to comply with the standards. They must show that they have taken all possible business, technical, and economic steps to comply, but the burden of compliance costs will have a major impact on their company's solvency. As part of its application of hardship, a company is required to provide a compliance plan detailing when and how it plans to achieve compliance with the standards. Hardship relief could include requirements for interim emission reductions and/or purchase and use of emission credits. The length of the hardship relief decided during initial review is up to one year, with the potential to extend the relief as needed. We anticipate that one to two years is normally sufficient. Also, for PMMs and SVMs, if a certified base engine is available, they must generally use this

¹⁶³The Waterways Journal, Inc., 2006 Inland River Record.

engine. We believe this provision will protect PMMs and SVMs from undue hardship due to certification burden. Also, some emission reduction can be gained if a certified base engine becomes available. See the regulatory text in 40 CFR 1068.250 for additional information.

Second, under the unusual circumstances hardship provision, PMMs, SVMs, and vessel operators (or marine remanufacturers) may also apply for hardship relief if circumstances outside their control cause the failure to comply and if the failure to sell the subject engines will have a major impact on their company's solvency. An example of an unusual circumstance outside a manufacturer's control may be an "Act of God," a fire at the manufacturing plant, or the unforeseen shut down of a supplier with no alternative available (the second example is mainly for PMMs and SVMs). The terms and time frame of the relief depend on the specific circumstances of the company and the situation involved. As part of its application for hardship, a company is required to provide a compliance plan detailing when and how it will achieve compliance with the standards. We consider this relief mechanism to be an option of last resort. We believe this provision will protect PMMs, SVMs, and vessel operators (or marine remanufacturers) from circumstances outside their control. We, however, do not envision granting hardship relief if contract problems with a specific company prevent compliance for a second time. See the regulatory text in 40 CFR 1068.245 for additional information.

Small-volume boat builders: As proposed, we are continuing the unusual circumstances hardship provision for small-volume boat builders (those with less than 500 employees and worldwide production of fewer than 100 boats). Small-volume boat builders may apply for hardship relief if circumstances outside their control cause the failure to comply and if the failure to sell the subject vessels will have a major impact on the company's solvency. An example of an unusual circumstance outside a boat builder's control may be an "Act of God," a fire at the boat building facility, or the unforeseen breakdown of a supply contract with an engine supplier. This relief allows the boat builder to use an uncertified engine and is considered a mechanism of last resort. The terms and time frame of the relief depend on the specific circumstances of the company and the situation involved. As part of its application for hardship, a

company is required to provide a compliance plan detailing when and how it plans to achieve compliance with the standards. See the regulatory text in 40 CFR 1068.250 for additional information.

In addition, as described in the proposal, small-volume boat builders generally depend on engine manufacturers to supply certified engines in time to produce complying vessels by the date emission standards begin to apply. We are aware of other applications where certified engines have been available too late for equipment manufacturers to adequately accommodate changing engine size (for engines meeting Tier 4 standards, which are described in section III.B.2 of today's rule)¹⁶⁴ or performance characteristics. To address this concern, we are allowing small-volume boat builders to request up to one extra year before using certified engines if they are not at fault and will face serious economic hardship without an extension. See the regulatory text in 40 CFR 1068.255 for additional information.

(14) Alternate Tier 4 NO_x+HC Standards

We proposed to continue our existing emission averaging programs for the new Tier 4 NO_x and HC standards for locomotives and marine engines. However, the existing averaging programs do not allow manufacturers to show compliance with HC standards using averaging. Because we are concerned that this could potentially limit the benefits of our averaging program as a phase-in tool for manufacturers, we are establishing an alternate NO_x+HC standard of 1.4 g/bhp-hr that could be used as part of the averaging program. Manufacturers that were unable to comply with the Tier 4 HC standard would be allowed to certify to a NO_x+HC FEL, and use emission credits to show compliance with the alternate standard instead of the otherwise applicable NO_x and HC standards. For example, a manufacturer may choose to use banked emission credits to gradually phase in its Tier 4 1200 kW marine engines by producing a mix of Tier 3 and Tier 4 engines during the early part of 2014. NO_x+HC credits and NO_x credits could be averaged together without discount.

¹⁶⁴ Tier 3 engine-out standards are not expected to change the physical characteristics of marine engines. Tier 3 standards will not result in a larger engine or otherwise require any more space within a vessel. For Tier 4 standards, we expect that vessels will be designed to accommodate emission components that engine manufacturers specify as necessary to meet these new standards (e.g., ensure adequate space is available to package aftertreatment components).

The value of this alternate standard (1.4 g/bhp-hr) is the rounded sum of the Tier 4 NO_x and HC standards. We proposed to set this value at the level of the NO_x standard (1.3 g/bhp-hr). However, based on the comments received, we no longer believe this to be appropriate. See the Summary and Analysis of Comments for more discussion of this issue.

(15) Other Issues

We are finalizing other minor changes to the compliance program. For example, engine manufacturers will be required to provide installation instructions to vessel manufacturers and kit installers to ensure that engine cooling systems, aftertreatment exhaust emission controls, and other emission controls are properly installed. Proper installation of these systems is critical to the emission performance of the equipment. Vessel manufacturers and kit installers will be required to follow the instructions to avoid improper installation that could render emission controls inoperative. Improper installation would subject them to penalties equivalent to those for tampering with the emission controls.

We are also clarifying the general requirement that no emission controls for engines subject to this final rule may cause or contribute to an unreasonable risk to public health, welfare, or safety, especially with respect to noxious or toxic emissions that may increase as a result of emission-control technologies. The regulatory language, which addresses the same general concept as the existing §§ 92.205 and 94.205, implements sections 202(a)(4) and 206(a)(3) of the Act and clarifies that the purpose of this requirement is to prevent control technologies that would cause unreasonable risks, rather than to prevent trace emissions of any noxious compounds. This requirement prevents the use of emission-control technologies that produce pollutants for which we have not set emission standards but nevertheless pose a risk to the public. As is described in Section III and the Summary and Analysis of Comments document, this provision does not preclude the use of urea-based SCR emission controls.

Some marine engine manufacturers have expressed concern over the current provisions in our regulation for selection of an emission data engine. Part 94 specifies that a marine manufacturer must select for testing from each engine family the engine configuration which is expected to be worst-case for exhaust emission compliance on in-use engines. Some manufacturers have interpreted this to

mean that they must test all the ratings within an engine family to determine which is the worst-case. Understandably, this interpretation could cause production problems for many manufacturers due to the lead time needed to test a large volume of engines. Our view is that the current provisions do not necessitate testing of all ratings within an engine family. Rather, manufacturers are allowed to base their selection on good engineering judgment, taking into consideration engine features and characteristics which, from experience, are known to produce the highest emissions. This methodology is consistent with the provisions for our on-highway and nonroad engine programs. Therefore, we are keeping essentially the same language in part 1042 as is in part 94. We are adopting similar language for locomotives and will apply it in the same manner as we do for marine engines.

B. Compliance Issues Specific to Locomotives

(1) Refurbished Locomotives

Section 213(a)(5) of the Clean Air Act directs EPA to establish emission standards for “new locomotives and new engines used in locomotives.” In the previous rulemaking, we defined “new locomotive” to mean a freshly manufactured or remanufactured locomotive.¹⁶⁵ We defined “remanufacture” of a locomotive as a process in which all of the power assemblies of a locomotive engine are replaced with freshly manufactured (containing no previously used parts) or reconditioned power assemblies. In cases where all of the power assemblies are not replaced at a single time, a locomotive is considered to be “remanufactured” (and therefore “new”) if all of the power assemblies from the previously new engine had been replaced within a five year period.

Our new regulations clarify the definition of “freshly manufactured locomotive” when an existing locomotive is substantially refurbished including the replacement of the old engine with a freshly manufactured engine. The existing definition in § 92.12 states that freshly manufactured locomotives are locomotives that do not contain more than 25 percent (by value) previously used parts. We allowed freshly manufactured locomotives to

contain up to 25 percent used parts because of the current industry practice of using various combinations of used and unused parts. This 25 percent value applies to the dollar value of the parts being used rather than the number because it more properly weights the significance of the various used and unused components. We chose 25 percent as the cutoff because setting a very low cutoff point would have allowed manufacturers to circumvent the more stringent standards for freshly manufactured locomotives by including a few used parts during the final assembly. On the other hand, setting a very high cutoff point could have required remanufacturers to meet standards applicable to freshly manufactured locomotives, but such standards may not have been feasible given the technical limitations of the existing chassis.

We are adding to § 1033.901 a definition of “refurbish” which will mean the act of modifying an existing locomotive such that the resulting locomotive contains less than 50 percent (by value) previously used parts (but more than 25 percent). We believe that where an existing locomotive is improved to this degree, it is appropriate to consider it separately from locomotives that are simply remanufactured in a conventional sense. As described below, we are specifying provisions for refurbished locomotives that vary by application (switch or line-haul) and model year (before or after 2015). See also section IV.B(2), which describes minimum credit proration factors for refurbished locomotives.

We are also clarifying that any locomotives built before 1973 become “new” and thus subject to our emission standards when refurbished. In the 1998 rulemaking, we determined that pre-1973 locomotives should not be considered “new” when remanufactured.¹⁶⁶ An important policy consideration in making that determination was our analysis of the feasibility of such locomotives to meet the Tier 0 emission standards. However, that analysis is not valid for refurbished locomotives. Given the degree to which such locomotives are redesigned and reconfigured, there is no reason that they should be considered differently from 1973 locomotives simply because their frames (or some other parts) were originally manufactured earlier.

We requested comment on setting more stringent standards for refurbished locomotives, considering that these

locomotives are restored to a condition likely to allow for many years of continued service. Industry commenters expressed concern that our subjecting refurbished locomotives to more stringent standards could prove counterproductive, because state and local programs that currently help fund voluntary refurbishments to very clean emission levels could lose their incentive to continue doing so, given that these refurbishments would now just be meeting EPA standards. It was further argued that these refurbishments would also lose any opportunity to generate valuable ABT credits, given the challenge just in meeting the standards.

We believe that the need for financial incentives will be just as clear and just as strong under the new program as before. Refurbishing a locomotive effectively removes an old, high-emitting locomotive from the fleet and replaces it with a clean one. The substantial cost of doing so and the potential that, absent incentives, old locomotives (especially switchers) would continue in operation almost indefinitely are the true drivers for creating incentives, regardless of the standards involved. We expect that state and local government officials involved in this process are well aware of this and will act accordingly. The ABT credits that can be gained from these refurbishments have not been a major factor to date and, considering that the credits can subsequently be used to produce other, less clean locomotives, we do not believe that state and local governments would or should be satisfied to help finance clean locomotives that result in dirtier locomotives elsewhere. As detailed below, we are therefore adopting more stringent standards for refurbished locomotives and phasing in these standards in a way that we believe best facilitates continued refurbishment of existing locomotives, while recognizing differences between the switch and line-haul locomotive fleets and the emission reduction trends resulting from our tiered approach to standards-setting.

Currently, small numbers of old low-horsepower locomotives are being refurbished as significantly lower-emitting switch locomotives. The regulations in part 92 subject these locomotives to the Tier 0 standards (unless they contain less than 25 percent previously used parts) and allow them to generate emission credits if they are cleaner than required. The regulations in part 1033 will continue this approach through model year 2014. It is important to note that since most of these locomotives were originally manufactured before 1973, simply by

¹⁶⁵ As is described in this section, freshly manufactured locomotives, repowered locomotives, refurbished locomotives, and all other remanufactured locomotives are all “new locomotives” in both the previous and new regulations.

¹⁶⁶ “Locomotive Emission Standards: Regulatory Support Document”, APPENDIX L, “Exclusion of Pre-1973 Locomotives”, April 1998.

meeting the Tier 0 standards they will achieve significant emission reductions.

For similar reasons, we are adopting an interim program for slightly larger locomotives with power between 2300 and 3000 horsepower refurbished through model year 2014. These locomotives, which are frequently used as road switchers, would also be subject to the Tier 0 standards for this period.

We do not believe, however, that it would be appropriate to allow switch locomotives to be refurbished to the Tier 0+ standards in the long term. Once the Tier 4 standards begin to apply, we will allow these locomotives to be certified to the Tier 3 switch locomotive standards, which will still provide the

opportunity to generate some emission credits as an incentive.

The story is slightly different for higher power line-haul locomotives, which are currently not being refurbished. Nearly all of these remaining in the Class I railroad fleets were originally manufactured in or after 1973 and are already subject to the Tier 0 or later standards. Therefore there will be less of an air quality incentive to fund their refurbishment, and so we are specifying that refurbished line-haul locomotives be subject to the same standards as freshly manufactured locomotives. The regulations would treat them the same except for emission credit proration factors, which are described in section IV.B.(2)

Another important consideration is the potential for refurbishment to be used as a loophole to circumvent the freshly manufactured standards for line-haul locomotives. Railroads currently turn over their line-haul fleets much faster than their switch fleets. However, it is not hard to envision a scenario in which railroads began refurbishing their locomotives rather than buying freshly manufactured locomotives, especially as the Tier 4 standards went into effect. A long-term program requiring that refurbished line-haul locomotives meet the same standards as freshly manufactured locomotives prevents refurbishment from being used as such a loophole.

TABLE IV-2.—PROVISIONS FOR REFURBISHED SWITCH LOCOMOTIVES

	Applicable tier of standards	Minimum proration factor
Locomotives refurbished before 2015	Tier 0+	0.60
Locomotives refurbished in 2015 or later	Tier 3	0.60

TABLE IV-3.—PROVISIONS FOR REFURBISHED LINE-HAUL LOCOMOTIVES

	Applicable tier of standards	Minimum proration factor
Locomotives refurbished before 2015	Tier 2+/3	0.60
Locomotives refurbished in 2015 or later	Tier 4	0.60

(2) Averaging, Banking and Trading

For the most part, our new regulations will continue the existing averaging banking and trading provisions for locomotives. This section only highlights the provisions that are most significant in the context of this Final Rule. The reader is encouraged to read subpart H of part 1033 for details of this program.

In order to ensure that the ABT program is not used to delay the implementation of the Tier 4 technology, we are applying a restriction similar to the averaging restriction that was adopted for Tier 2 locomotives in the previous locomotive rulemaking. We are restricting the number of Tier 4 locomotives that could be certified using credits to no more than 50 percent of a manufacturer's annual production. As was true for the earlier restriction, this is intended to ensure that progress is made toward compliance with the advanced technology expected to be needed to meet the Tier 4 standards. This will encourage manufacturers to make every effort toward meeting the Tier 4 standards, while allowing some use of banked credits to provide needed lead time in implementing the Tier 4

standards by 2015, allowing them to appropriately focus research and development funds.

We proposed to allow the carryover of all Part 92 credits except for PM credits generated from Tier 0 or Tier 1 locomotives. The Tier 0 and Tier 1 PM standards under part 92 were set above the average baseline level to act as caps on PM emissions rather than technology-forcing standards. While Part 92 allows credits generated only relative the estimated average baseline rather than the standards, we were still concerned that such credits might have been windfall credits. However, as is described in the Summary and Analysis of Comments document, after further analysis we now believe that allowing the carryover of all part 92 PM credits is appropriate and will allow such credits to be used under part 1033.

We are also updating the proration factors for credits generated or used by remanufactured locomotives. The updated proration factors better reflect the difference in service time for line-haul and switch locomotives. The ABT program is based on credit calculations that assume as a default that a locomotive would remain at a single FEL for its full service life (from the

point it is originally manufactured until it is scrapped). However, when we established the existing standards, we recognized that technology would continue to evolve and that locomotive owners may wish to upgrade their locomotives to cleaner technology and certify the locomotive to a lower FEL at a subsequent remanufacture. We established proration factors based on the age of the locomotive to make calculated credits for remanufactured locomotives consistent with credits for freshly manufactured locomotives in terms of lifetime emissions. These proration factors are shown in § 1033.705 of the new regulations. These replace the existing proration factors of § 92.305. For example, using the new proration factors, a 15-year-old line-haul locomotive certified to a new FEL that was 1.00 g/bhp-hr below the applicable standard would generate the same amount of credit as a freshly manufactured locomotive that was certified to an FEL that was 0.43 g/bhp-hr below the applicable standard because the proration factor would be 0.43. For comparison, under the old regulations, the proration factor would have been 0.50.

We are correcting how the proration factors apply for refurbished locomotives to more appropriately give credits to railroads for upgrading old locomotives to use clean engines, rather than to continue using the old high emission engines indefinitely. As with the rest of the program, credits will be calculated from the difference between the applicable standard and the emissions of the new refurbished locomotive, adjusted to account for the projected time the locomotive would remain in service. The correction creates a floor for the credit proration factor for refurbished locomotives of 0.60. This is equal to the proration factor for 20-year-old switchers and would also be equivalent to a proration factor for a locomotive that was just over 10 years old. For example, refurbishing a 35-year-old switch locomotive to an FEL 1.0 g/bhp-hr below the Tier 0 standard would generate the same amount of credit as a conventional remanufacture of a 20-year-old switch locomotive to an FEL 1.0 g/bhp-hr below the Tier 0 standard. This is because we believe that such refurbished switch locomotives will almost certainly operate as long as a 20-year-old locomotive that was remanufactured at the same time. Similarly, we believe that refurbished line-haul locomotives would likely operate as long as a 10-year-old locomotive that was remanufactured at the same time.

Finally, we are finalizing special provisions for credits generated and used by Tier 3 and later locomotives. Under the current part 92 ABT program, credits are segregated based on the cycle over which they are generated but not by how the locomotive is intended to be used (switch, line-haul, passenger, etc.). Line-haul locomotives can generate credits for use by switch locomotives, and vice versa, because both types of locomotives are subject to the same standards. However, for the Tier 3 and Tier 4 programs, switch and line-haul locomotives are subject to different standards with emissions generally measured only for one test cycle. We will allow credits generated by Tier 3 or later switch locomotives over the switch cycle to be used by line-haul locomotives to show compliance with line-haul cycle standards. As proposed, we are not allowing such cross-cycle use of line-haul credits (or switch credits generated by line-haul locomotives) by Tier 3 or later switch locomotives.

To make this approach work without double-counting of credits, we are also adopting a special calculation method where the credit using locomotive is subject to standards over only one duty cycle while the credit generating

locomotive is subject to standards over both duty cycles (and can thus generate credits over both cycles). In such cases, we would require the use of credits under both cycles. For example, for a Tier 4 line-haul engine family needing 1.0 megagram of NO_x credits to comply with the line-haul emission standard, the manufacturer would have to use 1.0 megagram of line-haul NO_x credits and 1.0 megagram of switch NO_x credits if the line-haul credits were generated by a locomotive subject to standards over both cycles.

(3) Phase-In and Reasonable Cost Limit

The new Tier 0 and 1 emission standards become applicable on January 1, 2010. We also proposed a requirement for 2008 and 2009 when a remanufacturing system is certified to these new standards. If such a system is available before 2010 for a given locomotive model at a reasonable cost, remanufacturers of those locomotives may no longer remanufacture them to the previously applicable standards. They must instead comply with the new Tier 0 or 1 emission standards when they are remanufactured. Similarly, we are requiring them to use certified Tier 2 systems for 2008 through 2012 when a remanufacturing system is certified to the new Tier 2 standards. For the purposes of this provision, "reasonable cost" means that the total incremental cost to the operators of the locomotive (including initial hardware, increased fuel consumption, and increased maintenance costs) during the useful life of the locomotive must be less than \$250,000. This cost limit is based on the upper cost we think likely to be required to meet these standards and reflects comments on our NPRM from remanufacturers.

As part of this phase-in requirement, we are requiring certifiers to notify customers that they are applying for certificate such that their locomotives will become subject to the new standards. We would then allow owners/operators a minimum 90-day grace period (after we issue the certificate) in which they could remanufacture their locomotives to the previously applicable standards once they are notified by the certificate holder that such systems are available. This allows them to use up inventory of older parts. However, where the certifiers do not immediately notify them, railroads would be allowed a grace period of at least 120 days after they are notified. This combined approach allows sufficient time to find out about the availability of kits and to make appropriate plans for compliance. We are also adding a new provision for

owners/operators that limits the total number of locomotives that would need to meet the new standards during 2008 and 2009 to a fraction of the total number of remanufactures they do between October 3, 2008 and December 31, 2009 that are subject to either the old or new standards.

We are adding provisions that would allow Tier 0/1 remanufacturers to use during the phase-in period an assigned deterioration factor of 0.03 g/bhp-hr for PM and assume that all other deterioration factors are zero. We will also apply an in-use PM add-on of 0.03 g/bhp-hr. These two provisions are intended to address lead time concerns raised by commenters. The commenters correctly point out that the available lead time is not sufficient to allow remanufacturers to verify durability of the emission controls in a more conventional way. By addressing this lead time issue, we will make it more likely that the low emission kits will be brought to market early.

(4) Recertification Without Testing

Once manufacturers have certified an engine family, we have historically allowed them to obtain certificates for subsequent model years using the same test data if the engines remain unchanged from the previous model year. We refer to this type of certification as "carryover." We are also extending this allowance to owner/operators. Specifically, we are adding the following paragraph to the end of § 1033.240:

(c) An owner/operator remanufacturing its locomotive to be identical to the previously certified configuration may certify by design without new emission test data. To do this, submit the application for certification described in § 1033.205, but instead of including test data, include a description of how you will ensure that your locomotives will be identical in all material respects to their previously certified condition. You have all of the liabilities and responsibilities of the certificate holder for locomotives you certify under this paragraph.

(5) Railroad Testing

Section 92.1003 requires Class I freight railroads to annually test a small sample of their locomotives. We proposed to adopt the same requirements in § 1033.810, but asked for comments on whether this program should be changed. In particular, we requested suggestions to better specify how a railroad selects which locomotives to test, which has been a source of some confusion in recent years. In this final rule, we are adopting a revised approach that should reduce this confusion. The regulations provide four options for railroads to select

locomotives for testing and require EPA to notify the railroad by January 1st for any year in which we choose to specify which locomotives should be tested.

In addition, the maximum annual testing rate is being lowered to 0.075 percent, from the previously applicable rates of 0.15 to 0.10 percent. This new rate will require Class I railroads to test approximately 20 locomotives per year. We believe that this number of tests (in addition to the testing required for certificate holders) will be enough to allow us to appropriately monitor the emission performance of in-use locomotives.

(6) Test Conditions and Corrections

In our previous rule, we established test conditions that are representative of in-use conditions. Specifically, we required that locomotives comply with emission standards when tested at temperatures from 45°F to 105°F and at both sea level and altitude conditions up to about 4,000 feet above sea level. One of the reasons we established such a broad range was to allow outdoor testing of locomotives. While we only required that locomotives comply with emission standards when tested at altitudes up to 4,000 feet for purposes of certification and in-use liability, we also required manufacturers to submit evidence with their certification applications, in the form of an engineering analysis, that shows that their locomotives were designed to comply with emission standards at altitudes up to 7,000 feet. We included correction factors that are used to account for the effects of ambient temperature and humidity on NO_x emission rates.

We are now changing how the regulations deal with the test temperatures. We are specifying that testing without correction may be performed down to a lower limit of 60°F. In implementing the prior regulations, we found that the broad temperature range with correction, which was established to make testing more practical, was problematic. Given the uncertainty with the existing correction, manufacturers have generally tried to test in the narrower range being adopted today. However, we will still allow manufacturers to test at lower temperatures but will require them to develop correction factors specific to their locomotive designs.

We are also changing the altitude requirements for switch locomotives in response to a comment noting that switch locomotives will rarely operate above 5,500 feet. For switch locomotives, we will only require manufacturers to show that their

locomotives comply with emission standards at altitudes up to 5,500 feet.

(7) Duty Cycles and Calculations

(a) Idle Weighting Adjustments

While we did not propose any changes to the weighting factors for the locomotive duty cycles, we did request comment on whether such changes would be appropriate in light of the proposed idle reduction requirements. The regulations specify an alternate calculation for locomotive equipped with idle shutdown features. This provision allows a manufacturer to appropriately account for the inclusion of idle reduction features as part of its emission control system. There are three primary reasons why we are not changing the calculation procedures with respect to the idle requirements. First, different shutdown systems will achieve different levels of idle reduction in use. Thus, no single adjustment to the cycle would appropriately reflect the range of reductions that will be achieved. Second, the existing calculation provides an incentive for manufacturers to design shutdown systems that achieve in the greatest degree of idle reduction that is practical. Finally, our feasibility analysis is based in part on the emission reductions achievable relative to the existing standards. Since some manufacturers already rely on the calculated emission reductions from shutdown features incorporated into many of their locomotive designs, our feasibility is based in part on allowing such calculations.

We are adopting a slight change to the way this adjustment works as compared to the previous regulations. We are specifying that idle emission rates for locomotives meeting our minimum shutdown requirements in § 1033.115 be reduced by 25 percent, unless the manufacturer demonstrates that greater idle reduction will be achieved.

(b) Representative Cycles

We also recognize that the potential exists for locomotives to include additional power notches, or even continuously variable throttles, and that the standard FTP sequence for such locomotives would result in an emissions measurement that does not accurately reflect their in-use emissions performance. Moreover, some locomotives may not have all of the specified notches, making it impossible to test them over the full test. Under the previous regulations, we handled such locomotives under our discretion to allow alternate calculations (40 CFR 92.132(e)). We are now adopting more

specific provisions in § 1033.520. In general, for locomotives missing duty cycle weighting factors should be reweighted without the missing notches. For locomotives without notches or more than 8 power notches, the regulations reference following information provided to us by manufacturers for the previous rulemaking that shows typical notch power levels expressed as a percentage of the rated power of the engine.

In response to comments we are also adding provisions to address locomotives that include new design features that will result in changes to the in-use duty cycle. Specifically, the regulations state that manufacturers must notify us if they are adding design features that will make the expected average in-use duty cycle of their engine family significantly different from the otherwise applicable test cycle. They must also recommend an alternate test cycle that represents the expected average in-use duty cycle. We will specify whether to use the default duty cycle, the recommended cycle, or a different cycle, depending on which cycle we believe best represents expected in-use operation. For locomotives subject to both line-haul and switch cycle standards, the regulations specify that a single set of standards would apply for the representative cycle.

(c) Energy Saving Design Features

We are adopting special provisions for locomotives equipped with energy-saving design features, such as sophisticated electronic optimization of throttle and brake settings based on route data or locomotive operation in a consist, electronically controlled pneumatic (ECP) brakes, and hybrid technology. The provisions we are adopting recognize that to whatever degree the total work done by a locomotive is reduced, the mass emissions would likely also be reduced. For example, if certain design features reduced by three percent the amount of work needed to pull a typical train, then the mass emission rate (g/hr) would generally also be reduced by three percent. Under the new provisions, manufacturers will be allowed to adjust their locomotives' emissions to reflect this, based on data gathered prior to certification.

Manufacturers choosing to adjust emissions under these provisions must present a test plan to EPA for approval prior generating the in-use data necessary to estimate their emissions reductions. The degree to which manufacturers would be allowed to take

a credit at certification would be determined from a statistical analysis of their supporting data to address the uncertainty in their estimate. This would minimize the possibility that manufacturers would be given credit for emission reductions that did not actually occur. Later, additional data on the in-use fleet using the feature could be gathered to improve the statistical certainty and this could then be factored into subsequent certifications. In concept, however, if we had perfect data, we would grant the manufacturers full credit for the savings.

Since our standards are specified as brake-specific emission limits, no credit or adjustment will be allowed for features that only improve the engine's brake-specific fuel consumption. The nature of the test procedure itself already properly credits such features. Thus, allowing additional credits to be calculated would be double-counting of credits.

(8) Non-OEM Remanufacturing Parts

We are adopting measures in § 1033.645 to help provide for the continued participation in remanufacturing by parts manufacturers willing to take responsibility for the long-term emissions performance of their parts but who lack the wherewithal to design and certify entire locomotive remanufacture systems that may include complex emissions control systems far beyond their expertise. Under this program, we would determine, based on an upfront engineering analysis, that the part supplier has a reasonable basis for concluding that use of their part would be equivalent to the OEM part in use. We would later verify its emission performance through in-use emission testing.

The exact nature of the engineering analysis necessary to demonstrate that the part supplier has a reasonable basis for concluding that use of their part (or parts) will not cause emissions to increase beyond the level expected from the OEM part in use, is expected to vary. We see four possible paths to accomplish this.

- The part is shown to be identical to the original part in all material respects.
- The part differs physically from the original in a small number of ways and each of these is evaluated to show that the aftermarket part will be as good as or better than the original with respect to emissions performance.
- Measurable emission-critical parameters such as fuel injection profile or engine oil consumption rate are established and an engine (or relevant engine subsystem) using the aftermarket

part is shown through testing to perform as good or better than one with the original part with respect to these parameters.

- Emissions testing and durability demonstration is performed in essentially the same manner as for remanufactured system certification.

For example, cylinder liners differing only in color and part number from the OEM liners would be identical in all material respects. Those having different bore groove patterns would not be considered identical, but an analysis of the difference this makes in the oil's interaction with the cylinder wall and rings (which could have an impact on PM emissions) could suffice to make the demonstration. Chrome-plated cylinder liners in combination with a specified piston ring set used in place of original rings and non-plated liners could be expected to affect the emission-critical parameter of oil consumption, especially later in the locomotive useful life due to differences in wear rates. Bench or field testing over time demonstrating lower oil consumption trends than original equipment could provide a sufficient demonstration, provided no other emission-critical parameters are involved. We do not believe it is necessary or even possible to specify in the regulations the appropriate emission-critical parameters for all of the locomotive aftermarket components identified in this provision or to specify the test procedures and criteria by which these parameters are evaluated. Instead, we are establishing broad criteria and requiring the part suppliers to propose the appropriate emission-critical parameters and corresponding test or analytical methods appropriate to the part they produce.

We would allow railroads to use the non-OEM part during remanufacturing once we have approved the supplier's engineering analysis. Once the part has been installed in at least 250 locomotives, we would require one of them to be tested. One additional locomotive would need to be tested from the next additional 500 locomotives that use the part. If any locomotives fail to meet all standards, we generally require one additional locomotive to be tested for each locomotive that fails. We would generally allow the supplier to include testing performed by others. For example, if a railroad tests a locomotive with the part under § 1033.810, the supplier could submit those test data as fulfillment of its test obligations.

We are adopting these provisions to address the specific issue of parts that are typically replaced during

remanufacturing and for which there is an active aftermarket. Therefore, we are only specifying cylinder liners, cylinder heads, pistons, rings, and fuel injectors as being covered by this program. We reserve the authority to expand the program to cover other parts.

(9) Use of Nonroad Engines Certified Under 40 CFR Parts 89 and 1039

Section 92.907 currently allows the use of a limited number of nonroad engines in locomotive applications without certification under the locomotive program. We believe a similar allowance should also be included in the new regulations. However, we are making some changes to these procedures. In general, manufacturers have not taken advantage of these previously existing provisions. In some cases, this was because the manufacturer wanted to produce more locomotives than allowed under the exemption. However, in most cases, it was because the customer wanted a full locomotive certification with the longer useful life and additional compliance assurances. We are adopting new separate approaches for the long term (§ 1033.625) and the short term (§ 1033.150), each of which addresses at least one of these issues.

For the long term, we are replacing the existing allowance that relies on part 89 certificates with a design-certification program that makes the locomotives subject to the locomotive standards in use but does not require new testing to demonstrate compliance at certification. Specifically, this program allows switch locomotive manufacturers using nonroad engines to introduce up to 30 locomotives of a new model prior to completing the traditional certification requirements. While the manufacturer would be able to certify without new testing, the locomotives would have locomotive certificates. Thus, purchasers would have the compliance assurances they desire.

As is described in section III B (1)(b), the short-term program is more flexible and does not require that the locomotives comply with the switch cycle standards; instead the engines would be subject to the part 1039 standards. The manufacturers would be required to use good engineering judgment to ensure that the engines' emission controls would function properly when installed in the locomotives. For example, the locomotive manufacturer would need to ensure that sufficient cooling capacity was available to cool the engine intake air. Given the relative levels of the part 1039 standards and those being

proposed in 1033, we do believe there is little environmental risk with this short-term allowance and thus are not including any limits of the sales of such locomotives. Nevertheless, we are limiting this allowance to model years through 2017. This provides sufficient time to develop these new switchers. These locomotives would not be exempt from the part 1033 locomotive standards when remanufactured, unless the remanufacturing of the locomotive took place prior to 2018 and involved replacement of the engines with certified new nonroad engines. Otherwise, the remanufactured locomotive will be required to be covered by a part 1033 remanufacturing certificate.

(10) Mexican and Canadian Locomotives

Under the prior regulations, Mexican and Canadian locomotives are subject to the same requirements as U.S. locomotives if they operate extensively within the U.S. The regulation 40 CFR 92.804(e) states:

Locomotives that are operated primarily outside of the United States, and that enter the United States temporarily from Canada or Mexico are exempt from the requirements and prohibitions of this part without application, provided that the operation within the United States is not extensive and is incidental to their primary operation.

We are changing this exemption to make it subject to our prior approval, since we have found that the current language has caused some confusion. When we created this exemption, it was our understanding that Mexican and Canadian locomotives rarely operated in the U.S. and the operation that did occur was limited to within a short distance of the border. We are now aware that there are many Canadian locomotives that do operate extensively within the U.S. and relatively few that meet the conditions of the exemption. We have also learned that some Mexican locomotives may be operating more extensively in the United States. Thus, it is appropriate to make this exemption subject to our prior approval. To obtain this exemption, a railroad will be required to submit a detailed plan for our review prior to using uncertified locomotives in the U.S. We will grant an exemption for locomotives that we determine will not be used extensively in the U.S. and that such operation will be incidental to their primary operation. Mexican and Canadian locomotives that do not have such an exemption and do not otherwise meet EPA regulations may not enter the United States.

(11) Other Locomotive Issues

The regulations in part 92 allow locomotive owners to voluntarily subject their pre-1973 locomotives to the Tier 0 standards or to include in the locomotive program low-horsepower locomotives that would otherwise be excluded based on their rated power. We are also including these options in the new part 1033. We will also provide two additional options. First, we will allow Tier 0 switch locomotives, which are normally not subject to line-haul cycle standards, to be voluntarily certified to the line-haul cycle standards. Second, we will allow any locomotives to be voluntarily certified to a more stringent tier of standards. An example of where these options may be desirable would be a case in which a customer wants to purchase a refurbished switch locomotive that meets the Tier 2 standards. While it may seem obvious that it would be allowed, the old regulations are unclear. The part 1033 regulations eliminate this confusion.

The existing and proposed regulations both specified that railroads are required to perform emission-related maintenance. In response to comments, we have added to the regulations a clarification that unscheduled maintenance has to be performed in a timely manner, no later than at the next "92-day" inspection required by the Federal Railroad Administration. Railroads expressed concern that the regulations, as previously written, would have required them to immediately remove a locomotive from service to make emission-related repairs. This was not our intent. Rather, the maintenance provision was intended to merely require that the maintenance be performed in a timely manner. For many repairs, it may be appropriate to wait until the next 92-day inspection. However, for many others it would be appropriate to make the repair sooner to the extent practical.

In response to comments, we are adding an interim allowance to simplify certification testing of locomotive engines. Specifically, for model years before 2014, we will allow manufacturers to test locomotive engines for certification without replicating the transient behavior in the locomotive. This will make it easier for manufacturers to certify new cleaner remanufacturing systems for the full range of locomotive models.

C. Compliance Issues Specific to Marine Engines

(1) Remanufacturing

As discussed in Section III, above, we are adopting a marine remanufacture program for marine diesel engines over 600 kW built from 1973 through Tier 2 that requires the use of a certified remanufacture system when such an engine is remanufactured, if one is available. Certified remanufacture systems must achieve at least a 25 percent reduction in PM emissions. This section briefly describes several certification and compliance provisions for the marine remanufacture program; the full program is contained in the regulations for this rule.

In general, the normal certification requirements for new marine diesel engines would apply, with minor variations as needed to accommodate the characteristics of remanufactured engines. For example, engine families are based on the same criteria as for freshly manufactured engines, and testing, reporting, the application for certification, and warranty requirements closely follow the provisions that apply for freshly manufactured engines.

In general, remanufactured engines are considered to be "new" engines, and they remain new until sold or placed back into service after the replacement of the last cylinder liner. The standards do not apply for engines that are rebuilt without removing cylinder liners. For a new engine to be placed into service, it must be covered by a certificate of conformity.

As is the case with our other emission control programs, certification testing for conformity demonstration will be performed on the most common configuration within an engine family. An engine family is a group of engines that have the same characteristics with respect to combustion cycle and fuel, cooling system, method of air aspiration, method of exhaust aftertreatment, combustion chamber design, bore and stroke, and mechanical or electronic controls. Other configurations may be included if it can be shown based on good engineering judgment that they are likely to provide a PM reduction similar to the configuration tested. Compliance for these other configurations is based on an engineering demonstration that the remanufacturing system reduces PM emissions by 25 percent without increasing NO_x emissions. Engine families may also include remanufacturing systems corresponding to engines that were originally produced over multiple model years, as long as the configuration does not change in a

way that affects the validity of certification for the remanufacturing system.

To certify a remanufacture system, a manufacturer must measure baseline emissions and emissions from an engine remanufactured using its system. A baseline emission rate would be established by remanufacturing an engine following normal procedures. That engine or a second engine of the same configuration is then tested for emissions after remanufacturing with the expected emission controls. The remanufacturing system meets the emission standards of the program by demonstrating a minimum 25 percent reduction in PM emissions and no increase in NO_x emissions (within 5 percent). The remanufacturer must also demonstrate that the remanufacturing system does not adversely affect engine reliability or power.

The remanufacturer must also demonstrate that the total marginal cost of the remanufacturing system is less than \$45,000 per ton of PM reduction. For the purpose of this demonstration, marginal cost means the difference in costs between remanufacturing the engine using the remanufacture system and remanufacturing the engine conventionally. Total marginal costs over the period of one useful life are divided by the projected PM emissions over one useful life to obtain the cost of the remanufacture system per ton of PM reduced. Costs to be considered include hardware costs, labor costs, operating costs over one useful life period, and other costs (such as shipping).

The useful life provisions established for freshly manufactured engines would apply equally to remanufactured engines. In general, remanufacturers would be responsible for meeting emission standards for 10 years or 10,000 hours of operation for Category 1 engines, and 10 years or 20,000 hours of operation for Category 2 engines.

Certification will rely on a deterioration factor, similar to freshly manufactured engines. The certifying company may either use an assigned value of 0.015 g/kW-hr for PM or develop a new deterioration factor based on engine testing. For Tier 2 engines, the certifying company needs to add the deterioration factor to measured emission levels for certification. The deteriorated number must be less than the applicable PM standard. For Tier 1 and earlier engines, the deterioration factor is added to the emission level established for the certified configuration and that higher emission level serves as the emission standard for any in-use testing after certification.

The regulations allow for simplified certification requirements for remanufacture systems that are already certified under the locomotive program. This would require only an engineering analysis demonstrating that the system would achieve emission reductions from marine engines similar to those from locomotives. Because the marine remanufacture program requires only a PM reduction, locomotive remanufacture system manufacturers may modify those locomotive systems with respect to NO_x emissions. In that case, the system will have to be recertified as a marine remanufacture system based on measured values and subject to all of the other certification requirements of the marine remanufacture program.

Remanufactured engines are not eligible for generating or using emission credits for averaging, banking, or trading. This is appropriate because the program we are finalizing is only mandatory if a system has been certified for the relevant engine. We will reconsider allowing systems to be based on emission credits when we consider whether to adopt a mandatory marine remanufacture program (Part 2 of the proposed program) at a later date.

Not-to-exceed standards do not apply to remanufacturing. This is appropriate because the base engine in most cases is not subject to NTE requirements. In addition, NTE is most appropriately considered in the initial engine design phase; requiring remanufactured engines to meet the NTE requirements would likely require more intensive engine redesign than is anticipated by the simpler program we are finalizing.

Finally, other provisions such as those governing maintenance intervals, warranties, duty cycles, test fuel, labeling, recordkeeping, etc. are the same as or similar to those for freshly manufactured engines.

(2) Replacement Engines

We are revising certain aspects of our existing provisions with regard to replacement engines, as described below. These requirements apply to all marine diesel engines, propulsion or auxiliary, regardless of marine application. Section 1042.601(c) provisions apply instead of the provision of section 1068.240(b)(3) that applies for other nonroad engines.

(a) Replacement With a Freshly Manufactured Engine

Under the current marine diesel engine program, an engine manufacturer is generally prohibited from selling a marine engine that does not meet the standards that are in effect when that engine is produced. However, we

recognize that there may be situations in which a vessel owner may require an engine certified to an earlier tier of standards. The two most likely situations are (1) when a vessel has been designed to use a particular engine such that it cannot physically accommodate a different engine due to size or weight constraints (e.g., a new engine model will not fit into the existing engine compartment); or (2) when the engine is matched to key vessel components such as the propeller, or when a vessel has a pair of engines that must be matched for the vessel to function properly.

To address these extreme situations, we amended existing regulation 40 CFR 94.1103(b)(3) to allow a manufacturer to produce a new engine which meets an earlier tier of standards if the Administrator determined that no new engine certified to the emission limits in effect at that time is produced by any manufacturer with the appropriate physical or performance characteristics needed to repower the vessel. An engine manufactured pursuant to this provision is subject to certain conditions: The replacement engine must meet standards at least as stringent as those of the original engine; the engine manufacturer must take possession of the original engine or confirm it is destroyed; and the replacement engine must be clearly labeled to show that it does not comply with the standards and that sale or installation of the engine for any purpose other than as a replacement engine is a violation of federal law and subject to civil penalty.

We subsequently revised this provision to allow the engine manufacturer to make the determination of whether an engine compliant with the current standards would fit a vessel, but solely in cases of catastrophic failure (see 70 CFR 40419, July 13, 2005). This change was made to reflect industry concerns that obtaining prior EPA approval would take too long. The engine manufacturer may make the determination in catastrophic failure situations provided that the following conditions are met: The manufacturer must determine that no certified engine is available, either from its own product lineup or that of the manufacturer of the original engine (if different); and the engine manufacturer must document the reasons why an engine of a newer tier is not usable, and this report must be made available to us upon request. We also specified in § 94.1103(a)(8) that no other significant modifications to the vessel can be made as part of the process of replacing the engine, or for a period of 6 months thereafter.

In response to comments on the proposal for this rulemaking, we are

finalizing three additional revisions to the replacement engine provisions. First, engine manufacturers may now make the determination with respect to the feasibility of using a current tier engine in both noncatastrophic and catastrophic situations. This is a significant change to the program. Engine manufacturers and user groups were concerned about the amount of time that would be needed to obtain prior EPA approval, even in these noncatastrophic cases. Even though the noncatastrophic engine replacement is more typically planned in advance, it is still the case that the determination must be made in a timely manner to ensure the engine manufacturer has time to produce the engine before the vessel is taken out of service for the replacement. Therefore, we are revising the program to allow the engine manufacturer to make such determinations, provided certain additional conditions are met: The engine manufacturer must examine the suitability of replacement with any current tier engine, either produced by that manufacturer or any other manufacturer; the engine manufacturer must make a record of each determination, which must be kept for eight years and contain specific information; the record must be submitted to EPA within 30 days after shipping each engine along with a statement certifying that the information contained in that record is true. We may reduce the reporting and recordkeeping requirements in this section after a manufacturer has established a consistent level of compliance with the requirements of this section.

These records will be used by EPA to evaluate whether engine manufacturers are properly making the feasibility determination and applying the replacement engine provisions. We may void any exemptions we determine do not conform to the applicable requirements. When assessing penalties under this provision we would consider whether the manufacturer acted in good faith. Thus manufacturers are encouraged to keep additional records to support their good faith attempt to comply with the regulations. For example, manufacturers could keep records of requests for replacement engines that are denied.

In making the determination that a current tier engine is not a feasible replacement engine for a vessel, we expect the engine manufacturer will evaluate not just engine dimensions and weight but may also include other pertinent vessel characteristics. These pertinent characteristics would include downstream vessel components such as

drive shafts, reduction gears, cooling systems, exhaust and ventilation systems, and propeller shafts; electrical systems for diesel generators (indirect drive engines); and such other ancillary systems and vessel equipment that would affect the choice of an engine. At the same time, there are differences between the new tier and original tier engines that should not affect this determination, such as the warranty period or life expectancy of a newer tier engine, or its cost or production lead time. These characteristics should not be part of the determination of whether or not a new tier engine can be used as a replacement engine. With regard to the warranty period or life expectancy for the new tier engine, an exception may be if these are significantly shorter for the new tier engine than for an older tier engine or the original engine and the shorter warranty period or life expectancy for the newer model is consistent with industry practices.

In addition, in the case of a vessel with two or more paired engines, if the engine not in need of replacement has accumulated service in excess of 75 percent of its useful life we specify that the determination must consider replacement of both engines in the pair. This requirement is necessary to prevent circumvention of the freshly manufactured engine requirements by replacing one engine at a time and relying on the need to pair the engines as the sole justification for producing an engine to an earlier tier. We are also specifying that no additional modifications may be made to a vessel for six months after installing a new replacement engine made to a previous tier. This is to avoid circumvention of the requirement to use a freshly manufactured engine when a vessel is refurbished such that it becomes a new vessel.

The second change to the replacement engine provision is necessary to accommodate the new tiers of standards we are adopting in this rulemaking. Specifically, in making the feasibility determination the engine manufacturer is now required to consider all previous tiers and use any of their own engine models from the most recent tier that meets the vessel's physical and performance requirements. If an engine manufacturer can produce an engine that meets a previous tier of standards representing better control of emissions than that of the engine being replaced, the manufacturer would need to supply the engine meeting the tier of standards with the lowest emission levels. For example, if a Tier 1 engine is being replaced after the Tier 3 standards go into effect, the engine manufacturer

would have to demonstrate why a Tier 2 as well as a Tier 3 engine cannot be used before a Tier 0 engine can be produced and installed. Similarly, for an engine built prior to 2004, the engine manufacturer would have to demonstrate why a Tier 1, Tier 2, or a Tier 3 engine cannot be used. It should be noted, in the case of Tier 0 engines, that MARPOL Annex VI prohibits replacing an existing engine at or above 130 kW with a freshly manufactured engine unless it meets the Tier 1 standards.

The third change to the replacement engine provisions pertains to Tier 4 engines. We are making the advance determination that Tier 4 engines equipped with aftertreatment technology to control either NO_x or PM are not required for use as replacement engines for engines from previous tiers in accordance with this regulatory replacement engine provision. Note, however, that Tier 4 engines will be required to be used as replacement engines if the original engine being replaced is a Tier 4 engine. We are making this determination in advance because we expect that installing such a Tier 4 engine in a vessel that was originally designed and built with a previous tier engine could require extensive vessel modifications (e.g., addition of a urea tank and associated plumbing; extra room for a SCR or PM filter; additional control equipment) that may affect important vessel characteristics (e.g., vessel stability). It should be noted that by making this advance determination, EPA is not implying that Tier 4 engines are never appropriate for use as replacement engines for engines from previous tiers; this determination is intended to simplify the search across engines and is based on the presumption that Tier 4 engines may not fit in most cases. We are also not intending to prevent states or local entities from including Tier 4 engines in incentive programs that encourage vessel owners to replace previous tier existing engines with new Tier 4 engines or to retrofit control technologies on existing engines, since those incentive programs often are designed to offset some of the costs of installing and/or using advanced emission control technology solutions. This advance determination is being made solely for Tier 4 marine diesel replacement engines that comply with the Tier 4 standards through the use of catalytic aftertreatment systems. Should an engine manufacturer develop a Tier 4 compliant engine solution that does not require the use of such technology, then this automatic determination will

not apply. Instead our existing provision will apply and it will be necessary to show that a non-catalytic Tier 4 engine would not meet the required physical or performance needs of the vessel.

(b) Replacement With an Existing Engine

Our current marine diesel engine program does not contain provisions that address the case in which an engine is replaced with an existing used engine. This means that if a vessel owner replaces an existing engine with a used engine, then that replacement engine is not required to be certified to our marine standards. It should be noted, however, that engines greater than 600 kW that are built after 1973 would still be subject to the remanufacture program described in Section III(C)(2)(b). This means if the existing engine that is the replacement engine has all of its cylinder liners replaced, it will be required to be remanufactured using a certified remanufacture system if one is available for that engine. It is our expectation that a vessel owner would not replace an existing engine above 600 kW with a partially-rebuilt engine, and therefore we do not expect to see replacement engines that are not remanufactured if there is a certified remanufacture system available.

These remanufacture requirements would apply whether the owner is obtaining an identical existing (used) replacement engine due to an engine failure or through an engine exchange for a periodic engine rebuild. These requirements would also apply if a vessel owner is obtaining a different model existing (used) replacement engine, for whatever reason.

It should be noted that pursuant to the definition of "new marine engine," used engines brought into the marine market from other segments (e.g., locomotive, land-based nonroad, or highway sectors) are considered to be new marine diesel engines when they are marinized or modified for use on a vessel, and must meet the standards for newly manufactured engines in effect when such an engine is marinized or modified for installation on a vessel.

(c) Swing Engines

A swing engine is an additional engine that is purchased at the time the vessel is constructed as part of a rebuild strategy. When an engine is due for rebuild, that engine is removed from the vessel and replaced with the swing engine. The removed engine is rebuilt and then becomes the swing engine. Note that a swing engine is not meant to be a replacement engine in case of

engine failure. Rather, it is a maintenance practice.

It is our expectation that the swing engine would undergo a complete rebuild, including cylinder liner replacement, before it is made available as the swing engine. That would constitute remanufacturing, and the engine would be required to comply with the engine remanufacture requirements. In general, this means that all engines that are part of a swing engine rebuild practice are expected to comply with the remanufacture requirements over time, providing a certified remanufacture system is available.

(d) Vessel Refurbishing

Our current program specifies that in addition to newly manufactured vessels, a vessel is considered to be "new" if it is modified such that the value of the modifications exceeds 50 percent of the value of the modified vessel. Such a refurbished vessel would be required to have an engine that is compliant with the standards in place when the vessel is modified. We expect that most vessel modifications will not trigger this threshold, but the requirement is necessary to accommodate those cases where a major structural change is done to a vessel that make it like-new.

We are revising this provision to specify how temporary modifications will be treated under this provision. In general, temporary modifications to a vessel would not be considered to be vessel refurbishing for the purpose of the "new vessel" definition. We are defining temporary modifications as modifications to a vessel that are made pursuant to a written contract between the vessel owners and the purchaser of the vessel's services and that are made for the purpose of fulfilling the purchaser's marine service requirements. To be considered to be temporary, the modifications must be removed from the vessel upon expiration of the contract or after a period of one year, whichever is shorter. While we will allow a vessel owner to petition EPA for a longer period of time, we will generally assume that changes that are necessary for longer than one year are quasi-permanent. We do not expect there to be many petitions for longer periods of time because temporary modifications that exceed 50 percent of the vessel's value would be considerable and would likely involve the vessel's power plant.

(3) Personal Use Exemption

The current marine diesel engine emission control program contains certain exemptions from the standards,

including the following: test engines; manufacturer-owned engines; display engines; competition engines; export engines; and certain military engines. We also provide an engine dresser exemption that applies to marine diesel engines that are produced by marinizing a certified highway, nonroad, or locomotive engine without changing it in any way that may affect the emissions characteristics of the engine.

In addition to these existing exemptions we are also adding a new provision that exempts an engine installed on a vessel manufactured by a person for his or her own use (see 40 CFR 1042.630). This is intended to address the hobbyists and fishermen who make their own vessel (from a personal design, for example, or to replicate a vintage vessel) and who would otherwise be considered to be a manufacturer subject to the full set of emission standards by introducing a vessel into commerce. The exemption is intended to allow such a person to install a rebuilt engine, an engine that was used in another vessel owned by the person building the new vessel, or a reconditioned vintage engine (to add greater authenticity to a vintage vessel). The exemption is not intended to allow such a person to order a new uncontrolled engine from an engine manufacturer. We expect this exemption to involve a very small number of vessels, so the environmental impact of this exemption will be negligible, while the cost would otherwise be high to install a certified compliant engine.

Because the exemption is intended for hobbyists and fishermen, we are setting additional constraints. First, the vessel may not be used for general commercial purposes. The one exception to this is that the exemption allows a fisherman to use the vessel for his or her own commercial fishing. Second, the exemption is limited to one such vessel over a ten-year period and does not allow exempt engines to be sold for at least five years. We believe these restrictions are not unreasonable for a true hobby builder or comparable fisherman. Moreover, we require that the vessel generally be built from unassembled components, rather than simply completing assembly of a vessel that is otherwise similar to one that must use a freshly manufactured engine certified to meet the applicable emission standards. The person also must be building the vessel him- or herself, and not simply ordering parts for someone else to assemble. Finally, the vessel must be a vessel that is not classed or subject to Coast Guard inspections or surveys.

(4) Lifeboat/Rescue Boat Exemption

Our current marine diesel engine program does not exempt lifeboats or rescue boats, and we did not propose to revise that approach. This approach was developed for the Tier 2 marine diesel engine standards. As we explained in our 1999 FRM, the technologies that would meet Tier 2 standards would not have inherent negative effect on the performance or power density of an engine, and we expected that manufacturers would be able to use the range of technologies available to maintain or even improve the performance capabilities and reliability of their engines. We also note that land-based emergency engines such as standby generators are not exempt from our emission control requirements in either highway or nonroad applications.

We received several comments from manufacturers of lifeboats and rescue boats requesting that we reconsider this approach and exempt engines on lifeboats and rescue boats from the Tier 3 and Tier 4 standards. They noted that engines on lifeboats and rescue boats are not regularly used as they are intended for use only during emergencies, and they are generally only operated for 3 minutes once a week and are water tested for a short period only a few times a year. Boat manufacturers were also concerned about the reliability of electronic controls and advanced technology aftertreatment systems in these situations, especially when the boats are stored on deck and exposed to the elements.

We've also learned that at least some engine manufacturers that have certified engines in the past for use on Coast Guard approved lifeboats and rescue boats pursuant to Coast Guard and international (International Convention for the Safety of Life at Sea—SOLAS) requirements have not yet done so for Tier 2 engines and may elect not to do so at all.¹⁶⁷ The Coast Guard and SOLAS certification requirements are meant to ensure that an engine will perform after it is inverted, will operate when submerged up to the crankshaft, and will readily start at temperatures as low as -15 degrees C. This certification is expensive and time-consuming, and those costs may be difficult to recover over the limited U.S. market for lifeboats and rescue boats (100 to 150 boats per year). Manufacturers of those lifeboats that use those engines must either find an alternative engine for their product, and recertify the boats to

the Coast Guard and SOLAS requirements, or exit the market.

After considering these comments, we conclude that it is reasonable to modify our program for engines used on Coast Guard approved lifeboats and rescue boats. First, our final program exempts engines intended to be used on lifeboats and rescue boats from the Tier 4 standards. This exemption is appropriate for technological reasons. We expect the Tier 4 standards to be met through the application of aftertreatment technology. While we believe these technologies will be durable and reliable, it is also the case the additional complexity could possibly affect engine performance in an emergency, which is the sole situation in which these engines would be used. For example, it would be necessary to ensure the engines on the lifeboat or rescue boat have onboard at all times an adequate supply of urea that meets the quality requirements of an SCR system. In addition, if the engine on the lifeboat or rescue boat is only run for very short periods of time for periodic onboard tests, the PM filter may not have time to regenerate. This could result in a small risk of plugging. Therefore, it is reasonable to exempt these engines from the Tier 4 requirements. It is worth noting that most lifeboat engines are less than 600 kW and thus would not be subject to Tier 4 standards.

Second, to avoid a situation in which an engine certified to the Coast Guard and SOLAS requirements is not available for use in a lifeboat or rescue boat application, we are providing an exemption that would have the effect of delaying the date of the emission standards for engines used on those boats until SOLAS certified engines of the respective emissions tier become available. Specifically, we will grant exemptions for engines not complying with the Tier 3 requirements for use in a Coast Guard approved lifeboat or rescue boat until such time as a comparable Tier 3 engine that meets the weight, size, and performance requirements of the boat is certified under the Coast Guard and SOLAS requirements. Once such an engine becomes available, the non Tier 3 compliant engines may not be sold for use in these applications. This provision is necessary because the Coast Guard has observed a precipitous drop in available SOLAS certified engines with the emissions tier change from the Tier 1 emissions standards to the Tier 2 emissions standards. Given the high cost of SOLAS certification and the low sales of SOLAS certified engines, engine manufacturers have delayed SOLAS certification of new emission tier

engines. After considering the high cost of SOLAS certification, the need for additional lead time to complete the SOLAS certification process and the importance of lifeboats and rescue boats to safety, we have concluded it is appropriate to provide this exemption. We are not requiring engine manufacturers to certify these engines by a specified date. However, we anticipate that engine manufacturers will over time certify their Tier 3 engines to the Coast Guard and SOLAS requirements, or modify their existing Coast Guard certified engines as necessary to comply with the Tier 3 requirements. Most of the marine diesel engines used on lifeboats and rescue boats are derived from land-based highway or nonroad engines. Once the Tier 3 requirements for those engines go into effect and the Tier 2 or Tier 1 counterparts are retired from the fleet, it will become more expensive to continue to provide parts and service for these older engines, and engine manufacturers will prefer to provide newer tier engines for lifeboats and rescue boats globally. Because it is not possible to determine when that change will take place, the final program specifies that when they do become available, they must be used.

Finally, we are extending this exemption to Tier 2 engines as well. We have learned that some lifeboat and rescue boat manufacturers are having trouble obtaining engines that meet the Tier 2 standards. Note that because Tier 2 engines are not regulated under part 1042, this exemption is included in a new section in part 94 (94.914). As with the Tier 3 exemption, once a Tier 2 engine becomes available that meets the weight, size, and performance requirements of the boat and is certified under the Coast Guard and SOLAS requirements the exemption will no longer be available for freshly manufactured engines.

Engines that are produced to an earlier tier pursuant to these provisions must be labeled to make clear that their use is limited to lifeboats or rescue boats approved by the U.S. Coast Guard under approval series 160.135 or 160.156. Using such a vessel as for a purpose other than a lifeboat or rescue boat is a violation of the regulations.

The above provisions are applicable only to engines in lifeboats and rescue boats used solely for emergency purposes. This is an important distinction because there are cases in which a lifeboat may serve dual use on a vessel, both for general transportation (e.g., tenders) and for emergencies. Engines in lifeboats and rescue boats that are not used solely for emergency purposes are not exempt. These engines

¹⁶⁷ See http://www.uscg.mil/hq/g-m/mse4/boatlb.htm#LIFEBOAT_FOR_MERCHANT_VESSELS for Coast Guard requirements for lifeboats and rescue boats.

are not expected to remain idle long enough for urea storage or PM trap regeneration to be a problem. For all these reasons, the Tier 2 and 3 flexibility and Tier 4 exemption will apply only to engines intended for installation on lifeboats approved by the U.S. Coast Guard under approval series 160.135 (except those which are also approved for use as launches or tenders) and rescue boats approved by the U.S. Coast Guard under series 160.156.

(5) Stand-By Emergency Auxiliary Engines

We are exempting certain stand-by emergency auxiliary engines from the Tier 4 standards. This exemption is necessary due to the fact that these engines are rarely used, their operation being limited to periodic testing of several minutes duration. While the technologies that will be used to achieve the Tier 4 standards are expected to be durable, it is also the case that operation for such short periods of time may not be enough to engage the aftertreatment regeneration strategy. In addition, these auxiliary engines would need separate urea tanks, rendering them more complicated to maintain and use in an emergency situation.

This exemption is limited to dedicated stand-by emergency auxiliary engines subject to United States Coast Guard requirements set out in 46 CFR part 112. In general, these stand-by emergency auxiliary engines are supplemental to the ships' main auxiliary engines. They are located away from the main engine compartment, have separate fuel tanks, and are connected to the ships' power system in such a way as to provide for emergency power only to emergency equipment and not the ship's power grid generally. These engines must be labeled for use as marine stand-by emergency auxiliary engines only.

Marine stand-by emergency engine means any marine auxiliary engine whose operation is limited to unexpected emergency situations on a vessel; these engines are subject to testing and maintenance required by the United States Coast Guard. They are generally used to produce power for critical networks or equipment (including power supplied to portions of a vessel) when electric power from the main auxiliary engine(s) is interrupted. Marine auxiliary engines used to supply power to the vessel's general electric grid or that are operated on a constant basis are not considered to be emergency marine auxiliary engines.

Exempted engines are required to meet the applicable Tier 3 standards (in

part 89 or part 94, as applicable). See 40 CFR 1068.265 for the provisions that apply for such exempt engines. The engines must also be labeled to make clear that they are exempt and their use is limited to emergency stand-by auxiliary power as specified in United States Coast Guard requirements set out in 46 CFR part 112.

(6) Gas Turbine Engines

While gas turbine engines¹⁶⁸ are used extensively in naval ships, they are not used very often in commercial ships. Because of this and because we do not currently have sufficient information, we are not including marine gas turbines in this rulemaking. Nevertheless, we believe that gas turbines could likely meet the new standards (or similar standards) since they generally have lower emissions than diesel engines and may reconsider gas turbines in a future rulemaking.

(7) Natural Gas Engines

The increasing deployment of tankers carrying liquefied natural gas has led to greater numbers of large marine engines running on natural gas instead of diesel fuel. Depending on the technological approach engine manufacturers take, these engines could fall under our definition for spark-ignition engines even though their design and development is more like compression-ignition engines. Without some clarifying provision, these engines would therefore be subject to the standards that we are developing for inboard spark-ignition engines, which are based on automotive technologies. Since this is clearly not appropriate, we are adopting a provision to specify that natural gas engines above 250 kW are subject to standards for marine compression-ignition engines regardless of our regulatory definitions for spark-ignition and compression-ignition engines. Since the analysis of control technology and the estimated costs and emission reductions are very similar to that for diesel-fueled engines, we have made no effort to separately analyze these engines relative to the new emission standards.

(8) Residual Fuel Engines

The vast majority of Category 1 and 2 marine diesel engines subject to EPA's emission standards operate on distillate diesel fuel. There are cases, however, in which the owner of a vessel may prefer

to operate a Category 2 engine on another type of diesel fuel. This is mainly the case for auxiliary engines on ocean-going vessels, to allow them to use the same fuel that is used in the propulsion engine (typically residual fuel). There are also a few vessels operated on the Great Lakes that use residual fuel or residual fuel blends.

Our marine diesel engine program requires engine manufacturers to perform certification testing using the same type of fuel that will be used in actual engine operation. This requirement, which was also included in our 1999 Tier 2 rule, is intended to ensure that engines meet the emission limits in operation. In our proposal, we noted that engine manufacturers have not certified Category 1 or 2 engines that can be operated on residual fuel to the Tier 2 standards. Manufacturers explained that it is not profitable to do so due to the small size of the U.S. market for these engines. They also informed us that it would be difficult to meet EPA's PM standards on residual fuel.

Some owners expressed concern to EPA about the unavailability of large auxiliary engines certified to the Tier 2 standards on residual fuel. These owners expressed a preference for auxiliary engines run on the same fuel as propulsion engines to simplify ship operations. To respond to this concern, we asked for comment on a compliance consisting of an alternative PM standard and a tighter NO_x standard. The alternative standards would be available for auxiliary engines to be installed on vessels with Category 3 propulsion engines. Certification testing would still be required on residual fuel but we would allow alternative PM measurement procedures. To ensure that questions of test fuel and PM measurement are resolved before certification testing, manufacturers would have to apply to EPA to exercise this flexibility.

The alternative of exempting residual fuel engines from the test fuel requirement and allowing them to be tested on distillate fuel is not appropriate. All of our mobile source emission control programs are predicated on an engine meeting the emission standards in use. The test fuel requirement is one of several provisions that help ensure in-use compliance, including useful life periods, emission deterioration factors, durability testing, and not-to-exceed zone. Amending the test fuel provisions to allow manufacturers to certify residual fuel engines using distillate fuel would introduce considerable uncertainty into the in-use performance of these engines,

¹⁶⁸ Gas turbine engines are internal combustion engines that can operate using diesel fuel, but do not operate on a compression-ignition or other reciprocating engine cycle. Power is extracted from the combustion gas using a rotating turbine rather than reciprocating pistons.

would weaken the emission standards, and would be contrary to the goals of our program.

We received no comments supporting the compliance flexibility described above, and therefore we are not revising our program with respect to test fuels or the standards that apply to engines with per cylinder displacement below 30 liters that use residual fuel. We expect to revisit this issue in the context of our upcoming rulemaking for Category 3 marine diesel engines.

(9) Duty Cycles for Marine Engines

Manufacturers pointed out two inconsistencies between the proposal and existing requirements for marine engines related to the proposed duty cycles for marine propulsion engines less than 37 kW and the proposed duty cycle for propeller-law auxiliary engines. We agree that the existing 4-mode duty cycle (E3) should be used for these applications and have corrected this in the final rule.

We received comment that the 8-mode (C1) duty cycle was not designed to represent variable-speed propulsion engines intended for use with variable-pitch or electrically-coupled propellers. Caterpillar provided an example of a power curve for a variable-speed engine designed to operate with a controllable pitch propeller where the operation is limited at low and mid-range speeds. In this case, we agree that the constant speed (E2) test duty cycle, combined with the NTE requirements, is more representative of the operation of this engine than the proposed C1 cycle. For this engine, the power and torque at the C1 intermediate speed is relatively low, leading to a heavy weighting of low power operation. In addition, the power limit curve, for overload protection, is at lower power than even the E3 duty cycle.

Controllable pitch propellers are also used with variable speed engines that have power curves that are more similar to those seen for nonroad engines or marine engines used with fixed pitch propellers. We are concerned that the E2 duty cycle would not be representative of the operation of these engines. Therefore, we are finalizing the E3 duty cycle for variable-speed propulsion engines intended for use with variable-pitch or electrically-coupled propellers. In the case where the engine is not capable of operating over the E3 duty cycle in-use, the E2 duty cycle would be used. For the purposes of this requirement, we consider an engine capable of operating over the E3 duty cycle if the engine can safely achieve more than 1.15 times the power

specified in the E3 duty cycle at 63, 80, and 91 percent of maximum test speed.

(10) Definition of Recreational Marine Diesel Vessel

We are adopting a revised the definition of recreational marine diesel vessel in part 1042 that will essentially return to the definition we originally adopted in 1999. This revision will effectively rescind that change we made in our 2003 recreational engine rule (68 FR 9745, February 28, 2003). As is described later, in that rulemaking we revised the definition of recreational vessel by adding a reference to the Coast Guard definition in 46 U.S.C. 2101. However, since then, it has become clear that the revision resulted in significant confusion for industry.

As described above, the Tier 3 standards that apply to recreational marine diesel engines are different than those that apply to standard power density commercial engines and recreational engines are not subject to the Tier 4 standards. Recreational engines are also subject to different compliance requirements, notably the duty cycle for certification testing and their useful life. These programmatic differences reflect the different way in which these engines are used, with recreational engines generally having a higher power/density ratio, operating at a higher load, and being used for fewer hours over their life than commercial engines.

Recreational engines are defined based on whether or not they are intended by the engine manufacturer to be installed on a recreational vessel. In our 1999 Tier 2 marine diesel engine rule, we defined recreational vessel as a vessel intended by the vessel operator to be operated primarily for pleasure or leased to another for the latter's pleasure, with the exception of (i) vessels less than 100 gross tons that carry more than six passengers; and (ii) vessels more than 100 gross tons that carry one or more passengers, where passenger means someone who pays to be on the vessel.

The goal of this definition was to exclude so-called recreational vessels that are in fact operated like commercial vessels: Those that are operated many hours a year (for example, charter fishing vessels and smaller tour vessels that are rented on an individual basis, with or without a crew). A personal vessel owned by an individual for his personal use and not for hire was intended to be considered to be a recreational vessel. For smaller vessels, this is achieved by requiring that there be fewer than six paying passengers; this allows an individual to invite

friends onboard his or her vessel in return for some pecuniary arrangement (e.g., paying for the gas). For larger vessels, above 100 gross tons, the presence of any paying passenger prevents the vessel from being characterized as recreational; this is intended to cover luxury yachts that recover costs by taking paying passengers onboard. The specified paying passenger thresholds are high enough to make them likely to be known at the time the vessel is purchased.

In the 2003 rule, we revised the definition of recreational vessel, by adding a reference to the Coast Guard definition. However, the Coast Guard definition and EPA's definition have different intents. Coast Guard's requirements are safety related to ensure adequate lifesaving equipment is onboard a recreational vessel. For example, the Coast Guard definitions differentiate between charter and noncharter vessels based on whether vessels are operated with or without a crew. The intent of EPA's approach is to identify those vessels that are intended for pleasure as opposed to commercial applications. Thus our definition needs to rely on features that can be known at the time of manufacture. For example, by setting a six passenger threshold for small vessels our intent was to identify those vessels clearly identified by the manufacturer as being intended for charter use and not used as a charter either incidentally or unintentionally.

Since the Coast Guard definitions do not reflect the intent of EPA's program and are inconsistent with EPA's definitions, we are revising the definitions to remove the references to the Coast Guard definitions and reverting back to the original definitions adopted in 1999. While the new definition is being adopted in part 1042, § 94.12(i) of part 94 will allow manufacturers to use this new definition for certification under part 94. Commercial vessels that were categorized as recreational prior to that time due to confusion about the meaning of the definitions will not be affected by the revised definitions.

(11) Engine Stockpiling by Vessel Builders

Our existing marine diesel engine program specifies in § 94.1103(a)(5) that it is a prohibited act to introduce into commerce a new vessel containing an engine not covered by a certificate of conformity applicable for an engine model year the same as or later than the calendar year in which the manufacture

of the new vessel is initiated.¹⁶⁹ However, as an exception, we allow vessel manufacturers to use up their normal inventory of engines not certified to new, more stringent emission standards if they were built before the date on which the new standards apply (subject to stockpiling prohibitions). With the adoption of the Tier 3 and 4 emission standards, the location of this provision transfers to § 1068.101(a)(1), including the exception noted above, now being located in § 1068.105(a).

The normal inventory approach above was developed in response to traditional business practice in automotive and other industries where vehicles and equipment are serially manufactured. Although this scheme works well for most manufacturers of small, serially-produced marine vessels, its application to manufacturers of large, commercial marine vessels may not be so straightforward. In this latter case there are typically long lead-time build schedules and low production volumes, which translate to vessel manufacturers maintaining lean inventory onsite at the shipyard. Vessel manufacturers usually order engines from dealers upon entering into a vessel construction agreement with an end customer. Due to lengthy build schedules, which for many projects can be counted in years, and the location of some shipyards in low-lying coastal areas subject to seasonal flooding, engines are often delivered and warehoused at the dealers' offsite location until such time as the vessels are ready to receive them for installation. Especially in projects where construction agreements involve multiple vessels, engines for all vessels may be ordered and delivered to the dealer during the same year in which construction of the first vessel is initiated. Due to this type of business practice, we will allow vessel manufacturers to consider as part of their normal inventory those engines that are warehoused at offsite dealerships and for which the vessel manufacturer entered into a purchase agreement prior to a change in applicable emission standards, provided this practice is consistent with the vessel manufacturers past engine ordering practices. We will allow this normal inventory of engines to be used up after new emission standards apply.

¹⁶⁹ The manufacture of a vessel is initiated when the keel is laid, or the vessel is at a similar stage of construction. "A similar stage of construction" means: (1) the stage at which construction identifiable with a specific vessel begins, and (2) assembly of that vessel has commenced comprising at least 50 tons or one percent of the estimated mass of all structural material, whichever is less.

It should be noted, however, that this clarification does not extend to engines that are not the subject of a prior purchase agreement, and would not allow a vessel manufacturer to search for a previous tier engine among engine dealers to evade the standards. Also, if a dealer has previous tier engines that are not the subject of a prior purchase agreement after a new tier of standards goes into effect, those engines may be used only as replacement engines, subject to § 1042.615; those engines may not be sold for use in new vessels.

(12) Other Issues

Several commenters, including the United States Coast Guard, raised questions regarding the possibility that advanced aftertreatment based emission control systems for marine diesel engines may need to be by-passed or otherwise modified or disabled in order to guarantee safe operation under emergency conditions. In general terms, the commenters speculated that the catalyst systems could fail in such a manner as to restrict exhaust flow reducing engine power and potentially endangering vessel safety.

Marine vessels that lose power to a main propulsion engine or generating engine providing essential power to main propulsion engine auxiliaries could go adrift with almost no control. Unlike trucks and locomotives, marine vessels have no brakes and can literally "coast" for miles and due to their enormous tonnage have an incredible amount of momentum and can cause catastrophic damage via collisions, allisions, and groundings. In the past, main propulsion failures on marine vessels have resulted in severe loss of life, property, and damage to the marine environment. Due to this precedent, a loss of main propulsion is defined as a "marine casualty or accident" in 46 CFR 4.03-1(b)(2)(ix) and 46 CFR 4.05-1 requires the occurrence to be immediately reported to the Coast Guard. To avoid potential loss of propulsion 46 CFR 58.01-35 effectively requires that main propulsion auxiliary machinery be provided in duplicate to prevent single point of failure.

Our discussions with the engine manufacturers regarding the technologies they expect to use to comply with the rules we are finalizing today, lead us to conclude that such failure mechanisms are extremely unlikely given the robust nature of the technologies.¹⁷⁰ However, reflecting the

¹⁷⁰ We should note here that the standards in our rules are performance-based rather than a prescription for the application of a specific technology. Our rules do not prevent a

high priority everyone places on safety and the reality that no one can say today with absolute certainty how emission control systems will be designed in the future, we are continuing several regulatory provisions that further ensure safe vessel operation under all circumstances. Consistent with Coast Guard's requirements for main propulsion auxiliary machinery, we feel these provisions address the single point of failure concern in the design of emission control systems.

First, we are continuing our general regulatory requirement found in § 1042.115(e) stating that a manufacturer may not design engines with emission-control devices, systems, or elements of design that cause or contribute to an unreasonable risk to public health, welfare, or safety while operating. Likewise, our regulations continue to make clear that actions taken by the operators of marine vessels in order to respond to a temporary emergency will not be considered tampering under § 1068.101(b)(1) provided the system is returned to its proper function as soon as possible. Lastly, in evaluating auxiliary emission control devices (AECs) for marine diesel engines we will continue to recognize that AECs, such as those that eliminate a single point of failure, are not defeat devices as defined under § 1042.115(f) if the AECs are necessary to prevent engine (or vessel) damage or accidents. In the case of AEC approval, we will continue our current practice of reviewing manufacturer certification applications to ensure that these provisions are only used when necessary. Further, it is our general expectation that engine manufacturers will provide diagnostic systems to alert vessel operators when such AECs are active and if the AEC requires the operator to take an action, the diagnostic system should give the vessel operator as much advance warning as reasonably possible.

V. Costs and Economic Impacts

In this section, we present the projected cost impacts and cost effectiveness of the standards, and our analysis of the expected economic impacts on affected markets. The projected benefits and benefit-cost analysis are presented in Section VI. The benefit-cost analysis explores the net yearly economic benefits to society of the reduction in mobile source emissions expected to be achieved by

manufacturer from developing and applying new or different technology at some future time as long as it meets the performance basis in the rules (e.g., a 0.04 g/kW-hr standard PM).

this rulemaking. The economic impact analysis explores how the costs of the rule will likely be shared across the manufacturers and users of the engines and equipment that will be affected by the standards. Unless noted otherwise, all costs are in 2005 dollars.

The annual monetized health benefits of this rule in 2030 will range from \$9.2 and \$11 billion, assuming a 3 percent discount rate, or between \$8.4 billion to \$10 billion, assuming a 7 percent discount rate. The social costs of the new standards are estimated to be approximately \$738 million in 2030.¹⁷¹ The impact of these costs on society are estimated to be small, with the prices of rail and marine transportation services estimated to increase by about 1 percent.

Further information on these and other aspects of the economic impacts of our final rule are summarized in the following sections and are presented in more detail in the Final RIA for this rulemaking.

A. Engineering Costs

The following sections briefly discuss the various engine and equipment cost elements considered for this cost analysis and present the total engineering costs we have estimated for this rulemaking; the reader is referred to Chapter 5 of the final RIA for a complete discussion of our engineering cost estimates. When referring to "equipment" costs throughout this discussion, we mean the locomotive and/or marine vessel related costs as opposed to costs associated with the diesel engine being placed into the locomotive or vessel. Estimated freshly manufactured engine and equipment engineering costs depend largely on both the size of the piece of equipment and its engine, and on the technology package being added to the engine to ensure compliance with the standards. The wide size variation of engines covered by this program (e.g., small marine engines with less than 37 kW (50 horsepower, or hp) through locomotive and marine C2 engines with over 3000 kW (4000 hp) and the broad application variation (e.g., small pleasure crafts through large line haul locomotives and

cargo vessels) that exists in these industries makes it difficult to present an estimated cost for every possible engine and/or piece of equipment. Nonetheless, for illustrative purposes, we present some example per engine/equipment engineering cost impacts throughout this discussion. This engineering cost analysis is presented in detail in Chapter 5 of the final RIA.

Note that the engineering costs here do not reflect changes to the fuel used to power locomotive and marine engines. Our Nonroad Tier 4 rule (69 FR 38958) controlled the sulfur level in all nonroad fuel, including that used in locomotives and marine engines. The sulfur level in the fuel is a critical element of the locomotive and marine program. However, since the costs of controlling locomotive and marine fuel sulfur have been considered in our Nonroad Tier 4 rule, they are not considered here. This analysis considers only those costs associated with the locomotive and marine program being finalized today. Also, the engineering costs presented here do not reflect any savings that are expected to occur because of the engine ABT program and the various flexibilities included in the program which are discussed in section IV of this preamble. As discussed there, these program features have the potential to provide savings for both engine and locomotive/vessel manufacturers.

(1) Freshly Manufactured Engine and Equipment Variable Engineering Costs

Engineering costs for exhaust emission control devices (i.e., catalyzed DPFs, SCR systems, and DOCs) were estimated using a methodology consistent with the one used in our 2007 heavy-duty highway rulemaking. In that rule, surveys were provided to nine engine manufacturers seeking information relevant to estimating the engineering costs for and types of emission-control technologies that might be enabled with ultra low-sulfur diesel fuel (15 ppm S). The survey responses were used as the first step in estimating the engineering costs of advanced emission control technologies anticipated for meeting the 2007 heavy-

duty highway standards. We then built upon these engineering costs using input from members of the Manufacturers of Emission Controls Association (MECA). We also used this information in our recent nonroad Tier 4 (NRT4) rule. Because the anticipated emission control technologies expected to be used on locomotive and marine engines are the same as or similar to those expected for highway and nonroad engines, and because the expected suppliers of the technologies are the same for these engines, we have used that analysis as the starting point for estimating the engineering costs of these technologies in this rule.¹⁷² Importantly, the analysis summarized here and detailed in the final RIA takes into account specific differences between the locomotive and marine products when compared to on-highway trucks (e.g., engine size).

Engineering costs of control include variable costs (for new hardware, its assembly, and associated markups) and fixed costs (for tooling, research, redesign efforts, and certification). We are projecting that the Tier 3 standards will be met by optimizing the engine and emission controls that will exist on locomotive and marine engines in the Tier 3 timeframe. Therefore, we have estimated no hardware costs associated with the Tier 3 standards. For the Tier 4 standards, we are projecting that SCR systems and DPFs will be the most likely technologies used to comply. Upon installation in a new locomotive or a new marine vessel, these devices would require some new equipment related hardware in the form of brackets, new sheet metal, and a reductant storage and delivery system. The annual variable costs for example years, the PM/NO_x split of those engineering costs, and the net present values that would result are presented in Table V-1.¹⁷³ As shown, we estimate the net present value for the years 2006 through 2040 of all variable costs at \$1.5 billion using a three percent discount rate, with \$1.3 billion of that being engine-related variable costs.¹⁷⁴ Using a seven percent discount rate, these costs are \$674 million and \$575 million, respectively.

This has the consequence of discounting the current year costs, effectively 2007, and all subsequent years are discounted by an additional year. The result is a slightly smaller NPV of engineering costs than by calculating the NPV over 2007-2040 (3% smaller for 3% NPV and 7% smaller for 7% NPV). The same convention applies for the emission inventories as shown in Table V-7. We have used 2006 because we intended to publish the proposal in 2006. For the final analysis, we have chosen to continue with 2006 to make comparisons between proposal and final analyses more clear.

¹⁷¹ The estimated 2030 social welfare cost of \$738 million is based on draft compliance costs for this final rule of \$740 million for that year. The final compliance cost estimate for 2030 is somewhat higher, at \$759 million; see section VI.C for an explanation. This difference is not expected to have an impact on the results of the market analysis or on the expected distribution of social costs among stakeholders.

¹⁷² "Economic Analysis of Diesel Aftertreatment System Changes Made Possible by Reduction of Diesel Fuel Sulfur Content," Engine, Fuel, and Emissions Engineering, Incorporated, December 15,

1999, Public Docket No. A-2001-28, Docket Item II-A-76.

¹⁷³ The PM/NO_x+NMHC cost allocations for variable costs used in this cost analysis are as follows: SCR systems including marinization costs on marine applications are 100% NO_x+NMHC; DPF systems including marinization costs on marine applications are 100% PM; and, equipment hardware costs are split evenly.

¹⁷⁴ Throughout our cost and economic impact analyses, net present value (NPV) calculations are based on the period 2006-2040, reflecting the period when the NPRM analysis was completed.

TABLE V-1.—FRESHLY MANUFACTURED ENGINE AND EQUIPMENT VARIABLE ENGINEERING COSTS
[Millions of 2005 dollars]

Year	Engine variable engineering costs	Equipment variable engineering costs	Total variable engineering costs	Total for PM	Total for NO _x +NMHC
2008	\$0	\$0	\$0	\$0	\$0
2009	\$0	\$0	\$0	\$0	\$0
2010	\$0	\$0	\$0	\$0	\$0
2011	\$0	\$0	\$0	\$0	\$0
2012	\$0	\$0	\$0	\$0	\$0
2015	\$60	\$11	\$71	\$37	\$34
2020	\$82	\$14	\$96	\$50	\$46
2030	\$99	\$18	\$117	\$61	\$56
2040	\$98	\$17	\$115	\$60	\$55
NPV at 3%	\$1,255	\$220	\$1,475	\$772	\$703
NPV at 7%	\$575	\$100	\$674	\$353	\$321

We can also look at these variable engineering costs on a “per engine” and a “per piece of equipment” basis rather than an annual total basis. Doing so results in the costs summarized in Table V-2. The costs shown represent the total engine-related and equipment-related engineering hardware costs associated with all of the new emissions standards

to which the given power range and market segment would need to comply. For example, a commercial marine engine below 600 kW (805 hp) would need to comply with the Tier 3 standards as its final tier and would, therefore, incur no new hardware costs. In contrast, a commercial marine engine over 600 kW is expected to comply with

both Tier 3 and then Tier 4 and would, therefore, incur hardware costs associated with the Tier 4 standards. The costs also represent long term costs or those costs after expected learning effects have occurred and warranty costs have stabilized.

Table V-2 Long-term Variable Engineering Cost per New Engine & Piece of Equipment to Comply with the Final Tier of Standards (2005 dollars) ^a

Power Range	Locomotive Line haul	Locomotive Switcher ^b	C1 Marine	C2 Marine
Engine Costs (\$/engine)				
600≤kW<1500	NA ^c	NA	\$11,540	\$29,960
≥1500 kW	\$54,630	\$13,640	\$20,050	\$55,750
# of engines/piece of equipment				
600≤kW<1500	NA	NA	2	2
≥1500 kW	1	1	2	2
Equipment Costs (\$/piece of equipment for Tier 4 engines)				
600≤kW<1500	NA	NA	\$23,070	\$59,910
≥1500 kW	\$54,630	\$13,640	\$40,110	\$111,510
Equipment Costs (\$/piece of equipment to accommodate Tier 4 engines)				
600≤kW<1500	NA	NA	\$5,500	\$5,500
≥1500 kW	\$10,400	\$7,500	\$10,400	\$10,400
Total Variable Cost (\$/piece of equipment)				
600≤kW<1500	NA	NA	\$28,570	\$65,420
≥1500 kW	\$65,020	\$21,140	\$50,490	\$121,890

Notes:

- (a) We have estimated no variable engineering costs associated with the Tier 3 standards and none associated with the Tier 4 standards for power ranges below 600 kW (800 hp) or for the recreational marine and small commercial marine categories.
- (b) Locomotive switchers generally use land-based nonroad engines (i.e., NRT4 engines); therefore, we have used NRT4 cost estimates for locomotive switchers in this rulemaking.
- (c) NA (not applicable) means there are no engines in that market segment/power range.

(2) Freshly Manufactured Engine and Equipment Fixed Engineering Costs

Because these technologies are being researched for implementation in the highway and nonroad markets well

before the locomotive and marine emission standards take effect, and because engine manufacturers will have had several years complying with the highway and nonroad standards, we

believe that the technologies used to comply with the locomotive and marine standards will have undergone significant development before reaching locomotive and marine production, and

we have considered this in estimating the costs for research and development. Chapter 5 of the final RIA details our approach which differs from our approach in the draft RIA. We anticipate that engine manufacturers would introduce a combination of primary technology upgrades to meet the new emission standards. Achieving very low NO_x emissions requires basic research on NO_x emission-control technologies

and improvements in engine management. There would also have to be some level of tooling expenditures to make possible the fitting of new hardware on locomotive and marine engines. We also expect that locomotives and marine vessels being fitted with Tier 4 engines would have to undergo some level of redesign to accommodate the aftertreatment devices expected to meet the Tier 4 standards.

The total of fixed engineering costs and the net present values of those costs are shown in Table V-3.¹⁷⁵ As shown, we have estimated the net present value for the years 2006 through 2040 of all fixed engineering costs at \$549 million using a three percent discount rate, with \$471 million of that being engine-related research costs. Using a seven percent discount rate, these costs are \$422 million and \$371 million, respectively.

TABLE V-3.—FRESHLY MANUFACTURED ENGINE AND EQUIPMENT FIXED ENGINEERING COSTS
[Millions of 2005 dollars]

Year	Engine research	Engine tooling	Engine certification	Equipment redesign	Total fixed engineering costs	Total for PM	Total for NO _x +NMHC
2008	\$34	\$0	\$0	\$0	\$34	\$11	\$23
2009	34	0	0	0	34	11	23
2010	68	0	0	0	68	23	46
2011	114	19	5	0	138	50	88
2012	80	0	0	0	80	27	54
2015	46	17	1	13	76	30	46
2020	0	0	0	3	3	1	1
2030	0	0	0	3	3	1	1
2040	0	0	0	0	0	0	0
NPV at 3%	471	33	6	39	549	194	354
NPV at 7%	371	24	5	22	422	148	274

Some of the estimated fixed engineering costs would occur in years prior to the Tier 3 standards taking effect in 2012. Engine manufacturers would need to invest in engine tooling and certification prior to selling engines that meet the standards. Engine research is expected to begin five years in advance of the standards for which the research is done. We have estimated some engine research for both the Tier 3 and Tier 4 standards, although the research associated with the Tier 4 standards is expected to be higher since it involves work on aftertreatment devices which only the Tier 4 standards would require. By 2016, the Tier 4 standards would be fully implemented and engine research toward the Tier 4 standards would be completed. Similarly, engine tooling and

certification efforts would be completed. We have estimated that equipment redesign, driven mostly by marine vessel redesigns, would continue for many years given the nature of the marine market. Therefore, by 2017 all engine-related fixed engineering costs would be zero, and by 2033 all equipment-related fixed engineering costs would be zero.

(3) Freshly Manufactured Engine Operating Costs

We anticipate an increase in costs associated with operating locomotives and marine vessels. We anticipate three sources of increased operating costs: Reductant use; DPF maintenance; and a fuel consumption impact. Increased operating costs associated with reductant use would occur only in those

locomotives/vessels equipped with a SCR engine using a reductant like urea. Maintenance costs associated with the DPF (for periodic cleaning of accumulated ash resulting from unburned material that accumulates in the DPF) would occur in those locomotives/vessels that are equipped with a DPF engine. The fuel consumption impact is anticipated to occur more broadly—we expect that a one percent fuel consumption increase would occur for all new Tier 4 engines, locomotive and marine, due to higher exhaust backpressure resulting from aftertreatment devices. These costs and how the fleet cost estimates were generated are detailed in Chapter 5 of the final RIA and are summarized in Table V-4.¹⁷⁶

TABLE V-4.—FRESHLY MANUFACTURED ENGINE ESTIMATED INCREASED OPERATING COSTS
[Millions of 2005 dollars]

Year	Reductant use	DPF maintenance	Fuel consumption impact	Total operating costs	Total for PM	Total for NO _x +NMHC
2008	\$0	\$0	\$0	\$0	\$0	\$0
2009	0	0	0	0	0	0
2010	0	0	0	0	0	0
2011	0	0	0	0	0	0
2012	0	0	0	0	0	0
2015	23	0	7	30	4	26

¹⁷⁵ The PM/NO_x+NMHC cost allocations for fixed costs used in this cost analysis are as follows: Engine research expenditures are 67% NO_x+NMHC and 33% PM; engine tooling and certification costs

are split evenly; and, equipment redesign costs are split evenly.

¹⁷⁶ The PM/NO_x+NMHC cost allocations for operating costs used in this cost analysis are as

follows: Reductant costs are 100% NO_x+NMHC; DPF maintenance costs are 100% PM; and, fuel consumption impacts are split evenly.

TABLE V-4.—FRESHLY MANUFACTURED ENGINE ESTIMATED INCREASED OPERATING COSTS—Continued
[Millions of 2005 dollars]

Year	Reductant use	DPF maintenance	Fuel consumption impact	Total operating costs	Total for PM	Total for NO _x +NMHC
2020	143	3	42	187	24	164
2030	409	8	118	535	67	468
2040	619	12	175	806	99	707
NPV at 3%	4,031	75	1,157	5,264	654	4,610
NPV at 7%	1,575	29	453	2,057	256	1,801

As shown, we have estimated the net present value for the years 2006 through 2040 of the annual operating costs at \$5.2 billion using a three percent discount rate and \$2.1 billion using a seven percent discount rate. The operating costs are zero until Tier 4 engines start being sold since only the Tier 4 engines are expected to incur increased operating costs (note that operating costs associated with the remanufacturing programs are discussed below). Reductant use represents the largest source of increased operating costs. Because reductant use is meant for controlling NO_x emissions, most of the operating costs are associated with NO_x+NMHC control.

(4) Engineering & Operating Costs Associated With the Remanufacturing Programs

We have also estimated engineering costs associated with the locomotive

and marine remanufacturing programs. The remanufacturing process is not a low cost endeavor. However, it is much less costly than purchasing a freshly manufactured engine. The engineering costs we have estimated associated with the remanufacturing program are not meant to capture the remanufacturing process but rather the incremental engineering costs to that process. Therefore, the remanufacturing costs estimated here are only those engineering and operating costs resulting from the requirement to meet a more stringent standard than the engine was designed to meet at its original sale. In addition to incremental hardware costs, we expect that some remanufactured engines will see a fuel consumption impact. We expect a one percent fuel consumption increase will occur for remanufactured Tier 0 locomotives because we believe that the

tighter NO_x standard will be met using retarded timing. For the same reason, we expect a two percent fuel consumption increase for remanufactured C2 marine engines. The marine engines will have timing retarded to the same degree as locomotives, but the relative degree of timing retard will be greater for marine engines given their initial state of control. These engineering and operating costs and how they were generated are detailed in Chapter 5 of the final RIA and are summarized in Table V-5.¹⁷⁷ As shown, we have estimated the net present value for the years 2006 through 2040 of the annual engineering and operating costs associated with the locomotive and marine remanufacturing programs at \$2.1 billion using a 3 percent discount rate and \$1.2 billion using a 7 percent discount rate.

TABLE V-5.—ESTIMATED HARDWARE AND OPERATING COSTS ASSOCIATED WITH THE LOCOMOTIVE & MARINE REMANUFACTURING PROGRAMS
[Millions of 2005 dollars]

Year	Locomotive	Marine	Total	Total for PM	Total for NO _x +NMHC
2008	\$59	\$16	\$75	\$38	\$38
2009	32	21	54	27	27
2010	58	27	85	42	42
2011	111	32	143	71	71
2012	91	44	135	68	68
2015	52	37	89	44	44
2020	37	26	63	31	31
2030	94	12	106	53	53
2040	158	3	161	80	80
NPV at 3%	1,669	450	2,120	1,060	1,060
NPV at 7%	864	289	1,153	577	577

(5) Total Engineering & Operating Costs

The total engineering and operating costs associated with today's final rule are the summation of the new engine

and new equipment engineering costs, both fixed and variable, the new engine operating costs for freshly manufactured engines, and the hardware and

operating costs associated with the locomotive and marine remanufacturing programs. These costs are summarized in Table V-6.

¹⁷⁷ Costs associated with the remanufacturing program are split evenly between NO_x+NMHC and PM. Note that the costs associated with the marine

remanufacturing program are consistent with the inventory reductions discussed in section II. Our estimate of the number of remanufactured engines

is presented in a memorandum from Amy Kopin to the docket for this rule (see Docket Item No. EPA-HQ-OAR-2003-0190-0847).

TABLE V-6.—TOTAL ENGINEERING & OPERATING COSTS OF THE FINAL PROGRAM
(Millions of 2005 dollars)

Year	Freshly manufactured engine related engineering costs	Freshly manufactured equipment related engineering costs	Freshly manufactured engine & equipment operating costs	Hardware and operating costs associated with the remanufacturing programs	Total engineering costs	Total PM costs	Total NO _x +NMHC costs
2008	\$34	\$0	\$0	\$75	\$109	\$49	\$60
2009	34	0	0	54	87	38	49
2010	68	0	0	85	153	65	88
2011	138	0	0	143	281	121	160
2012	80	0	0	135	215	94	121
2015	123	24	30	89	266	116	150
2020	82	17	187	63	349	106	242
2030	99	20	535	105	759	181	578
2040	98	17	806	161	1,082	240	842
NPV at 3%	1,764	260	5,264	2,120	9,407	2,680	6,727
NPV at 7%	974	122	2,057	1,153	4,307	1,333	2,973

As shown, we have estimated the net present value of the annual engineering costs for the years 2006 through 2040 at \$9.4 billion using a three percent discount rate and \$4.3 billion using a seven percent discount rate. Roughly half of these costs are operating costs, with the bulk of those being reductant related costs. As explained above in the operating cost discussion, because reductant use is meant for controlling NO_x emissions, most of the operating costs and, therefore, the majority of the total engineering costs are associated with NO_x+NMHC control.

Figure V-1 graphically depicts the annual engineering costs associated with the program being finalized today. The engine costs shown represent the engineering costs associated with engine research and tooling, etc., and the incremental costs for new hardware such as DPFs and reductant SCR systems. The equipment costs shown represent the engineering costs associated with equipment redesign efforts and the incremental costs for new equipment-related hardware such as reductant storage and delivery systems, sheet metal and brackets. The

remanufacturing program costs include incremental hardware and operating costs for the locomotive and marine remanufacturing programs. The operating costs include incremental increases in operating costs associated with reductant use, DPF maintenance, and a one percent fuel consumption increase for new Tier 4 engines. The total program engineering costs are shown in Table V-6 as \$9.4 billion at a three percent discount rate and \$4.3 billion at a seven percent discount rate.

BILLING CODE 6560-50-P

Figure V-1 Annual Engineering Costs of the New Engine Standards and Locomotive & Marine Remanufacturing Programs

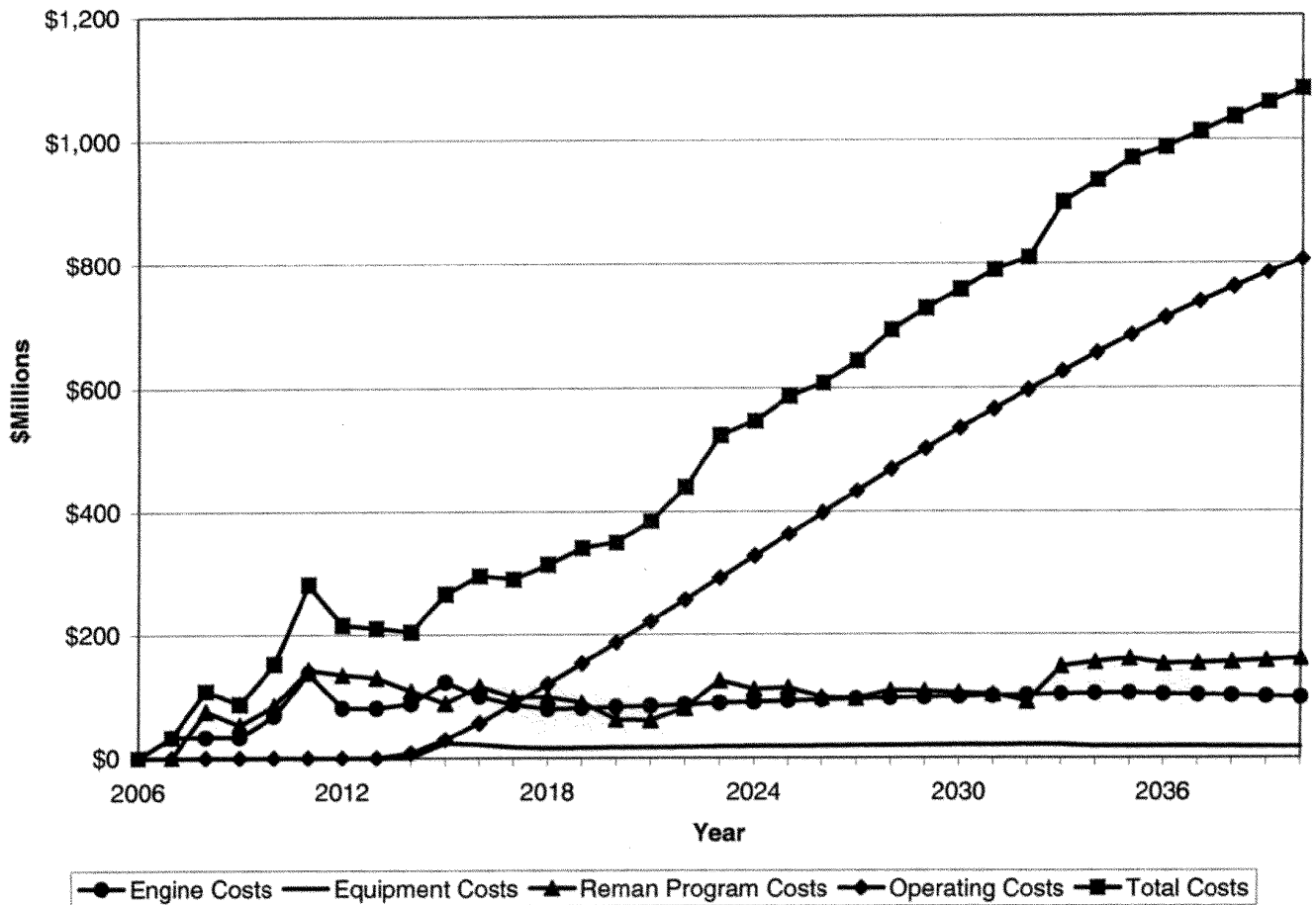

BILLING CODE 6560-50-C

B. Cost Effectiveness

As discussed in section VI, this rule is very cost beneficial, with social benefits far outweighing social costs. However, this does not shed light on how cost effective this control program is compared to other control programs at providing the expected emission reductions. One tool that can be used to assess the value of the final program is the ratio of engineering costs incurred per ton of emissions reduced and comparing that ratio to other control programs. As we show in this section, the PM and NO_x emissions reductions from the new locomotive and marine diesel program compare favorably—in terms of cost effectiveness—to other mobile source control programs that have been or will soon be implemented.

We note that today’s action builds upon the efforts undertaken by the engine manufacturing industry to comply with our recent 2007/2010 heavy-duty highway and nonroad Tier 4 (NRT4) rulemakings. As such, and as discussed at length in Chapter 5 of the final RIA, much of the research and development associated with diesel emission controls builds upon the work done to comply with those earlier rules. This does not change the conclusion that the cost effectiveness of today’s action compares favorably with other actions deemed appropriate for society.

We have calculated the cost per ton of our program based on the net present value of all engineering costs incurred and all emission reductions generated from the current year 2006 through the year 2040. This approach captures all of

the costs and emissions reductions from our program including those costs incurred and emissions reductions generated by the locomotive and marine remanufacturing programs. The baseline case for this evaluation is the existing set of engine standards for locomotive and marine diesel engines and the existing remanufacturing requirements. The analysis timeframe is meant to capture both the early period of the program when very few new engines that meet the standards would be in the fleet, and the later period when essentially all engines would meet the new standards.

Table V-7 shows the emissions reductions associated with today’s rule. These reductions are discussed in more detail in section II of this preamble and Chapter 3 of the final RIA.

TABLE V-7.—ESTIMATED EMISSIONS REDUCTIONS ASSOCIATED WITH THE NEW LOCOMOTIVE AND MARINE PROGRAM (Short tons)

Year	PM _{2.5}	PM ₁₀ ^a	NO _x	NMHC
2015	7,000	8,000	161,000	14,000
2020	14,000	15,000	371,000	26,000
2030	27,000	27,000	795,000	40,000
2040	37,000	38,000	1,144,000	52,000
NPV at 3%	308,000	318,000	8,757,000	492,000
NPV at 7%	134,000	139,000	3,708,000	221,000

Note: (a) Note that, PM_{2.5} is estimated to be 97 percent of the more inclusive PM₁₀ emission inventory.

In Section II we generate and present PM_{2.5} inventories since recent research has determined that these are of greater health concern. Similarly, NMHC is estimated to be 93 percent of the more inclusive VOC emission inventory. Traditionally, we have used PM₁₀ and NMHC in our cost effectiveness calculations. Since cost effectiveness is

a means of comparing control measures to one another, we use PM₁₀ and NMHC in our cost effectiveness calculations for comparisons to past control measures.

Using the engineering costs shown in Table V-6 and the emission reductions shown in Table V-7, we can calculate the \$/ton associated with today's rule. These are shown in Table V-8. The

resultant cost per ton numbers depend on how the engineering costs presented above are allocated to each pollutant. Therefore, as described in section V.A, we have allocated costs as closely as possible to the pollutants for which they are incurred. These allocations are also discussed in detail in Chapter 5 of the final RIA.

TABLE V-8.—FINAL PROGRAM AGGREGATE COST PER TON AND LONG-TERM ANNUAL COST PER TON

Pollutant	2006 thru 2040 discounted life-time cost per ton at 3%	2006 thru 2040 discounted life-time cost per ton at 7%	Cost per ton in 2030	Cost per ton in 2040
NO _x +NMHC	\$730	\$760	\$690	\$700
PM	8,440	9,620	6,620	6,360

The costs per ton shown in Table V-8 for 2006 through 2040 use the net present value of the annualized engineering costs and emissions reductions associated with the program for the years 2006 through 2040. We have also calculated the costs per ton of emissions reduced in the years 2030 and 2040 using the annual engineering costs and emissions reductions in those

specific years. These numbers are also shown in Table V-8. All of the costs per ton include costs and emission reductions that will occur from the locomotive and marine remanufacturing programs.

In comparison with other emissions control programs, we believe that the new locomotive and marine program represents a cost effective strategy for

generating substantial NO_x+NMHC and PM reductions. This can be seen by comparing the cost effectiveness with the cost effectiveness of a number of standards that EPA has adopted in the past. Table V-9 and Table V-10 summarize the cost per ton of several past EPA actions to reduce emissions of NO_x+NMHC and PM from mobile sources.

TABLE V-9.—NEW LOCOMOTIVE AND MARINE PROGRAM COMPARED TO PREVIOUS MOBILE SOURCE PROGRAMS FOR NO_x+NMHC

Program	\$/ton NO _x +NMHC
Today's locomotive & marine standards	\$730
Tier 4 Nonroad Diesel (69 FR 39131)	1,140
Tier 2 Nonroad Diesel (EPA420-R-98-016, Chapter 6)	710
Tier 3 Nonroad Diesel (EPA420-R-98-016, Chapter 6)	480
Tier 2 vehicle/gasoline sulfur (65 FR 6774)	1,580—2,650
2007 Highway HD (66 FR 5101)	2,530
2004 Highway HD (65 FR 59936)	250—480

Note: Costs adjusted to 2005 dollars using the Producer Price Index for Total Manufacturing Industries.

TABLE V-10.—NEW LOCOMOTIVE AND MARINE STANDARDS COMPARED TO PREVIOUS MOBILE SOURCE PROGRAMS FOR PM

Program	\$/ton PM
Today's locomotive & marine standards	\$8,440
Tier 4 Nonroad Diesel (69 FR 39131)	12,630
Tier 1/Tier 2 Nonroad Diesel (EPA420-R-98-016, Chapter 6)	2,700

TABLE V-10.—NEW LOCOMOTIVE AND MARINE STANDARDS COMPARED TO PREVIOUS MOBILE SOURCE PROGRAMS FOR PM—Continued

Program	\$/ton PM
2007 Highway HD (66 FR 5101)	15,990

Note: Costs adjusted to 2005 dollars using the Producer Price Index for Total Manufacturing Industries.

C. EIA

We prepared an Economic Impact Analysis (EIA) to estimate the social costs associated with the final control program to estimate the market-level changes in prices and outputs for affected markets, the social costs of the program, and the expected distribution of those costs across stakeholders. As defined in EPA’s *Guidelines for Preparing Economic Analyses*, social costs are the value of the goods and services lost by society resulting from (a) the use of resources to comply with and implement a regulation and (b) reductions in output.¹⁷⁸

A quantitative Economic Impact Model (EIM) was developed to estimate price and quantity changes and total social costs associated with the emission control program.

The EIM is a computer model comprised of a series of spreadsheet modules that simulate the supply and demand characteristics of each of the markets under consideration. The model methodology is firmly rooted in applied microeconomic theory and was developed following the methodology set out in OAQPS’s *Economic Analysis Resource Document*.¹⁷⁹ Chapter 7 of the RIA contains a detailed description of the EIM, including the economic theory behind the model and the data used to construct it, the baseline equilibrium market conditions, and the model’s behavior parameters. The EIM and the estimated compliance costs presented above are used to estimate the economic impacts of the program. The results of this analysis are summarized below.

The engineering costs we used in the EIA are an earlier version of the estimated compliance costs developed for this final rule. The net present value of the engineering costs used in the EIA is estimated to be approximately \$9.17 billion (NPV over the period of analysis at 3 percent discount rate), which is

about \$240 million less than the net present value of the final estimated engineering costs of about \$9.41 billion. This difference is the sum of various cost adjustments, the largest of which are an increase of about \$222 million in operating costs for the marine markets and \$42 million in the operating costs for the rail markets (NPV over the period of analysis at 3 percent discount rate). These changes are not expected to have a substantial impact on the market level results because the differences are relatively small on an annual basis. For example, operating costs for C2 marine markets increase by about 15 percent in 2030 (from \$107 million to \$123 million). The previous estimate of \$107 million was associated with an increase of approximately 1.1 in the price of marine transportation services and a decrease of approximately 0.5 percent in the quantity of marine transportation services provided. A small increase in operating costs is not likely to change those results by very much. The market-level impacts on the other downstream markets are also likely to be very small and not economically significant. Finally, the difference in compliance costs will not affect the distribution of social costs, which is a function of the price elasticity of supply and demand.

(1) Market Analysis Results

In the market analysis, we estimate how prices and quantities of goods and services affected by the emission control program can be expected to change once the program goes into effect.

The compliance costs associated with the new locomotive and marine diesel engine standards are expected to lead to price and quantity changes in these markets. A summary of the market analysis results is presented in Table V-11 for 2012, which is representative of the first year of the Tier 3 standards; 2016, which is representative of the first year of the Tier 4 standards; and 2030, which represents market impacts of the program in the long-term. Results for all years can be found in Chapter 7 of the RIA.

For all markets, the market impacts for the early years of the program are driven by the transportation markets. In these years, the only direct compliance costs are associated with the remanufacture programs; there are no

variable costs associated with the Tier 3 standards and therefore no direct compliance costs. The transportation markets will experience operating costs increases; these will result in small increases in transportation market prices, which will translate to small contractions in demand for locomotives and marine diesel engines and vessels. This is expected exert marginal downward pressure on prices in those markets, of less than 0.1 percent. The production decreases are also expected to be very small, at 0.1 percent or less.

The Tier 4 programs are expected to result in larger market changes due to the direct compliance costs associated with Tier 4 standards and the continuing costs of the remanufacture programs. For the locomotive markets, the price increases in 2016 are expected to be about 4 percent for line haul locomotives and about one percent for switchers in 2016. In the long term (by 2030), prices are expected to increase to about 3.2 percent for line haul locomotives and about 1.5 percent for switchers. These small price increases reflect the relative amount of the compliance costs compared to the total cost of a locomotive or switcher (the engine is only a small part of the total cost of the locomotive). In all cases, the decrease in the quantity of line haul locomotives or switchers produced is expected to be less than 0.5 percent.

In the marine markets, price increases for engines are expected to be larger in 2016, varying from about 9 percent for C1 engines above 600 kW (800 hp) to 17 percent for auxiliary engines and C2 engines above 600 kW.¹⁸⁰ The price increases for vessels that use these engines, however, are smaller (about 2 percent and 7 percent, respectively), reflecting the relative amount of the compliance costs compared to the price of a commercial marine vessel. Production quantities are expected to decrease by less than 4 percent for engines and vessels. The long-term price impacts are similar, with expected price increases of about 12 percent for engines C2 above 600 kW and 7 percent for C1 engines above 600 kW, and vessel price

¹⁷⁸ EPA Guidelines for Preparing Economic Analyses, EPA 240-R-00-003, September 2000, p 113. A copy of this document can be found at <http://yosemite.epa.gov/ee/epa/eed.nsf/webpages/Guidelines.html>.

¹⁷⁹ U.S. Environmental Protection Agency, Office of Air Quality Planning and Standards, Innovative Strategies and Economics Group, OAQPS Economic Analysis Resource Document, April 1999. A copy of this document can be found at <http://www.epa.gov/ttn/ecas/econdata/Rmanual2/>.

¹⁸⁰ Results presented in this section are by marine engine category in kW; the actual EIA analysis presented in Chapter 7 of the RIA was performed using marine engine categories by hp.

increases of less than 5 percent. Long-term production quantity decreases are expected to be less than 3 percent.

TABLE V-11.—ESTIMATED MARKET IMPACTS FOR 2012, 2016, 2030
(2005\$)

Market ^c	Average variable engineering cost per unit	Change in price		Change in quantity	
		Absolute	Percent	Absolute	Percent
2012					
Rail Sector:					
Locomotives	\$0	-535	-0.03	-1	-0.1
Switcher/Passenger	0	-348	-0.03	0	-0.1
Transportation Services	NA	^a NA	0.1	^a NA	-0.1
Marine Sector					
Engines:					
Auxiliary >600 kW	0	-47	0.00	0	-0.1
C1>600 kW	0	-8	0.00	0	0.0
C2>600 kW	0	-139	-0.03	0	-0.1
Other marine	0	0	0.00	0	0.0
Vessels:					
C1>600 kW	0	-174	-0.01	0	0.0
C2>600 kW	0	-2,419	-0.07	0	-0.1
Other marine	0	-3	0.00	1	0.0
Transportation Services	NA	^a NA	0.2	^a NA	-0.1
2016					
Rail Sector:					
Locomotives	84,274	83,227	4.2	-1	-0.1
Switcher/Passenger	14,175	13,494	1.0	0	-0.1
Transportation Services	NA	^a NA	0.3	^a NA	-0.1
Marine Sector					
Engines:					
Auxiliary >600 kW	37,097	35,569	17.1	-11	-3.4
C1>600 kW	18,483	16,384	8.5	-15	-3.7
C2>600 kW	71,806	71,602	16.3	0	-0.2
Other marine	0	0	0.00	0	0.0
Vessels:					
C1>600 kW	8,277	^b 34,043	2.1	-14	-3.7
C2>600 kW	12,107	^b 255,143	7.0	0	-0.2
Other marine	0	-4	0.00	-1	0.0
Transportation Services	NA	^a NA	0.4	^a NA	-0.2
2030					
Rail Sector:					
Locomotives	65,343	63,019	3.2	-4	-0.3
Switcher/Passenger	21,139	19,628	1.5	-1	-0.3
Transportation Services	NA	^a NA	0.6	^a NA	-0.3
Marine Sector					
Engines:					
Auxiliary >600 kW	28,359	27,021	13.0	-11	-2.8
C1>600 kW	14,131	12,479	6.5	-13	-2.9
C2>600 kW	54,893	54,264	12.3	-1	-0.5
Other marine	0	-1	0.0	0	0.0
Vessels:					
C1>600 kW	6,933	^b 25,768	1.6	-12	-2.9
C2>600 kW	10,169	^b 164,774	5.1	0	-0.5
Other marine	0	-12	0.0	-4	0.0
Transportation Services	NA	^a NA	1.1	^a NA	-0.5

Notes:

^a The prices and quantities for transportation services are normalized (\$1 for 1 unit of services provided) and therefore it is not possible to estimate the absolute change price or quantity; see 7.3.1.5.

^b The estimated vessel impacts include the impacts of direct vessel compliance costs and the indirect impacts of engine markets for both propulsion and auxiliary engines. See Chapter 7 of the RIA.

^c Results presented in this table are by marine engine category in kW; the actual EIA analysis presented in Chapter 7 of the RIA was performed using marine engine categories by hp.

(2) Economic Welfare Analysis

In the economic welfare analysis, we look at the total social costs associated with the program and their distribution across key stakeholders.

The total estimated social costs of the program are about \$221 million, \$284 million, \$332 million and \$738 million for 2012, 2016, 2020, and 2030. These estimated social costs are nearly identical to the total compliance costs

for those years. The slight reduction in social costs when compared to compliance costs occurs because the total engineering costs do not reflect the decreased sales of locomotives, engines and vessels that are incorporated in the

total social costs. Results for all years are presented in Chapter 7 of the RIA.

Table V-12 shows how total social costs are expected to be shared across stakeholders for selected years.

We estimate the net social costs of the program to be approximately \$738

million in 2030.¹⁸¹ The rail sector is expected to bear about 62.5 percent of the social costs of the program in 2030, and the marine sector is expected to bear about 37.5 percent. In each of these two sectors, these social costs are expected to be born primarily by

producers and users of locomotive and marine transportation services (about 98 percent). The remaining 2 percent is expected to be borne by locomotive, marine engine, and marine vessel manufacturers and fishing and recreational users.

TABLE V-12.—SUMMARY OF ESTIMATED SOCIAL COSTS FOR 2012, 2016, 2020, 2030 (2005\$, \$MILLION)

Stakeholder group ^a	2012		2016	
	Surplus change (\$)	Percent	Surplus change (\$)	Percent
Locomotives:				
Locomotive producers	-35.1	15.9	-8.3	2.9
Line haul producers	-27.8	12.6	-0.9	0.3
Switcher/Passenger producers	-7.2	3.3	-7.4	2.6
Rail transportation service providers	-21.4	9.7	-43.4	15.3
Rail transportation service consumers	-68.4	31.0	-138.9	48.8
Total locomotive sector	-124.9	56.6	-190.6	67.0
Marine:				
Marine engine producers	-45.8	20.7	-2.1	0.7
Auxiliary > 600 kW	-16.0	7.3	-0.5	0.2
C1 > 600 kW	-19.0	8.6	-1.6	0.5
C2 > 600 kW	-10.7	4.9	0.0	0.0
Other marine	0.0	0.0	0.0	0.0
Marine vessel producers	-0.3	0.1	-15.8	5.6
C1 > 600 kW	-0.1	0.0	-13.5	4.7
C2 > 600 kW	-0.1	0.1	-2.2	0.8
Other marine	-0.1	0.0	-0.1	0.0
Recreational and fishing vessel consumers	0.0	0.0	0.0	0.0
Marine transportation service providers	-11.9	5.4	-18.1	6.4
Marine transportation service consumers	-38.1	17.3	-57.9	20.3
Auxiliary engines < 600 kW	0.0	0.0	0.0	0.0
Total marine sector	-96.1	43.5	-93.8	33.0
Total Program	-221.0	-284.4
Stakeholder group	2020		2030	
	Surplus change (\$)	Percent	Surplus change (\$)	Percent
Locomotives:				
Locomotive producers	-1.1	0.3	-3.1	0.4
Line haul producers	-1.0	0.3	-2.7	0.4
Switcher/Passenger producers	-0.1	0.0	-0.4	0.1
Rail transportation service providers	-46.4	14.0	-109.0	14.8
Rail transportation service consumers	-148.6	44.8	-348.9	47.3
Total locomotive sector	-196.1	59.1	-461.1	62.5
Marine:				
Marine engine producers	-1.8	0.5	-2.0	0.3
Auxiliary > 600 kW	-0.4	0.1	-0.5	0.1
C1 > 600 kW	-1.3	0.4	-1.4	0.2
C2 > 600 kW	0.0	0.0	-0.1	0.0
Other marine	0.0	0.0	0.0	0.0
Marine vessel producers	-10.3	3.1	-9.2	1.2
C1 > 600 kW	-8.8	2.7	-8.2	1.1
C2 > 600 kW	-1.3	0.4	-0.7	0.1
Other marine	-0.1	0.0	-0.3	0.0
Recreational and fishing vessel consumers	0.0	0.0	0.0	0.0
Marine transportation service providers	-29.5	8.9	-63.3	8.6
Marine transportation service consumers	-94.4	28.4	-202.5	27.4
Auxiliary engines < 600 kW	0.0	0.0	0.0	0.0
Total marine sector	-135.9	40.9	-277.0	37.5
Total Program	-332.0	-738.1

Note: ^a Results presented in this table are by marine engine category in kW; the actual EIA analysis presented in Chapter 7 of the RIA was performed using marine engine categories by hp.

¹⁸¹ All estimates presented in this section are in 2005\$.

Table V–13 shows the distribution of total surplus losses for the program from 2007 through 2040. This table shows that the rail sector is expected to bear about 62 percent of the total program social costs through 2040 (NPV 3%),

and that most of the costs are expected to be borne by the rail transportation consumers. The marine sector is expected to bear about 38 percent of the total program social costs through 2040 (NPV 3%), most of which are also

expected to be borne by the marine transportation consumers. This is consistent with the structure of the program, which leads to high compliance costs for the rail marine transportation sectors.

TABLE V–13. ESTIMATED NET SOCIAL COSTS 2007 THROUGH 2040 BY STAKEHOLDER (\$MILLION, 2005\$)

Stakeholder Groups ^a	Surplus change	Percent of total surplus	Surplus change	Percent of total surplus
Locomotives	NPV 3%	NPV 7%	
Locomotive producers	–\$221.1	2.4	–\$160.4	3.8
Line Haul	– 172.2		– 124.5	
Switcher/Passenger	– 48.9		– 35.9	
Rail transportation service providers	– 1,302.7	14.2	– 568.6	13.6
Rail transportation service consumers	– 4,168.7	45.6	– 1,819.5	43.5
Total locomotive sector	– 5,692.6	62.6	– 2,548.5	61.0
Marine				
Marine engine producers	– 307.5	3.4	– 229.4	5.5
Auxiliary > 600 kW	– 87.3		– 64.0	
C1 > 600 kW	– 106.8		– 74.6	
C2 > 600 kW	– 56.8		– 42.6	
Other marine	– 56.7		– 48.1	
Marine vessel producers	– 150.0	1.6	– 72.5	1.7
C1 > 600 kW	– 126.8		– 60.8	
C2 > 600 kW	– 19.7		– 10.2	
Other marine	– 3.5		– 1.5	
Recreational and fishing vessel consumers	0.2		0.1	
Marine transportation service providers	– 704.6	7.7	– 308.4	7.4
Marine transportation service consumers	– 2,254.7	24.6	– 986.9	23.6
Auxiliary Engines <600 kW	– 40.2	0.4	– 34.2	– 0.8
Total marine sector	3,456.7	37.8	– 1,631.3	39.0
Total Program	– 9,149.2		– 4,179.8	

Note: ^aResults presented in this table are by marine engine category in kW; the actual EIA analysis presented in Chapter 7 of the RIA was performed using marine engine categories by hp.

(3) What Are the Significant Limitations of the Economic Impact Analysis?

Every economic impact analysis examining the market and social welfare impacts of a regulatory program is limited to some extent by limitations in model capabilities, deficiencies in the economic literatures with respect to estimated values of key variables necessary to configure the model, and data gaps. In this EIA, there three potential sources of uncertainty: (1) Uncertainty resulting from the way the EIM is designed, particularly from the use of a partial equilibrium model; (2) uncertainty resulting from the values for key model parameters, particularly the price elasticity of supply and demand; and (3) uncertainty resulting from the values for key model inputs, particularly baseline equilibrium price and quantities.

Uncertainty associated with the economic impact model structure arises from the use of a partial equilibrium approach, the use of the national level of analysis, and the assumption of perfect competition. These features of the model mean it does not take into account impacts on secondary markets or the general economy, and it does not

consider regional impacts. The results may also be biased to the extent that firms have some control over market prices, which would result in the modeling over-estimating the impacts on producers of affected goods and services.

The values used for the price elasticities of supply and demand are critical parameters in the EIM. The values of these parameters have an impact on both the estimated change in price and quantity produced expected as a result of compliance with the new standards and on how the burden of the social costs will be shared among producer and consumer groups. In selecting the values to use in the EIM it is important that they reflect the behavioral responses of the industries under analysis.

Finally, uncertainty in measurement of data inputs can have an impact on the results of the analysis. This includes measurement of the baseline equilibrium prices and quantities and the estimation of future year sales. In addition, there may be uncertainty in how similar engines and equipment were combined into smaller groups to facilitate the analysis. There may also be

uncertainty in the compliance cost estimations.

While variations in the above model parameters may affect the distribution of social costs among stakeholders and the estimated market impacts, they will not affect the total social costs of the program. This is because the total social costs are directly related to the total compliance costs. To explore the effects of key sources of uncertainty on the distribution of social costs and on estimated price and quantity impacts, we performed a sensitivity analysis in which we examine the results of using alternative values for several model parameters. The results of these analyses are contained in Appendix 7H of the RIA prepared for this rule.

Despite these uncertainties, we believe this economic impact analysis provides a reasonable estimate of the expected market impacts and social welfare costs of the new standards in future. Acknowledging benefits omissions and uncertainties, we present a best estimate of the social costs based on our interpretation of the best available scientific literature and methods supported by EPA’s Guidelines for Preparing Economic Analyses and

the OAQPS Economic Analysis Resource Document.

VI. Benefits

This section presents our analysis of the health and environmental benefits that are estimated to occur as a result of the final locomotive and marine engine standards throughout the period from initial implementation through 2030. Nationwide, the engines that are subject to the emission standards in this rule are a significant source of mobile source air pollution. The standards will reduce exposure to NO_x and direct PM emissions and help avoid a range of adverse health effects associated with ambient PM_{2.5} and ozone levels. In addition, the standards will help reduce exposures to diesel PM exhaust, various gaseous hydrocarbons and air toxics. As described below, the reductions in PM and ozone from the standards are expected to result in significant reductions in premature deaths and other serious human health effects, as well as other important public health and welfare effects.

EPA typically quantifies and monetizes PM- and ozone-related impacts in its regulatory impact analyses (RIAs) when possible. The RIA for the proposal for this rulemaking only quantified benefits from PM; in the current RIA we quantify and monetize the ozone-related health and environmental impacts associated with the final rule. The science underlying the analysis is based on the current ozone criteria document.¹⁸² To estimate the incidence and monetary value of the health outcomes associated with this final rule, we used health impact functions based on published epidemiological studies, and valuation functions derived from the economics literature.¹⁸³ Key health endpoints analyzed include premature mortality, hospital and emergency room visits, school absences, and minor restricted activity days. The analytic approach to characterizing uncertainty is consistent

¹⁸² U.S. Environmental Protection Agency (2006) Air quality criteria for ozone and related photochemical oxidants (second external review draft) Research Triangle Park, NC: National Center for Environmental Assessment; report no. EPA/600/R-05/004aB-cB, 3v. Available: <http://cfpub.epa.gov/ncea/cfm/recordisplay.cfm?deid=137307> [March 2006]

¹⁸³ Health impact functions measure the change in a health endpoint of interest, such as hospital admissions, for a given change in ambient ozone or PM concentration.

with the analysis used in the RIA for the proposed O₃ NAAQS.

The benefits modeling is based on peer-reviewed studies of air quality and health and welfare effects associated with improvements in air quality and peer-reviewed studies of the dollar values of those public health and welfare effects. These methods are consistent with benefits analyses performed for the recent analysis of the proposed Ozone NAAQS and the final PM NAAQS analysis.^{184, 185} They are described in detail in the RIAs prepared for those rules.

The range of PM benefits associated with the final standards is estimated based on risk reductions estimated using several sources of PM-related mortality effect estimates. In order to provide an indication of the sensitivity of the benefits estimates to alternative assumptions about PM mortality risk reductions, in Chapter 6 of the RIA we present a variety of benefits estimates based on two epidemiological studies (including the ACS study and the Six Cities Study) and the recent PM mortality expert elicitation.¹⁸⁶ EPA intends to ask the Science Advisory Board to provide additional advice as to which scientific studies should be used in future RIAs to estimate the benefits of reductions in PM-related premature mortality.

The range of ozone benefits associated with the final standards is also estimated based on risk reductions estimated using several sources of ozone-related mortality effect estimates. There is considerable uncertainty in the magnitude of the association between ozone and premature mortality. This analysis presents four alternative estimates for the association based upon different functions reported in the scientific literature. We use the National Morbidity, Mortality and Air Pollution

¹⁸⁴ U.S. Environmental Protection Agency. August 2007. Proposed Regulatory Impact Analysis (RIA) for the Proposed National Ambient Air Quality Standards for Ozone. Prepared by: Office of Air and Radiation. Available at <http://www.epa.gov/ttn/ecas/ria.html#ria2007>.

¹⁸⁵ U.S. Environmental Protection Agency. October 2006. Final Regulatory Impact Analysis (RIA) for the Proposed National Ambient Air Quality Standards for Particulate Matter. Prepared by: Office of Air and Radiation. Available at <http://www.epa.gov/ttn/ecas/ria.html>.

¹⁸⁶ Industrial Economics, Incorporated (IEC). 2006. Expanded Expert Judgment Assessment of the Concentration-Response Relationship Between PM_{2.5} Exposure and Mortality. Peer Review Draft. Prepared for: Office of Air Quality Planning and Standards, U.S. Environmental Protection Agency, Research Triangle Park, NC. August.

Study (NMMAPS),¹⁸⁷ which was used as the primary basis for the risk analysis in the ozone Staff Paper¹⁸⁸ and reviewed by the Clean Air Science Advisory Committee (CASAC).¹⁸⁹ We also use three studies that synthesize ozone mortality data across a large number of individual studies.^{190, 191, 192} Note that there are uncertainties within each study that are not fully captured by this range of estimates.

Recognizing that additional research is necessary to clarify the underlying mechanisms causing these effects, we also consider the possibility that the observed associations between ozone and mortality may not be causal in nature. EPA has requested advice from the National Academy of Sciences on how best to quantify uncertainty in the relationship between ozone exposure and premature mortality in the context of quantifying benefits associated with ozone control strategies.

The range of total ozone- and PM-related benefits associated with the final standards is presented in Table VI-1. We present total benefits based on the PM- and ozone-related premature mortality function used. The benefits ranges therefore reflect the addition of each estimate of ozone-related premature mortality (each with its own row in Table VI-1) to estimates of PM-related premature mortality, derived from either the epidemiological literature or the expert elicitation. The estimates in Table VI-1, and all monetized benefits presented in this section, are in year 2006 dollars.

¹⁸⁷ Bell, M.L., et al. 2004. Ozone and short-term mortality in 95 US urban communities, 1987-2000. *JAMA*, 2004. 292(19): p. 2372-8.

¹⁸⁸ U.S. EPA (2007) Review of the National Ambient Air Quality Standards for Ozone, Policy Assessment of Scientific and Technical Information. OAQPS Staff Paper. EPA-452/R-07-003. This document is available in Docket EPA-HQ-OAR-2003-0190. This document is available electronically at: http://www.epa.gov/ttn/naaqs/standard/ozone/s_o3_cr_sp.html.

¹⁸⁹ CASAC (2007). Clean Air Scientific Advisory Committee's (CASAC) Review of the Agency's Final Ozone Staff Paper. EPA-CASAC-07-002. March 26.

¹⁹⁰ Bell, M.L., F. Dominici, and J.M. Samet. A meta-analysis of time-series studies of ozone and mortality with comparison to the national morbidity, mortality, and air pollution study. *Epidemiology*, 2005. 16(4): p. 436-45.

¹⁹¹ Ito, K., S.F. De Leon, and M. Lippmann. Associations between ozone and daily mortality: analysis and meta-analysis. *Epidemiology*, 2005. 16(4): p. 446-57.

¹⁹² Levy, J.I., S.M. Chemerynski, and J.A. Sarnat. 2005. Ozone exposure and mortality: an empiric bayes metaregression analysis. *Epidemiology*, 2005. 16(4): p. 458-68.

TABLE VI-1.—ESTIMATED 2030 MONETIZED PM- AND OZONE-RELATED HEALTH BENEFITS OF THE FINAL LOCOMOTIVE AND MARINE ENGINE STANDARDS^a

Premature ozone mortality function or assumption	Reference	Mean total benefits (billions, 2006\$, 3% discount rate) ^{c, d}	Mean total benefits (billions, 2006\$, 7% discount rate) ^{c, d}
2030 Total Ozone and PM Benefits—PM Mortality Derived From American Cancer Society Analysis^a			
NMMAPS	Bell et al., 2004	\$9.7	\$8.9.
Meta-analysis	Bell et al., 2005	\$11	\$9.8.
	Ito et al., 2005	\$11	\$10.
	Levy et al., 2005	\$11	\$10.
Assumption that association is not causal		\$9.2	\$8.4.
2030 Total Ozone and PM Benefits—PM Mortality Derived From Expert Elicitation^b			
NMMAPS	Bell et al., 2004	\$5.2 to \$37	\$4.8 to \$34.
Meta-analysis	Bell et al., 2005	\$6.2 to \$38	\$5.8 to \$35.
	Ito et al., 2005	\$6.7 to \$39	\$6.3 to \$35.
	Levy et al., 2005	\$6.7 to \$39	\$6.4 to \$35.
Assumption that association is not causal		\$4.7 to \$37	\$4.4 to \$33.

Notes:

^a Total includes ozone and PM_{2.5} benefits. Range was developed by adding the estimate from the ozone premature mortality function to the estimate of PM_{2.5}-related premature mortality derived from the ACS study (Pope et al., 2002).

^b Total includes ozone and PM_{2.5} benefits. Range was developed by adding the estimate from the ozone premature mortality function to both the lower and upper ends of the range of the PM_{2.5} premature mortality functions characterized in the expert elicitation. The effect estimates of five of the twelve experts included in the elicitation panel fall within the empirically-derived range provided by the ACS and Six-Cities studies. One of the experts fall below this range and six of the experts are above this range. Although the overall range across experts is summarized in this table, the full uncertainty in the estimates is reflected by the results for the full set of 12 experts. The twelve experts' judgments as to the likely mean effect estimate are not evenly distributed across the range illustrated by arraying the highest and lowest expert means.

^c Note that total benefits presented here do not include a number of unquantified benefits categories. A detailed listing of unquantified health and welfare effects is provided in Table VI-6.

^d Results reflect the use of both a 3 and 7 percent discount rate, as recommended by EPA's Guidelines for Preparing Economic Analyses and OMB Circular A-4. Results are rounded to two significant digits for ease of presentation and computation.

(1) Quantified Human Health and Environmental Effects of the Final Standards

In this section we discuss the ozone and PM_{2.5} health and environmental impacts of the final standards. We discuss how these impacts are monetized in the next section. It should be noted that the emission control scenarios used in the air quality and benefits modeling are slightly different than the final emission control program. The differences reflect further refinements of the regulatory program since we performed the air quality modeling for this rule. Emissions and air quality modeling decisions are made early in the analytical process. Chapter 3 of the RIA describes the changes in the inputs and resulting emission inventories between the preliminary assumptions used for the air quality modeling and the final emission control scenario.

Estimated Ozone and PM Impacts

To model the ozone and PM air quality benefits of this rule we used the Community Multiscale Air Quality (CMAQ) model. CMAQ simulates the numerous physical and chemical processes involved in the formation, transport, and deposition of particulate matter. This model is commonly used in regional applications to estimate the

ozone and PM reductions expected to occur from a given set of emissions controls. The meteorological data input into CMAQ are developed by a separate model, the Penn State University / National Center for Atmospheric Research Mesoscale Model, known as MM5. The modeling domain covers the entire 48-State U.S., as modeled in proposed ozone NAAQS analysis.¹⁹³ The grid resolution for the modeling domain was 12 x 12 km.

While this rule will reduce ozone levels generally and provide national ozone-related health benefits, this is not always the case at the local level. Due to the complex photochemistry of ozone production, reductions in NO_x emissions lead to both the formation and destruction of ozone, depending on the relative quantities of NO_x, VOC, and ozone catalysts such as the OH and HO₂ radicals. In areas dominated by fresh emissions of NO_x, ozone catalysts are removed via the production of nitric acid which slows the ozone formation rate. Because NO_x is generally depleted more rapidly than VOC, this effect is usually short-lived and the emitted NO_x can lead to ozone formation later and further downwind. The terms "NO_x

disbenefits" or "ozone disbenefits" refer to the ozone increases that can result from NO_x emissions reductions in these localized areas. According to the North American Research Strategy for Tropospheric Ozone (NARSTO) Ozone Assessment, these disbenefits are generally limited to small regions within specific urban cores and are surrounded by larger regions in which NO_x control is beneficial.¹⁹⁴ For this analysis, we observed two urban areas that, to some degree, experience ozone disbenefits: Southern California and Chicago.

Marginal changes in ozone in these areas are much more dependent upon baseline air quality conditions than PM due to nonlinearities present in the chemistry of ozone formation. A marginal decrease in NO_x emissions modeled on its own in these areas, as

¹⁹³ See the Regulatory Impact Analysis for the Proposed Ozone NAAQS (EPA-452/R-07-008, July 2007). This document is available at <http://www.epa.gov/ttn/ecas/ria.html#ria2007>.

¹⁹⁴ The NARSTO Assessment Document synthesizes the scientific understanding of ozone pollution, giving special consideration to behavior on expanded scales over the North American continent, encompassing Canada, the United States, and Mexico. Successive drafts of this Assessment Document experienced progressive stages of review by its authors and by outside peers, and transcripts were recorded containing the review comments and the corresponding actions. This included an external review by the NRC, the comments of which were addressed and incorporated in the final draft. NARSTO, 2000. An Assessment of Tropospheric Ozone Pollution—A North American Perspective. NARSTO Management Office (Envair), Pasco, Washington. <http://narsto.org/>

was done for this analysis, may yield a very different ambient ozone concentration than if it were modeled in combination with other planned or future controls. For example, recent California SIP modeling indicates that with a combined program of national and local controls, California can reach ozone attainment by 2024 through a mixture of substantial NO_x (and VOC) reductions.¹⁹⁵ In areas prone to ozone disbenefits, our ability to draw conclusions based on air quality modeling conducted for the final rule is limited because the yet-to-occur emission reductions in these areas are not accounted for in our analytical approach. Within these regions, it is expected that the additional NO_x reductions from SIP-based controls would lead to fewer ozone disbenefits from the marginal changes modeled here. More detailed information about the air quality modeling conducted for

this analysis is included in the air quality modeling technical support document (TSD), which is located in the docket for this rule.

The modeled ambient air quality data serves as an input to the Environmental Benefits Mapping and Analysis Program (BenMAP).¹⁹⁶ BenMAP is a computer program developed by EPA that integrates a number of the modeling elements used in previous Regulatory Impact Analyses (e.g., interpolation functions, population projections, health impact functions, valuation functions, analysis and pooling methods) to translate modeled air concentration estimates into health effects incidence estimates and monetized benefits estimates.

The addition of ozone mortality to our health impacts analysis has led to an increased focus on the issue of ozone disbenefits for two related reasons: (1) The monetized value of ozone-related benefits, in terms of ozone's

contribution to total rule-related benefits, has increased due to the inclusion of ozone mortality; and (2) The overall ozone impacts of NO_x reductions in certain geographic regions of the U.S., when modeled on the margin, may be negative.

Figure 1 shows the diurnal pattern of ozone concentrations in the 2030 baseline and post-control scenarios for a grid cell in Orange County, CA during July. From this figure it is clear that the disbenefits (points when the control case ozone levels are higher than the baseline) are occurring primarily during nighttime hours when ozone is generally low.

This diurnal pattern means that the extent of the disbenefits is not as large as one might have thought. Our conversion from using a 24-hour metric to using the maximum 8-hour average metric in the ozone mortality studies (see page 6–4 and the health impacts section) excludes the nighttime hours when NO_x-related disbenefits are most likely to occur.

BILLING CODE 6560-50-P

¹⁹⁵ SCAQMD (2007). Final 2007 Air Quality Management Plan. Available at: <http://www.aqmd.gov/aqmp/07aqmp/index.html>. Accessed November 8, 2007.

¹⁹⁶ Information on BenMAP, including downloads of the software, can be found at <http://www.epa.gov/air/benmap>.

Figure 2: July 2030 time-series of CMAQ base and control modeling for Orange County, CA

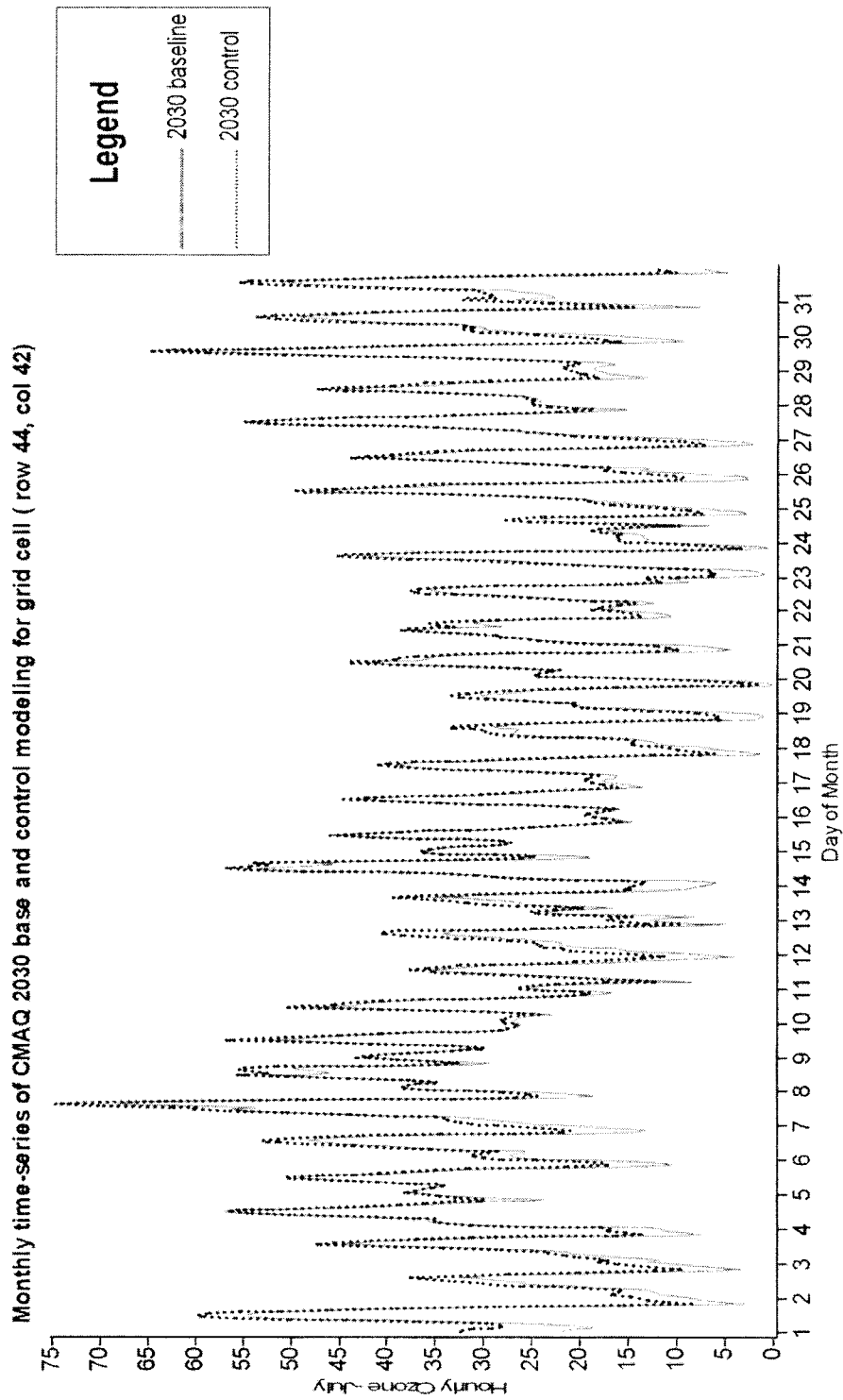

Table VI-2 presents the estimates of ozone- and PM-related health impacts for the years 2020 and 2030, which are based on the modeled air quality changes between a baseline, pre-control scenario and a post-control scenario reflecting the final emission control strategy.

The use of two sources of PM mortality reflects two different sources of information about the impact of reductions in PM on reduction in the risk of premature death, including both the published epidemiology literature and an expert elicitation study conducted by EPA in 2006. In 2030, based on the estimate provided by the ACS study, we estimate that PM-related emission reductions related to the final rule will result in 1,100 fewer premature fatalities annually. The number of

premature mortalities avoided increases to 2,600 when based on the Six Cities study. When the range of expert opinion is used, we estimate between 500 and 4,900 fewer premature mortalities in 2030. We also estimate 680 fewer cases of chronic bronchitis, 2,500 fewer non-fatal heart attacks, 870 fewer hospitalizations (for respiratory and cardiovascular disease combined), 720,000 fewer days of restricted activity due to respiratory illness and approximately 120,000 fewer work-loss days. This analysis projects substantial health improvements for children from reduced upper and lower respiratory illness, acute bronchitis, and asthma attacks. These results are based on an assumed cutpoint in the long-term mortality concentration-response functions at 10 µg/m³, and an assumed

cutpoint in the short-term morbidity concentration-response functions at 10 µg/m³. The impact using four alternative cutpoints (3 µg/m³, 7.5 µg/m³, 12 µg/m³, and 14 µg/m³) has on PM_{2.5}-related mortality incidence estimation is presented in Chapter 6 of the RIA.

For ozone, we estimate a range of between 54–250 fewer premature mortalities as a result of the final rule in 2030, assuming that there is a causal relationship between ozone exposure and mortality. We also estimate that by 2030, the final rule will result in over 500 avoided respiratory hospital admissions and emergency room visits, 290,000 fewer days of restricted activity due to respiratory illness, and 110,000 school loss days avoided.

TABLE VI-2.—ESTIMATED REDUCTION IN INCIDENCE OF ADVERSE HEALTH EFFECTS RELATED TO THE FINAL LOCOMOTIVE AND MARINE ENGINE STANDARDS^a

		2020	2030
Health Effect		Mean Incidence Reduction (5th–95th percentile)	
PM-Related Endpoints			
Premature Mortality—Derived from Epidemiology Literature.	Adult, age 30+—ACS cohort study (Pope et al., 2002).	490 (190–790)	1,100 (440–1,800)
	Adult, age 25+—Six-Cities study (Laden et al., 2006).	1,100 (610–1,600)	2,600 (1,400–3,700)
	Infant, age <1 year—Woodruff et al. 1997.	1 (1–2)	2 (1–3)
Premature Mortality—Derived from Expert Elicitation ^b .	Adult, age 25+—Lower Bound (Expert K).	220 (0–1,100)	500 (0–2,400)
	Adult, age 25+—Upper Bound (Expert E).	2,200 (1,100–3,300)	4,900 (2,500–7,500)
Chronic bronchitis (adult, age 26 and over)		310 (56–560)	680 (130–1,200)
Acute myocardial infarction (adults, age 18 and older)		1,000 (550–1,500)	2,500 (1,300–3,600)
Hospital admissions—respiratory (all ages) ^c		120 (58–170)	270 (130–400)
Hospital admissions—cardiovascular (adults, age >18) ^d		240 (150–330)	600 (380–820)
Emergency room visits for asthma (age 18 years and younger)		410 (240–580)	890 (520–1,300)
Acute bronchitis (children, age 8–12)		1,000 (–35–2,100)	2,300 (–77–4,600)
Lower respiratory symptoms (children, age 7–14)		9,200 (4,400–14,000)	20,000 (9,700–31,000)
Upper respiratory symptoms (asthmatic children, age 9–18)		6,700 (2,100–11,000)	15,000 (4,600–25,000)
Asthma exacerbation (asthmatic children, age 6–18)		8,400 (920–24,000)	19,000 (2,000–53,000)
Work loss days (adults, age 18–65)		59,000 (51,000–67,000)	120,000 (110,000–140,000)
Minor restricted-activity days (adults, age 18–65)		350,000 (290,000–400,000)	720,000 (610,000–830,000)
Ozone-Related Endpoints			
Premature Mortality, All ages—Derived from NMMAPS.	Bell et al., 2004	13 (–22–49)	54 (–43–150)
Premature Mortality, All ages—Derived from Meta-analyses.	Bell et al., 2005	44 (–47–140)	180 (–69–420)
	Ito et al., 2005	60 (–34–150)	240 (–14–500)
	Levy et al., 2005	62 (–14–140)	250 (44–450)
Premature Mortality—Assumption that association between ozone and mortality is not causal.		0	0
Hospital admissions—respiratory causes (children, under 2; adult, 65 and older) ^e .		14 (–150–170)	260 (–350–890)
Emergency room visit for asthma (all ages)		69 (–89–270)	250 (–190–830)
Minor restricted activity days (adults, age 18–65)		84,000 (43,000–120,000)	290,000 (150,000–430,000)
School absence days		33,000 (–17,000–77,000)	110,000 (–15,000–240,000)

Notes:

- (a) Incidence is rounded to two significant digits. PM and ozone estimates represent impacts from the final standards nationwide.
- (b) Based on effect estimates derived from the full-scale expert elicitation assessing the uncertainty in the concentration-response function for PM-related premature mortality (IEc, 2006).¹⁹⁷
The effect estimates of five of the twelve experts included in the elicitation panel fall within the empirically-derived range provided by the ACS and Six-Cities studies. One of the experts fall below this range and six of the experts are above this range. Although the overall range across experts is summarized in this table, the full uncertainty in the estimates is reflected by the results for the full set of 12 experts. The twelve experts' judgments as to the likely mean effect estimate are not evenly distributed across the range illustrated by arraying the highest and lowest expert means.
- (c) Respiratory hospital admissions for PM include admissions for chronic obstructive pulmonary disease (COPD), pneumonia, and asthma.
- (d) Cardiovascular hospital admissions for PM include total cardiovascular and subcategories for ischemic heart disease, dysrhythmias, and heart failure.
- (e) Respiratory hospital admissions for ozone include admissions for all respiratory causes and subcategories for COPD and pneumonia.

(2) Monetized Benefits

Table VI-3 presents the estimated monetary value of reductions in the incidence of health and welfare effects. Tables VI-4 and VI-5 present the total annual PM- and ozone-related health benefits, which are estimated to be between \$9.2 and \$11 billion in 2030, assuming a 3 percent discount rate, or between \$8.4 and \$10 billion, assuming a 7 percent discount rate, using the ACS-derived estimate of PM-related premature mortality (Pope et al., 2002) and the range of ozone-related premature mortality studies derived from the epidemiological literature. The range of benefits expands to between \$4.7 and \$39 billion, assuming a 3 percent discount rate, when the estimate includes the opinions of outside experts on PM and the risk of premature death, or between \$4.4 and \$35 billion, assuming a 7 percent discount rate. All monetized estimates are stated in 2006\$.

These estimates account for growth in real gross domestic product (GDP) per capita between the present and the years 2020 and 2030. As the tables indicate, total benefits are driven primarily by the reduction in premature fatalities each year.

The above estimates of monetized benefits include only one example of non-health related benefits. Changes in the ambient level of PM_{2.5} are known to affect the level of visibility in much of the U.S. Individuals value visibility both in the places they live and work, in the places they travel to for recreational purposes, and at sites of unique public value, such as at National Parks. For the final standards, we present the recreational visibility benefits of improvements in visibility at 86 Class I areas located throughout California, the Southwest, and the Southeast. These estimated benefits are approximately \$170 million in 2020 and

\$400 million in 2030, as shown in Table VI-3.

Table VI-3, VI-4 and VI-5 do not include those additional health and environmental benefits of the rule that we were unable to quantify or monetize. These effects are additive to the estimate of total benefits, and are related to two primary sources. First, there are many human health and welfare effects associated with PM, ozone, and toxic air pollutant reductions that remain unquantified because of current limitations in the methods or available data. A full appreciation of the overall economic consequences of the final standards requires consideration of all benefits and costs projected to result from the new standards, not just those benefits and costs which could be expressed here in dollar terms. A list of the benefit categories that could not be quantified or monetized in our benefit estimates are provided in Table VI-6.

TABLE VI-3.—ESTIMATED MONETARY VALUE IN REDUCTIONS IN INCIDENCE OF HEALTH AND WELFARE EFFECTS
[In millions of 2006\$] a, b

		2020	2030
PM _{2.5} -Related Health Effect		Estimated Mean Value of Reductions (5th and 95th percentile)	
Premature Mortality—Derived from Epidemiology Studies c, d.	Adult, age 30+—ACS study (Pope et al., 2002)		
	3% discount rate	\$3,400 (\$810–\$7,000)	\$8,100 (\$1,900–\$16,000)
	7% discount rate	\$3,100 (\$730–\$6,300)	\$7,300 (\$1,700–\$15,000)
	Adult, age 25+—Six-cities study (Laden et al., 2006)		
	3% discount rate	\$7,800 (\$2,200–\$15,000)	\$18,000 (\$5,100–\$35,000)
	7% discount rate	\$7,000 (\$1,900–\$13,000)	\$17,000 (\$4,600–\$32,000)
Premature mortality—Derived from Expert Elicitation c, d, e.	Infant Mortality, <1 year—(Woodruff et al. 1997)		
	3% discount rate	\$7 (\$2–\$14)	\$13 (\$3.5–\$26)
	7% discount rate	\$7 (\$2–\$13)	\$12 (\$3.1–\$23)
	Adult, age 25+—Lower bound (Expert K)		
3% discount rate	\$1,500 (\$0–\$7,700)	\$3,600 (\$0–\$18,000)	
7% discount rate	\$1,400 (\$0–\$7,000)	\$3,200 (\$0–\$16,000)	
Adult, age 25+—Upper bound (Expert E)	3% discount rate	\$15,000 (\$4,100–\$30,000)	\$36,000 (\$9,500–\$70,000)
	7% discount rate	\$14,000 (\$3,700–\$27,000)	\$32,000 (\$8,600–\$63,000)
Chronic bronchitis (adults, 26 and over)		\$150 (\$12–\$500)	\$340 (\$28–\$1,100)

¹⁹⁷ Industrial Economics, Incorporated (IEc). 2006. Expanded Expert Judgment Assessment of the Concentration-Response Relationship Between

PM_{2.5} Exposure and Mortality. Peer Review Draft. Prepared for: Office of Air Quality Planning and

Standards, U.S. Environmental Protection Agency, Research Triangle Park, NC. August.

TABLE VI-3.—ESTIMATED MONETARY VALUE IN REDUCTIONS IN INCIDENCE OF HEALTH AND WELFARE EFFECTS—Continued
[In millions of 2006\$]^{a, b}

		2020	2030
Non-fatal acute myocardial infarctions:			
	3% discount rate	\$110 (\$34–\$230)	\$260 (\$74–\$550)
	7% discount rate	\$110 (\$31–\$230)	\$250 (\$69–\$540)
	Hospital admissions for respiratory causes	\$2.1 (\$1.0–\$3.2)	\$4.9 (\$2.4–\$7.3)
	Hospital admissions for cardiovascular causes	\$6.7 (\$4.2–\$9.2)	\$17 (\$11–\$23)
	Emergency room visits for asthma	\$0.15 (\$0.08–\$0.23)	\$0.33 (\$0.18–\$0.49)
	Acute bronchitis (children, age 8–12)	\$0.08 (\$0–\$0.2)	\$0.17 (\$0–\$0.42)
	Lower respiratory symptoms (children, 7–14)	\$0.18 (\$0.07–\$0.33)	\$0.40 (\$0.15–\$0.73)
	Upper respiratory symptoms (asthma, 9–11)	\$0.21 (\$0.06–\$0.46)	\$0.46 (\$0.13–\$1.0)
	Asthma exacerbations	\$0.45 (\$0.05–\$1.3)	\$1.0 (\$0.11–\$2.9)
	Work loss days	\$8.9 (\$7.7–\$10)	\$18 (\$16–\$21)
	Minor restricted-activity days (MRADs)	\$22 (\$13–\$32)	\$46 (\$27–\$66)
	Recreational Visibility, 86 Class I areas	\$170 (na) ^f	\$400 (na)
Ozone-related Health Effect			
Premature Mortality, All ages—Derived from NMMAPS.	Bell et al., 2004	\$100 (–\$170–\$420)	\$440 (–\$340–\$1,400)
Premature Mortality, All ages—Derived from Meta-analyses.	Bell et al., 2005	\$340 (–\$360–\$1,200)	\$1,400 (–\$550–\$3,900)
	Ito et al., 2005	\$460 (–\$260–\$1,400)	\$1,900 (–\$120–\$4,700)
	Levy et al., 2005	\$480 (–\$110–\$1,300)	\$2,000 (\$280–\$4,400)
Premature Mortality—Assumption that association between ozone and mortality is not causal.		\$0	\$0
Hospital admissions—Respiratory causes (children, under 2; adult, 65 and older).		–\$0.54 (–\$4.6–\$3.3)	\$2.7 (–\$11–\$17)
Emergency room visit for asthma (all ages)		\$0.03 (–\$0.03–\$0.1)	\$0.09 (–\$0.07–\$0.30)
Minor restricted activity days (adults, age 18–65)		\$2.5 (–\$4.0–\$9.9)	\$8.8 (–\$7.8–\$28)
School absence days		\$2.9 (–\$1.5–\$6.8)	\$11 (–\$1.3–\$21)
Worker Productivity		\$0.53 (na) ^f	\$2.9 (na) ^f

Notes:

- (a) Monetary benefits are rounded to two significant digits for ease of presentation and computation. PM and ozone benefits are nationwide.
- (b) Monetary benefits adjusted to account for growth in real GDP per capita between 1990 and the analysis year (2020 or 2030)
- (c) Valuation assumes discounting over the SAB recommended 20 year segmented lag structure. Results reflect the use of 3 percent and 7 percent discount rates consistent with EPA and OMB guidelines for preparing economic analyses (EPA, 2000; OMB, 2003).
- (d) The valuation of adult premature mortality, derived either from the epidemiology literature or the expert elicitation, is not additive. Rather, the valuations represent a range of possible mortality benefits.
- (e) Based on effect estimates derived from the full-scale expert elicitation assessing the uncertainty in the concentration-response function for PM-related premature mortality (IEc, 2006).¹⁹⁸ The effect estimates of five of the twelve experts included in the elicitation panel fall within the empirically-derived range provided by the ACS and Six-Cities studies. One of the experts fall below this range and six of the experts are above this range. Although the overall range across experts is summarized in this table, the full uncertainty in the estimates is reflected by the results for the full set of 12 experts. The twelve experts' judgments as to the likely mean effect estimate are not evenly distributed across the range illustrated by arraying the highest and lowest expert means.
- (f) We are unable at this time to characterize the uncertainty in the estimate of benefits of worker productivity and improvements in visibility at Class I areas. As such, we treat these benefits as fixed and add them to all percentiles of the health benefits distribution.

TABLE VI-4.—TOTAL MONETIZED BENEFITS OF THE FINAL LOCOMOTIVE AND MARINE ENGINE RULE—3% DISCOUNT RATE

2020			2030		
Ozone mortality function	Reference	Mean total benefits	Ozone mortality function	Reference	Mean total benefits
Total Ozone and PM Benefits (Billions, 2006\$)—PM Mortality Derived From the ACS Study					
NMMAPS	Bell et al., 2004	\$4.0	NMMAPS	Bell et al., 2004	\$9.7
Meta-analysis	Bell et al., 2005	\$4.2	Meta-analysis	Bell et al., 2005	\$11
	Ito et al., 2005	\$4.4		Ito et al., 2005	\$11
	Levy et al., 2005	\$4.4		Levy et al., 2005	\$11

¹⁹⁸ Industrial Economics, Incorporated (IEC). 2006. Expanded Expert Judgment Assessment of the Concentration-Response Relationship between

PM_{2.5} Exposure and Mortality. Peer Review Draft. Prepared for: Office of Air Quality Planning and

Standards, U.S. Environmental Protection Agency, Research Triangle Park, NC. August.

TABLE VI-4.—TOTAL MONETIZED BENEFITS OF THE FINAL LOCOMOTIVE AND MARINE ENGINE RULE—3% DISCOUNT RATE—Continued

2020			2030		
Ozone mortality function	Reference	Mean total benefits	Ozone mortality function	Reference	Mean total benefits
Assumption that association is not causal		\$3.9	Assumption that association is not causal		\$9.2
Total Ozone and PM Benefits (Billions, 2006\$)—PM Mortality Derived From Expert Elicitation (Lowest and Highest Estimate)					
NMMAPS	Bell et al., 2004	\$2.1 to \$16	NMMAPS	Bell et al., 2004	\$5.2 to \$37
Meta-analysis	Bell et al., 2005	\$2.4 to \$16	Meta-analysis	Bell et al., 2005	\$6.2 to \$38
	Ito et al., 2005	\$2.5 to \$16		Ito et al., 2005	\$6.7 to \$39
	Levy et al., 2005	\$2.5 to \$16		Levy et al., 2005	\$6.7 to \$39
Assumption that association is not causal		\$2.0 to \$16	Assumption that association is not causal		\$4.7 to \$37

TABLE VI-5.—TOTAL MONETIZED BENEFITS OF THE FINAL LOCOMOTIVE AND MARINE ENGINE RULE—7% DISCOUNT RATE

Total Ozone and PM Benefits (Billions, 2006\$)—PM Mortality Derived From Epidemiology Studies (ACS and Six Cities)					
2020			2030		
Ozone mortality function	Reference	Mean total benefits	Ozone mortality function	Reference	Mean total benefits
NMMAPS	Bell et al., 2004	\$3.7	NMMAPS	Bell et al., 2004	\$8.9
Meta-analysis	Bell et al., 2005	\$3.9	Meta-analysis	Bell et al., 2005	\$9.8
	Ito et al., 2005	\$4.0		Ito et al., 2005	\$10
	Levy et al., 2005	\$4.0		Levy et al., 2005	\$10
Assumption that association is not causal		\$3.6	Assumption that association is not causal		\$8.4
Total Ozone and PM Benefits (Billions, 2006\$)—PM Mortality Derived From Expert Elicitation (Lowest and Highest Estimate)					
2020			2030		
Ozone mortality function	Reference	Mean total benefits	Ozone mortality function	Reference	Mean total benefits
NMMAPS	Bell et al., 2004	\$2.0 to \$14	NMMAPS	Bell et al., 2004	\$4.8 to \$34
Meta-analysis	Bell et al., 2005	\$2.2 to \$15	Meta-analysis	Bell et al., 2005	\$5.8 to \$35
	Ito et al., 2005	\$2.3 to \$15		Ito et al., 2005	\$6.3 to \$35
	Levy et al., 2005	\$2.3 to \$15		Levy et al., 2005	\$6.4 to \$35
Assumption that association is not causal		\$1.9 to \$14	Assumption that association is not causal		\$4.4 to \$33

TABLE VI-6.—UNQUANTIFIED AND NON-MONETIZED POTENTIAL EFFECTS OF THE FINAL LOCOMOTIVE AND MARINE ENGINE STANDARDS

Pollutant/Effects	Effects Not Included in Analysis—Changes in:
Ozone Health ^a	Chronic respiratory damage ^b Premature aging of the lungs ^b Non-asthma respiratory emergency room visits
Ozone Welfare	Exposure to UVb (+/-) ^e Yields for —commercial forests —some fruits and vegetables —non-commercial crops Damage to urban ornamental plants Impacts on recreational demand from damaged forest aesthetics Ecosystem functions
PM Health ^c	Exposure to UVb (+/-) ^e Premature mortality—short term exposures ^d Low birth weight Pulmonary function Chronic respiratory diseases other than chronic bronchitis Non-asthma respiratory emergency room visits
PM Welfare	Exposure to UVb (+/-) ^e Residential and recreational visibility in non-Class I areas Soiling and materials damage Damage to ecosystem functions

TABLE VI-6.—UNQUANTIFIED AND NON-MONETIZED POTENTIAL EFFECTS OF THE FINAL LOCOMOTIVE AND MARINE ENGINE STANDARDS—Continued

Pollutant/Effects	Effects Not Included in Analysis—Changes in:
Nitrogen and Sulfate Deposition Welfare	Exposure to UVb (+/-) ^e Commercial forests due to acidic sulfate and nitrate deposition Commercial freshwater fishing due to acidic deposition Recreation in terrestrial ecosystems due to acidic deposition Existence values for currently healthy ecosystems Commercial fishing, agriculture, and forests due to nitrogen deposition Recreation in estuarine ecosystems due to nitrogen deposition Ecosystem functions Passive fertilization
CO Health	Behavioral effects
HC/Toxics Health ^f	Cancer (benzene, 1,3-butadiene, formaldehyde, acetaldehyde) Anemia (benzene) Disruption of production of blood components (benzene) Reduction in the number of blood platelets (benzene) Excessive bone marrow formation (benzene) Depression of lymphocyte counts (benzene) Reproductive and developmental effects (1,3-butadiene) Irritation of eyes and mucus membranes (formaldehyde) Respiratory irritation (formaldehyde) Asthma attacks in asthmatics (formaldehyde) Asthma-like symptoms in non-asthmatics (formaldehyde) Irritation of the eyes, skin, and respiratory tract (acetaldehyde) Upper respiratory tract irritation and congestion (acrolein)
HC/Toxics Welfare	Direct toxic effects to animals Bioaccumulation in the food chain Damage to ecosystem function Odor

Notes:

(a) The public health impact of biological responses such as increased airway responsiveness to stimuli, inflammation in the lung, acute inflammation and respiratory cell damage, and increased susceptibility to respiratory infection are likely partially represented by our quantified endpoints.

(b) The public health impact of effects such as chronic respiratory damage and premature aging of the lungs may be partially represented by quantified endpoints such as hospital admissions or premature mortality, but a number of other related health impacts, such as doctor visits and decreased athletic performance, remain unquantified.

(c) In addition to primary economic endpoints, there are a number of biological responses that have been associated with PM health effects including morphological changes and altered host defense mechanisms. The public health impact of these biological responses may be partly represented by our quantified endpoints.

(d) While some of the effects of short-term exposures are likely to be captured in the estimates, there may be premature mortality due to short-term exposure to PM not captured in the cohort studies used in this analysis. However, the PM mortality results derived from the expert elicitation do take into account premature mortality effects of short term exposures.

(e) May result in benefits or disbenefits.

(f) Many of the key hydrocarbons related to this rule are also hazardous air pollutants listed in the Clean Air Act.

(3) What Are the Significant Limitations of the Benefit-Cost Analysis?

Every benefit-cost analysis examining the potential effects of a change in environmental protection requirements is limited to some extent by data gaps, limitations in model capabilities (such as geographic coverage), and uncertainties in the underlying scientific and economic studies used to configure the benefit and cost models. Limitations of the scientific literature often result in the inability to estimate quantitative changes in health and environmental effects, such as potential increases in premature mortality associated with increased exposure to carbon monoxide. Deficiencies in the economics literature often result in the inability to assign economic values even to those health and environmental outcomes which can be quantified. These general uncertainties in the underlying scientific and economics

literature, which can lead to valuations that are higher or lower, are discussed in detail in the RIA and its supporting references. Key uncertainties that have a bearing on the results of the benefit-cost analysis of the final standards include the following:

- The exclusion of potentially significant and unquantified benefit categories (such as health, odor, and ecological benefits of reduction in air toxics, ozone, and PM);
- Errors in measurement and projection for variables such as population growth;
- Uncertainties in the estimation of future year emissions inventories and air quality;
- Uncertainty in the estimated relationships of health and welfare effects to changes in pollutant concentrations including the shape of the C-R function, the size of the effect estimates, and the relative toxicity of the many components of the PM mixture;

- Uncertainties in exposure estimation; and
- Uncertainties associated with the effect of potential future actions to limit emissions.

As Table VI-3 indicates, total benefits are driven primarily by the reduction in premature mortalities each year. Some key assumptions underlying the premature mortality estimates include the following, which may also contribute to uncertainty:

- Inhalation of fine particles is causally associated with premature death at concentrations near those experienced by most Americans on a daily basis. Although biological mechanisms for this effect have not yet been completely established, the weight of the available epidemiological, toxicological, and experimental evidence supports an assumption of causality. The impacts of including a probabilistic representation of causality were explored in the expert elicitation-

based results of the recently published PM NAAQS RIA. Consistent with that analysis, we discuss the implications of these results in the RIA for the final standards.

- All fine particles, regardless of their chemical composition, are equally potent in causing premature mortality. This is an important assumption, because PM produced via transported precursors emitted from locomotive and marine engines may differ significantly from PM precursors released from electric generating units and other industrial sources. However, no clear scientific grounds exist for supporting differential effects estimates by particle type.

- The C-R function for fine particles is approximately linear within the range of ambient concentrations under consideration (above the assumed threshold of 10 µg/m³). Thus, the estimates include health benefits from reducing fine particles in areas with varied concentrations of PM, including both regions that may be in attainment with PM_{2.5} standards and those that are at risk of not meeting the standards.

- There is considerable uncertainty in the magnitude of the association between ozone and premature mortality. The range of ozone benefits associated with the final standards is estimated based on the risk of several sources of ozone-related mortality effect estimates. Recognizing that additional research is necessary to clarify the underlying mechanisms causing these effects, we also consider the possibility that the

observed associations between ozone and mortality may not be causal in nature. EPA has requested advice from the National Academy of Sciences on how best to quantify uncertainty in the relationship between ozone exposure and premature mortality in the context of quantifying benefits.

Despite these uncertainties, we believe this benefit-cost analysis provides a conservative estimate of the estimated economic benefits of the final standards in future years because of the exclusion of potentially significant benefit categories. Acknowledging benefits omissions and uncertainties, we present a best estimate of the total benefits based on our interpretation of the best available scientific literature and methods supported by EPA's technical peer review panel, the Science Advisory Board's Health Effects Subcommittee (SAB-HES). The National Academies of Science (NRC, 2002) also reviewed EPA's methodology for analyzing the health benefits of measures taken to reduce air pollution. EPA addressed many of these comments in the analysis of the final PM NAAQS.^{199, 200} The analysis of the final standards incorporates this most recent work to the extent possible.

(4) Benefit-Cost Analysis

In estimating the net benefits of the final standards, the appropriate cost measure is "social costs." Social costs represent the welfare costs of a rule to society. These costs do not consider transfer payments (such as taxes) that

are simply redistributions of wealth. Table VI-7 contains the estimates of monetized benefits and estimated social welfare costs for the final rule and each of the final control programs. The annual social welfare costs of all provisions of this final rule are described more fully in Section VII of this preamble.

The results in Table VI-7 suggest that the 2020 monetized benefits of the final standards are greater than the expected social welfare costs. Specifically, the annual benefits of the total program will range between \$3.9 to \$8.8 billion annually in 2020 using a three percent discount rate, or between \$3.6 to \$8.0 billion assuming a 7 percent discount rate, compared to estimated social costs of approximately \$330 million in that same year. These benefits are expected to increase to between \$9.2 and \$22 billion annually in 2030 using a three percent discount rate, or between \$8.4 and \$20 billion assuming a 7 percent discount rate, while the social costs are estimated to be approximately \$740 million. Though there are a number of health and environmental effects associated with the final standards that we are unable to quantify or monetize (see Table VI-6), the benefits of the final standards far outweigh the projected costs. When we examine the benefit-to-cost comparison for the rule standards separately, we also find that the benefits of the specific engine standards far outweigh their projected costs.

TABLE VI-7.—SUMMARY OF ANNUAL BENEFITS, COSTS, AND NET BENEFITS OF THE FINAL LOCOMOTIVE AND MARINE ENGINE STANDARDS (MILLIONS, 2006\$)^a

Description	2020 (Millions of 2006 dollars)	2030 (Millions of 2006 dollars)
Estimated Social Costs: ^b		
Locomotive:		
Marine:	\$200	\$460.
Marine:	\$140	\$280.
Total Social Costs	\$330	\$740.
Estimated Health Benefits of the Final Standards: ^{c, d, e, f}		
Locomotive:		
3 percent discount rate	\$2,000 to \$4,400 ...	\$4,300 to \$11,000.
7 percent discount rate	\$1,900 to \$4,000 ...	\$4,000 to \$10,000.
Marine:		
3 percent discount rate	\$1,900 to \$4,400 ...	\$4,900 to \$11,000.
7 percent discount rate	\$1,700 to \$4,000 ...	\$4,400 to \$10,000.
Total Benefits:		
3 percent discount rate	\$3,900 to \$8,800 ...	\$9,200 to \$22,000.
7 percent discount rate	\$3,600 to \$8,000 ...	\$8,400 to \$20,000.
Annual Net Benefits (Total Benefits – Total Costs):		
3 percent discount rate	\$3,600 to \$8,500 ...	\$8,500 to \$21,000.
7 percent discount rate	\$3,300 to \$7,700 ...	\$7,700 to \$19,000.

Notes:

^a All estimates represent annualized benefits and costs anticipated for the years 2020 and 2030. Totals may not sum due to rounding.

¹⁹⁹ National Research Council (NRC). 2002. Estimating the Public Health Benefits of Proposed Air Pollution Regulations. The National Academies Press: Washington, DC.

²⁰⁰ U.S. Environmental Protection Agency. October 2006. Final Regulatory Impact Analysis (RIA) for the Proposed National Ambient Air Quality Standards for Particulate Matter. Prepared

by: Office of Air and Radiation. Available at <http://www.epa.gov/ttn/ecas/ria.html>.

^b The calculation of annual costs does not require amortization of costs over time. Therefore, the estimates of annual cost do not include a discount rate or rate of return assumption (see Chapter 7 of the RIA). In Section V, however, we do use both a 3 percent and 7 percent social discount rate to calculate the net present value of total social costs consistent with EPA and OMB guidelines for preparing economic analyses.

^c Total includes ozone and PM_{2.5} benefits. Range was developed by adding the estimate from the ozone premature mortality function, including an assumption that the association is not causal, to both estimates of PM_{2.5}-related premature mortality derived from the ACS (Pope et al., 2002) and Six-Cities (Laden et al., 2006) studies, respectively.

^d Annual benefits analysis results reflect the use of a 3 percent and 7 percent discount rate in the valuation of premature mortality and nonfatal myocardial infarctions, consistent with EPA and OMB guidelines for preparing economic analyses (US EPA, 2000 and OMB, 2003).^{201, 202}

^e Valuation of premature mortality based on long-term PM exposure assumes discounting over the SAB recommended 20-year segmented lag structure described in the Regulatory Impact Analysis for the Final Clean Air Interstate Rule (March, 2005).

^f Not all possible benefits or disbenefits are quantified and monetized in this analysis. Potential benefit categories that have not been quantified and monetized are listed in Table VI–6.

VII. Alternative Program Options

The program we are finalizing today represents a broad and comprehensive approach to reducing emissions from locomotive and marine diesel engines. As we developed this final rule, we considered a number of alternatives with regard to the scope and timing of the standards. After carefully evaluating these alternatives, we believe that our new program provides the best opportunity for achieving timely and substantial emission reductions from locomotive and marine diesel engines. Our final program balances a number of key factors: (1) Achieving significant emissions reductions as early as possible, (2) providing appropriate lead time to develop and apply advanced control technologies, and (3) coordinating requirements in this final rule with existing highway and nonroad diesel engine programs. The alternative scenarios described here were constructed to further evaluate each individual aspect of our program, and have enabled us to achieve the appropriate balance between these key factors. This section presents a summary of our analysis of these alternative control scenarios. For a more detailed explanation of our analysis, including a year by year breakout of expected costs and emission reductions, please refer to Chapter 8 of the Regulatory Impact Analysis (RIA) prepared for this final rulemaking.

A. Summary of Alternatives

(1) Alternative 1: Proposed Program From the Notice of Proposed Rulemaking

Alternative 1 examines the differences between the program we proposed and the program we are finalizing in this rulemaking. The proposal consisted of a three-part program. First, it proposed more stringent standards for existing locomotives that would apply when they were remanufactured. These

standards would go into effect as soon as a certified remanufacture system became available. Second, we proposed a set of near-term emission standards, referred to as Tier 3, for freshly manufactured locomotives and marine engines that reflected the application of technologies to reduce engine-out PM and NO_x. Third, we proposed longer-term standards, referred to as Tier 4, that utilized high-efficiency catalytic aftertreatment technology enabled by the availability of ULSD. These standards would phase in over time, beginning in 2014. In addition, we proposed eliminating emissions from unnecessary locomotive idling.

The final rule makes a number of important changes to the program originally set out in the proposal which we believe will yield significantly greater overall NO_x and PM reductions, especially in the critical early years of the program. In particular, the adoption of standards for remanufactured marine engines and a 2-year pull-ahead of the Tier 4 NO_x requirements for line-haul locomotives and for 2000–3700 kW marine engines provide greater near-term reductions than the proposal. The final rule also expands the remanufactured locomotive program to include Class II railroads.

As a stand-alone program, through the year 2040 Alternative 1 provides PM_{2.5} reductions of 286,000 tons NPV 3%, or 121,000 tons NPV 7%, and NO_x reductions of 8,140,000 tons NPV 3%, or 3,320,000 tons NPV 7%. The cost of this alternative through 2040 is estimated to be \$8,760 million NPV 3%, or \$3,900 million NPV 7%. In 2020, this alternative provides monetized health and welfare benefits of \$3.3 billion at a 3% discount rate, or \$3.0 billion at a 7% discount rate, and \$8.8 billion in 2030 at a 3% discount rate, or \$8.0 billion at a 7% discount rate. Through 2040 our final program provides additional PM_{2.5} reductions of 22,000 tons NPV 3%, or 13,000 tons NPV 7%, and additional NO_x reductions of 620,000 tons NPV 3%, or 390,000 tons NPV 7%. Through 2040, the additional costs of our final program will be \$650 million NPV 3%, or \$410 million NPV 7%. The additional PM_{2.5} monetized health and welfare

benefits in 2020 of our final program are \$0.6 billion at a 3% discount rate, or \$0.6 billion at a 7% discount rate, while in 2030 the additional monetized health and welfare benefits total \$0.4 billion at a 3% discount rate, or \$0.4 billion at a 7% discount rate.

(2) Alternative 2: Exclusion of Remanufacturing Standards

Alternative 2 examines the potential impacts of the locomotive and marine remanufacturing programs by excluding them from the analysis (see sections III.B.(1)(a)(i), III.B.(1)(b), and III.B.(2)(b) of this Preamble for more details on the remanufacturing standards). As a stand-alone program, Alternative 2 provides PM_{2.5} reductions of 240,000 tons NPV 3%, or 96,000 tons NPV 7%, and NO_x reductions of 7,640,000 tons NPV 3%, or 3,030,000 tons NPV 7%, through the year 2040. The cost of this alternative through 2040 is estimated to be \$8,080 million NPV 3%, or \$3,430 million NPV 7%. In 2020, this alternative provides monetized health and welfare benefits of \$2.5 billion at a 3% discount rate, or \$2.3 billion at a 7% discount rate, and \$8.2 billion in 2030 at a 3% discount rate, or \$7.5 billion at a 7% discount rate. Compared to the final program, our analysis shows that by 2040 eliminating the locomotive and marine remanufacture programs lessen PM_{2.5} emission reductions by 68,000 tons NPV 3%, or 38,000 tons NPV 7%, and NO_x emission reductions by nearly 1,120,000 tons NPV 3%, or 680,000 tons NPV 7%. The cost of this alternative, as compared to our final program through 2040, is estimated to be \$1,330 million less NPV 3%, or \$880 million less NPV 7%. Compared to our final program, eliminating the locomotive and marine remanufacture programs reduce the monetized health and welfare benefits by \$1.4 billion at a 3% discount rate, or \$1.3 billion at a 7% discount rate in 2020, and \$1.0 billion at a 3% discount rate, or \$0.9 billion at a 7% discount rate in 2030.

(3) Alternative 3: Elimination of Tier 3

Alternative 3 eliminates the Tier 3 standards, while retaining the Tier 4 standards and the combined marine and

²⁰¹ U.S. Environmental Protection Agency, 2000. Guidelines for Preparing Economic Analyses. www.yosemite1.epa.gov/ee/epa/eed/hsf/pages/Guideline.html.

²⁰² Office of Management and Budget, The Executive Office of the President, 2003. Circular A–4. <http://www.whitehouse.gov/omb/circulars>.

locomotive remanufacturing requirements. As a stand-alone program, Alternative 3 provides PM_{2.5} reductions of 237,000 tons NPV 3%, or 100,000 tons NPV 7%, and NO_x reductions of 8,360,000 tons NPV 3%, or 3,530,000 tons NPV 7%, through the year 2040. The cost of this alternative through 2040 is estimated to be \$9,240 million NPV 3%, or \$4,160 million NPV 7%. In 2020, this alternative provides monetized health and welfare benefits of \$2.8 billion at a 3% discount rate, or \$2.6 billion at a 7% discount rate, and \$7.8 billion in 2030 at a 3% discount rate, or \$7.1 billion at a 7% discount rate. Comparing this alternative to our final program allows us to consider the value of the Tier 3 standards on their own merits. Specifically, this alternative would lessen PM_{2.5} emissions reductions by nearly 71,000 tons NPV 3%, or 34,000 tons NPV 7%, and NO_x emissions by 400,000 tons NPV 3%, or 180,000 tons NPV 7%. The cost of this alternative, as compared to our final program through 2040, is estimated to be \$170 million less at NPV 3%, or \$150 million less at NPV 7%. The monetized health and welfare benefits that would be forgone by eliminating Tier 3 are \$1.1 billion at a 3% discount rate, or \$1.0 billion at a 7% discount rate in 2020, and \$1.4 billion at a 3% discount rate, or \$1.3 billion at a 7% discount rate in 2030. Although the remanufacturing programs provide substantial benefits in the near-term, as evidenced by the analysis of Alternative 2, it is clear that Tier 3 also plays an important role in providing both near- and long-term emission reductions.

(4) Alternative 4: Tier 4 Exclusively in 2013
 Alternative 4 most closely reflects the program described in our Advanced Notice of Proposed Rulemaking, whereby we would set new aftertreatment based emission standards as soon as possible. In this case, we believe the earliest that such standards could logically be started is in 2013 (three months after the introduction of 15 ppm ULSD in this sector). Alternative 4 eliminates our Tier 3 standards along with the locomotive and marine remanufacturing standards, while pulling the Tier 4 standards ahead to 2013 for all portions of the Tier 4 program. We are unable to make an accurate estimate of the cost for such an approach since we do not believe it to be technically feasible at this time. However, we have reported a cost in the summary table reflecting the same cost estimation method we used for our primary case and have denoted unestimated additional costs as ‘C’. These additional unestimated costs would include costs for additional engine test cells, engineering staff, and engineering facilities necessary to introduce Tier 4 early. As a stand-alone program, Alternative 4 provides PM_{2.5} reductions of 249,000 tons NPV 3%, or 101,000 tons NPV 7%, and NO_x reductions of 8,320,000 tons NPV 3%, or 3,420,000 tons NPV 7% through the year 2040. In 2020, this alternative provides monetized health and welfare benefits of \$3.0 billion at a 3% discount rate, or \$2.8 billion at a 7% discount rate, and \$8.4 billion in 2030 at a 3% discount rate, or \$7.6 billion at a 7% discount rate. Through 2040, this alternative, as compared to our final program, would decrease PM_{2.5} reductions by more than 59,000 NPV

3% tons, or 33,000 tons NPV 7%, and NO_x emissions by 440,000 tons NPV 3%, or 290,000 tons NPV 7%. Compared to our final program, the reduction in monetized health and welfare benefits of this alternative would be \$0.9 billion at a 3% discount rate, or \$0.8 billion at a 7% discount rate in 2020, while in 2030 the reductions in monetized benefits would be \$0.8 billion at a 3% discount rate, or \$0.8 billion at a 7% discount rate.

B. Summary of Results

A summary of the four alternatives is contained in Table VII–1 and Table VII–2 below. The PM and NO_x emissions reductions from the alternatives described here compare favorably—in terms of cost effectiveness—to other mobile source control programs that have been or will soon be implemented. These alternatives show that each element of our comprehensive program: the locomotive and marine remanufacturing programs, the near-term Tier 3 emission standards, and the long-term Tier 4 emission standards, represent valuable emission control programs on their own. The collective program results in the greatest emission reductions we believe to be possible giving consideration to all of the elements described in this final rule. Overall, our final program will provide very large reductions in PM, NO_x, and toxic compounds in both the near-term and the long-term. These reductions will be achieved in a manner that: (1) Leverages technology developments in other diesel sectors, (2) aligns well with the clean diesel fuel requirements already being implemented, and (3) provides the lead time needed to deal with the significant engineering design workload that is involved.

TABLE VII–1.—SUMMARY OF INVENTORY AND COSTS AT NPV 3% AND 7%

Alternatives	Standards	Estimated PM _{2.5} reductions 2006–2040		Estimated NO _x reductions 2006–2040		Total costs ^a millions 2006–2040	
		NPV 3%	NPV 7%	NPV 3%	NPV 7%	NPV 3%	NPV 7%
Final Rule	<ul style="list-style-type: none"> • Locomotive Remanufacturing .. • Marine Remanufacturing, • Tier 3 Near-term program, • Tier 4 Long-term standards 	308,000	134,000	8,760,000	3,710,000	\$9,410	\$4,310
Alternative 1: Proposed Case (NPRM).	<ul style="list-style-type: none"> • Proposed Locomotive Remanufacturing program,. • Proposed Tier 3 Near-term program, • Proposed Tier 4 Long-term standards 	286,000	121,000	8,140,000	3,320,000	8,760	3,900
Alternative 2: Exclusion of Remanufacturing Standards.	<ul style="list-style-type: none"> • Tier 3 Near-term program, • Tier 4 Long-term standards 	240,000	96,000	7,640,000	3,030,000	8,080	3,430
Alternative 3: Elimination of Tier 3.	<ul style="list-style-type: none"> • Locomotive Remanufacturing, • Marine Remanufacturing, • Tier 4 Long-term standards 	237,000	10,000	8,360,000	3,530,000	9,240	4,160

TABLE VII-1.—SUMMARY OF INVENTORY AND COSTS AT NPV 3% AND 7%—Continued

Alternatives	Standards	Estimated PM _{2.5} reductions 2006–2040		Estimated NO _x reductions 2006–2040		Total costs ^a millions 2006–2040	
		NPV 3%	NPV 7%	NPV 3%	NPV 7%	NPV 3%	NPV 7%
Alternative 4: Tier 4 Exclusively in 2013.	• Tier 4 Long-term standards only in 2013.	249,000	101,000	8,320,000	3,420,000	9,070+C	3950+C

Note: ^a‘C’ represents the additional costs necessary to accelerate the introduction of Tier 4 technologies that we are unable to estimate at this time.

TABLE VII-2.—INVENTORY, COST, AND BENEFITS FOR 2020 AND 2030

	PM _{2.5} emissions reductions (tons)		NO _x emissions reductions (tons)		Total costs ^a (mil-lions)		Benefits ^{b,c} (billions) PM _{2.5} only 3% discount rate		Benefits ^{b,c} (bil-lions) PM _{2.5} only 7% discount rate	
	2020	2030	2020	2030	2020	2030	2020	2030	2020	2030
	Final Rule	14,000	27,000	370,000	790,000	\$350	\$760	\$3.9	\$9.2	\$3.6
Alternative 1: Proposed Case (NPRM)	13,000	26,000	310,000	780,000	300	750	3.3	8.8	3.0	8.0
Alternative 2: Exclusion of Re-manufacturing Standards	8,800	24,000	280,000	760,000	290	720	2.5	8.2	2.3	7.5
Alternative 3: Elimination of Tier 3	8,800	21,000	350,000	760,000	350	760	2.8	7.8	2.6	7.1
Alternative 4: Tier 4 Exclusively in 2013	10,000	24,000	350,000	790,000	360	780	3.0	8.4	2.8	7.6

Notes:

^a‘C’ represents the additional costs necessary to accelerate the introduction of Tier 4 technologies that we are unable to estimate at this time.

^bNote that the range of PM-related benefits reflects the use of an empirically-derived estimate of PM mortality benefits, based on the ACS cohort study (Pope et al., 2002).

^cAnnual benefits analysis results reflect the use of a 3 percent and 7 percent discount rate in the valuation of premature mortality and nonfatal myocardial infarctions, consistent with EPA and OMB guidelines for preparing economic analyses (US EPA, 2000 and OMB, 2003). U.S. Environmental Protection Agency, 2000. Guidelines for Preparing Economic Analyses. <http://yosemite.epa.gov/ee/epa/eed.nsf/webpages/Guidelines.html>.

VIII. Public Participation

Many interested parties participated in the rulemaking process that culminates with this final rule. This process provided opportunity for submitting written public comments following the proposal that we published on April 3, 2007 (72 FR 15938). We considered these comments in developing the final rule. In addition, we held public hearings on the proposed rulemaking on May 8 and 10, 2007, and we have considered comments presented at the hearings.

Throughout the rulemaking process, EPA met with stakeholders including representatives from industry, government, environmental organizations, and others. The program we are finalizing today was developed as a collaborative effort with these stakeholders.

We have prepared a detailed Summary and Analysis of Comments document, which describes comments we received on the proposal and our response to each of these comments. The Summary and Analysis of Comments is available in the docket for this rule at the Internet address listed under **ADDRESSES**, as well as on the Office of Transportation and Air Quality Web site (www.epa.gov/otaq/

[locomotv.htm](#) and www.epa.gov/otaq/marine.htm). In addition, comments and responses for key issues are included throughout this preamble.

IX. Statutory and Executive Order Reviews

A. Executive Order 12866: Regulatory Planning and Review

Under section 3(f)(1) of Executive Order (EO) 12866 (58 FR 51735, October 4, 1993), this action is an “economically significant regulatory action” because it is likely to have an annual effect on the economy of \$100 million or more. Accordingly, EPA submitted this action to the Office of Management and Budget (OMB) for review under EO 12866, and any changes made by EPA after submission to OMB have been documented in the docket for this action.

In addition, EPA prepared an analysis of the potential costs and benefits associated with this action. This analysis is contained in the final Regulatory Impact Analysis that was prepared for this rulemaking, and is available in the docket at the docket internet address listed under **ADDRESSES** above.

B. Paperwork Reduction Act

The information collection requirements in this final rule have been submitted for approval to the Office of Management and Budget (OMB) under the *Paperwork Reduction Act*, 44 U.S.C. 3501 *et seq.* EPA may not conduct the information collection requirements in this rule and may not penalize anyone for failing to comply with the information collection requirements in the rule unless they are currently approved by OMB.

EPA plans to collect information to ensure that locomotives and marine diesel engines conform to the regulations throughout their useful lives. Section 208(a) of the Clean Air Act requires that manufacturers provide information the Administrator may reasonably require to determine compliance with the regulations; submission of the information is therefore mandatory. We will consider confidential all information meeting the requirements of Section 208(c) of the Clean Air Act.

The annual public reporting and recordkeeping burden for this collection of information is estimated to be 287 hours per respondent for locomotives, and 149 hours per respondent for marine. The projected number of

respondents and annual reporting, recordkeeping, and cost burdens to respondents are as follows:

- Estimated total number of potential respondents: for locomotives—7; for marine—13.

- Estimated total annual burden hours: for locomotives—14,040 (2,010 per respondent); for marine—25,167 (1,940 per respondent).

- Estimated total annual costs: for locomotives—\$1.65 million (\$315,000 per respondent); for marine—\$1.45 million (\$112,000 per respondent).

Burden means the total time, effort, or financial resources expended by persons to generate, maintain, retain, or disclose or provide information to or for a Federal agency. This includes the time needed to review instructions; develop, acquire, install, and utilize technology and systems for the purposes of collecting, validating, and verifying information, processing and maintaining information, and disclosing and providing information; adjust the existing ways to comply with any

previously applicable instructions and requirements; train personnel to be able to respond to a collection of information; search data sources; complete and review the collection of information; and transmit or otherwise disclose the information.

An agency may not conduct or sponsor, and a person is not required to respond to a collection of information unless it displays a currently valid OMB control number. The OMB control numbers for EPA's regulations in 40 CFR are listed in 40 CFR part 9. When this ICR is approved by OMB, EPA will publish a technical amendment to 40 CFR part 9 in the **Federal Register** to display the OMB control number for the approved information collection requirements contained in this final rule.

C. Regulatory Flexibility Act

(1) Overview

The Regulatory Flexibility Act (RFA) generally requires an agency to prepare

a regulatory flexibility analysis of any rule subject to notice and comment rulemaking requirements under the Administrative Procedure Act or any other statute unless the agency certifies that the rule will not have a significant economic impact on a substantial number of small entities. Small entities include small businesses, small organizations, and small governmental jurisdictions.

For purposes of assessing the impacts of today's rule on small entities, small entity is defined as: (1) A small business as defined by the Small Business Administration's (SBA) regulations at 13 CFR 121.201 (see Table IX-1, below); (2) a small governmental jurisdiction that is a government of a city, county, town, school district or special district with a population of less than 50,000; and (3) a small organization that is any not-for-profit enterprise which is independently owned and operated and is not dominant in its field.

TABLE IX-1.—PRIMARY SBA SMALL BUSINESS CATEGORIES POTENTIALLY AFFECTED BY THIS REGULATION

Industry	NAICS ^a Codes	Defined by SBA as a small business if less than or equal to: ^b
Locomotive:		
Manufacturers, remanufacturers and importers of locomotives and locomotive engines	333618, 336510	1,000 employees.
Railroad owners and operators	482110, 482111	1,500 employees.
	482112	500 employees.
Engine repair and maintenance	488210	\$6.5 million annual sales.
Marine:		
Manufacturers of freshly manufactured marine diesel engines	333618	1,000 employees.
Ship and boat building; ship building and repairing	336611, 346611	1,000 employees.
Engine repair and maintenance	811310	\$6.5 million annual sales.
Water transportation, freight and passenger	483	500 employees.
Water transportation, freight and passenger—Offshore Marine Services	483	\$25.5 million annual sales.
Scenic and Sightseeing Transportation, Water	487210	\$6.5 million annual sales.
Navigational Services to Shipping	488330	\$6.5 million annual sales.
Commercial Fishing	114	\$4.0 million annual sales.
Boat building (watercraft not built in shipyards and typically of the type suitable or intended for personal use).	336612	500 employees.

Notes:

^a North American Industry Classification System

^b According to SBA's regulations (13 CFR 121), businesses with no more than the listed number of employees or dollars in annual receipts are considered "small entities" for RFA purposes.

After considering the economic impacts of today's final rule on small entities, I certify that this action will not have a significant economic impact on a substantial number of small entities. The small entities directly regulated by this final rule are shown in Table IX-1 (and are not small governmental jurisdictions or small non-profit organizations). We have determined that about five small entities representing less than one percent of the total number of companies affected will have an estimated impact exceeding three percent of their annual sales revenues.

The vast majority of small entities (about several thousand small companies) will have an estimated impact of less than one percent on their annual sales revenues. (An analysis of the impacts of the rule on small entities was performed for the rule, and can be found in the docket for this rulemaking.^{203, 204})

²⁰³ U.S. EPA, Assessment and Standards Division, *Locomotive and Marine Diesel RFA/SBREF A Screening Analysis*, Memorandum from Chester J. France to Alexander Cristofaro of U.S. EPA's Office of Policy, Economics, and Innovation, September 25, 2006.

Although this final rule will not have a significant economic impact on a substantial number of small entities, EPA nonetheless has tried to reduce the impact of this rule on small entities, as described below.

²⁰⁴ U.S. EPA, Assessment and Standards Division, *Supplement to Locomotive and Marine Diesel RFA/SBREF A Screening Analysis—Marine Existing Fleet Program Impact Analysis*, Memorandum from Lucie Audette and Bryan Manning to Docket EPA-HQ-OAR-2003-0190, December 12, 2007.

(2) Outreach Efforts and Special Compliance Provisions for Small Entities

In addition to the inputs we sought prior to issuing the proposed rule, we also received additional comments following its publication. First we summarize the pre-proposal outreach, followed by additional comments we received after the proposal was published.

Early on, we sought the input of a number of small entities affected by the rule on potential regulatory flexibility provisions and the needs of these small businesses. For marine diesel engine manufacturers, we had separate meetings with the four small companies in this sector, which are post-manufacture marinizers (companies that purchase a complete or semi-complete engine from an engine manufacturer and modify it for use in the marine environment by changing the engine in ways that may affect emissions). We also met individually with one small commercial vessel builder and a few vessel trade associations whose members include small vessel builders. For locomotive manufacturers and remanufacturers, we met separately with the three small businesses in these sectors, which are all remanufacturers. In addition, we met with a railroad trade association whose members include small railroads. For nearly all meetings, EPA provided each small business with an outreach packet that included background information on this proposed rulemaking; and a document outlining some flexibility provisions for small businesses that we have implemented in past rulemakings. (This outreach packet and a complete summary of our discussions with small entities can be found in the docket for this rulemaking.)²⁰⁵

The primary feedback we received from these small entities pre-proposal was to continue the flexibility provisions that we have provided to small entities in earlier locomotive and marine diesel rulemakings. A number of these provisions are listed below. Therefore, we will largely continue the existing flexibility provisions finalized in the 1998 Locomotive and Locomotive Engines Rule (April 16, 1998; 63 FR 18977); our 1999 Commercial Marine Diesel Engines Rule (December 29, 1999; 64 FR 73299) and our 2002 Recreational Diesel Marine program (November 8, 2002; 67 FR 68304).

In the proposed rule, we requested comment on an alternative program option—a marine existing fleet or remanufacture program (*Alternative 5: Existing Engines*)—and as described earlier in this preamble, we are finalizing a portion of this alternative. Based on oral testimony at the hearings and written comments (from trade associations, small entities, etc.), we are providing flexibilities to vessel operators and/or marine remanufacturers as described below. For a complete description of the flexibilities in this final rule, please refer to the Certification and Compliance Program, section IV.A.(13)—Small Business Provisions.

(a) Transition Flexibilities

(i) Locomotive Sector

Small locomotive remanufacturers are granted a waiver from production-line and in-use testing for up to five calendar years after this program becomes effective.

Class III railroads qualifying as small businesses are exempt from new Tier 0, 1, and 2 remanufacturing requirements for locomotives in their existing fleets. The Certification and Compliance Program section IV.A.(13) provides a discussion on the revisions being made in this program.

Railroads qualifying as small businesses continue being exempt from the in-use testing program.

(ii) Marine Sector

Post-manufacture marinizers and small-volume manufacturers (annual worldwide production of fewer than 1,000 engines) are allowed to group all engines into one engine family, based on the worst-case emitter.

Small-volume manufacturers producing engines less than or equal to 600 kW (800 hp) are exempted from production-line and deterioration testing (assigned deterioration factors) for Tier 3 standards.

Post-manufacture marinizers qualifying as small businesses and producing engines less than or equal to 600 kW (800 hp) may delay compliance with the Tier 3 standards by one model year.

Post-manufacture marinizers qualifying as small businesses and producing engines less than or equal to 600 kW (800 hp) may delay compliance with the Not-to-Exceed requirements for Tier 3 standards by up to three model years.

Marine engine dressers (modify base engine without affecting the emission characteristics of the engine) are exempted from certification and compliance requirements.

Post-manufacture marinizers, small-volume manufacturers, and small-volume boat builders (less than 500 employees and annual worldwide production of fewer than 100 boats) have hardship relief provisions—i.e., apply for additional time.

For the marine existing fleet or remanufacture program, vessel operators and marine remanufacturers qualifying as small businesses also have hardship relief provisions allowing them if necessary to apply for additional time to comply with program requirements.

Vessel operators who earn less than \$5 million in gross annual sales revenue are exempted from the marine existing fleet or remanufacture program. If at some future date annual gross revenues exceed \$5 million, they become subject to the existing fleet program at that point.

(b) Small Entity Compliance Information

In addition to the above flexibilities, EPA is also preparing documentation to help small entities comply with this rule. This documentation will be available on the Office of Transportation and Air Quality Web site. Small entities may also contact our office to obtain copies of this documentation.

D. Unfunded Mandates Reform Act

Title II of the Unfunded Mandates Reform Act of 1995 (UMRA), P.L. 104–4, establishes requirements for Federal agencies to assess the effects of their regulatory actions on State, local, and tribal governments and the private sector. Under section 202 of the UMRA, EPA generally must prepare a written statement, including a cost-benefit analysis, for proposed and final rules with “Federal mandates” that may result in expenditures to State, local, and tribal governments, in the aggregate, or to the private sector, of \$100 million or more in any one year. Before promulgating an EPA rule for which a written statement is needed, section 205 of the UMRA generally requires EPA to identify and consider a reasonable number of regulatory alternatives and adopt the least costly, most cost-effective or least burdensome alternative that achieves the objectives of the rule. The provisions of section 205 do not apply when they are inconsistent with applicable law. Moreover, section 205 allows EPA to adopt an alternative other than the least costly, most cost-effective or least burdensome alternative if the Administrator publishes with the final rule an explanation why that alternative was not adopted. Before EPA establishes any regulatory requirements that may significantly or uniquely affect small

²⁰⁵ U.S. EPA, *Summary of Small Business Outreach for Locomotive and Marine Diesel NPRM*, Memorandum to Docket EPA–HQ–OAR–2003–0190 from Bryan Manning, January 18, 2007.

governments, including tribal governments, it must have developed under section 203 of the UMRA a small government agency plan. The plan must provide for notifying potentially affected small governments, enabling officials of affected small governments to have meaningful and timely input in the development of EPA regulatory proposals with significant Federal intergovernmental mandates, and informing, educating, and advising small governments on compliance with the regulatory requirements.

This rule contains no federal mandates for state, local, or tribal governments as defined by the provisions of Title II of the UMRA. The rule imposes no enforceable duties on any of these governmental entities. Nothing in the rule would significantly or uniquely affect small governments. EPA has determined that this rule contains federal mandates that may result in expenditures of more than \$100 million to the private sector in any single year. Accordingly, EPA has evaluated under section 202 of the UMRA the potential impacts to the private sector. EPA believes that this rule represents the least costly, most cost-effective approach to achieve the statutory requirements of the rule. The costs and benefits associated with this rule are included in the final Regulatory Impact Analysis (RIA), as required by the UMRA. This analysis can be found in chapter 6 of the final RIA. A complete discussion of why the approach being finalized in this action was chosen is located in chapter 8 of the final RIA. EPA has determined that this rule contains no regulatory requirements that might significantly or uniquely affect small governments.

Thus, this rule is not subject to the requirements of sections 202 and 205 of the UMRA.

E. Executive Order 13132 (Federalism)

Executive Order 13132, entitled "Federalism" (64 FR 43255, August 10, 1999), requires EPA to develop an accountable process to ensure "meaningful and timely input by State and local officials in the development of regulatory policies that have federalism implications." "Policies that have federalism implications" is defined in the Executive Order to include regulations that have "substantial direct effects on the States, on the relationship between the national government and the States, or on the distribution of power and responsibilities among the various levels of government."

This final rule does not have federalism implications. It will not have substantial direct effects on the States,

on the relationship between the national government and the States, or on the distribution of power and responsibilities among the various levels of government, as specified in Executive Order 13132. Although section 6 of Executive Order 13132 does not apply to this rule, EPA did consult with representatives of various State and local governments in developing this rule. EPA consulted with representatives from the National Association of Clean Air Agencies (NACAA, formerly STAPPA/ALAPCO), the Northeast States for Coordinated Air Use Management (NESCAUM), and the California Air Resources Board (CARB). These organizations and other state organizations submitted comments on the proposed rule. Their comments are available in the rulemaking docket, and are summarized and addressed in the Summary and Analysis of Comments document (which is also available in the rulemaking docket).

In the spirit of Executive Order 13132, and consistent with EPA policy to promote communications between EPA and State and local governments, EPA specifically solicited comment on the proposed rule from State and local officials.

F. Executive Order 13175 (Consultation and Coordination with Indian Tribal Governments)

Executive Order 13175, entitled "Consultation and Coordination with Indian Tribal Governments" (65 FR 67249, November 9, 2000), requires EPA to develop an accountable process to ensure "meaningful and timely input by tribal officials in the development of regulatory policies that have tribal implications." This final rule does not have tribal implications, as specified in Executive Order 13175. The rule will be implemented at the Federal level and impose compliance costs only on locomotive manufacturers, locomotive engine manufacturers, locomotive operators, locomotive remanufacturers, marine engine manufacturers, and marine vessel manufacturers. Tribal governments will be affected only to the extent they purchase and use the regulated engines and vehicles. Thus, Executive Order 13175 does not apply to this rule.

Although Executive Order 13175 does not apply to this rule, EPA did solicit additional comment on this rule from tribal officials. A comment was received from one tribal government; that comment is available in the rulemaking docket, and is summarized and addressed in the Summary and Analysis of Comments document (which is also available in the rulemaking docket).

G. Executive Order 13045: Protection of Children From Environmental Health and Safety Risks

Executive Order 13045: "Protection of Children from Environmental Health Risks and Safety Risks" (62 FR 19885, April 23, 1997) applies to any rule that: (1) Is determined to be "economically significant" as defined under Executive Order 12866, and (2) concerns an environmental health or safety risk that EPA has reason to believe may have a disproportionate effect on children. If the regulatory action meets both criteria, the Agency must evaluate the environmental health or safety effects of the planned rule on children, and explain why the planned regulation is preferable to other potentially effective and reasonably feasible alternatives considered by the Agency.

This final rule is subject to the Executive Order because it is an economically significant regulatory action as defined by Executive Order 12866, and we believe that the environmental health or safety risk addressed by this action may have a disproportionate effect on children. Accordingly, we have evaluated the environmental health or safety effects of these risks on children. The results of this evaluation are discussed above in section II of this preamble, and in chapter 2 of the Regulatory Impact Analysis (RIA).

EPA recently conducted an initial screening-level analysis of selected marine port areas and rail yards²⁰⁶,²⁰⁷ to begin to understand the populations, including children, that are exposed to DPM emissions from these facilities. This screening-level analysis²⁰⁸ indicates that at the 47 marine ports and 37 rail yards studied, at least 13 million people, including 3.5 million children live in neighborhoods that are exposed to higher levels of DPM from these

²⁰⁶ ICF International. September 28, 2007. Estimation of diesel particulate matter concentration isopleths for marine harbor areas and rail yards. Memorandum to EPA under Work Assignment Number 0-3, Contract Number EP-C-06-094. This memo is available in Docket EPA-HQ-OAR-2003-0190.

²⁰⁷ ICF International. September 28, 2007. Estimation of diesel particulate matter population exposure near selected harbor areas and rail yards. Memorandum to EPA under Work Assignment Number 0-3, Contract Number EP-C-06-094. This memo is available in Docket EPA-HQ-OAR-2003-0190.

²⁰⁸ This type of screening-level analysis is an inexact tool and not appropriate for regulatory decision-making; it is useful in beginning to understand potential impacts and for illustrative purposes. Additionally, the emissions inventories used as inputs into our analysis are not official estimates and they likely underestimate overall emissions because they are not inclusive of all emissions sources at the individual ports in our sample.

facilities than people living further away and will benefit from the controls being finalized in this action.

With regard to children, the screening-level analysis shows that the age composition of the total affected population near both the marine ports and rail yards matches closely the age composition of the overall U.S. population. However, for some individual facilities the young appear to be over-represented in the affected population compared to the overall U.S. population. See section VI of this preamble and chapters 2 and 6 of the RIA for a discussion on the air quality and monetized health benefits of this rule, including the benefits to children's health.

This rulemaking will achieve significant reductions of various emissions from locomotive and marine diesel engines, including NO_x, PM, and air toxics. These pollutants raise concerns regarding environmental health or safety risks that EPA has reason to believe may have a disproportionate effect on children, such as impacts from ozone, PM, and certain toxic air pollutants.

EPA has evaluated several regulatory strategies for reductions in emissions from locomotive and marine diesel engines, and we believe that we have selected the most stringent and effective control reasonably feasible at this time (in light of the technology and cost requirements of the Clean Air Act), which will benefit the health of children.

H. Executive Order 13211: Actions That Significantly Affect Energy Supply, Distribution, or Use

Executive Order 13211, "Actions Concerning Regulations That Significantly Affect Energy Supply, Distribution, or Use" (66 FR 28355 (May 22, 2001)), requires EPA to prepare and submit a Statement of Energy Effects to the Administrator of the Office of Information and Regulatory Affairs, Office of Management and Budget, for certain actions identified as "significant energy actions." Section 4(b) of Executive Order 13211 defines "significant energy actions" as "any action by an agency (normally published in the **Federal Register**) that promulgates or is expected to lead to the promulgation of a final rule or regulation, including notices of inquiry, advance notices of proposed rulemaking, and notices of proposed rulemaking: (1)(i) that is a significant regulatory action under Executive Order 12866 or any successor order, and (ii) is likely to have a significant adverse effect on the supply, distribution, or use of

energy; or (2) that is designated by the Administrator of the Office of Information and Regulatory Affairs as a significant energy action." We have prepared a Statement of Energy Effects for this action as follows.

This rule's potential effects on energy supply, distribution, or use have been analyzed and are discussed in detail in section 5.8 of the RIA. In summary, while we project that this rule would result in an energy effect that exceeds the 4,000 barrel per day threshold noted in E.O. 13211 in or around the year 2022 and thereafter, the program consists of performance-based standards with averaging, banking, and trading provisions that make it likely that our estimated impact is overstated. Further, the fuel consumption estimates upon which we are basing this energy effect analysis, which are discussed in full in sections 5.4 and 5.5 of the RIA, do not reflect the potential fuel savings associated with automatic engine stop/start (AESS) systems or other idle reduction technologies. Such technologies can provide significant fuel savings which could offset our projected estimates of increased fuel consumption. Nonetheless, our projections show that this rule could result in energy usage exceeding the 4,000 barrel per day threshold noted in E.O. 13211.

I. National Technology Transfer Advancement Act

As noted in the proposed rule, Section 12(d) of the National Technology Transfer and Advancement Act of 1995 ("NTTAA"), Public Law No. 104-113, 12(d) (15 U.S.C. 272 note) directs EPA to use voluntary consensus standards in its regulatory activities unless to do so would be inconsistent with applicable law or otherwise impractical. Voluntary consensus standards are technical standards (e.g., materials specifications, test methods, sampling procedures, and business practices) that are developed or adopted by voluntary consensus standards bodies. The NTTAA directs EPA to provide Congress, through OMB, explanations when the Agency decides not to use available and applicable voluntary consensus standards.

This rule references technical standards adopted by EPA through previous rulemakings. No new technical standards are established in this rule. The standards referenced in today's rule involve test procedures for measuring engine emissions. These measurement standards include those that were developed by EPA as well as the International Organization for Standardization (ISO) engine testing

voluntary consensus standards, adopted in previous rulemakings. These standards have served EPA's emissions control goals well since their implementation and have been well accepted by industry. Therefore, EPA will continue to use the ISO and existing EPA-developed standards referenced in 40 CFR Parts 94 and 1065.

J. Executive Order 12898: Federal Actions to Address Environmental Justice in Minority Populations and Low-Income Populations

Executive Order (EO) 12898 (59 FR 7629 (Feb. 16, 1994)) establishes federal executive policy on environmental justice. Its main provision directs federal agencies, to the greatest extent practicable and permitted by law, to make environmental justice part of their mission by identifying and addressing, as appropriate, disproportionately high and adverse human health or environmental effects of their programs, policies, and activities on minority populations and low-income populations in the United States.

EPA has determined that this final rule will not have disproportionately high and adverse human health or environmental effects on minority or low-income populations because it increases the level of environmental protection for all affected populations without having any disproportionately high and adverse human health or environmental effects on any population, including any minority or low-income population.

This rulemaking will achieve significant reductions of various emissions from locomotive and marine diesel engines, including NO_x, PM, and air toxics. Exposure to these pollutants raises concerns regarding environmental health for the U.S. population in general including the minority populations and low-income populations that are the focus of the environmental justice executive order.

EPA has evaluated several regulatory strategies for reductions in emissions from locomotive and marine diesel engines, and we believe that we have selected the most stringent and effective control reasonably feasible at this time (in light of the technology and cost requirements of the Clean Air Act).

The emission reductions from the stringent new standards finalized in the locomotive and marine diesel rule will have large beneficial effects on communities in proximity to port, harbor, waterway, railway, and rail yard locations, including low-income and minority communities. In addition to stringent exhaust emission standards for freshly manufactured and

remanufactured engines, the final rule includes provisions targeted to further reduce emissions from regulated engines that directly impact low-income and minority communities. The idle reduction provision is one example: “Even in very efficient railroad operations, locomotive engines spend a substantial amount of time idling, during which they emit harmful pollutants, consume fuel, create noise, and increase maintenance costs. A significant portion of this idling occurs in rail yards, as railcars and locomotives are transferred to build up trains. Many of these rail yards are in urban neighborhoods, close to where people live, work, and go to school” (from section III.C(1)(c) of this preamble). The final rule includes a mandatory locomotive idle reduction requirement that will begin to take effect as early as 2008. Another example is the emission standards for freshly manufactured switch locomotives. Switch locomotives are major polluters in urban rail yards. These standards are earlier and more stringent than the line-haul locomotive standards, and include incentives for introducing cleaner switchers using Tier 4 nonroad engines. Further examples can be found in averaging, banking, and trading program provisions aimed at ensuring that emissions are not shifted from line-haul locomotives operating in rural areas to rail yards in urban communities.

EPA recently conducted an initial screening-level analysis of selected marine port areas and rail yards^{209, 210} to better understand the populations, including minority and low-income, that are exposed to DPM emissions from these facilities. This screening-level analysis²¹¹ indicates that at the 47 marine ports and 37 rail yards studied at least 13 million people, including a high percentage of low-income households, African-Americans, and

Hispanics, live in the vicinity of these facilities and are exposed to higher levels of DPM than urban background levels. Thus, these residents will benefit from the controls being finalized in this action. See section II.A and II.B of this preamble and chapter 2 of the RIA for a discussion on the benefits of this rule, including the benefits to minority and low-income communities. Because those living in the vicinity of marine ports and rail yards are more likely to be low-income and minority residents, these populations will receive a significant benefit from this rule.

K. Congressional Review Act

The Congressional Review Act, 5 U.S.C. 801 et seq., as added by the Small Business Regulatory Enforcement Fairness Act of 1996, generally provides that before a rule may take effect, the agency promulgating the rule must submit a rule report, which includes a copy of the rule, to each House of the Congress and to the Comptroller General of the United States. EPA will submit a report containing this rule and other required information to the U.S. Senate, the U.S. House of Representatives, and the Comptroller General of the United States prior to publication of the rule in the **Federal Register**. A Major rule cannot take effect until 60 days after it is published in the **Federal Register**. This action is a “major rule” as defined by 5 U.S.C. 804(2). This rule will be effective July 7, 2008.

X. Statutory Provisions and Legal Authority

Statutory authority for the controls in this final rule can be found in sections 213 (which specifically authorizes controls on emissions from nonroad engines and vehicles), 203–209, 216, and 301 of the Clean Air Act (CAA), 42 U.S.C. 7547, 7522, 7523, 7424, 7525, 7541, 7542, 7543, 7550, and 7601.

List of Subjects

40 CFR Part 9

Reporting and recordkeeping requirements.

40 CFR Part 85

Confidential business information, Imports, Labeling, Motor vehicle pollution, Reporting and recordkeeping requirements, Research, Warranties.

40 CFR Part 86

Administrative practice and procedure, Confidential business information, Labeling, Motor vehicle pollution, Reporting and recordkeeping requirements.

40 CFR Part 89

Environmental protection, Administrative practice and procedure, Confidential business information, Imports, Labeling, Motor vehicle pollution, Reporting and recordkeeping requirements, Research, Vessels, Warranties.

40 CFR Part 92

Environmental protection, Administrative practice and procedure, Air pollution control, Confidential business information, Imports, Incorporation by reference, Labeling, Penalties, Railroads, Reporting and recordkeeping requirements, Warranties.

40 CFR Part 94

Environmental protection, Administrative practice and procedure, Air pollution control, Confidential business information, Imports, Incorporation by reference, Labeling, Penalties, Vessels, Reporting and recordkeeping requirements, Warranties.

40 CFR Part 1033

Environmental protection, Administrative practice and procedure, Confidential business information, Incorporation by reference, Labeling, Penalties, Railroads, Reporting and recordkeeping requirements.

40 CFR Part 1039

Environmental protection, Administrative practice and procedure, Air pollution control, Confidential business information, Imports, Incorporation by reference, Labeling, Penalties, Reporting and recordkeeping requirements, Warranties.

40 CFR Part 1042

Environmental protection, Administrative practice and procedure, Air pollution control, Confidential business information, Imports, Incorporation by reference, Labeling, Penalties, Vessels, Reporting and recordkeeping requirements, Warranties.

40 CFR Part 1065

Environmental protection, Administrative practice and procedure, Incorporation by reference, Reporting and recordkeeping requirements, Research.

40 CFR Part 1068

Environmental protection, Administrative practice and procedure, Confidential business information, Imports, Motor vehicle pollution,

²⁰⁹ ICF International. September 28, 2007.

Estimation of diesel particulate matter concentration isopleths for marine harbor areas and rail yards. Memorandum to EPA under Work Assignment Number 0–3, Contract Number EP–C–06–094. This memo is available in Docket EPA–HQ–OAR–2003–0190.

²¹⁰ ICF International. September 28, 2007.

Estimation of diesel particulate matter population exposure near selected harbor areas and rail yards. Memorandum to EPA under Work Assignment Number 0–3, Contract Number EP–C–06–094. This memo is available in Docket EPA–HQ–OAR–2003–0190.

²¹¹ This type of screening analysis is an inexact tool and not appropriate for regulatory decision-making; it is useful in beginning to understand potential impacts and for illustrative purposes. Additionally, the emissions inventories used as inputs into our analysis are not official estimates and they likely underestimate overall emissions because they are not inclusive of all emission sources at the individual ports in our sample.

Penalties, Reporting and recordkeeping requirements, Warranties.

Dated: March 14, 2008.

Stephen L. Johnson, Administrator.

For the reasons set forth in the preamble, chapter I of title 40 of the Code of Federal Regulations is amended as follows:

PART 9—OMB APPROVALS UNDER THE PAPERWORK REDUCTION ACT

1. The authority citation for part 9 continues to read as follows:

Authority: 7 U.S.C. 135 et seq., 136-136y; 15 U.S.C. 2001, 2003, 2005, 2006, 2601-2671; 21 U.S.C. 331j, 346a, 348; 31 U.S.C. 9701; 33 U.S.C. 1251 et seq., 1311, 1313d, 1314, 1318, 1321, 1326, 1330, 1342, 1344, 1345(d) and (e), 1361; E.O. 11735, 38 FR 21243, 3 CFR, 1971-1975 Comp. p. 973; 42 U.S.C. 241, 242b, 243, 246, 300f, 300g, 300g-1, 300g-2, 300g-3, 300g-4, 300g-5, 300g-6, 300j-1, 300j-2, 300j-3, 300j-4, 300j-9, 1857 et seq., 6901-6992k, 7401-7671q, 7542, 9601-9657, 11023, 11048.

2. Section 9.1 is amended in the table by adding the center headings and the entries under those center headings in numerical order to read as follows:

§ 9.1 OMB approvals under the Paperwork Reduction Act.

* * * * *

Table with 2 columns: 40 CFR citation, OMB control No.

Table with 2 columns: 40 CFR citation, OMB control No. Control of Emissions from Locomotives

Table with 2 columns: 40 CFR citation, OMB control No. Control of Emissions From New and In-use Marine Compression-ignition Engines and Vessels

PART 85—CONTROL OF AIR POLLUTION FROM MOBILE SOURCES

3. The authority citation for part 85 continues to read as follows:

Authority: 42 U.S.C. 7401-7671q.

Subpart Y—[Amended]

4. Section 85.2401 is amended by revising paragraphs (a)(7) and (a)(8) to read as follows:

§ 85.2401 To whom do these requirements apply?

(a) * * *

(7) Locomotives (See 40 CFR parts 92 and 1033);

(8) Marine engines (See 40 CFR parts 91, 94, and 1042 and MARPOL Annex VI, as applicable);

* * * * *

M_HC = (kV_n * 10^-4) * ((C_HCf - rC_CH3OH_f)P_Bf / T_f - (C_HCi - rC_CH3OH_i)P_Bi / T_i) + (M_HC,out - M_HC,in)

* * * * *

Subpart N—[Amended]

8. Section 86.1305-2010 is amended by revising paragraph (b) to read as follows:

§ 86.1305-2010 Introduction; structure of subpart.

* * * * *

(b) Use the applicable equipment and procedures for spark-ignition or compression-ignition engines in 40 CFR part 1065 to determine whether engines meet the duty-cycle emission standards in subpart A of this part. Measure the emissions of all regulated pollutants as specified in 40 CFR part 1065. Use the duty cycles and procedures specified in §§ 86.1333-2010, 86.1360-2007, and

86.1362-2007. Adjust emission results from engines using aftertreatment technology with infrequent regeneration events as described in § 86.004-28.

* * * * *

9. Section 86.1333-2010 is amended by adding paragraph (d) to read as follows:

§ 86.1333-2010 Transient test cycle generation.

* * * * *

(d) Determine idle speeds as specified in § 86.1337-2007(a)(9).

10. Section 86.1360-2007 is amended by adding paragraph (b)(3) to read as follows:

PART 86—CONTROL OF EMISSIONS FROM NEW AND IN-USE HIGHWAY VEHICLES AND ENGINES

5. The authority citation for part 86 continues to read as follows:

Authority: 42 U.S.C. 7401-7671q.

Subpart A—[Amended]

6. Section 86.007-11 is amended by revising paragraph (a)(2) introductory text to read as follows:

§ 86.007-11 Emission standards and supplemental requirements for 2007 and later model year diesel heavy-duty engines and vehicles.

* * * * *

(a) * * *

(2) The standards set forth in paragraph (a)(1) of this section refer to the exhaust emitted over the duty cycle specified in paragraphs (a)(2)(i) through (iii) of this section, where exhaust emissions are measured and calculated as specified in paragraphs (a)(2)(iv) and (v) of this section in accordance with the procedures set forth in subpart N of this part, except as noted in § 86.007-23(c)(2):

* * * * *

7. Section 86.117-96 is amended by revising the first equation in paragraph (d)(2) to read as follows:

§ 86.117-96 Evaporative emission enclosure calibrations.

* * * * *

(d) * * *

(2) * * *

§ 86.1360-2007 Supplemental emission test; test cycle and procedures.

* * * * *

(b) * * *

(3) For engines certified using the ramped-modal cycle specified in § 86.1362, perform the three discrete test points described in paragraph (b)(2) of this section as follows:

(i) Allow the engine to idle as needed to complete equipment checks following the supplemental emission test described in this section, then operate the engine over the three additional discrete test points.

(ii) Validate the additional discrete test points as a composite test separate from the supplemental emission test, but in the same manner.

(iii) Use the emission data collected during the time interval from 35 to 5 seconds before the end of each mode (excluding transitions) to perform the MAEL calculations in paragraph (f) of this section.

* * * * *

§ 86.1362–2007 [Amended]

■ 11. Section 86.1362–2007 is amended by removing and reserving paragraph (d).

■ 12. A new § 86.1362–2010 is added to read as follows:

§ 86.1362–2010 Steady-state testing with a ramped-modal cycle.

This section describes how to test engines under steady-state conditions. For model years through 2009, manufacturers may use the mode order described in this section or in § 86.1362–2007. Starting in model year 2010 manufacturers must use the mode order described in this section with the following exception: for model year 2010, manufacturers may continue to use the cycle specified in § 86.1362–2007 as long as it does not adversely

affect the ability to demonstrate compliance with the standards.

(a) Start sampling at the beginning of the first mode and continue sampling until the end of the last mode. Calculate emissions as described in 40 CFR 1065.650 and cycle statistics as described in 40 CFR 1065.514.

(b) Measure emissions by testing the engine on a dynamometer with the following ramped-modal duty cycle to determine whether it meets the applicable steady-state emission standards:

RMC mode	Time in mode (seconds)	Engine speed ^{1 2}	Torque (percent) ^{2 3}
1a Steady-state	170	Warm Idle	0
1b Transition	20	Linear Transition	Linear Transition.
2a Steady-state	173	A	100
2b Transition	20	Linear Transition	Linear Transition.
3a Steady-state	219	B	50
3b Transition	20	B	Linear Transition.
4a Steady-state	217	B	75
4b Transition	20	Linear Transition	Linear Transition.
5a Steady-state	103	A	50
5b Transition	20	A	Linear Transition.
6a Steady-state	100	A	75
6b Transition	20	A	Linear Transition.
7a Steady-state	103	A	25
7b Transition	20	Linear Transition	Linear Transition.
8a Steady-state	194	B	100
8b Transition	20	B	Linear Transition.
9a Steady-state	218	B	25
9b Transition	20	Linear Transition	Linear Transition.
10a Steady-state	171	C	100
10b Transition	20	C	Linear Transition.
11a Steady-state	102	C	25
11b Transition	20	C	Linear Transition.
12a Steady-state	100	C	75
12b Transition	20	C	Linear Transition.
13a Steady-state	102	C	50
13b Transition	20	Linear Transition	Linear Transition.
14 Steady-state	168	Warm Idle	0

¹ Speed terms are defined in 40 CFR part 1065.

² Advance from one mode to the next within a 20-second transition phase. During the transition phase, command a linear progression from the speed or torque setting of the current mode to the speed or torque setting of the next mode.

³ The percent torque is relative to maximum torque at the commanded engine speed.

(c) During idle mode, operate the engine at its warm idle as described in 40 CFR part 1065.

(d) See 40 CFR part 1065 for detailed specifications of tolerances and calculations.

(e) Perform the ramped-modal test with a warmed-up engine. If the ramped-modal test follows directly after

testing over the Federal Test Procedure, consider the engine warm. Otherwise, operate the engine to warm it up as described in 40 CFR part 1065, subpart F.

■ 13. Section 86.1363–2007 is amended by revising paragraph (a) and the

equation in paragraph (g)(1) to read as follows:

§ 86.1363–2007 Steady-state testing with a discrete-mode cycle.

* * * * *

(a) Use the following 13-mode cycle in dynamometer operation on the test engine:

Mode No.	Engine speed ¹	Percent load ²	Weighting factors	Mode length (minutes) ³
1	Warm Idle		0.15	4
2	A	100	0.08	2
3	B	50	0.10	2
4	B	75	0.10	2
5	A	50	0.05	2
6	A	75	0.05	2
7	A	25	0.05	2
8	B	100	0.09	2
9	B	25	0.10	2

Mode No.	Engine speed ¹	Percent load ²	Weighting factors	Mode length (minutes) ³
10	C	100	0.08	2
11	C	25	0.05	2
12	C	75	0.05	2
13	C	50	0.05	2

¹ Speed terms are defined in 40 CFR part 1065.

² The percent torque is relative to the maximum torque at the commanded test speed.

³ Upon Administrator approval, the manufacturer may use other mode lengths.

* * * * *

(g) * * *

(1) * * *

$$A_{WA} = \frac{\sum_{i=1}^N [A_{Mi} \cdot WF_i]}{\sum_{i=2}^N [A_{Pi} \cdot WF_i]}$$

* * * * *

Subpart P—[Amended]

■ 14. Subpart P is amended by removing § 86.1504–94.

§§ 86.1501–94 through 86.1544–84 [Redesignated]

■ 15. Redesignate §§ 86.1501–94 through 86.1544–84 as follows:

Old section	New section
86.1501–94	86.1501
86.1502–84	86.1502
86.1503–84	86.1503
86.1505–94	86.1505
86.1506–94	86.1506
86.1509–84	86.1509
86.1511–84	86.1511
86.1513–94	86.1513
86.1514–84	86.1514
86.1516–84	86.1516
86.1519–84	86.1519
86.1522–84	86.1522
86.1524–84	86.1524
86.1526–84	86.1526
86.1527–84	86.1527
86.1530–84	86.1530
86.1537–84	86.1537
86.1540–84	86.1540
86.1542–84	86.1542
86.1544–84	86.1544

■ 16. Newly designated § 86.1506 is amended by adding paragraph (b) to read as follows:

§ 86.1506 Equipment required and specifications; overview.

* * * * *

(b) Through the 2009 model year, manufacturers may elect to use the appropriate test procedures in this part 86 instead of the procedures referenced in 40 CFR part 1065 without getting advance approval by the Administrator.

PART 89—CONTROL OF EMISSIONS FROM NEW AND IN-USE NONROAD COMPRESSION-IGNITION ENGINES

■ 17. The authority citation for part 89 continues to read as follows:

Authority: 42 U.S.C. 7401–7671q.

Subpart J—[Amended]

■ 18. A new § 89.916 is added to read as follows:

§ 89.916 Emergency-vessel exemption for marine engines below 37 kW.

The prohibitions in § 89.1003(a)(1) do not apply to new marine engines used in lifeboats and rescue boats as described in 40 CFR 94.914.

PART 92—CONTROL OF AIR POLLUTION FROM LOCOMOTIVES AND LOCOMOTIVE ENGINES

■ 19. The authority citation for part 92 continues to read as follows:

Authority: 42 U.S.C. 7401–7671q.

■ 20. Section 92.1 is amended by revising paragraph (a) introductory text and adding paragraph (e) to read as follows:

§ 92.1 Applicability.

(a) Except as noted in paragraphs (b), (d) and (e) of this section, the provisions of this part apply to manufacturers, remanufacturers, owners and operators of:

* * * * *

(e) The provisions of this part do not apply for locomotives that are subject to the emissions standards of 40 CFR part 1033.

■ 21. Section 92.2 is amended by revising the definition for “Freshly manufactured locomotive” to read as follows:

§ 92.2 Definitions.

* * * * *

Freshly manufactured locomotive means a locomotive which is powered by a freshly manufactured engine, and which contains fewer than 25 percent previously used parts (weighted by the dollar value of the parts). See 40 CFR

1033.640 for information about how to calculate this.

* * * * *

■ 22. Section 92.12 is amended by revising paragraph (b) and adding paragraphs (i) and (j) to read as follows:

§ 92.12 Interim provisions.

* * * * *

(b) *Production line and in-use testing.*

(1) The requirements of Subpart F of this part (i.e., production line testing) do not apply prior to January 1, 2002.

(2) The testing requirements of subpart F of this part (i.e., production line testing) do not apply to small manufacturers/remanufacturers prior to January 1, 2013. Note that the production line audit requirements apply as specified.

(3) The requirements of Subpart G of this part (i.e., in-use testing) only apply for locomotives and locomotive engines that become new on or after January 1, 2002.

(4) For locomotives and locomotive engines that are covered by a small business certificate of conformity, the requirements of Subpart G of this part (i.e., in-use testing) only apply for locomotives and locomotive engines that become new on or after January 1, 2007. We will also not require small remanufacturers to perform any in-use testing prior to January 1, 2013.

* * * * *

(i) *Diesel test fuels.* Manufacturers and remanufacturers may use LSD or ULSD test fuel to certify to the standards of this part, instead of the otherwise specified test fuel, provided PM emissions are corrected as described in this paragraph (i). Measure your PM emissions and determine your cycle-weighted emission rates as specified in subpart B of this part. If you test using LSD, add 0.04 g/bhp-hr to these weighted emission rates to determine your official emission result. If you test using ULSD, add 0.05 g/bhp-hr to these weighted emission rates to determine your official emission result.

(j) *Subchapter U provisions.* For model years 2008 through 2012, certain locomotives will be subject to the requirements of this part 92 while others will be subject to the

requirements of 40 CFR subchapter U. This paragraph (j) describes allowances for manufacturers or remanufacturers to ask for flexibility in transitioning to the new regulations.

(1) You may ask to use a combination of the test procedures of this part and those of 40 CFR part 1033. We will approve your request if you show us that it does not affect your ability to show compliance with the applicable emission standards. Generally this requires that the combined procedures would result in emission measurements at least as high as those that would be measured using the procedures specified in this part. Alternatively, you may demonstrate that the combined effects of the procedures is small relative to your compliance margin (the degree to which your locomotives are below the applicable standards).

(2) You may ask to comply with the administrative requirements of 40 CFR part 1033 and 1068 instead of the equivalent requirements of this part.

■ 23. Section 92.204 is amended by adding paragraph (f) to read as follows:

§ 92.204 Designation of engine families.

* * * * *

(f) Remanufactured Tier 2 locomotives may be included in the same engine family as freshly manufactured Tier 2 locomotives, provided such engines are used for locomotive models included in the engine family.

■ 24. Section 92.206 is amended by revising paragraph (c) to read as follows:

§ 92.206 Required information.

* * * * *

(c) Emission data, including exhaust methane data in the case of locomotives or locomotive engines subject to a non-methane hydrocarbon standard, on such locomotives or locomotive engines tested in accordance with applicable test procedures of subpart B of this part. These data shall include zero hour data, if generated. In lieu of providing the emission data required by paragraph (a) of this section, the Administrator may, upon request of the manufacturer or remanufacturer, allow the manufacturer or remanufacturer to demonstrate (on the basis of previous emission tests, development tests, or other testing information) that the engine or locomotive will conform with the applicable emission standards of § 92.8. The requirement to measure smoke emissions is waived for certification and production line testing of Tier 2 locomotives, except where there is reason to believe the locomotives do not meet the applicable smoke standards.

* * * * *

■ 25. Section 92.208 is amended by revising paragraph (a) to read as follows:

§ 92.208 Certification.

(a) This paragraph (a) applies to manufacturers of new locomotives and new locomotive engines. If, after a review of the application for certification, test reports and data acquired from a freshly manufactured locomotive or locomotive engine or from a development data engine, and any other information required or obtained by EPA, the Administrator determines that the application is complete and that the engine family meets the requirements of the Act and this part, he/she will issue a certificate of conformity with respect to such engine family except as provided by paragraph (c)(3) of this section. The certificate of conformity is valid for each engine family starting with the indicated effective date, but it is not valid for any production after December 31 of the model year for which it is issued (except as specified in (92.12). The certificate of conformity is valid upon such terms and conditions as the Administrator deems necessary or appropriate to ensure that the production engines covered by the certificate will meet the requirements of the Act and of this part.

* * * * *

■ 26. Section 92.212 is amended by revising paragraph (b)(2)(iv) to read as follows:

§ 92.212 Labeling.

* * * * *

(b) * * *

(2) * * *

(iv) The label may be made up of more than one piece permanently attached to the same locomotive part, except for Tier 0 locomotives, where you may attach it to separate parts.

* * * * *

■ 27. Section 92.501 is amended by adding paragraph (c) to read as follows:

§ 92.501 Applicability.

* * * * *

(c) Manufacturers may comply with the provisions of subpart D of 40 CFR part 1033 instead of the provisions of this subpart F.

■ 28. A new § 92.1007 is added to read as follows:

§ 92.1007 Remanufacturing requirements.

(a) See the definition of “remanufacture” in § 92.2 to determine if you are remanufacturing your locomotive or engine. (**Note:** Replacing power assemblies one at a time may

qualify as remanufacturing, depending on the interval between replacement.)

(b) See the definition of “new” in § 92.2 to determine if remanufacturing your locomotive makes it subject to the requirements of this part. If the locomotive is considered to be new, it is subject to the certification requirements of this part, unless it is exempt under subpart J of this part. The standards to which your locomotive is subject will depend on factors such as the following:

(1) Its date of original manufacture.

(2) The FEL to which it was previously certified, which is listed on the “Locomotive Emission Control Information” label.

(3) Its power rating (whether it is above or below 2300 hp).

(4) The calendar year in which it is being remanufactured.

(c) You may comply with the certification requirements of this part for your remanufactured locomotive by either obtaining your own certificate of conformity as specified in subpart C of this part or by having a certifying remanufacturer include your locomotive under its certificate of conformity. In either case, your remanufactured locomotive must be covered by a certificate before it is reintroduced into service.

(d) If you do not obtain your own certificate of conformity from EPA, contact a certifying remanufacturer to have your locomotive included under its certificate of conformity. Confirm with the certificate holder that your locomotive’s model, date of original manufacture, previous FEL, and power rating allow it to be covered by the certificate. You must do all of the following:

(1) Comply with the certificate holder’s emission-related installation instructions.

(2) Provide to the certificate holder the information it identifies as necessary to comply with the requirements of this part.

(e) For parts unrelated to emissions and emission-related parts not addressed by the certificate holder in the emission-related installation instructions, you may use parts from any source. For emission-related parts listed by the certificate holder in the emission-related installation instructions, you must either use the specified parts or parts certified under 40 CFR 1033.645 for remanufacturing. If you believe that the certificate holder has included as emission-related parts, parts that are actually unrelated to emissions, you may ask us to exclude such parts from the emission-related installation instructions. (**Note:** This

paragraph (e) does not apply with respect to parts for maintenance other than remanufacturing; see § 92.1004 for provisions related to general maintenance.)

(f) Failure to comply with this section is a violation of § 92.1102(a)(1).

PART 94—CONTROL OF EMISSIONS FROM MARINE COMPRESSION-IGNITION ENGINES

■ 29. The authority citation for part 94 continues to read as follows:

Authority: 42 U.S.C. 7401–7671q.

Subpart A— [Amended]

■ 30. Section 94.1 is amended by revising paragraph (b) to read as follows:

§ 94.1 Applicability.

* * * * *

(b) Notwithstanding the provisions of paragraph (c) of this section, the requirements and prohibitions of this part do not apply with respect to the engines identified in paragraphs (a)(1) and (2) of this section for any of the following engines:

- (1) Marine engines with rated power below 37 kW.
- (2) Marine engines on foreign vessels.
- (3) Marine engines subject to the standards of 40 CFR part 1042.

* * * * *

■ 31. Section 94.2 is amended by revising paragraph (1)(ii) of the definition for “New vessel” and adding definitions for “Nonroad” and “Nonroad engine” in alphabetical order to read as follows:

§ 94.2 Definitions.

* * * * *

New vessel means:

(1)(i) * * *

(ii) For vessels with no Category 3 engines, a vessel that has been modified such that the value of the modifications exceeds 50 percent of the value of the modified vessel. The value of the modification is the difference in the assessed value of the vessel before the modification and the assessed value of the vessel after the modification. Use the following equation to determine if the fractional value of the modification exceeds 50 percent:

$$\text{Percent of value} = \frac{[(\text{Value after modification}) - (\text{Value before modification})] \times (100\% \div (\text{Value after modification}))}{* * * * *}$$

Nonroad means relating to nonroad engines, or vessels or equipment that include nonroad engines.

Nonroad engine has the meaning given in 40 CFR 1068.30. In general, this

means all internal-combustion engines except motor vehicle engines, stationary engines, engines used solely for competition, or engines used in aircraft.

* * * * *

■ 32. Section 94.12 is amended by adding paragraph (i) to read as follows:

§ 94.12 Interim provisions.

* * * * *

(i) *Early use of future provisions.* For model years 2009 through 2013, certain marine engines will be subject to the requirements of this part 94 while others will be subject to the requirements of 40 CFR part 1042. Manufacturers may ask for flexibility in making the transition to the new regulations as follows:

(1) You may ask to use a combination of the test procedures of this part and those of 40 CFR part 1042. This might include the early use of the duty cycles and NTE specifications that apply for Tier 3 or Tier 4 engines. We will approve your request only if you show us that it does not affect your ability to demonstrate compliance with the applicable emission standards. This generally requires that the combined procedures would result in emission measurements at least as high as those that would be measured using the procedures specified in this part. Alternatively, you may demonstrate that the combined effects of the procedures is small relative to your compliance margin (the degree to which your engines are below the applicable standards).

(2) You may ask to comply with the administrative requirements of 40 CFR parts 1042 and 1068 instead of the equivalent requirements of this part.

Subpart B—[Amended]

■ 33. Section 94.108 is amended by adding paragraph (a)(4) and revising paragraph (d) to read as follows:

§ 94.108 Test fuels.

(a) * * *

(4) Manufacturers may perform testing using the low-sulfur diesel test fuel or the ultra low-sulfur diesel test fuel specified in 40 CFR part 1065.

* * * * *

(d) *Correction for sulfur*—(1) *High sulfur fuel.* (i) Particulate emission measurements from Category 1 or Category 2 engines without exhaust aftertreatment obtained using a diesel fuel containing more than 0.40 weight percent sulfur may be adjusted to a sulfur content of 0.40 weight percent.

(ii) Adjustments to the particulate measurement for using high sulfur fuel

shall be made using the following equation:

$$PM_{adj} = PM - [BSFC \times 0.0917 \times (FSF - 0.0040)]$$

Where:

PM_{adj}=adjusted measured PM level [g/kW-hr]

PM=measured weighted PM level [g/kW-hr]

BSFC=measured brake specific fuel consumption [g/kW-hr]

FSF=fuel sulfur weight fraction

(2) *Low sulfur fuel.* (i) Particulate emission measurements from Category 1 or Category 2 engines without exhaust aftertreatment obtained using diesel fuel containing less than 0.03 weight percent sulfur shall be adjusted to a sulfur content of 0.20 weight percent.

(ii) Adjustments to the particulate measurement for using ultra low-sulfur fuel shall be made using the following equation:

$$PM_{adj} = PM + [BSFC \times 0.0917 \times (0.0020 - FSF)]$$

Where:

PM_{adj}=adjusted measured PM level [g/kW-hr]

PM=measured weighted PM level [g/kW-hr]

BSFC=measured brake specific fuel consumption [g/kW-hr]

FSF=fuel sulfur weight fraction

* * * * *

Subpart C—[Amended]

■ 34. Section 94.208 is amended by revising paragraph (a) to read as follows:

§ 94.208 Certification.

(a) If, after a review of the application for certification, test reports and data acquired from an engine or from a development data engine, and any other information required or obtained by EPA, the Administrator determines that the application is complete and that the engine family meets the requirements of the Act and this part, he/she will issue a certificate of conformity with respect to such engine family, except as provided by paragraph (c)(3) of this section. The certificate of conformity is valid for each engine family starting with the indicated effective date, but it is not valid for any production after December 31 of the model year for which it is issued. The certificate of conformity is valid upon such terms and conditions as the Administrator deems necessary or appropriate to ensure that the production engines covered by the certificate will meet the requirements of the Act and of this part.

* * * * *

■ 35. Section 94.209 is amended by revising paragraph (a) introductory text to read as follows:

§ 94.209 Special provisions for post-manufacture marinizers and small-volume manufacturers.

* * * * *

(a) *Broader engine families.* Instead of the requirements of § 94.204, an engine family may consist of any or all of a manufacturer's engines within a given category. This does not change any of the requirements of this part for showing that an engine family meets emission standards. To be eligible to use the provisions of this paragraph (a), the manufacturer must demonstrate one of the following:

* * * * *

Subpart F—[Amended]

■ 36. Section 94.501 is amended by adding paragraph (c) to read as follows:

§ 94.501 Applicability.

* * * * *

(c) Manufacturers may comply with the provisions of 40 CFR part 1042, subpart D, instead of the provisions of this subpart F.

Subpart J—[Amended]

■ 37. A new § 94.914 is added to read as follows:

§ 94.914 Emergency vessel exemption.

(a) Except as specified in paragraph (c) of this section, the prohibitions in § 94.1103(a)(1) do not apply to a new engine that is subject to Tier 2 standards according to the following provisions:

(1) The engine must be intended for installation in a lifeboat or a rescue boat as specified in 40 CFR 1042.625(a)(1)(i) or (ii).

(2) This exemption is available from the initial effective date for the Tier 2 standards until the engine model (or an engine of comparable size, weight, and performance) has been certified as complying with the Tier 2 standards and Coast Guard requirements. For example, this exemption would apply for new engine models that have not yet been certified to the Tier 2 standards.

(3) The engine must meet the Tier 1 emission standards specified in § 94.8.

(b) If you introduce an engine into U.S. commerce under this section, you must meet the labeling requirements in § 94.212, but add the following statement instead of the compliance statement in § 94.212(b)(6):

THIS ENGINE DOES NOT COMPLY WITH CURRENT U.S. EPA EMISSION STANDARDS UNDER 40 CFR 94.914 AND IS FOR USE SOLELY IN LIFEBOATS OR RESCUE BOATS (COAST GUARD APPROVAL SERIES 160.135 OR 160.156). INSTALLATION OR USE OF THIS ENGINE IN ANY OTHER APPLICATION MAY BE A

VIOLATION OF FEDERAL LAW SUBJECT TO CIVIL PENALTY.

(c) Introducing into commerce a vessel containing an engine exempted under this section violates the prohibitions in § 94.1103(a)(1) where the vessel is not a lifeboat or rescue boat, unless it is exempt under a different provision. Similarly, using such an engine or vessel as something other than a lifeboat or rescue boat as specified in paragraph (a) of this section violates the prohibitions in § 94.1103(a)(1), unless it is exempt under a different provision.

■ 38. A new part 1033 is added to subchapter U of chapter I to read as follows:

PART 1033—CONTROL OF EMISSIONS FROM LOCOMOTIVES**Subpart A—Overview and Applicability**

Sec.

- 1033.1 Applicability.
- 1033.5 Exemptions and exclusions.
- 1033.10 Organization of this part.
- 1033.15 Other regulation parts that apply for locomotives.

Subpart B—Emission Standards and Related Requirements

- 1033.101 Exhaust emission standards.
- 1033.102 Transition to the standards of this part.
- 1033.110 Emission diagnostics—general requirements.
- 1033.112 Emission diagnostics for SCR systems.
- 1033.115 Other requirements.
- 1033.120 Emission-related warranty requirements.
- 1033.125 Maintenance instructions.
- 1033.130 Instructions for engine remanufacturing or engine installation.
- 1033.135 Labeling.
- 1033.140 Rated power.
- 1033.150 Interim provisions.

Subpart C—Certifying Engine Families

- 1033.201 General requirements for obtaining a certificate of conformity.
- 1033.205 Applying for a certificate of conformity.
- 1033.210 Preliminary approval.
- 1033.220 Amending maintenance instructions.
- 1033.225 Amending applications for certification.
- 1033.230 Grouping locomotives into engine families.
- 1033.235 Emission testing required for certification.
- 1033.240 Demonstrating compliance with exhaust emission standards.
- 1033.245 Deterioration factors.
- 1033.250 Reporting and recordkeeping.
- 1033.255 EPA decisions.

Subpart D—Manufacturer and Remanufacturer Production Line Testing and Audit Programs

- 1033.301 Applicability.
- 1033.305 General requirements.

- 1033.310 Sample selection for testing.
- 1033.315 Test procedures.
- 1033.320 Calculation and reporting of test results.
- 1033.325 Maintenance of records; submittal of information.
- 1033.330 Compliance criteria for production line testing.
- 1033.335 Remanufactured locomotives: installation audit requirements.
- 1033.340 Suspension and revocation of certificates of conformity.

Subpart E—In-use Testing

- 1033.401 Applicability.
- 1033.405 General provisions.
- 1033.410 In-use test procedure.
- 1033.415 General testing requirements.
- 1033.420 Maintenance, procurement and testing of in-use locomotives.
- 1033.425 In-use test program reporting requirements.

Subpart F—Test Procedures

- 1033.501 General provisions.
- 1033.505 Ambient conditions.
- 1033.510 Auxiliary power units.
- 1033.515 Discrete-mode steady-state emission tests of locomotives and locomotive engines.
- 1033.520 Alternative ramped modal cycles.
- 1033.525 Smoke testing.
- 1033.530 Duty cycles and calculations.
- 1033.535 Adjusting emission levels to account for infrequently regenerating aftertreatment devices.

Subpart G—Special Compliance Provisions

- 1033.601 General compliance provisions.
- 1033.610 Small railroad provisions.
- 1033.615 Voluntarily subjecting locomotives to the standards of this part.
- 1033.620 Hardship provisions for manufacturers and remanufacturers.
- 1033.625 Special certification provisions for non-locomotive-specific engines.
- 1033.630 Staged-assembly and delegated assembly exemptions.
- 1033.640 Provisions for repowered and refurbished locomotives.
- 1033.645 Non-OEM component certification program.
- 1033.650 Incidental use exemption for Canadian and Mexican locomotives.
- 1033.655 Special provisions for certain Tier 0/Tier 1 locomotives.

Subpart H—Averaging, Banking, and Trading for Certification

- 1033.701 General provisions.
- 1033.705 Calculating emission credits.
- 1033.710 Averaging emission credits.
- 1033.715 Banking emission credits.
- 1033.720 Trading emission credits.
- 1033.722 Transferring emission credits.
- 1033.725 Requirements for your application for certification.
- 1033.730 ABT reports.
- 1033.735 Required records.
- 1033.740 Credit restrictions.
- 1033.745 Compliance with the provisions of this subpart.
- 1033.750 Changing a locomotive's FEL at remanufacture.

Subpart I—Requirements for Owners and Operators

- 1033.801 Applicability.
- 1033.805 Remanufacturing requirements.
- 1033.810 In-use testing program.
- 1033.815 Maintenance, operation, and repair.
- 1033.820 In-use locomotives.
- 1033.825 Refueling requirements.

Subpart J—Definitions and Other Reference Information

- 1033.901 Definitions.
- 1033.905 Symbols, acronyms, and abbreviations.
- 1033.915 Confidential information.
- 1033.920 How to request a hearing.

Authority: 42 U.S.C. 7401–7671q.

Subpart A—Overview and Applicability**§ 1033.1 Applicability.**

The regulations in this part 1033 apply for all new locomotives and all locomotives containing a new locomotive engine, except as provided in § 1033.5.

(a) Standards begin to apply each time a locomotive or locomotive engine is originally manufactured or otherwise becomes new (defined in § 1033.901). The requirements of this part continue to apply as specified after locomotives cease to be new.

(b) Standards apply to the locomotive. However, in certain cases, the manufacturer/remanufacturer is allowed to test a locomotive engine instead of a complete locomotive, such as for certification. Also, you are not required to complete assembly of a locomotive to obtain a certificate of conformity for it, provided you meet the definition of “manufacturer” or “remanufacturer” (as applicable) in § 1033.901. For example, an engine manufacturer may obtain a certificate for locomotives which it does not manufacture, if the locomotives use its engines.

(c) Standards apply based on the year in which the locomotive was originally manufactured. The date of original manufacture is generally the date on which assembly is completed for the first time. For example, all locomotives originally manufactured in calendar years 2002, 2003, and 2004 are subject to the Tier 1 emission standards for their entire service lives.

(d) The following provisions apply when there are multiple persons meeting the definition of manufacturer or remanufacturer in § 1033.901:

(1) Each person meeting the definition of manufacturer must comply with the requirements of this part that apply to manufacturers; and each person meeting the definition of remanufacturer must comply with the requirements of this part that apply to remanufacturers.

However, if one person complies with a specific requirement for a given locomotive, then all manufacturers/remanufacturers are deemed to have complied with that specific requirement.

(2) We will apply the requirements of subparts C, D, and E of this part to the manufacturer/remanufacturer that obtains the certificate of conformity for the locomotive. Other manufacturers and remanufacturers are required to comply with the requirements of subparts C, D, and E of this part only when notified by us. In our notification, we will specify a reasonable time period in which you need to comply with the requirements identified in the notice. See § 1033.601 for the applicability of 40 CFR part 1068 to these other manufacturers and remanufacturers.

(3) For example, we may require a railroad that installs certified kits but does not hold the certificate to perform production line auditing of the locomotives that it remanufactures. However, if we did, we would allow the railroad a reasonable amount of time to develop the ability to perform such auditing.

(e) The provisions of this part apply as specified for locomotives manufactured or remanufactured on or after July 7, 2008. See § 1033.102 to determine whether the standards of this part or the standards of 40 CFR part 92 apply for model years 2008 through 2012. For example, for a locomotive that was originally manufactured in 2007 and remanufactured on April 10, 2014, the provisions of this part begin to apply on April 10, 2014.

§ 1033.5 Exemptions and exclusions.

(a) Subpart G of this part exempts certain locomotives from the standards of this part.

(b) The definition of “locomotive” in § 1033.901 excludes certain vehicles. In general, the engines used in such excluded equipment are subject to standards under other regulatory parts. For example, see 40 CFR part 1039 for requirements that apply to diesel engines used in equipment excluded from the definition of “locomotive” in § 1033.901. The following locomotives are also excluded from the provisions of this part 1033:

(1) Historic locomotives powered by steam engines. For a locomotive that was originally manufactured after January 1, 1973 to be excluded under this paragraph (b)(1), it may not use any internal combustion engines and must be used only for historical purposes such as at a museum or similar public attraction.

(2) Locomotives powered only by an external source of electricity.

(c) The requirements and prohibitions of this part apply only for locomotives that have become “new” (as defined in § 1033.901) on or after July 7, 2008.

(d) The provisions of this part do not apply for any auxiliary engine that only provides hotel power. In general, these engines are subject to the provisions of 40 CFR part 1039. However, depending on the engine cycle, model year and power rating, the engines may be subject to other regulatory parts instead.

(e) Manufacturers and owners of locomotives that operate only on non-standard gauge rails may ask us to exclude such locomotives from this part by excluding them from the definition of “locomotive”.

§ 1033.10 Organization of this part.

The regulations in this part 1033 contain provisions that affect locomotive manufacturers, remanufacturers, and others. However, the requirements of this part are generally addressed to the locomotive manufacturer/remanufacturer. The term “you” generally means the manufacturer/remanufacturer, as defined in § 1033.901. This part 1033 is divided into the following subparts:

(a) Subpart A of this part defines the applicability of part 1033 and gives an overview of regulatory requirements.

(b) Subpart B of this part describes the emission standards and other requirements that must be met to certify locomotives under this part. Note that § 1033.150 discusses certain interim requirements and compliance provisions that apply only for a limited time.

(c) Subpart C of this part describes how to apply for a certificate of conformity.

(d) Subpart D of this part describes general provisions for testing and auditing production locomotives.

(e) Subpart E of this part describes general provisions for testing in-use locomotives.

(f) Subpart F of this part and 40 CFR part 1065 describe how to test locomotives and engines.

(g) Subpart G of this part and 40 CFR part 1068 describe requirements, prohibitions, exemptions, and other provisions that apply to locomotive manufacturer/remanufacturers, owners, operators, and all others.

(h) Subpart H of this part describes how you may generate and use emission credits to certify your locomotives.

(i) Subpart I of this part describes provisions for locomotive owners and operators.

(j) Subpart J of this part contains definitions and other reference information.

§ 1033.15 Other regulation parts that apply for locomotives.

(a) Part 1065 of this chapter describes procedures and equipment specifications for testing engines. Subpart F of this part 1033 describes how to apply the provisions of part 1065 of this chapter to test locomotives to determine whether they meet the emission standards in this part.

(b) The requirements and prohibitions of part 1068 of this chapter apply to everyone, including anyone who manufactures, remanufactures, imports, maintains, owns, or operates any of the

locomotives subject to this part 1033. See § 1033.601 to determine how to apply the part 1068 regulations for locomotives. Part 1068 of this chapter describes general provisions, including the following areas:

- (1) Prohibited acts and penalties for locomotive manufacturer/remanufacturers and others.
- (2) Exclusions and exemptions for certain locomotives.
- (3) Importing locomotives.
- (4) Selective enforcement audits of your production.
- (5) Defect reporting and recall.
- (6) Procedures for hearings.
- (c) Other parts of this chapter apply if referenced in this part.

Subpart B—Emission Standards and Related Requirements

§ 1033.101 Exhaust emission standards.

See §§ 1033.102 and 1033.150 to determine how the emission standards of this section apply before 2023.

(a) *Emission standards for line-haul locomotives.* Exhaust emissions from your new locomotives may not exceed the applicable emission standards in Table 1 to this section during the useful life of the locomotive. (**Note:** § 1033.901 defines locomotives to be “new” when originally manufactured and when remanufactured.) Measure emissions using the applicable test procedures described in subpart F of this part.

TABLE 1 TO § 1033.101.—LINE-HAUL LOCOMOTIVE EMISSION STANDARDS

Year of original manufacture	Tier of standards	Standards (g/bhp-hr)			
		NO _x	PM	HC	CO
1973–1992 ^a	Tier 0 ^b	8.0	0.22	1.00	5.0
1993 ^a –2004	Tier 1 ^b	7.4	0.22	0.55	2.2
2005–2011	Tier 2 ^b	5.5	^e 0.10	0.30	1.5
2012–2014	Tier 3 ^c	5.5	0.10	0.30	1.5
2015 or later	Tier 4 ^d	1.3	0.03	0.14	1.5

^a Locomotive models that were originally manufactured in model years 1993 through 2001, but that were not originally equipped with a separate coolant system for intake air are subject to the Tier 0 rather than the Tier 1 standards.

^b Line-haul locomotives subject to the Tier 0 through Tier 2 emission standards must also meet switch standards of the same tier.

^c Tier 3 line-haul locomotives must also meet Tier 2 switch standards.

^d Manufacturers may elect to meet a combined NO_x+HC standard of 1.4 g/bhp-hr instead of the otherwise applicable Tier 4 NO_x and HC standards, as described in paragraph (j) of this section.

^e The PM standard for newly remanufactured Tier 2 line-haul locomotives is 0.20 g/bhp-hr until January 1, 2013, except as specified in § 1033.150(a).

(b) *Emission standards for switch locomotives.* Exhaust emissions from your new locomotives may not exceed the applicable emission standards in

Table 2 to this section during the useful life of the locomotive. (**Note:** § 1033.901 defines locomotives to be “new” when originally manufactured and when

remanufactured.) Measure emissions using the applicable test procedures described in subpart F of this part.

TABLE 2 TO § 1033.101.—SWITCH LOCOMOTIVE EMISSION STANDARDS

Year of original manufacture	Tier of standards	Standards (g/bhp-hr)			
		NO _x	PM	HC	CO
1973–2001	Tier 0	11.8	0.26	2.10	8.0
2002–2004	Tier 1 ^a	11.0	0.26	1.20	2.5
2005–2010	Tier 2 ^a	8.1	^b 0.13	0.60	2.4
2011–2014	Tier 3	5.0	0.10	0.60	2.4
2015 or later	Tier 4	^c 1.3	0.03	^c 0.14	2.4

^a Switch locomotives subject to the Tier 1 through Tier 2 emission standards must also meet line-haul standards of the same tier.

^b The PM standard for new Tier 2 switch locomotives is 0.24 g/bhp-hr until January 1, 2013, except as specified in § 1033.150(a).

^c Manufacturers may elect to meet a combined NO_x+HC standard of 1.3 g/bhp-hr instead of the otherwise applicable Tier 4 NO_x and HC standards, as described in paragraph (j) of this section.

(c) *Smoke standards.* The smoke opacity standards specified in Table 3 to this section apply only for locomotives

certified to one or more PM standards or FELs greater than 0.05 g/bhp-hr. Smoke emissions, when measured in

accordance with the provisions of Subpart F of this part, shall not exceed these standards.

TABLE 3 TO § 1033.101.—SMOKE STANDARDS FOR LOCOMOTIVES (PERCENT OPACITY)

	Steady-state	30-sec peak	3-sec peak
Tier 0	30	40	50
Tier 1	25	40	50

TABLE 3 TO § 1033.101.—SMOKE STANDARDS FOR LOCOMOTIVES (PERCENT OPACITY)—Continued

	Steady-state	30-sec peak	3-sec peak
Tier 2 and later	20	40	50

(d) *Averaging, banking, and trading.* You may generate or use emission credits under the averaging, banking, and trading (ABT) program as described in subpart H of this part to comply with the NO_x and/or PM standards of this part. You may also use ABT to comply with the Tier 4 HC standards of this part as described in paragraph (j) of this section. Generating or using emission credits requires that you specify a family emission limit (FEL) for each pollutant you include in the ABT program for each engine family. These FELs serve as the emission standards for the engine family with respect to all required testing instead of the standards specified in paragraphs (a) and (b) of this section. No FEL may be higher than the previously applicable Tier of standards. For example, no FEL for a Tier 1 locomotive may be higher than the Tier 0 standard.

(e) *Notch standards.* (1) Exhaust emissions from locomotives may not exceed the notch standards specified in paragraph (e)(2) of this section, except as allowed in paragraph (e)(3) of this section, when measured using any test procedures under any test conditions.

(2) Except as specified in paragraph (e)(5) of this section, calculate the applicable notch standards for each pollutant for each notch from the certified notch emission rate as follows:
 Notch standard = (E_i) × (1.1 + (1—ELH_i/std))

Where:

E_i = The deteriorated brake-specific emission rate (for pollutant i) for the notch (i.e., the brake-specific emission rate calculated under subpart F of this part, adjusted by the deterioration factor in the application for certification); where i is NO_x, HC, CO or PM.

ELH_i = The deteriorated line-haul duty-cycle weighted brake-specific emission rate for pollutant i, as reported in the application for certification, except as specified in paragraph (e)(6) of this section.

std = The applicable line-haul duty-cycle standard/FEL, except as specified in paragraph (e)(6) of this section.

(3) Exhaust emissions that exceed the notch standards specified in paragraph (e)(2) of this section are allowed only if one of the following is true:

(i) The same emission controls are applied during the test conditions causing the noncompliance as were

applied during certification test conditions (and to the same degree).

(ii) The exceedance result from a design feature that was described (including its effect on emissions) in the approved application for certification, and is:

(A) Necessary for safety;

(B) Addresses infrequent regeneration of an aftertreatment device; or

(C) Otherwise allowed by this part.

(4) Since you are only required to test your locomotive at the highest emitting dynamic brake point, the notch caps that you calculate for the dynamic brake point that you test also apply for other dynamic brake points.

(5) No PM notch caps apply for locomotives certified to a PM standard or FEL of 0.05 g/bhp-hr or lower.

(6) For switch locomotives that are not subject to line-haul standards, ELH_i equals the deteriorated switch duty-cycle weighted brake-specific emission rate for pollutant i and std is the applicable switch cycle standard/FEL.

(f) *Fuels.* The exhaust emission standards in this section apply for locomotives using the fuel type on which the locomotives in the engine family are designed to operate.

(1) You must meet the numerical emission standards for HC in this section based on the following types of hydrocarbon emissions for locomotives powered by the following fuels:

(i) Alcohol-fueled locomotives: THCE emissions for Tier 3 and earlier locomotives and NMHCE for Tier 4.

(ii) Gaseous-fueled locomotives: NMHC emissions.

(iii) Diesel-fueled and other locomotives: THC emissions for Tier 3 and earlier locomotives and NMHC for Tier 4. Note that manufacturers/remanufacturers may choose to not measure NMHC and assume that NMHC is equal to THC multiplied by 0.98 for diesel-fueled locomotives.

(2) You must certify your diesel-fueled locomotives to use the applicable grades of diesel fuel as follows:

(i) Certify your Tier 4 and later diesel-fueled locomotives for operation with only Ultra Low Sulfur Diesel (ULSD) fuel. Use ULSD as the test fuel for these locomotives.

(ii) Certify your Tier 3 and earlier diesel-fueled locomotives for operation with only ULSD fuel if they include sulfur-sensitive technology and you

demonstrate compliance using a ULSD test fuel.

(iii) Certify your Tier 3 and earlier diesel-fueled locomotives for operation with either ULSD fuel or Low Sulfur Diesel (LSD) fuel if they do not include sulfur-sensitive technology or if you demonstrate compliance using an LSD test fuel (including commercial LSD fuel).

(iv) For Tier 1 and earlier diesel-fueled locomotives, if you demonstrate compliance using a ULSD test fuel, you must adjust the measured PM emissions upward by 0.01 g/bhp-hr to make them equivalent to tests with LSD. We will not apply this adjustment for our testing.

(g) *Useful life.* The emission standards and requirements in this subpart apply to the emissions from new locomotives for their useful life. The useful life is generally specified as MW-hrs and years, and ends when either of the values (MW-hrs or years) is exceeded or the locomotive is remanufactured.

(1) The minimum useful life in terms of MW-hrs is equal to the product of the rated horsepower multiplied by 7.50. The minimum useful life in terms of years is ten years. For locomotives originally manufactured before January 1, 2000 and not equipped with MW-hr meters, the minimum useful life is equal to 750,000 miles or ten years, whichever is reached first. See (1033.140 for provisions related to rated power.

(2) You must specify a longer useful life if the locomotive or locomotive engine is designed to last longer than the applicable minimum useful life. Recommending a time to remanufacture that is longer than the minimum useful life is one indicator of a longer design life.

(3) Manufacturers/remanufacturers of locomotives with non-locomotive-specific engines (as defined in (1033.901) may ask us (before certification) to allow a shorter useful life for an engine family containing only non-locomotive-specific engines. We may approve a shorter useful life, in MW-hrs of locomotive operation but not in years, if we determine that these locomotives will rarely operate longer than the shorter useful life. If engines identical to those in the engine family have already been produced and are in use, your demonstration must include documentation from such in-use engines. In other cases, your

demonstration must include an engineering analysis of information equivalent to such in-use data, such as data from research engines or similar engine models that are already in production. Your demonstration must also include any overhaul interval that you recommend, any mechanical warranty that you offer for the engine or its components, and any relevant customer design specifications. Your demonstration may include any other relevant information.

(4) Remanufacturers of locomotive or locomotive engine configurations that have been previously certified under paragraph (g)(3) of this section to a useful life that is shorter than the value specified in paragraph (g)(1) of this section may certify to that same shorter useful life value without request.

(5) In unusual circumstances, you may ask us to allow you to certify some locomotives in your engine family to a partial useful life. This allowance is limited to cases in which some or all of the locomotive(s) power assemblies have been operated previously such that the locomotive will need to be remanufactured prior to the end of the otherwise applicable useful life. Unless we specify otherwise, define the partial useful life based on the total MW-hrs since the last remanufacture to be consistent with other locomotives in the family. For example, this may apply for a previously uncertified locomotive that becomes "new" when it is imported, but that was remanufactured two years earlier (representing 25 percent of the normal useful life period). If such a locomotive could be brought into compliance with the applicable standards without being remanufactured, you may ask to include it in your engine family for the remaining 75 percent of its useful life period.

(h) *Applicability for testing.* The emission standards in this subpart apply to all testing, including certification testing, production-line testing, and in-use testing.

(i) *Alternate CO standards.* Manufacturers/remanufacturers may certify Tier 0, Tier 1, or Tier 2 locomotives to an alternate CO emission standard of 10.0 g/bhp-hr instead of the otherwise applicable CO standard if they also certify those locomotives to alternate PM standards less than or equal to one-half of the otherwise applicable PM standard. For example, a manufacturer certifying Tier 1 locomotives to a 0.11 g/bhp-hr PM standard may certify those locomotives to the alternate CO standard of 10.0 g/bhp-hr.

(j) *Alternate NO_x+HC standards for Tier 4.* Manufacturers/remanufacturers may use credits accumulated through the ABT program to certify Tier 4 locomotives to an alternate NO_x+HC emission standard of 1.4 g/bhp-hr (instead of the otherwise applicable NO_x and NMHC standards). You may use NO_x credits to show compliance with this standard by certifying your family to a NO_x+HC FEL. Calculate the NO_x credits needed as specified in subpart H of this part using the NO_x+HC emission standard and FEL in the calculation instead of the otherwise applicable NO_x standard and FEL. You may not generate credits relative to the alternate standard or certify to the standard without using credits.

(k) *Upgrading.* Upgraded locomotives that were originally manufactured prior to January 1, 1973 are subject to the Tier 0 standards. (See the definition of upgrade in § 1033.901.)

(l) *Other optional standard provisions.* Locomotives may be certified to a higher tier of standards than would otherwise be required. Tier 0 switch locomotives may be certified to both the line-haul and switch cycle standards. In both cases, once the locomotives become subject to the additional standards, they remain subject to those standards for the remainder of their service lives.

§ 1033.102 Transition to the standards of this part.

(a) Except as specified in § 1033.150(a), the Tier 0 and Tier 1 standards of § 1033.101 apply for new locomotives beginning January 1, 2010, except as specified in § 1033.150(a). The Tier 0 and Tier 1 standards of 40 CFR part 92 apply for earlier model years.

(b) Except as specified in § 1033.150(a), the Tier 2 standards of § 1033.101 apply for new locomotives beginning January 1, 2013. The Tier 2 standards of 40 CFR part 92 apply for earlier model years.

(c) The Tier 3 and Tier 4 standards of § 1033.101 apply for the model years specified in that section.

§ 1033.110 Emission diagnostics—general requirements.

The provisions of this section apply if you equip your locomotives with a diagnostic system that will detect significant malfunctions in their emission-control systems and you choose to base your emission-related maintenance instructions on such diagnostics. See § 1033.420 for information about how to select and maintain diagnostic-equipped locomotives for in-use testing. Notify the owner/operator that the presence of

this diagnostic system affects their maintenance obligations under § 1033.815. Except as specified in § 1033.112, this section does not apply for diagnostics that you do not include in your emission-related maintenance instructions. The provisions of this section address diagnostic systems based on malfunction-indicator lights (MILs). You may ask to use other indicators instead of MILs.

(a) The MIL must be readily visible to the operator. When the MIL goes on, it must display "Check Emission Controls" or a similar message that we approve. You may use sound in addition to the light signal.

(b) To ensure that owner/operators consider MIL illumination seriously, you may not illuminate it for malfunctions that would not otherwise require maintenance. This section does not limit your ability to display other indicator lights or messages, as long as they are clearly distinguishable from MILs affecting the owner/operator's maintenance obligations under § 1033.815.

(c) Control when the MIL can go out. If the MIL goes on to show a malfunction, it must remain on during all later engine operation until servicing corrects the malfunction. If the engine is not serviced, but the malfunction does not recur during the next 24 hours, the MIL may stay off during later engine operation.

(d) Record and store in computer memory any diagnostic trouble codes showing a malfunction that should illuminate the MIL. The stored codes must identify the malfunctioning system or component as uniquely as possible. Make these codes available through the data link connector as described in paragraph (e) of this section. You may store codes for conditions that do not turn on the MIL. The system must store a separate code to show when the diagnostic system is disabled (from malfunction or tampering). Provide instructions to the owner/operator regarding how to interpret malfunction codes.

(e) Make data, access codes, and devices accessible. Make all required data accessible to us without any access codes or devices that only you can supply. Ensure that anyone servicing your locomotive can read and understand the diagnostic trouble codes stored in the onboard computer with generic tools and information.

(f) Follow standard references for formats, codes, and connections.

§ 1033.112 Emission diagnostics for SCR systems.

Engines equipped with SCR systems using separate reductant tanks must also meet the requirements of this section in addition to the requirements of § 1033.110. This section does not apply for SCR systems using the engine's fuel as the reductant.

(a) The diagnostic system must monitor reductant quality and tank levels and alert operators to the need to refill the reductant tank before it is empty, or to replace the reductant if it does not meet your concentration specifications. Unless we approve other alerts, use a malfunction-indicator light (MIL) as specified in § 1033.110 and an audible alarm. You do not need to separately monitor reductant quality if you include an exhaust NO_x sensor (or other sensor) that allows you to determine inadequate reductant quality. However, tank level must be monitored in all cases.

(b) Your onboard computer must record in nonvolatile computer memory all incidents of engine operation with inadequate reductant injection or reductant quality. It must record the total amount of operation without adequate reductant. It may total the operation by hours, work, or excess NO_x emissions.

§ 1033.115 Other requirements.

Locomotives that are required to meet the emission standards of this part must meet the requirements of this section. These requirements apply when the locomotive is new (for freshly manufactured or remanufactured locomotives) and continue to apply throughout the useful life.

(a) *Crankcase emissions.* Crankcase emissions may not be discharged directly into the ambient atmosphere from any locomotive, except as follows:

(1) Locomotives may discharge crankcase emissions to the ambient atmosphere if the emissions are added to the exhaust emissions (either physically or mathematically) during all emission testing. If you take advantage of this exception, you must do both of the following things:

(i) Manufacture the locomotives so that all crankcase emissions can be routed into the applicable sampling systems specified in 40 CFR part 1065, consistent with good engineering judgment.

(ii) Account for deterioration in crankcase emissions when determining exhaust deterioration factors.

(2) For purposes of this paragraph (a), crankcase emissions that are routed to the exhaust upstream of exhaust aftertreatment during all operation are

not considered to be discharged directly into the ambient atmosphere.

(b) *Adjustable parameters.* Locomotives that have adjustable parameters must meet all the requirements of this part for any adjustment in the approved adjustable range. You must specify in your application for certification the adjustable range of each adjustable parameter on a new locomotive or new locomotive engine to:

(1) Ensure that safe locomotive operating characteristics are available within that range, as required by section 202(a)(4) of the Clean Air Act (42 U.S.C. 7521(a)(4)), taking into consideration the production tolerances.

(2) Limit the physical range of adjustability to the maximum extent practicable to the range that is necessary for proper operation of the locomotive or locomotive engine.

(c) *Prohibited controls.* You may not design or produce your locomotives with emission control devices, systems, or elements of design that cause or contribute to an unreasonable risk to public health, welfare, or safety while operating. For example, this would apply if the locomotive emits a noxious or toxic substance it would otherwise not emit that contributes to such an unreasonable risk.

(d) *Evaporative and refueling controls.* For locomotives fueled with a volatile fuel you must design and produce them to minimize evaporative emissions during normal operation, including periods when the engine is shut down. You must also design and produce them to minimize the escape of fuel vapors during refueling. Hoses used to refuel gaseous-fueled locomotives may not be designed to be bled or vented to the atmosphere under normal operating conditions. No valves or pressure relief vents may be used on gaseous-fueled locomotives except as emergency safety devices that do not operate at normal system operating flows and pressures.

(e) *Altitude requirements.* All locomotives must be designed to include features that compensate for changes in altitude so that the locomotives will comply with the applicable emission standards when operated at any altitude less than:

(1) 7000 feet above sea level for line-haul locomotives.

(2) 5500 feet above sea level for switch locomotives.

(f) *Defeat devices.* You may not equip your locomotives with a defeat device. A defeat device is an auxiliary emission control device (AECDD) that reduces the effectiveness of emission controls under conditions that the locomotive may

reasonably be expected to encounter during normal operation and use.

(1) This does not apply to AECDDs you identify in your certification application if any of the following is true:

(i) The conditions of concern were substantially included in the applicable duty cycle test procedures described in subpart F of this part.

(ii) You show your design is necessary to prevent locomotive damage or accidents.

(iii) The reduced effectiveness applies only to starting the locomotive.

(iv) The locomotive emissions when the AECDD is functioning are at or below the notch caps of § 1033.101.

(g) *Idle controls.* All new locomotives must be equipped with automatic engine stop/start as described in this paragraph (g). All new locomotives must be designed to allow the engine(s) to be restarted at least six times per day without causing engine damage that would affect the expected interval between remanufacturing. Note that it is a violation of 40 CFR 1068.101(b)(1) to circumvent the provisions of this paragraph (g).

(1) Except as allowed by paragraph (g)(2) of this section, the stop/start systems must shut off the main locomotive engine(s) after 30 minutes of idling (or less).

(2) Stop/start systems may restart or continue idling for the following reasons:

(i) To prevent engine damage such as to prevent the engine coolant from freezing.

(ii) To maintain air pressure for brakes or starter system, or to recharge the locomotive battery.

(iii) To perform necessary maintenance.

(iv) To otherwise comply with federal regulations.

(4) You may ask to use alternate stop/start systems that will achieve equivalent idle control.

(5) See § 1033.201 for provisions that allow you to obtain a separate certificate for idle controls.

(6) It is not considered circumvention to allow a locomotive to idle to heat or cool the cab, provided such heating or cooling is necessary.

(h) *Power meters.* Tier 1 and later locomotives must be equipped with MW-hr meters (or the equivalent) consistent with the specifications of § 1033.140.

§ 1033.120 Emission-related warranty requirements.

(a) *General requirements.*

Manufacturers/remanufacturers must warrant to the ultimate purchaser and each subsequent purchaser that the new

locomotive, including all parts of its emission control system, meets two conditions:

(1) It is designed, built, and equipped so it conforms at the time of sale to the ultimate purchaser with the requirements of this part.

(2) It is free from defects in materials and workmanship that may keep it from meeting these requirements.

(b) *Warranty period.* Except as specified in this paragraph, the minimum warranty period is one-third of the useful life. Your emission-related warranty must be valid for at least as long as the minimum warranty periods listed in this paragraph (b) in MW-hrs of operation and years, whichever comes first. You may offer an emission-related warranty more generous than we require. The emission-related warranty for the locomotive may not be shorter than any published warranty you offer without charge for the locomotive. Similarly, the emission-related warranty for any component may not be shorter than any published warranty you offer without charge for that component. If you provide an extended warranty to individual owners for any components covered in paragraph (c) of this section for an additional charge, your emission-related warranty must cover those components for those owners to the same degree. If the locomotive does not record MW-hrs, we base the warranty periods in this paragraph (b) only on years. The warranty period begins when the locomotive is placed into service, or back into service after remanufacture.

(c) *Components covered.* The emission-related warranty covers all components whose failure would increase a locomotive's emissions of any pollutant. This includes components listed in 40 CFR part 1068, Appendix I, and components from any other system you develop to control emissions. The emission-related warranty covers the components you sell even if another company produces the component. Your emission-related warranty does not cover components whose failure would not increase a locomotive's emissions of any pollutant. For remanufactured locomotives, your emission-related warranty does not cover used parts that are not replaced during the remanufacture.

(d) *Limited applicability.* You may deny warranty claims under this section if the operator caused the problem through improper maintenance or use, as described in 40 CFR 1068.115.

(e) *Owners manual.* Describe in the owners manual the emission-related warranty provisions from this section that apply to the locomotive.

§ 1033.125 Maintenance instructions.

Give the owner of each new locomotive written instructions for properly maintaining and using the locomotive, including the emission-control system. Include in the instructions a notification that owners and operators must comply with the requirements of subpart I of this part 1033. The emission-related maintenance instructions also apply to any service accumulation on your emission-data locomotives, as described in § 1033.245 and in 40 CFR part 1065. If you equip your locomotives with a diagnostic system that will detect significant malfunctions in their emission-control systems, specify the extent to which your emission-related maintenance instructions include such diagnostics.

§ 1033.130 Instructions for engine remanufacturing or engine installation.

(a) If you do not complete assembly of the new locomotive (such as selling a kit that allows someone else to remanufacture a locomotive under your certificate), give the assembler instructions for completing assembly consistent with the requirements of this part. Include all information necessary to ensure that the locomotive will be assembled in its certified configuration.

(b) Make sure these instructions have the following information:

(1) Include the heading: "Emission-related assembly instructions".

(2) Describe any instructions necessary to make sure the assembled locomotive will operate according to design specifications in your application for certification.

(3) Describe how to properly label the locomotive. This will generally include instructions to remove and destroy the previous Engine Emission Control Information label.

(4) State one of the following as applicable:

(i) "Failing to follow these instructions when remanufacturing a locomotive or locomotive engine violates federal law (40 CFR 1068.105(b)), and may subject you to fines or other penalties as described in the Clean Air Act."

(ii) "Failing to follow these instructions when installing this locomotive engine violates federal law (40 CFR 1068.105(b)), and may subject you to fines or other penalties as described in the Clean Air Act."

(c) You do not need installation instructions for locomotives you assemble.

(d) Provide instructions in writing or in an equivalent format. For example, you may post instructions on a publicly available Web site for downloading or

printing. If you do not provide the instructions in writing, explain in your application for certification how you will ensure that each assembler is informed of the assembly requirements.

(e) Your emission-related assembly instructions may not include specifications for parts unrelated to emissions. For the basic mechanical parts listed in this paragraph (e), you may not specify a part manufacturer unless we determine that such a specification is necessary. You may include design specifications for such parts addressing the dimensions and material constraints as necessary. You may also specify a part number, as long you make it clear that alternate part suppliers may be used. This paragraph (e) covers the following parts or other parts we determine qualify as basic mechanical parts:

- (1) Intake and exhaust valves.
- (2) Intake and exhaust valve retainers.
- (3) Intake and exhaust valve springs.
- (4) Intake and exhaust valve rotators.
- (5) Oil coolers.

§ 1033.135 Labeling.

As described in this section, each locomotive must have a label on the locomotive and a separate label on the engine. The label on the locomotive stays on the locomotive throughout its service life. It generally identifies the original certification of the locomotive, which is when it was originally manufactured for Tier 1 and later locomotives. The label on the engine is replaced each time the locomotive is remanufactured and identifies the most recent certification.

(a) *Serial numbers.* At the point of original manufacture, assign each locomotive and each locomotive engine a serial number or other unique identification number and permanently affix, engrave, or stamp the number on the locomotive and engine in a legible way.

(b) *Locomotive labels.* (1) Locomotive labels meeting the specifications of paragraph (b)(2) of this section must be applied as follows:

(i) The manufacturer must apply a locomotive label at the point of original manufacture.

(ii) The remanufacturer must apply a locomotive label at the point of original remanufacture, unless the locomotive was labeled by the original manufacturer.

(iii) Any remanufacturer certifying a locomotive to an FEL or standard different from the previous FEL or standard to which the locomotive was previously certified must apply a locomotive label.

(2) The locomotive label must meet all of the following criteria:

(i) The label must be permanent and legible and affixed to the locomotive in a position in which it will remain readily visible. Attach it to a locomotive chassis part necessary for normal operation and not normally requiring replacement during the service life of the locomotive. You may not attach this label to the engine or to any equipment that is easily detached from the locomotive. Attach the label so that it cannot be removed without destroying or defacing the label. For Tier 0 locomotives, the label may be made up of more than one piece, as long as all pieces are permanently attached to the locomotive.

(ii) The label must be lettered in the English language using a color that contrasts with the background of the label.

(iii) The label must include all the following information:

(A) The label heading: "ORIGINAL LOCOMOTIVE EMISSION CONTROL INFORMATION." Manufacturers/remanufacturers may add a subheading to distinguish this label from the engine label described in paragraph (c) of this section.

(B) Full corporate name and trademark of the manufacturer (or remanufacturer).

(C) The applicable engine family and configuration identification. In the case of locomotive labels applied by the manufacturer at the point of original manufacture, this will be the engine family and configuration identification of the certificate applicable to the freshly manufactured locomotive. In the case of locomotive labels applied by a remanufacturer during remanufacture, this will be the engine family and configuration identification of the certificate under which the remanufacture is being performed.

(D) Date of original manufacture of the locomotive, as defined in § 1033.901.

(E) The standards/FELs to which the locomotive was certified and the following statement: "THIS LOCOMOTIVE MUST COMPLY WITH THESE EMISSION LEVELS EACH TIME THAT IT IS REMANUFACTURED, EXCEPT AS ALLOWED BY 40 CFR 1033.750."

(3) Label diesel-fueled locomotives near the fuel inlet to identify the allowable fuels, consistent with § 1033.101. For example, Tier 4 locomotives should be labeled "ULTRA LOW SULFUR DIESEL FUEL ONLY". You do not need to label Tier 3 and earlier locomotives certified for use with both LSD and ULSL.

(c) *Engine labels.* (1) For engines not requiring aftertreatment devices, apply engine labels meeting the specifications

of paragraph (c)(2) of this section once an engine has been assembled in its certified configuration. For engines that require aftertreatment devices, apply the label after the engine has been fully assembled, which may occur before installing the aftertreatment devices. These labels must be applied by:

(i) The manufacturer at the point of original manufacture; and

(ii) The manufacturer at the point of each remanufacture (including the original remanufacture and subsequent remanufactures).

(2) The engine label must meet all of the following criteria:

(i) The label must be durable throughout the useful life of the engine, be legible and affixed to the engine in a position in which it will be readily visible after installation of the engine in the locomotive. Attach it to an engine part necessary for normal operation and not normally requiring replacement during the useful life of the locomotive. You may not attach this label to any equipment that is easily detached from the engine. Attach the label so it cannot be removed without destroying or defacing the label. The label may be made up of more than one piece, as long as all pieces are permanently attached to the same engine part.

(ii) The label must be lettered in the English language using a color that contrasts with the background of the label.

(iii) The label must include all the following information:

(A) The label heading: "ENGINE EMISSION CONTROL INFORMATION." Manufacturers/remanufacturers may add a subheading to distinguish this label from the locomotive label described in paragraph (b) of this section.

(B) Full corporate name and trademark of the manufacturer/remanufacturer.

(C) Engine family and configuration identification as specified in the certificate under which the locomotive is being manufactured or remanufactured.

(D) A prominent unconditional statement of compliance with U.S. Environmental Protection Agency regulations which apply to locomotives, as applicable:

(1) "This locomotive conforms to U.S. EPA regulations applicable to Tier 0+ switch locomotives."

(2) "This locomotive conforms to U.S. EPA regulations applicable to Tier 0+ line-haul locomotives."

(3) "This locomotive conforms to U.S. EPA regulations applicable to Tier 1+ locomotives."

(4) "This locomotive conforms to U.S. EPA regulations applicable to Tier 2+ locomotives."

(5) "This locomotive conforms to U.S. EPA regulations applicable to Tier 3 switch locomotives."

(6) "This locomotive conforms to U.S. EPA regulations applicable to Tier 3 line-haul locomotives."

(7) "This locomotive conforms to U.S. EPA regulations applicable to Tier 4 switch locomotives."

(8) "This locomotive conforms to U.S. EPA regulations applicable to Tier 4 line-haul locomotives."

(E) The useful life of the locomotive.

(F) The standards/FELs to which the locomotive was certified.

(iv) You may include other critical operating instructions such as specifications for adjustments or reductant use for SCR systems.

(d) You may add information to the emission control information label as follows:

(1) You may identify other emission standards that the engine/locomotive meets or does not meet (such as international standards). You may include this information by adding it to the statement we specify or by including a separate statement.

(2) You may add other information to ensure that the locomotive will be properly maintained and used.

(3) You may add appropriate features to prevent counterfeit labels. For example, you may include the engine's unique identification number on the label.

(e) You may ask us to approve modified labeling requirements in this part 1033 if you show that it is necessary or appropriate. We will approve your request if your alternate label is consistent with the requirements of this part.

§ 1033.140 Rated power.

This section describes how to determine the rated power of a locomotive for the purposes of this part.

(a) A locomotive configuration's rated power is the maximum brake power point on the nominal power curve for the locomotive configuration, as defined in this section. See § 1033.901 for the definition of brake power. Round the power value to the nearest whole horsepower. Generally, this will be the brake power of the engine in notch 8.

(b) The nominal power curve of a locomotive configuration is its maximum available brake power at each possible operator demand setpoint or "notch". See 40 CFR 1065.1001 for the definition of operator demand. The maximum available power at each operator demand setpoint is based on

your design and production specifications for that locomotive. The nominal power curve does not include any operator demand setpoints that are not achievable during in-use operation. For example, for a locomotive with only eight discrete operator demand setpoints, or notches, the nominal power curve would be a series of eight power points versus notch, rather than a continuous curve.

(c) The nominal power curve must be within the range of the actual power curves of production locomotives considering normal production variability. If after production begins it is determined that your nominal power curve does not represent production locomotives, we may require you to amend your application for certification under § 1033.225.

(d) For the purpose of determining useful life, you may need to use a rated power based on power other than brake power according to the provisions of this paragraph (d). The useful life must be based on the power measured by the locomotive's megawatt-hour meter. For example, if your megawatt-hour meter reads and records the electrical work output of the alternator/generator rather than the brake power of the engine, and the power output of the alternator/generator at notch 8 is 4000 horsepower, calculate your useful life as 30,000 MW-hrs (7.5×4000).

§ 1033.150 Interim provisions.

The provisions of this section apply instead of other provisions of this part for a limited time. This section describes when these provisions apply.

(a) *Early availability of Tier 0, Tier 1, or Tier 2 systems.* Except as specified in paragraph (a)(2) of this section, for model years 2008 and 2009, you may remanufacture locomotives to meet the applicable standards in 40 CFR part 92 only if no remanufacture system has been certified to meet the standards of this part and is available at a reasonable cost at least 90 days prior to the completion of the remanufacture as specified in paragraph (a)(3) of this section. This same provision continues to apply after 2009, but only for Tier 2 locomotives. Note that remanufacturers may certify remanufacturing systems that will not be available at a reasonable cost; however such certification does not trigger the requirements of this paragraph (a).

(1) For the purpose of this paragraph (a), "available at a reasonable cost" means available for use where all of the following are true:

(i) The total incremental cost to the owner and operators of the locomotive due to meeting the new standards

(including initial hardware, increased fuel consumption, and increased maintenance costs) during the useful life of the locomotive is less than \$250,000, adjusted as specified in paragraph (a)(4)(i) of this section.

(ii) The initial incremental hardware costs are reasonably related to the technology included in the remanufacturing system and are less than \$125,000, adjusted as specified in paragraph (a)(4)(i) of this section.

(iii) The remanufactured locomotive will have reliability throughout its useful life that is similar to the reliability the locomotive would have had if it had been remanufactured without the certified remanufacture system.

(iv) The remanufacturer must demonstrate at the time of certification that the system meets the requirements of this paragraph (a)(1).

(v) The system does not generate or use emission credits.

(2) The number of locomotives that each railroad must remanufacture under this paragraph (a) is capped as follows:

(i) For the period October 3, 2008 to December 31, 2008, the maximum number of locomotives that a railroad must remanufacture under this paragraph (a) is 50 percent of the total number of the railroad's locomotives that are remanufactured during this period under this part or 40 CFR part 92. Include in the calculation both locomotives you own and locomotives you lease.

(ii) For the period January 1, 2009 to December 31, 2009, the maximum number of locomotives that a railroad must remanufacture under this paragraph (a) is 70 percent of the total number of the railroad's locomotives that are remanufactured during this period under this part or 40 CFR part 92. Include in the calculation both locomotives you own and locomotives you lease.

(3) Remanufacturers applying for certificates under this paragraph (a) are responsible to notify owner/operators (and other customers as applicable) that they have requested such certificates. The notification should occur at the same time that the remanufacturer submits its application, and should include a description of the remanufacturing system, price, expected incremental operating costs, and draft copies of your installation and maintenance instructions. The system is considered to be available for a customer 120 days after this notification, or 90 days after the certificate is issued, whichever is later. Where we issue a certificate of conformity under this part based on

carryover data from an engine family that we previously considered available for the configuration, the system is considered to be available when we issue the certificate.

(4) Estimate costs as described in this paragraph (a)(4).

(i) The cost limits described in paragraph (a)(1) of this section are specified in terms of 2007 dollars. Adjust these values for future years according to the following equation:

$$\text{Actual Limit} = (2007 \text{ Limit}) \times [(0.6000) \times (\text{Commodity Index}) + (0.4000) \times (\text{Earnings Index})]$$

Where:

2007 Limit = The value specified in paragraph (a)(1) of this section (\$250,000 or \$125,000).

Commodity Index = The U.S. Bureau of Labor Statistics Producer Price Index for Industrial Commodities Less Fuel (Series WPU03T15M05) for the month prior to the date you submit your application divided by 173.1.

Earnings Index = The U.S. Bureau of Labor Statistics Estimated Average Hourly Earnings of Production Workers for Durable Manufacturing (Series CES3100000008) for the month prior to the date you submit your application divided by 18.26.

(ii) Calculate all costs in current dollars (for the month prior to the date you submit your application). Calculate fuel costs based on a fuel price adjusted by the Association of American Railroads' monthly railroad fuel price index (P), which is available at <https://www.aar.org/PubCommon/Documents/AboutTheIndustry/IndexMonthlyFuelPrices.pdf>. (Use the value for the column in which P equals 539.8 for November 2007.) Calculate a new fuel price using the following equation:

$$\text{Fuel Price} = (\$2.76 \text{ per gallon}) \times (P/539.8)$$

(b) *Idle controls.* A locomotive equipped with an automatic engine stop/start system that was originally installed before January 1, 2008 and that conforms to the requirements of § 1033.115(g) is deemed to be covered by a certificate of conformity with respect to the requirements of § 1033.115(g). Note that the provisions of subpart C of this part also allow you to apply for a conventional certificate of conformity for such systems.

(c) *Locomotive labels for transition to new standards.* This paragraph (c) applies when you remanufacture a locomotive that was previously certified under 40 CFR part 92. You must remove the old locomotive label and replace it with the locomotive label specified in § 1033.135.

(d) *Small manufacturer/remanufacturer provisions.* The

production-line testing requirements and in-use testing requirements of this part do not apply until January 1, 2013 for manufacturers/remanufacturers that qualify as small manufacturers under § 1033.901.

(e) *Producing switch locomotives using certified nonroad engines.* You may use the provisions of this paragraph (e) to produce any number of freshly manufactured or refurbished switch locomotives in model years 2008 through 2017. Locomotives produced under this paragraph (e) are exempt from the standards and requirements of this part and 40 CFR part 92 subject to the following provisions:

(1) All of the engines on the switch locomotive must be covered by a certificate of conformity issued under 40 CFR part 89 or 1039 for model year 2008

or later. Engines over 750 hp certified to the Tier 4 standards for non-generator set engines are not eligible for this allowance after 2014.

(2) You must reasonably project that more of the engines will be sold and used for non-locomotive use than for use in locomotives.

(3) You may not generate or use locomotive credits under this part for these locomotives.

(4) Include the following statement on a permanent locomotive label: "THIS LOCOMOTIVE WAS CERTIFIED UNDER 40 CFR 1033.150(e). THE ENGINES USED IN THIS LOCOMOTIVE ARE SUBJECT TO REQUIREMENTS OF 40 CFR PARTS 1039 (or 89) AND 1068."

(5) The rebuilding requirements of 40 CFR part 1068 apply when remanufacturing engines used in these locomotives.

(f) *In-use compliance limits.* For purposes of determining compliance other than for certification or production-line testing, calculate the applicable in-use compliance limits by adjusting the applicable standards/FELs. The PM adjustment applies only for model year 2017 and earlier locomotives and does not apply for locomotives with a PM FEL higher than 0.03 g/bhp-hr. The NO_x adjustment applies only for model year 2017 and earlier locomotives and does not apply for locomotives with a NO_x FEL higher than 2.0 g/bhp-hr. Add the applicable adjustments in Tables 1 or 2 of this section (which follow) to the otherwise applicable standards (or FELs) and notch caps. You must specify during certification which add-ons, if any, will apply for your locomotives.

TABLE 1 TO § 1033.150.—IN-USE ADJUSTMENTS FOR TIER 4 LOCOMOTIVES

Fraction of useful life already used	In-use adjustments (g/bhp-hr)	
	For model year 2017 and earlier Tier 4 NO _x standards	For model year 2017 and earlier Tier 4 PM standards
0 < MW-hrs ≤ 50% of UL	0.7	0.01
50 < MW-hrs > 75% of UL	1.0	0.01
MW-hrs > 75% of UL	1.3	0.01

TABLE 2 TO § 1033.150.—OPTIONAL IN-USE ADJUSTMENTS FOR TIER 4 LOCOMOTIVES

Fraction of useful life already used	In-use adjustments (g/bhp-hr)	
	For model year 2017 and earlier Tier 4 NO _x standards	For model year 2017 and earlier Tier 4 PM standards
0 < MW-hrs ≤ 50% of UL	0.2	0.03
50 < MW-hrs ≤ 75% of UL	0.3	0.03
MW-hrs > 75% of UL	0.4	0.03

(g) Optional interim Tier 4 compliance provisions for NO_x emissions. For model years 2015 through 2022, manufacturers may choose to certify some or all of their Tier 4 line-haul engine families according to the optional compliance provisions of this paragraph (g). The following provisions apply to all locomotives in those families:

(1) The provisions of this paragraph (g) apply instead of the deterioration factor requirements of §§ 1033.240 and 1033.245 for NO_x emissions. You must certify that the locomotives in the engine family will conform to the requirements of this paragraph (g) for their full useful lives.

(2) The applicable NO_x emission standard for locomotives certified under this paragraph (g) is:

(i) 1.3 g/bhp-hr for locomotives that have accumulated less than 50 hours of operation.

(ii) 1.3 plus 0.6 g/bhp-hr for locomotives that have accumulated 50 hours or more of operation.

(3) The engine family may not generate NO_x emission credits.

(4) The design certification provisions of § 1033.240(c) do not apply for these locomotives for the next remanufacture.

(5) Manufacturers must comply with the production-line testing program in subpart D of this part for these engine families or the following optional program:

(i) You are not required to test locomotives in the family under subpart D of this part if you comply with the requirements of this paragraph (g)(5).

(ii) Test the locomotives as specified in subpart E of this part, with the following exceptions:

(A) The minimum test sample size is one percent of the number of locomotives in the family or five, whichever is less.

(B) The locomotives must be tested after they have accumulated 50 hours or more of operation but before they have reached 50 percent of their useful life.

(iii) The standards in this part for pollutants other than NO_x apply as specified for testing conducted under this optional program.

(6) The engine family may use NO_x emission credits to comply with this paragraph (g). However, a 1.5 g/bhp-hr NO_x FEL cap applies for engine families certified under this paragraph (g). The applicable standard for locomotives that

have accumulated 50 hours or more of operation is the FEL plus 0.6 g/bhp-hr.

(7) The in-use NO_x add-ons specified in paragraph (f) of this section do not apply for these locomotives.

(8) All other provisions of this part apply to such locomotives, except as specified otherwise in this paragraph (g).

(h) *Test procedures.* You are generally required to use the test procedures specified in subpart F of this part (including the applicable test procedures in 40 CFR part 1065). As specified in this paragraph (h), you may use a combination of the test procedures specified in this part and the test procedures specified in 40 CFR part 92 prior to January 1, 2015. After this date, you must use only the test procedures specified in this part.

(1) Prior to January 1, 2015, you may ask to use some or all of the procedures specified in 40 CFR part 92 for locomotives certified under this part 1033.

(2) If you ask to rely on a combination of procedures under this paragraph (h), we will approve your request only if you show us that it does not affect your ability to demonstrate compliance with the applicable emission standards. Generally this requires that the combined procedures would result in emission measurements at least as high as those that would be measured using the procedures specified in this part. Alternatively, you may demonstrate that the combined effects of the different procedures is small relative to your compliance margin (the degree to which your emissions are below the applicable standards).

(i) *Certification testing.* Prior to model year 2014, you may use the simplified steady-state engine test procedure specified in this paragraph (i) for certification testing. The normal certification procedures and engine testing procedures apply, except as specified in this paragraph (i).

(1) Use good engineering judgment to operate the engine consistent with its expected operation in the locomotive, to the extent practical. You are not required to exactly replicate the transient behavior of the engine.

(2) You may delay sampling during notch transition for up to 20 seconds after you begin the notch change.

(3) We may require you provide additional information in your application for certification to support the expectation that production locomotives will meet all applicable emission standards when tested as locomotives.

(4) You may not use this simplified procedure for production-line or in-use testing.

(j) *Administrative requirements.* For model years 2008 and 2009, you may use a combination of the administrative procedures specified in this part and the test procedures specified in 40 CFR part 92. For example, this would allow you to use the certification procedures of 40 CFR part 92 to apply for certificates under this part 1033.

(k) *Test fuels.* Testing performed during calendar years 2008 and 2009 may be performed using test fuels that meet the specifications of 40 CFR 92.113. If you do, adjust PM emissions downward by 0.04 g/bhp-hr to account for the difference in sulfur content of the fuel.

(1) *Refurbished switch locomotives.* In 2008 and 2009 remanufactured Tier 0 switch locomotives that are deemed to be refurbished may be certified as remanufactured switch locomotives under 40 CFR part 92.

Subpart C—Certifying Engine Families

§ 1033.201 General requirements for obtaining a certificate of conformity.

Certification is the process by which you demonstrate to us that your freshly manufactured or remanufactured locomotives will meet the applicable emission standards throughout their useful lives (explaining to us how you plan to manufacture or remanufacture locomotives, and providing test data showing that such locomotives will comply with all applicable emission standards). Anyone meeting the definition of manufacturer in § 1033.901 may apply for a certificate of conformity for freshly manufactured locomotives. Anyone meeting the definition of remanufacturer in § 1033.901 may apply for a certificate of conformity for remanufactured locomotives.

(a) You must send us a separate application for a certificate of conformity for each engine family. A certificate of conformity is valid starting with the indicated effective date, but it is not valid for any production after December 31 of the model year for which it is issued. No certificate will be issued after December 31 of the model year.

(b) The application must contain all the information required by this part and must not include false or incomplete statements or information (see § 1033.255).

(c) We may ask you to include less information than we specify in this subpart, as long as you maintain all the information required by § 1033.250.

(d) You must use good engineering judgment for all decisions related to your application (see 40 CFR 1068.5).

(e) An authorized representative of your company must approve and sign the application.

(f) See § 1033.255 for provisions describing how we will process your application.

(g) We may require you to deliver your test locomotives to a facility we designate for our testing (see § 1033.235(c)).

(h) By applying for a certificate of conformity, you are accepting responsibility for the in-use emission performance of all properly maintained and used locomotives covered by your certificate. This responsibility applies without regard to whether you physically manufacture or remanufacture the entire locomotive. If you do not physically manufacture or remanufacture the entire locomotive, you must take reasonable steps (including those specified by this part) to ensure that the locomotives produced under your certificate conform to the specifications of your application for certification. Note that this paragraph does not limit any liability under this part or the Clean Air Act for entities that do not obtain certificates. This paragraph also does not prohibit you from making contractual arrangements with noncertifiers related to recovering damages for noncompliance.

(i) The provisions of this subpart describe how to obtain a certificate that covers all standards and requirements. Manufacturer/remanufacturers may ask to obtain a certificate of conformity that does not cover the idle control requirements of § 1033.115 or one that only covers the idle control requirements of § 1033.115. Remanufacturers obtaining such partial certificates must include a statement in their installation instructions that two certificates and labels are required for a locomotive to be in a fully certified configuration. We may modify the certification requirements for certificates that will only cover idle control systems.

§ 1033.205 Applying for a certificate of conformity.

(a) Send the Designated Compliance Officer a complete application for each engine family for which you are requesting a certificate of conformity.

(b) The application must be approved and signed by the authorized representative of your company.

(c) You must update and correct your application to accurately reflect your production, as described in § 1033.225.

(d) Include the following information in your application:

(1) A description of the basic engine design including, but not limited to, the engine family specifications listed in § 1033.230. For freshly manufactured locomotives, a description of the basic locomotive design. For remanufactured locomotives, a description of the basic locomotive designs to which the remanufacture system will be applied. Include in your description, a list of distinguishable configurations to be included in the engine family. Note whether you are requesting a certificate that will or will not cover idle controls.

(2) An explanation of how the emission control system operates, including detailed descriptions of:

(i) All emission control system components.

(ii) Injection or ignition timing for each notch (i.e., degrees before or after top-dead-center), and any functional dependence of such timing on other operational parameters (e.g., engine coolant temperature).

(iii) Each auxiliary emission control device (AECD).

(iv) All fuel system components to be installed on any production or test locomotives.

(v) Diagnostics.

(3) A description of the test locomotive.

(4) A description of the test equipment and fuel used. Identify any special or alternate test procedures you used.

(5) A description of the operating cycle and the period of operation necessary to accumulate service hours on the test locomotive and stabilize emission levels. You may also include a Green Engine Factor that would adjust emissions from zero-hour engines to be equivalent to stabilized engines.

(6) A description of all adjustable operating parameters (including, but not limited to, injection timing and fuel rate), including the following:

(i) The nominal or recommended setting and the associated production tolerances.

(ii) The intended adjustable range, and the physically adjustable range.

(iii) The limits or stops used to limit adjustable ranges.

(iv) Production tolerances of the limits or stops used to establish each physically adjustable range.

(v) Information relating to why the physical limits or stops used to establish the physically adjustable range of each parameter, or any other means used to inhibit adjustment, are the most effective means possible of preventing adjustment of parameters to settings outside your specified adjustable ranges on in-use engines.

(7) Projected U.S. production information for each configuration. If you are projecting substantially different sales of a configuration than you had previously, we may require you to explain why you are projecting the change.

(8) All test data you obtained for each test engine or locomotive. As described in § 1033.235, we may allow you to demonstrate compliance based on results from previous emission tests, development tests, or other testing information. Include data for NO_x, PM, HC, CO, and CO₂.

(9) The intended deterioration factors for the engine family, in accordance with § 1033.245. If the deterioration factors for the engine family were developed using procedures that we have not previously approved, you should request preliminary approval under § 1033.210.

(10) The intended useful life period for the engine family, in accordance with § 1033.101(g). If the useful life for the engine family was determined using procedures that we have not previously approved, you should request preliminary approval under § 1033.210.

(11) Copies of your proposed emission control label(s), maintenance instructions, and installation instructions (where applicable).

(12) An unconditional statement declaring that all locomotives included in the engine family comply with all requirements of this part and the Clean Air Act.

(e) If we request it, you must supply such additional information as may be required to evaluate the application.

(f) Provide the information to read, record, and interpret all the information broadcast by a locomotive's onboard computers and electronic control units. State that, upon request, you will give us any hardware, software, or tools we would need to do this. You may reference any appropriate publicly released standards that define conventions for these messages and parameters. Format your information consistent with publicly released standards.

(g) Include the information required by other subparts of this part. For example, include the information required by § 1033.725 if you participate in the ABT program.

(h) Include other applicable information, such as information specified in this part or part 1068 of this chapter related to requests for exemptions.

(i) Name an agent for service located in the United States. Service on this agent constitutes service on you or any of your officers or employees for any

action by EPA or otherwise by the United States related to the requirements of this part.

(j) For imported locomotives, we may require you to describe your expected importation process.

§ 1033.210 Preliminary approval.

(a) If you send us information before you finish the application, we will review it and make any appropriate determinations for questions related to engine family definitions, auxiliary emission-control devices, deterioration factors, testing for service accumulation, maintenance, and useful lives.

(b) Decisions made under this section are considered to be preliminary approval, subject to final review and approval. We will generally not reverse a decision where we have given you preliminary approval, unless we find new information supporting a different decision.

(c) If you request preliminary approval related to the upcoming model year or the model year after that, we will make best-efforts to make the appropriate determinations as soon as practicable. We will generally not provide preliminary approval related to a future model year more than three years ahead of time.

(d) You must obtain preliminary approval for your plan to develop deterioration factors prior to the start of any service accumulation to be used to develop the factors.

§ 1033.220 Amending maintenance instructions.

You may amend your emission-related maintenance instructions after you submit your application for certification, as long as the amended instructions remain consistent with the provisions of § 1033.125. You must send the Designated Compliance Officer a request to amend your application for certification for an engine family if you want to change the emission-related maintenance instructions in a way that could affect emissions. In your request, describe the proposed changes to the maintenance instructions. We will approve your request if we determine that the amended instructions are consistent with maintenance you performed on emission-data engines such that your durability demonstration would remain valid. If owners/operators follow the original maintenance instructions rather than the newly specified maintenance, this does not allow you to disqualify those locomotives from in-use testing or deny a warranty claim.

(a) If you are decreasing, replacing, or eliminating any of the specified

maintenance, you may distribute the new maintenance instructions to your customers 30 days after we receive your request, unless we disapprove your request. This would generally include replacing one maintenance step with another. We may approve a shorter time or waive this requirement.

(b) If your requested change would not decrease the specified maintenance, you may distribute the new maintenance instructions anytime after you send your request. For example, this paragraph (b) would cover adding instructions to increase the frequency of filter changes for locomotives in severe-duty applications.

(c) You do not need to request approval if you are making only minor corrections (such as correcting typographical mistakes), clarifying your maintenance instructions, or changing instructions for maintenance unrelated to emission control. We may ask you to send us copies of maintenance instructions revised under this paragraph (c).

§ 1033.225 Amending applications for certification.

Before we issue you a certificate of conformity, you may amend your application to include new or modified locomotive configurations, subject to the provisions of this section. After we have issued your certificate of conformity, you may send us an amended application requesting that we include new or modified locomotive configurations within the scope of the certificate, subject to the provisions of this section. You must also amend your application if any changes occur with respect to any information included in your application. For example, you must amend your application if you determine that your actual production variation for an adjustable parameter exceeds the tolerances specified in your application.

(a) You must amend your application before you take either of the following actions:

(1) Add a locomotive configuration to an engine family. In this case, the locomotive added must be consistent with other locomotives in the engine family with respect to the criteria listed in § 1033.230. For example, you must amend your application if you want to produce 12-cylinder versions of the 16-cylinder locomotives you described in your application.

(2) Change a locomotive already included in an engine family in a way that may affect emissions, or change any of the components you described in your application for certification. This includes production and design changes

that may affect emissions any time during the locomotive's lifetime. For example, you must amend your application if you want to change a part supplier if the part was described in your original application and is different in any material respect than the part you described.

(3) Modify an FEL for an engine family as described in paragraph (f) of this section.

(b) To amend your application for certification, send the Designated Compliance Officer the following information:

(1) Describe in detail the addition or change in the locomotive model or configuration you intend to make.

(2) Include engineering evaluations or data showing that the amended engine family complies with all applicable requirements. You may do this by showing that the original emission-data locomotive is still appropriate with respect to showing compliance of the amended family with all applicable requirements.

(3) If the original emission-data locomotive for the engine family is not appropriate to show compliance for the new or modified locomotive, include new test data showing that the new or modified locomotive meets the requirements of this part.

(c) We may ask for more test data or engineering evaluations. You must give us these within 30 days after we request them.

(d) For engine families already covered by a certificate of conformity, we will determine whether the existing certificate of conformity covers your new or modified locomotive. You may ask for a hearing if we deny your request (see § 1033.920).

(e) For engine families already covered by a certificate of conformity, you may start producing the new or modified locomotive anytime after you send us your amended application, before we make a decision under paragraph (d) of this section. However, if we determine that the affected locomotives do not meet applicable requirements, we will notify you to cease production of the locomotives and may require you to recall the locomotives at no expense to the owner. Choosing to produce locomotives under this paragraph (e) is deemed to be consent to recall all locomotives that we determine do not meet applicable emission standards or other requirements and to remedy the nonconformity at no expense to the owner. If you do not provide information required under paragraph (c) of this section within 30 days, you

must stop producing the new or modified locomotives.

(f) You may ask us to approve a change to your FEL in certain cases after the start of production. The changed FEL may not apply to locomotives you have already introduced into U.S. commerce, except as described in this paragraph (f). If we approve a changed FEL after the start of production, you must include the new FEL on the emission control information label for all locomotives produced after the change. You may ask us to approve a change to your FEL in the following cases:

(1) You may ask to raise your FEL for your engine family at any time. In your request, you must show that you will still be able to meet the emission standards as specified in subparts B and H of this part. If you amend your application by submitting new test data to include a newly added or modified locomotive, as described in paragraph (b)(3) of this section, use the appropriate FELs with corresponding production volumes to calculate your production-weighted average FEL for the model year, as described in subpart H of this part. If you amend your application without submitting new test data, you must use the higher FEL for the entire family to calculate your production-weighted average FEL under subpart H of this part.

(2) You may ask to lower the FEL for your emission family only if you have test data from production locomotives showing that emissions are below the proposed lower FEL. The lower FEL applies only to engines or fuel-system components you produce after we approve the new FEL. Use the appropriate FELs with corresponding production volumes to calculate your production-weighted average FEL for the model year, as described in subpart H of this part.

§ 1033.230 Grouping locomotives into engine families.

(a) Divide your product line into engine families of locomotives that are expected to have similar emission characteristics throughout the useful life. Your engine family is limited to a single model year. Freshly manufactured locomotives may not be included in the same engine family as remanufactured locomotives, except as allowed by paragraph (f) of this section. Paragraphs (b) and (c) of this section specify default criteria for dividing locomotives into engine families. Paragraphs (d) and (e) of this section allow you deviate from these defaults in certain circumstances.

(b) This paragraph (b) applies for all locomotives other than Tier 0 locomotives. Group locomotives in the same engine family if they are the same in all the following aspects:

(1) The combustion cycle (e.g., diesel cycle).

(2) The type of engine cooling employed and procedure(s) employed to maintain engine temperature within desired limits (thermostat, on-off radiator fan(s), radiator shutters, etc.).

(3) The nominal bore and stroke dimensions.

(4) The approximate intake and exhaust event timing and duration (valve or port).

(5) The location of the intake and exhaust valves (or ports).

(6) The size of the intake and exhaust valves (or ports).

(7) The overall injection or ignition timing characteristics (i.e., the deviation of the timing curves from the optimal fuel economy timing curve must be similar in degree).

(8) The combustion chamber configuration and the surface-to-volume ratio of the combustion chamber when the piston is at top dead center position, using nominal combustion chamber dimensions.

(9) The location of the piston rings on the piston.

(10) The method of air aspiration (turbocharged, supercharged, naturally aspirated, Roots blown).

(11) The general performance characteristics of the turbocharger or supercharger (e.g., approximate boost pressure, approximate response time, approximate size relative to engine displacement).

(12) The type of air inlet cooler (air-to-air, air-to-liquid, approximate degree to which inlet air is cooled).

(13) The intake manifold induction port size and configuration.

(14) The type of fuel and fuel system configuration.

(15) The configuration of the fuel injectors and approximate injection pressure.

(16) The type of fuel injection system controls (i.e., mechanical or electronic).

(17) The type of smoke control system.

(18) The exhaust manifold port size and configuration.

(19) The type of exhaust aftertreatment system (oxidation catalyst, particulate trap), and characteristics of the aftertreatment system (catalyst loading, converter size vs. engine size).

(c) Group Tier 0 locomotives in the same engine family if they are the same in all the following aspects:

(1) The combustion cycle (e.g., diesel cycle).

(2) The type of engine cooling employed and procedure(s) employed to maintain engine temperature within desired limits (thermostat, on-off radiator fan(s), radiator shutters, etc.).

(3) The approximate bore and stroke dimensions.

(4) The approximate location of the intake and exhaust valves (or ports).

(5) The combustion chamber general configuration and the approximate surface-to-volume ratio of the combustion chamber when the piston is at top dead center position, using nominal combustion chamber dimensions.

(6) The method of air aspiration (turbocharged, supercharged, naturally aspirated, Roots blown).

(7) The type of air inlet cooler (air-to-air, air-to-liquid, approximate degree to which inlet air is cooled).

(8) The type of fuel and general fuel system configuration.

(9) The general configuration of the fuel injectors and approximate injection pressure.

(10) The type of fuel injection system control (electronic or mechanical).

(d) You may subdivide a group of locomotives that is identical under paragraph (b) or (c) of this section into different engine families if you show the expected emission characteristics are different during the useful life. This allowance also covers locomotives for which only calculated emission rates differ, such as locomotives with and without energy-saving design features. For the purposes of determining whether an engine family is a small engine family in § 1033.405(a)(2), we will consider the number of locomotives that could have been classed together under paragraph (b) or (c) of this section, instead of the number of locomotives that are included in a subdivision allowed by this paragraph (d).

(e) In unusual circumstances, you may group locomotives that are not identical with respect to the things listed in paragraph (b) or (c) of this section in the same engine family if you show that their emission characteristics during the useful life will be similar.

(f) During the first six calendar years after a new tier of standards become applicable, remanufactured engines/locomotives may be included in the same engine family as freshly manufactured locomotives, provided the same engines and emission controls are used for locomotive models included in the engine family.

§ 1033.235 Emission testing required for certification.

This section describes the emission testing you must perform to show

compliance with the emission standards in § 1033.101.

(a) Select an emission-data locomotive (or engine) from each engine family for testing. It may be a low mileage locomotive, or a development engine (that is equivalent in design to the engines of the locomotives being certified), or another low hour engine. Use good engineering judgment to select the locomotive configuration that is most likely to exceed (or have emissions nearest to) an applicable emission standard or FEL. In making this selection, consider all factors expected to affect emission control performance and compliance with the standards, including emission levels of all exhaust constituents, especially NO_x and PM.

(b) Test your emission-data locomotives using the procedures and equipment specified in subpart F of this part.

(c) We may measure emissions from any of your test locomotives or other locomotives from the engine family.

(1) We may decide to do the testing at your plant or any other facility. If we do this, you must deliver the test locomotive to a test facility we designate. If we do the testing at your plant, you must schedule it as soon as possible and make available the instruments, personnel, and equipment we need.

(2) If we measure emissions from one of your test locomotives, the results of that testing become the official emission results for the locomotive. Unless we later invalidate these data, we may decide not to consider your data in determining if your engine family meets applicable requirements.

(3) Before we test one of your locomotives, we may set its adjustable parameters to any point within the adjustable ranges (see § 1033.115(b)).

(4) Before we test one of your locomotives, we may calibrate it within normal production tolerances for anything we do not consider an adjustable parameter.

(d) You may ask to use emission data from a previous model year instead of doing new tests if all the following are true:

(1) The engine family from the previous model year differs from the current engine family only with respect to model year, or other factors not related to emissions. You may include additional configurations subject to the provisions of § 1033.225.

(2) The emission-data locomotive from the previous model year remains the appropriate emission-data locomotive under paragraph (b) of this section.

(3) The data show that the emission-data locomotive would meet all the requirements that apply to the engine family covered by the application for certification.

(e) You may ask to use emission data from a different engine family you have already certified instead of testing a locomotive in the second engine family if all the following are true:

(1) The same engine is used in both engine families.

(2) You demonstrate to us that the differences in the two families are sufficiently small that the locomotives in the untested family will meet the same applicable notch standards calculated from the test data.

(f) We may require you to test a second locomotive of the same or different configuration in addition to the locomotive tested under paragraph (b) of this section.

(g) If you use an alternate test procedure under 40 CFR 1065.10 and later testing shows that such testing does not produce results that are equivalent to the procedures specified in subpart F of this part, we may reject data you generated using the alternate procedure.

(h) The requirement to measure smoke emissions is waived for certification and production line testing, except where there is reason to believe your locomotives do not meet the applicable smoke standards.

§ 1033.240 Demonstrating compliance with exhaust emission standards.

(a) For purposes of certification, your engine family is considered in compliance with the applicable numerical emission standards in § 1033.101 if all emission-data locomotives representing that family have test results showing deteriorated emission levels at or below these standards.

(1) If you include your locomotive in the ABT program in subpart H of this part, your FELs are considered to be the applicable emission standards with which you must comply.

(2) If you do not include your remanufactured locomotive in the ABT program in subpart H of this part, but it was previously included in the ABT program in subpart H of this part, the previous FELs are considered to be the applicable emission standards with which you must comply.

(b) Your engine family is deemed not to comply if any emission-data locomotive representing that family has test results showing a deteriorated emission level above an applicable FEL or emission standard from § 1033.101 for any pollutant. Use the following

steps to determine the deteriorated emission level for the test locomotive:

(1) Collect emission data using measurements with enough significant figures to calculate the cycle-weighted emission rate to at least one more decimal place than the applicable standard. Apply any applicable humidity corrections before weighting emissions.

(2) Apply the regeneration factors if applicable. At this point the emission rate is generally considered to be an official emission result.

(3) Apply the deterioration factor to the official emission result, as described in § 1033.245, then round the adjusted figure to the same number of decimal places as the emission standard. This adjusted value is the deteriorated emission level. Compare these emission levels from the emission-data locomotive with the applicable emission standards. In the case of NO_x+NMHC standards, apply the deterioration factor to each pollutant and then add the results before rounding.

(4) The highest deteriorated emission levels for each pollutant are considered to be the certified emission levels.

(c) An owner/operator remanufacturing its locomotives to be identical to their previously certified configuration may certify by design without new emission test data. To do this, submit the application for certification described in § 1033.205, but instead of including test data, include a description of how you will ensure that your locomotives will be identical in all material respects to their previously certified condition. You may use reconditioned parts consistent with good engineering judgment. You have all of the liabilities and responsibilities of the certificate holder for locomotives you certify under this paragraph.

§ 1033.245 Deterioration factors.

Establish deterioration factors for each pollutant to determine, as described in § 1033.240, whether your locomotives will meet emission standards for each pollutant throughout the useful life. Determine deterioration factors as described in this section, either with an engineering analysis, with pre-existing test data, or with new emission measurements. The deterioration factors are intended to reflect the deterioration expected to result during the useful life of a locomotive maintained as specified in § 1033.125. If you perform durability testing, the maintenance that you may perform on your emission-data locomotive is limited to the maintenance described in § 1033.125.

(a) Your deterioration factors must take into account any available data

from in-use testing with similar locomotives, consistent with good engineering judgment. For example, it would not be consistent with good engineering judgment to use deterioration factors that predict emission increases over the useful life of a locomotive or locomotive engine that are significantly less than the emission increases over the useful life observed from in-use testing of similar locomotives.

(b) Deterioration factors may be additive or multiplicative.

(1) *Additive deterioration factor for exhaust emissions.* Except as specified in paragraph (b)(2) of this section, use an additive deterioration factor for exhaust emissions. An additive deterioration factor for a pollutant is the difference between exhaust emissions at the end of the useful life and exhaust emissions at the low-hour test point. In these cases, adjust the official emission results for each tested locomotive at the selected test point by adding the factor to the measured emissions. The deteriorated emission level is intended to represent the highest emission level during the useful life. Thus, if the factor is less than zero, use zero. Additive deterioration factors must be specified to one more decimal place than the applicable standard.

(2) *Multiplicative deterioration factor for exhaust emissions.* Use a multiplicative deterioration factor if good engineering judgment calls for the deterioration factor for a pollutant to be the ratio of exhaust emissions at the end of the useful life to exhaust emissions at the low-hour test point. For example, if you use aftertreatment technology that controls emissions of a pollutant proportionally to engine-out emissions, it is often appropriate to use a multiplicative deterioration factor. Adjust the official emission results for each tested locomotive at the selected test point by multiplying the measured emissions by the deterioration factor. The deteriorated emission level is intended to represent the highest emission level during the useful life. Thus, if the factor is less than one, use one. A multiplicative deterioration factor may not be appropriate in cases where testing variability is significantly greater than locomotive-to-locomotive variability. Multiplicative deterioration factors must be specified to one more significant figure than the applicable standard.

(c) Deterioration factors for smoke are always additive.

(d) If your locomotive vents crankcase emissions to the exhaust or to the atmosphere, you must account for crankcase emission deterioration, using

good engineering judgment. You may use separate deterioration factors for crankcase emissions of each pollutant (either multiplicative or additive) or include the effects in combined deterioration factors that include exhaust and crankcase emissions together for each pollutant.

(e) Include the following information in your application for certification:

(1) If you determine your deterioration factors based on test data from a different engine family, explain why this is appropriate and include all the emission measurements on which you base the deterioration factor.

(2) If you determine your deterioration factors based on engineering analysis, explain why this is appropriate and include a statement that all data, analyses, evaluations, and other information you used are available for our review upon request.

(3) If you do testing to determine deterioration factors, describe the form and extent of service accumulation, including a rationale for selecting the service-accumulation period and the method you use to accumulate hours.

§ 1033.250 Reporting and recordkeeping.

(a) Within 45 days after the end of the model year, send the Designated Compliance Officer a report describing the following information about locomotives you produced during the model year:

(1) Report the total number of locomotives you produced in each engine family by locomotive model and engine model.

(2) If you produced exempted locomotives, report the number of exempted locomotives you produced for each locomotive model and identify the buyer or shipping destination for each exempted locomotive. You do not need to report under this paragraph (a)(2) locomotives that were temporarily exempted, exported locomotives, locomotives exempted as manufacturer/remanufacturer-owned locomotives, or locomotives exempted as test locomotives.

(b) Organize and maintain the following records:

(1) A copy of all applications and any summary information you send us.

(2) Any of the information we specify in § 1033.205 that you were not required to include in your application.

(3) A detailed history of each emission-data locomotive. For each locomotive, describe all of the following:

(i) The emission-data locomotive's construction, including its origin and buildup, steps you took to ensure that it represents production locomotives,

any components you built specially for it, and all the components you include in your application for certification.

(ii) How you accumulated locomotive operating hours (service accumulation), including the dates and the number of hours accumulated.

(iii) All maintenance, including modifications, parts changes, and other service, and the dates and reasons for the maintenance.

(iv) All your emission tests, including documentation on routine and standard tests, as specified in part 40 CFR part 1065, and the date and purpose of each test.

(v) All tests to diagnose locomotive or emission control performance, giving the date and time of each and the reasons for the test.

(vi) Any other significant events.

(4) If you test a development engine for certification, you may omit information otherwise required by paragraph (b)(3) of this section that is unrelated to emissions and emission-related components.

(5) Production figures for each engine family divided by assembly plant.

(6) Keep a list of locomotive identification numbers for all the locomotives you produce under each certificate of conformity.

(c) Keep data from routine emission tests (such as test cell temperatures and relative humidity readings) for one year after we issue the associated certificate of conformity. Keep all other information specified in paragraph (a) of this section for eight years after we issue your certificate.

(d) Store these records in any format and on any media, as long as you can promptly send us organized, written records in English if we ask for them. You must keep these records readily available. We may review them at any time.

(e) Send us copies of any locomotive maintenance instructions or explanations if we ask for them.

§ 1033.255 EPA decisions.

(a) If we determine your application is complete and shows that the engine family meets all the requirements of this part and the Clean Air Act, we will issue a certificate of conformity for your engine family for that model year. We may make the approval subject to additional conditions.

(b) We may deny your application for certification if we determine that your engine family fails to comply with emission standards or other requirements of this part or the Clean Air Act. Our decision may be based on a review of all information available to us. If we deny your application, we will explain why in writing.

(c) In addition, we may deny your application or suspend or revoke your certificate if you do any of the following:

(1) Refuse to comply with any testing or reporting requirements.

(2) Submit false or incomplete information (paragraph (e) of this section applies if this is fraudulent).

(3) Render inaccurate any test data.

(4) Deny us from completing authorized activities. This includes a failure to provide reasonable assistance.

(5) Produce locomotives for importation into the United States at a location where local law prohibits us from carrying out authorized activities.

(6) Fail to supply requested information or amend your application to include all locomotives being produced.

(7) Take any action that otherwise circumvents the intent of the Clean Air Act or this part.

(d) We may void your certificate if you do not keep the records we require or do not give us information when we ask for it.

(e) We may void your certificate if we find that you intentionally submitted false or incomplete information.

(f) If we deny your application or suspend, revoke, or void your certificate, you may ask for a hearing (see § 1033.920).

Subpart D—Manufacturer and Remanufacturer Production Line Testing and Audit Programs

§ 1033.301 Applicability.

The requirements of this part apply to manufacturers/remanufacturers of locomotives certified under this part, with the following exceptions:

(a) The requirements of §§ 1033.310, 1033.315, 1033.320, and 1033.330 apply only to manufacturers of freshly manufactured locomotives or locomotive engines (including those used for repowering). We may also apply these requirements to remanufacturers of any locomotives for which there is reason to believe production problems exist that could affect emission performance. When we make a determination that production problems may exist that could affect emission performance, we will notify the remanufacturer(s). The requirements of §§ 1033.310, 1033.315, 1033.320, and 1033.330 will apply as specified in the notice.

(b) The requirements of § 1033.335 apply only to remanufacturers.

(c) As specified in § 1033.1(d), we may apply the requirements of this subpart to manufacturers/remanufacturers that do not certify the

locomotives. However, unless we specify otherwise, the requirements of this subpart apply to manufacturers/remanufacturers that hold the certificates for the locomotives.

§ 1033.305 General requirements.

(a) Manufacturers (and remanufacturers, where applicable) are required to test production line locomotives using the test procedures specified in § 1033.315. While this subpart refers to locomotive testing, you may ask to test locomotive engines instead of testing locomotives.

(b) Remanufacturers are required to conduct audits according to the requirements of § 1033.335 to ensure that remanufactured locomotives comply with the requirements of this part.

(c) If you certify an engine family with carryover emission data, as described in § 1033.235, and these equivalent engine families consistently pass the production-line testing requirements over the preceding two-year period, you may ask for a reduced testing rate for further production-line testing for that family. If we reduce your testing rate, we may limit our approval to any number of model years. In determining whether to approve your request, we may consider the number of locomotives that have failed emission tests.

(d) You may ask to use an alternate program or measurement method for testing production-line engines. In your request, you must show us that the alternate program gives equal assurance that your engines meet the requirements of this part. We may waive some or all of this subpart's requirements if we approve your alternate program.

§ 1033.310 Sample selection for testing.

(a) At the start of each model year, begin randomly selecting locomotives from each engine family for production line testing at a rate of one percent. Make the selection of the test locomotive after it has been assembled. Perform the testing throughout the entire model year to the extent possible, unless we specify a different schedule for your tests. For example, we may require you to disproportionately select locomotives from the early part of a model year for a new locomotive model that has not been subject to PLT previously.

(1) The required sample size for an engine family (provided that no locomotive tested fails to meet applicable emission standards) is the lesser of five tests per model year or one percent of projected annual production, with a minimum sample size for an

engine family of one test per model year. See paragraph (d) of this section to determine the required number of test locomotives if any locomotives fail to comply with any standards.

(2) You may elect to test additional locomotives. All additional locomotives must be tested in accordance with the applicable test procedures of this part.

(b) You must assemble the test locomotives using the same production process that will be used for locomotives to be introduced into commerce. You may ask us to allow special assembly procedures for catalyst-equipped locomotives.

(c) Unless we approve it, you may not use any quality control, testing, or assembly procedures that you do not use during the production and assembly of all other locomotives of that family. This applies for any test locomotive or any portion of a locomotive, including engines, parts, and subassemblies.

(d) If one or more locomotives fail a production line test, then you must test two additional locomotives from the next fifteen produced in that engine family for each locomotive that fails. These two additional locomotives do not count towards your minimum number of locomotives. For example, if you are required to test a minimum of four locomotives under paragraph (a) of this section and the second locomotive fails to comply with one or more standards, then you must test two additional locomotives from the next fifteen produced in that engine family. If both of those locomotives pass all standards, you are required to test two additional locomotives to complete the original minimum number of four. If they both pass, you are done with testing for that family for the year since you tested six locomotives (the four originally required plus the two additional locomotives).

§ 1033.315 Test procedures.

(a) *Test procedures.* Use the test procedures described in subpart F of this part, except as specified in this section.

(1) You may ask to use other test procedures. We will approve your request if we determine that it is not possible to perform satisfactory testing using the specified procedures. We may also approve alternate test procedures under § 1033.305(d).

(2) If you used test procedures other than those in subpart F of this part during certification for the engine family (other than alternate test procedures necessary for testing a development engine or a low hour engine instead of a low mileage locomotive), use the same test

procedures for production line testing that you used in certification.

(b) *Modifying a test locomotive.* Once an engine is selected for testing, you may adjust, repair, maintain, or modify it or check its emissions only if one of the following is true:

(1) You document the need for doing so in your procedures for assembling and inspecting all your production engines and make the action routine for all the engines in the engine family.

(2) This subpart otherwise specifically allows your action.

(3) We approve your action in advance.

(c) *Adjustable parameters.* (1) Confirm that adjustable parameters are set to values or positions that are within the range recommended to the ultimate purchaser.

(2) We may require to be adjusted any adjustable parameter to any setting within the specified adjustable range of that parameter prior to the performance of any test.

(d) *Stabilizing emissions.* You may stabilize emissions from the locomotives to be tested through service accumulation by running the engine through a typical duty cycle. Emissions are considered stabilized after 300 hours of operation. You may accumulate fewer hours, consistent with good engineering judgment. You may establish a Green Engine Factor for each regulated pollutant for each engine family, instead of (or in combination with) accumulating actual operation, to be used in calculating emissions test results. You must obtain our approval prior to using a Green Engine Factor. For catalyst-equipped locomotives, you may operate the locomotive for up to 1000 hours (in revenue or other service) prior to testing.

(e) *Adjustment after shipment.* If a locomotive is shipped to a facility other than the production facility for production line testing, and an adjustment or repair is necessary because of such shipment, you may perform the necessary adjustment or repair only after the initial test of the locomotive, unless we determine that the test would be impossible to perform or would permanently damage the locomotive.

(f) *Malfunctions.* If a locomotive cannot complete the service accumulation or an emission test because of a malfunction, you may request that we authorize either the repair of that locomotive or its deletion from the test sequence.

(g) *Retesting.* If you determine that any production line emission test of a locomotive is invalid, you must retest it in accordance with the requirements of

this subpart. Report emission results from all tests to us, including test results you determined are invalid. You must also include a detailed explanation of the reasons for invalidating any test in the quarterly report required in § 1033.320(e). In the event a retest is performed, you may ask us within ten days of the end of the production quarter for permission to substitute the after-repair test results for the original test results. We will respond to the request within ten working days of our receipt of the request.

§ 1033.320 Calculation and reporting of test results.

(a) Calculate initial test results using the applicable test procedure specified in § 1033.315(a). Include applicable non-deterioration adjustments such as a Green Engine Factor or regeneration adjustment factor. Round the results to one more decimal place than the applicable emission standard.

(b) If you conduct multiple tests on any locomotives, calculate final test results by summing the initial test results derived in paragraph (a) of this section for each test locomotive, dividing by the number of tests conducted on the locomotive, and rounding to one more decimal place than the applicable emission standard. For catalyst-equipped locomotives, you may ask us to allow you to exclude an initial failed test if all of the following are true:

- (1) The catalyst was in a green condition when tested initially.
- (2) The locomotive met all emission standards when retested after degreening the catalyst.
- (3) No additional emission-related maintenance or repair was performed between the initial failed test and the subsequent passing test.

(c) Calculate the final test results for each test locomotive by applying the appropriate deterioration factors, derived in the certification process for the engine family, to the final test results, and rounding to one more decimal place than the applicable emission standard.

(d) If, subsequent to an initial failure of a production line test, the average of the test results for the failed locomotive and the two additional locomotives tested, is greater than any applicable emission standard or FEL, the engine family is deemed to be in non-compliance with applicable emission standards, and you must notify us within ten working days of such noncompliance.

(e) Within 45 calendar days of the end of each quarter, you must send to the

Designated Compliance Officer a report with the following information:

(1) The location and description of the emission test facilities which you used to conduct your testing.

(2) Total production and sample size for each engine family tested.

(3) The applicable standards against which each engine family was tested.

(4) For each test conducted, include all of the following:

(i) A description of the test locomotive, including:

(A) Configuration and engine family identification.

(B) Year, make, and build date.

(C) Engine identification number.

(D) Number of megawatt-hours (or miles if applicable) of service accumulated on locomotive prior to testing.

(E) Description of Green Engine Factor; how it is determined and how it is applied.

(ii) Location(s) where service accumulation was conducted and description of accumulation procedure and schedule, if applicable. If the locomotive was introduced into service between assembly and testing, you are only required to summarize the service accumulation, rather than identifying specific locations.

(iii) Test number, date, test procedure used, initial test results before and after rounding, and final test results for all production line emission tests conducted, whether valid or invalid, and the reason for invalidation of any test results, if applicable.

(iv) A complete description of any adjustment, modification, repair, preparation, maintenance, and testing which was performed on the test locomotive, has not been reported pursuant to any other paragraph of this subpart, and will not be performed on other production locomotives.

(v) Any other information we may ask you to add to your written report so we can determine whether your new engines conform with the requirements of this part.

(6) For each failed locomotive as defined in § 1033.330(a), a description of the remedy and test results for all retests as required by § 1033.340(g).

(7) The following signed statement and endorsement by an authorized representative of your company:

We submit this report under sections 208 and 213 of the Clean Air Act. Our production-line testing conformed completely with the requirements of 40 CFR part 1033. We have not changed production processes or quality-control procedures for the test locomotives in a way that might affect emission controls. All the information in this report is true

and accurate to the best of my knowledge. I know of the penalties for violating the Clean Air Act and the regulations. (Authorized Company Representative)

§ 1033.325 Maintenance of records; submittal of information.

(a) You must establish, maintain, and retain the following adequately organized and indexed test records:

(1) A description of all equipment used to test locomotives. The equipment requirements in subpart F of this part apply to tests performed under this subpart. Maintain these records for each test cell that can be used to perform emission testing under this subpart.

(2) Individual test records for each production line test or audit including:

(i) The date, time, and location of each test or audit.

(ii) The method by which the Green Engine Factor was calculated or the number of hours of service accumulated on the test locomotive when the test began and ended.

(iii) The names of all supervisory personnel involved in the conduct of the production line test or audit;

(iv) A record and description of any adjustment, repair, preparation or modification performed on test locomotives, giving the date, associated time, justification, name(s) of the authorizing personnel, and names of all supervisory personnel responsible for the conduct of the action.

(v) If applicable, the date the locomotive was shipped from the assembly plant, associated storage facility or port facility, and the date the locomotive was received at the testing facility.

(vi) A complete record of all emission tests or audits performed under this subpart (except tests performed directly by us), including all individual worksheets and/or other documentation relating to each test, or exact copies thereof, according to the record requirements specified in subpart F of this part and 40 CFR part 1065.

(vii) A brief description of any significant events during testing not otherwise described under this paragraph (a)(2), commencing with the test locomotive selection process and including such extraordinary events as engine damage during shipment.

(b) Keep all records required to be maintained under this subpart for a period of eight years after completion of all testing. Store these records in any format and on any media, as long as you can promptly provide to us organized, written records in English if we ask for them and all the information is retained.

(c) Send us the following information with regard to locomotive production if we ask for it:

(1) Projected production for each configuration within each engine family for which certification has been requested and/or approved.

(2) Number of locomotives, by configuration and assembly plant, scheduled for production.

(d) Nothing in this section limits our authority to require you to establish, maintain, keep or submit to us information not specified by this section.

(e) Send all reports, submissions, notifications, and requests for approval made under this subpart to the Designated Compliance Officer using an approved format.

(f) You must keep a copy of all reports submitted under this subpart.

§ 1033.330 Compliance criteria for production line testing.

There are two types of potential failures: failure of an individual locomotive to comply with the standards, and a failure of an engine family to comply with the standards.

(a) A failed locomotive is one whose final test results pursuant to § 1033.320(c), for one or more of the applicable pollutants, exceed an applicable emission standard or FEL.

(b) An engine family is deemed to be in noncompliance, for purposes of this subpart, if at any time throughout the model year, the average of an initial failed locomotive and the two additional locomotives tested, is greater than any applicable emission standard or FEL.

§ 1033.335 Remanufactured locomotives: installation audit requirements.

The section specifies the requirements for certifying remanufacturers to audit the remanufacture of locomotives covered by their certificates of conformity for proper components, component settings and component installations on randomly chosen locomotives in an engine family.

(a) You must ensure that all emission related components are properly installed on the locomotive and are set to the proper specification as indicated in your instructions. You may submit audits performed by the owners/operators of the locomotives, provided the audits are performed in accordance with the provisions of this section. We may require that you obtain affidavits for audits performed by owners/operators.

(b) Audit at least five percent of your annual production per model year per installer or ten per engine family per

installer, whichever is less. You must perform more audits if there are any failures. Randomly select the locomotives to be audited after the remanufacture is complete. We may allow you to select locomotives prior to the completion of the remanufacture, if the preselection would not have the potential to affect the manner in which the locomotive was remanufactured (e.g., where the installer is not aware of the selection prior to the completion of the remanufacture). Unless we specify otherwise, you are not required to audit installers that remanufacture fewer than 10 locomotives per year under your certificates (combined for all of your engine families).

(c) The audit should be completed as soon as is practical after the remanufacture is complete. In no case may the remanufactured locomotive accumulate more than 45,000 miles prior to an audit.

(d) A locomotive fails if any emission related components are found to be improperly installed, improperly adjusted or incorrectly used.

(e) If a remanufactured locomotive fails an audit, then you must audit two additional locomotives from the next ten remanufactured in that engine family by that installer.

(f) An engine family is determined to have failed an audit, if at any time during the model year, you determine that the three locomotives audited are found to have had any improperly installed, improperly adjusted or incorrectly used components. You must notify us within 2 working days of a determination of an engine family audit failure.

(g) Within 45 calendar days of the end of each quarter, each remanufacturer must send the Designated Compliance Officer a report which includes the following information:

(1) The location and description of your audit facilities which were utilized to conduct auditing reported pursuant to this section;

(2) Total production and sample size for each engine family;

(3) The applicable standards and/or FELs against which each engine family was audited;

(4) For each audit conducted:

(i) A description of the audited locomotive, including:

(A) Configuration and engine family identification;

(B) Year, make, build date, and remanufacture date; and

(C) Locomotive and engine identification numbers;

(ii) Any other information we request relevant to the determination whether the new locomotives being

remanufactured do in fact conform with the regulations with respect to which the certificate of conformity was issued;

(5) For each failed locomotive as defined in paragraph (d) of this section, a description of the remedy as required by § 1033.340(g);

(6) The following signed statement and endorsement by your authorized representative:

We submit this report under sections 208 and 213 of the Clean Air Act. Our production-line auditing conformed completely with the requirements of 40 CFR part 1033. We have not changed production processes or quality-control procedures for the audited locomotives in a way that might affect emission controls. All the information in this report is true and accurate to the best of my knowledge. I know of the penalties for violating the Clean Air Act and the regulations. (Authorized Company Representative)

§ 1033.340 Suspension and revocation of certificates of conformity.

(a) A certificate can be suspended for an individual locomotive as follows:

(1) The certificate of conformity is automatically suspended for any locomotive that fails a production line test pursuant to § 1033.330(a), effective from the time the testing of that locomotive is completed.

(2) The certificate of conformity is automatically suspended for any locomotive that fails an audit pursuant to § 1033.335(d), effective from the time that auditing of that locomotive is completed.

(b) A certificate can be suspended for an engine family as follows:

(1) We may suspend the certificate of conformity for an engine family that is in noncompliance pursuant to § 1033.330(b), thirty days after the engine family is deemed to be in noncompliance.

(2) We may suspend the certificate of conformity for an engine family that is determined to have failed an audit pursuant to § 1033.335(f). This suspension will not occur before thirty days after the engine family is deemed to be in noncompliance.

(c) If we suspend your certificate of conformity for an engine family, the suspension may apply to all facilities producing engines from an engine family, even if you find noncompliant engines only at one facility.

(d) We may revoke a certificate of conformity for any engine family in whole or in part if:

(1) You fail to comply with any of the requirements of this subpart.

(2) You submit false or incomplete information in any report or information provided to us under this subpart.

(3) You render inaccurate any test data submitted under this subpart.

(4) An EPA enforcement officer is denied the opportunity to conduct activities authorized in this subpart.

(5) An EPA enforcement officer is unable to conduct authorized activities for any reason.

(e) We will notify you in writing of any suspension or revocation of a certificate of conformity in whole or in part; a suspension or revocation is effective upon receipt of such notification or thirty days from the time a locomotive or engine family is deemed to be in noncompliance under §§ 1033.320(d), 1033.330(a), 1033.330(b), or 1033.335(f) is made, whichever is earlier, except that the certificate is immediately suspended with respect to any failed locomotives as provided for in paragraph (a) of this section.

(f) We may revoke a certificate of conformity for an engine family when the certificate has been suspended under paragraph (b) or (c) of this section if the remedy is one requiring a design change or changes to the locomotive, engine and/or emission control system as described in the application for certification of the affected engine family.

(g) Once a certificate has been suspended for a failed locomotive, as provided for in paragraph (a) of this section, you must take all the following actions before the certificate is reinstated for that failed locomotive:

(1) Remedy the nonconformity.

(2) Demonstrate that the locomotive conforms to applicable standards or family emission limits by retesting, or reauditing if applicable, the locomotive in accordance with this part.

(3) Submit a written report to us after successful completion of testing (or auditing, if applicable) on the failed locomotive, which contains a description of the remedy and testing (or auditing) results for each locomotive in addition to other information that may be required by this part.

(h) Once a certificate for a failed engine family has been suspended pursuant to paragraph (b) or (c) of this section, you must take the following actions before we will consider reinstating the certificate:

(1) Submit a written report to us identifying the reason for the noncompliance of the locomotives, describing the remedy, including a description of any quality control measures you will use to prevent future occurrences of the problem, and stating the date on which the remedies will be implemented.

(2) Demonstrate that the engine family for which the certificate of conformity has been suspended does in fact comply with the regulations of this part by testing (or auditing) locomotives selected from normal production runs of that engine family. Such testing (or auditing) must comply with the provisions of this subpart. If you elect to continue testing (or auditing) individual locomotives after suspension of a certificate, the certificate is reinstated for any locomotive actually determined to be in conformance with the applicable standards or family emission limits through testing (or auditing) in accordance with the applicable test procedures, provided that we have not revoked the certificate under paragraph (f) of this section.

(i) If the certificate has been revoked for an engine family, you must take the following actions before we will issue a certificate that would allow you to continue introduction into commerce of a modified version of that family:

(1) If we determine that the change(s) in locomotive design may have an effect on emission deterioration, we will notify you within five working days after receipt of the report in paragraph (h) of this section, whether subsequent testing/auditing under this subpart will be sufficient to evaluate the change(s) or whether additional testing (or auditing) will be required.

(2) After implementing the change or changes intended to remedy the nonconformity, you must demonstrate that the modified engine family does in fact conform with the regulations of this part by testing locomotives (or auditing for remanufactured locomotives) selected from normal production runs of that engine family. When both of these requirements are met, we will reissue the certificate or issue a new certificate. If this subsequent testing (or auditing) reveals failing data the revocation remains in effect.

(j) At any time subsequent to an initial suspension of a certificate of conformity for a test or audit locomotive pursuant to paragraph (a) of this section, but not later than 30 days (or such other period as may we allow) after the notification our decision to suspend or revoke a certificate of conformity in whole or in part pursuant to this section, you may request a hearing as to whether the tests or audits have been properly conducted or any sampling methods have been properly applied. (See § 1033.920.)

(k) Any suspension of a certificate of conformity under paragraphs (a) through (d) of this section will be made only after you have been offered an opportunity for a hearing conducted in accordance with § 1033.920. It will not

apply to locomotives no longer in your possession.

(l) If we suspend, revoke, or void a certificate of conformity, and you believe that our decision was based on erroneous information, you may ask us to reconsider our decision before requesting a hearing. If you demonstrate to our satisfaction that our decision was based on erroneous information, we will reinstate the certificate.

(m) We may conditionally reinstate the certificate for that family so that you do not have to store non-test locomotives while conducting subsequent testing or auditing of the noncomplying family subject to the following condition: you must commit to recall all locomotives of that family produced from the time the certificate is conditionally reinstated if the family fails subsequent testing, or auditing if applicable, and must commit to remedy any nonconformity at no expense to the owner.

Subpart E—In-use Testing

§ 1033.401 Applicability.

The requirements of this subpart are applicable to certificate holders for locomotives subject to the provisions of this part. These requirements may also be applied to other manufacturers/remanufacturers as specified in § 1033.1(d).

§ 1033.405 General provisions.

(a) Each year, we will identify engine families and configurations within families that you must test according to the requirements of this section.

(1) We may require you to test one engine family each year for which you have received a certificate of conformity. If you are a manufacturer that holds certificates of conformity for both freshly manufactured and remanufactured locomotive engine families, we may require you to test one freshly manufactured engine family and one remanufactured engine family. We may require you to test additional engine families if we have reason to believe that locomotives in such families do not comply with emission standards in use.

(2) For engine families of less than 10 locomotives per year, no in-use testing will be required, unless we have reason to believe that those engine families are not complying with the applicable emission standards in use.

(b) Test a sample of in-use locomotives from an engine family, as specified in § 1033.415. We will use these data, and any other data available to us, to determine the compliance status of classes of locomotives,

including for purposes of recall under 40 CFR part 1068, and whether remedial action is appropriate.

§ 1033.410 In-use test procedure.

(a) You must test the complete locomotives; you may not test engines that are not installed in locomotives at the time of testing.

(b) Test the locomotive according to the test procedures outlined in subpart F of this part, except as provided in this section.

(c) Use the same test procedures for in-use testing as were used for certification, except for cases in which certification testing was not conducted with a locomotive, but with a development engine or other engine. In such cases, we will specify deviations from the certification test procedures as appropriate. We may allow or require other alternate procedures, with advance approval.

(d) Set all adjustable locomotive or engine parameters to values or positions that are within the range specified in the certificate of conformity. We may require you to set these parameters to specific values.

(e) We may waive a portion of the applicable test procedure that is not necessary to determine in-use compliance.

§ 1033.415 General testing requirements.

(a) *Number of locomotives to be tested.* Determine the number of locomotives to be tested by the following method:

(1) Test a minimum of 2 locomotives per engine family, except as provided in paragraph (a)(2) of this section. You must test additional locomotives if any locomotives fail to meet any standard. Test 2 more locomotives for each failing locomotive, but stop testing if the total number of locomotives tested equals 10.

(2) If an engine family has been certified using carryover emission data from a family that has been previously tested under paragraph (a)(1) of this section (and we have not ordered or begun to negotiate remedial action of that family), you need to test only one locomotive per engine family. If that locomotive fails to meet applicable standards for any pollutant, testing for that engine family must be conducted as outlined under paragraph (a)(1) of this section.

(3) You may ask us to allow you to test more locomotives than the minimum number described above or you may concede failure before testing 10 locomotives.

(b) *Compliance criteria.* We will consider failure rates, average emission levels and the existence of any defects

among other factors in determining whether to pursue remedial action. We may order a recall pursuant to 40 CFR part 1068 before testing reaches the tenth locomotive.

(c) *Collection of in-use locomotives.* Procure in-use locomotives that have been operated for 50 to 75 percent of the locomotive's useful life for testing under this subpart. Complete testing required by this section for any engine family before useful life of the locomotives in the engine family passes. (**Note:** § 1033.820 specifies that railroads must make reasonable efforts to enable you to perform this testing.)

§ 1033.420 Maintenance, procurement and testing of in-use locomotives.

(a) A test locomotive must have a maintenance history that is representative of actual in-use conditions, and identical or equivalent to your recommended emission-related maintenance requirements.

(1) When procuring locomotives for in-use testing, ask the end users about the accumulated usage, maintenance, operating conditions, and storage of the test locomotives.

(2) Your selection of test locomotives is subject to our approval. Maintain the information you used to procure locomotives for in-use testing in the same manner as is required in § 1033.250.

(b) You may perform minimal set-to-spec maintenance on a test locomotive before conducting in-use testing. Maintenance may include only that which is listed in the owner's instructions for locomotives with the amount of service and age of the acquired test locomotive. Maintain documentation of all maintenance and adjustments.

(c) If the locomotive selected for testing is equipped with emission diagnostics meeting the requirements in § 1033.110 and the MIL is illuminated, you may read the code and repair the malfunction according to your emission-related maintenance instructions, but only to the degree that an owner/operator would be required to repair the malfunction under § 1033.815.

(d) Results of at least one valid set of emission tests using the test procedure described in subpart F of this part is required for each in-use locomotive.

(e) If in-use testing results show that an in-use locomotive fails to comply with any applicable emission standards, you must determine the reason for noncompliance and report your findings in the quarterly in-use test result report described in § 1033.425.

§ 1033.425 In-use test program reporting requirements.

(a) Within 90 days of completion of testing, send us all emission test results generated from the in-use testing program. Report all of the following information for each locomotive tested:

- (1) Engine family, and configuration.
- (2) Locomotive and engine models.
- (3) Locomotive and engine serial numbers.
- (4) Date of manufacture or remanufacture, as applicable.
- (5) Megawatt-hours of use (or miles, as applicable).
- (6) Date and time of each test attempt.
- (7) Results of all emission testing.
- (8) Results (if any) of each voided or failed test attempt.
- (9) Summary of all maintenance and/or adjustments performed.
- (10) Summary of all modifications and/or repairs.
- (11) Determinations of noncompliance.

(12) The following signed statement and endorsement by an authorized representative of your company.

We submit this report under sections 208 and 213 of the Clean Air Act. Our in-use testing conformed completely with the requirements of 40 CFR part 1033. All the information in this report is true and accurate to the best of my knowledge. I know of the penalties for violating the Clean Air Act and the regulations. (Authorized Company Representative)

(b) Report to us within 90 days of completion of testing the following information for each engine family tested:

(1) The serial numbers of all locomotive that were excluded from the test sample because they did not meet the maintenance requirements of § 1033.420.

(2) The owner of each locomotive identified in paragraph (b)(1) of this section (or other entity responsible for the maintenance of the locomotive).

(3) The specific reasons why the locomotives were excluded from the test sample.

(c) Submit the information outlined in paragraphs (a) and (b) of this section electronically using an approved format. We may exempt you from this requirement upon written request with supporting justification.

(d) Send all testing reports and requests for approvals to the Designated Compliance Officer.

Subpart F—Test Procedures

§ 1033.501 General provisions.

(a) Except as specified in this subpart, use the equipment and procedures for

compression-ignition engines in 40 CFR part 1065 to determine whether your locomotives meet the duty-cycle emission standards in § 1033.101. Use the applicable duty cycles specified in this subpart. Measure emissions of all the pollutants we regulate in § 1033.101 plus CO₂. The general test procedure is the procedure specified in 40 CFR part 1065 for steady-state discrete-mode cycles. However, if you use the optional ramped modal cycle in § 1033.520, follow the procedures for ramped modal testing in 40 CFR part 1065. The following exceptions from the 1065 procedures apply:

(1) You must average power and emissions over the sampling periods specified in this subpart for both discrete-mode testing and ramped modal testing.

(2) The test cycle is considered to be steady-state with respect to operator demand rather than engine speed and load.

(3) The provisions related to engine mapping and duty cycle generation (40 CFR 1065.510 and 1065.512) are not applicable to testing of complete locomotives or locomotive engines because locomotive operation and locomotive duty cycles are based on operator demand via locomotive notch settings rather than engine speeds and loads. The cycle validation criteria (40 CFR 1065.514) are not applicable to testing of complete locomotives but do apply for dynamometer testing of engines.

(b) You may use special or alternate procedures to the extent we allow as them under 40 CFR 1065.10. In some cases, we allow you to use procedures that are less precise or less accurate than the specified procedures if they do not affect your ability to show that your locomotives comply with the applicable emission standards. This generally requires emission levels to be far enough below the applicable emission standards so that any errors caused by greater imprecision or inaccuracy do not affect your ability to state unconditionally that the locomotives meet all applicable emission standards.

(c) This part allows (with certain limits) testing of either a complete locomotive or a separate uninstalled engine. When testing a locomotive, you must test the complete locomotive in its in-use configuration, except that you may disconnect the power output and fuel input for the purpose of testing. To calculate power from measured alternator/generator output, use an alternator/generator efficiency curve that varies with speed/load, consistent with good engineering judgment.

(d) Unless smoke standards do not apply for your locomotives or the testing requirement is waived, measure smoke emissions using the procedures in § 1033.525.

(e) Use the applicable fuel listed in 40 CFR part 1065, subpart H, to perform valid tests.

(1) For diesel-fueled locomotives, use the appropriate diesel fuel specified in 40 CFR part 1065, subpart H, for emission testing. The applicable diesel test fuel is either the ultra low-sulfur diesel or low-sulfur diesel fuel, as specified in § 1033.101. Identify the test fuel in your application for certification and ensure that the fuel inlet label is consistent with your selection of the test fuel (see §§ 1033.101 and 1033.135).

(2) You may ask to use as a test fuel commercially available diesel fuel similar but not identical to the applicable fuel specified in 40 CFR part 1065, subpart H; we will approve your request if you show us that it does not affect your ability to demonstrate compliance with the applicable emission standards. If your locomotive uses sulfur-sensitive technology, you may not use an in-use fuel that has a lower sulfur content than the range specified for the otherwise applicable test fuel in 40 CFR part 1065. If your locomotive does not use sulfur-sensitive technology, we may allow you to use an in-use fuel that has a lower sulfur content than the range specified for the otherwise applicable test fuel in 40 CFR part 1065, but may require that you correct PM emissions to account for the sulfur differences.

(3) For service accumulation, use the test fuel or any commercially available fuel that is representative of the fuel that in-use locomotives will use.

(f) See § 1033.505 for information about allowable ambient testing conditions for testing.

(g) This subpart is addressed to you as a manufacturer/remanufacturer, but it applies equally to anyone who does testing for you, and to us when we perform testing to determine if your locomotives meet emission standards.

(h) We may also perform other testing as allowed by the Clean Air Act.

(i) For passenger locomotives that can generate hotel power from the main propulsion engine, the locomotive must comply with the emission standards when in either hotel or non-hotel setting.

§ 1033.505 Ambient conditions.

This section specifies the allowable ambient conditions (including temperature and pressure) under which testing may be performed to determine compliance with the emission standards

of (1068.101. Manufacturers/remanufacturers may ask to perform testing at conditions other than those allowed by this section. We will allow such testing provided it does not affect your ability to demonstrate compliance with the applicable standards. See §§ 1033.101 and 1033.115 for more information about the requirements that apply at other conditions.

(a) *Temperature.* Testing may be performed with ambient temperatures from 15.5 °C (60 °F) to 40.5 °C (105 °F). Do not correct emissions for temperature effects within this range. If we allow you to perform testing at lower ambient temperatures, you must correct NO_x emissions for temperature effects, consistent with good engineering judgment. For example, if the intake air temperature (at the manifold) is lower at the test temperature than at 15.5 °C, you generally will need to adjust your measured NO_x emissions to account for the effect of the lower intake air temperature. However, if you maintain a constant manifold air temperature, you will generally not need to correct emissions.

(b) *Altitude/pressure.* Testing may be performed with ambient pressures from 88.000 kPa (26.0 in Hg) to 103.325 kPa (30.5 in Hg). This is intended to correspond to altitudes up to 4000 feet above sea level. Do not correct emissions for pressure effects within this range.

(c) *Humidity.* Testing may be performed with any ambient humidity level. Correct NO_x emissions as specified in 40 CFR 1065.670. Do not correct any other emissions for humidity effects.

(d) *Wind.* If you test outdoors, use good engineering judgment to ensure that excessive wind does not affect your emission measurements. Winds are excessive if they disturb the size, shape, or location of the exhaust plume in the region where exhaust samples are drawn or where the smoke plume is measured, or otherwise cause any dilution of the exhaust. Tests may be conducted if wind shielding is placed adjacent to the exhaust plume to prevent bending, dispersion, or any other distortion of the exhaust plume as it passes through the optical unit or through the sample probe.

§ 1033.510 Auxiliary power units.

If your locomotive is equipped with an auxiliary power unit (APU) that operates during an idle shutdown mode, you must account for the APU's emissions rates as specified in this section, unless the APU is part of an AESS system that was certified separate from the rest of the locomotive. This

section does not apply for auxiliary engines that only provide hotel power.

(a) Adjust the locomotive main engine's idle emission rate (g/hr) as specified in § 1033.530. Add the APU emission rate (g/hr) that you determine under paragraph (b) of this section. Use the locomotive main engine's idle power as specified in § 1033.530.

(b) Determine the representative emission rate for the APU using one of the following methods.

(1) *Installed APU tested separately.* If you separately measure emission rates (g/hr) for each pollutant from the APU installed in the locomotive, you may use the measured emissions rates (g/hr) as the locomotive's idle emissions rates when the locomotive is shutdown and the APU is operating. For all testing other than in-use testing, apply appropriate deterioration factors to the measured emission rates. You may ask to carryover APU emission data for a previous test, or use data for the same APU installed on locomotives in another engine family.

(2) *Uninstalled APU tested separately.* If you separately measure emission rates (g/hr) over an appropriate duty-cycle for each pollutant from the APU when it is not installed in the locomotive, you may use the measured emissions rates (g/hr) as the locomotive's idle emissions rates when the locomotive is shutdown and the APU is operating. For the purpose of this paragraph (b)(2), an appropriate duty-cycle is one that approximates the APU engine's cycle-weighted power when operating in the locomotive. Apply appropriate deterioration factors to the measured emission rates. You may ask to carryover APU emission data for a previous test, or use data for the same APU installed on locomotives in another engine family.

(3) *APU engine certification data.* If the engine used for the APU has been certified to EPA emission standards you may calculate the APU's emissions based upon existing EPA-certification information about the APU's engine. In this case, calculate the APU's emissions as follows:

(i) For each pollutant determine the brake-specific standard/FEL to which the APU engine was originally EPA-certified.

(ii) Determine the APU engine's cycle-weighted power when operating in the locomotive.

(iii) Multiply each of the APU's applicable brake-specific standards/FELs by the APU engine's cycle-weighted power. The results are the APU's emissions rates (in g/hr).

(iv) Use these emissions rates as the locomotive's idle emissions rates when the locomotive is shutdown and the APU is running. Do not apply a deterioration factor to these values.

(4) *Other.* You may ask us to approve an alternative means to account for APU emissions.

§ 1033.515 Discrete-mode steady-state emission tests of locomotives and locomotive engines.

This section describes how to test locomotives at each notch setting so that emissions can be weighted according to either the line-haul duty cycle or the switch duty cycle. The locomotive test cycle consists of a warm-up followed by a sequence of nominally steady-state discrete test modes, as described in Table 1 to this section. The test modes are steady-state with respect to operator demand, which is the notch setting for the locomotive. Engine speeds and loads are not necessarily steady-state.

(a) Follow the provisions of 40 CFR part 1065, subpart F for general pre-test procedures (including engine and sampling system pre-conditioning which is included as engine warm-up). You may operate the engine in any way you choose to warm it up prior to beginning the sample pre-conditioning specified in 40 CFR part 1065.

(b) Begin the test by operating the locomotive over the pre-test portion of the cycle specified in Table 1 to this section. For locomotives not equipped with catalysts, you may begin the test as soon as the engine reaches its lowest idle setting. For catalyst-equipped locomotives, you may begin the test in normal idle mode if the engine does not reach its lowest idle setting within 15 minutes. If you do start in normal idle, run the low idle mode after normal idle, then resume the specified mode sequence (without repeating the normal idle mode).

(c) Measure emissions during the rest of the test cycle.

(1) Each test mode begins when the operator demand to the locomotive or engine is set to the applicable notch setting.

(2) Start measuring gaseous emissions, power, and fuel consumption at the start of the test mode A and continue until the completion of test mode 8. You may zero and span analyzers between modes (or take other actions consistent with good engineering judgment).

(i) The sample period over which emissions for the mode are averaged generally begins when the operator demand is changed to start the test mode and ends within 5 seconds of the minimum sampling time for the test mode is reached. However, you need to shift the sampling period to account for sample system residence times. Follow the provisions of 40 CFR 1065.308 and 1065.309 to time align emission and work measurements.

(ii) The sample period is 300 seconds for all test modes except mode 10. The sample period for test mode 8 is 600 seconds.

(3) If gaseous emissions are sampled using a batch-sampling method, begin proportional sampling at the beginning of each sampling period and terminate sampling once the minimum time in each test mode is reached, ± 5 seconds.

(4) If applicable, begin the smoke test at the start of the test mode A. Continue collecting smoke data until the completion of test mode 8. Refer to § 1033.101 to determine applicability of smoke testing and § 1033.525 for details on how to conduct a smoke test.

(5) Begin proportional sampling of PM emissions at the beginning of each sampling period and terminate sampling once the minimum time in each test mode is reached, ± 5 seconds, unless good engineering judgment requires you sample for a longer period to allow for collection of a sufficiently large PM sample.

(6) Proceed through each test mode in the order specified in Table 1 to this section until the locomotive test cycle is completed.

(7) At the end of each numbered test mode, you may continue to operate sampling and dilution systems to allow corrections for the sampling system's response time.

(8) Following the completion of Mode 8, conduct the post sampling procedures in § 1065.530. Note that cycle validation criteria do not apply to testing of complete locomotives.

TABLE 1 TO § 1033.515.—LOCOMOTIVE TEST CYCLE

Test mode	Notch setting	Time in mode (minutes) ¹	Sample averaging period for emissions ¹
Pre-test idle	Lowest idle setting	10 to 15 ³	Not applicable
A	Low idle ²	5 to 10	300 ± 5 seconds
B	Normal idle	5 to 10	300 ± 5 seconds

TABLE 1 TO § 1033.515.—LOCOMOTIVE TEST CYCLE—Continued

Test mode	Notch setting	Time in mode (minutes) ¹	Sample averaging period for emissions ¹
C	Dynamic brake ²	5 to 10	300 ± 5 seconds
1	Notch 1	5 to 10	300 ± 5 seconds
2	Notch 2	5 to 10	300 ± 5 seconds
3	Notch 3	5 to 10	300 ± 5 seconds
4	Notch 4	5 to 10	300 ± 5 seconds
5	Notch 5	5 to 10	300 ± 5 seconds
6	Notch 6	5 to 10	300 ± 5 seconds
7	Notch 7	5 to 10	300 ± 5 seconds
8	Notch 8	10 to 15	600 ± 5 seconds

¹ The time in each notch and sample averaging period may be extended as needed to allow for collection of a sufficiently large PM sample.

² Omit if not so equipped.

³ See paragraph (b) of this section for alternate pre-test provisions.

(f) There are two approaches for sampling PM emissions during discrete-mode steady-state testing as described in this paragraph (f).

(1) *Engines certified to a PM standard/FEL at or above 0.05 g/bhp-hr.* Use a separate PM filter sample for each test mode of the locomotive test cycle according to the procedures specified in paragraph (a) through (e) of this section. You may ask to use a shorter sampling period if the total mass expected to be collected would cause unacceptably high pressure drop across the filter before reaching the end of the required sampling time. We will not allow sampling times less than 60 seconds. When we conduct locomotive emission tests, we will adhere to the time limits for each of the numbered modes in Table 1 to § 1033.515.

(2) *Engines certified to a PM standard/FEL below 0.05 g/bhp-hr.* (i) You may use separate PM filter samples for each test mode as described in paragraph (f)(1) of this section; however, we recommend that you do not. The low rate of sample filter loading will result in very long sampling times and the large number of filter samples may induce uncertainty stack-up that will lead to unacceptable PM measurement accuracy. Instead, we recommend that you measure PM emissions as specified in paragraph (f)(2)(ii) of this section.

(ii) You may use a single PM filter for sampling PM over all of the test modes of the locomotive test cycle as specified in this paragraph (f)(2). Vary the sample time to be proportional to the applicable line-haul or switch weighting factors specified in § 1033.530 for each mode. The minimum sampling time for each mode is 400 seconds multiplied by the weighting factor. For example, for a mode with a weighting factor of 0.030, the minimum sampling time is 12.0 seconds. PM sampling in each mode must be proportional to engine exhaust flow as specified in 40 CFR part 1065. Begin proportional sampling of PM

emissions at the beginning of each test mode as is specified in paragraph (c) of this section. End the sampling period for each test mode so that sampling times are proportional to the weighting factors for the applicable duty cycles. If necessary, you may extend the time limit for each of the test modes beyond the sampling times in Table 1 to § 1033.515 to increase the sampled mass of PM emissions or to account for proper weighting of the PM emission sample over the entire cycle, using good engineering judgment.

(g) This paragraph (g) describes how to test locomotive engines when not installed in a locomotive. Note that the test procedures for dynamometer engine testing of locomotive engines are intended to produce emission measurements that are essentially identical to emission measurements produced during testing of complete locomotives using the same engine configuration. The following requirements apply for all engine tests:

(1) Specify a second-by-second set of engine speed and load points that are representative of in-use locomotive operation for each of the set-points of the locomotive test cycle described in Table 1 to § 1033.515, including transitions from one notch to the next. This is your reference cycle for validating your cycle. You may ignore points between the end of the sampling period for one mode and the point at which you change the notch setting to begin the next mode.

(2) Keep the temperature of the air entering the engine after any charge air cooling to within 5 °C of the typical intake manifold air temperature when the engine is operated in the locomotive under similar ambient conditions.

(3) Proceed with testing as specified for testing complete locomotives as specified in paragraphs (a) through (f) of this section.

§ 1033.520 Alternative ramped modal cycles.

(a) Locomotive testing over a ramped modal cycle is intended to improve measurement accuracy at low emission levels by allowing the use of batch sampling of PM and gaseous emissions over multiple locomotive notch settings. Ramped modal cycles combine multiple test modes of a discrete-mode steady-state into a single sample period. Time in notch is varied to be proportional to weighting factors. The ramped modal cycle for line-haul locomotives is shown in Table 1 to this section. The ramped modal cycle for switch locomotives is shown in Table 2 to this section. Both ramped modal cycles consist of a warm-up followed by three test phases that are each weighted in a manner that maintains the duty cycle weighting of the line-haul and switch locomotive duty cycles in § 1033.530. You may use ramped modal cycle testing for any locomotives certified under this part.

(b) Ramped modal testing requires continuous gaseous analyzers and three separate PM filters (one for each phase). You may collect a single batch sample for each test phase, but you must also measure gaseous emissions continuously to allow calculation of notch caps as required under § 1033.101.

(c) You may operate the engine in any way you choose to warm it up. Then follow the provisions of 40 CFR part 1065, subpart F for general pre-test procedures (including engine and sampling system pre-conditioning).

(d) Begin the test by operating the locomotive over the pre-test portion of the cycle. For locomotives not equipped with catalysts, you may begin the test as soon as the engine reaches its lowest idle setting. For catalyst-equipped locomotives, you may begin the test in normal idle mode if the engine does not reach its lowest idle setting within 15 minutes. If you do start in normal idle, run the low idle mode after normal idle,

then resume the specified mode sequence (without repeating the normal idle mode).

(e) Start the test according to 40 CFR 1065.530.

(1) Each test phase begins when operator demand is set to the first operator demand setting of each test phase of the ramped modal cycle. Each test phase ends when the time in mode is reached for the last mode in the test phase.

(2) For PM emissions (and other batch sampling), the sample period over which emissions for the phase are averaged generally begins within 10 seconds after the operator demand is changed to start the test phase and ends within 5 seconds of the sampling time for the test mode is reached. (see Table 1 to this section). You may ask to delay the start of the sample period to account for sample system residence times longer than 10 seconds.

(3) Use good engineering judgment when transitioning between phases.

(i) You should come as close as possible to simultaneously:

(A) Ending batch sampling of the previous phase.

(B) Starting batch sampling of the next phase.

(C) Changing the operator demand to the notch setting for the first mode in the next phase.

(ii) Avoid the following:

(A) Overlapping batch sampling of the two phases.

(B) An unnecessarily long delay before starting the next phase.

(iii) For example, the following sequence would generally be appropriate:

(A) End batch sampling for phase 2 after 240 seconds in notch 7.

(B) Switch the operator demand to notch 8 one second later.

(C) Begin batch sampling for phase 3 one second after switching to notch 8.

(4) If applicable, begin the smoke test at the start of the first test phase of the applicable ramped modal cycle.

Continue collecting smoke data until the completion of final test phase. Refer to § 1033.101 to determine applicability of the smoke standards and § 1033.525 for details on how to conduct a smoke test.

(5) Proceed through each test phase of the applicable ramped modal cycle in the order specified until the test is completed.

(6) If you must void a test phase you may repeat the phase. To do so, begin with a warm engine operating at the notch setting for the last mode in the previous phase. You do not need to repeat later phases if they were valid.

(Note: you must report test results for all voided tests and test phases.)

(7) Following the completion of the third test phase of the applicable ramped modal cycle, conduct the post sampling procedures specified in 40 CFR 1065.530.

TABLE 1 TO § 1033.520.—LINE-HAUL LOCOMOTIVE RAMPED MODAL CYCLE

RMC test phase	Weighting factor	RMC mode	Time in mode (seconds)	Notch setting
Pre-test idle	NA	NA	600 to 900	Lowest idle setting. ¹
Phase 1	A	600	Low Idle. ²
(Idle test)	0.380	B	600	Normal Idle.
Phase Transition				
.....	C	1000	Dynamic Brake. ³
.....	1	520	Notch 1.
.....	2	520	Notch 2.
.....	3	416	Notch 3.
.....	4	352	Notch 4.
Phase 2	0.389	5	304	Notch 5.
Phase Transition				
.....	6	144	Notch 6.
.....	7	111	Notch 7.
Phase 3	0.231	8	600	Notch 8.

¹ See paragraph (d) of this section for alternate pre-test provisions.

² Operate at normal idle for modes A and B if not equipped with multiple idle settings.

³ Operate at normal idle if not equipped with a dynamic brake.

TABLE 2 TO § 1033.520.—SWITCH LOCOMOTIVE RAMPED MODAL CYCLE

RMC test phase	Weighting factor	RMC mode	Time in mode (seconds)	Notch setting
Pre-test idle	NA	NA	600 to 900	Lowest idle setting. ¹
Phase 1	A	600	Low Idle. ²
(Idle test)	0.598	B	600	Normal Idle.
Phase Transition				
.....	1	868	Notch 1.
.....	2	861	Notch 2.
.....	3	406	Notch 3.
.....	4	252	Notch 4.
Phase 2	0.377	5	252	Notch 5.

TABLE 2 TO § 1033.520.—SWITCH LOCOMOTIVE RAMPED MODAL CYCLE—Continued

RMC test phase	Weighting factor	RMC mode	Time in mode (seconds)	Notch setting
Phase Transition				
Phase 3	0.025	6 7 8	1080 144 576	Notch 6. Notch 7. Notch 8.

¹ See paragraph (d) of this section for alternate pre-test provisions.

² Operate at normal idle for modes A and B if not equipped with multiple idle settings.

(f) Calculate your cycle-weighted brake-specific emission rates as follows:

(1) For each test phase j:

(i) Calculate emission rates (E_{ij}) for each pollutant i as the total mass emissions divided by the total time in the phase.

(ii) Calculate average power (P_j) as the total work divided by the total time in the phase.

(2) For each pollutant, calculate your cycle-weighted brake-specific emission rate using the following equation, where w_j is the weighting factor for phase j:

$$E_{ij} = \frac{w_1 E_{i1} + w_2 E_{i2} + w_3 E_{i3}}{w_1 P_1 + w_2 P_2 + w_3 P_3}$$

§ 1033.525 Smoke testing.

This section describes the equipment and procedures for testing for smoke emissions when is required.

(a) This section specifies how to measure smoke emissions using a full-flow, open path light extinction smokemeter. A light extinction meter consists of a built-in light beam that traverses the exhaust smoke plume that issues from exhaust the duct. The light beam must be at right angles to the axis of the plume. Align the light beam to go through the plume along the hydraulic diameter (defined in 1065.1001) of the exhaust stack. Where it is difficult to align the beam to have a path length equal to the hydraulic diameter (such as a long narrow rectangular duct), you may align the beam to have a different path length and correct it to be equivalent to a path length equal to the hydraulic diameter. The light extinction meter must meet the requirements of paragraph (b) of this section and the following requirements:

(1) Use an incandescent light source with a color temperature range of 2800K to 3250K, or a light source with a

spectral peak between 550 and 570 nanometers.

(2) Collimate the light beam to a nominal diameter of 3 centimeters and an angle of divergence within a 6 degree included angle.

(3) Use a photocell or photodiode light detector. If the light source is an incandescent lamp, use a detector that has a spectral response similar to the photopic curve of the human eye (a maximum response in the range of 550 to 570 nanometers, to less than four percent of that maximum response below 430 nanometers and above 680 nanometers).

(4) Attach a collimating tube to the detector with apertures equal to the beam diameter to restrict the viewing angle of the detector to within a 16 degree included angle.

(5) Amplify the detector signal corresponding to the amount of light.

(6) You may use an air curtain across the light source and detector window assemblies to minimize deposition of smoke particles on those surfaces, provided that it does not measurably affect the opacity of the plume.

(7) Minimize distance from the optical centerline to the exhaust outlet; in no case may it be more than 3.0 meters. The maximum allowable distance of unducted space upstream of the optical centerline is 0.5 meters. Center the full flow of the exhaust stream between the source and detector apertures (or windows and lenses) and on the axis of the light beam.

(8) You may use light extinction meters employing substantially identical measurement principles and producing substantially equivalent results, but which employ other electronic and optical techniques.

(b) All smokemeters must meet the following specifications:

(1) A full-scale deflection response time of 0.5 second or less.

(2) You may attenuate signal responses with frequencies higher than 10 Hz with a separate low-pass electronic filter with the following performance characteristics:

(i) Three decibel point: 10 Hz.

(ii) Insertion loss: 0.0 ± 0.5 dB.

(iii) Selectivity: 12 dB down at 40 Hz minimum.

(iv) Attenuation: 27 dB down at 40 Hz minimum.

(c) Perform the smoke test by continuously recording smokemeter response over the entire locomotive test cycle in percent opacity to within one percent resolution and also simultaneously record operator demand set point (e.g., notch position). Compare the recorded opacities to the smoke standards applicable to your locomotive.

(d) You may use a partial flow sampling smokemeter if you correct for the path length of your exhaust plume. If you use a partial flow sampling meter, follow the instrument manufacturer's installation, calibration, operation, and maintenance procedures.

§ 1033.530 Duty cycles and calculations.

This section describes how to apply the duty cycle to measured emission rates to calculate cycle-weighted average emission rates.

(a) *Standard duty cycles and calculations.* Tables 1 and 2 of this section show the duty cycle to use to calculate cycle-weighted average emission rates for locomotives equipped with two idle settings, eight propulsion notches, and at least one dynamic brake notch and tested using the Locomotive Test Cycle. Use the appropriate weighting factors for your locomotive application and calculate cycle-weighted average emissions as specified in 40 CFR part 1065, subpart G.

TABLE 1 TO § 1033.530.—STANDARD DUTY CYCLE WEIGHTING FACTORS FOR CALCULATING EMISSION RATES FOR LOCOMOTIVES WITH MULTIPLE IDLE SETTINGS

Notch setting	Test mode	Line-haul weighting factors	Line-haul weighting factors (no dynamic brake)	Switch weighting factors
Low Idle	A	0.190	0.190	0.299
Normal Idle	B	0.190	0.315	0.299
Dynamic Brake	C	0.125	(¹)	0.000
Notch 1	1	0.065	0.065	0.124
Notch 2	2	0.065	0.065	0.123
Notch 3	3	0.052	0.052	0.058
Notch 4	4	0.044	0.044	0.036
Notch 5	5	0.038	0.038	0.036
Notch 6	6	0.039	0.039	0.015
Notch 7	7	0.030	0.030	0.002
Notch 8	8	0.162	0.162	0.008

¹ Not applicable.

TABLE 2 TO § 1033.530.—STANDARD DUTY CYCLE WEIGHTING FACTORS FOR CALCULATING EMISSION RATES FOR LOCOMOTIVES WITH A SINGLE IDLE SETTING

Notch setting	Test mode	Line-haul	Line-haul (no dynamic brake)	Switch
Normal Idle	A	0.380	0.505	0.598
Dynamic Brake	C	0.125	(¹)	0.000
Notch 1	1	0.065	0.065	0.124
Notch 2	2	0.065	0.065	0.123
Notch 3	3	0.052	0.052	0.058
Notch 4	4	0.044	0.044	0.036
Notch 5	5	0.038	0.038	0.036
Notch 6	6	0.039	0.039	0.015
Notch 7	7	0.030	0.030	0.002
Notch 8	8	0.162	0.162	0.008

¹ Not applicable.

(b) *Idle and dynamic brake notches.* The test procedures generally require you to measure emissions at two idle settings and one dynamic brake, as follows:

(1) If your locomotive is equipped with two idle settings and one or more dynamic brake settings, measure emissions at both idle settings and the worst case dynamic brake setting, and weight the emissions as specified in the applicable table of this section. Where it is not obvious which dynamic brake setting represents worst case, do one of the following:

(i) You may measure emissions and power at each dynamic brake point and average them together.

(ii) You may measure emissions and power at the dynamic brake point with the lowest power.

(2) If your locomotive is equipped with two idle settings and is not equipped with dynamic brake, use a normal idle weighting factor of 0.315 for the line-haul cycle. If your locomotive is equipped with only one idle setting and no dynamic brake, use an idle weighting factor of 0.505 for the line-haul cycle.

(c) *Nonstandard notches or no notches.* If your locomotive is equipped with more or less than 8 propulsion notches, recommend an alternate test cycle based on the in-use locomotive configuration. Unless you have data demonstrating that your locomotive will be operated differently from conventional locomotives, recommend weighting factors that are consistent with the power weightings of the specified duty cycle. For example, the average load factor for your recommended cycle (cycle-weighted power divided by rated power) should be equivalent to those of conventional locomotives. We may also allow the use of the standard power levels shown in Table 3 to this section for nonstandard locomotive testing subject to our prior approval. This paragraph (c) does not allow engines to be tested without consideration of the actual notches that will be used.

TABLE 3 TO § 1033.530.—STANDARD NOTCH POWER LEVELS EXPRESSED AS A PERCENTAGE OF RATED POWER

	Percent
Normal Idle	0.00
Dynamic Brake	0.00
Notch 1	4.50
Notch 2	11.50
Notch 3	23.50
Notch 4	35.00
Notch 5	48.50
Notch 6	64.00
Notch 7	85.00
Notch 8	100.00

(d) *Optional Ramped Modal Cycle Testing.* Tables 1 and 2 of § 1033.520 show the weighting factors to use to calculate cycle-weighted average emission rates for the applicable locomotive ramped modal cycle. Use the weighting factors for the ramped modal cycle for your locomotive application and calculate cycle-weighted average emissions as specified in 40 CFR part 1065, subpart G.

(e) *Automated Start-Stop*. For locomotive equipped with features that shut the engine off after prolonged periods of idle, multiply the measured idle mass emission rate over the idle portion of the applicable test cycles by a factor equal to one minus the estimated fraction reduction in idling time that will result in use from the shutdown feature. Do not apply this factor to the weighted idle power. Application of this adjustment is subject to our approval. This paragraph (e) does not apply if the locomotive is (or will be) covered by a separate certificates for idle control.

(f) *Multi-engine locomotives*. This paragraph (f) applies for locomotives using multiple engines where all engines are identical in all material respects. In cases where we allow engine dynamometer testing, you may test a single engine consistent with good engineering judgment, as long as you test it at the operating points at which the engines will operate when installed in the locomotive (excluding stopping and starting). Weigh the results to reflect the power demand/power-sharing of the in-use configuration for each notch setting.

(g) *Representative test cycles for freshly manufactured locomotives*. As specified in this paragraph (g), manufacturers may be required to use an alternate test cycle for freshly manufactured Tier 3 and later locomotives.

(1) If you determine that you are adding design features that will make the expected average in-use duty cycle for any of your freshly manufactured locomotive engine families significantly different from the otherwise applicable test cycle (including weighting factors), you must notify us and recommend an alternate test cycle that represents the expected average in-use duty cycle. You should also obtain preliminary approval before you begin collecting data to support an alternate test cycle. We will specify whether to use the default duty cycle, your recommended cycle, or a different cycle, depending on which cycle we believe best represents expected in-use operation.

(2) The provisions of this paragraph (g) apply differently for different types of locomotives, as follows:

(i) For Tier 4 and later line-haul locomotives, use the cycle required by (g)(1) of this section to show compliance with the line-haul cycle standards.

(ii) For Tier 3 and later switch locomotives, use the cycle required by (g)(1) of this section to show compliance with the switch cycle standards.

(iii) For Tier 3 line-haul locomotives, if we specify an alternate cycle, use it

to show compliance with the line-haul cycle standards. If you include the locomotives in the ABT program of subpart H of this part, calculate line-haul cycle credits (positive or negative) using the alternate cycle and the line-haul cycle standards. Your locomotive is deemed to also generate an equal amount of switch cycle credits.

(3) For all locomotives certified using an alternate cycle, include a description of the cycle in the owners manual such that the locomotive can be remanufactured using the same cycle.

(4) For example, if your freshly manufactured line-haul locomotives are equipped with load control features that modify how the locomotive will operate when it is in a consist, and such features will cause the locomotives to operate differently from the otherwise applicable line-haul cycle, we may require you to certify using an alternate cycle.

(5) See paragraph (h) of this section for cycle-changing design features that also result in energy savings.

(h) *Calculation adjustments for energy-saving design features*. The provisions of this paragraph (h) apply for locomotives equipped with energy-saving locomotive design features. They do not apply for features that only improve the engine's brake-specific fuel consumption.

(1) Manufacturers/remanufacturers choosing to adjust emissions under this paragraph (h) must do all of the following for certification:

(i) Describe the energy-saving features in your application for certification.

(ii) Describe in your installation instruction and/or maintenance instructions all steps necessary to utilize the energy-saving features.

(2) If your design feature will also affect the locomotive's duty cycle, you must comply with the requirements of paragraph (g) of this section.

(3) Calculate energy the savings as described in this paragraph (h)(3).

(i) Estimate the expected mean in-use fuel consumption rate (on a BTU per ton-mile basis) with and without the energy saving design feature, consistent with the specifications of paragraph (h)(4) of this section. The energy savings is the ratio of fuel consumed from a locomotive operating with the new feature to fuel consumed from a locomotive operating without the feature under identical conditions. Include an estimate of the 80 percent confidence interval for your estimate of the mean, and other statistical parameters we specify.

(ii) Your estimate must be based on in-use operating data, consistent with good engineering judgment. Where we

have previously certified your design feature under this paragraph (h), we may require you to update your analysis based on all new data that are available. You must obtain preliminary approval before you begin collecting operational data for this purpose.

(iii) We may allow you to consider the effects of your design feature separately for different route types, regions, or railroads. We may require that you certify these different locomotives in different engine families and may restrict their use to the specified applications.

(iv) Design your test plan so that the operation of the locomotives with and without is as similar as possible in all material aspects (other than the design feature being evaluated). Correct all data for any relevant differences, consistent with good engineering judgment.

(v) Do not include any brake-specific energy savings in your calculated values. If it is not possible to exclude such effects from your data gathering, you must correct for these effects, consistent with good engineering judgment.

(4) Calculate adjustment factors as described in this paragraph (h)(4). If the energy savings will apply broadly, calculate and apply the adjustment on a cycle-weighted basis. Otherwise, calculate and apply the adjustment separately for each notch. To apply the adjustment, multiply the emissions (either cycle-weighted or notch-specific, as applicable) by the adjustment. Use the lower bound of the 80 percent confidence interval of the estimate of the mean as your estimated energy savings rate. We may cap your energy savings rate for this paragraph (h)(4) at 80 percent of the estimate of the mean. Calculate the emission adjustment factors as:

$$AF = 1.000 - (\text{energy savings rate})$$

§ 1033.535 Adjusting emission levels to account for infrequently regenerating aftertreatment devices.

This section describes how to adjust emission results from locomotives using aftertreatment technology with infrequent regeneration events that occur during testing. See paragraph (e) of this section for how to adjust ramped modal testing. See paragraph (f) of this section for how to adjust discrete-mode testing. For this section, "regeneration" means an intended event during which emission levels change while the system restores aftertreatment performance. For example, hydrocarbon emissions may increase temporarily while oxidizing accumulated particulate matter in a trap. Also for this section, "infrequent" refers to regeneration events that are

expected to occur on average less than once per sample period.

(a) *Developing adjustment factors.* Develop an upward adjustment factor and a downward adjustment factor for each pollutant based on measured emission data and observed regeneration frequency. Adjustment factors should generally apply to an entire engine family, but you may develop separate adjustment factors for different configurations within an engine family. If you use adjustment factors for certification, you must identify the frequency factor, F, from paragraph (b) of this section in your application for certification and use the adjustment factors in all testing for that engine family. You may use carryover or carry-across data to establish adjustment factors for an engine family, as described in § 1033.235, consistent with good engineering judgment. All adjustment factors for regeneration are additive. Determine adjustment factors separately for different test segments as described in paragraphs (e) and (f) of this section. You may use either of the following different approaches for locomotives that use aftertreatment with infrequent regeneration events:

(1) You may disregard this section if you determine that regeneration does not significantly affect emission levels for an engine family (or configuration) or if it is not practical to identify when regeneration occurs. If you do not use adjustment factors under this section, your locomotives must meet emission standards for all testing, without regard to regeneration.

(2) You may ask us to approve an alternate methodology to account for regeneration events. We will generally limit approval to cases in which your locomotives use aftertreatment technology with extremely infrequent regeneration and you are unable to apply the provisions of this section.

(b) *Calculating average emission factors.* Calculate the average emission factor (EF_A) based on the following equation:

$$EF_A = (F)(EF_H) + (1-F)(EF_L)$$

Where:

F = the frequency of the regeneration event during normal in-use operation, expressed in terms of the fraction of equivalent tests during which the regeneration occurs. You may determine F from in-use operating data or running replicate tests. For example, if you observe that the regeneration occurs 125 times during 1000 MW-hrs of operation, and your locomotive typically accumulates 1 MW-hr per test, F would be $(125) \div (1000) \times (1) = 0.125$.

EF_H = measured emissions from a test segment in which the regeneration occurs.

EF_L = measured emissions from a test segment in which the regeneration does not occur.

(c) *Applying adjustment factors.* Apply adjustment factors based on whether regeneration occurs during the test run. You must be able to identify regeneration in a way that is readily apparent during all testing.

(1) If regeneration does not occur during a test segment, add an upward adjustment factor to the measured emission rate. Determine the upward adjustment factor (UAF) using the following equation:

$$UAF = EF_A - EF_L$$

(2) If regeneration occurs or starts to occur during a test segment, subtract a downward adjustment factor from the measured emission rate. Determine the downward adjustment factor (DAF) using the following equation:

$$DAF = EF_H - EF_A$$

(d) *Sample calculation.* If EF_L is 0.10 g/bhp-hr, EF_H is 0.50 g/bhp-hr, and F is 0.10 (the regeneration occurs once for each ten tests), then:

$$EF_A = (0.10)(0.50 \text{ g/bhp-hr}) + (1.00 - 0.10)(0.10 \text{ g/bhp-hr}) = 0.14 \text{ g/bhp-hr.}$$

$$UAF = 0.14 \text{ g/bhp-hr} - 0.10 \text{ g/bhp-hr} = 0.04 \text{ g/bhp-hr.}$$

$$DAF = 0.50 \text{ g/bhp-hr} - 0.14 \text{ g/bhp-hr} = 0.36 \text{ g/bhp-hr}$$

(e) *Ramped modal testing.* Develop separate adjustment factors for each test phase. If a regeneration has started but has not been completed when you reach the end of a test phase, use good engineering judgment to reduce your downward adjustments to be proportional to the emission impact that occurred in the test phases.

(f) *Discrete-mode testing.* Develop separate adjustment factors for each test mode. If a regeneration has started but has not been completed when you reach the end of the sampling time for a test mode extend the sampling period for that mode until the regeneration is completed.

Subpart G—Special Compliance Provisions

§ 1033.601 General compliance provisions.

Locomotive manufacturer/remanufacturers, as well as owners and operators of locomotives subject to the requirements of this part, and all other persons, must observe the provisions of this part, the requirements and prohibitions in 40 CFR part 1068, and the provisions of the Clean Air Act. The provisions of 40 CFR part 1068 apply for locomotives as specified in that part, except as otherwise specified in this section.

(a) *Meaning of manufacturer.* When used in 40 CFR part 1068, the term “manufacturer” means manufacturer and/or remanufacturer.

(b) *Engine rebuilding.* The provisions of 40 CFR 1068.120 do not apply when remanufacturing locomotives under a certificate of conformity issued under this part.

(c) *Exemptions.* (1) The exemption provisions of 40 CFR 1068.240 (i.e., exemptions for replacement engines) do not apply for domestic or imported locomotives. (**Note:** You may introduce into commerce freshly manufactured replacement engines under this part, provided the locomotives into which they are installed are covered by a certificate of conformity.)

(2) The exemption provisions of 40 CFR 1068.250 and 1068.255 (i.e., exemptions for hardship relief) do not apply for domestic or imported locomotives. See § 1033.620 for provisions related to hardship relief.

(3) The exemption provisions of 40 CFR 1068.260 (i.e., exemptions for delegated assembly) do not apply for domestic or imported locomotives, except as specified in § 1033.630.

(4) The provisions for importing engines and equipment under the identical configuration exemption of 40 CFR 1068.315(i) do not apply for locomotives.

(5) The provisions for importing engines and equipment under the ancient engine exemption of 40 CFR 1068.315(j) do not apply for locomotives.

(d) *SEAs, defect reporting, and recall.* The provisions of 40 CFR part 1068, subpart E (i.e., SEA provisions) do not apply for locomotives. Except as noted in this paragraph (d), the provisions of 40 CFR part 1068, subpart F, apply to certificate holders for locomotives as specified for manufacturers in that part.

(1) When there are multiple persons meeting the definition of manufacturer or remanufacturer, each person meeting the definition of manufacturer or remanufacturer must comply with the requirements of 40 CFR part 1068, subpart F, as needed so that the certificate holder can fulfill its obligations under those subparts.

(2) The defect investigation requirements of 40 CFR 1068.501(a)(5), (b)(1) and (b)(2) do not apply for locomotives. Instead, use good engineering judgment to investigate emission-related defects consistent with normal locomotive industry practice for investigating defects. You are not required to track parts shipments as indicators of possible defects.

(e) *Introduction into commerce.* The placement of a new locomotive or new

locomotive engine back into service following remanufacturing is a violation of 40 CFR 1068.101(a)(1), unless it has a valid certificate of conformity for its model year and the required label.

§ 1033.610 Small railroad provisions.

In general, the provisions of this part apply for all locomotives, including those owned by Class II and Class III railroads. This section describes how these provisions apply for railroads meeting the definition of “small railroad” in § 1033.901. (**Note:** The term “small railroad” excludes all Class II railroads and some Class III railroads, such as those owned by large parent companies.)

(a) Locomotives become subject to the provisions of this part when they become “new” as defined in § 1033.901. Under that definition, a locomotive is “new” when first assembled, and generally becomes “new” again when remanufactured. As an exception to this general concept, locomotives that are owned and operated by railroads meeting the definition of “small railroad” in § 1033.901 do not become “new” when remanufactured, unless they were previously certified to EPA emission standards. Certificate holders may require written confirmation from the owner/operator that the locomotive qualifies as a locomotive that is owned and operated by a small railroad. Such written confirmation to a certificate holder is deemed to also be a submission to EPA and is thus subject to the reporting requirements of 40 CFR 1068.101.

(b) The provisions of subpart I of this part apply to all owners and operators of locomotives subject to this part 1033. However, the regulations of that subpart specify some provisions that apply only for Class I freight railroads, and others that apply differently to Class I freight railroads and other railroads.

(c) We may exempt new locomotives that are owned or operated by small railroads from the prohibition against remanufacturing a locomotive without a certificate of conformity as specified in this paragraph (c). This exemption is only available in cases where no certified remanufacturing system is available for the locomotive. For example, it is possible that no remanufacturer will certify a system for very old locomotive models that comprise a tiny fraction of the fleet and that are remanufactured infrequently. We will grant the exemption in all cases in which no remanufacturing system has been certified for the applicable engine family and model year. We may also grant an exemption where we determine that a certified system is

unavailable. We may consider the issue of excessive costs in determining the availability of certified systems. If we grant this exemption for a previously certified locomotive, you are required to return the locomotive to its previously certified configuration. Send your request for such exemptions to the Designated Compliance Officer.

(d) Non-Class I railroads that do not meet the definition of “small railroad” in § 1033.901 may ask that their remanufactured locomotives be excluded from the definition of “new” in § 1033.901 in cases where no certified remanufacturing system is available for the locomotive. We will grant the exemption in all cases in which no remanufacturing system has been certified for the applicable engine family and model year. If we grant this exemption for a previously certified locomotive, you are required to return the locomotive to its previously certified configuration. Send your request for such exemptions to the Designated Compliance Officer.

§ 1033.615 Voluntarily subjecting locomotives to the standards of this part.

The provisions of this section specify the cases in which an owner or manufacturer of a locomotive or similar piece of equipment can subject it to the standards and requirements of this part. Once the locomotive or equipment becomes subject to the locomotive standards and requirements of this part, it remains subject to the standards and requirements of this part for the remainder of its service life.

(a) *Equipment excluded from the definition of “locomotive”.* (1) Manufacturers/remanufacturers of equipment that is excluded from the definition of “locomotive” because of its total power, but would otherwise meet the definition of locomotive may ask to have it considered to be a locomotive. To do this, submit an application for certification as specified in subpart C of this part, explaining why it should be considered to be a locomotive. If we approve your request, it will be deemed to be a locomotive for the remainder of its service life.

(2) In unusual circumstances, we may deem other equipment to be locomotives (at the request of the owner or manufacturer/remanufacturer) where such equipment does not conform completely to the definition of locomotive, but is functionally equivalent to a locomotive.

(b) *Locomotives excluded from the definition of “new”.* Owners of remanufactured locomotives excluded from the definition of “new” in § 1033.901 under paragraph (2) of that

definition may choose to upgrade their locomotives to subject their locomotives to the standards and requirements of this part by complying with the specifications of a certified remanufacturing system, including the labeling specifications of § 1033.135.

§ 1033.620 Hardship provisions for manufacturers and remanufacturers.

(a) If you qualify for the economic hardship provisions specified in 40 CFR 1068.245, we may approve a period of delayed compliance for up to one model year total.

(b) The provisions of this paragraph (b) are intended to address problems that could occur near the date on which more stringent emission standards become effective, such as the transition from the Tier 2 standards to the Tier 3 standards for line-haul locomotives on January 1, 2012.

(1) In appropriate extreme and unusual circumstances that are clearly outside the control of the manufacturer and could not have been avoided by the exercise of prudence, diligence, and due care, we may permit you, for a brief period, to introduce into commerce locomotives which do not comply with the applicable emission standards if all of the following conditions apply:

(i) You cannot reasonably manufacture the locomotives in such a manner that they would be able to comply with the applicable standards.

(ii) The manufacture of the locomotives was substantially completed prior to the applicability date of the standards from which you seek the relief. For example, you may not request relief for a locomotive that has been ordered, but for which you will not begin the assembly process prior to the applicability date of the standards. On the other hand, we would generally consider completion of the underframe weldment to be a substantial part of the manufacturing process.

(iii) Manufacture of the locomotives was previously scheduled to be completed at such a point in time that locomotives would have been included in the previous model year, such that they would have been subject to less stringent standards, and that such schedule was feasible under normal conditions.

(iv) You demonstrate that the locomotives comply with the less stringent standards that applied to the previous model year’s production described in paragraph (b)(1)(iii) of this section, as prescribed by subpart C of this part (i.e., that the locomotives are identical to locomotives certified in the previous model year).

(v) You exercised prudent planning, were not able to avoid the violation, and have taken all reasonable steps to minimize the extent of the nonconformity.

(vi) We approve your request before you introduce the locomotives into commerce.

(2) You must notify us as soon as you become aware of the extreme or unusual circumstances.

(3)(i) Include locomotives for which we grant relief under this section in the engine family for which they were originally intended to be included.

(ii) Where the locomotives are to be included in an engine family that was certified to an FEL above the applicable standard, you must reserve credits to cover the locomotives covered by this allowance and include the required information for these locomotives in the end-of-year report required by subpart H of this part.

(c) In granting relief under this section, we may also set other conditions as appropriate, such as requiring payment of fees to negate an economic gain that such relief would otherwise provide.

§ 1033.625 Special certification provisions for non-locomotive-specific engines.

You may certify freshly manufactured or remanufactured locomotives using non-locomotive-specific engines (as defined in (1033.901) using the normal certification procedures of this part. Locomotives certified in that way are generally treated the same as other locomotives, except where specified otherwise. The provisions of this section provide for design certification to the locomotive standards in this part for locomotives using engines included in engine families certified under 40 CFR part 1039 (or part 89) in limited circumstances.

(a) Remanufactured or freshly manufactured switch locomotives powered by non-locomotive-specific engines may be certified by design without the test data required by 1033.235 if all of the following are true:

(1) Before being installed in the locomotive, the engines were covered by a certificate of conformity issued under 40 CFR Part 1039 (or part 89) that is effective for the calendar year in which the manufacture or remanufacture occurs. You may use engines certified during the previous year if it is subject to the same standards. You may not make any modifications to the engines unless we approve them.

(2) The engines were certified to standards that are numerically lower than the applicable locomotive standards of this part.

(3) More engines are reasonably projected to be sold and used under the certificate for non-locomotive use than for use in locomotives.

(4) The number of such locomotives certified under this section does not exceed 30 in any three-year period. We may waive this sales limit for locomotive models that have previously demonstrated compliance with the locomotive standards of § 1033.101 in-use.

(5) We approved the application as specified in paragraph (d) of this section.

(b) To certify your locomotives by design under this section, submit your application as specified in § 1033.205, except include the following instead of the locomotive test data otherwise required:

(1) A description of the engines to be used, including the name of the engine manufacturer and engine family identifier for the engines.

(2) A brief engineering analysis describing how the engine's emission controls will function when installed in the locomotive throughout the locomotive's useful life.

(3) The emission data submitted under 40 CFR part 1039 (or part 89).

(c) Locomotives certified under this section are subject to all of the same requirements of this part unless specified otherwise in this section. The engines used in such locomotives are not considered to be included in the otherwise applicable engines family of 40 CFR part 1039 (or part 89).

(d) We will approve or deny the application as specified in subpart C of this part. For example, we will deny your application for certification by design under this section in any case where we have evidence that your locomotives will not conform to the requirements of this part throughout their useful lives.

§ 1033.630 Staged-assembly and delegated assembly exemptions.

(a) *Staged assembly.* You may ask us to provide a temporary exemption to allow you to complete production of your engines and locomotives at different facilities, as long as you maintain control of the engines until they are in their certified configuration. We may require you to take specific steps to ensure that such locomotives are in their certified configuration before reaching the ultimate purchaser. You may request an exemption under this paragraph (a) in your application for certification, or in a separate submission. If you include your request in your application, your exemption is approved when we grant your

certificate. Note that no exemption is needed to ship an engine that has been assembled in its certified configuration, is properly labeled, and will not require an aftertreatment device to be attached when installed in the locomotive.

(b) *Delegated assembly.* This paragraph (b) applies where the engine manufacturer/remanufacturer does not complete assembly of the locomotives and the engine is shipped after being manufactured or remanufactured (partially or completely). The provisions of this paragraph (b) apply differently depending on who holds the certificate of conformity and the state of the engine when it is shipped. You may request an exemption under this paragraph (b) in your application for certification, or in a separate submission. If you include your request in your application, your exemption is approved when we grant your certificate. A manufacturer/remanufacturer may request an exemption under 40 CFR 1068.260 instead of under this section.

(1) In cases where an engine has been assembled in its certified configuration, properly labeled, and will not require an aftertreatment device to be attached when installed in the locomotive, no exemption is needed to ship the engine. You do not need an exemption to ship engines without specific components if they are not emission-related components identified in Appendix I of 40 CFR part 1068.

(2) In cases where an engine has been properly labeled by the certificate holder and assembled in its certified configuration except that it does not yet have a required aftertreatment device, an exemption is required to ship the engine. You may ask for this exemption if you do all of the following:

(i) You note on the Engine Emission Control Information label that the locomotive must include the aftertreatment device to be covered by the certificate.

(ii) You make clear in your emission-related installation instructions that installation of the aftertreatment device is required for the locomotive to be covered by the certificate.

(3) In cases where an engine will be shipped to the certificate holder in an uncertified configuration, an exemption is required to ship the engine. You may ask for this exemption under 40 CFR 1068.262.

(c) *Other exemptions.* In unusual circumstances, you may ask us to provide an exemption for an assembly process that is not covered by the provisions of paragraphs (a) and (b) of this section. We will make the exemption conditional based on you complying with requirements that we

determine are necessary to ensure that the locomotives are assembled in their certified configuration before being placed (back) into service.

§ 1033.640 Provisions for repowered and refurbished locomotives.

(a) The provisions of this section apply for locomotives that are produced from an existing locomotive so that the new locomotive contains both previously used parts and parts that have never been used before.

(1) Repowered locomotives are used locomotives in which a freshly manufactured propulsion engine is installed. As described in this section, a repowered locomotive is deemed to be either remanufactured or freshly manufactured, depending on the total amount of unused parts on the locomotive. It may also be deemed to be a refurbished locomotive.

(2) Refurbished locomotives are locomotives that contain more unused parts than previously used parts. As described in this section, a locomotive containing more unused parts than previously used parts may be deemed to be either remanufactured or freshly manufactured, depending on the total amount of unused parts on the locomotive. Note that § 1033.101 defines refurbishment of a pre-1973 locomotive to be an upgrade of the locomotive.

(b) A single existing locomotive cannot be divided into parts and combined with new parts to create more than one remanufactured locomotive. However, any number of locomotives can be divided into parts and combined with new parts to create more than one remanufactured locomotive, provide the number of locomotives created (remanufactured and freshly manufactured) does not exceed the number of locomotives that were disassembled.

(c) You may determine the relative amount of previously used parts consistent with the specifications of the Federal Railroad Administration. Otherwise, determine the relative amount of previously used parts as follows:

(1) Identify the parts in the fully assembled locomotive that have been previously used and those that have never been used before.

(2) Weight the unused parts and previously used parts by the dollar value of the parts. For example, a single part valued at \$1200 would count the same as six parts valued at \$200 each. Group parts by system where possible (such as counting the engine as one part) if either all the parts in that system are used or all the parts in that system are unused. Calculate the used part

values using dollar values from the same year as the new parts.

(3) Sum the values of the unused parts. Also sum the values of the previously used parts. The relative fraction of used parts is the total value of previously used parts divided by the combined value of the unused parts and previously used parts.

(c) If the weighted fraction of the locomotive that is comprised of previously used parts is greater than or equal to 25 percent, then the locomotive is considered to be a remanufactured locomotive and retains its original date of manufacture. Note, however, that if the weighted fraction of the locomotive that is comprised of previously used parts is less than 50 percent, then the locomotive is also considered to be a refurbished locomotive.

(d) If the weighted fraction of the locomotive that is comprised of previously used parts is less than 25 percent, then the locomotive is deemed to be a freshly manufactured locomotive and the date of original manufacture is the most recent date on which the locomotive was assembled using less than 25 percent previously used parts. For example:

(1) If you produce a new locomotive that includes a used frame, but all other parts are unused, then the locomotive would likely be considered to be a freshly manufactured locomotive because the value of the frame would likely be less than 25 percent of the total value of the locomotive. Its date of original manufacture would be the date on which you complete its assembly.

(2) If you produce a new locomotive by replacing the engine in a 1990 locomotive with a freshly manufactured engine, but all other parts are used, then the locomotive would likely be considered to be a remanufactured locomotive and its date of original manufacture is the date on which assembly was completed in 1990. (**Note:** such a locomotive would also be considered to be a repowered locomotive.)

(e) Locomotives containing used parts that are deemed to be freshly manufactured locomotives are subject to the same provisions as all other freshly manufactured locomotives. Other refurbished locomotives are subject to the same provisions as other remanufactured locomotives, with the following exceptions:

(1) *Switch locomotives.* (i) Prior to January 1, 2015, remanufactured Tier 0 switch locomotives that are deemed to be refurbished are subject to the Tier 0 line-haul cycle and switch cycle standards. Note that this differs from the requirements applicable to other Tier 0

switch locomotives, which are not subject to the Tier 0 line-haul cycle standards.

(ii) Beginning January 1, 2015, remanufactured Tier 3 and earlier switch locomotives that are deemed to be refurbished are subject to the Tier 3 switch standards.

(2) *Line-haul locomotives.*

Remanufactured line-haul locomotives that are deemed to be refurbished are subject to the same standards as freshly manufactured line-haul locomotives, except that line-haul locomotives with rated power less than 3000 hp that are refurbished before January 1, 2015 are subject to the same standards as refurbished switch locomotives under paragraph (e)(1)(i) of this section. However, line-haul locomotives less than 3000 hp may not generate emission credits relative to the standards specified in paragraph (e)(1)(i) of this section.

(3) *Labels for switch and line-haul locomotives.* Remanufacturers that refurbish a locomotive must add a secondary locomotive label that includes the following:

(i) The label heading: "REFURBISHED LOCOMOTIVE EMISSION CONTROL INFORMATION."

(ii) The statement identifying when the locomotive was refurbished and what standards it is subject to, as follows: "THIS LOCOMOTIVE WAS REFURBISHED IN [year of refurbishment] AND MUST COMPLY WITH THE TIER [applicable standard level] EACH TIME THAT IT IS REMANUFACTURED, EXCEPT AS ALLOWED BY 40 CFR 1033.750."

§ 1033.645 Non-OEM component certification program.

This section describes a voluntary program that allows you to get EPA approval of components you manufacture for use during remanufacturing.

(a) *Applicability.* This section applies only for components replaced during remanufacturing. It does not apply for other components that are replaced during a locomotive's useful life.

(1) The following components are eligible for approval under this section:

- (i) Cylinder liners.
- (ii) Pistons.
- (iii) Piston rings.
- (iv) Heads.
- (v) Fuel injectors.
- (vi) Turbochargers.
- (vii) Aftercoolers and intercoolers.

(2) Catalysts and electronic controls are not eligible for approval under this section.

(3) We may determine that other types of components can be certified under

this section, consistent with good engineering judgment.

(b) *Approval.* To obtain approval, submit your request to the Designated Compliance Officer.

(1) Include all of the following in your request:

(i) A description of the component(s) for which you are requesting approval.

(ii) A list of all engine/locomotive models and engine families for which your component would be used. You may exclude models that are not subject to our standards or will otherwise not be remanufactured under a certificate of conformity.

(iii) A copy of the maintenance instructions for engines using your component. You may reference the other certificate holder's maintenance instructions in your instructions. For example, your instructions may specify to follow the other certificate holder's instructions in general, but list one or more exceptions to address the specific maintenance needs of your component.

(iv) An engineering analysis (including test data in some cases) demonstrating to us that your component will not cause emissions to increase. The analysis must address both low-hour and end-of-useful life emissions. The amount of information required for this analysis is less than is required to obtain a certificate of conformity under subpart C of this part and will vary depending on the type of component being certified.

(v) The following statement signed by an authorized representative of your company: We submit this request under 40 CFR 1033.645. All the information in this report is true and accurate to the best of my knowledge. I know of the penalties for violating the Clean Air Act and the regulations. (Authorized Company Representative)

(2) If we determine that there is reasonable technical basis to believe that your component is sufficiently equivalent that it will not increase emissions, we will approve your request and you will be a certificate holder for your components with respect to actual emissions performance for all locomotives that use those components (in accordance with this section).

(c) *Liability.* Being a certificate holder under this section means that if in-use testing indicates that a certified locomotive using one or more of your approved components does not comply with an applicable emission standard, we will presume that you and other certificate holders are liable for the noncompliance. However, we will not hold you liable in cases where you convince us that your components did not cause the noncompliance.

Conversely, we will not hold other certificate holders liable for noncompliance caused solely by your components. You are also subject to the warranty and defect reporting requirements of this part for your certified components. Other requirements of this part apply as specified in § 1033.1.

(d) *In-use testing.* Locomotives containing your components must be tested according to the provisions of this paragraph (d).

(1) Except as specified in paragraph (d)(5) of this section, you must test at least one locomotive if 250 locomotives use your component under this section. You must test one additional locomotive for the next additional 500 locomotives that use your component under this section. After that, we may require you to test one additional locomotive for each additional 1000 locomotives that use your component under this section. These numbers apply across model years. For example, if your component is used in 125 remanufactures per year under this section, you must test one of the first 250 locomotives, one of the next 500 locomotives, and up to one every eight years after that. Do not count locomotives that use your components but are not covered by this section.

(2) Except for the first locomotive you test for a specific component under this section, locomotives tested under this paragraph (d) must be past the half-way point of the useful life in terms of MW-hrs. For the first locomotive you test, select a locomotive that has operated between 25 and 50 percent of its useful life.

(3) Unless we approve a different schedule, you must complete testing and report the results to us within 180 days of the earliest point at which you could complete the testing based on the hours of operation accumulated by the locomotives. For example, if 250 or more locomotives use your part under this section, and the first of these to reach 25 percent of its useful life does so on March 1st of a given year, you must complete testing of one of the first 250 locomotives and report to us by August 28th of that year.

(4) Unless we approve different test procedures, you must test the locomotive according to the procedures specified in subpart F of this part.

(5) If any locomotives fail to meet all standards, we may require you to test one additional locomotive for each locomotive that fails. You may choose to accept that your part is causing an emission problem rather than continuing testing. You may also test additional locomotives at any time. We will consider failure rates, average

emission levels and the existence of any defects among other factors in determining whether to pursue remedial action. We may order a recall pursuant to 40 CFR part 1068 before you complete testing additional locomotives.

(6) You may ask us to allow you to rely on testing performed by others instead of requiring you to perform testing. For example, if a railroad tests a locomotive with your component as part of its testing under § 1033.810, you may ask to submit those test data as fulfillment of your test obligations under this paragraph (d). If a given test locomotive uses different components certified under this section that were manufactured by different manufacturers (such as rings from one manufacturer and cylinder liners from another manufacturer), a single test of it may be counted towards both manufacturers' test obligations. In unusual circumstances, you may also ask us to grant you hardship relief from the testing requirements of this paragraph (d). In determining whether to grant you relief, we will consider all relevant factors including the extent of the financial hardship to your company and whether the test data are available from other sources, such as testing performed by a railroad.

(e) Components certified under this section may be used when remanufacturing Category 2 engines under 40 CFR part 1042.

§ 1033.650 Incidental use exemption for Canadian and Mexican locomotives.

You may ask us to exempt from the requirements and prohibitions of this part locomotives that are operated primarily outside of the United States and that enter the United States temporarily from Canada or Mexico. We will approve this exemption only where we determine that the locomotive's operation within the United States will not be extensive and will be incidental to its primary operation. For example, we would generally exempt locomotives that will not operate more than 25 miles from the border and will operate in the United States less than 5 percent of their operating time. For existing operations, you must request this exemption before January 1, 2011. In your request, identify the locomotives for which you are requesting an exemption, and describe their projected use in the United States. We may grant the exemption broadly or limit the exemption to specific locomotives and/or specific geographic areas. However, we will typically approve exemptions for specific rail facilities rather than specific locomotives. In unusual circumstances, such as cases in which

new rail facilities are created, we may approve requests submitted after January 1, 2011.

§ 1033.655 Special provisions for certain Tier 0/Tier 1 locomotives.

(a) The provisions of this section apply only for the following locomotives (and locomotives in the same engine families as these locomotives):

(1) Locomotives listed in Table 1 of this section originally manufactured 1986–1994 by General Electric Company that have never been equipped with separate loop aftercooling. The section also applies for the equivalent passenger locomotives.

TABLE 1 TO § 1033.655

8–40C	P32ACDM
8–40B	P42DC
8–32B	8–40BPH
8–40CW	P40DC
8–40BW	8–32BWH
8–40CM	C39–8
8–41CW	B39–8E
8–44CW	

(2) SD70MAC and SD70IAC locomotives originally manufactured 1996–2000 by EMD.

(b) Any certifying remanufacturer may request relief for the locomotives covered by this section.

(c) You may ask us to allow these locomotives to exceed otherwise applicable line-haul cycle NO_x standard for high ambient temperatures and/or altitude because of limitations of the cooling system. However, the NO_x emissions may exceed the otherwise applicable standard only to the extent necessary. Relief is limited to the following conditions:

(1) For General Electric locomotives, you may ask for relief for ambient temperatures above 23 °C and/or barometric pressure below 97.5 kPa (28.8 in. Hg). NO_x emissions may not exceed 9.5 g/bhp-hr over the line-haul cycle for any temperatures up to 105 °F and any altitude up to 7000 feet above sea level.

(2) For EMD locomotives, you may ask for relief for ambient temperatures above 30 °C and/or barometric pressure below 97.5 kPa (28.8 in. Hg). NO_x emissions may not exceed 8.0 g/bhp-hr over the line-haul cycle for any temperatures up to 105 °F and any altitude up to 7000 feet above sea level.

(d) All other standards and requirements in this part apply as specified.

(e) To request this relief, submit to the Designated Compliance Officer along with your application for certification an engineering analysis showing how

your emission controls operate for the following conditions:

(1) Temperatures 23–40 °C at any altitude up to 7000 feet above sea level.

(2) Altitudes 1000–7000 feet above sea level for any temperature from 15–40 °C.

Subpart H—Averaging, Banking, and Trading for Certification

§ 1033.701 General provisions.

(a) You may average, bank, and trade (ABT) emission credits for purposes of certification as described in this subpart to show compliance with the standards of this part. Participation in this program is voluntary.

(b) Section 1033.740 restricts the use of emission credits to certain averaging sets.

(c) The definitions of Subpart J of this part apply to this subpart. The following definitions also apply:

(1) *Actual emission credits* means emission credits you have generated that we have verified by reviewing your final report.

(2) *Applicable emission standard* means an emission standard that is specified in subpart B of this part. Note that for other subparts, “applicable emission standard” is defined to also include FELs.

(3) *Averaging set* means a set of locomotives in which emission credits may be exchanged only with other locomotives in the same averaging set.

(4) *Broker* means any entity that facilitates a trade of emission credits between a buyer and seller.

(5) *Buyer* means the entity that receives emission credits as a result of a trade.

(6) *Reserved emission credits* means emission credits you have generated that we have not yet verified by reviewing your final report.

(7) *Seller* means the entity that provides emission credits during a trade.

(8) *Trade* means to exchange emission credits, either as a buyer or seller.

(9) *Transfer* means to convey control of credits generated for an individual locomotive to the purchaser, owner, or operator of the locomotive at the time of manufacture or remanufacture; or to convey control of previously generated credits from the purchaser, owner, or operator of an individual locomotive to the manufacturer/remanufacturer at the time of manufacture/remanufacture.

(d) You may not use emission credits generated under this subpart to offset any emissions that exceed an FEL or standard. This applies for all testing, including certification testing, in-use testing, selective enforcement audits, and other production-line testing.

However, if emissions from a locomotive exceed an FEL or standard (for example, during a selective enforcement audit), you may use emission credits to recertify the engine family with a higher FEL that applies only to future production.

(e) Engine families that use emission credits for one or more pollutants may not generate positive emission credits for another pollutant.

(f) Emission credits may be used in the model year they are generated or in future model years. Emission credits may not be used for past model years.

(g) You may increase or decrease an FEL during the model year by amending your application for certification under § 1033.225. The new FEL may apply only to locomotives you have not already introduced into commerce. Each locomotive’s emission control information label must include the applicable FELs. You must conduct production line testing to verify that the emission levels are achieved.

(h) Credits may be generated by any certifying manufacturer/remanufacturer and may be held by any of the following entities:

(1) Locomotive or engine manufacturers.

(2) Locomotive or engine remanufacturers.

(3) Locomotive owners.

(4) Locomotive operators.

(5) Other entities after notification to EPA.

(i) All locomotives that are certified to an FEL that is different from the emission standard that would otherwise apply to the locomotives are required to comply with that FEL for the remainder of their service lives, except as allowed by § 1033.750.

(1) Manufacturers must notify the purchaser of any locomotive that is certified to an FEL that is different from the emission standard that would otherwise apply that the locomotive is required to comply with that FEL for the remainder of its service life.

(2) Remanufacturers must notify the owner of any locomotive or locomotive engine that is certified to an FEL that is different from the emission standard that would otherwise apply that the locomotive (or the locomotive in which the engine is used) is required to comply with that FEL for the remainder of its service life.

(j) The FEL to which the locomotive is certified must be included on the locomotive label required in § 1033.135. This label must include the notification specified in paragraph (i) of this section.

§ 1033.705 Calculating emission credits.

The provisions of this section apply separately for calculating emission credits for NO_x or PM.

(a) Calculate positive emission credits for an engine family that has an FEL below the otherwise applicable emission standard. Calculate negative emission credits for an engine family that has an FEL above the otherwise applicable emission standard. Do not round until the end of year report.

(b) For each participating engine family, calculate positive or negative emission credits relative to the otherwise applicable emission standard. For the end of year report, round calculated emission credits to the nearest one hundredth of a megagram (0.01 Mg). Round your end of year emission credit balance to the nearest megagram (Mg). Use consistent units throughout the calculation. When useful life is expressed in terms of megawatt-hrs, calculate credits for each engine family from the following equation:
 Emission credits = (Std - FEL) × (1.341) × (UL) × (Production) × (F_p) × (10⁻³ kW-Mg/MW-g).

Where:

Std = the applicable NO_x or PM emission standard in g/bhp-hr (except that Std = previous FEL in g/bhp-hr for locomotives that were certified under this part to an FEL other than the standard during the previous useful life).

FEL = the family emission limit for the engine family in g/bhp-hr.

UL = the sales-weighted average useful life in megawatt-hours (or the subset of the engine family for which credits are being calculated), as specified in the application for certification.

Production = the number of locomotives participating in the averaging, banking, and trading program within the given engine family during the calendar year (or the number of locomotives in the subset of the engine family for which credits are being calculated). Quarterly production projections are used for initial certification. Actual applicable production/sales volumes are used for end-of-year compliance determination.

F_p = the proration factor as determined in paragraph (d) of this section.

(c) When useful life is expressed in terms of miles, calculate the useful life in terms of megawatt-hours (UL) by dividing the useful life in miles by 100,000, and multiplying by the sales-weighted average rated power of the engine family. For example, if your useful life is 800,000 miles for a family with an average rated power of 3,500 hp, then your equivalent MW-hr useful life would be 28,000 MW-hrs. Credits are calculated using this UL value in the equations of paragraph (b) of this section.

(d) The proration factor is an estimate of the fraction of a locomotive's service life that remains as a function of age. The proration factor is 1.00 for freshly manufactured locomotives.

(1) The locomotive's age is the length of time in years from the date of original manufacture to the date at which the remanufacture (for which credits are being calculated) is completed, rounded to the next higher year.

(2) The proration factors for line-haul locomotives ages 1 through 20 are specified in Table 1 to this section. For line-haul locomotives more than 20 years old, use the proration factor for 20 year old locomotives. The proration factors for switch locomotives ages 1 through 40 are specified in Table 2 to this section. For switch locomotives more than 40 years old, use the proration factor for 40 year old locomotives.

(3) For repower engines, the proration factor is based on the age of the locomotive chassis, not the age of the engine, except for remanufactured locomotives that qualify as refurbished. The minimum proration factor for remanufactured locomotives that meet the definition of refurbished but not freshly manufactured is 0.60. (Note: The proration factor is 1.00 for all locomotives that meet the definition of freshly manufactured.)

TABLE 1 TO § 1033.705.—PRORATION FACTORS FOR LINE-HAUL LOCOMOTIVES

Locomotive age (years)	Proration factor (F _p)
1	0.96
2	0.92
3	0.88
4	0.84
5	0.81
6	0.77
7	0.73
8	0.69
9	0.65
10	0.61
11	0.57
12	0.54
13	0.50
14	0.47
15	0.43
16	0.40
17	0.36
18	0.33
19	0.30
20	0.27

TABLE 2 TO § 1033.705.—PRORATION FACTORS FOR SWITCH LOCOMOTIVES

Locomotive age (years)	Proration factor (F _p)
1	0.98

TABLE 2 TO § 1033.705.—PRORATION FACTORS FOR SWITCH LOCOMOTIVES—Continued

Locomotive age (years)	Proration factor (F _p)
2	0.96
3	0.94
4	0.92
5	0.90
6	0.88
7	0.86
8	0.84
9	0.82
10	0.80
11	0.78
12	0.76
13	0.74
14	0.72
15	0.70
16	0.68
17	0.66
18	0.64
19	0.62
20	0.60
21	0.58
22	0.56
23	0.54
24	0.52
25	0.50
26	0.48
27	0.46
28	0.44
29	0.42
30	0.40
31	0.38
32	0.36
33	0.34
34	0.32
35	0.30
36	0.28
37	0.26
38	0.24
39	0.22
40	0.20

(e) In your application for certification, base your showing of compliance on projected production volumes for locomotives that will be placed into service in the United States. As described in § 1033.730, compliance with the requirements of this subpart is determined at the end of the model year based on actual production volumes for locomotives that will be placed into service in the United States. Do not include any of the following locomotives to calculate emission credits:

(1) Locomotives permanently exempted under subpart G of this part or under 40 CFR part 1068.

(2) Exported locomotives. You may ask to include locomotives sold to Mexican or Canadian railroads if they will likely operate within the United States and you include all such locomotives (both credit using and credit generating locomotives).

(3) Locomotives not subject to the requirements of this part, such as those excluded under § 1033.5.

(4) Any other locomotives, where we indicate elsewhere in this part 1033 that they are not to be included in the calculations of this subpart.

§ 1033.710 Averaging emission credits.

(a) Averaging is the exchange of emission credits among your engine families. You may average emission credits only as allowed by § 1033.740.

(b) You may certify one or more engine families to an FEL above the applicable emission standard, subject to the FEL caps and other provisions in subpart B of this part, if you show in your application for certification that your projected balance of all emission-credit transactions in that model year is greater than or equal to zero.

(c) If you certify an engine family to an FEL that exceeds the otherwise applicable emission standard, you must obtain enough emission credits to offset the engine family's deficit by the due date for the final report required in § 1033.730. The emission credits used to address the deficit may come from your other engine families that generate emission credits in the same model year, from emission credits you have banked, or from emission credits you obtain through trading or by transfer.

§ 1033.715 Banking emission credits.

(a) Banking is the retention of emission credits by the manufacturer/remanufacturer generating the emission credits (or owner/operator, in the case of transferred credits) for use in averaging, trading, or transferring in future model years. You may use banked emission credits only as allowed by § 1033.740.

(b) You may use banked emission credits from the previous model year for averaging, trading, or transferring before we verify them, but we may revoke these emission credits if we are unable to verify them after reviewing your reports or auditing your records.

(c) Reserved credits become actual emission credits only when we verify them after reviewing your final report.

§ 1033.720 Trading emission credits.

(a) Trading is the exchange of emission credits between certificate holders. You may use traded emission credits for averaging, banking, or further trading transactions. Traded emission credits may be used only as allowed by § 1033.740.

(b) You may trade actual emission credits as described in this subpart. You may also trade reserved emission credits, but we may revoke these emission credits based on our review of

your records or reports or those of the company with which you traded emission credits.

(c) If a negative emission credit balance results from a transaction, both the buyer and seller are liable, except in cases we deem to involve fraud. See § 1033.255(e) for cases involving fraud. We may void the certificates of all engine families participating in a trade that results in a manufacturer/remanufacturer having a negative balance of emission credits. See § 1033.745.

§ 1033.722 Transferring emission credits.

(a) Credit transfer is the conveying of control over credits, either:

(1) From a certifying manufacturer/remanufacturer to an owner/operator.

(2) From an owner/operator to a certifying manufacturer/remanufacturer.

(b) Transferred credits can be:

(1) Used by a certifying manufacturer/remanufacturer in averaging.

(2) Transferred again within the model year.

(3) Reserved for later banking. Transferred credits may not be traded unless they have been previously banked.

(c) Owners/operators participating in credit transfers must submit the reports specified in § 1033.730.

§ 1033.725 Requirements for your application for certification.

(a) You must declare in your application for certification your intent to use the provisions of this subpart for each engine family that will be certified using the ABT program. You must also declare the FELs you select for the engine family for each pollutant for which you are using the ABT program. Your FELs must comply with the specifications of subpart B of this part, including the FEL caps. FELs must be expressed to the same number of decimal places as the applicable emission standards.

(b) Include the following in your application for certification:

(1) A statement that, to the best of your belief, you will not have a negative balance of emission credits for any averaging set when all emission credits are calculated at the end of the year.

(2) Detailed calculations of projected emission credits (positive or negative) based on projected production volumes.

§ 1033.730 ABT reports.

(a) If any of your engine families are certified using the ABT provisions of this subpart, you must send an end-of-year report within 90 days after the end of the model year and a final report within 270 days after the end of the

model year. We may waive the requirement to send the end-of-year report, as long as you send the final report on time.

(b) Your end-of-year and final reports must include the following information for each engine family participating in the ABT program:

(1) Engine family designation.

(2) The emission standards that would otherwise apply to the engine family.

(3) The FEL for each pollutant. If you changed an FEL during the model year, identify each FEL you used and calculate the positive or negative emission credits under each FEL. Also, describe how the applicable FEL can be identified for each locomotive you produced. For example, you might keep a list of locomotive identification numbers that correspond with certain FEL values.

(4) The projected and actual production volumes for the model year that will be placed into service in the United States as described in § 1033.705. If you changed an FEL during the model year, identify the actual production volume associated with each FEL.

(5) Rated power for each locomotive configuration, and the sales-weighted average locomotive power for the engine family.

(6) Useful life.

(7) Calculated positive or negative emission credits for the whole engine family. Identify any emission credits that you traded or transferred, as described in paragraph (d)(1) or (e) of this section.

(c) Your end-of-year and final reports must include the following additional information:

(1) Show that your net balance of emission credits from all your engine families in each averaging set in the applicable model year is not negative.

(2) State whether you will retain any emission credits for banking.

(3) State that the report's contents are accurate.

(d) If you trade emission credits, you must send us a report within 90 days after the transaction, as follows:

(1) As the seller, you must include the following information in your report:

(i) The corporate names of the buyer and any brokers.

(ii) A copy of any contracts related to the trade.

(iii) The engine families that generated emission credits for the trade, including the number of emission credits from each family.

(2) As the buyer, you must include the following information in your report:

(i) The corporate names of the seller and any brokers.

(ii) A copy of any contracts related to the trade.

(iii) How you intend to use the emission credits, including the number of emission credits you intend to apply to each engine family (if known).

(e) If you transfer emission credits, you must send us a report within 90 days after the first transfer to an owner/operator, as follows:

(1) Include the following information:

(i) The corporate names of the owner/operator receiving the credits.

(ii) A copy of any contracts related to the trade.

(iii) The serial numbers and engine families for the locomotive that generated the transferred emission credits and the number of emission credits from each family.

(2) The requirements of this paragraph (e) apply separately for each owner/operator.

(3) We may require you to submit additional 90-day reports under this paragraph (e).

(f) Send your reports electronically to the Designated Compliance Officer using an approved information format. If you want to use a different format, send us a written request with justification for a waiver.

(g) Correct errors in your end-of-year report or final report as follows:

(1) You may correct any errors in your end-of-year report when you prepare the final report, as long as you send us the final report by the time it is due.

(2) If you or we determine within 270 days after the end of the model year that errors mistakenly decreased your balance of emission credits, you may correct the errors and recalculate the balance of emission credits. You may not make these corrections for errors that are determined more than 270 days after the end of the model year. If you report a negative balance of emission credits, we may disallow corrections under this paragraph (g)(2).

(3) If you or we determine anytime that errors mistakenly increased your balance of emission credits, you must correct the errors and recalculate the balance of emission credits.

(h) We may modify these requirements for owners/operators required to submit reports because of their involvement in credit transferring.

§ 1033.735 Required records.

(a) You must organize and maintain your records as described in this section. We may review your records at any time.

(b) Keep the records required by this section for eight years after the due date for the end-of-year report. You may not use emission credits on any engines if

you do not keep all the records required under this section. You must therefore keep these records to continue to bank valid credits. Store these records in any format and on any media, as long as you can promptly send us organized, written records in English if we ask for them. You must keep these records readily available. We may review them at any time.

(c) Keep a copy of the reports we require in § 1033.730.

(d) Keep the following additional records for each locomotive you produce that generates or uses emission credits under the ABT program:

(1) Engine family designation.

(2) Locomotive identification number.

You may identify these numbers as a range.

(3) FEL. If you change the FEL after the start of production, identify the date that you started using the new FEL and give the engine identification number for the first engine covered by the new FEL.

(4) Rated power and useful life.

(5) Purchaser and destination for freshly manufactured locomotives; or owner for remanufactured locomotives.

(e) We may require you to keep additional records or to send us relevant information not required by this section, as allowed under the Clean Air Act.

§ 1033.740 Credit restrictions.

Use of emission credits generated under this part 1033 or 40 CFR part 92 is restricted depending on the standards against which they were generated.

(a) *Credits from 40 CFR part 92.* NO_x and PM credits generated under 40 CFR part 92 may be used under this part in the same manner as NO_x and PM credits generated under this part.

(b) *General cycle restriction.* Locomotives subject to both switch cycle standards and line-haul cycle standards (such as Tier 2 locomotives) may generate both switch and line-haul credits. Except as specified in paragraph (c) of this section, such credits may only be used to show compliance with standards for the same cycle for which they were generated. For example, a Tier 2 locomotive that is certified to a switch cycle NO_x FEL below the applicable switch cycle standard and a line-haul cycle NO_x FEL below the applicable line-haul cycle standard may generate switch cycle NO_x credits for use in complying with switch cycle NO_x standards and a line-haul cycle NO_x credits for use in complying with line-haul cycle NO_x standards.

(c) *Single cycle locomotives.* As specified in § 1033.101, Tier 0 switch locomotives, Tier 3 and later switch locomotives, and Tier 4 and later line-

haul locomotives are not subject to both switch cycle and line-haul cycle standards.

(1) When using credits generated by locomotives covered by paragraph (b) of this section for single cycle locomotives covered by this paragraph (c), you must use both switch and line-haul credits as described in this paragraph (c)(1).

(i) For locomotives subject only to switch cycle standards, calculate the negative switch credits for the credit using locomotive as specified in § 1033.705. Such locomotives also generate an equal number of negative line-haul cycle credits (in Mg).

(ii) For locomotives subject only to line-haul cycle standards, calculate the negative line-haul credits for the credit using locomotive as specified in § 1033.705. Such locomotives also generate an equal number of negative switch cycle credits (in Mg).

(2) Credits generated by Tier 0, Tier 3, or Tier 4 switch locomotives may be used to show compliance with any switch cycle or line-haul cycle standards.

(3) Credits generated by any line-haul locomotives may not be used by Tier 3 or later switch locomotives.

(d) *Tier 4 credit use.* The number of Tier 4 locomotives that can be certified using credits in any year may not exceed 50 percent of the total number of Tier 4 locomotives you produce in that year for U.S. sales.

(e) *Other restrictions.* Other sections of this part may specify additional restrictions for using emission credits under certain special provisions.

§ 1033.745 Compliance with the provisions of this subpart.

The provisions of this section apply to certificate holders.

(a) For each engine family participating in the ABT program, the certificate of conformity is conditional upon full compliance with the provisions of this subpart during and after the model year. You are responsible to establish to our satisfaction that you fully comply with applicable requirements. We may void the certificate of conformity for an engine family if you fail to comply with any provisions of this subpart.

(b) You may certify your engine family to an FEL above an applicable emission standard based on a projection that you will have enough emission credits to offset the deficit for the engine family. However, we may void the certificate of conformity if you cannot show in your final report that you have enough actual emission credits to offset a deficit for any pollutant in an engine family.

(c) We may void the certificate of conformity for an engine family if you fail to keep records, send reports, or give us information we request.

(d) You may ask for a hearing if we void your certificate under this section (see § 1033.920).

§ 1033.750 Changing a locomotive's FEL at remanufacture.

Locomotives are generally required to be certified to the previously applicable emission standard or FEL when remanufactured. This section describes provisions that allow a remanufactured locomotive to be certified to a different FEL (higher or lower).

(a) A remanufacturer may choose to certify a remanufacturing system to change the FEL of a locomotive from a previously applicable FEL or standard. Any locomotives remanufactured using that system are required to comply with the revised FEL for the remainder of their service lives, unless it is changed again under this section during a later remanufacture. Remanufacturers changing an FEL must notify the owner of the locomotive that it is required to comply with that FEL for the remainder of its service life.

(b) Calculate the credits needed or generated as specified in § 1033.705, except as specified in this paragraph. If the locomotive was previously certified to an FEL for the pollutant, use the previously applicable FEL as the standard.

Subpart I—Requirements for Owners and Operators

§ 1033.801 Applicability.

The requirements of this subpart are applicable to railroads and all other owners and operators of locomotives subject to the provisions of this part, except as otherwise specified. The prohibitions related to maintenance in § 1033.815 also applies to anyone performing maintenance on a locomotive subject to the provisions of this part.

§ 1033.805 Remanufacturing requirements.

(a) See the definition of “remanufacture” in § 1033.901 to determine if you are remanufacturing your locomotive or engine. (**Note:** Replacing power assemblies one at a time may qualify as remanufacturing, depending on the interval between replacement.)

(b) See the definition of “new” in § 1033.901 to determine if remanufacturing your locomotive makes it subject to the requirements of this part. If the locomotive is considered to be new, it is subject to the certification

requirements of this part, unless it is exempt under subpart G of this part. The standards to which your locomotive is subject will depend on factors such as the following:

(1) Its date of original manufacture.

(2) The FEL to which it was previously certified, which is listed on the “Locomotive Emission Control Information” label.

(3) Its power rating (whether it is above or below 2300 hp).

(4) The calendar year in which it is being remanufactured.

(c) You may comply with the certification requirements of this part for your remanufactured locomotive by either obtaining your own certificate of conformity as specified in subpart C of this part or by having a certifying remanufacturer include your locomotive under its certificate of conformity. In either case, your remanufactured locomotive must be covered by a certificate before it is reintroduced into service.

(d) If you do not obtain your own certificate of conformity from EPA, contact a certifying remanufacturer to have your locomotive included under its certificate of conformity. Confirm with the certificate holder that your locomotive's model, date of original manufacture, previous FEL, and power rating allow it to be covered by the certificate. You must do all of the following:

(1) Comply with the certificate holder's emission-related installation instructions, which should include the following:

(i) A description of how to assemble and adjust the locomotive so that it will operate according to design specifications in the certificate. See paragraph (e) of this section for requirements related to the parts you must use.

(ii) Instructions to remove the Engine Emission Control Information label and replace it with the certificate holder's new label. **Note:** In most cases, you must not remove the Locomotive Emission Control Information label.

(2) Provide to the certificate holder the information it identifies as necessary to comply with the requirements of this part. For example, the certificate holder may require you to provide the information specified by § 1033.735.

(e) For parts unrelated to emissions and emission-related parts not addressed by the certificate holder in the emission-related installation instructions, you may use parts from any source. For emission-related parts listed by the certificate holder in the emission-related installation instructions, you must either use the

specified parts or parts certified under § 1033.645 for remanufacturing. If you believe that the certificate holder has included as emission-related parts, parts that are actually unrelated to emissions, you may ask us to exclude such parts from the emission-related installation instructions. **Note:** This paragraph (e) does not apply with respect to parts for maintenance other than remanufacturing; see § 1033.815 for provisions related to general maintenance.

(f) Failure to comply with this section is a violation of 40 CFR 1068.101(a)(1).

§ 1033.810 In-use testing program.

(a) *Applicability.* This section applies to all Class I freight railroads. It does not apply to other owner/operators.

(b) *Testing requirements.* Annually test a sample of locomotives in your fleet. For purposes of this section, your fleet includes both the locomotives that you own and the locomotives that you are leasing. Use the test procedures in subpart F of this part, unless we approve different procedures.

(1) Except for the cases described in paragraph (b)(2) of this section, test at least 0.075 percent of the average number of locomotives in your fleet during the previous calendar year (i.e., determine the number to be tested by multiplying the number of locomotives in the fleet by 0.00075 and rounding up to the next whole number).

(2) We may allow you to test a smaller number of locomotives if we determine that the number of tests otherwise required by this section is not necessary.

(c) *Test locomotive selection.* Unless we specify a different option, select test locomotives as specified in paragraph (c)(1) of this section (Option 1). In no case may you exclude locomotives because of visible smoke, a history of durability problems, or other evidence of malmaintenance. You may test more locomotives than is required by this section.

(1) *Option 1.* To the extent possible, select locomotives from each manufacturer and remanufacturer, and from each tier level (e.g., Tier 0, Tier 1 and Tier 2) in proportion to their numbers in the your fleet. Exclude locomotives tested during the previous year. If possible, select locomotives that have been operated for at least 100 percent of their useful lives. Where there are multiple locomotives meeting the requirements of this paragraph (c)(1), randomly select the locomotives to be tested from among those locomotives. If the number of certified locomotives that have been operated for at least 100 percent of their useful lives is not large enough to fulfill the testing

requirement, test locomotives still within their useful lives as follows:

(i) Test locomotives in your fleet that are nearest to the end of their useful lives. You may identify such locomotives as a range of values representing the fraction of the useful life already used up for the locomotives.

(ii) For example, you may determine that 20 percent of your fleet has been operated for at least 75 percent of their useful lives. In such a case, select locomotives for testing that have been operated for at least 75 percent of their useful lives.

(2) *Option 2.* If you hold a certificate for some of your locomotives, you may ask us to allow you to select up to two locomotives as specified in subpart E of this part, and count those locomotives toward both your testing obligations of that subpart and this section.

(3) *Option 3.* You may ask us to allow you to test locomotives that use parts covered under § 1033.645. If we do, it does not change the number of locomotives that you must test.

(4) *Option 4.* We may require that you test specific locomotives, including locomotives that do not meet the criteria specified in any of the options in this section. If we do, we will specify which locomotives to test by January 1 of the calendar year for which testing is required.

(d) *Reporting requirements.* Report all testing done in compliance with the provisions of this section to us within 45 calendar days after the end of each calendar year. At a minimum, include the following:

(1) Your full corporate name and address.

(2) For each locomotive tested, all the following:

(i) Corporate name of the manufacturer and last remanufacturer(s) of the locomotive (including both certificate holder and installer, where different), and the corporate name of the manufacturer or last remanufacturer(s) of the engine if different than that of the manufacturer/remanufacturer(s) of the locomotive.

(ii) Year (and month if known) of original manufacture of the locomotive and the engine, and the manufacturer's model designation of the locomotive and manufacturer's model designation of the engine, and the locomotive identification number.

(iii) Year (and month if known) that the engine last underwent remanufacture, the engine remanufacturer's designation that reflects (or most closely reflects) the engine after the last remanufacture, and the engine family identification.

(iv) The number of MW-hrs and miles (where available) the locomotive has been operated since its last remanufacture.

(v) The emission test results for all measured pollutants.

(e) You do not have to submit a report for any year in which you performed no emission testing under this section.

(f) You may ask us to allow you to submit equivalent emission data collected for other purposes instead of some or all of the test data required by this section. If we allow it in advance, you may report emission data collected using other testing or sampling procedures instead of some or all of the data specified by this section.

(g) Submit all reports to the Designated Compliance Officer.

(h) Failure to comply fully with this section is a violation of 40 CFR 1068.101(a)(2).

§ 1033.815 Maintenance, operation, and repair.

All persons who own, operate, or maintain locomotives are subject to this section, except where we specify that a requirement applies to the owner.

(a) Unless we allow otherwise, all owners of locomotives subject to the provisions of this part must ensure that all emission-related maintenance is performed on the locomotives, as specified in the maintenance instructions provided by the certifying manufacturer/remanufacturer in compliance with § 1033.125 (or maintenance that is equivalent to the maintenance specified by the certifying manufacturer/remanufacturer in terms of maintaining emissions performance).

(b) Perform unscheduled maintenance in a timely manner. This includes malfunctions identified through the locomotive's emission control diagnostics system and malfunctions discovered in components of the diagnostics system itself. For most repairs, this paragraph (b) requires that the maintenance be performed no later than the locomotive's next periodic (92-day) inspection. See paragraph (e) of this section, for reductant replenishment requirements in a locomotive equipped with an SCR system.

(c) Use good engineering judgment when performing maintenance of locomotives subject to the provisions of this part. You must perform all maintenance and repair such that you have a reasonable technical basis for believing the locomotive will continue (after the maintenance or repair) to meet the applicable emission standards and FELs to which it was certified.

(d) The owner of the locomotive must keep records of all maintenance and repairs that could reasonably affect the emission performance of any locomotive subject to the provisions of this part. Keep these records for eight years.

(e) For locomotives equipped with emission controls requiring the use of specific fuels, lubricants, or other fluids, proper maintenance includes complying with the manufacturer/remanufacturer's specifications for such fluids when operating the locomotives. This requirement applies without regard to whether misfueling permanently disables the emission controls. The following additional provisions apply for locomotives equipped with SCR systems requiring the use of urea or other reductants:

(1) You must plan appropriately to ensure that reductant will be available to the locomotive during operation.

(2) If the SCR diagnostic indicates (or you otherwise determine) that either reductant supply or reductant quality in the locomotive is inadequate, you must replace the reductant as soon as practical.

(3) If you operate a locomotive without the appropriate urea or other reductant, you must report such operation to us within 30 days. Note that such operation violates the requirement of this paragraph (e); however, we may consider mitigating factors (such as how long the locomotive was operated without the appropriate urea or other reductant) in determining whether to assess penalties for such violations.

(f) Failure to fully comply with this section is a violation of 40 CFR 1068.101(b).

§ 1033.820 In-use locomotives.

(a) We may require you to supply in-use locomotives to us for testing. We will specify a reasonable time and place at which you must supply the locomotives and a reasonable period during which we will keep them for testing. We will make reasonable allowances for you to schedule the supply of locomotives to minimize disruption of your operations. The number of locomotives that you must supply is limited as follows:

(1) We will not require a Class I railroad to supply more than five locomotives per railroad per calendar year.

(2) We will not require a non-Class I railroad (or other entity subject to the provisions of this subpart) to supply more than two locomotives per railroad per calendar year. We will request locomotives under this paragraph (a)(2) only for purposes that cannot be

accomplished using locomotives supplied under paragraph (a)(1) of this section.

(b) You must make reasonable efforts to supply manufacturers/remanufacturers with the test locomotives needed to fulfill the in-use testing requirements in subpart E of this part.

(c) Failure to fully comply with this section is a violation of 40 CFR 1068.101(a)(2).

§ 1033.825 Refueling requirements.

(a) If your locomotive operates using a volatile fuel, your refueling equipment must be designed and used to minimize the escape of fuel vapors. This means you may not use refueling equipment in a way that renders any refueling emission controls inoperative or reduces their effectiveness.

(b) If your locomotive operates using a gaseous fuel, the hoses used to refuel it may not be designed to be bled or vented to the atmosphere under normal operating conditions.

(c) Failing to fully comply with the requirements of this section is a violation of 40 CFR 1068.101(b).

Subpart J—Definitions and Other Reference Information

§ 1033.901 Definitions.

The following definitions apply to this part. The definitions apply to all subparts unless we note otherwise. All undefined terms have the meaning the Clean Air Act gives to them. The definitions follow:

Adjustable parameter means any device, system, or element of design that someone can adjust (including those which are difficult to access) and that, if adjusted, may affect emissions or locomotive performance during emission testing or normal in-use operation. This includes, but is not limited to, parameters related to injection timing and fueling rate. You may ask us to exclude a parameter if you show us that it will not be adjusted in a way that affects emissions during in-use operation.

Aftertreatment means relating to a catalytic converter, particulate filter, or any other system, component, or technology mounted downstream of the exhaust valve (or exhaust port) whose design function is to reduce emissions in the locomotive exhaust before it is exhausted to the environment. Exhaust-gas recirculation (EGR) is not aftertreatment.

Alcohol fuel means a fuel consisting primarily (more than 50 percent by weight) of one or more alcohols: e.g., methyl alcohol, ethyl alcohol.

Alternator/generator efficiency means the ratio of the electrical power output from the alternator/generator to the mechanical power input to the alternator/generator at the operating point. Note that the alternator/generator efficiency may be different at different operating points. For example, the Institute of Electrical and Electronic Engineers Standard 115 (“Test Procedures for Synchronous Machines”) is an appropriate test procedure for determining alternator/generator efficiency. Other methods may also be used consistent with good engineering judgment.

Applicable emission standard or applicable standard means a standard to which a locomotive is subject; or, where a locomotive has been or is being certified to another standard or FEL, the FEL or other standard to which the locomotive has been or is being certified is the applicable standard. This definition does not apply to Subpart H of this part.

Auxiliary emission control device means any element of design that senses temperature, locomotive speed, engine RPM, transmission gear, or any other parameter for the purpose of activating, modulating, delaying, or deactivating the operation of any part of the emission-control system.

Auxiliary engine means a nonroad engine that provides hotel power or power during idle, but does not provide power to propel the locomotive.

Averaging means the exchange of emission credits among engine families within a given manufacturer's, or remanufacturer's product line.

Banking means the retention of emission credits by a credit holder for use in future calendar year averaging or trading as permitted by the regulations in this part.

Brake power means the sum of the alternator/generator input power and the mechanical accessory power, excluding any power required to circulate engine coolant, circulate engine lubricant, supply fuel to the engine, or operate aftertreatment devices.

Calibration means the set of specifications, including tolerances, specific to a particular design, version, or application of a component, or components, or assembly capable of functionally describing its operation over its working range.

Carryover means the process of obtaining a certificate for one model year using the same test data from the preceding model year, as described in § 1033.235(d). This generally requires that the locomotives in the engine

family do not differ in any aspect related to emissions.

Certification means the process of obtaining a certificate of conformity for an engine family that complies with the emission standards and requirements in this part, or relating to that process.

Certified emission level means the highest deteriorated emission level in an engine family for a given pollutant from a given test cycle.

Class I freight railroad means a Class I railroad that primarily transports freight rather than passengers.

Class I railroad means a railroad that has been classified as a Class I railroad by the Surface Transportation Board.

Class II railroad means a railroad that has been classified as a Class II railroad by the Surface Transportation Board.

Class III railroad means a railroad that has been classified as a Class III railroad by the Surface Transportation Board.

Clean Air Act means the Clean Air Act, as amended, 42 U.S.C. 7401–7671q.

Configuration means a unique combination of locomotive hardware and calibration within an engine family. Locomotives within a single configuration differ only with respect to normal production variability (or factors unrelated to engine performance or emissions).

Crankcase emissions means airborne substances emitted to the atmosphere from any part of the locomotive crankcase's ventilation or lubrication systems. The crankcase is the housing for the crankshaft and other related internal parts.

Days means calendar days, unless otherwise specified. For example, where we specify working days, we mean calendar days excluding weekends and U.S. national holidays.

Design certify or certify by design means to certify a locomotive based on inherent design characteristics rather than your test data, such as allowed under § 1033.625. All other requirements of this part apply for such locomotives.

Designated Compliance Officer means the Manager, Heavy Duty and Nonroad Engine Group (6403–J), U.S. Environmental Protection Agency, 1200 Pennsylvania Ave., NW., Washington, DC 20460.

Deteriorated emission level means the emission level that results from applying the appropriate deterioration factor to the official emission result of the emission-data locomotive.

Deterioration factor means the relationship between emissions at the end of useful life and emissions at the low-hour test point, expressed in one of the following ways:

(1) For multiplicative deterioration factors, the ratio of emissions at the end of useful life to emissions at the low-hour test point.

(2) For additive deterioration factors, the difference between emissions at the end of useful life and emissions at the low-hour test point.

Discrete-mode means relating to the discrete-mode type of steady-state test described in § 1033.515.

Emission control system means any device, system, or element of design that controls or reduces the regulated emissions from a locomotive.

Emission credits represent the amount of emission reduction or exceedance, by a locomotive engine family, below or above the emission standard, respectively. Emission reductions below the standard are considered as "positive credits," while emission exceedances above the standard are considered as "negative credits." In addition, "projected credits" refer to emission credits based on the projected applicable production/sales volume of the engine family. "Reserved credits" are emission credits generated within a calendar year waiting to be reported to EPA at the end of the calendar year. "Actual credits" refer to emission credits based on actual applicable production/sales volume as contained in the end-of-year reports submitted to EPA.

Emission-data locomotive means a locomotive or engine that is tested for certification. This includes locomotives tested to establish deterioration factors.

Emission-related maintenance means maintenance that substantially affects emissions or is likely to substantially affect emission deterioration.

Engine family has the meaning given in § 1033.230.

Engine used in a locomotive means an engine incorporated into a locomotive or intended for incorporation into a locomotive (whether or not it is used for propelling the locomotive).

Engineering analysis means a summary of scientific and/or engineering principles and facts that support a conclusion made by a manufacturer/remanufacturer, with respect to compliance with the provisions of this part.

EPA Enforcement Officer means any officer or employee of the Environmental Protection Agency so designated in writing by the Administrator or his/her designee.

Exempted means relating to a locomotive that is not required to meet otherwise applicable standards. Exempted locomotives must conform to regulatory conditions specified for an exemption in this part 1033 or in 40

CFR part 1068. Exempted locomotives are deemed to be "subject to" the standards of this part, even though they are not required to comply with the otherwise applicable requirements.

Locomotives exempted with respect to a certain tier of standards may be required to comply with an earlier tier of standards as a condition of the exemption; for example, locomotives exempted with respect to Tier 3 standards may be required to comply with Tier 2 standards.

Excluded means relating to a locomotive that either has been determined not to be a locomotive (as defined in this section) or otherwise excluded under section § 1033.5. Excluded locomotives are not subject to the standards of this part.

Exhaust emissions means substances (i.e., gases and particles) emitted to the atmosphere from any opening downstream from the exhaust port or exhaust valve of a locomotive engine.

Exhaust-gas recirculation means a technology that reduces emissions by routing exhaust gases that had been exhausted from the combustion chamber(s) back into the locomotive to be mixed with incoming air before or during combustion. The use of valve timing to increase the amount of residual exhaust gas in the combustion chamber(s) that is mixed with incoming air before or during combustion is not considered exhaust-gas recirculation for the purposes of this part.

Freshly manufactured locomotive means a new locomotive that contains fewer than 25 percent previously used parts (weighted by the dollar value of the parts) as described in § 1033.640.

Freshly manufactured engine means a new engine that has not been remanufactured. An engine becomes freshly manufactured when it is originally manufactured.

Family emission limit (FEL) means an emission level declared by the manufacturer/remanufacturer to serve in place of an otherwise applicable emission standard under the ABT program in subpart H of this part. The family emission limit must be expressed to the same number of decimal places as the emission standard it replaces. The family emission limit serves as the emission standard for the engine family with respect to all required testing.

Fuel system means all components involved in transporting, metering, and mixing the fuel from the fuel tank to the combustion chamber(s), including the fuel tank, fuel tank cap, fuel pump, fuel filters, fuel lines, carburetor or fuel-injection components, and all fuel-system vents.

Fuel type means a general category of fuels such as diesel fuel or natural gas. There can be multiple grades within a single fuel type, such as high-sulfur or low-sulfur diesel fuel.

Gaseous fuel means a fuel which is a gas at standard temperature and pressure. This includes both natural gas and liquefied petroleum gas.

Good engineering judgment means judgments made consistent with generally accepted scientific and engineering principles and all available relevant information. See 40 CFR 1068.5 for the administrative process we use to evaluate good engineering judgment.

Green Engine Factor means a factor that is applied to emission measurements from a locomotive or locomotive engine that has had little or no service accumulation. The Green Engine Factor adjusts emission measurements to be equivalent to emission measurements from a locomotive or locomotive engine that has had approximately 300 hours of use.

High-altitude means relating to an altitude greater than 4000 feet (1220 meters) and less than 7000 feet (2135 meters), or equivalent observed barometric test conditions (approximately 79 to 88 kPa).

High-sulfur diesel fuel means one of the following:

(1) For in-use fuels, high-sulfur diesel fuel means a diesel fuel with a maximum sulfur concentration greater than 500 parts per million.

(2) For testing, high-sulfur diesel fuel has the meaning given in 40 CFR part 1065.

Hotel power means the power provided by an engine on a locomotive to operate equipment on passenger cars of a train; e.g., heating and air conditioning, lights, etc.

Hydrocarbon (HC) means the hydrocarbon group (THC, NMHC, or THCE) on which the emission standards are based for each fuel type as described in § 1033.101.

Identification number means a unique specification (for example, a model number/serial number combination) that allows someone to distinguish a particular locomotive from other similar locomotives.

Idle speed means the speed, expressed as the number of revolutions of the crankshaft per unit of time (e.g., rpm), at which the engine is set to operate when not under load for purposes of propelling the locomotive. There are typically one or two idle speeds on a locomotive as follows:

(1) *Normal idle speed* means the idle speed for the idle throttle-notch position for locomotives that have one throttle-notch position, or the highest idle speed

for locomotives that have two idle throttle-notch positions.

(2) *Low idle speed* means the lowest idle speed for locomotives that have two idle throttle-notch positions.

Inspect and qualify means to determine that a previously used component or system meets all applicable criteria listed for the component or system in a certificate of conformity for remanufacturing (such as to determine that the component or system is functionally equivalent to one that has not been used previously).

Installer means an individual or entity that assembles remanufactured locomotives or locomotive engines.

Line-haul locomotive means a locomotive that does not meet the definition of switch locomotive. Note that this includes both freight and passenger locomotives.

Liquefied petroleum gas means the commercial product marketed as propane or liquefied petroleum gas.

Locomotive means a self-propelled piece of on-track equipment designed for moving or propelling cars that are designed to carry freight, passengers or other equipment, but which itself is not designed or intended to carry freight, passengers (other than those operating the locomotive) or other equipment. The following other equipment are not locomotives (see 40 CFR parts 86, 89, and 1039 for this diesel-powered equipment):

(1) Equipment designed for operation both on highways and rails is not a locomotive.

(2) Specialized railroad equipment for maintenance, construction, post-accident recovery of equipment, and repairs; and other similar equipment, are not locomotives.

(3) Vehicles propelled by engines with total rated power of less than 750 kW (1006 hp) are not locomotives, unless the owner (which may be a manufacturer) chooses to have the equipment certified to meet the requirements of this part (under § 1033.615). Where equipment is certified as a locomotive pursuant to this paragraph (3), it is subject to the requirements of this part for the remainder of its service life. For locomotives propelled by two or more engines, the total rated power is the sum of the rated power of each engine.

Locomotive engine means an engine that propels a locomotive.

Low-hour means relating to a locomotive with stabilized emissions and represents the undeteriorated emission level. This would generally involve less than 300 hours of operation.

Low mileage locomotive means a locomotive during the interval between the time that normal assembly operations and adjustments are completed and the time that either 10,000 miles of locomotive operation or 300 additional operating hours have been accumulated (including emission testing if performed). Note that we may deem locomotives with additional operation to be low mileage locomotives, consistent with good engineering judgment.

Low-sulfur diesel fuel means one of the following:

(1) For in-use fuels, *low-sulfur diesel fuel* means a diesel fuel market as low-sulfur diesel fuel having a maximum sulfur concentration of 500 parts per million.

(2) For testing, *low-sulfur diesel fuel* has the meaning given in 40 CFR part 1065.

Malfunction means a condition in which the operation of a component in a locomotive or locomotive engine occurs in a manner other than that specified by the certifying manufacturer/remanufacturer (e.g., as specified in the application for certification); or the operation of the locomotive or locomotive engine in that condition.

Manufacture means the physical and engineering process of designing, constructing, and assembling a locomotive or locomotive engine.

Manufacturer has the meaning given in section 216(1) of the Clean Air Act with respect to freshly manufactured locomotives or engines. In general, this term includes any person who manufactures a locomotive or engine for sale in the United States or otherwise introduces a new locomotive or engine into commerce in the United States. This includes importers who import locomotives or engines for resale.

Manufacturer/remanufacturer means the manufacturer of a freshly manufactured locomotive or engine or the remanufacturer of a remanufactured locomotive or engine, as applicable.

Model year means a calendar year in which a locomotive is manufactured or remanufactured.

New, when relating to a locomotive or locomotive engine, has the meaning given in paragraph (1) of this definition, except as specified in paragraph (2) of this definition:

(1) A locomotive or engine is new if its equitable or legal title has never been transferred to an ultimate purchaser. Where the equitable or legal title to a locomotive or engine is not transferred prior to its being placed into service, the locomotive or engine ceases to be new when it is placed into service. A

locomotive or engine also becomes new if it is remanufactured or refurbished (as defined in this section). A remanufactured locomotive or engine ceases to be new when placed back into service. With respect to imported locomotives or locomotive engines, the term "new locomotive" or "new locomotive engine" also means a locomotive or locomotive engine that is not covered by a certificate of conformity under this part or 40 CFR part 92 at the time of importation, and that was manufactured or remanufactured after the effective date of the emission standards in 40 CFR part 92 which would have been applicable to such locomotive or engine had it been manufactured or remanufactured for importation into the United States. Note that replacing an engine in one locomotive with an unremanufactured used engine from a different locomotive does not make a locomotive new.

(2) The provisions of paragraph (1) of this definition do not apply for the following cases:

(i) Locomotives and engines that were originally manufactured before January 1, 1973 are not considered to become new when remanufactured unless they have been upgraded (as defined in this section). The provisions of paragraph (1) of this definition apply for locomotives that have been upgraded.

(ii) Locomotives that are owned and operated by a small railroad and that have never been remanufactured into a certified configuration are not considered to become new when remanufactured. The provisions of paragraph (1) of this definition apply for locomotives that have previously been remanufactured into a certified configuration.

(iii) Locomotives originally certified under (1033.150(e) do not become new when remanufactured, except as specified in § 1033.615.

(iv) Locomotives that operate only on non-standard gauge rails do not become new when remanufactured if no certified remanufacturing system is available for them.

Nonconforming means relating to a locomotive that is not covered by a certificate of conformity prior to importation or being offered for importation (or for which such coverage has not been adequately demonstrated to EPA); or a locomotive which was originally covered by a certificate of conformity, but which is not in a certified configuration, or otherwise does not comply with the conditions of that certificate of conformity. (**Note:** Domestic locomotives and locomotive engines not covered by a certificate of conformity prior to their introduction

into U.S. commerce are considered to be noncomplying locomotives and locomotive engines.)

Non-locomotive-specific engine means an engine that is sold for and used in non-locomotive applications much more than for locomotive applications.

Nonmethane hydrocarbon has the meaning given in 40 CFR 1065.1001. This generally means the difference between the emitted mass of total hydrocarbons and the emitted mass of methane.

Nonroad means relating to nonroad engines as defined in 40 CFR 1068.30.

Official emission result means the measured emission rate for an emission-data locomotive on a given duty cycle before the application of any deterioration factor, but after the application of regeneration adjustment factors, Green Engine Factors, and/or humidity correction factors.

Opacity means the fraction of a beam of light, expressed in percent, which fails to penetrate a plume of smoke, as measured by the procedure specified in § 1033.525.

Original manufacture means the event of freshly manufacturing a locomotive or locomotive engine. The date of original manufacture is the date of final assembly, except as provided in § 1033.640. Where a locomotive is manufactured under § 1033.620(b), the date of original manufacture is the date on which the final assembly of locomotive was originally scheduled.

Original remanufacture means the first remanufacturing of a locomotive at which the locomotive is subject to the emission standards of this part.

Owner/operator means the owner and/or operator of a locomotive.

Owners manual means a written or electronic collection of instructions provided to ultimate purchasers to describe the basic operation of the locomotive.

Oxides of nitrogen has the meaning given in 40 CFR part 1065.

Particulate trap means a filtering device that is designed to physically trap all particulate matter above a certain size.

Passenger locomotive means a locomotive designed and constructed for the primary purpose of propelling passenger trains, and providing power to the passenger cars of the train for such functions as heating, lighting and air conditioning.

Petroleum fuel means gasoline or diesel fuel or another liquid fuel primarily derived from crude oil.

Placed into service means put into initial use for its intended purpose after becoming new.

Power assembly means the components of an engine in which combustion of fuel occurs, and consists of the cylinder, piston and piston rings, valves and ports for admission of charge air and discharge of exhaust gases, fuel injection components and controls, cylinder head and associated components.

Primary fuel means the type of fuel (e.g., diesel fuel) that is consumed in the greatest quantity (mass basis) when the locomotive is operated in use.

Produce means to manufacture or remanufacture. Where a certificate holder does not actually assemble the locomotives or locomotive engines that it manufactures or remanufactures, produce means to allow other entities to assemble locomotives under the certificate holder's certificate.

Railroad means a commercial entity that operates locomotives to transport passengers or freight.

Ramped-modal means relating to the ramped-modal type of testing in subpart F of this part.

Rated power has the meaning given in § 1033.140.

Refurbish has the meaning given in § 1033.640.

Remanufacture means one of the following:

(1)(i) To replace, or inspect and qualify, each and every power assembly of a locomotive or locomotive engine, whether during a single maintenance event or cumulatively within a five-year period.

(ii) To upgrade a locomotive or locomotive engine.

(iii) To convert a locomotive or locomotive engine to enable it to operate using a fuel other than it was originally manufactured to use.

(iv) To install a remanufactured engine or a freshly manufactured engine into a previously used locomotive.

(v) To repair a locomotive engine that does not contain power assemblies to a condition that is equivalent to or better than its original condition with respect to reliability and fuel consumption.

(2) Remanufacture also means the act of remanufacturing.

Remanufacture system or *remanufacturing system* means all components (or specifications for components) and instructions necessary to remanufacture a locomotive or locomotive engine in accordance with applicable requirements of this part or 40 CFR part 92.

Remanufactured locomotive means either a locomotive powered by a remanufactured locomotive engine, a repowered locomotive, or a refurbished locomotive.

Remanufactured locomotive engine means a locomotive engine that has been remanufactured.

Remanufacturer has the meaning given to "manufacturer" in section 216(1) of the Clean Air Act with respect to remanufactured locomotives. (See §§ 1033.1 and 1033.601 for applicability of this term.) This term includes:

(1) Any person that is engaged in the manufacture or assembly of remanufactured locomotives or locomotive engines, such as persons who:

(i) Design or produce the emission-related parts used in remanufacturing.

(ii) Install parts in an existing locomotive or locomotive engine to remanufacture it.

(iii) Own or operate the locomotive or locomotive engine and provide specifications as to how an engine is to be remanufactured (i.e., specifying who will perform the work, when the work is to be performed, what parts are to be used, or how to calibrate the adjustable parameters of the engine).

(2) Any person who imports remanufactured locomotives or remanufactured locomotive engines.

Repower means replacement of the engine in a previously used locomotive with a freshly manufactured locomotive engine. See § 1033.640.

Repowered locomotive means a locomotive that has been repowered with a freshly manufactured engine.

Revoke has the meaning given in 40 CFR 1068.30. In general this means to terminate the certificate or an exemption for an engine family.

Round means to round numbers as specified in 40 CFR 1065.1001.

Service life means the total life of a locomotive. Service life begins when the locomotive is originally manufactured and continues until the locomotive is permanently removed from service.

Small manufacturer/remanufacturer means a manufacturer/remanufacturer with 1,000 or fewer employees. For purposes of this part, the number of employees includes all employees of the manufacturer/remanufacturer's parent company, if applicable.

Small railroad means a railroad meeting the criterion of paragraph (1) of this definition, but not either of the criteria of paragraphs (2) and (3) of this definition.

(1) To be considered a small railroad, a railroad must qualify as a small business under the Small Business Administration's regulations in 13 CFR part 121.

(2) Class I and Class II railroads (and their subsidiaries) are not small railroads.

(3) Intercity passenger and commuter railroads are excluded from this

definition of small railroad. Note that this paragraph (3) does not exclude tourist railroads.

Specified adjustable range means the range of allowable settings for an adjustable component specified by a certificate of conformity.

Specified by a certificate of conformity or specified in a certificate of conformity means stated or otherwise specified in a certificate of conformity or an approved application for certification.

Sulfur-sensitive technology means an emission-control technology that would experience a significant drop in emission control performance or emission-system durability when a locomotive is operated on low-sulfur fuel with a sulfur concentration of 300 to 500 ppm as compared to when it is operated on ultra low-sulfur fuel (i.e., fuel with a sulfur concentration less than 15 ppm). Exhaust-gas recirculation is not a sulfur-sensitive technology.

Suspend has the meaning given in 40 CFR 1068.30. In general this means to temporarily discontinue the certificate or an exemption for an engine family.

Switch locomotive means a locomotive that is powered by an engine with a maximum rated power (or a combination of engines having a total rated power) of 2300 hp or less. Include auxiliary engines in your calculation of total power if the engines are permanently installed on the locomotive and can be operated while the main propulsion engine is operating. Do not count the power of auxiliary engines that operate only to reduce idling time of the propulsion engine.

Test locomotive means a locomotive or engine in a test sample.

Test sample means the collection of locomotives or engines selected from the population of an engine family for emission testing. This may include testing for certification, production-line testing, or in-use testing.

Tier 0 or Tier 0+ means relating to the Tier 0 emission standards, as shown in § 1033.101.

Tier 1 or Tier 1+ means relating to the Tier 1 emission standards, as shown in § 1033.101.

Tier 2 or Tier 2+ means relating to the Tier 2 emission standards, as shown in § 1033.101.

Tier 3 means relating to the Tier 3 emission standards, as shown in § 1033.101.

Tier 4 means relating to the Tier 4 emission standards, as shown in § 1033.101.

Total hydrocarbon has the meaning given in 40 CFR 1065.1001. This generally means the combined mass of organic compounds measured by the

specified procedure for measuring total hydrocarbon, expressed as a hydrocarbon with an atomic hydrogen-to-carbon ratio of 1.85:1.

Total hydrocarbon equivalent has the meaning given in 40 CFR 1065.1001. This generally means the sum of the carbon mass contributions of non-oxygenated hydrocarbons, alcohols and aldehydes, or other organic compounds that are measured separately as contained in a gas sample, expressed as exhaust hydrocarbon from petroleum-fueled locomotives. The hydrogen-to-carbon ratio of the equivalent hydrocarbon is 1.85:1.

Ultimate purchaser means the first person who in good faith purchases a new locomotive for purposes other than resale.

Ultra low-sulfur diesel fuel means one of the following:

(1) For in-use fuels, *ultra low-sulfur diesel fuel* means a diesel fuel marketed as ultra low-sulfur diesel fuel having a maximum sulfur concentration of 15 parts per million.

(2) For testing, *ultra low-sulfur diesel fuel* has the meaning given in 40 CFR part 1065.

Upcoming model year means for an engine family the model year after the one currently in production.

Upgrade means one of the following types of remanufacturing.

(1) Repowering a locomotive that was originally manufactured prior to January 1, 1973.

(2) Refurbishing a locomotive that was originally manufactured prior to January 1, 1973 in a manner that is not freshly manufacturing.

(3) Modifying a locomotive that was originally manufactured prior to January 1, 1973 (or a locomotive that was originally manufactured on or after January 1, 1973, and that is not subject to the emission standards of this part), such that it is intended to comply with the Tier 0 standards. See § 1033.615.

Useful life means the period during which the locomotive engine is designed to properly function in terms of reliability and fuel consumption, without being remanufactured, specified as work output or miles. It is the period during which a new locomotive is required to comply with all applicable emission standards. See § 1033.101(g).

Void has the meaning given in 40 CFR 1068.30. In general this means to invalidate a certificate or an exemption both retroactively and prospectively.

Volatile fuel means a volatile liquid fuel or any fuel that is a gas at atmospheric pressure. Gasoline, natural gas, and LPG are volatile fuels.

Volatile liquid fuel means any liquid fuel other than diesel or biodiesel that

is a liquid at atmospheric pressure and has a Reid Vapor Pressure higher than 2.0 pounds per square inch.

We (us, our) means the Administrator of the Environmental Protection Agency and any authorized representatives.

§ 1033.905 Symbols, acronyms, and abbreviations.

The following symbols, acronyms, and abbreviations apply to this part:

AECD	auxiliary emission control device.
AESS	automatic engine stop/start
CFR	Code of Federal Regulations.
CO	carbon monoxide.
CO ₂	carbon dioxide.
EPA	Environmental Protection Agency.
FEL	Family Emission Limit.
g/bhp-hr	grams per brake horsepower-hour.
HC	hydrocarbon.
hp	horsepower.
LPG	liquefied petroleum gas.
LSD	low sulfur diesel.
MW	megawatt.
NIST	National Institute of Standards and Technology.
NMHC	nonmethane hydrocarbons.
NO _x	oxides of nitrogen.
PM	particulate matter.
rpm	revolutions per minute.
SAE	Society of Automotive Engineers.
SCR	selective catalytic reduction.
SEA	Selective Enforcement Audit.
THC	total hydrocarbon.
THCE	total hydrocarbon equivalent.
UL	useful life.
ULSD	ultra low sulfur diesel.
U.S.C.	United States Code.

§ 1033.915 Confidential information.

(a) Clearly show what you consider confidential by marking, circling, bracketing, stamping, or some other method.

(b) We will store your confidential information as described in 40 CFR part 2. Also, we will disclose it only as specified in 40 CFR part 2. This applies both to any information you send us and to any information we collect from inspections, audits, or other site visits.

(c) If you send us a second copy without the confidential information, we will assume it contains nothing confidential whenever we need to release information from it.

(d) If you send us information without claiming it is confidential, we may make it available to the public without further notice to you, as described in 40 CFR 2.204.

§ 1033.920 How to request a hearing.

(a) You may request a hearing under certain circumstances, as described elsewhere in this part. To do this, you must file a written request, including a description of your objection and any supporting data, within 30 days after we make a decision.

(b) For a hearing you request under the provisions of this part, we will

approve your request if we find that your request raises a substantial factual issue.

(c) If we agree to hold a hearing, we will use the procedures specified in 40 CFR part 1068, subpart G.

PART 1039—CONTROL OF EMISSIONS FROM NEW AND IN-USE NONROAD COMPRESSION-IGNITION ENGINES

■ 39. The authority citation for part 1039 continues to read as follows:

Authority: 42 U.S.C. 7401–7671q.

Subpart F—[Amended]

■ 40. Section 1039.505 is amended by revising paragraphs (a)(1) introductory text, (c), and (d) and adding paragraph (g) to read as follows:

§ 1039.505 How do I test engines using steady-state duty cycles, including ramped-modal testing?

* * * * *

(a) * * *

(1) For discrete-mode testing, sample emissions separately for each mode, then calculate an average emission level for the whole cycle using the weighting

factors specified for each mode. Calculate cycle statistics and compare with the established criteria as specified in 40 CFR 1065.514 to confirm that the test is valid. Operate the engine and sampling system as follows:

* * * * *

(c) During idle mode, operate the engine at its warm idle speed as described in 40 CFR part 1065.

(d) For constant-speed engines whose design prevents full-load operation for extended periods, you may ask for approval under 40 CFR 1065.10(c) to replace full-load operation with the maximum load for which the engine is designed to operate for extended periods.

* * * * *

(g) To allow non-motoring dynamometers on cycles with idle, you may omit additional points from the duty-cycle regression as follows:

(1) For variable-speed engines with low-speed governors, you may omit speed, torque, and power points from the duty-cycle regression statistics if the following are met:

(i) The engine operator demand is at its minimum.

(ii) The dynamometer demand is at its minimum.

(iii) It is an idle point $f_{nref} = 0\%$ (idle) and $T_{ref} = 0\%$ (idle).

(iv) $T_{ref} < T \leq 5\% \cdot T_{max}$ mapped.

(2) For variable-speed engines without low-speed governors, you may omit torque and power points from the duty-cycle regression statistics if the following are met:

(i) The dynamometer demand is at its minimum.

(ii) It is an idle point $f_{nref} = 0\%$ (idle) and $T_{ref} = 0\%$ (idle).

(iii) $f_{nref} - (2\% \cdot f_{ntest}) < f_n < f_{nref} + (2\% \cdot f_{ntest})$.

(iv) $T_{ref} < T \leq 5\% \cdot T_{max}$ mapped.

Subpart G—[Amended]

■ 41. Section 1039.645 is amended by revising paragraph (b)(1) to read as follows:

§ 1039.645 What special provisions apply to engines used for transportation refrigeration units?

* * * * *

(b) * * *

(1) The following duty cycle applies for discrete-mode testing:

TABLE 1 OF § 1039.645.—DISCRETE-MODE CYCLE FOR TRU ENGINES

Mode number	Engine speed ¹	Torque (percent) ²	Weighting factors
1	Maximum test speed	75	0.25
2	Maximum test speed	50	0.25
3	Intermediate test speed	75	0.25
4	Intermediate test speed	50	0.25

¹ Speed terms are defined in 40 CFR part 1065.

² The percent torque is relative to the maximum torque at the given engine speed.

* * * * *

Appendices—[Amended]

■ 42. Appendix II to part 1039 is revised to read as follows:

Appendix II to Part 1039—Steady-State Duty Cycles

(a) The following duty cycles apply for constant-speed engines:

(1) The following duty cycle applies for discrete-mode testing:

D2 mode number	Engine speed	Torque (percent) ¹	Weighting factors
1	Engine governed	100	0.05
2	Engine governed	75	0.25
3	Engine governed	50	0.30
4	Engine governed	25	0.30
5	Engine governed	10	0.10

¹ The percent torque is relative to maximum test torque.

(2) The following duty cycle applies for ramped-modal testing:

RMC mode	Time in mode (seconds)	Engine speed	Torque (percent) ^{1, 2}
1a Steady-state	53	Engine governed	100.
1b Transition	20	Engine governed	Linear transition.
2a Steady-state	101	Engine governed	10.

RMC mode	Time in mode (seconds)	Engine speed	Torque (percent) ^{1, 2}
2b Transition	20	Engine governed	Linear transition.
3a Steady-state	277	Engine governed	75.
3b Transition	20	Engine governed	Linear transition.
4a Steady-state	339	Engine governed	25.
4b Transition	20	Engine governed	Linear transition.
5 Steady-state	350	Engine governed	50.

¹ The percent torque is relative to maximum test torque.

² Advance from one mode to the next within a 20-second transition phase. During the transition phase, command a linear progression from the torque setting of the current mode to the torque setting of the next mode.

(b) The following duty cycles apply for variable-speed engines with maximum engine power below 19 kW:

(1) The following duty cycle applies for discrete-mode testing:

G2 mode number	Engine speed ¹	Torque (percent) ²	Weighting factors
1	Maximum test speed	100	0.09
2	Maximum test speed	75	0.20
3	Maximum test speed	50	0.29
4	Maximum test speed	25	0.30
5	Maximum test speed	10	0.07
6	Warm idle	0	0.05

¹ Speed terms are defined in 40 CFR part 1065.

² The percent torque is relative to the maximum torque at the commanded test speed.

(2) The following duty cycle applies for ramped-modal testing:

RMC mode	Time in mode (seconds)	Engine speed ^{1, 3}	Torque (percent) ^{2, 3}
1a Steady-state	41	Warm idle	0.
1b Transition	20	Linear transition	Linear transition.
2a Steady-state	135	Maximum test speed	100.
2b Transition	20	Maximum test speed	Linear transition.
3a Steady-state	112	Maximum test speed	10.
3b Transition	20	Maximum test speed	Linear transition.
4a Steady-state	337	Maximum test speed	75.
4b Transition	20	Maximum test speed	Linear transition.
5a Steady-state	518	Maximum test speed	25.
5b Transition	20	Maximum test speed	Linear transition.
6a Steady-state	494	Maximum test speed	50.
6b Transition	20	Linear transition	Linear transition.
7 Steady-state	43	Warm idle	0.

¹ Speed terms are defined in 40 CFR part 1065.

² The percent torque is relative to the maximum torque at the commanded engine speed.

³ Advance from one mode to the next within a 20-second transition phase. During the transition phase, command a linear progression from the torque setting of the current mode to the torque setting of the next mode, and simultaneously command a similar linear progression for engine speed if there is a change in speed setting.

(c) The following duty cycles apply for variable-speed engines with maximum engine power at or above 19 kW:

(1) The following duty cycle applies for discrete-mode testing:

C1 mode number	Engine speed ¹	Torque (percent) ²	Weighting factors
1	Maximum test speed	100	0.15
2	Maximum test speed	75	0.15
3	Maximum test speed	50	0.15
4	Maximum test speed	10	0.10
5	Intermediate test speed	100	0.10
6	Intermediate test speed	75	0.10
7	Intermediate test speed	50	0.10
8	Warm idle	0	0.15

¹ Speed terms are defined in 40 CFR part 1065.

² The percent torque is relative to the maximum torque at the commanded test speed.

(2) The following duty cycle applies for ramped-modal testing:

RMC mode	Time in mode (seconds)	Engine speed ^{1,3}	Torque (percent) ^{2,3}
1a Steady-state	126	Warm Idle	0.
1b Transition	20	Linear Transition	Linear Transition.
2a Steady-state	159	Intermediate Speed	100.
2b Transition	20	Intermediate Speed	Linear Transition.
3a Steady-state	160	Intermediate Speed	50.
3b Transition	20	Intermediate Speed	Linear Transition.
4a Steady-state	162	Intermediate Speed	75.
4b Transition	20	Linear Transition	Linear Transition.
5a Steady-state	246	Maximum Test Speed	100.
5b Transition	20	Maximum Test Speed	Linear Transition.
6a Steady-state	164	Maximum Test Speed	10.
6b Transition	20	Maximum Test Speed	Linear Transition.
7a Steady-state	248	Maximum Test Speed	75.
7b Transition	20	Maximum Test Speed	Linear Transition.
8a Steady-state	247	Maximum Test Speed	50.
8b Transition	20	Linear Transition	Linear Transition.
9 Steady-state	128	Warm Idle	0.

¹ Speed terms are defined in 40 CFR part 1065.

² The percent torque is relative to the maximum torque at the commanded engine speed.

³ Advance from one mode to the next within a 20-second transition phase. During the transition phase, command a linear progression from the torque setting of the current mode to the torque setting of the next mode, and simultaneously command a similar linear progression for engine speed if there is a change in speed setting.

■ 43. Appendix III and Appendix IV of part 1039 are removed and reserved.

■ 44. A new part 1042 is added to subchapter U of chapter I to read as follows:

PART 1042—CONTROL OF EMISSIONS FROM NEW AND IN-USE MARINE COMPRESSION-IGNITION ENGINES AND VESSELS

Subpart A—Overview and Applicability

Sec.

- 1042.1 Applicability.
- 1042.2 Who is responsible for compliance?
- 1042.5 Exclusions.
- 1042.10 Organization of this part.
- 1042.15 Do any other regulation parts apply to me?

Subpart B—Emission Standards and Related Requirements

- 1042.101 Exhaust emission standards.
- 1042.107 Evaporative emission standards.
- 1042.110 Recording reductant use and other diagnostic functions.
- 1042.115 Other requirements.
- 1042.120 Emission-related warranty requirements.
- 1042.125 Maintenance instructions for Category 1 and Category 2 engines.
- 1042.130 Installation instructions for vessel manufacturers.
- 1042.135 Labeling.
- 1042.140 Maximum engine power, displacement, and power density.
- 1042.145 Interim provisions.

Subpart C—Certifying Engine Families

- 1042.201 General requirements for obtaining a certificate of conformity.
- 1042.205 Application requirements.
- 1042.210 Preliminary approval.
- 1042.220 Amending maintenance instructions.

- 1042.225 Amending applications for certification.
- 1042.230 Engine families.
- 1042.235 Emission testing required for a certificate of conformity.
- 1042.240 Demonstrating compliance with exhaust emission standards.
- 1042.245 Deterioration factors.
- 1042.250 Recordkeeping and reporting.
- 1042.255 EPA decisions.

Subpart D—Testing Production-Line Engines

- 1042.301 General provisions.
- 1042.305 Preparing and testing production-line engines.
- 1042.310 Engine selection.
- 1042.315 Determining compliance.
- 1042.320 What happens if one of my production-line engines fails to meet emission standards?
- 1042.325 What happens if an engine family fails the production-line testing requirements?
- 1042.330 Selling engines from an engine family with a suspended certificate of conformity.
- 1042.335 Reinstating suspended certificates.
- 1042.340 When may EPA revoke my certificate under this subpart and how may I sell these engines again?
- 1042.345 Reporting.
- 1042.350 Recordkeeping.

Subpart E—In-Use Testing

- 1042.401 General Provisions.

Subpart F—Test Procedures

- 1042.501 How do I run a valid emission test?
- 1042.505 Testing engines using discrete-mode or ramped-modal duty cycles.
- 1042.515 Test procedures related to not-to-exceed standards.
- 1042.520 What testing must I perform to establish deterioration factors?

- 1042.525 How do I adjust emission levels to account for infrequently regenerating aftertreatment devices?

Subpart G—Special Compliance Provisions

- 1042.601 General compliance provisions for marine engines and vessels.
- 1042.605 Dressing engines already certified to other standards for nonroad or heavy-duty highway engines for marine use.
- 1042.610 Certifying auxiliary marine engines to land-based standards.
- 1042.615 Replacement engine exemption.
- 1042.620 Engines used solely for competition.
- 1042.625 Special provisions for engines used in emergency applications.
- 1042.630 Personal-use exemption.
- 1042.635 National security exemption.
- 1042.640 Special provisions for branded engines.
- 1042.650 Migratory vessels.
- 1042.660 Requirements for vessel manufacturers, owners, and operators.

Subpart H—Averaging, Banking, and Trading for Certification

- 1042.701 General provisions.
- 1042.705 Generating and calculating emission credits.
- 1042.710 Averaging emission credits.
- 1042.715 Banking emission credits.
- 1042.720 Trading emission credits.
- 1042.725 Information required for the application for certification.
- 1042.730 ABT reports.
- 1042.735 Recordkeeping.
- 1042.745 Noncompliance.

Subpart I—Special Provisions for Remanufactured Marine Engines

- 1042.801 General provisions.
- 1042.810 Requirements for owner/operators and installers during remanufacture.
- 1042.815 Demonstrating availability.

- 1042.820 Emission standards and required emission reductions for remanufactured engines.
- 1042.825 Baseline determination.
- 1042.830 Labeling.
- 1042.835 Certification of remanufactured engines.
- 1042.836 Marine certification of locomotive remanufacturing systems.
- 1042.840 Application requirements for remanufactured engines.
- 1042.845 Remanufactured engine families.
- 1042.850 Exemptions and hardship relief.

Subpart J—Definitions and Other Reference Information

- 1042.901 Definitions.
- 1042.905 Symbols, acronyms, and abbreviations.

- 1042.910 Reference materials.
- 1042.915 Confidential information.
- 1042.920 Hearings.
- 1042.925 Reporting and recordkeeping requirements.
- Appendix I to Part 1042—Summary of Previous Emission Standards
- Appendix II to Part 1042—Steady-state Duty Cycles
- Appendix III to Part 1042—Not-to-Exceed Zones

Authority: 42 U.S.C. 7401–7671q.

Subpart A—Overview and Applicability

§ 1042.1 Applicability.

Except as provided in § 1042.5, the regulations in this part 1042 apply for

all new compression-ignition marine engines with per-cylinder displacement below 30.0 liters per cylinder and vessels containing such engines. See § 1042.901 for the definitions of engines and vessels considered to be new. This part 1042 applies as follows:

(a) This part 1042 applies for freshly manufactured marine engines starting with the model years noted in the following tables:

BILLING CODE 6560–50–P

Table 1 to §1042.1— Part 1042 Applicability by Model Year

Engine Category	Maximum Engine Power	Displacement (L/cyl) or Application	Model Year
Category 1	kW <75	disp.< 0.9	2009 ^a
	75 ≤ kW < 3700	disp.< 0.9	2012
		0.9 ≤ disp. < 1.2	2013
		1.2 ≤ disp. < 2.5	2014
		2.5 ≤ disp. < 3.5	2013
		3.5 ≤ disp.< 7.0	2012
	kW ≥ 3700	All	2014
Category 2	kW < 3700	7.0 ≤ disp. < 15.0	2013
	kW ≥ 3700	7.0 ≤ disp. < 15.0	2014
	All	15 ≤ disp. < 30	2014

^aSee Table 1 of §1042.101 for the first model year in which this part 1042 applies for engines with maximum engine power below 75 kW and displacement at or above 0.9 L/cyl.

(b) The requirements of subpart I of this part apply to remanufactured engines beginning July 7, 2008.

(c) See 40 CFR part 94 for requirements that apply to engines with maximum engine power at or above 37 kW not yet subject to the requirements of this part 1042. See 40 CFR part 89 for requirements that apply to engines with maximum engine power below 37 kW not yet subject to the requirements of this part 1042.

(d) The provisions of §§ 1042.620 and 1042.901 apply for new engines used solely for competition beginning January 1, 2009.

(e) Marine engines powered by natural gas with maximum engine power at or above 250 kW are deemed to be compression-ignition engines. These engines are therefore subject to all the requirements of this part even if they do not meet the definition of "compression-ignition" in § 1042.901.

§ 1042.2 Who is responsible for compliance?

The regulations in this part 1042 contain provisions that affect both engine manufacturers and others. However, the requirements of this part, other than those of subpart I of this part, are generally addressed to the engine manufacturer for freshly manufactured marine engines or other certificate holders. The term "you" generally means the engine manufacturer, as defined in § 1042.901, especially for issues related to certification (including production-line testing, reporting, etc.).

§ 1042.5 Exclusions.

This part does not apply to the following marine engines:

(a) *Foreign vessels.* The requirements and prohibitions of this part do not apply to engines installed on foreign vessels, as defined in § 1042.901.

(b) *Hobby engines.* Engines with per-cylinder displacement below 50 cubic centimeters are not subject to the provisions of this part 1042.

§ 1042.10 Organization of this part.

This part 1042 is divided into the following subparts:

(a) Subpart A of this part defines the applicability of this part 1042 and gives an overview of regulatory requirements.

(b) Subpart B of this part describes the emission standards and other requirements that must be met to certify engines under this part. Note that § 1042.145 discusses certain interim requirements and compliance provisions that apply only for a limited time.

(c) Subpart C of this part describes how to apply for a certificate of conformity.

(d) Subpart D of this part describes general provisions for testing production-line engines.

(e) Subpart E of this part describes general provisions for testing in-use engines.

(f) Subpart F of this part and 40 CFR 1065 describe how to test your engines.

(g) Subpart G of this part and 40 CFR part 1068 describe requirements, prohibitions, and other provisions that apply to engine manufacturers, vessel manufacturers, owners, operators, rebuilders, and all others.

(h) Subpart H of this part describes how you may generate and use emission credits to certify your engines.

(i) Subpart I of this part describes how these regulations apply for remanufactured engines.

(j) Subpart J of this part contains definitions and other reference information.

§ 1042.15 Do any other regulation parts apply to me?

(a) The evaporative emission requirements of part 1060 of this chapter apply to vessels that include installed engines fueled with a volatile liquid fuel as specified in § 1042.107. (**Note:** Conventional diesel fuel is not considered to be a volatile liquid fuel.)

(b) Part 1065 of this chapter describes procedures and equipment specifications for testing engines. Subpart F of this part 1042 describes how to apply the provisions of part 1065 of this chapter to determine whether engines meet the emission standards in this part.

(c) The requirements and prohibitions of part 1068 of this chapter apply to everyone, including anyone who manufactures, imports, installs, owns, operates, or rebuilds any of the engines subject to this part 1042, or vessels containing these engines. Part 1068 of this chapter describes general provisions, including these seven areas:

(1) Prohibited acts and penalties for engine manufacturers, vessel manufacturers, and others.

(2) Rebuilding and other aftermarket changes.

(3) Exclusions and exemptions for certain engines.

(4) Importing engines.

(5) Selective enforcement audits of your production.

(6) Defect reporting and recall.

(7) Procedures for hearings.

(d) Other parts of this chapter apply if referenced in this part.

Subpart B—Emission Standards and Related Requirements

§ 1042.101 Exhaust emission standards.

(a) *Duty-cycle standards.* Exhaust emissions from your engines may not exceed emission standards, as follows:

(1) Measure emissions using the test procedures described in subpart F of this part.

(2) The following CO emission standards in this paragraph (a)(2) apply starting with the applicable model year identified in § 1042.1:

(i) 8.0 g/kW-hr for engines below 8 kW.

(ii) 6.6 g/kW-hr for engines at or above 8 kW and below 19 kW.

(iii) 5.5 g/kW-hr for engines at or above 19 kW and below 37 kW.

(iv) 5.0 g/kW-hr for engines at or above 37 kW.

(3) Except as described in paragraphs (a)(4) and (5) of this section, the Tier 3 standards for PM and NO_x+HC emissions are described in the following tables:

BILLING CODE 6560-50-P

Table 1 to §1042.101— Tier 3 Standards for Category 1 Engines Below 3700 kW ^a

Power Density and Application	Displacement (L/cyl)	Maximum Engine Power	Model Year	PM (g/kW-hr)	NO _x +HC (g/kW-hr)
all	disp.< 0.9	kW <19	2009+	0.40	7.5
		19 ≤ kW < 75	2009-2013	0.30	7.5
			2014+	0.30	4.7
Commercial engines with kW/L ≤ 35 ^b	disp.< 0.9	kW ≥ 75	2012+	0.14	5.4
	0.9 ≤ disp. < 1.2	all	2013+	0.12	5.4
			2014-2017	0.11	5.6
	1.2 ≤ disp. < 2.5	kW < 600	2018+	0.10	5.6
		kW ≥ 600	2014+	0.11	5.6
	2.5 ≤ disp. < 3.5	kW < 600	2013-2017	0.11	5.6
			2018+	0.10	5.6
		kW ≥ 600	2013+	0.11	5.6
			2012-2017	0.11	5.8
	3.5 ≤ disp.< 7.0	kW < 600	2018+	0.10	5.8
kW ≥ 600		2012+	0.11	5.8	
Commercial engines with kW/L > 35 and all recreational engines	disp. < 0.9	kW ≥ 75	2012+	0.15	5.8
	0.9 ≤ disp. < 1.2	all	2013+	0.14	5.8
			2014+	0.12	5.8
	1.2 ≤ disp. < 2.5	all	2013+	0.12	5.8
	2.5 ≤ disp. < 3.5		2012+	0.11	5.8
3.5 ≤ disp. < 7.0	all	2013+	0.12	5.8	
2012+		0.11	5.8		

^a No Tier 3 standards apply for commercial Category 1 engines at or above 3700 kW. See §1042.1(c) and paragraph (a)(7) of this section for the standards that apply for these engines.

^b The applicable NO_x+HC standards specified for Tier 2 engines in Appendix I of this part continue to apply instead of the values noted in the table for commercial engines at or above 2000 kW. FELs for these engines may not be higher than the Tier 1 NO_x standard specified in Appendix I of this part.

BILLING CODE 6560-50-C

TABLE 2 TO § 1042.101.—TIER 3 STANDARDS FOR CATEGORY 2 ENGINES BELOW 3700 kW ^a

Displacement (L/cyl)	Maximum engine power	Model year	PM (g/kW-hr)	NO _x +HC (g/kW-hr)
7.0 ≤ disp. < 15.0	kW < 2000	2013+	0.14	6.2
	2000 ≤ kW < 3700	2013+	0.14	^b 7.8
15.0 ≤ disp. < 20.0 ^c	kW < 2000	2014+	0.34	7.0
20.0 ≤ disp. < 25.0 ^c	kW < 2000	2014+	0.27	9.8
25.0 ≤ disp. < 30.0 ^c	kW < 2000	2014+	0.27	11.0

^aNo Tier 3 standards apply for Category 2 engines at or above 3700 kW. See §1042.1(c) and paragraph (a)(7) of this section for the standards that apply for these engines.

^bFor engines subject to the 7.8 g/kW-hr NO_x+HC standard, FELs may not be higher than the Tier 1 NO_x standard specified in Appendix I of this part.

^cNo Tier 3 standards apply for Category 2 engines with per-cylinder displacement above 15.0 liters if maximum engine power is at or above 2000 kW. See § 1042.1(c) and paragraph (a)(7) of this section for the standards that apply for these engines.

(4) For Tier 3 engines at or above 19 kW and below 75 kW with displacement below 0.9 L/cyl, you may alternatively certify some or all of your engine families to a PM emission standard of 0.20 g/kW-hr and a NO_x+HC emission standard of 5.8 g/kW-hr for 2014 and later model years.

(5) Starting with the 2014 model year, recreational marine engines at or above 3700 kW (with any displacement) must be certified under this part 1042 to the

Tier 3 standards specified in this section for 3.5 to 7.0 L/cyl recreational marine engines.

(6) Interim Tier 4 PM standards apply for 2014 and 2015 model year engines between 2000 and 3700 kW as specified in this paragraph (a)(6). These engines are considered to be Tier 4 engines.

(i) For Category 1 engines, the Tier 3 PM standards from Table 1 to this section continue to apply. PM FELs for these engines may not be higher than

the applicable Tier 2 PM standards specified in Appendix I of this part.

(ii) For Category 2 engines with per-cylinder displacement below 15.0 liters, the Tier 3 PM standards from Table 2 to this section continue to apply. PM FELs for these engines may not be higher than 0.27 g/kW-hr.

(iii) For Category 2 engines with per-cylinder displacement at or above 15.0 liters, the PM standard is 0.34 g/kW-hr for engines at or above 2000 kW and

below 3300 kW, and 0.27 g/kW-hr for engines at or above 3300 kW and below

3700 kW. PM FELs for these engines may not be higher than 0.50 g/kW-hr. (7) Except as described in paragraph (a)(8) of this section, the Tier 4

standards for PM, NO_x, and HC emissions are described in the following table:

TABLE 3 TO § 1042.101.—TIER 4 STANDARDS FOR CATEGORY 2 AND COMMERCIAL CATEGORY 1 ENGINES ABOVE 600 kW

Maximum engine power	Displacement (L/cyl)	Model year	PM (g/kW-hr)	NO _x (g/kW-hr)	HC (g/kW-hr)
600 ≤ kW < 1400	all	2017+	0.04	1.8	0.19
1400 ≤ kW < 2000	all	2016+	0.04	1.8	0.19
2000 ≤ kW < 3700 ^a	all	2014+	0.04	1.8	0.19
kW ≥ 3700	disp. <15.0	2014–2015	0.12	1.8	0.19
	15.0 ≤ disp. < 30.0	2014–2015	0.25	1.8	0.19
	all	2016+	0.06	1.8	0.19

^a See paragraph (a)(6) of this section for interim PM standards that apply for model years 2014 and 2015 for engines between 2000 and 3700 kW. The Tier 4 NO_x FEL cap for engines at or above 2000 kW and below 3700 kW is 7.0 g/kW-hr. Starting in the 2016 model year, the Tier 4 PM FEL cap for engines at or above 2000 kW and below 3700 kW is 0.34 g/kW-hr.

(8) The following optional provisions apply for complying with the Tier 3 and Tier 4 standards specified in paragraphs (a)(3) and (6) of this section:

(i) You may use NO_x credits accumulated through the ABT program to certify Tier 4 engines to a NO_x+HC emission standard of 1.9 g/kW-hr instead of the NO_x and HC standards that would otherwise apply by certifying your family to a NO_x+HC FEL. Calculate the NO_x credits needed as specified in subpart H of this part using the NO_x+HC emission standard and FEL in the calculation instead of the otherwise applicable NO_x standard and

FEL. You may not generate credits relative to the alternate standard or certify to the standard without using credits.

(ii) For engines below 1000 kW, you may delay complying with the Tier 4 standards in the 2017 model year for up to nine months, but you must comply no later than October 1, 2017.

(iii) For engines at or above 3700 kW, you may delay complying with the Tier 4 standards in the 2016 model year for up to twelve months, but you must comply no later than December 31, 2016.

(iv) For Category 2 engines at or above 1400 kW, you may alternatively comply with the Tier 3 and Tier 4 standards specified in Table 4 of this section instead of the NO_x, HC, NO_x+HC, and PM standards specified in paragraphs (a)(3) and (6) of this section. The CO standards specified in paragraph (a)(2) of this section apply without regard to whether you choose this option. If you choose this option, you must do so for all engines at or above 1400 kW in the same displacement category (that is, 7–15, 15–20, 20–25, or 25–30 liters per cylinder) in model years 2012 through 2015.

TABLE 4 TO § 1042.101.—OPTIONAL TIER 3 AND TIER 4 STANDARDS FOR CATEGORY 2 ENGINES AT OR ABOVE 1400 kW

Tier	Maximum engine power	Model year	PM (g/kW-hr)	NO _x (g/kW-hr)	HC (g/kW-hr)
Tier 3	kW ≥ 1400	2012–2014	0.14	7.8 NO _x +HC	
Tier 4	1400 ≤ kW < 3700	2015	0.04	1.8	0.19
	kW ≥ 3700	2015	0.06	1.8	0.19

(b) *Averaging, banking, and trading.* You may generate or use emission credits under the averaging, banking, and trading (ABT) program as described in subpart H of this part for demonstrating compliance with NO_x, NO_x+HC, and PM emission standards for Category 1 and Category 2 engines. You may also use NO_x or NO_x+HC emission credits to comply with the alternate NO_x+HC standard in paragraph (a)(8)(i) of this section. Generating or using emission credits requires that you specify a family emission limit (FEL) for each pollutant you include in the ABT program for each engine family. These FELs serve as the emission standards for the engine family with respect to all required testing instead of the standards specified in paragraph (a) of this

section. The FELs determine the not-to-exceed standards for your engine family, as specified in paragraph (c) of this section. Unless otherwise specified, the following FEL caps apply:

(1) FELs for Tier 3 engines may not be higher than the applicable Tier 2 standards specified in Appendix I of this part.

(2) FELs for Tier 4 engines may not be higher than the applicable Tier 3 standards specified in paragraph (a)(3) of this section.

(c) *Not-to-exceed standards.* Except as noted in § 1042.145(e), exhaust emissions from all engines subject to the requirements of this part may not exceed the not-to-exceed (NTE) standards as follows:

(1) Use the following equation to determine the NTE standards:

(i) NTE standard for each pollutant = STD × M.

Where:

STD = The standard specified for that pollutant in this section if you certify without using ABT for that pollutant; or the FEL for that pollutant if you certify using ABT.

M = The NTE multiplier for that pollutant.

(ii) Round each NTE standard to the same number of decimal places as the emission standard.

(2) Determine the applicable NTE zone and subzones as described in § 1042.515. Determine NTE multipliers for specific zones and subzones and pollutants as follows:

(i) For commercial marine engines certified using the duty cycle specified in § 1042.505(b)(1), except for variable-speed propulsion marine engines used

with controllable-pitch propellers or with electrically coupled propellers, apply the following NTE multipliers:

(A) Subzone 1: 1.2 for Tier 3 NO_x+HC standards.

(B) Subzone 1: 1.5 for Tier 4 standards and Tier 3 PM and CO standards.

(C) Subzone 2: 1.5 for NO_x+HC standards.

(D) Subzone 2: 1.9 for PM and CO standards.

(ii) For recreational marine engines certified using the duty cycle specified in § 1042.505(b)(2), except for variable-speed marine engines used with controllable-pitch propellers or with electrically coupled propellers, apply the following NTE multipliers:

(A) Subzone 1: 1.2 for Tier 3 NO_x+HC standards.

(B) Subzone 1: 1.5 for Tier 4 standards and Tier 3 PM and CO standards.

(C) Subzones 2 and 3: 1.5 for NO_x+HC standards.

(D) Subzones 2 and 3: 1.9 for PM and CO standards.

(iii) For variable-speed marine engines used with controllable-pitch propellers or with electrically coupled propellers that are certified using the duty cycle specified in § 1042.505(b)(1), (2), or (3), apply the following NTE multipliers:

(A) Subzone 1: 1.2 for Tier 3 NO_x+HC standards.

(B) Subzone 1: 1.5 for Tier 4 standards and Tier 3 PM and CO standards.

(C) Subzone 2: 1.5 for NO_x+HC standards.

(D) Subzone 2: 1.9 for PM and CO standards. However, there is no NTE standard in Subzone 2b for PM emissions if the engine family's applicable standard for PM is at or above 0.07 g/kW-hr.

(iv) For constant-speed engines certified using a duty cycle specified in § 1042.505(b)(3) or (4), apply the following NTE multipliers:

(A) Subzone 1: 1.2 for Tier 3 NO_x+HC standards.

(B) Subzone 1: 1.5 for Tier 4 standards and Tier 3 PM and CO standards.

(C) Subzone 2: 1.5 for NO_x+HC standards.

(D) Subzone 2: 1.9 for PM and CO standards. However, there is no NTE standard for PM emissions if the engine family's applicable standard for PM is at or above 0.07 g/kW-hr.

(v) For variable-speed auxiliary marine engines certified using the duty cycle specified in § 1042.505(b)(5)(ii) or (iii):

(A) Subzone 1: 1.2 for Tier 3 NO_x+HC standards.

(B) Subzone 1: 1.5 for Tier 4 standards and Tier 3 PM and CO standards.

(C) Subzone 2: 1.2 for Tier 3 NO_x+HC standards.

(D) Subzone 2: 1.5 for Tier 4 standards and Tier 3 PM and CO standards.

However, there is no NTE standard for PM emissions if the engine family's applicable standard for PM is at or above 0.07 g/kW-hr.

(3) The NTE standards apply to your engines whenever they operate within the NTE zone for an NTE sampling period of at least thirty seconds, during which only a single operator demand set point may be selected. Engine operation during a change in operator demand is excluded from any NTE sampling period. There is no maximum NTE sampling period.

(4) Collect emission data for determining compliance with the NTE standards using the procedures described in subpart F of this part.

(5) You may ask us to accept as compliant an engine that does not fully meet specific requirements under the applicable NTE standards where such deficiencies are necessary for safety.

(d) *Fuel types.* The exhaust emission standards in this section apply for engines using the fuel type on which the engines in the engine family are designed to operate.

(1) You must meet the numerical emission standards for hydrocarbons in this section based on the following types of hydrocarbon emissions for engines powered by the following fuels:

(i) Alcohol-fueled engines must comply with Tier 3 HC standards based on THCE emissions and with Tier 4 standards based on NMHCE emissions.

(ii) Natural gas-fueled engines must comply with HC standards based on NMHC emissions.

(iii) Diesel-fueled and other engines must comply with Tier 3 HC standards based on THC emissions and with Tier 4 standards based on NMHC emissions.

(2) Tier 3 and later engines must comply with the exhaust emission standards when tested using test fuels containing 15 ppm or less sulfur (ultra low-sulfur diesel fuel). Manufacturers may use low-sulfur diesel fuel (without request) to certify an engine otherwise requiring an ultra low-sulfur test fuel; however, emissions may not be corrected to account for the effects of using higher sulfur fuel.

(3) Engines designed to operate using residual fuel must comply with the standards and requirements of this part when operated using residual fuel in addition to complying with the requirements of this part when operated using diesel fuel.

(e) *Useful life.* Your engines must meet the exhaust emission standards of this section over their full useful life, expressed as a period in years or hours

of engine operation, whichever comes first.

(1) The minimum useful life values are as follows, except as specified by paragraph (e)(2) or (3) of this section:

(i) 10 years or 1,000 hours of operation for recreational Category 1 engines

(ii) 5 years or 3,000 hours of operation for commercial engines below 19 kW.

(iii) 7 years or 5,000 hours of operation for commercial engines at or above 19 kW and below 37kW.

(iv) 10 years or 10,000 hours of operation for commercial Category 1 engines at or above 37 kW.

(v) 10 years or 20,000 hours of operation for Category 2 engines.

(2) Specify a longer useful life in hours for an engine family under either of two conditions:

(i) If you design, advertise, or market your engine to operate longer than the minimum useful life (your recommended hours until rebuild indicates a longer design life).

(ii) If your basic mechanical warranty is longer than the minimum useful life.

(3) You may request in your application for certification that we approve a shorter useful life for an engine family. We may approve a shorter useful life, in hours of engine operation but not in years, if we determine that these engines will rarely operate longer than the shorter useful life. If engines identical to those in the engine family have already been produced and are in use, your demonstration must include documentation from such in-use engines. In other cases, your demonstration must include an engineering analysis of information equivalent to such in-use data, such as data from research engines or similar engine models that are already in production. Your demonstration must also include any overhaul interval that you recommend, any mechanical warranty that you offer for the engine or its components, and any relevant customer design specifications. Your demonstration may include any other relevant information. The useful life value may not be shorter than any of the following:

(i) 1,000 hours of operation.

(ii) Your recommended overhaul interval.

(iii) Your mechanical warranty for the engine.

(f) *Applicability for testing.* The duty-cycle emission standards in this subpart apply to all testing performed according to the procedures in § 1042.505, including certification, production-line, and in-use testing. The not-to-exceed standards apply for all testing

performed according to the procedures of subpart F of this part.

§ 1042.107 Evaporative emission standards.

You must design and produce engines fueled with a volatile liquid fuel to minimize evaporative emissions during normal operation, including periods when the engine is shut down. You must also design and produce them to minimize the escape of fuel vapors during refueling. Hoses used to refuel gaseous-fueled engines may not be designed to be bled or vented to the atmosphere under normal operating conditions. No valves or pressure-relief vents may be used on gaseous-fueled engines except as emergency safety devices that do not operate at normal system operating flows and pressures.

§ 1042.110 Recording reductant use and other diagnostic functions.

(a) Engines equipped with SCR systems using a reductant other than the engine's fuel must meet the following requirements:

(1) The diagnostic system must monitor reductant quality and tank levels and alert operators to the need to refill the reductant tank before it is empty, or to replace the reductant if it does not meet your concentration specifications. Unless we approve other alerts, use a malfunction-indicator light (MIL) and an audible alarm. You do not need to separately monitor reductant quality if you include an exhaust NO_x sensor (or other sensor) that allows you to determine inadequate reductant quality. However, tank level must be monitored in all cases.

(2) The onboard computer log must record in nonvolatile computer memory all incidents of engine operation with inadequate reductant injection or reductant quality.

(b) If you determine your emission controls have failure modes that may reasonably be expected to affect safety, equip the engines with diagnostic features that will alert the operator to such failures. Use good engineering judgment to alert the operator before the failure occurs.

(c) You may equip your engine with other diagnostic features. If you do, they must be designed to allow us to read and interpret the codes. Note that §§ 1042.115 and 1042.205 require that you provide us any information needed to read, record, and interpret all the information broadcast by an engine's onboard computers and electronic control units.

§ 1042.115 Other requirements.

Engines that are required to comply with the emission standards of this part must meet the following requirements:

(a) *Crankcase emissions.* Crankcase emissions may not be discharged directly into the ambient atmosphere from any engine throughout its useful life, except as follows:

(1) Engines may discharge crankcase emissions to the ambient atmosphere if the emissions are added to the exhaust emissions (either physically or mathematically) during all emission testing. If you take advantage of this exception, you must do both of the following things:

(i) Manufacture the engines so that all crankcase emissions can be routed into the applicable sampling systems specified in 40 CFR part 1065.

(ii) Account for deterioration in crankcase emissions when determining exhaust deterioration factors.

(2) For purposes of this paragraph (a), crankcase emissions that are routed to the exhaust upstream of exhaust aftertreatment during all operation are not considered to be discharged directly into the ambient atmosphere.

(b) *Torque broadcasting.* Electronically controlled engines must broadcast their speed and output shaft torque (in newton-meters). Engines may alternatively broadcast a surrogate value for determining torque. Engines must broadcast engine parameters such that they can be read with a remote device, or broadcast them directly to their controller area networks. This information is necessary for testing engines in the field (see § 1042.515).

(c) *EPA access to broadcast information.* If we request it, you must provide us any hardware or tools we would need to readily read, interpret, and record all information broadcast by an engine's on-board computers and electronic control modules. If you broadcast a surrogate parameter for torque values, you must provide us what we need to convert these into torque units. We will not ask for hardware or tools if they are readily available commercially.

(d) *Adjustable parameters.* An operating parameter is not considered adjustable if you permanently seal it or if it is not normally accessible using ordinary tools. The following provisions apply for adjustable parameters:

(1) Category 1 engines that have adjustable parameters must meet all the requirements of this part for any adjustment in the physically adjustable range. We may require that you set adjustable parameters to any specification within the adjustable range during any testing, including

certification testing, selective enforcement auditing, or in-use testing.

(2) Category 2 engines that have adjustable parameters must meet all the requirements of this part for any adjustment in the specified adjustable range. You must specify in your application for certification the adjustable range of each adjustable parameter on a new engine to—

(i) Ensure that safe engine operating characteristics are available within that range, as required by section 202(a)(4) of the Clean Air Act (42 U.S.C. 7521(a)(4)), taking into consideration the production tolerances.

(ii) Limit the physical range of adjustability to the maximum extent practicable to the range that is necessary for proper operation of the engine.

(e) *Prohibited controls.* You may not design your engines with emission-control devices, systems, or elements of design that cause or contribute to an unreasonable risk to public health, welfare, or safety while operating. For example, this would apply if the engine emits a noxious or toxic substance it would otherwise not emit, that contributes to such an unreasonable risk.

(f) *Defeat devices.* You may not equip your engines with a defeat device. A defeat device is an auxiliary emission control device that reduces the effectiveness of emission controls under conditions that the engine may reasonably be expected to encounter during normal operation and use. This does not apply to auxiliary emission control devices you identify in your certification application if any of the following is true:

(1) The conditions of concern were substantially included in the applicable duty-cycle test procedures described in subpart F of this part (the portion during which emissions are measured). See paragraph (f)(4) of this section for other conditions.

(2) You show your design is necessary to prevent engine (or vessel) damage or accidents.

(3) The reduced effectiveness applies only to starting the engine.

§ 1042.120 Emission-related warranty requirements.

(a) *General requirements.* You must warrant to the ultimate purchaser and each subsequent purchaser that the new engine, including all parts of its emission control system, meets two conditions:

(1) It is designed, built, and equipped so it conforms at the time of sale to the ultimate purchaser with the requirements of this part.

(2) It is free from defects in materials and workmanship that may keep it from meeting these requirements.

(b) *Warranty period.* Your emission-related warranty must be valid for at least as long as the minimum warranty periods listed in this paragraph (b) in hours of operation and years, whichever comes first. You may offer an emission-related warranty more generous than we require. The emission-related warranty for the engine may not be shorter than any published warranty you offer without charge for the engine. Similarly, the emission-related warranty for any component may not be shorter than any published warranty you offer without charge for that component. If an engine has no hour meter, we base the warranty periods in this paragraph (b) only on the engine's age (in years).

The warranty period begins when the engine is placed into service. The following minimum warranty periods apply:

(1) For Category 1 and Category 2 engines, your emission-related warranty must be valid for at least 50 percent of the engine's useful life in hours of operation or a number of years equal to at least 50 percent of the useful life in years, whichever comes first.

(2) [Reserved]

(c) *Components covered.* The emission-related warranty covers all components whose failure would increase an engine's emissions of any pollutant, including those listed in 40 CFR part 1068, Appendix I, and those from any other system you develop to control emissions. The emission-related warranty for freshly manufactured marine engines covers these components even if another company produces the component. Your emission-related warranty does not cover components whose failure would not increase an engine's emissions of any pollutant. For remanufactured engines, your emission-related warranty does not cover used parts that are not replaced during the remanufacture.

(d) *Limited applicability.* You may deny warranty claims under this section if the operator caused the problem through improper maintenance or use, as described in 40 CFR 1068.115.

(e) *Owners manual.* Describe in the owners manual the emission-related warranty provisions from this section that apply to the engine.

§ 1042.125 Maintenance instructions for Category 1 and Category 2 engines.

Give the ultimate purchaser of each new engine written instructions for properly maintaining and using the engine, including the emission control system, as described in this section. The

maintenance instructions also apply to service accumulation on your emission-data engines as described in § 1042.245 and in 40 CFR part 1065. This section applies only to Category 1 and Category 2 engines.

(a) *Critical emission-related maintenance.* Critical emission-related maintenance includes any adjustment, cleaning, repair, or replacement of critical emission-related components. This may also include additional emission-related maintenance that you determine is critical if we approve it in advance. You may schedule critical emission-related maintenance on these components if you meet the following conditions:

(1) You demonstrate that the maintenance is reasonably likely to be done at the recommended intervals on in-use engines. We will accept scheduled maintenance as reasonably likely to occur if you satisfy any of the following conditions:

(i) You present data showing that any lack of maintenance that increases emissions also unacceptably degrades the engine's performance.

(ii) You present survey data showing that at least 80 percent of engines in the field get the maintenance you specify at the recommended intervals.

(iii) You provide the maintenance free of charge and clearly say so in maintenance instructions for the customer.

(iv) You otherwise show us that the maintenance is reasonably likely to be done at the recommended intervals.

(2) For engines below 130 kW, you may not schedule critical emission-related maintenance more frequently than the following minimum intervals, except as specified in paragraphs (a)(4), (b), and (c) of this section:

(i) For EGR-related filters and coolers, PCV valves, and fuel injector tips (cleaning only), the minimum interval is 1,500 hours.

(ii) For the following components, including associated sensors and actuators, the minimum interval is 3,000 hours: Fuel injectors, turbochargers, catalytic converters, electronic control units, particulate traps, trap oxidizers, components related to particulate traps and trap oxidizers, EGR systems (including related components, but excluding filters and coolers), and other add-on components. For particulate traps, trap oxidizers, and components related to either of these, maintenance is limited to cleaning and repair only.

(3) For Category 1 and Category 2 engines at or above 130 kW, you may not schedule critical emission-related maintenance more frequently than the following minimum intervals, except as

specified in paragraphs (a)(4), (b), and (c) of this section:

(i) For EGR-related filters and coolers, PCV valves, and fuel injector tips (cleaning only), the minimum interval is 1,500 hours.

(ii) For the following components, including associated sensors and actuators, the minimum interval is 4500 hours: Fuel injectors, turbochargers, catalytic converters, electronic control units, particulate traps, trap oxidizers, components related to particulate traps and trap oxidizers, EGR systems (including related components, but excluding filters and coolers), and other add-on components. For particulate traps, trap oxidizers, and components related to either of these, maintenance is limited to cleaning and repair only.

(4) We may approve shorter maintenance intervals than those listed in paragraph (a)(3) of this section where technologically necessary.

(5) If your engine family has an alternate useful life under § 1042.101(e) that is shorter than the period specified in paragraph (a)(2) or (a)(3) of this section, you may not schedule critical emission-related maintenance more frequently than the alternate useful life, except as specified in paragraph (c) of this section.

(b) *Recommended additional maintenance.* You may recommend any additional amount of maintenance on the components listed in paragraph (a) of this section, as long as you state clearly that these maintenance steps are not necessary to keep the emission-related warranty valid. If operators do the maintenance specified in paragraph (a) of this section, but not the recommended additional maintenance, this does not allow you to disqualify those engines from in-use testing or deny a warranty claim. Do not take these maintenance steps during service accumulation on your emission-data engines.

(c) *Special maintenance.* You may specify more frequent maintenance to address problems related to special situations, such as atypical engine operation. You must clearly state that this additional maintenance is associated with the special situation you are addressing.

(d) *Noncritical emission-related maintenance.* Subject to the provisions of this paragraph (d), you may schedule any amount of emission-related inspection or maintenance that is not covered by paragraph (a) of this section (that is, maintenance that is neither explicitly identified as critical emission-related maintenance, nor that we approve as critical emission-related maintenance). Noncritical emission-

related maintenance generally includes maintenance on the components we specify in 40 CFR part 1068, Appendix I. You must state in the owners manual that these steps are not necessary to keep the emission-related warranty valid. If operators fail to do this maintenance, this does not allow you to disqualify those engines from in-use testing or deny a warranty claim. Do not take these inspection or maintenance steps during service accumulation on your emission-data engines.

(e) *Maintenance that is not emission-related.* For maintenance unrelated to emission controls, you may schedule any amount of inspection or maintenance. You may also take these inspection or maintenance steps during service accumulation on your emission-data engines, as long as they are reasonable and technologically necessary. This might include adding engine oil, changing air, fuel, or oil filters, servicing engine-cooling systems, and adjusting idle speed, governor, engine bolt torque, valve lash, or injector lash. You may perform this nonemission-related maintenance on emission-data engines at the least frequent intervals that you recommend to the ultimate purchaser (but not intervals recommended for severe service).

(f) *Source of parts and repairs.* State clearly on the first page of your written maintenance instructions that a repair shop or person of the owner's choosing may maintain, replace, or repair emission control devices and systems. Your instructions may not require components or service identified by brand, trade, or corporate name. Also, do not directly or indirectly condition your warranty on a requirement that the engine be serviced by your franchised dealers or any other service establishments with which you have a commercial relationship. You may disregard the requirements in this paragraph (f) if you do one of two things:

(1) Provide a component or service without charge under the purchase agreement.

(2) Get us to waive this prohibition in the public's interest by convincing us the engine will work properly only with the identified component or service.

(g) *Payment for scheduled maintenance.* Owners are responsible for properly maintaining their engines. This generally includes paying for scheduled maintenance. However, manufacturers must pay for scheduled maintenance during the useful life if it meets all the following criteria:

(1) Each affected component was not in general use on similar engines before

the applicable dates shown in paragraph (6) of the definition of "new marine engine" in § 1042.901.

(2) The primary function of each affected component is to reduce emissions.

(3) The cost of the scheduled maintenance is more than 2 percent of the price of the engine.

(4) Failure to perform the maintenance would not cause clear problems that would significantly degrade the engine's performance.

(h) *Owners manual.* Explain the owner's responsibility for proper maintenance in the owners manual.

§ 1042.130 Installation instructions for vessel manufacturers.

(a) If you sell an engine for someone else to install in a vessel, give the engine installer instructions for installing it consistent with the requirements of this part. Include all information necessary to ensure that an engine will be installed in its certified configuration.

(b) Make sure these instructions have the following information:

(1) Include the heading: "Emission-related installation instructions".

(2) State: "Failing to follow these instructions when installing a certified engine in a vessel violates federal law (40 CFR 1068.105(b)), subject to fines or other penalties as described in the Clean Air Act."

(3) Describe the instructions needed to properly install the exhaust system and any other components. Include instructions consistent with the requirements of § 1042.205(u).

(4) Describe any necessary steps for installing the diagnostic system described in § 1042.110.

(5) Describe any limits on the range of applications needed to ensure that the engine operates consistently with your application for certification. For example, if your engines are certified only for constant-speed operation, tell vessel manufacturers not to install the engines in variable-speed applications or modify the governor.

(6) Describe any other instructions to make sure the installed engine will operate according to design specifications in your application for certification. This may include, for example, instructions for installing aftertreatment devices when installing the engines.

(7) State: "If you install the engine in a way that makes the engine's emission control information label hard to read during normal engine maintenance, you must place a duplicate label on the vessel, as described in 40 CFR 1068.105."

(8) Describe any vessel labeling requirements specified in § 1042.135.

(c) You do not need installation instructions for engines you install in your own vessels.

(d) Provide instructions in writing or in an equivalent format. For example, you may post instructions on a publicly available Web site for downloading or printing. If you do not provide the instructions in writing, explain in your application for certification how you will ensure that each installer is informed of the installation requirements.

§ 1042.135 Labeling.

(a) Assign each engine a unique identification number and permanently affix, engrave, or stamp it on the engine in a legible way.

(b) At the time of manufacture, affix a permanent and legible label identifying each engine. The label must be—

(1) Attached in one piece so it is not removable without being destroyed or defaced.

(2) Secured to a part of the engine needed for normal operation and not normally requiring replacement.

(3) Durable and readable for the engine's entire life.

(4) Written in English.

(c) The label must—

(1) Include the heading "EMISSION CONTROL INFORMATION".

(2) Include your full corporate name and trademark. You may identify another company and use its trademark instead of yours if you comply with the provisions of § 1042.640.

(3) Include EPA's standardized designation for the engine family (and subfamily, where applicable).

(4) Identify all the emission standards that apply to the engine (or FELs, if applicable). If you do not declare an FEL under subpart H of this part, you may alternatively state the engine's category, displacement (in liters or L/cyl), maximum engine power (in kW), and power density (in kW/L) as needed to determine the emission standards for the engine family. You may specify displacement, maximum engine power, or power density as a range consistent with the ranges listed in § 1042.101. See § 1042.140 for descriptions of how to specify per-cylinder displacement, maximum engine power, and power density.

(5) State the date of manufacture [DAY (optional), MONTH, and YEAR]. However, you may omit this from the label if you stamp or engrave it on the engine, in which case you must also describe in your application for certification where you will identify the date on the engine.

(6) Identify the application(s) for which the engine family is certified

(such as constant-speed auxiliary, variable-speed propulsion engines used with fixed-pitch propellers, etc.). If the engine is certified as a recreational engine, state: "INSTALLING THIS RECREATIONAL ENGINE IN A COMMERCIAL VESSEL OR USING THE VESSEL FOR COMMERCIAL PURPOSES MAY VIOLATE FEDERAL LAW SUBJECT TO CIVIL PENALTY (40 CFR 1042.601)."

(7) For engines requiring ULSD, state: "ULTRA LOW SULFUR DIESEL FUEL ONLY".

(8) State the useful life for your engine family if the applicable useful life is based on the provisions of § 1042.101(e)(2) or (3).

(9) Identify the emission control system. Use terms and abbreviations consistent with SAE J1930 (incorporated by reference in § 1042.910). You may omit this information from the label if there is not enough room for it and you put it in the owners manual instead.

(10) State: "THIS MARINE ENGINE COMPLIES WITH U.S. EPA REGULATIONS FOR [MODEL YEAR]."

(11) For an engine that can be modified to operate on residual fuel, but has not been certified to meet the standards on such a fuel, include the statement: "THIS ENGINE IS CERTIFIED FOR OPERATION ONLY WITH DIESEL FUEL. MODIFYING THE ENGINE TO OPERATE ON RESIDUAL OR INTERMEDIATE FUEL MAY BE A VIOLATION OF FEDERAL LAW SUBJECT TO CIVIL PENALTIES."

(d) You may add information to the emission control information label as follows:

(1) You may identify other emission standards that the engine meets or does not meet (such as international standards). You may include this information by adding it to the statement we specify or by including a separate statement.

(2) You may add other information to ensure that the engine will be properly maintained and used.

(3) You may add appropriate features to prevent counterfeit labels. For example, you may include the engine's unique identification number on the label.

(e) For engines requiring ULSD, create a separate label with the statement: "ULTRA LOW SULFUR DIESEL FUEL ONLY". Permanently attach this label to the vessel near the fuel inlet or, if you do not manufacture the vessel, take one of the following steps to ensure that the vessel will be properly labeled:

(1) Provide the label to each vessel manufacturer and include in the emission-related installation

instructions the requirement to place this label near the fuel inlet.

(2) Confirm that the vessel manufacturers install their own complying labels.

(f) You may ask us to approve modified labeling requirements in this part 1042 if you show that it is necessary or appropriate. We will approve your request if your alternate label is consistent with the intent of the labeling requirements of this part.

(g) If you obscure the engine label while installing the engine in the vessel such that the label will be hard to read during normal maintenance, you must place a duplicate label on the vessel. If others install your engine in their vessels in a way that obscures the engine label, we require them to add a duplicate label on the vessel (see 40 CFR 1068.105); in that case, give them the number of duplicate labels they request and keep the following records for at least five years:

(1) Written documentation of the request from the vessel manufacturer.

(2) The number of duplicate labels you send for each family and the date you sent them.

§ 1042.140 Maximum engine power, displacement, and power density.

This section describes how to determine the maximum engine power, displacement, and power density of an engine for the purposes of this part. Note that maximum engine power may differ from the definition of "maximum test power" in § 1042.901.

(a) An engine configuration's maximum engine power is the maximum brake power point on the nominal power curve for the engine configuration, as defined in this section. Round the power value to the nearest whole kilowatt.

(b) The nominal power curve of an engine configuration is the relationship between maximum available engine brake power and engine speed for an engine, using the mapping procedures of 40 CFR part 1065, based on the manufacturer's design and production specifications for the engine. This information may also be expressed by a torque curve that relates maximum available engine torque with engine speed.

(c) An engine configuration's per-cylinder displacement is the intended swept volume of each cylinder. The swept volume of the engine is the product of the internal cross-section area of the cylinders, the stroke length, and the number of cylinders. Calculate the engine's intended swept volume from the design specifications for the cylinders using enough significant

figures to allow determination of the displacement to the nearest 0.02 liters. Determine the final value by truncating digits to establish the per-cylinder displacement to the nearest 0.1 liters. For example, for an engine with circular cylinders having an internal diameter of 13.0 cm and a 15.5 cm stroke length, the rounded displacement would be: $(13.0/2)^2 \times (\pi) \times (15.5) \div 1000 = 2.0$ liters.

(d) The nominal power curve and intended swept volume must be within the range of the actual power curves and swept volumes of production engines considering normal production variability. If after production begins, it is determined that either your nominal power curve or your intended swept volume does not represent production engines, we may require you to amend your application for certification under § 1042.225.

(e) Throughout this part, references to a specific power value for an engine are based on maximum engine power. For example, the group of engines with maximum engine power above 600 kW may be referred to as engines above 600 kW.

(f) Calculate an engine family's power density in kW/L by dividing the unrounded maximum engine power by the engine's unrounded per-cylinder displacement, then dividing by the number of cylinders. Round the calculated value to the nearest whole number.

§ 1042.145 Interim provisions.

(a) *General.* The provisions in this section apply instead of other provisions in this part for Category 1 and Category 2 engines. This section describes when these interim provisions expire.

(b) *Delayed standards.* Post-manufacturer marinizers that are small-volume engine manufacturers may delay compliance with the Tier 3 standards for engines below 600 kW as follows:

(1) You may delay compliance with the Tier 3 standards for one model year, as long as the engines meet all the requirements that apply to Tier 2 engines.

(2) You may delay compliance with the NTE standards for Tier 3 engines for three model years in addition to the one-year delay specified in paragraph (b)(1) of this section, as long as the engines meet all other Tier 3 requirements for the appropriate model year.

(c) *Part 1065 test procedures.* You must generally use the test procedures specified in subpart F of this part, including the applicable test procedures in 40 CFR part 1065. As specified in this paragraph (c), you may use a

combination of the test procedures specified in this part and the test procedures specified for Tier 2 engines before January 1, 2015. After this date, you must use test procedures only as specified in subpart F of this part.

(1) You may determine maximum test speed for engines below 37 kW as specified in 40 CFR part 89 without request through the 2009 model year.

(2) Before January 1, 2015, you may ask to use some or all of the procedures specified in 40 CFR part 94 (or 40 CFR part 89 for engines below 37 kW) for engines certified under this part 1042. If you ask to rely on a combination of procedures under this paragraph (c)(2), we will approve your request only if you show us that it does not affect your ability to demonstrate compliance with the applicable emission standards. This

generally requires that the combined procedures would result in emission measurements at least as high as those that would be measured using the procedures specified in this part. Alternatively, you may demonstrate that the combined effects of the different procedures is small relative to your compliance margin (the degree to which your emissions are below the applicable standards).

(d) [Reserved]

(e) *Delayed compliance with NTE standards.* Engines below 56 kW may delay complying with the NTE standards specified in § 1042.101(c) until the 2013 model year. Engines at or above 56 kW and below 75 kW may delay complying with the NTE standards specified in § 1042.101(c) until the 2012 model year.

(f) *In-use compliance limits.* The provisions of this paragraph (f) apply for the first three model years of the Tier 4 standards. For purposes of determining compliance based on testing other than certification or production-line testing, calculate the applicable in-use compliance limits by adjusting the applicable standards/FELs. The PM adjustment does not apply for engines with a PM standard or FEL above 0.04 g/kW-hr. The NO_x adjustment does not apply for engines with a NO_x FEL above 2.7 g/kW-hr. Add the applicable adjustments in one of the following tables to the otherwise applicable standards and NTE limits. You must specify during certification which additions, if any, will apply for your engines.

TABLE 1 TO § 1042.145.—IN-USE ADJUSTMENTS FOR THE FIRST THREE MODEL YEARS OF THE TIER 4 STANDARDS

Fraction of useful life already used	In-use adjustments (g/kW-hr)	
	For Tier 4 NO _x standards	For Tier 4 PM standards
0 < hours ≤ 50% of useful life	0.9	0.02
50 < hours ≤ 75% of useful life	1.3	0.02
hours > 75% of useful life	1.7	0.02

TABLE 2 TO § 1042.145.—OPTIONAL IN-USE ADJUSTMENTS FOR THE FIRST THREE MODEL YEARS OF THE TIER 4 STANDARDS

Fraction of useful life already used	In-use adjustments (g/kW-hr)	
	For model year 2017 and earlier Tier 4 NO _x standards	For model year 2017 and earlier Tier 4 PM standards
0 < hours ≤ 50% of useful life	0.3	0.05
50 < hours ≤ 75% of useful life	0.4	0.05
hours > 75% of useful life	0.5	0.05

(g) *Deficiencies for NTE standards.* You may ask us to accept as compliant an engine that does not fully meet specific requirements under the applicable NTE standards. Such deficiencies are intended to allow for minor deviations from the NTE standards under limited conditions. We expect your engines to have functioning emission control hardware that allows you to comply with the NTE standards.

(1) Request our approval for specific deficiencies in your application for certification, or before you submit your application. We will not approve deficiencies retroactively to cover engines already certified. In your request, identify the scope of each deficiency and describe any auxiliary emission control devices you will use to control emissions to the lowest practical

level, considering the deficiency you are requesting.

(2) We will approve a deficiency only if compliance would be infeasible or unreasonable considering such factors as the technical feasibility of the given hardware and the applicable lead time and production cycles. We may consider other relevant factors.

(3) Our approval applies only for a single model year and may be limited to specific engine configurations. We may approve your request for the same deficiency in the following model year if correcting the deficiency would require unreasonable hardware or software modifications and we determine that you have demonstrated an acceptable level of effort toward complying.

(4) You may ask for any number of deficiencies in the first three model

years during which NTE standards apply for your engines. For the next four model years, we may approve up to three deficiencies per engine family. Deficiencies of the same type that apply similarly to different power ratings within a family count as one deficiency per family. We may condition approval of any such additional deficiencies during these four years on any additional conditions we determine to be appropriate. We will not approve deficiencies after the seven-year period specified in this paragraph (g)(4), unless they are related to safety.

Subpart C—Certifying Engine Families

§ 1042.201 General requirements for obtaining a certificate of conformity.

(a) You must send us a separate application for a certificate of conformity for each engine family. A

certificate of conformity is valid starting with the indicated effective date, but it is not valid for any production after December 31 of the model year for which it is issued. No certificate will be issued after December 31 of the model year.

(b) The application must contain all the information required by this part and must not include false or incomplete statements or information (see § 1042.255).

(c) We may ask you to include less information than we specify in this subpart, as long as you maintain all the information required by § 1042.250.

(d) You must use good engineering judgment for all decisions related to your application (see 40 CFR 1068.5).

(e) An authorized representative of your company must approve and sign the application.

(f) See § 1042.255 for provisions describing how we will process your application.

(g) We may require you to deliver your test engines to a facility we designate for our testing (see § 1042.235(c)).

(h) For engines that become new as a result of substantial modifications or for engines installed on imported vessels that become subject to the requirements of this part, we may specify alternate certification provisions consistent with the intent of this part. See the definition of "new marine engine" in § 1042.901.

§ 1042.205 Application requirements.

This section specifies the information that must be in your application, unless we ask you to include less information under § 1042.201(c). We may require you to provide additional information to evaluate your application.

(a) Describe the engine family's specifications and other basic parameters of the engine's design and emission controls. List the fuel type on which your engines are designed to operate (for example, ultra low-sulfur diesel fuel). List each distinguishable engine configuration in the engine family. For each engine configuration, list the maximum engine power and the range of values for maximum engine power resulting from production tolerances, as described in § 1042.140.

(b) Explain how the emission control system operates. Describe in detail all system components for controlling exhaust emissions, including all auxiliary emission control devices (AECs) and all fuel-system components you will install on any production or test engine. Identify the part number of each component you describe. For this paragraph (b), treat as separate AECs any devices that

modulate or activate differently from each other. Include all the following:

(1) Give a general overview of the engine, the emission control strategies, and all AECs.

(2) Describe each AEC's general purpose and function.

(3) Identify the parameters that each AEC senses (including measuring, estimating, calculating, or empirically deriving the values). Include vessel-based parameters and state whether you simulate them during testing with the applicable procedures.

(4) Describe the purpose for sensing each parameter.

(5) Identify the location of each sensor the AEC uses.

(6) Identify the threshold values for the sensed parameters that activate the AEC.

(7) Describe the parameters that the AEC modulates (controls) in response to any sensed parameters, including the range of modulation for each parameter, the relationship between the sensed parameters and the controlled parameters and how the modulation achieves the AEC's stated purpose. Use graphs and tables, as necessary.

(8) Describe each AEC's specific calibration details. This may be in the form of data tables, graphical representations, or some other description.

(9) Describe the hierarchy among the AECs when multiple AECs sense or modulate the same parameter. Describe whether the strategies interact in a comparative or additive manner and identify which AEC takes precedence in responding, if applicable.

(10) Explain the extent to which the AEC is included in the applicable test procedures specified in subpart F of this part.

(11) Do the following additional things for AECs designed to protect engines or vessels:

(i) Identify the engine and/or vessel design limits that make protection necessary and describe any damage that would occur without the AEC.

(ii) Describe how each sensed parameter relates to the protected components' design limits or those operating conditions that cause the need for protection.

(iii) Describe the relationship between the design limits/parameters being protected and the parameters sensed or calculated as surrogates for those design limits/parameters, if applicable.

(iv) Describe how the modulation by the AEC prevents engines and/or vessels from exceeding design limits.

(v) Explain why it is necessary to estimate any parameters instead of measuring them directly and describe

how the AEC calculates the estimated value, if applicable.

(vi) Describe how you calibrate the AEC modulation to activate only during conditions related to the stated need to protect components and only as needed to sufficiently protect those components in a way that minimizes the emission impact.

(c) If your engines are equipped with an engine diagnostic system, explain how it works, describing especially the engine conditions (with the corresponding diagnostic trouble codes) that cause the malfunction-indicator light to go on.

(d) Describe the engines you selected for testing and the reasons for selecting them.

(e) Describe the test equipment and procedures that you used, including the duty cycle(s) and the corresponding engine applications. Also describe any special or alternate test procedures you used.

(f) Describe how you operated the emission-data engine before testing, including the duty cycle and the number of engine operating hours used to stabilize emission levels. Explain why you selected the method of service accumulation. Describe any scheduled maintenance you did.

(g) List the specifications of the test fuel to show that it falls within the required ranges we specify in 40 CFR part 1065.

(h) Identify the engine family's useful life.

(i) Include the maintenance and warranty instructions you will give to the ultimate purchaser of each new engine (see §§ 1042.120 and 1042.125). Describe your plan for meeting warranty obligations under §§ 1042.120.

(j) Include the emission-related installation instructions you will provide if someone else installs your engines in a vessel (see § 1042.130).

(k) Describe your emission control information label (see § 1042.135).

(l) Identify the emission standards and/or FELs to which you are certifying engines in the engine family.

(m) Identify the engine family's deterioration factors and describe how you developed them (see § 1042.245). Present any emission test data you used for this.

(n) State that you operated your emission-data engines as described in the application (including the test procedures, test parameters, and test fuels) to show you meet the requirements of this part.

(o) Present emission data for HC, NO_x, PM, and CO on an emission-data engine to show your engines meet emission standards as specified in

§ 1042.101. Show emission figures before and after applying adjustment factors for regeneration and deterioration factors for each pollutant and for each engine. If we specify more than one grade of any fuel type (for example, high-sulfur and low-sulfur diesel fuel), you need to submit test data only for one grade, unless the regulations of this part specify otherwise for your engine.

Include emission results for each mode if you do discrete-mode testing under § 1042.505. Note that §§ 1042.235 and 1042.245 allows you to submit an application in certain cases without new emission data.

(p) For Category 1 and Category 2 engines, state that all the engines in the engine family comply with the applicable not-to-exceed emission standards in § 1042.101 for all normal operation and use when tested as specified in § 1042.515. Describe any relevant testing, engineering analysis, or other information in sufficient detail to support your statement.

(q) [Reserved]

(r) Report all test results, including those from invalid tests, whether or not they were conducted according to the test procedures of subpart F of this part. If you measure CO₂, report those emission levels (in g/kW-hr). We may ask you to send other information to confirm that your tests were valid under the requirements of this part and 40 CFR part 1065.

(s) Describe all adjustable operating parameters (see § 1042.115(d)), including production tolerances. Include the following in your description of each parameter:

(1) The nominal or recommended setting.

(2) The intended physically adjustable range.

(3) The limits or stops used to establish adjustable ranges.

(4) For Category 1 engines, information showing why the limits, stops, or other means of inhibiting adjustment are effective in preventing adjustment of parameters on in-use engines to settings outside your intended physically adjustable ranges.

(5) For Category 2 engines, propose a range of adjustment for each adjustable parameter, as described in § 1042.115(d). Include information showing why the limits, stops, or other means of inhibiting adjustment are effective in preventing adjustment of parameters on in-use engines to settings outside your proposed adjustable ranges.

(t) Provide the information to read, record, and interpret all the information broadcast by an engine's onboard

computers and electronic control units. State that, upon request, you will give us any hardware, software, or tools we would need to do this. If you broadcast a surrogate parameter for torque values, you must provide us what we need to convert these into torque units. You may reference any appropriate publicly released standards that define conventions for these messages and parameters. Format your information consistent with publicly released standards.

(u) Confirm that your emission-related installation instructions specify how to ensure that sampling of exhaust emissions will be possible after engines are installed in vessels and placed in service. Show how to sample exhaust emissions in a way that prevents diluting the exhaust sample with ambient air.

(v) State whether your certification is limited for certain engines. If this is the case, describe how you will prevent use of these engines in applications for which they are not certified. This applies for engines such as the following:

(1) Constant-speed engines.

(2) Engines used with controllable-pitch propellers.

(3) Recreational engines.

(w) Unconditionally certify that all the engines in the engine family comply with the requirements of this part, other referenced parts of the CFR, and the Clean Air Act.

(x) Include good-faith estimates of U.S.-directed production volumes. Include a justification for the estimated production volumes if they are substantially different than actual production volumes in earlier years for similar models.

(y) Include the information required by other subparts of this part. For example, include the information required by § 1042.725 if you participate in the ABT program.

(z) Include other applicable information, such as information specified in this part or 40 CFR part 1068 related to requests for exemptions.

(aa) Name an agent for service located in the United States. Service on this agent constitutes service on you or any of your officers or employees for any action by EPA or otherwise by the United States related to the requirements of this part.

(bb) The following provisions apply for imported engines:

(1) Describe your normal practice for importing engines. For example, this may include identifying the names and addresses of any agents you have authorized to import your engines. Engines imported by nonauthorized

agents are not covered by your certificate.

(2) For engines below 560 kW, identify a test facility in the United States where you can test your engines if we select them for testing under a selective enforcement audit, as specified in 40 CFR part 1068.

§ 1042.210 Preliminary approval.

If you send us information before you finish the application, we will review it and make any appropriate determinations, especially for questions related to engine family definitions, auxiliary emission control devices, deterioration factors, useful life, testing for service accumulation, maintenance, and compliance with not-to-exceed standards. See § 1042.245 for specific provisions that apply for deterioration factors. Decisions made under this section are considered to be preliminary approval, subject to final review and approval. We will generally not reverse a decision where we have given you preliminary approval, unless we find new information supporting a different decision. If you request preliminary approval related to the upcoming model year or the model year after that, we will make best-efforts to make the appropriate determinations as soon as practicable. We will generally not provide preliminary approval related to a future model year more than two years ahead of time.

§ 1042.220 Amending maintenance instructions.

You may amend your emission-related maintenance instructions after you submit your application for certification, as long as the amended instructions remain consistent with the provisions of § 1042.125. You must send the Designated Compliance Officer a written request to amend your application for certification for an engine family if you want to change the emission-related maintenance instructions in a way that could affect emissions. In your request, describe the proposed changes to the maintenance instructions. We will approve your request if we determine that the amended instructions are consistent with maintenance you performed on emission-data engines such that your durability demonstration would remain valid. If operators follow the original maintenance instructions rather than the newly specified maintenance, this does not allow you to disqualify those engines from in-use testing or deny a warranty claim.

(a) If you are decreasing, replacing, or eliminating or any specified maintenance, you may distribute the

new maintenance instructions to your customers 30 days after we receive your request, unless we disapprove your request. We may approve a shorter time or waive this requirement.

(b) If your requested change would not decrease the specified maintenance, you may distribute the new maintenance instructions anytime after you send your request. For example, this paragraph (b) would cover adding instructions to increase the frequency of a maintenance step for engines in severe-duty applications.

(c) You do not need to request approval if you are making only minor corrections (such as correcting typographical mistakes), clarifying your maintenance instructions, or changing instructions for maintenance unrelated to emission control.

§ 1042.225 Amending applications for certification.

Before we issue you a certificate of conformity, you may amend your application to include new or modified engine configurations, subject to the provisions of this section. After we have issued your certificate of conformity, you may send us an amended application requesting that we include new or modified engine configurations within the scope of the certificate, subject to the provisions of this section. You must amend your application if any changes occur with respect to any information included in your application.

(a) You must amend your application before you take any of the following actions:

(1) Add an engine configuration to an engine family. In this case, the engine configuration added must be consistent with other engine configurations in the engine family with respect to the criteria listed in § 1042.230.

(2) Change an engine configuration already included in an engine family in a way that may affect emissions, or change any of the components you described in your application for certification. This includes production and design changes that may affect emissions any time during the engine's lifetime.

(3) Modify an FEL for an engine family as described in paragraph (f) of this section.

(b) To amend your application for certification as specified in paragraph (a) of this section, send the Designated Compliance Officer the following information:

(1) Describe in detail the addition or change in the engine model or configuration you intend to make.

(2) Include engineering evaluations or data showing that the amended engine family complies with all applicable requirements. You may do this by showing that the original emission-data engine is still appropriate with respect to showing compliance of the amended family with all applicable requirements.

(3) If the original emission-data engine for the engine family is not appropriate to show compliance for the new or modified engine configuration, include new test data showing that the new or modified engine configuration meets the requirements of this part.

(c) We may ask for more test data or engineering evaluations. You must give us these within 30 days after we request them.

(d) For engine families already covered by a certificate of conformity, we will determine whether the existing certificate of conformity covers your newly added or modified engine. You may ask for a hearing if we deny your request (see § 1042.920).

(e) For engine families already covered by a certificate of conformity, you may start producing the new or modified engine configuration anytime after you send us your amended application and before we make a decision under paragraph (d) of this section. However, if we determine that the affected engines do not meet applicable requirements, we will notify you to cease production of the engines and may require you to recall the engines at no expense to the owner. Choosing to produce engines under this paragraph (e) is deemed to be consent to recall all engines that we determine do not meet applicable emission standards or other requirements and to remedy the nonconformity at no expense to the owner. If you do not provide information required under paragraph (c) of this section within 30 days, you must stop producing the new or modified engines.

(f) You may ask us to approve a change to your FEL in certain cases after the start of production. The changed FEL may not apply to engines you have already introduced into U.S. commerce, except as described in this paragraph (f). If we approve a changed FEL after the start of production, you must include the new FEL on the emission control information label for all engines produced after the change. You may ask us to approve a change to your FEL in the following cases:

(1) You may ask to raise your FEL for your emission family at any time. In your request, you must show that you will still be able to meet the emission standards as specified in subparts B and H of this part. If you amend your

application by submitting new test data to include a newly added or modified engine or fuel-system component, as described in paragraph (b)(3) of this section, use the appropriate FELs with corresponding production volumes to calculate your production-weighted average FEL for the model year, as described in subpart H of this part. If you amend your application without submitting new test data, you must use the higher FEL for the entire family to calculate your production-weighted average FEL under subpart H of this part.

(2) You may ask to lower the FEL for your emission family only if you have test data from production engines showing that emissions are below the proposed lower FEL. The lower FEL applies only to engines you produce after we approve the new FEL. Use the appropriate FELs with corresponding production volumes to calculate your production-weighted average FEL for the model year, as described in subpart H of this part.

§ 1042.230 Engine families.

(a) For purposes of certification, divide your product line into families of engines that are expected to have similar emission characteristics throughout the useful life as described in this section. You may not group Category 1 and Category 2 engines in the same family. Your engine family is limited to a single model year.

(b) For Category 1 engines, group engines in the same engine family if they are the same in all the following aspects:

(1) The combustion cycle and the fuel with which the engine is intended or designed to be operated.

(2) The cooling system (for example, raw-water vs. separate-circuit cooling).

(3) Method of air aspiration.

(4) Method of exhaust aftertreatment (for example, catalytic converter or particulate trap).

(5) Combustion chamber design.

(6) Nominal bore and stroke.

(7) Number of cylinders (for engines with aftertreatment devices only).

(8) Cylinder arrangement (for engines with aftertreatment devices only).

(9) Method of control for engine operation other than governing (i.e., mechanical or electronic).

(10) Application (commercial or recreational).

(11) Numerical level of the emission standards that apply to the engine, except as allowed under paragraphs (f) and (g) of this section.

(c) For Category 2 engines, group engines in the same engine family if they are the same in all the following aspects:

(1) The combustion cycle (e.g., diesel cycle).

(2) The fuel with which the engine is intended or designed to be operated and the fuel system configuration.

(3) The cooling system (for example, air-cooled or water-cooled), and procedure(s) employed to maintain engine temperature within desired limits (thermostat, on-off radiator fans, radiator shutters, etc.).

(4) The method of air aspiration (turbocharged, supercharged, naturally aspirated, Roots blown).

(5) The turbocharger or supercharger general performance characteristics (e.g., approximate boost pressure, approximate response time, approximate size relative to engine displacement).

(6) The type of air inlet cooler (air-to-air, air-to-liquid, approximate degree to which inlet air is cooled).

(7) The type of exhaust aftertreatment system (oxidation catalyst, particulate trap), and characteristics of the aftertreatment system (catalyst loading, converter size vs. engine size).

(8) The combustion chamber configuration and the surface-to-volume ratio of the combustion chamber when the piston is at top dead center position, using nominal combustion chamber dimensions.

(9) Nominal bore and stroke dimensions.

(10) The location of the piston rings on the piston.

(11) The intake manifold induction port size and configuration.

(12) The exhaust manifold port size and configuration.

(13) The location of the intake and exhaust valves (or ports).

(14) The size of the intake and exhaust valves (or ports).

(15) The approximate intake and exhaust event timing and duration (valve or port).

(16) The configuration of the fuel injectors and approximate injection pressure.

(17) The type of fuel injection system controls (i.e., mechanical or electronic).

(18) The overall injection timing characteristics, or as appropriate ignition timing characteristics (i.e., the deviation of the timing curves from the optimal fuel economy timing curve must be similar in degree).

(19) The type of smoke control system.

(d) [Reserved]

(e) You may subdivide a group of engines that is identical under paragraph (b) or (c) of this section into different engine families if you show the expected emission characteristics are different during the useful life.

However, for the purpose of applying small-volume family provisions of this part, we will consider the otherwise applicable engine family criteria of this section.

(f) You may group engines that are not identical with respect to the things listed in paragraph (b) or (c) of this section in the same engine family, as follows:

(1) In unusual circumstances, you may group such engines in the same engine family if you show that their emission characteristics during the useful life will be similar.

(2) If you are a small-volume engine manufacturer, you may group any Category 1 engines into a single engine family or you may group any Category 2 engines into a single engine family. This also applies if you are a post-manufacture marinizer modifying a base engine that has a valid certificate of conformity for any kind of nonroad or heavy-duty highway engine under this chapter.

(3) The provisions of this paragraph (f) do not exempt any engines from meeting the standards and requirements in subpart B of this part.

(g) If you combine engines that are subject to different emission standards into a single engine family under paragraph (f) of this section, you must certify the engine family to the more stringent set of standards for that model year.

§ 1042.235 Emission testing required for a certificate of conformity.

This section describes the emission testing you must perform to show compliance with the emission standards in § 1042.101(a). See § 1042.205(p) regarding emission testing related to the NTE standards. See §§ 1042.240 and 1042.245 and 40 CFR part 1065, subpart E, regarding service accumulation before emission testing.

(a) Select an emission-data engine from each engine family for testing. For engines at or above 560 kW, you may use a development engine that is equivalent in design to the engine being certified. Using good engineering judgment, select the engine configuration most likely to exceed an applicable emission standard over the useful life, considering all exhaust emission constituents and the range of installation options available to vessel manufacturers.

(b) Test your emission-data engines using the procedures and equipment specified in subpart F of this part.

(c) We may measure emissions from any of your test engines or other engines from the engine family, as follows:

(1) We may decide to do the testing at your plant or any other facility. If we do this, you must deliver the test engine to a test facility we designate. The test engine you provide must include appropriate manifolds, aftertreatment devices, electronic control units, and other emission-related components not normally attached directly to the engine block. If we do the testing at your plant, you must schedule it as soon as possible and make available the instruments, personnel, and equipment we need.

(2) If we measure emissions from one of your test engines, the results of that testing become the official emission results for the engine. Unless we later invalidate these data, we may decide not to consider your data in determining if your engine family meets applicable requirements.

(3) Before we test one of your engines, we may set its adjustable parameters to any point within the specified adjustable ranges (see § 1042.115(d)).

(4) Before we test one of your engines, we may calibrate it within normal production tolerances for anything we do not consider an adjustable parameter.

(d) You may ask to use emission data from a previous model year instead of doing new tests, but only if all the following are true:

(1) The engine family from the previous model year differs from the current engine family only with respect to model year or other characteristics unrelated to emissions. You may also ask to add a configuration subject to § 1042.225.

(2) The emission-data engine from the previous model year remains the appropriate emission-data engine under paragraph (b) of this section.

(3) The data show that the emission-data engine would meet all the requirements that apply to the engine family covered by the application for certification. For engines originally tested under the provisions of 40 CFR part 94, you may consider those test procedures to be equivalent to the procedures we specify in subpart F of this part.

(e) We may require you to test a second engine of the same or different configuration in addition to the engine tested under paragraph (b) of this section.

(f) If you use an alternate test procedure under 40 CFR 1065.10 and later testing shows that such testing does not produce results that are equivalent to the procedures specified in subpart F of this part, we may reject data you generated using the alternate procedure.

§ 1042.240 Demonstrating compliance with exhaust emission standards.

(a) For purposes of certification, your engine family is considered in compliance with the emission standards in § 1042.101(a) if all emission-data engines representing that family have test results showing deteriorated emission levels at or below these standards. Note that your FELs are considered to be the applicable emission standards with which you must comply if you participate in the ABT program in subpart H of this part.

(b) Your engine family is deemed not to comply if any emission-data engine representing that family has test results showing a deteriorated emission level above an applicable emission standard for any pollutant.

(c) To compare emission levels from the emission-data engine with the applicable emission standards for Category 1 and Category 2 engines, apply deterioration factors to the measured emission levels for each pollutant. Section 1042.245 specifies how to test your engine to develop deterioration factors that represent the deterioration expected in emissions over your engines' full useful life. Your deterioration factors must take into account any available data from in-use testing with similar engines. Small-volume engine manufacturers and post-manufacture marinizers may use assigned deterioration factors that we establish. Apply deterioration factors as follows:

(1) *Additive deterioration factor for exhaust emissions.* Except as specified in paragraph (c)(2) of this section, use an additive deterioration factor for exhaust emissions. An additive deterioration factor is the difference between exhaust emissions at the end of the useful life and exhaust emissions at the low-hour test point. In these cases, adjust the official emission results for each tested engine at the selected test point by adding the factor to the measured emissions. If the deterioration factor is less than zero, use zero. Additive deterioration factors must be specified to one more decimal place than the applicable standard.

(2) *Multiplicative deterioration factor for exhaust emissions.* Use a multiplicative deterioration factor if good engineering judgment calls for the deterioration factor for a pollutant to be the ratio of exhaust emissions at the end of the useful life to exhaust emissions at the low-hour test point. For example, if you use aftertreatment technology that controls emissions of a pollutant proportionally to engine-out emissions, it is often appropriate to use a multiplicative deterioration factor.

Adjust the official emission results for each tested engine at the selected test point by multiplying the measured emissions by the deterioration factor. If the deterioration factor is less than one, use one. A multiplicative deterioration factor may not be appropriate in cases where testing variability is significantly greater than engine-to-engine variability. Multiplicative deterioration factors must be specified to one more significant figure than the applicable standard.

(3) *Deterioration factor for crankcase emissions.* If your engine vents crankcase emissions to the exhaust or to the atmosphere, you must account for crankcase emission deterioration, using good engineering judgment. You may use separate deterioration factors for crankcase emissions of each pollutant (either multiplicative or additive) or include the effects in combined deterioration factors that include exhaust and crankcase emissions together for each pollutant.

(d) Collect emission data using measurements to one more decimal place than the applicable standard. Apply the deterioration factor to the official emission result, as described in paragraph (c) of this section, then round the adjusted figure to the same number of decimal places as the emission standard. Compare the rounded emission levels to the emission standard for each emission-data engine. In the case of NO_x+HC standards, apply the deterioration factor to each pollutant and then add the results before rounding.

§ 1042.245 Deterioration factors.

For Category 1 and Category 2 engines, establish deterioration factors, as described in § 1042.240, to determine whether your engines will meet emission standards for each pollutant throughout the useful life. This section describes how to determine deterioration factors, either with an engineering analysis, with pre-existing test data, or with new emission measurements.

(a) You may ask us to approve deterioration factors for an engine family with established technology based on engineering analysis instead of testing. Engines certified to a NO_x+HC standard or FEL greater than the Tier 3 NO_x+HC standard are considered to rely on established technology for gaseous emission control, except that this does not include any engines that use exhaust-gas recirculation or aftertreatment. In most cases, technologies used to meet the Tier 1 and Tier 2 emission standards would be considered to be established technology. We must approve your plan to establish

a deterioration factor under this paragraph (a) before you submit your application for certification.

(b) You may ask us to approve deterioration factors for an engine family based on emission measurements from similar highway, stationary, or nonroad engines (including locomotive engines or other marine engines) if you have already given us these data for certifying the other engines in the same or earlier model years. Use good engineering judgment to decide whether the two engines are similar. We must approve your plan to establish a deterioration factor under this paragraph (b) before you submit your application for certification. We will approve your request if you show us that the emission measurements from other engines reasonably represent in-use deterioration for the engine family for which you have not yet determined deterioration factors.

(c) If you are unable to determine deterioration factors for an engine family under paragraph (a) or (b) of this section, first get us to approve a plan for determining deterioration factors based on service accumulation and related testing. We will respond to your proposed plan within 45 days of receiving your request. Your plan must involve measuring emissions from an emission-data engine at least three times, which are evenly spaced over the service-accumulation period unless we specify otherwise, such that the resulting measurements and calculations will represent the deterioration expected from in-use engines over the full useful life. You may use extrapolation to determine deterioration factors once you have established a trend of changing emissions with age for each pollutant. You may use an engine installed in a vessel to accumulate service hours instead of running the engine only in the laboratory. You may perform maintenance on emission-data engines as described in § 1042.125 and 40 CFR part 1065, subpart E.

(d) Include the following information in your application for certification:

(1) If you determine your deterioration factors based on test data from a different engine family, explain why this is appropriate and include all the emission measurements on which you base the deterioration factor.

(2) If you determine your deterioration factors based on engineering analysis, explain why this is appropriate and include a statement that all data, analyses, evaluations, and other information you used are available for our review upon request.

(3) If you do testing to determine deterioration factors, describe the form and extent of service accumulation, including a rationale for selecting the service-accumulation period and the method you use to accumulate hours.

§ 1042.250 Recordkeeping and reporting.

(a) If you produce engines under any provisions of this part that are related to production volumes, send the Designated Compliance Officer a report within 30 days after the end of the model year describing the total number of engines you produced in each engine family. For example, if you use special provisions intended for small-volume engine manufacturers, report your U.S.-directed production volumes to show that you do not exceed the applicable limits.

(b) Organize and maintain the following records:

(1) A copy of all applications and any summary information you send us.

(2) Any of the information we specify in § 1042.205 that you were not required to include in your application.

(3) A detailed history of each emission-data engine. For each engine, describe all of the following:

(i) The emission-data engine's construction, including its origin and buildup, steps you took to ensure that it represents production engines, any components you built specially for it, and all the components you include in your application for certification.

(ii) How you accumulated engine operating hours (service accumulation), including the dates and the number of hours accumulated.

(iii) All maintenance, including modifications, parts changes, and other service, and the dates and reasons for the maintenance.

(iv) All your emission tests (valid and invalid), including documentation on routine and standard tests, as specified in part 40 CFR part 1065, and the date and purpose of each test.

(v) All tests to diagnose engine or emission control performance, giving the date and time of each and the reasons for the test.

(vi) Any other significant events.

(4) Production figures for each engine family divided by assembly plant.

(5) Keep a list of engine identification numbers for all the engines you produce under each certificate of conformity.

(c) Keep data from routine emission tests (such as test cell temperatures and relative humidity readings) for one year after we issue the associated certificate of conformity. Keep all other information specified in paragraph (a) of this section for eight years after we issue your certificate.

(d) Store these records in any format and on any media, as long as you can promptly send us organized, written records in English if we ask for them. You must keep these records readily available. We may review them at any time.

(e) Send us copies of any engine maintenance instructions or explanations if we ask for them.

§ 1042.255 EPA decisions.

(a) If we determine your application is complete and shows that the engine family meets all the requirements of this part and the Clean Air Act, we will issue a certificate of conformity for your engine family for that model year. We may make the approval subject to additional conditions.

(b) We may deny your application for certification if we determine that your engine family fails to comply with emission standards or other requirements of this part or the Clean Air Act. Our decision may be based on a review of all information available to us. If we deny your application, we will explain why in writing.

(c) In addition, we may deny your application or suspend or revoke your certificate if you do any of the following:

(1) Refuse to comply with any testing or reporting requirements.

(2) Submit false or incomplete information (paragraph (e) of this section applies if this is fraudulent).

(3) Render inaccurate any test data.

(4) Deny us from completing authorized activities (see 40 CFR 1068.20). This includes a failure to provide reasonable assistance.

(5) Produce engines for importation into the United States at a location where local law prohibits us from carrying out authorized activities.

(6) Fail to supply requested information or amend your application to include all engines being produced.

(7) Take any action that otherwise circumvents the intent of the Clean Air Act or this part.

(d) We may void your certificate if you do not keep the records we require or do not give us information as required under this part or the Clean Air Act.

(e) We may void your certificate if we find that you intentionally submitted false or incomplete information.

(f) If we deny your application or suspend, revoke, or void your certificate, you may ask for a hearing (see § 1042.920).

Subpart D—Testing Production-line Engines

§ 1042.301 General provisions.

(a) If you produce engines that are subject to the requirements of this part, you must test them as described in this subpart, except as follows:

(1) Small-volume engine manufacturers may omit testing under this subpart.

(2) We may exempt Category 1 engine families with a projected U.S.-directed production volume below 100 engines from routine testing under this subpart. Request this exemption in your application for certification and include your basis for projecting a production volume below 100 units. You must promptly notify us if your actual production exceeds 100 units during the model year. If you exceed the production limit or if there is evidence of a nonconformity, we may require you to test production-line engines under this subpart, or under 40 CFR part 1068, subpart D, even if we have approved an exemption under this paragraph (a)(2).

(3) [Reserved]

(b) We may suspend or revoke your certificate of conformity for certain engine families if your production-line engines do not meet the requirements of this part or you do not fulfill your obligations under this subpart (see §§ 1042.325 and 1042.340).

(c) Other requirements apply to engines that you produce. Other regulatory provisions authorize us to suspend, revoke, or void your certificate of conformity, or order recalls for engine families without regard to whether they have passed these production-line testing requirements. The requirements of this subpart do not affect our ability to do selective enforcement audits, as described in 40 CFR part 1068.

Individual engines in families that pass these production-line testing requirements must also conform to all applicable regulations of this part and 40 CFR part 1068.

(d) You may use alternate programs or measurement methods for testing production-line engines in the following circumstances:

(1) [Reserved]

(2) You may test your engines using the CumSum procedures specified in 40 CFR part 1045 or 1051 instead of the procedures specified in this subpart, except that the threshold for establishing quarterly or annual test periods is based on U.S.-directed production volumes of 800 instead of 1600. This alternate program does not require prior approval.

(3) You may ask to use another alternate program or measurement

method for testing production-line engines. In your request, you must show us that the alternate program gives equal assurance that your engines meet the requirements of this part. We may waive some or all of this subpart's requirements if we approve your alternate program.

(e) If you certify an engine family with carryover emission data, as described in § 1042.235(d), and these equivalent engine families consistently pass the production-line testing requirements over the preceding two-year period, you may ask for a reduced testing rate for further production-line testing for that family. The minimum testing rate is one engine per engine family. If we reduce your testing rate, we may limit our approval to any number of model years. In determining whether to approve your request, we may consider the number of engines that have failed the emission tests.

(f) We may ask you to make a reasonable number of production-line engines available for a reasonable time so we can test or inspect them for compliance with the requirements of this part. See 40 CFR 1068.27.

§ 1042.305 Preparing and testing production-line engines.

This section describes how to prepare and test production-line engines. You must assemble the test engine in a way that represents the assembly procedures for other engines in the engine family. You must ask us to approve any deviations from your normal assembly procedures for other production engines in the engine family.

(a) *Test procedures.* Test your production-line engines using the applicable testing procedures in subpart F of this part to show you meet the duty-cycle emission standards in subpart B of this part. The not-to-exceed standards apply for this testing, but you need not do additional testing to show that production-line engines meet the not-to-exceed standards.

(b) *Modifying a test engine.* Once an engine is selected for testing (see § 1042.310), you may adjust, repair, prepare, or modify it or check its emissions only if one of the following is true:

(1) You document the need for doing so in your procedures for assembling and inspecting all your production engines and make the action routine for all the engines in the engine family.

(2) This subpart otherwise specifically allows your action.

(3) We approve your action in advance.

(c) *Engine malfunction.* If an engine malfunction prevents further emission

testing, ask us to approve your decision to either repair the engine or delete it from the test sequence.

(d) *Setting adjustable parameters.* Before any test, we may require you to adjust any adjustable parameter on a Category 1 engine to any setting within its physically adjustable range. We may adjust or require you to adjust any adjustable parameter on a Category 2 engine to any setting within its specified adjustable range.

(1) We may require you to adjust idle speed outside the physically adjustable range as needed, but only until the engine has stabilized emission levels (see paragraph (e) of this section). We may ask you for information needed to establish an alternate minimum idle speed.

(2) We may specify adjustments within the physically adjustable range or the specified adjustable range by considering their effect on emission levels, as well as how likely it is someone will make such an adjustment with in-use engines.

(e) *Stabilizing emission levels.* You may stabilize emission levels (or establish a Green Engine Factor for Category 2 engines) before you test production-line engines, as follows:

(1) You may stabilize emission levels by operating the engine in a way that represents the way production engines will be used, using good engineering judgment, for no more than the greater of two periods:

(i) 300 hours.

(ii) The number of hours you operated your emission-data engine for certifying the engine family (see 40 CFR part 1065, subpart E, or the applicable regulations governing how you should prepare your test engine).

(2) For Category 2 engines, you may ask us to approve a Green Engine Factor for each regulated pollutant for each engine family. Use the Green Engine Factor to adjust measured emission levels to establish a stabilized low-hour emission level.

(f) *Damage during shipment.* If shipping an engine to a remote facility for production-line testing makes necessary an adjustment or repair, you must wait until after the initial emission test to do this work. We may waive this requirement if the test would be impossible or unsafe, or if it would permanently damage the engine. Report to us in your written report under § 1042.345 all adjustments or repairs you make on test engines before each test.

(g) *Retesting after invalid tests.* You may retest an engine if you determine an emission test is invalid under subpart F of this part. Explain in your

written report reasons for invalidating any test and the emission results from all tests. If you retest an engine, you may ask us to substitute results of the new tests for the original ones. You must ask us within ten days of testing. We will generally answer within ten days after we receive your information.

§ 1042.310 Engine selection.

(a) Determine minimum sample sizes as follows:

(1) For Category 1 engines, the minimum sample size is one engine or one percent of the projected U.S.-directed production volume for all your Category 1 engine families, whichever is greater.

(2) For Category 2 engines, the minimum sample size is one engine or one percent of the projected U.S.-directed production volume for all your Category 2 engine families, whichever is greater.

(b) Randomly select one engine from each engine family early in the model year. For further testing to reach the minimum sample size, randomly select a proportional sample from each engine family, with testing distributed evenly over the course of the model year, unless we specify a different schedule for your tests. For example, we may require you to disproportionately select engines from the early part of a model year for a new engine model that has not previously been subject to production-line testing.

(c) For each engine that fails to meet emission standards, test two engines from the same engine family from the next fifteen engines produced or within seven days, whichever is later. If an engine fails to meet emission standards for any pollutant, count it as a failing engine under this paragraph (c).

(d) Continue testing until one of the following things happens:

(1) You test the number of engines specified in paragraphs (a) and (c) of this section.

(2) The engine family does not comply according to § 1042.315 or you choose to declare that the engine family does not comply with the requirements of this subpart.

(3) You test 30 engines from the engine family.

(e) You may elect to test more randomly chosen engines than we require under this section.

§ 1042.315 Determining compliance.

This section describes the pass-fail criteria for the production-line testing requirements. We apply these criteria on an engine-family basis. See § 1042.320 for the requirements that apply to individual engines that fail a production-line test.

(a) Calculate your test results as follows:

(1) *Initial and final test results.*

Calculate the test results for each engine. If you do several tests on an engine, calculate the initial test results, then add them together and divide by the number of tests for the final test results on that engine. Include the Green Engine Factor to determine low-hour emission results, if applicable.

(2) *Final deteriorated test results.*

Apply the deterioration factor for the engine family to the final test results (see § 1042.240(c)).

(3) *Round deteriorated test results.*

Round the results to one more decimal place than the applicable emission standard.

(b) If a production-line engine fails to meet emission standards and you test two additional engines as described in § 1042.310, calculate the average emission level for each pollutant for the three engines. If the calculated average emission level for any pollutant exceeds the applicable emission standard, the engine family fails the production-line testing requirements of this subpart. Tell us within ten working days if this happens. You may request to amend the application for certification to raise the FEL of the engine family as described in § 1042.225(f).

§ 1042.320 What happens if one of my production-line engines fails to meet emission standards?

(a) If you have a production-line engine with final deteriorated test results exceeding one or more emission standards (see § 1042.315(a)), the certificate of conformity is automatically suspended for that failing engine. You must take the following actions before your certificate of conformity can cover that engine:

(1) Correct the problem and retest the engine to show it complies with all emission standards.

(2) Include in your written report a description of the test results and the remedy for each engine (see § 1042.345).

(b) You may request to amend the application for certification to raise the FEL of the entire engine family at this point (see § 1042.225).

(c) For catalyst-equipped engines, you may ask us to allow you to exclude an initial failed test if all of the following are true:

(1) The catalyst was in a green condition when tested initially.

(2) The engine met all emission standards when retested after degreening the catalyst.

(3) No additional emission-related maintenance or repair was performed between the initial failed test and the subsequent passing test.

§ 1042.325 What happens if an engine family fails the production-line testing requirements?

(a) We may suspend your certificate of conformity for an engine family if it fails under § 1042.315. The suspension may apply to all facilities producing engines from an engine family, even if you find noncompliant engines only at one facility.

(b) We will tell you in writing if we suspend your certificate in whole or in part. We will not suspend a certificate until at least 15 days after the engine family fails. The suspension is effective when you receive our notice.

(c) Up to 15 days after we suspend the certificate for an engine family, you may ask for a hearing (see § 1042.920). If we agree before a hearing occurs that we used erroneous information in deciding to suspend the certificate, we will reinstate the certificate.

(d) Section 1042.335 specifies steps you must take to remedy the cause of the engine family's production-line failure. All the engines you have produced since the end of the last test period are presumed noncompliant and should be addressed in your proposed remedy. We may require you to apply the remedy to engines produced earlier if we determine that the cause of the failure is likely to have affected the earlier engines.

(e) You may request to amend the application for certification to raise the FEL of the entire engine family as described in § 1051.225(f). We will approve your request if it is clear that you used good engineering judgment in establishing the original FEL.

§ 1042.330 Selling engines from an engine family with a suspended certificate of conformity.

You may sell engines that you produce after we suspend the engine family's certificate of conformity under § 1042.315 only if one of the following occurs:

(a) You test each engine you produce and show it complies with emission standards that apply.

(b) We conditionally reinstate the certificate for the engine family. We may do so if you agree to recall all the affected engines and remedy any noncompliance at no expense to the owner if later testing shows that the engine family still does not comply.

§ 1042.335 Reinstating suspended certificates.

(a) Send us a written report asking us to reinstate your suspended certificate. In your report, identify the reason for noncompliance, propose a remedy for the engine family, and commit to a date

for carrying it out. In your proposed remedy include any quality control measures you propose to keep the problem from happening again.

(b) Give us data from production-line testing that shows the remedied engine family complies with all the emission standards that apply.

§ 1042.340 When may EPA revoke my certificate under this subpart and how may I sell these engines again?

(a) We may revoke your certificate for an engine family in the following cases:

(1) You do not meet the reporting requirements.

(2) Your engine family fails to comply with the requirements of this subpart and your proposed remedy to address a suspended certificate under § 1042.325 is inadequate to solve the problem or requires you to change the engine's design or emission control system.

(b) To sell engines from an engine family with a revoked certificate of conformity, you must modify the engine family and then show it complies with the requirements of this part.

(1) If we determine your proposed design change may not control emissions for the engine's full useful life, we will tell you within five working days after receiving your report. In this case we will decide whether production-line testing will be enough for us to evaluate the change or whether you need to do more testing.

(2) Unless we require more testing, you may show compliance by testing production-line engines as described in this subpart.

(3) We will issue a new or updated certificate of conformity when you have met these requirements.

§ 1042.345 Reporting.

(a) Within 45 days of the end of each quarter in which production-line testing occurs, send us a report with the following information:

(1) Describe any facility used to test production-line engines and state its location.

(2) State the total U.S.-directed production volume and number of tests for each engine family.

(3) Describe how you randomly selected engines.

(4) Describe each test engine, including the engine family's identification and the engine's model year, build date, model number, identification number, and number of hours of operation before testing. Also describe how you developed and applied the Green Engine Factor, if applicable.

(5) Identify how you accumulated hours of operation on the engines and

describe the procedure and schedule you used.

(6) Provide the test number; the date, time and duration of testing; test procedure; initial test results before and after rounding; final test results; and final deteriorated test results for all tests. Provide the emission results for all measured pollutants. Include information for both valid and invalid tests and the reason for any invalidation.

(7) Describe completely and justify any nonroutine adjustment, modification, repair, preparation, maintenance, or test for the test engine if you did not report it separately under this subpart. Include the results of any emission measurements, regardless of the procedure or type of engine.

(8) Report on each failed engine as described in § 1042.320.

(9) Identify when the model year ends for each engine family.

(b) We may ask you to add information to your written report so we can determine whether your new engines conform with the requirements of this subpart.

(c) An authorized representative of your company must sign the following statement:

We submit this report under sections 208 and 213 of the Clean Air Act. Our production-line testing conformed completely with the requirements of 40 CFR part 1042. We have not changed production processes or quality-control procedures for test engines in a way that might affect emission controls. All the information in this report is true and accurate to the best of my knowledge. I know of the penalties for violating the Clean Air Act and the regulations. (Authorized Company Representative)

(d) Send electronic reports of production-line testing to the Designated Compliance Officer using an approved information format. If you want to use a different format, send us a written request with justification for a waiver.

(e) We will send copies of your reports to anyone from the public who asks for them. See § 1042.915 for information on how we treat information you consider confidential.

§ 1042.350 Recordkeeping.

(a) Organize and maintain your records as described in this section. We may review your records at any time.

(b) Keep records of your production-line testing for eight years after you complete all the testing required for an engine family in a model year. You may use any appropriate storage formats or media.

(c) Keep a copy of the written reports described in § 1042.345.

(d) Keep the following additional records:

(1) A description of all test equipment for each test cell that you can use to test production-line engines.

(2) The names of supervisors involved in each test.

(3) The name of anyone who authorizes adjusting, repairing, preparing, or modifying a test engine and the names of all supervisors who oversee this work.

(4) If you shipped the engine for testing, the date you shipped it, the associated storage or port facility, and the date the engine arrived at the testing facility.

(5) Any records related to your production-line tests that are not in the written report.

(6) A brief description of any significant events during testing not otherwise described in the written report or in this section.

(7) Any information specified in § 1042.345 that you do not include in your written reports.

(e) If we ask, you must give us projected or actual production figures for an engine family. We may ask you to divide your production figures by maximum engine power, displacement, fuel type, or assembly plant (if you produce engines at more than one plant).

(f) Keep a list of engine identification numbers for all the engines you produce under each certificate of conformity. Give us this list within 30 days if we ask for it.

(g) We may ask you to keep or send other information necessary to implement this subpart.

Subpart E—In-use Testing

§ 1042.401 General Provisions.

We may perform in-use testing of any engine subject to the standards of this part.

Subpart F—Test Procedures

§ 1042.501 How do I run a valid emission test?

(a) Use the equipment and procedures for compression-ignition engines in 40 CFR part 1065 to determine whether Category 1 and Category 2 engines meet the duty-cycle emission standards in § 1042.101(a). Measure the emissions of all regulated pollutants as specified in 40 CFR part 1065. Use the applicable duty cycles specified in § 1042.505.

(b) Section 1042.515 describes the supplemental test procedures for evaluating whether engines meet the

not-to-exceed emission standards in § 1042.101(c).

(c) Use the fuels and lubricants specified in 40 CFR part 1065, subpart H, for all the testing we require in this part, except as specified in § 1042.515.

(1) For service accumulation, use the test fuel or any commercially available fuel that is representative of the fuel that in-use engines will use.

(2) For diesel-fueled engines, use the appropriate diesel fuel specified in 40 CFR part 1065, subpart H, for emission testing. Unless we specify otherwise, the appropriate diesel test fuel is the ultra low-sulfur diesel fuel. If we allow you to use a test fuel with higher sulfur levels, identify the test fuel in your application for certification and ensure that the emission control information label is consistent with your selection of the test fuel (see § 1042.135(c)(11)). For Category 2 engines, you may ask to use commercially available diesel fuel similar but not necessarily identical to the applicable fuel specified in 40 CFR part 1065, subpart H; we will approve your request if you show us that it does not affect your ability to demonstrate compliance with the applicable emission standards.

(3) For Category 1 and Category 2 engines that are expected to use a type of fuel (or mixed fuel) other than diesel fuel (such as natural gas, methanol, or residual fuel), use a commercially available fuel of that type for emission testing. If an engine is designed to operate on different fuels, we may (at our discretion) require testing on each fuel. Propose test fuel specifications that take into account the engine design and the properties of commercially available fuels. Describe these test fuel specifications in the application for certification.

(4) [Reserved]

(d) You may use special or alternate procedures to the extent we allow them under 40 CFR 1065.10.

(e) This subpart is addressed to you as a manufacturer, but it applies equally to anyone who does testing for you, and to us when we perform testing to determine if your engines meet emission standards.

(f) Duty-cycle testing is limited to ambient temperatures of 20 to 30 °C. Atmospheric pressure must be between 91.000 and 103.325 kPa, and must be within ±5 percent of the value recorded at the time of the last engine map. Testing may be performed with any ambient humidity level. Correct duty-cycle NO_x emissions for humidity as specified in 40 CFR part 1065.

§ 1042.505 Testing engines using discrete-mode or ramped-modal duty cycles.

This section describes how to test engines under steady-state conditions. In some cases, we allow you to choose the appropriate steady-state duty cycle for an engine. In these cases, you must use the duty cycle you select in your application for certification for all testing you perform for that engine family. If we test your engines to confirm that they meet emission standards, we will use the duty cycles you select for your own testing. We may also perform other testing as allowed by the Clean Air Act.

(a) You may perform steady-state testing with either discrete-mode or ramped-modal cycles, as follows:

(1) For discrete-mode testing, sample emissions separately for each mode, then calculate an average emission level for the whole cycle using the weighting factors specified for each mode.

Calculate cycle statistics and compare with the established criteria as specified in 40 CFR 1065.514 to confirm that the test is valid. Operate the engine and sampling system as follows:

(i) *Engines with NO_x aftertreatment.* For engines that depend on aftertreatment to meet the NO_x emission standard, operate the engine for 5–6 minutes, then sample emissions for 1–3 minutes in each mode. You may extend the sampling time to improve measurement accuracy of PM emissions, using good engineering judgment. If you have a longer sampling time for PM emissions, calculate and validate cycle statistics separately for the gaseous and PM sampling periods.

(ii) *Engines without NO_x aftertreatment.* For other engines, operate the engine for at least 5 minutes, then sample emissions for at least 1 minute in each mode.

(2) For ramped-modal testing, start sampling at the beginning of the first mode and continue sampling until the end of the last mode. Calculate emissions and cycle statistics the same as for transient testing as specified in 40 CFR part 1065, subpart G.

(b) Measure emissions by testing the engine on a dynamometer with one of the following duty cycles (as specified) to determine whether it meets the emission standards in § 1042.101(a):

(1) *General cycle.* Use the 4-mode duty cycle or the corresponding ramped-modal cycle described in paragraph (a) of Appendix II of this part for commercial propulsion marine engines that are used with (or intended to be used with) fixed-pitch propellers, propeller-law auxiliary engines, and any other engines for which the other duty cycles of this section do not apply. Use

this duty cycle also for commercial variable-speed propulsion marine engines that are used with (or intended to be used with) controllable-pitch propellers or with electrically coupled propellers, unless these engines are not intended for sustained operation (e.g., for at least 30 minutes) at all four modes when installed in the vessel.

(2) *Recreational marine engines.* Except as specified in paragraph (b)(3) of this section, use the 5-mode duty cycle or the corresponding ramped-modal cycle described in paragraph (b) of Appendix II of this part for recreational marine engines with maximum engine power at or above 37 kW.

(3) *Controllable-pitch and electrically coupled propellers.* Use the 4-mode duty cycle or the corresponding ramped-modal cycle described in paragraph (c) of Appendix II of this part for constant-speed propulsion marine engines that are used with (or intended to be used with) controllable-pitch propellers or with electrically coupled propellers. Use this duty cycle also for variable-speed propulsion marine engines that are used with (or intended to be used with) controllable-pitch propellers or with electrically coupled propellers if the duty cycles in paragraph (b)(1) and (b)(2) of this section do not apply.

(4) *Constant-speed auxiliary engines.* Use the 5-mode duty cycle or the corresponding ramped-modal cycle described in 40 CFR part 1039, Appendix II, paragraph (a) for constant-speed auxiliary engines.

(5) *Variable-speed auxiliary engines.* (i) Use the duty cycle specified in paragraph (b)(1) of this section for propeller-law auxiliary engines.

(ii) Use the 6-mode duty cycle or the corresponding ramped-modal cycle described in 40 CFR part 1039, Appendix II, paragraph (b) for variable-speed auxiliary engines with maximum engine power below 19 kW that are not propeller-law engines.

(iii) Use the 8-mode duty cycle or the corresponding ramped-modal cycle described in 40 CFR part 1039, Appendix III, paragraph (c) for variable-speed auxiliary engines with maximum engine power at or above 19 kW that are not propeller-law engines.

(c) During idle mode, operate the engine at its warm idle speed as described in 40 CFR part 1065.

(d) For constant-speed engines whose design prevents full-load operation for extended periods, you may ask for approval under 40 CFR 1065.10(c) to replace full-load operation with the maximum load for which the engine is

designed to operate for extended periods.

(e) See 40 CFR part 1065 for detailed specifications of tolerances and calculations.

§ 1042.515 Test procedures related to not-to-exceed standards.

(a) This section describes the procedures to determine whether your engines meet the not-to-exceed emission standards in § 1042.101(c). These procedures may include any normal engine operation and ambient conditions that the engines may experience in use. Paragraphs (c) through (e) of this section define the limits of what we will consider normal engine operation and ambient conditions.

(b) Measure emissions with one of the following procedures:

(1) Remove the selected engines for testing in a laboratory. You may use an engine dynamometer to simulate normal operation, as described in this section. Use the equipment and procedures specified in 40 CFR part 1065 to conduct laboratory testing.

(2) Test the selected engines while they remain installed in a vessel. Use the equipment and procedures specified in 40 CFR part 1065 subpart J, to conduct field testing. Use fuel meeting the specifications of 40 CFR part 1065, subpart H, or a fuel typical of what you would expect the engine to use in service.

(c) Engine testing may occur under the following ranges of ambient conditions without correcting measured emission levels:

(1) Atmospheric pressure must be between 96.000 and 103.325 kPa, except that manufacturers may test at lower atmospheric pressures if their test facility is located at an altitude that makes it impractical to stay within this range. This pressure range is intended to allow testing under most weather conditions at all altitudes up to 1,100 feet above sea level.

(2) Ambient air temperature must be between 13 and 35 °C (or between 13 °C and 30 °C for engines not drawing intake air directly from a space that could be heated by the engine).

(3) Ambient water temperature must be between 5 and 27 °C.

(4) Ambient humidity must be between 7.1 and 10.7 grams of moisture per kilogram of dry air.

(d) Engine testing may occur at any conditions expected during normal operation but that are outside the conditions described in paragraph (b) of this section, as long as measured values are corrected to be equivalent to the nearest end of the specified range, using

good engineering judgment. Correct NO_x emissions for humidity as specified in 40 CFR part 1065, subpart G.

(e) The sampling period may not begin until the engine has reached stable operating temperatures. For example, this would include only engine operation after starting and after the engine thermostat starts modulating the engine's coolant temperature. The sampling period may not include engine starting.

(f) Apply the NTE standards specified in § 1042.101(c) to an engine family based on the zones and subzones corresponding to specific duty cycles and engine types as defined in Appendix III of this part. For an engine family certified to multiple duty cycles, the broadest applicable NTE zone applies for that family at the time of certification. Whenever an engine family is certified to multiple duty cycles and a specific engine from that family is tested for NTE compliance in use, determine the applicable NTE zone for that engine according to its in-use application. An engine family's NTE zone may be modified as follows:

(1) You may ask us to approve a narrower NTE zone for an engine family at the time of certification, based on information such as how that engine family is expected to normally operate in use. For example, if an engine family is always coupled to a pump or jet drive, the engine might be able to operate only within a narrow range of engine speed and power.

(2) You may ask us to approve a Limited Testing Region (LTR). An LTR is a region of engine operation, within the applicable NTE zone, where you have demonstrated that your engine family operates for no more than 5.0 percent of its normal in-use operation, on a time-weighted basis. You must specify an LTR using boundaries based on engine speed and power (or torque), where the LTR boundaries must coincide with some portion of the boundary defining the overall NTE zone. Any emission data collected within an LTR for a time duration that exceeds 5.0 percent of the duration of its respective NTE sampling period (as defined in paragraph (c)(3) of this section) will be excluded when determining compliance with the applicable NTE standards. Any emission data collected within an LTR for a time duration of 5.0 percent or less of the duration of the respective NTE sampling period will be included when determining compliance with the NTE standards.

(3) You must notify us if you design your engines for normal in-use

operation outside the applicable NTE zone. If we learn that normal in-use operation for your engines includes other speeds and loads, we may specify a broader NTE zone, as long as the modified zone is limited to normal in-use operation for speeds greater than 70 percent of maximum test speed and loads greater than 30 percent of maximum power at maximum test speed (or 30 percent of maximum test torque for constant-speed engines).

(4) You may exclude emission data based on ambient or engine parameter limit values as follows:

(i) *NO_x catalytic aftertreatment minimum temperature.* For an engine equipped with a catalytic NO_x aftertreatment system, exclude NO_x emission data that is collected when the exhaust temperature is less than 250 °C, as measured within 30 cm downstream of the last NO_x aftertreatment device. Where there are parallel paths, measure the temperature 30 cm downstream of the last NO_x aftertreatment device in the path with the greatest exhaust flow.

(ii) *Oxidizing aftertreatment minimum temperature.* For an engine equipped with an oxidizing catalytic aftertreatment system, exclude HC, CO, and PM emission data that is collected when the exhaust temperature is less than 250 °C, as measured within 30 cm downstream of the last oxidizing aftertreatment device. Where there are parallel paths, measure the temperature 30 cm downstream of the last oxidizing aftertreatment device in the path with the greatest exhaust flow.

(iii) *Other parameters.* You may request our approval for other minimum or maximum ambient or engine parameter limit values at the time of certification.

(g) For engines equipped with emission controls that include discrete regeneration events, if a regeneration event occurs during the NTE test, the averaging period must be at least as long as the time between the events multiplied by the number of full regeneration events within the sampling period. This requirement applies only for engines that send an electronic signal indicating the start of the regeneration event.

§ 1042.520 What testing must I perform to establish deterioration factors?

Sections 1042.240 and 1042.245 describe the required methods for testing to establish deterioration factors for an engine family.

§ 1042.525 How do I adjust emission levels to account for infrequently regenerating aftertreatment devices?

This section describes how to adjust emission results from engines using

aftertreatment technology with infrequent regeneration events. See paragraph (e) of this section for how to adjust ramped-modal testing. See paragraph (f) of this section for how to adjust discrete-mode testing. For this section, "regeneration" means an intended event during which emission levels change while the system restores aftertreatment performance. For example, exhaust gas temperatures may increase temporarily to remove sulfur from adsorbers or to oxidize accumulated particulate matter in a trap. For this section, "infrequent" refers to regeneration events that are expected to occur on average less than once over the applicable transient duty cycle or ramped-modal cycle, or on average less than once per typical mode in a discrete-mode test.

(a) *Developing adjustment factors.* Develop an upward adjustment factor and a downward adjustment factor for each pollutant based on measured emission data and observed regeneration frequency. Adjustment factors should generally apply to an entire engine family, but you may develop separate adjustment factors for different engine configurations within an engine family. If you use adjustment factors for certification, you must identify the frequency factor, F, from paragraph (b) of this section in your application for certification and use the adjustment factors in all testing for that engine family. You may use carryover or carry-across data to establish adjustment factors for an engine family, as described in § 1042.235(d), consistent with good engineering judgment. All adjustment factors for regeneration are additive. Determine adjustment factors separately for different test segments. For example, determine separate adjustment factors for different modes of a discrete-mode steady-state test. You may use either of the following different approaches for engines that use aftertreatment with infrequent regeneration events:

(1) You may disregard this section if regeneration does not significantly affect emission levels for an engine family (or configuration) or if it is not practical to identify when regeneration occurs. If you do not use adjustment factors under this section, your engines must meet emission standards for all testing, without regard to regeneration.

(2) If your engines use aftertreatment technology with extremely infrequent regeneration and you are unable to apply the provisions of this section, you may ask us to approve an alternate methodology to account for regeneration events.

(b) *Calculating average adjustment factors.* Calculate the average adjustment factor (EF_A) based on the following equation:

$$EF_A = (F)(EF_H) + (1 - F)(EF_L)$$

Where:

F = the frequency of the regeneration event during normal in-use operation, expressed in terms of the fraction of equivalent tests during which the regeneration occurs. You may determine F from in-use operating data or running replicate tests. For example, if you observe that the regeneration occurs 125 times during 1000 MW-hrs of operation, and your engine typically accumulates 1 MW-hr per test, F would be $(125) \div (1000) \div (1) = 0.125$.

EF_H = Measured emissions from a test segment in which the regeneration occurs.

EF_L = Measured emissions from a test segment in which the regeneration does not occur.

(c) *Applying adjustment factors.* Apply adjustment factors based on whether regeneration occurs during the test run. You must be able to identify regeneration in a way that is readily apparent during all testing.

(1) If regeneration does not occur during a test segment, add an upward adjustment factor to the measured emission rate. Determine the upward adjustment factor (UAF) using the following equation:

$$UAF = EF_A - EF_L$$

(2) If regeneration occurs or starts to occur during a test segment, subtract a downward adjustment factor from the measured emission rate. Determine the downward adjustment factor (DAF) using the following equation:

$$DAF = EF_H - EF_A$$

(d) *Sample calculation.* If EF_L is 0.10 g/kW-hr, EF_H is 0.50 g/kW-hr, and F is 0.1 (the regeneration occurs once for each ten tests), then:

$$EF_A = (0.1)(0.5 \text{ g/kW-hr}) + (1.0 - 0.1)(0.1 \text{ g/kW-hr}) = 0.14 \text{ g/kW-hr.}$$

$$UAF = 0.14 \text{ g/kW-hr} - 0.10 \text{ g/kW-hr} = 0.04 \text{ g/kW-hr.}$$

$$DAF = 0.50 \text{ g/kW-hr} - 0.14 \text{ g/kW-hr} = 0.36 \text{ g/kW-hr.}$$

(e) *Ramped-modal testing.* Develop a single sets of adjustment factors for the entire test. If a regeneration has started but has not been completed when you reach the end of a test, use good engineering judgment to reduce your downward adjustments to be proportional to the emission impact that occurred in the test.

(f) *Discrete-mode testing.* Develop separate adjustment factors for each test mode. If a regeneration has started but has not been completed when you reach the end of the sampling time for a test

mode extend the sampling period for that mode until the regeneration is completed.

Subpart G—Special Compliance Provisions

§ 1042.601 General compliance provisions for marine engines and vessels.

Engine and vessel manufacturers, as well as owners, operators, and rebuilders of engines and vessels subject to the requirements of this part, and all other persons, must observe the provisions of this part, the requirements and prohibitions in 40 CFR part 1068, and the provisions of the Clean Air Act. The provisions of 40 CFR part 1068 apply for compression-ignition marine engines as specified in that part, subject to the following provisions:

(a) The following prohibitions apply with respect to recreational marine engines and recreational vessels:

(1) Installing a recreational marine engine in a vessel that is not a recreational vessel is a violation of 40 CFR 1068.101(a)(1).

(2) For a vessel with an engine that is certified and labeled as a recreational marine engine, using it in a manner inconsistent with its intended use as a recreational vessel violates 40 CFR 1068.101(a)(1), except as allowed by this chapter.

(b) Subpart I of this part describes how the prohibitions of 40 CFR 1068.101(a)(1) apply for remanufactured engines. The provisions of 40 CFR 1068.105 do not allow the installation of a new remanufactured engine in a vessel that is defined as a “new vessel” unless the remanufactured engine is subject to the same standards as the standards applicable to freshly manufactured engines of the required model year.

(c) The provisions of 40 CFR 1068.120 apply when rebuilding marine engines, except as specified in subpart I of this part. The following additional requirements also apply when rebuilding marine engines equipped with exhaust aftertreatment:

(1) Follow all instructions from the engine manufacturer and aftertreatment manufacturer for checking, repairing, and replacing aftertreatment components. For example, you must replace the catalyst if the catalyst assembly is stamped with a build date more than ten years ago and the manufacturer’s instructions state that catalysts over ten years old must be replaced when the engine is rebuilt.

(2) Measure pressure drop across the catalyst assembly to ensure that it is neither higher nor lower than the manufacturer’s specifications and repair or replace exhaust-system components

as needed to bring the pressure drop within the manufacturer’s specifications.

(3) For engines equipped with exhaust sensors, verify that sensor outputs are within the manufacturer’s recommended range and repair or replace any malfunctioning components (sensors, catalysts, or other components).

(d) The provisions of § 1042.635 for the national security exemption apply instead of 40 CFR 1068.225.

(e) For replacement engines, apply the provisions of 40 CFR 1068.240 as described in § 1042.615.

(f) For the purpose of meeting the defect-reporting requirements in 40 CFR 1068.501, if you manufacture other nonroad engines that are substantially similar to your marine engines, you may consider defects using combined marine and non-marine families.

(g) For a marine engine labeled as requiring the use of ultra low-sulfur diesel fuel, is a violation of 40 CFR 1068.101(b)(1) to operate it with higher-sulfur fuel. It is also a violation of 40 CFR 1068.101(b)(1) if an engine installer or vessel manufacturer fails to follow the engine manufacturer’s emission-related installation instructions when installing a certified engine in a marine vessel.

§ 1042.605 Dressing engines already certified to other standards for nonroad or heavy-duty highway engines for marine use.

(a) *General provisions.* If you are an engine manufacturer (including someone who marinizes a land-based engine), this section allows you to introduce new marine engines into U.S. commerce if they are already certified to the requirements that apply to compression-ignition engines under 40 CFR parts 85 and 86 or 40 CFR part 89, 92, 1033, or 1039 for the appropriate model year. If you comply with all the provisions of this section, we consider the certificate issued under 40 CFR part 86, 89, 92, 1033, or 1039 for each engine to also be a valid certificate of conformity under this part 1042 for its model year, without a separate application for certification under the requirements of this part 1042.

(b) *Vessel-manufacturer provisions.* If you are not an engine manufacturer, you may install an engine certified for the appropriate model year under 40 CFR part 86, 89, 92, 1033, or 1039 in a marine vessel as long as you do not make any of the changes described in paragraph (d)(3) of this section and you meet the requirements of paragraph (e) of this section. If you modify the non-marine engine in any of the ways

described in paragraph (d)(3) of this section, we will consider you a manufacturer of a new marine engine. Such engine modifications prevent you from using the provisions of this section.

(c) *Liability.* Engines for which you meet the requirements of this section are exempt from all the requirements and prohibitions of this part, except for those specified in this section. Engines exempted under this section must meet all the applicable requirements from 40 CFR parts 85 and 86 or 40 CFR part 89, 92, 1033, or 1039. This paragraph (c) applies to engine manufacturers, vessel manufacturers that use such an engine, and all other persons as if the engine were used in its originally intended application. The prohibited acts of 40 CFR 1068.101(a)(1) apply to these new engines and vessels; however, we consider the certificate issued under 40 CFR part 86, 89, 92, 1033, or 1039 for each engine to also be a valid certificate of conformity under this part 1042 for its model year. If we make a determination that these engines do not conform to the regulations during their useful life, we may require you to recall them under 40 CFR part 85, 89, 92, or 1068.

(d) *Specific criteria and requirements.* If you are an engine manufacturer and meet all the following criteria and requirements regarding your new marine engine, the engine is eligible for an exemption under this section:

(1) You must produce it by marinizing an engine covered by a valid certificate of conformity from one of the following programs:

(i) Heavy-duty highway engines (40 CFR part 86).

(ii) Land-based compression-ignition nonroad engines (40 CFR part 89 or 1039).

(iii) Locomotives (40 CFR part 92 or 1033). To be eligible for dressing under this section, the engine must be from a locomotive certified to standards that are at least as stringent as either the standards applicable to new marine engines or freshly manufactured locomotives in the model year that the engine is being dressed.

(2) The engine must have the label required under 40 CFR part 86, 89, 92, 1033, or 1039.

(3) You must not make any changes to the certified engine that could reasonably be expected to increase its emissions. For example, if you make any of the following changes to one of these engines, you do not qualify for the engine dressing exemption:

(i) Change any fuel system parameters from the certified configuration, or change, remove, or fail to properly

install any other component, element of design, or calibration specified in the engine manufacturer's application for certification. This includes aftertreatment devices and all related components.

(ii) Replacing an original turbocharger, except that small-volume engine manufacturers may replace an original turbocharger on a recreational engine with one that matches the performance of the original turbocharger.

(iii) Modify or design the marine engine cooling or aftercooling system so that temperatures or heat rejection rates are outside the original engine manufacturer's specified ranges.

(4) You must show that fewer than 10 percent of the engine family's total sales in the United States are used in marine applications. This includes engines used in any application, without regard to which company manufactures the vessel or equipment. Show this as follows:

(i) If you are the original manufacturer of the engine, base this showing on your sales information.

(ii) In all other cases, you must confirm this based on your best estimate of the original manufacturer's sales information.

(e) *Labeling and documentation.* If you are an engine manufacturer or vessel manufacturer using this exemption, you must do all of the following:

(1) Make sure the original engine label will remain clearly visible after installation in the vessel.

(2) Add a permanent supplemental label to the engine in a position where it will remain clearly visible after installation in the vessel. In your engine label, do the following:

(i) Include the heading: "Marine Engine Emission Control Information".

(ii) Include your full corporate name and trademark.

(iii) State: "This engine was marinized without affecting its emission controls."

(iv) State the date you finished marinizing the engine (month and year).

(3) Send the Designated Compliance Officer a signed letter by the end of each calendar year (or less often if we tell you) with all the following information:

(i) Identify your full corporate name, address, and telephone number.

(ii) List the engine models for which you expect to use this exemption in the coming year and describe your basis for meeting the sales restrictions of paragraph (d)(4) of this section.

(iii) State: "We prepare each listed engine model for marine application without making any changes that could

increase its certified emission levels, as described in 40 CFR 1042.605."

(f) *Failure to comply.* If your engines do not meet the criteria listed in paragraph (d) of this section, they will be subject to the standards, requirements, and prohibitions of this part 1042 and the certificate issued under 40 CFR part(s) 86, 89, 92, 1033, or 1039 will not be deemed to also be a certificate issued under this part 1042. Introducing these engines into U.S. commerce as marine engines without a valid exemption or certificate of conformity under this part violates the prohibitions in 40 CFR 1068.101(a)(1).

(g) *Data submission.* (1) If you are both the original manufacturer and marinizer of an exempted engine, you must send us emission test data on the appropriate marine duty cycles. You can include the data in your application for certification or in the letter described in paragraph (e)(3) of this section.

(2) If you are the original manufacturer of an exempted engine that is marinized by a post-manufacture marinizer, you may be required to send us emission test data on the appropriate marine duty cycles. If such data are requested you will be allowed a reasonable amount of time to collect the data.

(h) *Participation in averaging, banking and trading.* Engines adapted for marine use under this section may not generate or use emission credits under this part 1042. These engines may generate credits under the ABT provisions in 40 CFR part(s) 86, 89, 92, 1033, or 1039, as applicable. These engines must use emission credits under 40 CFR part(s) 86, 89, 92, 1033, or 1039 as applicable if they are certified to an FEL that exceeds an emission standard.

(i) *Operator requirements.* The requirements specified for vessel manufacturers, owners, and operators in this subpart (including requirements in 40 CFR part 1068) apply to these engines whether they are certified under this part 1042 or another part as allowed by this section.

§ 1042.610 Certifying auxiliary marine engines to land-based standards.

This section applies to auxiliary marine engines that are identical to certified land-based engines. See § 1042.605 for provisions that apply to propulsion marine engines or auxiliary marine engines that are modified for marine applications.

(a) *General provisions.* If you are an engine manufacturer, this section allows you to introduce new marine engines into U.S. commerce if they are already certified to the requirements that apply to compression-ignition engines under

40 CFR part 89 or 1039 for the appropriate model year. If you comply with all the provisions of this section, we consider the certificate issued under 40 CFR part 89 or 1039 for each engine to also be a valid certificate of conformity under this part 1042 for its model year, without a separate application for certification under the requirements of this part 1042.

(b) *Vessel-manufacturer provisions.* If you are not an engine manufacturer, you may install an engine certified for land-based applications in a marine vessel as long as you meet all the qualifying criteria and requirements specified in paragraphs (d) and (e) of this section. If you modify the non-marine engine, we will consider you a manufacturer of a new marine engine. Such engine modifications prevent you from using the provisions of this section.

(c) *Liability.* Engines for which you meet the requirements of this section are exempt from all the requirements and prohibitions of this part, except for those specified in this section. Engines exempted under this section must meet all the applicable requirements from 40 CFR part 89 or 1039. This paragraph (c) applies to engine manufacturers, vessel manufacturers that use such an engine, and all other persons as if the engine were used in its originally intended application. The prohibited acts of 40 CFR 1068.101(a)(1) apply to these new engines and vessels; however, we consider the certificate issued under 40 CFR part 89 or 1039 for each engine to also be a valid certificate of conformity under this part 1042 for its model year. If we make a determination that these engines do not conform to the regulations during their useful life, we may require you to recall them under 40 CFR part 89 or 1068.

(d) *Qualifying criteria.* If you are an engine manufacturer and meet all the following criteria and requirements regarding your new marine engine, the engine is eligible for an exemption under this section:

(1) The marine engine must be identical in all material respects to a land-based engine covered by a valid certificate of conformity for the appropriate model year showing that it meets emission standards for engines of that power rating under 40 CFR part 89 or 1039.

(2) The engines may not be used as propulsion marine engines.

(3) You must show that the number of auxiliary marine engines from the engine family must be smaller than the number of land-based engines from the engine family sold in the United States, as follows:

(i) If you are the original manufacturer of the engine, base this showing on your sales information.

(ii) In all other cases, you must get the original manufacturer of the engine to confirm this based on its sales information.

(e) *Specific requirements.* If you are an engine manufacturer or vessel manufacturer using this exemption, you must do all of the following:

(1) Make sure the original engine label will remain clearly visible after installation in the vessel. This label or a supplemental label must identify that the original certification is valid for auxiliary marine applications.

(2) Send a signed letter to the Designated Compliance Officer by the end of each calendar year (or less often if we tell you) with all the following information:

(i) Identify your full corporate name, address, and telephone number.

(ii) List the engine models you expect to produce under this exemption in the coming year and describe your basis for meeting the sales restrictions of paragraph (d)(3) of this section.

(iii) State: "We produce each listed engine model for marine application without making any changes that could increase its certified emission levels, as described in 40 CFR 1042.610."

(3) If you are the certificate holder, you must describe in your application for certification how you plan to produce engines for both land-based and auxiliary marine applications, including projected sales of auxiliary marine engines to the extent this can be determined. If the projected marine sales are substantial, we may ask for the year-end report of production volumes to include actual auxiliary marine engine sales.

(f) *Failure to comply.* If your engines do not meet the criteria listed in paragraph (d) of this section, they will be subject to the standards, requirements, and prohibitions of this part 1042 and the certificate issued under 40 CFR part 89 or 1039 will not be deemed to also be a certificate issued under this part 1042. Introducing these engines into U.S. commerce as marine engines without a valid exemption or certificate of conformity under this part 1042 violates the prohibitions in 40 CFR 1068.101(a)(1).

(g) *Participation in averaging, banking and trading.* Engines using this exemption may not generate or use emission credits under this part 1042. These engines may generate credits under the ABT provisions in 40 CFR part 89 or 1039, as applicable. These engines must use emission credits under 40 CFR part 89 or 1039 as applicable if

they are certified to an FEL that exceeds an emission standard.

(h) *Operator requirements.* The requirements specified for vessel manufacturers, owners, and operators in this subpart (including requirements in 40 CFR part 1068) apply to these engines whether they are certified under this part 1042 or another part as allowed by this section.

§ 1042.615 Replacement engine exemption.

For replacement engines, apply the provisions of 40 CFR 1068.240 as described in this section.

(a) This paragraph (a) applies instead of the provisions of 40 CFR 1068.240(b)(3). The prohibitions in 40 CFR 1068.101(a)(1) do not apply for a new replacement engine meeting Tier 3 standards if the engine being replaced is a Tier 3 or earlier engine (this applies where new engines would otherwise be subject to Tier 4 or later standards). For other cases, the prohibitions in 40 CFR 1068.101(a)(1) do not apply to a new replacement engine if all the following conditions are met:

(1) You use good engineering judgment to determine that no engine certified to the current requirements of this part is produced by any manufacturer with the appropriate physical or performance characteristics to repower the vessel.

(2) You make a record of your determination for each replacement engine with the following information and keep these records for eight years:

(i) If you determine that no engine certified to the current requirements of this part is available with the appropriate performance characteristics, explain why certified engines produced by you and other manufacturers cannot be used as a replacement because they are not similar to the engine being replaced in terms of power or speed.

(ii) You may determine that all engines certified to the current requirements of this part that have appropriate performance characteristics are not available because they do not have the appropriate physical characteristics. If this is the case, explain why these certified engines produced by you and other manufacturers cannot be used as a replacement because their weight or dimensions are substantially different than those of the engine being replaced, or because they will not fit within the vessel's engine compartment or engine room.

(iii) In evaluating appropriate physical or performance characteristics, you may account for compatibility with vessel components you would not

otherwise replace when installing a new engine, including transmissions or reduction gears, drive shafts or propeller shafts, propellers, cooling systems, operator controls, or electrical systems for generators or indirect-drive configurations. If you make your determination on this basis, you must identify the vessel components that are incompatible with engines certified to current standards and explain how they are incompatible and why it would be unreasonable to replace them.

(iv) In evaluating appropriate physical or performance characteristics, you may account for compatibility in a set of two or more propulsion engines on a vessel where only one of the engines needs replacement, but only if each engine not needing replacement has operated for less than 75 percent of its applicable useful life in hours or years (see § 1042.101). If any engine not otherwise needing replacement exceeds this 75 percent threshold, your determination must consider replacement of all the propulsion engines.

(v) In addition to the determination specified in paragraph (a)(1) of this section, you must make a separate determination for your own product line addressing every tier of emission standards that is more stringent than the emission standards for the engine being replaced. For example, if the engine being replaced was built before the Tier 1 standards started to apply and engines of that size are currently subject to Tier 3 standards, you must consider whether any Tier 1 or Tier 2 engines that you produce have the appropriate physical and performance characteristics for replacing the old engine; if you can produce a Tier 2 engine with the appropriate physical and performance characteristics, you must use it as the replacement engine.

(3) You must notify us within 30 days after you ship each replacement engine under this section. Your notification must include all the following things and be signed by an authorized representative of your company:

(i) A copy of your records describing how you made the determination described in paragraph (a)(2) of this section for this particular engine.

(ii) The total number of replacement engines you have shipped in the applicable calendar year, from all your marine engine models.

(iii) The following statement:

I certify that the statements and information in the enclosed document are true, accurate, and complete to the best of my knowledge. I am aware that there are significant civil and criminal penalties for submitting false statements

and information, or omitting required statements and information.

(4) We may reduce the reporting and recordkeeping requirements in this section.

(b) Modifying a vessel to significantly increase its value within six months after installing a replacement engine produced under this section is a violation of 40 CFR 1068.101(a)(1).

(c) We may void an exemption for an engine if we determine that any of the conditions described in paragraph (a) of this section are not met.

§ 1042.620 Engines used solely for competition.

The provisions of this section apply for new engines and vessels built on or after January 1, 2009.

(a) We may grant you an exemption from the standards and requirements of this part for a new engine on the grounds that it is to be used solely for competition. The requirements of this part, other than those in this section, do not apply to engines that we exempt for use solely for competition. The prohibitions in § 1068.101(a)(1) do not apply to engines exempted under this section.

(b) We will exempt engines that we determine will be used solely for competition. The basis of our determination is described in paragraphs (c) and (d) of this section. Exemptions granted under this section are good for only one model year and you must request renewal for each subsequent model year. We will not approve your renewal request if we determine the engine will not be used solely for competition.

(c) Engines meeting all the following criteria are considered to be used solely for competition:

(1) Neither the engine nor any vessels containing the engine may be displayed for sale in any public dealership or otherwise offered for sale to the general public.

(2) Sale of the vessel in which the engine is installed must be limited to professional racing teams, professional racers, or other qualified racers. Keep records documenting this, such as a letter requesting an exempted engine.

(3) The engine and the vessel in which it is installed must have performance characteristics that are substantially superior to noncompetitive models.

(4) The engines are intended for use only as specified in paragraph (e) of this section.

(d) You may ask us to approve an exemption for engines not meeting the applicable criteria listed in paragraph (c) of this section as long as you have

clear and convincing evidence that the engines will be used solely for competition.

(e) Engines will not be considered to be used solely for competition if they are ever used for any recreational or other noncompetitive purpose. This means that their use must be limited to competition events sanctioned by the U.S. Coast Guard or another public organization with authorizing permits for participating competitors. Operation for such engines may include only racing events or trials to qualify for racing events. Authorized attempts to set speed records (and the associated official trials) are also considered racing events. Any use of exempt engines in recreational events, such as poker runs and lobsterboat races, is a violation of 40 CFR 1068.101(b)(4).

(f) You must permanently label engines exempted under this section to clearly indicate that they are to be used only for competition. Failure to properly label an engine will void the exemption for that engine.

(g) If we request it, you must provide us any information we need to determine whether the engines or vessels are used solely for competition. This would include documentation regarding the number of engines and the ultimate purchaser of each engine. Keep these records for five years.

§ 1042.625 Special provisions for engines used in emergency applications.

(a) Except as specified in paragraph (d) of this section, the prohibitions in § 1068.101(a)(1) do not apply to a new engine that is subject to Tier 4 standards if the following conditions are met:

(1) The engine is intended for installation in one of the following vessels or applications:

(i) A lifeboat approved by the U.S. Coast Guard under approval series 160.135 (see for example 46 CFR 199.201(a)(1)), as long as such a vessel is not also used as a launch or tender.

(ii) A rescue boat approved by the U.S. Coast Guard under approval series 160.156 (see for example 46 CFR 199.202(a)).

(iii) Generator sets or other auxiliary equipment that qualify as final emergency power sources under 46 CFR part 112.

(2) The engine meets the Tier 3 emission standards specified in § 1042.101 as specified in 40 CFR 1068.265.

(3) The engine is used only for its intended purpose, as specified on the emission control information label.

(b) Except as specified in paragraph (d) of this section, the prohibitions in § 1068.101(a)(1) do not apply to a new

engine that is subject to Tier 3 standards according to the following provisions:

(1) The engine must be intended for installation in a lifeboat or a rescue boat as specified in paragraph (a)(1)(i) or (ii) of this section.

(2) This exemption is available from the initial effective date for the Tier 3 standards until the engine model (or one of comparable size, weight, and performance) has been certified as complying with the Tier 3 standards and Coast Guard requirements.

(3) The engine must meet the Tier 2 emission standards specified in Appendix I of this part as specified in 40 CFR 1068.265.

(c) If you introduce an engine into U.S. commerce under this section, you must meet the labeling requirements in § 1042.135, but add one of the following statements instead of the compliance statement in § 1042.135(c)(10):

(1) For lifeboats and rescue boats, add the following statement:

THIS ENGINE DOES NOT COMPLY WITH CURRENT U.S. EPA EMISSION STANDARDS UNDER 40 CFR 1042.625 AND IS FOR USE SOLELY IN LIFEBOATS OR RESCUE BOATS (COAST GUARD APPROVAL SERIES 160.135 OR 160.156). INSTALLATION OR USE OF THIS ENGINE IN ANY OTHER APPLICATION MAY BE A VIOLATION OF FEDERAL LAW SUBJECT TO CIVIL PENALTY.

(2) For engines serving as final emergency power sources, add the following statement:

THIS ENGINE DOES NOT COMPLY WITH CURRENT U.S. EPA EMISSION STANDARDS UNDER 40 CFR 1042.625 AND IS FOR USE SOLELY IN EMERGENCY EQUIPMENT REGULATED BY 46 CFR 112. INSTALLATION OR USE OF THIS ENGINE IN ANY OTHER APPLICATION MAY BE A VIOLATION OF FEDERAL LAW SUBJECT TO CIVIL PENALTY.

(d) Introducing into commerce a vessel containing an engine exempted under this section violates the prohibitions in 40 CFR 1068.101(a)(1) where the vessel is not covered by paragraph (a) or (b) of this section, unless it is exempt under a different provision. Similarly, using such an engine or vessel as something other than a lifeboat, rescue boat, or emergency engine as specified in paragraph (a)(1) of this section violates the prohibitions in 40 CFR 1068.101(a)(1), unless it is exempt under a different provision.

§ 1042.630 Personal-use exemption.

This section applies to individuals who manufacture vessels for personal use. If you and your vessel meet all the

conditions of this section, the vessel and its engine are considered to be exempt from the standards and requirements of this part that apply to new engines and new vessels. The prohibitions in § 1068.101(a)(1) do not apply to engines exempted under this section. For example, you may install an engine that was not certified as a marine engine.

(a) The vessel may not be manufactured from a previously certified vessel, nor may it be manufactured from a partially complete vessel that is equivalent to a certified vessel. The vessel must be manufactured primarily from unassembled components, but may incorporate some preassembled components. For example, fully preassembled steering assemblies may be used. You may also power the vessel with an engine that was previously used in a highway or land-based nonroad application.

(b) The vessel may not be sold within five years after the date of final assembly.

(c) No individual may manufacture more than one vessel in any ten-year period under this exemption.

(d) You may not use the vessel in any revenue-generating service or for any other commercial purpose, except that you may use a vessel exempt under this section for commercial fishing that you personally do.

(e) This exemption may not be used to circumvent the requirements of this part or the requirements of the Clean Air Act. For example, this exemption would not cover a case in which a person sells an almost completely assembled vessel to another person, who would then complete the assembly. This would be considered equivalent to the sale of the complete new vessel. This section also does not allow engine manufacturers to produce new engines that are exempt from emission standards and it does not provide an exemption from the prohibition against tampering with certified engines.

(f) The vessel must be a vessel that is not classed or subject to Coast Guard inspections or surveys.

§ 1042.635 National security exemption.

The standards and requirements of this part and prohibitions in § 1068.101(a)(1) do not apply to engines exempted under this section.

(a) You are eligible for the exemption for national security only if you are a manufacturer.

(b) Your engine is exempt without a request if it will be used or owned by an agency of the federal government responsible for national defense, where the vessel has armor, permanently

attached weaponry, specialized electronic warfare systems, unique stealth performance requirements, and/or unique combat maneuverability requirements.

(c) You may request a national security exemption for engines not meeting the conditions of paragraph (b) of this section, as long as your request is endorsed by an agency of the federal government responsible for national defense. In your request, explain why you need the exemption.

(d) Add a legible label, written in English, to all engines exempted under this section. The label must be permanently secured to a readily visible part of the engine needed for normal operation and not normally requiring replacement, such as the engine block. This label must include at least the following items:

(1) The label heading "EMISSION CONTROL INFORMATION".

(2) Your corporate name and trademark.

(3) Engine displacement, family identification, and model year of the engine (as applicable), or whom to contact for further information.

(4) The statement "THIS ENGINE HAS AN EXEMPTION FOR NATIONAL SECURITY UNDER 40 CFR 1042.635.".

§ 1042.640 Special provisions for branded engines.

The following provisions apply if you identify the name and trademark of another company instead of your own on your emission control information label, as provided by § 1042.135(c)(2):

(a) You must have a contractual agreement with the other company that obligates that company to take the following steps:

(1) Meet the emission warranty requirements that apply under § 1042.120. This may involve a separate agreement involving reimbursement of warranty-related expenses.

(2) Report all warranty-related information to the certificate holder.

(b) In your application for certification, identify the company whose trademark you will use.

(c) You remain responsible for meeting all the requirements of this chapter, including warranty and defect-reporting provisions.

§ 1042.650 Migratory vessels.

The provisions of this section address concerns for vessel owners related to extended use of vessels with Tier 4 engines outside the United States where ultra low-sulfur diesel fuel is not available.

(a) *Temporary exemption.* A vessel owner may ask us for a temporary

exemption from the tampering prohibition in 40 CFR 1068.101(b)(1) for a vessel if it will operate only in areas outside the United States where ULSD is not available. In your request, describe where the vessel will operate, how long it will operate there, why ULSD will be unavailable, and how you will modify the engine, including its emission controls. If we approve your request, you may modify the engine, but only as needed to disable or remove the emission controls needed for meeting the Tier 4 standards. You must return the engine to its original certified configuration before the vessel returns to the United States to avoid violating the tampering prohibition in 40 CFR 1068.101(b)(1). We may set additional conditions to prevent circumvention of the provisions of this part.

(b) *SOLAS exemption.* We may approve a permanent exemption from the prohibitions in 40 CFR 1068.101(a)(1) for an engine that is subject to Tier 4 standards as described in this paragraph (b).

(1) Vessel owners may ask for a permanent exemption from the Tier 4 standards for an engine that will be installed on vessels that will operate for extended periods outside the United States, provided they demonstrate all of the following are true:

(i) Prior to introduction into service, the vessel will comply with applicable certification requirements for international safety pursuant to the U.S. Coast Guard and the International Convention for the Protection of Life at Sea (SOLAS). The vessel owner must maintain compliance with these requirements for the life of the exempted engine.

(ii) The vessel will be used in areas outside of the United States where ULSD will not be available.

(iii) The mix of vessels with engines certified to Tier 3 or earlier standards in the owner's current fleet and the owner's current business operation of those vessels makes the exemption necessary. Note that because of the large fraction of pre-Tier 4 engines in the fleet prior to 2021, a request for a Tier 4 exemption prior to that year must clearly demonstrate that unusual circumstances apply.

(2) An engine exempted under this paragraph (b) must meet the Tier 3 emission standards described in § 1402.101, subject to the procedural requirements of 40 CFR 1068.265.

(3) If you introduce an engine into U.S. commerce under this section, you must meet the labeling requirements in § 1042.135, but add the following statement instead of the compliance statement in § 1042.135(c)(10):

THIS ENGINE DOES NOT COMPLY WITH CURRENT U.S. EPA EMISSION STANDARDS UNDER 40 CFR 1042.650 AND IS FOR USE SOLELY IN SOLAS VESSELS. INSTALLATION OR USE OF THIS ENGINE IN ANY OTHER APPLICATION MAY BE A VIOLATION OF FEDERAL LAW SUBJECT TO CIVIL PENALTY.

(4) Operating a vessel containing an engine exempted under this paragraph (b) violates the prohibitions in 40 CFR 1068.101(a)(1) if the vessel is not in full compliance with applicable requirements for international safety specified in paragraph (b)(1)(i) of this section.

(c) *Vessels less than 500 gross tons.* In unusual circumstances for vessels less than 500 gross tons, we may approve a vessel owner's request for a permanent exemption from the prohibitions in 40 CFR 1068.101(a)(1) for an engine that is subject to Tier 4 standards that will operate for extended periods outside the United States without it being in compliance with applicable certification requirements for international safety. We may set appropriate additional conditions on such exemptions, and may void the exemption if those conditions are not met.

§ 1042.660 Requirements for vessel manufacturers, owners, and operators.

(a) The provisions of 40 CFR part 94, subpart K, apply to manufacturers, owners, and operators of marine vessels that contain Category 3 engines subject to the provisions of 40 CFR part 94, subpart A.

(b) For vessels equipped with emission controls requiring the use of specific fuels, lubricants, or other fluids, owners and operators must comply with the manufacturer/remanufacturer's specifications for such fluids when operating the vessels. Failure to comply with the requirements of this paragraph is a violation of 40 CFR 1068.101(b)(1).

(c) For vessels equipped with SCR systems requiring the use of urea or other reductants, owners and operators must report to us within 30 days any operation of such vessels without the appropriate reductant. Failure to comply with the requirements of this paragraph is a violation of 40 CFR 1068.101(a)(2).

Subpart H—Averaging, Banking, and Trading for Certification

§ 1042.701 General provisions.

(a) You may average, bank, and trade (ABT) emission credits for purposes of certification as described in this subpart to show compliance with the standards of this part. Participation in this program is voluntary.

(b) The definitions of subpart J of this part apply to this subpart. The following definitions also apply:

(1) *Actual emission credits* means emission credits you have generated that we have verified by reviewing your final report.

(2) *Applicable emission standard* means an emission standard that is specified in subpart B of this part. Note that for other subparts, "applicable emission standard" is defined to also include FELs.

(3) *Averaging set* means a set of engines in which emission credits may be exchanged only with other engines in the same averaging set.

(4) *Broker* means any entity that facilitates a trade of emission credits between a buyer and seller.

(5) *Buyer* means the entity that receives emission credits as a result of a trade.

(6) *Reserved emission credits* means emission credits you have generated that we have not yet verified by reviewing your final report.

(7) *Seller* means the entity that provides emission credits during a trade.

(8) *Standard* means the emission standard that applies under subpart B of this part for engines not participating in the ABT program of this subpart.

(9) *Trade* means to exchange emission credits, either as a buyer or seller.

(c) Emission credits may be exchanged only within an averaging set. Except as specified in paragraph (d) of this section, the following criteria define the applicable averaging sets:

(1) Recreational engines.

(2) Commercial Category 1 engines.

(3) Category 2 engines.

(d) Emission credits generated by commercial Category 1 engine families may be used for compliance by Category 2 engine families. Such credits must be discounted by 25 percent.

(e) You may not use emission credits generated under this subpart to offset any emissions that exceed an FEL or standard. This applies for all testing, including certification testing, in-use testing, selective enforcement audits, and other production-line testing. However, if emissions from an engine exceed an FEL or standard (for example, during a selective enforcement audit), you may use emission credits to recertify the engine family with a higher FEL that applies only to future production.

(f) Engine families that use emission credits for one or more pollutants may not generate positive emission credits for another pollutant.

(g) Emission credits may be used in the model year they are generated or in

future model years. Emission credits may not be used for past model years.

(h) You may increase or decrease an FEL during the model year by amending your application for certification under § 1042.225.

(i) You may use NO_x+HC credits to show compliance with a NO_x emission standard or use NO_x credits to show compliance with a NO_x+HC emission standard.

§ 1042.705 Generating and calculating emission credits.

The provisions of this section apply separately for calculating emission credits for NO_x, NO_x+HC, or PM.

(a) For each participating family, calculate positive or negative emission credits relative to the otherwise applicable emission standard. Calculate positive emission credits for a family that has an FEL below the standard. Calculate negative emission credits for a family that has an FEL above the standard. Sum your positive and negative credits for the model year before rounding. Round calculated emission credits to the nearest kilogram (kg), using consistent units throughout the following equation:

$$\text{Emission credits (kg)} = (\text{Std} - \text{FEL}) \times (\text{Volume}) \times (\text{Power}) \times (\text{LF}) \times (\text{UL}) \times (10^{-3})$$

Where:

Std = The emission standard, in g/kW-hr.

FEL = The family emission limit for the engine family, in g/kW-hr.

Volume = The number of engines eligible to participate in the averaging, banking, and trading program within the given engine family during the model year, as described in paragraph (c) of this section.

Power = The average value of maximum engine power of all the engine configurations within an engine family, calculated on a production-weighted basis, in kilowatts.

LF = Load factor. Use 0.69 for propulsion marine engines and 0.51 for auxiliary marine engines. We may specify a different load factor if we approve the use of special test procedures for an engine family under 40 CFR 1065.10(c)(2), consistent with good engineering judgment.

UL = The useful life for the given engine family, in hours.

(b) [Reserved]

(c) In your application for certification, base your showing of compliance on projected production volumes for engines whose point of first retail sale is in the United States. As described in § 1042.730, compliance with the requirements of this subpart is determined at the end of the model year based on actual production volumes for engines whose point of first retail sale is in the United States. Do not include

any of the following engines to calculate emission credits:

(1) Engines permanently exempted under subpart G of this part or under 40 CFR part 1068.

(2) Exported engines.

(3) Engines not subject to the requirements of this part, such as those excluded under § 1042.5.

(4) [Reserved]

(5) Any other engines, where we indicate elsewhere in this part 1042 that they are not to be included in the calculations of this subpart.

§ 1042.710 Averaging emission credits.

(a) Averaging is the exchange of emission credits among your engine families.

(b) You may certify one or more engine families to an FEL above the emission standard, subject to the FEL caps and other provisions in subpart B of this part, if you show in your application for certification that your projected balance of all emission-credit transactions in that model year is greater than or equal to zero.

(c) If you certify an engine family to an FEL that exceeds the otherwise applicable emission standard, you must obtain enough emission credits to offset the engine family's deficit by the due date for the final report required in § 1042.730. The emission credits used to address the deficit may come from your other engine families that generate emission credits in the same model year, from emission credits you have banked, or from emission credits you obtain through trading.

§ 1042.715 Banking emission credits.

(a) Banking is the retention of emission credits by the manufacturer generating the emission credits for use in averaging or trading in future model years.

(b) You may use banked emission credits from the previous model year for averaging or trading before we verify them, but we may revoke these emission credits if we are unable to verify them after reviewing your reports or auditing your records.

(c) Reserved credits become actual emission credits only when we verify them in reviewing your final report.

§ 1042.720 Trading emission credits.

(a) Trading is the exchange of emission credits between manufacturers. You may use traded emission credits for averaging, banking, or further trading transactions.

(b) You may trade actual emission credits as described in this subpart. You may also trade reserved emission credits, but we may revoke these

emission credits based on our review of your records or reports or those of the company with which you traded emission credits. You may trade banked credits to any certifying manufacturer.

(c) If a negative emission credit balance results from a transaction, both the buyer and seller are liable, except in cases we deem to involve fraud. See § 1042.255(e) for cases involving fraud. We may void the certificates of all engine families participating in a trade that results in a manufacturer having a negative balance of emission credits. See § 1042.745.

§ 1042.725 Information required for the application for certification.

(a) You must declare in your application for certification your intent to use the provisions of this subpart for each engine family that will be certified using the ABT program. You must also declare the FELs you select for the engine family for each pollutant for which you are using the ABT program. Your FELs must comply with the specifications of subpart B of this part, including the FEL caps. FELs must be expressed to the same number of decimal places as the emission standards.

(b) Include the following in your application for certification:

(1) A statement that, to the best of your belief, you will not have a negative balance of emission credits for any averaging set when all emission credits are calculated at the end of the year.

(2) Detailed calculations of projected emission credits (positive or negative) based on projected production volumes.

§ 1042.730 ABT reports.

(a) If any of your engine families are certified using the ABT provisions of this subpart, you must send an end-of-year report within 90 days after the end of the model year and a final report within 270 days after the end of the model year. We may waive the requirement to send the end-of-year report, as long as you send the final report on time.

(b) Your end-of-year and final reports must include the following information for each engine family participating in the ABT program:

(1) Engine-family designation.

(2) The emission standards that would otherwise apply to the engine family.

(3) The FEL for each pollutant. If you changed an FEL during the model year, identify each FEL you used and calculate the positive or negative emission credits under each FEL. Also, describe how the FEL can be identified for each engine you produced. For example, you might keep a list of engine

identification numbers that correspond with certain FEL values.

(4) The projected and actual production volumes for the model year with a point of first retail sale in the United States, as described in § 1042.705(c). If you changed an FEL during the model year, identify the actual production volume associated with each FEL.

(5) Maximum engine power for each engine configuration, and the production-weighted average engine power for the engine family.

(6) Useful life.

(7) Calculated positive or negative emission credits for the whole engine family. Identify any emission credits that you traded, as described in paragraph (d)(1) of this section.

(c) Your end-of-year and final reports must include the following additional information:

(1) Show that your net balance of emission credits from all your participating engine families in each averaging set in the applicable model year is not negative.

(2) State whether you will retain any emission credits for banking.

(3) State that the report's contents are accurate.

(d) If you trade emission credits, you must send us a report within 90 days after the transaction, as follows:

(1) Sellers must include the following information in their report:

(i) The corporate names of the buyer and any brokers.

(ii) A copy of any contracts related to the trade.

(iii) The engine families that generated emission credits for the trade, including the number of emission credits from each family.

(2) Buyers must include the following information in their report:

(i) The corporate names of the seller and any brokers.

(ii) A copy of any contracts related to the trade.

(iii) How you intend to use the emission credits, including the number of emission credits you intend to apply to each engine family (if known).

(e) Send your reports electronically to the Designated Compliance Officer using an approved information format. If you want to use a different format, send us a written request with justification for a waiver.

(f) Correct errors in your end-of-year report or final report as follows:

(1) You may correct any errors in your end-of-year report when you prepare the final report, as long as you send us the final report by the time it is due.

(2) If you or we determine within 270 days after the end of the model year that

errors mistakenly decreased your balance of emission credits, you may correct the errors and recalculate the balance of emission credits. You may not make these corrections for errors that are determined more than 270 days after the end of the model year. If you report a negative balance of emission credits, we may disallow corrections under this paragraph (f)(2).

(3) If you or we determine anytime that errors mistakenly increased your balance of emission credits, you must correct the errors and recalculate the balance of emission credits.

§ 1042.735 Recordkeeping.

(a) You must organize and maintain your records as described in this section. We may review your records at any time.

(b) Keep the records required by this section for eight years after the due date for the end-of-year report. You may not use emission credits on any engines if you do not keep all the records required under this section. You must therefore keep these records to continue to bank valid credits. Store these records in any format and on any media, as long as you can promptly send us organized, written records in English if we ask for them. You must keep these records readily available. We may review them at any time.

(c) Keep a copy of the reports we require in § 1042.730.

(d) Keep the following additional records for each engine you produce that generates or uses emission credits under the ABT program:

(1) Engine family designation.

(2) Engine identification number. You may identify these numbers as a range.

(3) FEL and useful life. If you change the FEL after the start of production, identify the date that you started using the new FEL and give the engine identification number for the first engine covered by the new FEL.

(4) Maximum engine power.

(5) Purchaser and destination.

(e) We may require you to keep additional records or to send us relevant information not required by this section, as allowed under the Clean Air Act.

§ 1042.745 Noncompliance.

(a) For each engine family participating in the ABT program, the certificate of conformity is conditional upon full compliance with the provisions of this subpart during and after the model year. You are responsible to establish to our satisfaction that you fully comply with applicable requirements. We may void the certificate of conformity for an engine family if you fail to comply with any provisions of this subpart.

(b) You may certify your engine family to an FEL above an emission standard based on a projection that you will have enough emission credits to offset the deficit for the engine family. However, we may void the certificate of conformity if you cannot show in your final report that you have enough actual emission credits to offset a deficit for any pollutant in an engine family.

(c) We may void the certificate of conformity for an engine family if you fail to keep records, send reports, or give us information we request.

(d) You may ask for a hearing if we void your certificate under this section (see § 1042.920).

Subpart I—Special Provisions for Remanufactured Marine Engines

§ 1042.801 General provisions.

This section describes how the provisions of this part 1042 apply for certain remanufactured marine engines.

(a) The requirements of this subpart apply for remanufactured Tier 2 and earlier commercial marine engines at or above 600 kW, excluding those engines originally manufactured before 1973. Note that the requirements of this subpart do not apply for engines below 600 kW, engines installed on recreational vessels, or Tier 3 and later engines.

(b) Any person meeting the definition of “remanufacturer” in § 1042.901 may apply for a certificate of conformity for a remanufactured engine family.

(c) The rebuilding requirements of 40 CFR 1068.120 do not apply to remanufacturing of engines using a certified remanufacturing system under this subpart. However, the requirements of 40 CFR 1068.120 do apply to all other remanufacturing of engines.

(d) Unless specified otherwise, engines certified under this subpart are also subject to the other requirements of this part.

(e) For remanufactured engines required to have a valid certificate of conformity, placing a new marine engine back into service following remanufacturing is a violation of 40 CFR 1068.101(a)(1), unless it has a valid certificate of conformity for its model year and the required label.

(f) Remanufacturing systems that require a fuel change or use of a fuel additive may be certified under this part. However, they are not considered to be “available” with respect to triggering the requirement for an engine to be covered by a certificate of conformity under § 1042.815. The following provisions apply:

(i) Only fuels and additives registered under 40 CFR part 79 may be used under this paragraph.

(ii) You must demonstrate in your application that the fuel or additive will actually be used by operators, including a description of how the vessels and dispensing tanks will be labeled. We may require you to provide the labels to the operators.

(iii) You must also describe analytical methods that can be used by EPA or others to verify that fuel meets your specifications.

(iv) You must provide clear instructions to the operators specifying that they may only use the specified fuel/additive, label their vessels and fuel dispensing tanks, and keep records of their use of the fuel/additive in order for their engine to be covered by your certificate. Use of the incorrect fuel (or fuel without the specified additive) or any other failure to comply with the requirements of this paragraph is a violation of 40 CFR 1068.101(b)(1).

(g) Vessels equipped with emission controls as part of a state or local retrofit program prior to January 1, 2017 are exempt from the requirements of this subpart, as specified in this paragraph (g).

(1) This exemption only applies for retrofit programs sponsored by a state government (or one of its political subdivisions) for the purpose of reducing emissions. The exemption does not apply where the sponsoring government specifies that inclusion in the retrofit program is not intended to provide an exemption from the requirements of this subpart.

(2) The prohibitions against tampering and defeat devices in 40 CFR 1068.101(b) and the rebuilding requirements in 40 CFR 1068.120 apply for the exempt engines in the same manner as if they were covered by a certificate.

(3) Vessel owners must request an exemption prior to remanufacturing the engine. Your request must include documentation that your vessel has been retrofitted consistent with the specifications of paragraph (g)(1) of this section, and a signed statement declaring that to be true. Except for the initial request for a specific vessel and a specific retrofit, you may consider your request to be approved unless we notify you otherwise within 30 days of the date that we receive your request.

§ 1042.810 Requirements for owner/operators and installers during remanufacture.

This section describes how the remanufacturing regulations affect

owner/operators and installers for engines subject to this subpart.

(a) See the definition of “remanufacture” in § 1042.901 to determine if you are remanufacturing your engine. (**Note:** Replacing cylinders one at a time may qualify as remanufacturing, depending on the interval between replacement.)

(b) See the definition of “new marine engine” in § 1042.901 to determine if remanufacturing your engine makes it subject to the requirements of this part. If the engine is considered to be new, it is subject to the certification requirements of this subpart, unless it is exempt under subpart G of this part.

(c) Your engine is not subject to the standards of this part if we determine that no certified remanufacturing system is available for your engine as described in § 1042.815. For engines that are remanufactured during multiple events within a five-year period, you are not required to use a certified system until all of your engine’s cylinders have been replaced after the system became available. For example, if you remanufacture your 16-cylinder engine by replacing four cylinders each January and a system becomes available for your engine June 1, 2010, your engine must be in a certified configuration when you replace four cylinders in January of 2014. At that point, all 16 cylinders would have been replaced after June 1, 2010.

(d) You may comply with the certification requirements of this part for your remanufactured engine by either obtaining your own certificate of conformity as specified in subpart C of this part or by having a certifying remanufacturer include your engine under its certificate of conformity. In either case, your remanufactured engine must be covered by a certificate before it is reintroduced into service.

(e) Contact a certifying remanufacturer to have your engine included under its certificate of conformity. You must comply with the certificate holder’s emission-related installation instructions.

§ 1042.815 Demonstrating availability.

(a) A certified remanufacturing system is considered to be available for a specific engine only if EPA has certified the remanufacturing system as being in compliance with the provisions of this part and the certificate holder has demonstrated during certification that the system meets the criteria of this paragraph (a). We may issue a certificate for a remanufacturing system that does not meet these criteria, but such systems would not be considered available.

(1) The engine configuration must be included in the engine family for the remanufacturing system.

(2) The total marginal cost of the remanufacturing system, as calculated under paragraph (c) of this section, must be less than \$45,000 per ton of PM reduction.

(3) It must be possible to obtain and install the remanufacturing system in a timely manner consistent with normal remanufacturing procedures. For example, a remanufacturing system would generally not be considered to be available if it required that the engine be removed from the vessel and shipped to a factory to be remanufactured.

(4) The remanufacturing system may result in increased maintenance costs, provided the incremental maintenance costs are included in the total costs. The remanufacturing system may not adversely affect engine reliability or power. Note that owner/operators may ask us to determine that a remanufacturing system is not considered available for their vessels because of excessive costs under § 1042.850.

(b) We will maintain a list of available remanufacturing systems. A new remanufacturing system is considered to be available 120 days after we first issue a certificate of conformity for it. Where we issue a certificate of conformity based on carryover data for a system that is already considered to be available for the configuration, the 120-day delay does not apply and the new system is considered to be available when we issue the certificate.

(c) For the purpose of paragraph (a)(2) of this section, marginal cost means the difference in costs between remanufacturing the engine using the remanufacturing system and remanufacturing the engine conventionally, divided by the projected amount that PM emissions will be reduced over the engine’s useful life.

(1) Total costs include:

(i) Incremental hardware costs.

(ii) Incremental labor costs.

(iii) Incremental operating costs over one useful life period.

(iv) Other costs (such as shipping).

(2) Calculate the projected amount that PM emissions will be reduced over the engine’s useful life using the following equation:

$$\text{PM tons} = (\text{EF}_{\text{base}} - \text{EF}_{\text{cont}}) \times (\text{PR}) \times (\text{UL}) \times (\text{LF}) \times (10^{-6})$$

Where:

EF_{base} = deteriorated baseline PM emission rate (g/kW-hr).

EF_{cont} = deteriorated controlled PM emission rate (g/kW-hr).

PR = maximum engine power for the engine (kW).

UL = useful life (hr).

LF = the load factor that would apply for your engine under § 1042.705.

§ 1042.820 Emission standards and required emission reductions for remanufactured engines.

(a) The requirements of this section apply with respect to emissions as measured according to subpart F of this part. See paragraph (g) of this section for special provisions related to remanufacturing systems certified for both locomotive and marine engines.

Remanufactured Tier 2 and earlier engines may be certified under this subpart only if they have NO_x emissions equivalent to or less than baseline NO_x levels and PM emissions at least 25.0 percent less than baseline PM emission levels. See § 1042.825 for provisions for determining baseline NO_x and PM emissions. See § 1042.835 for provisions related to demonstrating compliance with these requirements.

(b) The NTE and ABT provisions of this part do not apply for remanufactured engines.

(c) The exhaust emission standards in this section apply for engines using the fuel type on which the engines in the engine family are designed to operate. Engines designed to operate using residual fuel must comply with the standards and requirements of this part when operated using residual fuel.

(d) Your engines must meet the exhaust emission standards of this section over their full useful life, as defined in § 1042.101(e).

(e) The duty-cycle emission standards in this subpart apply to all testing performed according to the procedures in § 1042.505, including certification, production-line, and in-use testing.

(f) Sections 1042.120, 1042.125, 1042.130, 1042.140 apply for remanufactured engines as written. Section 1042.115 applies for remanufactured engines as written, except for the requirement that electronically controlled engines broadcast their speed and output shaft torque.

(g) A remanufacturing system certified for locomotive engines under 40 CFR part 1033 may be deemed to also meet the requirements of this section, as specified in § 1042.836.

§ 1042.825 Baseline determination.

(a) For the purpose of this subpart, the term “baseline emissions” means the average measured emission rate specified by this section. Baseline emissions are specific to a given certificate holder and a given engine configuration.

(b) Select a used engine to be the emission-data engine for the engine

family for testing. Using good engineering judgment, select the engine configuration expected to represent the most common configuration in the family.

(c) Remanufacture the engine according to OEM specifications (or equivalent). The engine is considered “the baseline engine” at this point. If the OEM specifications include a range of adjustment for any parameter, set the parameter to the midpoint of the range. You may ask us to allow you to adjust it differently, consistent with good engineering judgment.

(d) Test the baseline engine four times according to the test procedures in subpart F of this part. The baseline emissions are the average of those four tests.

(e) We may require you to test a second engine of the same or different configuration in addition to the engine tested under this section. If we require you to test the same configuration, average the results of the testing with previous results, unless we determine that your previous results are not valid.

(f) Use good engineering judgment for all aspects of the baseline determination. We may reject your baseline if we determine that you did not use good engineering judgment, consistent with the provisions of 40 CFR 1068.5.

§ 1042.830 Labeling.

(a) At the time of remanufacture, affix a permanent and legible label identifying each engine. The label must be—

(1) Attached in one piece so it is not removable without being destroyed or defaced.

(2) Secured to a part of the engine needed for normal operation and not normally requiring replacement.

(3) Durable and readable for the engine’s entire useful life.

(4) Written in English.

(b) The label must—

(1) Include the heading “EMISSION CONTROL INFORMATION”.

(2) Include your full corporate name and trademark.

(3) Include EPA’s standardized designation for the engine family.

(4) State the engine’s category, displacement (in liters or L/cyl), maximum engine power (in kW), and power density (in kW/L) as needed to determine the emission standards for the engine family. You may specify displacement, maximum engine power, and power density as ranges consistent with the ranges listed in § 1042.101. See § 1042.140 for descriptions of how to specify per-cylinder displacement, maximum engine power, and power density.

(5) State: “THIS MARINE ENGINE COMPLIES WITH 40 CFR 1042, SUBPART I, FOR [CALENDAR YEAR OF REMANUFACTURE].”.

(c) You may add information to the emission control information label to identify other emission standards that the engine meets or does not meet (such as international standards). You may also add other information to ensure that the engine will be properly maintained and used.

(d) You may ask us to approve modified labeling requirements in this section if you show that it is necessary or appropriate. We will approve your request if your alternate label is consistent with the intent of the labeling requirements of this section.

§ 1042.835 Certification of remanufactured engines.

(a) *General requirements.* See §§ 1042.201, 1042.210, 1042.220, 1042.225, 1042.250, and 1042.255 for the general requirements related to obtaining a certificate of conformity. See § 1042.836 for special certification provisions for remanufacturing systems certified for locomotive engines under 40 CFR 1033.936.

(b) *Applications.* See § 1042.840 for a description of what you must include in your application.

(c) *Engine families.* See § 1042.845 for instruction about dividing your engines into engine families.

(d) *Test data.* (1) Measure baseline emissions for the test configuration as specified in § 1042.825.

(2) Measure emissions from the test engine for your remanufacturing system according to the procedures of subpart F of this part.

(3) We may measure emissions from any of your test engines or other engines from the engine family, as follows:

(i) We may decide to do the testing at your plant or any other facility. If we do this, you must deliver the test engine to a test facility we designate. The test engine you provide must include appropriate manifolds, aftertreatment devices, electronic control units, and other emission-related components not normally attached directly to the engine block. If we do the testing at your plant, you must schedule it as soon as possible and make available the instruments, personnel, and equipment we need.

(ii) If we measure emissions from one of your test engines, the results of that testing become the official emission results for the engine. Unless we later invalidate these data, we may decide not to consider your data in determining if your engine family meets applicable requirements.

(iii) Before we test one of your engines, we may set its adjustable parameters to any point within the specified adjustable ranges (see § 1042.115(d)).

(iv) Before we test one of your engines, we may calibrate it within normal production tolerances for anything we do not consider an adjustable parameter.

(4) You may ask to use emission data from a previous model year instead of doing new tests, but only if all the following are true:

(i) The engine family from the previous model year differs from the current engine family only with respect to model year or other characteristics unrelated to emissions. You may also ask to add a configuration subject to § 1042.225.

(ii) The emission-data engine from the previous model year remains the appropriate emission-data engine.

(iii) The data show that the emission-data engine would meet all the requirements that apply to the engine family covered by the application for certification.

(5) We may require you to test a second engine of the same or different configuration in addition to the engine tested under this section.

(6) If you use an alternate test procedure under 40 CFR 1065.10 and later testing shows that such testing does not produce results that are equivalent to the procedures specified in subpart F of this part, we may reject data you generated using the alternate procedure.

(e) *Demonstrating compliance.* (1) For purposes of certification, your engine family is considered in compliance with the emission standards in § 1042.820 if all emission-data engines representing that family have test results showing compliance with the standards and percent reductions required by that section. To compare emission levels from the emission-data engine with the applicable emission standards, apply an additive deterioration factor of 0.015 g/kW-hr to the measured emission levels for PM. Alternatively, you may test your engine as specified in § 1042.245 to develop deterioration factors that represent the deterioration expected in emissions over your engines' full useful life.

(2) Collect emission data using measurements to one more decimal place than the applicable standard. Apply the deterioration factor to the official emission result, then round the adjusted figure to the same number of decimal places as the emission standard. Compare the rounded

emission levels to the emission standard for each emission-data engine.

(3) Your applicable NO_x standard for each configuration is the baseline NO_x emission rate for that configuration plus 5.0 percent (to account for test-to-test and engine-to-engine variability). Your applicable PM standard for each configuration is the baseline PM emission rate for that configuration multiplied by 0.750 plus the deterioration factor. If you choose to include configurations in your engine family for which you do not measure baseline emissions, you must demonstrate through engineering analysis that your remanufacturing system will reduce PM emissions by at least 25.0 percent for those configurations and not increase NO_x emissions.

(4) Your engine family is deemed not to comply if any emission-data engine representing that family for certification has test results showing a deteriorated emission level above an applicable emission standard for any pollutant.

(f) *Safety Evaluation.* You must exercise due diligence in ensuring that your system will not adversely affect safety or otherwise violate the prohibition of § 1042.115(e).

(g) *Compatibility Evaluation.* If you are not the original manufacturer of the engine, you must contact the original manufacturer of the engine to verify that your system is compatible with the engine. Keep records of your contact with the original manufacturer.

§ 1042.836 Marine certification of locomotive remanufacturing systems.

If you certify a Tier 0, Tier 1, or Tier 2 remanufacturing system for locomotives under 40 CFR part 92 or part 1033, you may also certify the system under this part 1042, according to the provisions of this section.

(a) Include the following with your application for certification under 40 CFR part 1033:

(1) A statement of your intent to use your remanufacturing system for marine engines. Include a list of marine engine models for which your system may be used.

(2) If there are significant differences in how your remanufacture system will be applied to marine engines relative to locomotives, in an engineering analysis demonstrating that your system will achieve emission reductions from marine engines similar to those from locomotives.

(3) A description of modifications needed for marine applications.

(4) A demonstration of availability as described in § 1042.815, except that the

total marginal cost threshold does not apply.

(5) An unconditional statement that all the engines in the engine family comply with the requirements of this part, other referenced parts of the CFR, and the Clean Air Act.

(b) Sections 1042.835 and 1042.840 do not apply for engines certified under this section.

(c) Systems certified under 40 CFR part 92 are subject to the following restrictions:

(1) Tier 0 locomotives systems may not be used for any Category 1 engines or Tier 1 or later Category 2 engines.

(2) Where systems certified under 40 CFR part 1033 are also available for an engine, you may not use a system certified under 40 CFR part 92.

§ 1042.840 Application requirements for remanufactured engines.

This section specifies the information that must be in your application, unless we ask you to include less information under § 1042.201(c). We may require you to provide additional information to evaluate your application.

(a) Describe the engine family's specifications and other basic parameters of the engine's design and emission controls. List the fuel type on which your engines are designed to operate (for example, ultra low-sulfur diesel fuel). List each distinguishable engine configuration in the engine family. For each engine configuration, list the maximum engine power and the range of values for maximum engine power resulting from production tolerances, as described in § 1042.140.

(b) Explain how the emission control system operates. Describe in detail all system components for controlling exhaust emissions, including any auxiliary emission control devices (AECs) you add to the engine. Identify the part number of each component you describe.

(c) Summarize your cost effectiveness analysis used to demonstrate your system will meet the availability criteria of § 1042.815. Identify the maximum allowable costs for vessel modifications to meet these criteria.

(d) Describe the engines you selected for testing and the reasons for selecting them.

(e) Describe the test equipment and procedures that you used, including the duty cycle(s) and the corresponding engine applications. Also describe any special or alternate test procedures you used.

(f) Describe how you operated the emission-data engine before testing, including the duty cycle and the number of engine operating hours used

to stabilize emission levels. Explain why you selected the method of service accumulation. Describe any scheduled maintenance you did.

(g) List the specifications of the test fuel to show that it falls within the required ranges we specify in 40 CFR part 1065. See § 1042.801 if your certification is based on the use of special fuels or additives.

(h) Identify the engine family's useful life.

(i) Include the maintenance and warranty instructions you will give to the owner/operator (see §§ 1042.120 and 1042.125).

(j) Include the emission-related installation instructions you will provide if someone else installs your engines in a vessel (see § 1042.130).

(k) Describe your emission control information label (see § 1042.830).

(l) Identify the engine family's deterioration factors and describe how you developed them (see § 1042.245). Present any emission test data you used for this.

(m) State that you operated your emission-data engines as described in the application (including the test procedures, test parameters, and test fuels) to show you meet the requirements of this part.

(n) Present emission data for HC, NO_x, PM, and CO as required by § 1042.820. Show emission figures before and after applying adjustment factors for regeneration and deterioration factors for each pollutant and for each engine.

(o) Report all test results, including those from invalid tests, whether or not they were conducted according to the test procedures of subpart F of this part. If you measure CO₂, report those emission levels. We may ask you to send other information to confirm that your tests were valid under the requirements of this part and 40 CFR part 1065.

(p) Describe all adjustable operating parameters (see § 1042.115(d)), including production tolerances. Include the following in your description of each parameter:

(1) The nominal or recommended setting.

(2) The intended physically adjustable range.

(3) The limits or stops used to establish adjustable ranges.

(4) For Category 1 engines, information showing why the limits, stops, or other means of inhibiting adjustment are effective in preventing adjustment of parameters on in-use engines to settings outside your intended physically adjustable ranges.

(5) For Category 2 engines, propose a range of adjustment for each adjustable parameter, as described in § 1042.115(d). Include information showing why the limits, stops, or other means of inhibiting adjustment are effective in preventing adjustment of parameters on in-use engines to settings outside your proposed adjustable ranges.

(q) Unconditionally certify that all the engines in the engine family comply with the requirements of this part, other referenced parts of the CFR, and the Clean Air Act.

(r) Include the information required by other subparts of this part.

(s) Include other applicable information, such as information specified in this part or 40 CFR part 1068 related to requests for exemptions.

(t) Name an agent for service located in the United States. Service on this agent constitutes service on you or any of your officers or employees for any action by EPA or otherwise by the United States related to the requirements of this part.

(u) If you are not the original manufacturer of the engine, include a summary of your contact with the original manufacturer of the engine and provide to us any documentation provided to you by the original manufacturer.

§ 1042.845 Remanufactured engine families.

(a) For purposes of certification, divide your product line into families of engines that are expected to have similar emission characteristics throughout the useful life as described in this section. You may not group Category 1 and Category 2 engines in the same family.

(b) In general, group engines in the same engine family if they are the same in all the following aspects:

- (1) The combustion cycle and fuel (the fuels with which the engine is intended or designed to be operated).
- (2) The cooling system (for example, raw-water vs. separate-circuit cooling).
- (3) Method of air aspiration.
- (4) Method of exhaust aftertreatment (for example, catalytic converter or particulate trap).
- (5) Combustion chamber design.
- (6) Nominal bore and stroke.
- (7) Method of control for engine operation other than governing (i.e., mechanical or electronic).
- (8) Original engine manufacturer.

(c) Alternatively, you may ask us to allow you to include other engine configurations in your engine family, consistent with good engineering judgment.

(d) Do not include in your family any configurations for which good engineering judgment indicates that your emission controls are unlikely to provide PM emission reductions similar to the configuration(s) tested.

§ 1042.850 Exemptions and hardship relief.

This section describes exemption and hardship provisions that are available for owner/operators of engine subject to the provisions of this subpart.

(a) Vessels owned and operated by entities that meet the size criterion of this paragraph (a) are exempt from the requirements of this subpart I. To be exempt, your gross annual revenue for the calendar year before the remanufacture must be less than \$5,000,000 in 2008 dollars or the equivalent value for future years based on the Bureau of Labor Statistics' Producer Price Index (see www.bls.gov). Include all revenues from any parent company and its subsidiaries. The exemption applies only for years in which you meet this criterion.

(b) In unusual circumstances, we may exempt you from an otherwise applicable requirement that you apply a certified remanufacturing system when remanufacturing your marine engine.

(1) To be eligible, you must demonstrate that all of the following are true:

(i) Unusual circumstances prevent you from meeting requirements from this chapter.

(ii) You have taken all reasonable steps to minimize the extent of the nonconformity.

(iii) Not having the exemption will jeopardize the solvency of your company.

(iv) No other allowances are available under the regulations in this chapter to avoid the impending violation.

(2) Send the Designated Compliance Officer a written request for an exemption before you are in violation.

(3) We may impose other conditions, including provisions to use an engine meeting less stringent emission standards or to recover the lost environmental benefit.

(4) In determining whether to grant the exemptions, we will consider all relevant factors, including the following:

(i) The number of engines to be exempted.

(ii) The size of your company and your ability to endure the hardship.

(iii) The length of time a vessel is expected to remain in service.

(c) If you believe that a remanufacturing system that we identified as being available cannot be

installed without significant modification of your vessel, you may ask us to determine that a remanufacturing system is not considered available for your vessel because the cost would be excessive.

Subpart J—Definitions and Other Reference Information

§ 1042.901 Definitions.

The following definitions apply to this part. The definitions apply to all subparts unless we note otherwise. All undefined terms have the meaning the Clean Air Act gives to them. The definitions follow:

Adjustable parameter means any device, system, or element of design that someone can adjust (including those which are difficult to access) and that, if adjusted, may affect emissions or engine performance during emission testing or normal in-use operation. This includes, but is not limited to, parameters related to injection timing and fueling rate. You may ask us to exclude a parameter that is difficult to access if it cannot be adjusted to affect emissions without significantly degrading engine performance, or if you otherwise show us that it will not be adjusted in a way that affects emissions during in-use operation.

Aftertreatment means relating to a catalytic converter, particulate filter, or any other system, component, or technology mounted downstream of the exhaust valve (or exhaust port) whose design function is to decrease emissions in the engine exhaust before it is exhausted to the environment. Exhaust-gas recirculation and turbochargers are not aftertreatment.

Amphibious vehicle means a vehicle with wheels or tracks that is designed primarily for operation on land and secondarily for operation in water.

Annex VI Technical Code means the "Technical Code on Control of Emission of Nitrogen Oxides from Marine Diesel Engines, 1997," adopted by the International Maritime Organization (incorporated by reference in § 1042.910).

Applicable emission standard or applicable standard means an emission standard to which an engine is subject; or, where an engine has been or is being certified to another standard or FEL, applicable emission standards means the FEL and other standards to which the engine has been or is being certified. This definition does not apply to subpart H of this part.

Auxiliary emission control device means any element of design that senses temperature, vessel speed, engine RPM, transmission gear, or any other

parameter for the purpose of activating, modulating, delaying, or deactivating the operation of any part of the emission control system.

Base engine means a land-based engine to be marinized, as configured prior to marinization.

Baseline emissions has the meaning given in § 1042.825.

Brake power means the usable power output of the engine, not including power required to fuel, lubricate, or heat the engine, circulate coolant to the engine, or to operate aftertreatment devices.

Calibration means the set of specifications and tolerances specific to a particular design, version, or application of a component or assembly capable of functionally describing its operation over its working range.

Carryover means the process of obtaining a certificate for one model year using the same test data from the preceding model year, as described in § 1042.235(d). This generally requires that the locomotives in the engine family do not differ in any aspect related to emissions.

Category 1 means relating to a marine engine with specific engine displacement below 7.0 liters per cylinder.

Category 2 means relating to a marine engine with a specific engine displacement at or above 7.0 liters per cylinder but less than 30.0 liters per cylinder.

Category 3 means relating to a marine engine with a specific engine displacement at or above 30.0 liters per cylinder.

Certification means relating to the process of obtaining a certificate of conformity for an engine family that complies with the emission standards and requirements in this part.

Certified emission level means the highest deteriorated emission level in an engine family for a given pollutant from either transient or steady-state testing.

Clean Air Act means the Clean Air Act, as amended, 42 U.S.C. 7401–7671q.

Commercial means relating to an engine or vessel that is not a recreational marine engine or a recreational vessel.

Compression-ignition means relating to a type of reciprocating, internal-combustion engine that is not a spark-ignition engine. Note that marine engines powered by natural gas with maximum engine power at or above 250 kW are deemed to be compression-ignition engines in § 1042.1.

Constant-speed engine means an engine whose certification is limited to constant-speed operation. Engines whose constant-speed governor function

is removed or disabled are no longer constant-speed engines.

Constant-speed operation has the meaning given in 40 CFR 1065.1001.

Crankcase emissions means airborne substances emitted to the atmosphere from any part of the engine crankcase's ventilation or lubrication systems. The crankcase is the housing for the crankshaft and other related internal parts.

Critical emission-related component means any of the following components:

(1) Electronic control units, aftertreatment devices, fuel-metering components, EGR-system components, crankcase-ventilation valves, all components related to charge-air compression and cooling, and all sensors and actuators associated with any of these components.

(2) Any other component whose primary purpose is to reduce emissions.

Days means calendar days, unless otherwise specified. For example, where we specify working days, we mean calendar days excluding weekends and U.S. national holidays.

Designated Compliance Officer means the Manager, Heavy-Duty and Nonroad Engine Group (6403-J), U.S. Environmental Protection Agency, 1200 Pennsylvania Ave., NW., Washington, DC 20460.

Deteriorated emission level means the emission level that results from applying the appropriate deterioration factor to the official emission result of the emission-data engine.

Deterioration factor means the relationship between emissions at the end of useful life and emissions at the low-hour test point (or between highest and lowest emission levels, if applicable), expressed in one of the following ways:

(1) For multiplicative deterioration factors, the ratio of emissions at the end of useful life to emissions at the low-hour test point.

(2) For additive deterioration factors, the difference between emissions at the end of useful life and emissions at the low-hour test point.

Diesel fuel has the meaning given in 40 CFR 80.2. This generally includes No. 1 and No. 2 petroleum diesel fuels and biodiesel fuels.

Discrete-mode means relating to the discrete-mode type of steady-state test described in § 1042.505.

Emission control system means any device, system, or element of design that controls or reduces the emissions of regulated pollutants from an engine.

Emission-data engine means an engine that is tested for certification. This includes engines tested to establish deterioration factors.

Emission-related maintenance means maintenance that substantially affects emissions or is likely to substantially affect emission deterioration.

Engine has the meaning given in 40 CFR 1068.30. This includes complete and partially complete engines.

Engine configuration means a unique combination of engine hardware and calibration within an engine family. Engines within a single engine configuration differ only with respect to normal production variability.

Engine family has the meaning given in § 1042.230.

Engine manufacturer means a manufacturer of an engine. See the definition of “manufacturer” in this section.

Engineering analysis means a summary of scientific and/or engineering principles and facts that support a conclusion made by a manufacturer, with respect to compliance with the provisions of this part.

Excluded means relating to an engine that either:

(1) Has been determined not to be a nonroad engine, as specified in 40 CFR 1068.30; or

(2) Is a nonroad engine that, according to § 1042.5, is not subject to this part 1042.

Exempted has the meaning given in 40 CFR 1068.30.

Exhaust-gas recirculation means a technology that reduces emissions by routing exhaust gases that had been exhausted from the combustion chamber(s) back into the engine to be mixed with incoming air before or during combustion. The use of valve timing to increase the amount of residual exhaust gas in the combustion chamber(s) that is mixed with incoming air before or during combustion is not considered exhaust-gas recirculation for the purposes of this part.

Family emission limit (FEL) means an emission level declared by the manufacturer to serve in place of an otherwise applicable emission standard under the ABT program in subpart H of this part. The family emission limit must be expressed to the same number of decimal places as the emission standard it replaces. The family emission limit serves as the emission standard for the engine family with respect to all required testing.

Freshly manufactured marine engine means a new marine engine that has not been remanufactured. An engine becomes freshly manufactured when it is originally manufactured.

Foreign vessel means a vessel of foreign registry or a vessel operated

under the authority of a country other than the United States.

Fuel system means all components involved in transporting, metering, and mixing the fuel from the fuel tank to the combustion chamber(s), including the fuel tank, fuel tank cap, fuel pump, fuel filters, fuel lines, carburetor or fuel-injection components, and all fuel-system vents.

Fuel type means a general category of fuels such as gasoline, diesel fuel, residual fuel, or natural gas. There can be multiple grades within a single fuel type, such as high-sulfur or low-sulfur diesel fuel.

Good engineering judgment has the meaning given in 40 CFR 1068.30. See 40 CFR 1068.5 for the administrative process we use to evaluate good engineering judgment.

Green Engine Factor means a factor that is applied to emission measurements from a Category 2 engine that has had little or no service accumulation. The Green Engine Factor adjusts emission measurements to be equivalent to emission measurements from an engine that has had approximately 300 hours of use.

High-sulfur diesel fuel means one of the following:

(1) For in-use fuels, *high-sulfur diesel fuel* means a diesel fuel with a maximum sulfur concentration above 500 parts per million.

(2) For testing, *high-sulfur diesel fuel* has the meaning given in 40 CFR part 1065.

Hydrocarbon (HC) means the hydrocarbon group on which the emission standards are based for each fuel type, as described in § 1042.101(d).

Identification number means a unique specification (for example, a model number/serial number combination) that allows someone to distinguish a particular engine from other similar engines.

Low-hour means relating to an engine that has stabilized emissions and represents the undeteriorated emission level. This would generally involve less than 125 hours of operation for engines below 560 kW and less than 300 hours for engines at or above 560 kW.

Low-sulfur diesel fuel means one of the following:

(1) For in-use fuels, *low-sulfur diesel fuel* means a diesel fuel market as low-sulfur diesel fuel having a maximum sulfur concentration of 500 parts per million.

(2) For testing, *low-sulfur diesel fuel* has the meaning given in 40 CFR part 1065.

Manufacture means the physical and engineering process of designing,

constructing, and assembling an engine or a vessel.

Manufacturer has the meaning given in section 216(1) of the Clean Air Act (42 U.S.C. 7550(1)). In general, this term includes any person who manufactures an engine or vessel for sale in the United States or otherwise introduces a new marine engine into U.S. commerce. This includes importers who import engines or vessels for resale. It also includes post-manufacture marinizers, but not dealers. All manufacturing entities under the control of the same person are considered to be a single manufacturer.

Marine engine means a nonroad engine that is installed or intended to be installed on a marine vessel. This includes a portable auxiliary marine engine only if its fueling, cooling, or exhaust system is an integral part of the vessel. A fueling system is considered integral to the vessel only if one or more essential elements are permanently affixed to the vessel. There are two kinds of marine engines:

(1) Propulsion marine engine means a marine engine that moves a vessel through the water or directs the vessel's movement.

(2) Auxiliary marine engine means a marine engine not used for propulsion.

Marine vessel has the meaning given in 1 U.S.C. 3, except that it does not include amphibious vehicles. The definition in 1 U.S.C. 3 very broadly includes every craft capable of being used as a means of transportation on water.

Maximum engine power has the meaning given in § 1042.140.

Maximum test power means the power output observed at the maximum test speed with the maximum fueling rate possible.

Maximum test speed has the meaning given in 40 CFR 1065.1001.

Maximum test torque has the meaning given in 40 CFR 1065.1001.

Model year means one of the following things:

(1) For freshly manufactured marine engines (see definition of “new marine engine,” paragraph (1)), model year means one of the following:

(i) Calendar year.

(ii) Your annual new model production period if it is different than the calendar year. This must include January 1 of the calendar year for which the model year is named. It may not begin before January 2 of the previous calendar year and it must end by December 31 of the named calendar year.

(2) For an engine that is converted to a marine engine after originally being placed into service as a motor-vehicle

engine, a nonroad engine that is not a marine engine, or a stationary engine, model year means the calendar year in which the engine was converted (see definition of "new marine engine," paragraph (2)).

(3) For a marine engine excluded under § 1042.5 that is later converted to operate in an application that is not excluded, model year means the calendar year in which the engine was converted (see definition of "new marine engine," paragraph (3)).

(4) For engines that are not freshly manufactured but are installed in new vessels, model year means the calendar year in which the engine is installed in the new vessel (see definition of "new marine engine," paragraph (4)).

(5) For imported engines:

(i) For imported engines described in paragraph (5)(i) of the definition of "new marine engine," *model year* has the meaning given in paragraphs (1) through (4) of this definition.

(ii) For imported engines described in paragraph (5)(ii) of the definition of new marine engine," *model year* means the calendar year in which the engine is modified.

(iii) For imported engines described in paragraph (5)(iii) of the definition of "new marine engine," *model year* means the calendar year in which the importation occurs.

(6) For freshly manufactured vessels, model year means the calendar year in which the keel is laid or the vessel is at a similar stage of construction. For vessels that become new as a result of substantial modifications, model year means the calendar year in which the modifications physically begin.

(7) For remanufactured engines, model year means the calendar year in which the remanufacture takes place.

Motor vehicle has the meaning given in 40 CFR 85.1703(a).

New marine engine means any of the following things:

(1) A freshly manufactured marine engine for which the ultimate purchaser has never received the equitable or legal title. This kind of engine might commonly be thought of as "brand new." In the case of this paragraph (1), the engine is new from the time it is produced until the ultimate purchaser receives the title or the product is placed into service, whichever comes first.

(2) An engine intended to be installed in a vessel that was originally manufactured as a motor-vehicle engine, a nonroad engine that is not a marine engine, or a stationary engine. In this case, the engine is no longer a motor-vehicle, nonmarine, or stationary engine and becomes a "new marine engine." The engine is no longer new when it is placed into marine service.

(3) A marine engine that has been previously placed into service in an application we exclude under § 1042.5, where that engine is installed in a vessel that is covered by this part 1042. The engine is no longer new when it is placed into marine service covered by this part 1042. For example, this would apply to an engine that is no longer used in a foreign vessel.

(4) An engine not covered by paragraphs (1) through (3) of this definition that is intended to be installed in a new vessel. The engine is no longer new when the ultimate purchaser receives a title for the vessel or it is placed into service, whichever comes first. This generally includes installation of used engines in new vessels.

(5) A remanufactured marine engine. An engine becomes new when it is remanufactured (as defined in this section) and ceases to be new when placed back into service.

(6) An imported marine engine, subject to the following provisions:

(i) An imported marine engine covered by a certificate of conformity issued under this part that meets the criteria of one or more of paragraphs (1) through (4) of this definition, where the original engine manufacturer holds the certificate, is new as defined by those applicable paragraphs.

(ii) An imported remanufactured engine that would have been required to be certified if it had been remanufactured in the United States.

(iii) An imported engine that will be covered by a certificate of conformity issued under this part, where someone other than the original engine manufacturer holds the certificate (such as when the engine is modified after its initial assembly), is a new marine engine when it is imported. It is no longer new when the ultimate purchaser receives a title for the engine or it is placed into service, whichever comes first.

(iv) An imported marine engine that is not covered by a certificate of conformity issued under this part at the time of importation is new, but only if it was produced on or after the dates shown in the following table. This addresses uncertified engines and vessels initially placed into service that someone seeks to import into the United States. Importation of this kind of engine (or vessel containing such an engine) is generally prohibited by 40 CFR part 1068.

APPLICABILITY OF EMISSION STANDARDS FOR COMPRESSION-IGNITION MARINE ENGINES

Engine category and type	Power (kW)	Per-cylinder displacement (L/cyl)	Initial model year of emission standards
Category 1	P < 19	All	2000
Category 1	19 ≤ P < 37	All	1999
Category 1, Recreational	P ≥ 37	disp. < 0.9	2007
Category 1, Recreational	All	0.9 ≤ disp. < 2.5	2006
Category 1, Recreational	All	disp. ≥ 2.5	2004
Category 1, Commercial	P ≥ 37	disp. < 0.9	2005
Category 1, Commercial	All	disp. ≥ 0.9	2004
Category 2 and 3	All	disp. ≥ 5.0	2004

New vessel means any of the following:

(1) A vessel for which the ultimate purchaser has never received the equitable or legal title. The vessel is no longer new when the ultimate purchaser

receives this title or it is placed into service, whichever comes first.

(2) For vessels with no Category 3 engines, a vessel that has been modified such that the value of the modifications exceeds 50 percent of the value of the modified vessel, excluding temporary

modifications (as defined in this section). The value of the modification is the difference in the assessed value of the vessel before the modification and the assessed value of the vessel after the modification. The vessel is no longer new when it is placed into service. Use

the following equation to determine if the fractional value of the modification exceeds 50 percent:

$$\text{Percent of value} = \frac{[(\text{Value after modification}) - (\text{Value before modification})] \times 100\%}{(\text{Value after modification})}$$

(3) For vessels with Category 3 engines, a vessel that has undergone a modification that substantially alters the dimensions or carrying capacity of the vessel, changes the type of vessel, or substantially prolongs the vessel's life.

(4) An imported vessel that has already been placed into service, where it has an engine not covered by a certificate of conformity issued under this part at the time of importation that was manufactured after the requirements of this part start to apply (see § 1042.1).

Noncompliant engine means an engine that was originally covered by a certificate of conformity but is not in the certified configuration or otherwise does not comply with the conditions of the certificate.

Nonconforming engine means an engine not covered by a certificate of conformity that would otherwise be subject to emission standards.

Nonmethane hydrocarbon has the meaning given in 40 CFR 1065.1001. This generally means the difference between the emitted mass of total hydrocarbons and the emitted mass of methane.

Nonroad means relating to nonroad engines, or vessels, or equipment that include nonroad engines.

Nonroad engine has the meaning given in 40 CFR 1068.30. In general, this means all internal-combustion engines except motor vehicle engines, stationary engines, engines used solely for competition, or engines used in aircraft.

Official emission result means the measured emission rate for an emission-data engine on a given duty cycle before the application of any deterioration factor, but after the applicability of regeneration adjustment factors.

Operator demand has the meaning given in 40 CFR 1065.1001.

Owners manual means a document or collection of documents prepared by the engine manufacturer for the owner or operator to describe appropriate engine maintenance, applicable warranties, and any other information related to operating or keeping the engine. The owners manual is typically provided to the ultimate purchaser at the time of sale. The owners manual may be in paper or electronic format.

Oxides of nitrogen has the meaning given in 40 CFR 1065.1001.

Particulate trap means a filtering device that is designed to physically

trap particulate matter above a certain size.

Passenger means a person that provides payment as a condition of boarding a vessel. This does not include the owner or any paid crew members.

Placed into service means put into initial use for its intended purpose.

Point of first retail sale means the location at which the initial retail sale occurs. This generally means a vessel dealership or manufacturing facility, but may also include an engine seller or distributor in cases where loose engines are sold to the general public for uses such as replacement engines.

Post-manufacture marinizer means an entity that produces a marine engine by modifying a non-marine engine, whether certified or uncertified, complete or partially complete, where the entity is not controlled by the manufacturer of the base engine or by an entity that also controls the manufacturer of the base engine. In addition, vessel manufacturers that substantially modify marine engines are post-manufacture marinizers. For the purpose of this definition, "substantially modify" means changing an engine in a way that could change engine emission characteristics.

Power density has the meaning given in § 1042.140.

Ramped-modal means relating to the ramped-modal type of steady-state test described in § 1042.505.

Rated speed means the maximum full-load governed speed for governed engines and the speed of maximum power for ungoverned engines.

Recreational marine engine means a Category 1 propulsion marine engine that is intended by the manufacturer to be installed on a recreational vessel.

Recreational vessel means a vessel that is intended by the vessel manufacturer to be operated primarily for pleasure or leased, rented or chartered to another for the latter's pleasure. However, this does not include the following vessels:

(1) Vessels below 100 gross tons that carry more than 6 passengers.

(2) Vessels at or above 100 gross tons that carry one or more passengers.

(3) Vessels used solely for competition (see § 1042.620).

Remanufacture means to replace every cylinder liner in a commercial engine with maximum engine power at or above 600 kW, whether during a single maintenance event or cumulatively within a five-year period. For the purpose of this definition, "replace" includes removing, inspecting, and requalifying a liner. Rebuilding a recreational engine or an

engine with maximum engine power below 600 kW is not remanufacturing.

Remanufacture system or *remanufacturing system* means all components (or specifications for components) and instructions necessary to remanufacture an engine in accordance with applicable requirements of this part 1042.

Remanufacturer has the meaning given to "manufacturer" in section 216(1) of the Clean Air Act (42 U.S.C. 7550(1)) with respect to remanufactured marine engines. This term includes any person that is engaged in the manufacture or assembly of remanufactured engines, such as persons who:

(1) Design or produce the emission-related parts used in remanufacturing.

(2) Install parts in or on an existing engine to remanufacture it.

(3) Own or operate the engine and provide specifications as to how an engine is to be remanufactured (i.e., specifying who will perform the work, when the work is to be performed, what parts are to be used, or how to calibrate the adjustable parameters of the engine).

Residual fuel has the meaning given in 40 CFR 80.2. This generally includes all RM grades of marine fuel without regard to whether they are known commercially as residual fuel. For example, fuel marketed as intermediate fuel may be residual fuel.

Revoke has the meaning given in 40 CFR 1068.30. In general this means to terminate the certificate or an exemption for an engine family.

Round has the meaning given in 40 CFR 1065.1001.

Scheduled maintenance means adjusting, repairing, removing, disassembling, cleaning, or replacing components or systems periodically to keep a part or system from failing, malfunctioning, or wearing prematurely. It also may mean actions you expect are necessary to correct an overt indication of failure or malfunction for which periodic maintenance is not appropriate.

Small volume boat builder means a boat manufacturer with fewer than 500 employees and with annual worldwide production of fewer than 100 boats. For manufacturers owned by a parent company, these limits apply to the combined production and number of employees of the parent company and all its subsidiaries.

Small-volume engine manufacturer means a manufacturer with annual worldwide production of fewer than 1,000 internal combustion engines (marine and nonmarine). For manufacturers owned by a parent company, the limit applies to the

production of the parent company and all its subsidiaries.

Spark-ignition means relating to a gasoline-fueled engine or any other type of engine with a spark plug (or other sparking device) and with operating characteristics significantly similar to the theoretical Otto combustion cycle. Spark-ignition engines usually use a throttle to regulate intake air flow to control power during normal operation.

Specified adjustable range means a range of adjustment for an adjustable parameter that is approved as part of certification. Note that Category 1 engines must comply with emission standards over the full physically adjustable range for any adjustable parameters.

Steady-state has the meaning given in 40 CFR 1065.1001.

Sulfur-sensitive technology means an emission control technology that experiences a significant drop in emission control performance or emission-system durability when an engine is operated on low-sulfur fuel (i.e., fuel with a sulfur concentration of 300 to 500 ppm) as compared to when it is operated on ultra low-sulfur fuel (i.e., fuel with a sulfur concentration less than 15 ppm). Exhaust-gas recirculation is not a sulfur-sensitive technology.

Suspend has the meaning given in 40 CFR 1068.30. In general this means to temporarily discontinue the certificate or an exemption for an engine family.

Temporary modification means a modification to a vessel based on a written contract for marine services such that the modifications will be removed from the vessel when the contract expires. This provision is intended to address short-term contracts that would generally be less than 12 months in duration. You may ask us to consider modifications that will be in place longer than 12 months as temporary modifications.

Test engine means an engine in a test sample.

Test sample means the collection of engines selected from the population of an engine family for emission testing. This may include testing for certification, production-line testing, or in-use testing.

Tier 1 means relating to the Tier 1 emission standards, as shown in Appendix I.

Tier 2 means relating to the Tier 2 emission standards, as shown in Appendix I.

Tier 3 means relating to the Tier 3 emission standards, as shown in § 1042.101.

Tier 4 means relating to the Tier 4 emission standards, as shown in § 1042.101.

Total hydrocarbon has the meaning given in 40 CFR 1065.1001. This generally means the combined mass of organic compounds measured by the specified procedure for measuring total hydrocarbon, expressed as a hydrocarbon with an atomic hydrogen-to-carbon ratio of 1.85:1.

Total hydrocarbon equivalent has the meaning given in 40 CFR 1065.1001. This generally means the sum of the carbon mass contributions of non-oxygenated hydrocarbons, alcohols and aldehydes, or other organic compounds that are measured separately as contained in a gas sample, expressed as exhaust hydrocarbon from petroleum-fueled locomotives. The hydrogen-to-carbon ratio of the equivalent hydrocarbon is 1.85:1.

Ultimate purchaser means, with respect to any new vessel or new marine engine, the first person who in good faith purchases such new vessel or new marine engine for purposes other than resale.

Ultra low-sulfur diesel fuel means one of the following:

(1) For in-use fuels, *ultra low-sulfur diesel fuel* means a diesel fuel marketed as ultra low-sulfur diesel fuel having a maximum sulfur concentration of 15 parts per million.

(2) For testing, *ultra low-sulfur diesel fuel* has the meaning given in 40 CFR part 1065.

United States has the meaning given in 40 CFR 1068.30.

Upcoming model year means for an engine family the model year after the one currently in production.

U.S.-directed production volume means the number of engine units, subject to the requirements of this part, produced by a manufacturer for which the manufacturer has a reasonable assurance that sale was or will be made to ultimate purchasers in the United States.

Useful life means the period during which the engine is designed to properly function in terms of reliability and fuel consumption, without being remanufactured, specified as a number of hours of operation or calendar years, whichever comes first. It is the period during which a new engine is required to comply with all applicable emission standards. See § 1042.101(e).

Variable-speed engine means an engine that is not a constant-speed engine.

Vessel means a marine vessel.

Vessel operator means any individual that physically operates or maintains a

vessel or exercises managerial control over the operation of the vessel.

Vessel owner means the individual or company that holds legal title to a vessel.

Void has the meaning given in 40 CFR 1068.30. In general this means to invalidate a certificate or an exemption both retroactively and prospectively.

Volatile liquid fuel means any fuel other than diesel fuel or biodiesel that is a liquid at atmospheric pressure and has a Reid Vapor Pressure higher than 2.0 pounds per square inch.

We (us, our) means the Administrator of the Environmental Protection Agency and any authorized representatives.

§ 1042.905 Symbols, acronyms, and abbreviations.

The following symbols, acronyms, and abbreviations apply to this part:

ABT	Averaging, banking, and trading.
AECD	auxiliary-emission control device.
CFR	Code of Federal Regulations.
CO	carbon monoxide.
CO ₂	carbon dioxide.
cyl	cylinder.
disp.	displacement.
EPA	Environmental Protection Agency.
FEL	Family Emission Limit.
g	grams.
HC	hydrocarbon.
hr	hours.
kPa	kilopascals.
kW	kilowatts.
L	liters.
LTR	Limited Testing Region.
NARA	National Archives and Records Administration.
NMHC	nonmethane hydrocarbons.
NO _x	oxides of nitrogen (NO and NO ₂).
NTE	not-to-exceed.
PM	particulate matter.
RPM	revolutions per minute.
SAE	Society of Automotive Engineers.
SCR	selective catalytic reduction.
THC	total hydrocarbon.
THCE	total hydrocarbon equivalent.
ULSD	ultra low-sulfur diesel fuel.
U.S.C.	United States Code.

§ 1042.910 Reference materials.

Documents listed in this section have been incorporated by reference into this part. The Director of the Federal Register approved the incorporation by reference as prescribed in 5 U.S.C. 552(a) and 1 CFR part 51. Anyone may inspect copies at the U.S. EPA, Air and Radiation Docket and Information Center, 1301 Constitution Ave., NW., Room B102, EPA West Building, Washington, DC 20460 or at the National Archives and Records Administration (NARA). For information on the availability of this material at NARA, call 202-741-6030, or go to: http://www.archives.gov/federal_register/code_of_federal_regulations/ibr_locations.html.

(a) *SAE material.* Table 1 to this section lists material from the Society of Automotive Engineers that we have incorporated by reference. The first column lists the number and name of the material. The second column lists the sections of this part where we reference it. Anyone may purchase copies of these materials from the Society of Automotive Engineers, 400 Commonwealth Drive, Warrendale, PA 15096 or *www.sae.org*. Table 1 follows:

TABLE 1 TO §1042.910.—SAE MATERIALS

Document No. and name	Part 1042 reference
SAE J1930, Electrical/Electronic Systems Diagnostic Terms, Definitions, Abbreviations, and Acronyms, revised May 1998	1042.135

(b) *IMO material.* Table 2 to this section lists material from the International Maritime Organization that we have incorporated by reference. The first column lists the number and name of the material. The second column lists the section of this part where we reference it. Anyone may purchase copies of these materials from the International Maritime Organization, 4 Albert Embankment, London SE1 7SR, United Kingdom or *www.imo.org*. Table 2 follows:

TABLE 2 TO §1042.910.—IMO MATERIALS

Document No. and name	Part 1042 reference
Resolutions of the 1997 MARPOL Conference: Resolution 2—Technical Code on Control of Emission of Nitrogen Oxides from Marine Diesel Engines, 1997	1042.901

§ 1042.915 Confidential information.

(a) Clearly show what you consider confidential by marking, circling, bracketing, stamping, or some other method.

(b) We will store your confidential information as described in 40 CFR part 2. Also, we will disclose it only as specified in 40 CFR part 2. This applies both to any information you send us and to any information we collect from inspections, audits, or other site visits.

(c) If you send us a second copy without the confidential information, we will assume it contains nothing

confidential whenever we need to release information from it.

(d) If you send us information without claiming it is confidential, we may make it available to the public without further notice to you, as described in 40 CFR 2.204.

§ 1042.920 Hearings.

(a) You may request a hearing under certain circumstances, as described elsewhere in this part. To do this, you must file a written request, including a description of your objection and any supporting data, within 30 days after we make a decision.

(b) For a hearing you request under the provisions of this part, we will approve your request if we find that your request raises a substantial factual issue.

(c) If we agree to hold a hearing, we will use the procedures specified in 40 CFR part 1068, subpart G.

§ 1042.925 Reporting and recordkeeping requirements.

Under the Paperwork Reduction Act (44 U.S.C. 3501 et seq.), the Office of Management and Budget approves the reporting and recordkeeping specified in the applicable regulations. The following items illustrate the kind of reporting and recordkeeping we require for engines regulated under this part:

- (a) We specify the following requirements related to engine certification in this part 1042:
 - (1) In §1042.135 we require engine manufacturers to keep certain records related to duplicate labels sent to vessel manufacturers.
 - (2) In §1042.145 we state the requirements for interim provisions.
 - (3) In subpart C of this part we identify a wide range of information required to certify engines.
 - (4) In §§1042.345 and 1042.350 we specify certain records related to production-line testing.
 - (5) In subpart G of this part we identify several reporting and recordkeeping items for making demonstrations and getting approval related to various special compliance provisions.
 - (6) In §§1042.725, 1042.730, and 1042.735 we specify certain records related to averaging, banking, and trading.
 - (7) In subpart I of this part we specify certain records related to meeting requirements for remanufactured engines.
 - (b) We specify the following requirements related to testing in 40 CFR part 1065:

- (1) In 40 CFR 1065.2 we give an overview of principles for reporting information.
 - (2) In 40 CFR 1065.10 and 1065.12 we specify information needs for establishing various changes to published test procedures.
 - (3) In 40 CFR 1065.25 we establish basic guidelines for storing test information.
 - (4) In 40 CFR 1065.695 we identify data that may be appropriate for collecting during testing of in-use engines using portable analyzers.
 - (c) We specify the following requirements related to the general compliance provisions in 40 CFR part 1068:
 - (1) In 40 CFR 1068.5 we establish a process for evaluating good engineering judgment related to testing and certification.
 - (2) In 40 CFR 1068.25 we describe general provisions related to sending and keeping information.
 - (3) In 40 CFR 1068.27 we require manufacturers to make engines available for our testing or inspection if we make such a request.
 - (4) In 40 CFR 1068.105 we require vessel manufacturers to keep certain records related to duplicate labels from engine manufacturers.
 - (5) In 40 CFR 1068.120 we specify recordkeeping related to rebuilding engines.
 - (6) In 40 CFR part 1068, subpart C, we identify several reporting and recordkeeping items for making demonstrations and getting approval related to various exemptions.
 - (7) In 40 CFR part 1068, subpart D, we identify several reporting and recordkeeping items for making demonstrations and getting approval related to importing engines.
 - (8) In 40 CFR 1068.450 and 1068.455 we specify certain records related to testing production-line engines in a selective enforcement audit.
 - (9) In 40 CFR 1068.501 we specify certain records related to investigating and reporting emission-related defects.
 - (10) In 40 CFR 1068.525 and 1068.530 we specify certain records related to recalling nonconforming engines.
- Appendix I to Part 1042.—Summary of Previous Emission Standards**
- The following standards apply to compression-ignition marine engines produced before the model years specified in § 1042.1:
- (a) *Engines below 37 kW.* Tier 1 and Tier 2 standards for engines below 37 kW apply as specified in 40 CFR part 89 and summarized in the following table:

TABLE 1 TO APPENDIX I.—EMISSION STANDARDS FOR ENGINES BELOW 37 kW (G/KW-HR)

Rated power (kW)	Tier	Model year	NMHC + NO _x	CO	PM
kW<8	Tier 1	2000	10.5	8.0	1.0
	Tier 2	2005	7.5	8.0	0.80
8≤kW<19	Tier 1	2000	9.5	6.6	0.80
	Tier 2	2005	7.5	6.6	0.80
19≤kW<37	Tier 1	1999	9.5	5.5	0.8
	Tier 2	2004	7.5	5.5	0.6

(b) Engines at or above 37 kW. Tier 1 and Tier 2 standards for engines at or above 37 kW apply as specified in 40 CFR part 94 and summarized as follows:

(1) Tier 1 standards. NO_x emissions from model year 2004 and later engines with displacement of 2.5 or more liters per

cylinder may not exceed the following values:

(i) 17.0 g/kW-hr when maximum test speed is less than 130 rpm.

(ii) $45.0 \times N^{-0.20}$ when maximum test speed is at or above 130 but below 2000 rpm, where N is the maximum test speed of the engine in revolutions per minute. Round the

calculated standard to the nearest 0.1 g/kW-hr.

(ii) 9.8 g/kW-hr when maximum test speed is 2000 rpm or more.

(2) Tier 2 primary standards. Exhaust emissions may not exceed the values shown in the following table:

TABLE 2 TO APPENDIX I.—PRIMARY TIER 2 EMISSION STANDARDS FOR COMMERCIAL AND RECREATIONAL MARINE ENGINES AT OR ABOVE 37 kW (G/KW-HR)

Engine size liters/cylinder	Maximum engine power	Category	Model year	NO _x + THC g/kW-hr	CO g/kW-hr	PM g/kW-hr
disp. < 0.9	power ≥ 37 kW	Category 1 Commercial	2005	7.5	5.0	0.40
		Category 1 Recreational	2007	7.5	5.0	0.40
0.9 ≤ disp. < 1.2	All	Category 1 Commercial	2004	7.2	5.0	0.30
		Category 1 Recreational	2006	7.2	5.0	0.30
1.2 ≤ disp. < 2.5	All	Category 1 Commercial	2004	7.2	5.0	0.20
		Category 1 Recreational	2006	7.2	5.0	0.20
2.5 ≤ disp. < 5.0	All	Category 1 Commercial	2007	7.2	5.0	0.20
		Category 1 Recreational	2009	7.2	5.0	0.20
5.0 ≤ disp. < 15.0	All	Category 2	2007	7.8	5.0	0.27
		Category 2	2007	8.7	5.0	0.50
15.0 ≤ disp. < 20.0	power < 3300 kW	Category 2	2007	9.8	5.0	0.50
	power ≥ 3300 kW	Category 2	2007	9.8	5.0	0.50
20.0 ≤ disp. < 25.0	All	Category 2	2007	9.8	5.0	0.50
25.0 ≤ disp. < 30.0	All	Category 2	2007	11	5.0	0.5

(3) Tier 2 supplemental standards. Not-to-exceed emission standards apply for Tier 2 engines as specified in 40 CFR 94.8(e).

Appendix II to Part 1042—Steady-State Duty Cycles

(a) The following duty cycles apply as specified in § 1042.505(b)(1):

(1) The following duty cycle applies for discrete-mode testing:

E3 mode No.	Engine speed ¹	Percent of maximum test power	Weighting factors
1	Maximum test speed	100	0.2
2	91%	75	0.5
3	80%	50	0.15
4	63%	25	0.15

¹ Speed terms are defined in 40 CFR part 1065. Percent speed values are relative to maximum test speed.

(2) The following duty cycle applies for ramped-modal testing:

RMC mode	Time in mode (seconds)	Engine speed ^{1,3}	Power (percent) ^{2,3}
1a Steady-state	229	Maximum test speed	100%.
1b Transition	20	Linear transition	Linear transition in torque.
2a Steady-state	166	63%	25%.
2b Transition	20	Linear transition	Linear transition in torque.
3a Steady-state	570	91%	75%.
3b Transition	20	Linear transition	Linear transition in torque.
4a Steady-state	175	80%	50%.

¹ Speed terms are defined in 40 CFR part 1065. Percent speed is relative to maximum test speed.

² The percent power is relative to the maximum test power.

³ Advance from one mode to the next within a 20-second transition phase. During the transition phase, command a linear progression from the torque setting of the current mode to the torque setting of the next mode, and simultaneously command a similar linear progression for engine speed if there is a change in speed setting.

(b) The following duty cycles apply as specified in § 1042.505(b)(2):

(1) The following duty cycle applies for discrete-mode testing:

E5 mode No.	Engine speed ¹	Percent of maximum test power	Weighting factors
1	Maximum test speed	100	0.08
2	91%	75	0.13
3	80%	50	0.17
4	63%	25	0.32
5	Warm idle	0	0.3

¹ Speed terms are defined in 40 CFR part 1065. Percent speed values are relative to maximum test speed.

(2) The following duty cycle applies for ramped-modal testing:

RMC mode	Time in mode (seconds)	Engine speed ^{1,3}	Power (percent) ^{2,3}
1a Steady-state	167	Warm idle	0.
1b Transition	20	Linear transition	Linear transition in torque.
2a Steady-state	85	Maximum test speed	100%.
2b Transition	20	Linear transition	Linear transition in torque.
3a Steady-state	354	63%	25%.
3b Transition	20	Linear transition	Linear transition in torque.
4a Steady-state	141	91%	75%.
4b Transition	20	Linear transition	Linear transition in torque.
5a Steady-state	182	80%	50%.
5b Transition	20	Linear transition	Linear transition in torque.
6 Steady-state	171	Warm idle	0.

¹ Speed terms are defined in 40 CFR part 1065. Percent speed is relative to maximum test speed.

² The percent power is relative to the maximum test power.

³ Advance from one mode to the next within a 20-second transition phase. During the transition phase, command a linear progression from the torque setting of the current mode to the torque setting of the next mode, and simultaneously command a similar linear progression for engine speed if there is a change in speed setting.

(c) The following duty cycles apply as specified in § 1042.505(b)(3):

(1) The following duty cycle applies for discrete-mode testing:

E2 mode No.	Engine speed ¹	Torque (percent) ²	Weighting factors
1	Engine Governed	100	0.2
2	Engine Governed	75	0.5
3	Engine Governed	50	0.15
4	Engine Governed	25	0.15

¹ Speed terms are defined in 40 CFR part 1065.

² The percent torque is relative to the maximum test torque as defined in 40 CFR part 1065.

(2) The following duty cycle applies for ramped-modal testing:

RMC mode	Time in mode (seconds)	Engine speed	Torque (percent) ^{1,2}
1a Steady-state	234	Engine Governed	100%.
1b Transition	20	Engine Governed	Linear transition.
2a Steady-state	571	Engine Governed	25%.
2b Transition	20	Engine Governed	Linear transition.
3a Steady-state	165	Engine Governed	75%.
3b Transition	20	Engine Governed	Linear transition.
4a Steady-state	170	Engine Governed	50%.

¹ The percent torque is relative to the maximum test torque as defined in 40 CFR part 1065.

² Advance from one mode to the next within a 20-second transition phase. During the transition phase, command a linear progression from the torque setting of the current mode to the torque setting of the next mode.

Appendix III to Part 1042—Not-to-Exceed Zones

(a) The following definitions apply for this Appendix III:

(1) *Percent power* means the percentage of the maximum power achieved at Maximum Test Speed (or at Maximum Test Torque for constant-speed engines).

(2) *Percent speed* means the percentage of Maximum Test Speed.

(b) Figure 1 of this Appendix illustrates the default NTE zone for commercial marine engines certified using the duty cycle specified in § 1042.505(b)(1), except for variable-speed propulsion marine engines used with controllable-pitch propellers or with electrically coupled propellers, as follows:

(1) Subzone 1 is defined by the following boundaries:

(i) Percent power $\geq 0.7 \cdot (\text{percent speed})^{2.5}$.

(ii) Percent power $\leq (\text{percent speed}/0.9)^{3.5}$.
(iii) Percent power $\geq 3.0 \cdot (100\% - \text{percent speed})$.

(2) Subzone 2 is defined by the following boundaries:

(i) Percent power $\geq 0.7 \cdot (\text{percent speed})^{2.5}$.

(ii) Percent power $\leq (\text{percent speed}/0.9)^{3.5}$.

(iii) Percent power $< 3.0 \cdot (100\% - \text{percent speed})$.

(iv) Percent speed ≥ 70 percent.

BILLING CODE 6560-50-P

Figure 1 of Appendix III — NTE Zone and Subzones for Propeller-Law Commercial

Marine Engines

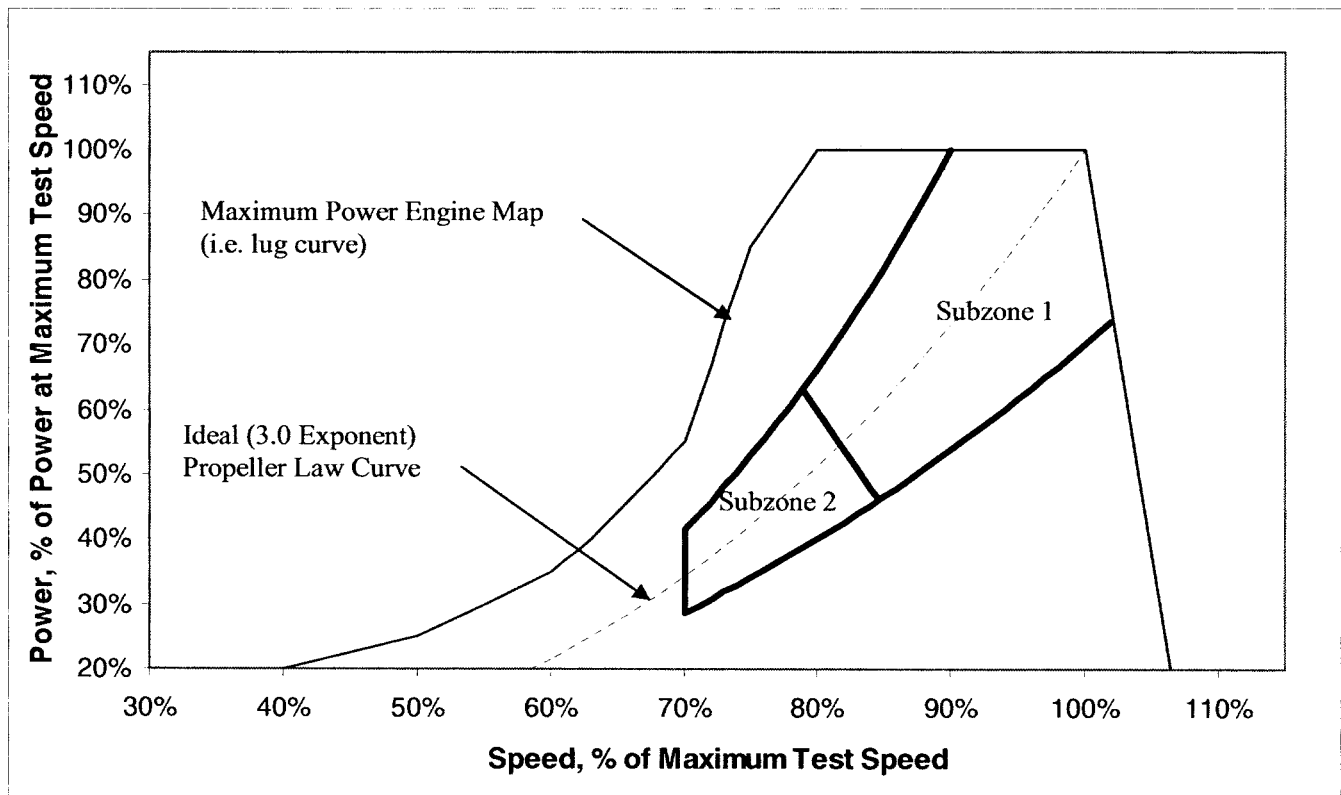

(c) Figure 2 of this Appendix illustrates the default NTE zone for recreational marine engines certified using the duty cycle specified in § 1042.505(b)(2), except for variable-speed marine engines used with controllable-pitch propellers or with electrically coupled propellers, as follows:

(1) Subzone 1 is defined by the following boundaries:

(i) Percent power $\geq 0.7 \cdot (\text{percent speed})^{2.5}$.
(ii) Percent power $\leq (\text{percent speed}/0.9)^{3.5}$.
(iii) Percent power $\geq 3.0 \cdot (100\% - \text{percent speed})$.

(iv) Percent power ≤ 95 percent.

(2) Subzone 2 is defined by the following boundaries:

(i) Percent power $\geq 0.7 \cdot (\text{percent speed})^{2.5}$.
(ii) Percent power $\leq (\text{percent speed}/0.9)^{3.5}$.

(iii) Percent power $< 3.0 \cdot (100\% - \text{percent speed})$.

(iv) Percent speed ≥ 70 percent.

(3) Subzone 3 is defined by the following boundaries:

(i) Percent power $\leq (\text{percent speed}/0.9)^{3.5}$.

(ii) Percent power > 95 percent.

Figure 2 of Appendix III — NTE Zone and Subzones for Propeller-Law Recreational

Marine Engines

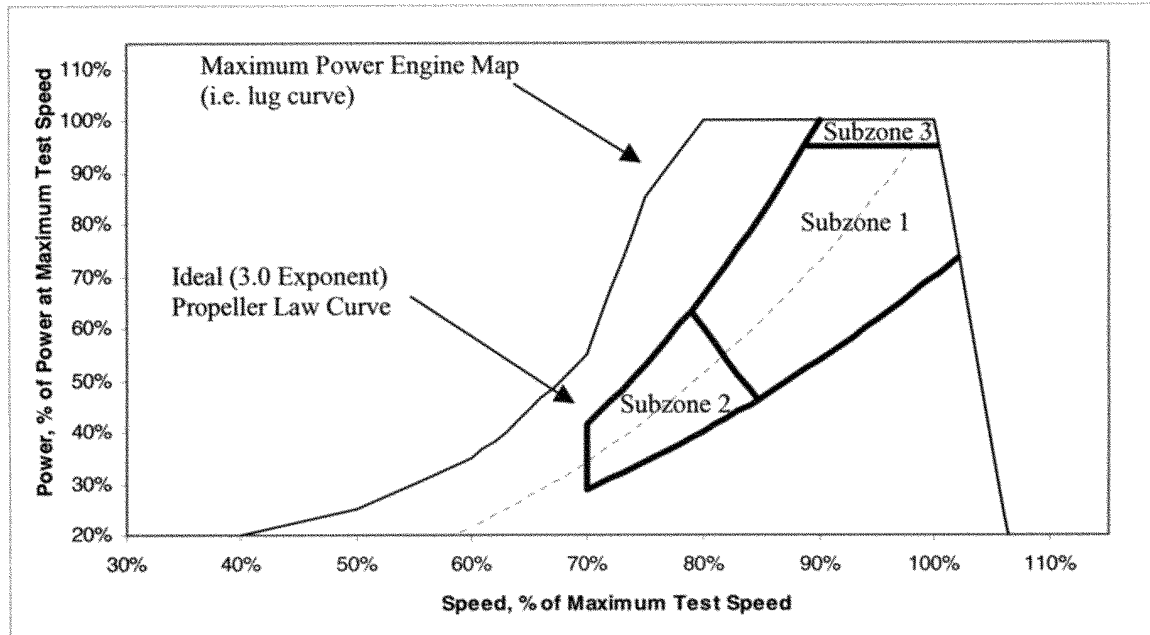

(d) Figure 3 of this Appendix illustrates the default NTE zone for variable-speed marine engines used with controllably-pitch propellers or with electrically coupled propellers that are certified using the duty cycle specified in § 1042.505(b)(1), (2), or (3), as follows:

(1) Subzone 1 is defined by the following boundaries:

- (i) Percent power $\geq 0.7 \cdot (\text{percent speed})^{2.5}$.

(ii) Percent power $\geq 3.0 \cdot (100\% - \text{percent speed})$.

(iii) Percent speed ≥ 78.9 percent.

(2) Subzone 2a is defined by the following boundaries:

(i) Percent power $\geq 0.7 \cdot (\text{percent speed})^{2.5}$.

(ii) Percent speed ≥ 70 percent.

(iii) Percent speed < 78.9 percent, for Percent power > 63.3 percent.

(iv) Percent power $< 3.0 \cdot (100\% - \text{percent speed})$, for Percent speed ≥ 78.9 percent.

(3) Subzone 2b is defined by the following boundaries:

(i) The line formed by connecting the following two points on a plot of speed-vs.-power:

(A) Percent speed = 70 percent; Percent power = 28.7 percent.

(B) Percent speed = 40 percent at governed speed; Percent power = 40 percent.

(ii) Percent power $< 0.7 \cdot (\text{percent speed})^{2.5}$.

Figure 3 of Appendix III – NTE Zone and Subzones for Variable-Pitch or Electronically

Coupled Engines*

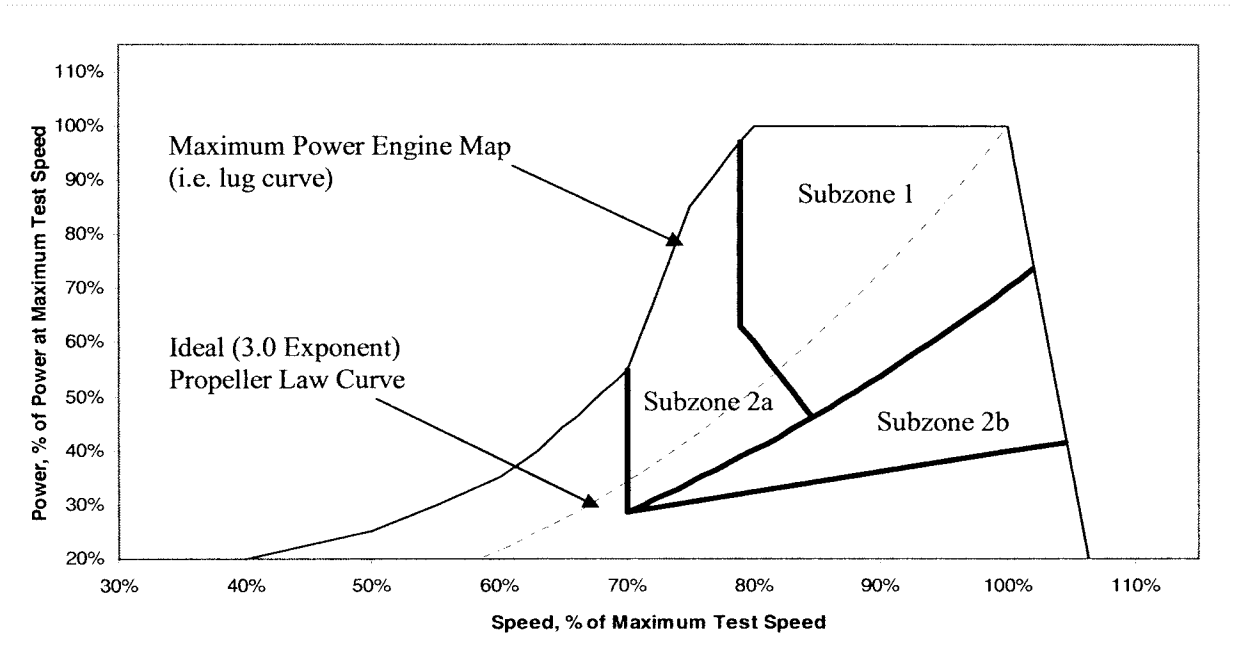

*shown for engines capable of operating on the E3 Duty Cycle

(e) Figure 4 of this Appendix illustrates the default NTE zone for constant-speed engines certified using a duty cycle specified in § 1042.505(b)(3) or (b)(4), as follows:

(1) Subzone 1 is defined by the following boundaries:

- (i) Percent power \geq 70 percent.
- (ii) [Reserved]

(2) Subzone 2 is defined by the following boundaries:

- (i) Percent power $<$ 70 percent.
- (ii) Percent power \geq 40 percent.

Figure 4 of Appendix III -- NTE Zone and Subzones for Constant-Speed Marine Engines

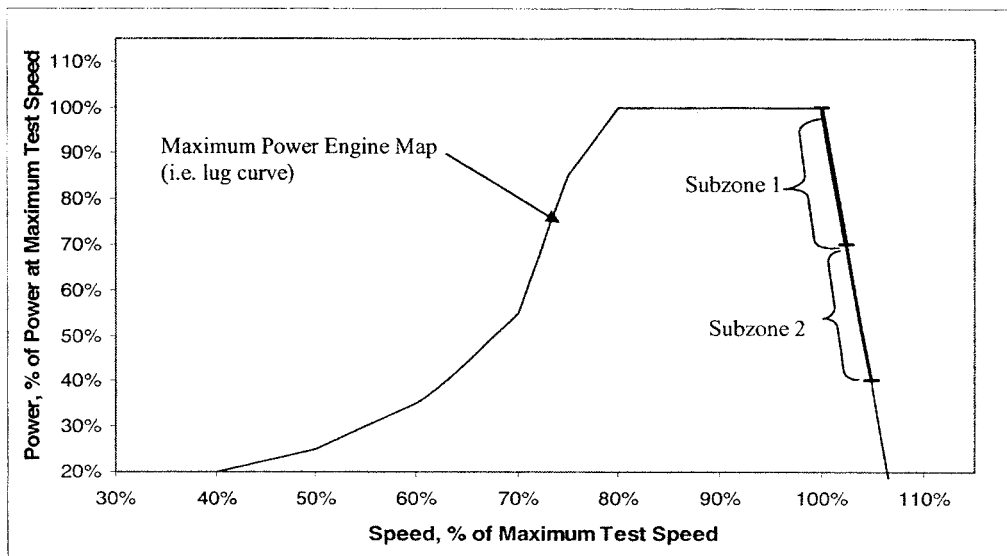

(f) Figure 5 of this Appendix illustrates the default NTE zone for variable-speed auxiliary marine engines certified using the duty cycle specified in § 1042.505(b)(5)(ii) or (iii), as follows:

(1) The default NTE zone is defined by the boundaries specified in 40 CFR 86.1370–2007(b)(1) and (2).

(2) A special PM subzone is defined in 40 CFR 1039.515(b).

Figure 5 of Appendix III — NTE Zone and Subzones for

Variable-Speed Auxiliary Marine Engines (nonpropeller-law)

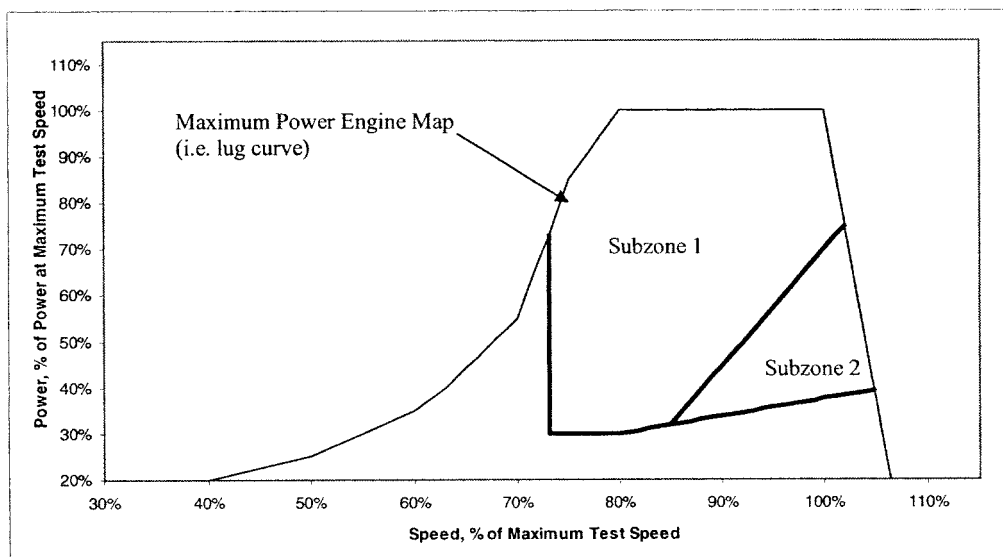

PART 1065—ENGINE-TESTING PROCEDURES

■ 45. The authority citation for part 1065 continues to read as follows:

Authority: 42 U.S.C. 7401–7671q.

Subpart A—[Amended]

■ 46. Section 1065.1 is revised to read as follows:

§ 1065.1 Applicability.

(a) This part describes the procedures that apply to testing we require for the following engines or for vehicles using the following engines:

(1) Locomotives we regulate under 40 CFR part 1033. For earlier model years, manufacturers may use the test procedures in this part or those specified in 40 CFR part 92 according to § 1065.10.

(2) Model year 2010 and later heavy-duty highway engines we regulate under 40 CFR part 86. For earlier model years, manufacturers may use the test procedures in this part or those specified in 40 CFR part 86, subpart N, according to § 1065.10.

(3) Nonroad diesel engines we regulate under 40 CFR part 1039 and stationary diesel engines that are certified to the standards in 40 CFR part

1039 as specified in 40 CFR part 60, subpart IIII. For earlier model years, manufacturers may use the test procedures in this part or those specified in 40 CFR part 89 according to § 1065.10.

(4) Marine diesel engines we regulate under 40 CFR part 1042. For earlier model years, manufacturers may use the test procedures in this part or those specified in 40 CFR part 94 according to § 1065.10.

(5) [Reserved]

(6) Large nonroad spark-ignition engines we regulate under 40 CFR part 1048, and stationary engines that are certified to the standards in 40 CFR part 1048 or as otherwise specified in 40 CFR part 60, subpart JJJJ.

(7) Vehicles we regulate under 40 CFR part 1051 (such as snowmobiles and off-highway motorcycles) based on engine testing. See 40 CFR part 1051, subpart F, for standards and procedures that are based on vehicle testing.

(8) [Reserved]

(b) The procedures of this part may apply to other types of engines, as described in this part and in the standard-setting part.

(c) The term “you” means anyone performing testing under this part other than EPA.

(1) This part is addressed primarily to manufacturers of engines, vehicles, equipment, and vessels, but it applies equally to anyone who does testing under this part for such manufacturers.

(2) This part applies to any manufacturer or supplier of test equipment, instruments, supplies, or any other goods or services related to the procedures, requirements, recommendations, or options in this part.

(d) Paragraph (a) of this section identifies the parts of the CFR that define emission standards and other requirements for particular types of engines. In this part, we refer to each of these other parts generically as the “standard-setting part.” For example, 40 CFR part 1051 is always the standard-setting part for snowmobiles and part 86 is the standard-setting part for heavy-duty highway engines.

(e) Unless we specify otherwise, the terms “procedures” and “test procedures” in this part include all aspects of engine testing, including the equipment specifications, calibrations, calculations, and other protocols and procedural specifications needed to measure emissions.

(f) For vehicles, equipment, or vessels subject to this part and regulated under

vehicle-based, equipment-based, or vessel-based standards, use good engineering judgment to interpret the term "engine" in this part to include vehicles, equipment, or vessels, where appropriate.

(g) For additional information regarding these test procedures, visit our Web site at www.epa.gov, and in particular <http://www.epa.gov/otaq/testingregs.htm>.

■ 47. Section 1065.2 is revised to read as follows:

§ 1065.2 Submitting information to EPA under this part.

(a) You are responsible for statements and information in your applications for certification, requests for approved procedures, selective enforcement audits, laboratory audits, production-line test reports, field test reports, or any other statements you make to us related to this part 1065.

(b) In the standard-setting part and in 40 CFR 1068.101, we describe your obligation to report truthful and complete information and the consequences of failing to meet this obligation. See also 18 U.S.C. 1001 and 42 U.S.C. 7413(c)(2).

(c) We may void any certificates or approvals associated with a submission of information if we find that you intentionally submitted false, incomplete, or misleading information. For example, if we find that you intentionally submitted incomplete information to mislead EPA when requesting approval to use alternate test procedures, we may void the certificates

for all engines families certified based on emission data collected using the alternate procedures. This would also apply if you ignore data from incomplete tests or from repeat tests with higher emission results.

(d) We may require an authorized representative of your company to approve and sign the submission, and to certify that all of the information submitted is accurate and complete. This includes everyone who submits information, including manufacturers and others.

(e) See 40 CFR 1068.10 for provisions related to confidential information. Note however that under 40 CFR 2.301, emission data is generally not eligible for confidential treatment.

(f) Nothing in this part should be interpreted to limit our ability under Clean Air Act section 208 (42 U.S.C. 7542) to verify that engines conform to the regulations.

■ 48. Section 1065.5 is revised to read as follows:

§ 1065.5 Overview of this part 1065 and its relationship to the standard-setting part.

(a) This part specifies procedures that apply generally to testing various categories of engines. See the standard-setting part for directions in applying specific provisions in this part for a particular type of engine. Before using this part's procedures, read the standard-setting part to answer at least the following questions:

(1) What duty cycles must I use for laboratory testing?

(2) Should I warm up the test engine before measuring emissions, or do I need to measure cold-start emissions during a warm-up segment of the duty cycle?

(3) Which exhaust gases do I need to measure?

(4) Do any unique specifications apply for test fuels?

(5) What maintenance steps may I take before or between tests on an emission-data engine?

(6) Do any unique requirements apply to stabilizing emission levels on a new engine?

(7) Do any unique requirements apply to test limits, such as ambient temperatures or pressures?

(8) Is field testing required or allowed, and are there different emission standards or procedures that apply to field testing?

(9) Are there any emission standards specified at particular engine-operating conditions or ambient conditions?

(10) Do any unique requirements apply for durability testing?

(b) The testing specifications in the standard-setting part may differ from the specifications in this part. In cases where it is not possible to comply with both the standard-setting part and this part, you must comply with the specifications in the standard-setting part. The standard-setting part may also allow you to deviate from the procedures of this part for other reasons.

(c) The following table shows how this part divides testing specifications into subparts:

TABLE 1 OF § 1065.5.—DESCRIPTION OF PART 1065 SUBPARTS

This subpart	Describes these specifications or procedures
Subpart A	Applicability and general provisions.
Subpart B	Equipment for testing.
Subpart C	Measurement instruments for testing.
Subpart D	Calibration and performance verifications for measurement systems.
Subpart E	How to prepare engines for testing, including service accumulation.
Subpart F	How to run an emission test over a predetermined duty cycle.
Subpart G	Test procedure calculations.
Subpart H	Fuels, engine fluids, analytical gases, and other calibration standards.
Subpart I	Special procedures related to oxygenated fuels.
Subpart J	How to test with portable emission measurement systems (PEMS).

■ 49. Section 1065.10 is amended by revising paragraphs (c)(1), (c)(2), (c)(6), and (c)(7) introductory text to read as follows:

§ 1065.10 Other procedures.

* * * * *

(c) * * *

(1) The objective of the procedures in this part is to produce emission measurements equivalent to those that would result from measuring emissions

during in-use operation using the same engine configuration as installed in a vehicle, equipment, or vessel. However, in unusual circumstances where these procedures may result in measurements that do not represent in-use operation, you must notify us if good engineering judgment indicates that the specified procedures cause unrepresentative emission measurements for your engines. Note that you need not notify us of unrepresentative aspects of the test

procedure if measured emissions are equivalent to in-use emissions. This provision does not obligate you to pursue new information regarding the different ways your engine might operate in use, nor does it obligate you to collect any other in-use information to verify whether or not these test procedures are representative of your engine's in-use operation. If you notify us of unrepresentative procedures under this paragraph (c)(1), we will cooperate

with you to establish whether and how the procedures should be appropriately changed to result in more representative measurements. While the provisions of this paragraph (c)(1) allow us to be responsive to issues as they arise, we would generally work toward making these testing changes generally applicable through rulemaking. We will allow reasonable lead time for compliance with any resulting change in procedures. We will consider the following factors in determining the importance of pursuing changes to the procedures:

(i) Whether supplemental emission standards or other requirements in the standard-setting part address the type of operation of concern or otherwise prevent inappropriate design strategies.

(ii) Whether the unrepresentative aspect of the procedures affect your ability to show compliance with the applicable emission standards.

(iii) The extent to which the established procedures require the use of emission-control technologies or strategies that are expected to ensure a comparable degree of emission control under the in-use operation that differs from the specified procedures.

(2) You may request to use special procedures if your engine cannot be tested using the specified procedures. For example, this may apply if your engine cannot operate on the specified duty cycle. In this case, tell us in writing why you cannot satisfactorily test your engine using this part's procedures and ask to use a different approach. We will approve your request if we determine that it would produce emission measurements that represent in-use operation and we determine that it can be used to show compliance with the requirements of the standard-setting part.

* * * * *

(6) During the 12 months following the effective date of any change in the provisions of this part 1065, you may use data collected using procedures specified in the previously applicable version of this part 1065. This paragraph (c)(6) does not restrict the use of carryover certification data otherwise allowed by the standard-setting part.

(7) You may request to use alternate procedures, or procedures that are more accurate or more precise than the allowed procedures. The following provisions apply to requests for alternate procedures:

* * * * *

■ 50. Section 1065.12 is amended by revising paragraphs (a) and (d)(1) to read as follows:

§ 1065.12 Approval of alternate procedures.

(a) To get approval for an alternate procedure under § 1065.10(c), send the Designated Compliance Officer an initial written request describing the alternate procedure and why you believe it is equivalent to the specified procedure. Anyone may request alternate procedure approval. This means that an individual engine manufacturer may request to use an alternate procedure. This also means that an instrument manufacturer may request to have an instrument, equipment, or procedure approved as an alternate procedure to those specified in this part. We may approve your request based on this information alone, or, as described in this section, we may ask you to submit to us in writing supplemental information showing that your alternate procedure is consistently and reliably at least as accurate and repeatable as the specified procedure.

* * * * *

(d) * * *

(1) *Theoretical basis.* Give a brief technical description explaining why you believe the proposed alternate procedure should result in emission measurements equivalent to those using the specified procedure. You may include equations, figures, and references. You should consider the full range of parameters that may affect equivalence. For example, for a request to use a different NO_x measurement procedure, you should theoretically relate the alternate detection principle to the specified detection principle over the expected concentration ranges for NO, NO₂, and interference gases. For a request to use a different PM measurement procedure, you should explain the principles by which the alternate procedure quantifies particulate mass similarly to the specified procedure.

* * * * *

■ 51. Section 1065.15 is amended by revising paragraphs (c)(1) and (e) and adding paragraph (f) to read as follows:

§ 1065.15 Overview of procedures for laboratory and field testing.

* * * * *

(c) * * *

(1) Engine operation. Engine operation is specified over a test interval. A test interval is the time over which an engine's total mass of emissions and its total work are determined. Refer to the standard-setting part for the specific test intervals that apply to each engine. Testing may involve measuring emissions and work in a laboratory-type environment or in the field, as described in paragraph (f) of this section.

* * * * *

(e) The following figure illustrates the allowed measurement configurations described in this part 1065:

BILLING CODE 6560-50-P

Figure 1 of §1065.15—Default test procedures and other specified procedures.

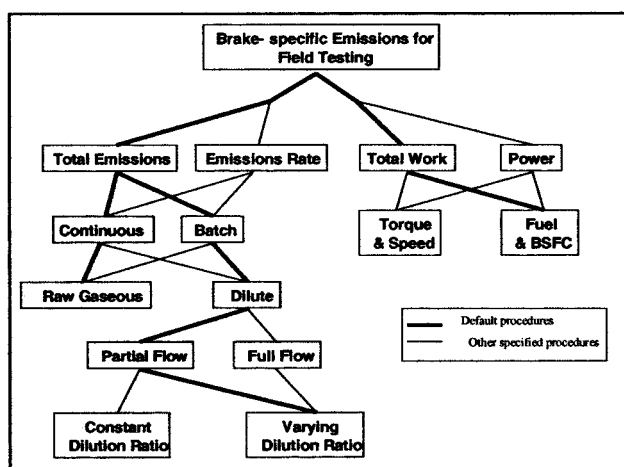
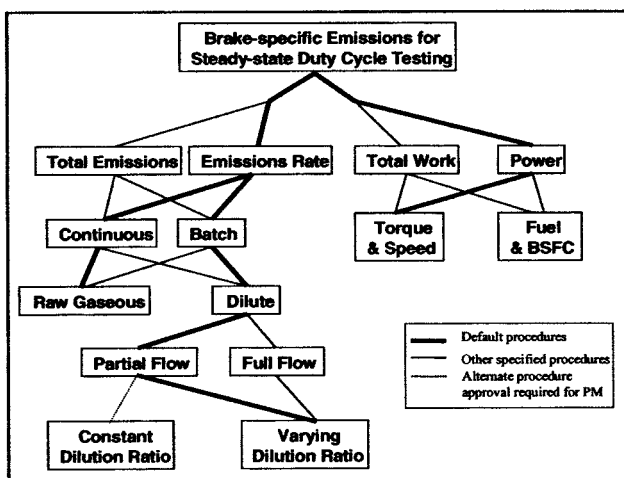
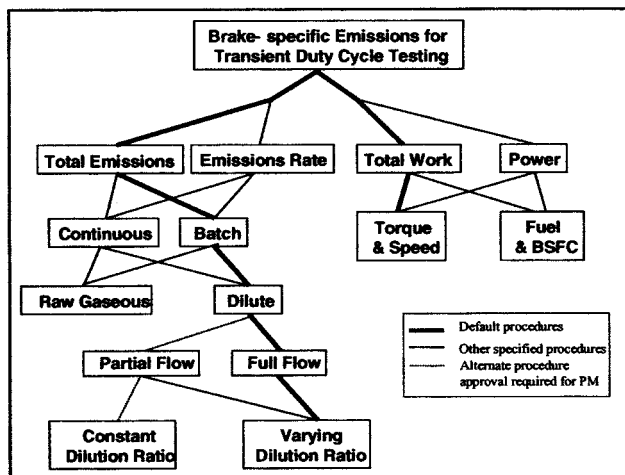

(f) This part 1065 describes how to test engines in a laboratory-type environment or in the field.

(1) This affects test intervals and duty cycles as follows:

(i) For laboratory testing, you generally determine brake-specific emissions for duty-cycle testing by using an engine dynamometer in a laboratory or other environment. This typically consists of one or more test intervals, each defined by a duty cycle, which is a sequence of modes, speeds, and/or torques (or powers) that an engine must follow. If the standard-setting part allows it, you may also simulate field testing with an engine dynamometer in a laboratory or other environment.

(ii) Field testing consists of normal in-use engine operation while an engine is installed in a vehicle, equipment, or vessel rather than following a specific engine duty cycle. The standard-setting part specifies how test intervals are defined for field testing.

(2) The type of testing may also affect what test equipment may be used. You may use "lab-grade" test equipment for any testing. The term "lab-grade" refers to equipment that fully conforms to the applicable specifications of this part. For some testing you may alternatively use "field-grade" equipment. The term "field-grade" refers to equipment that fully conforms to the applicable specifications of subpart J of this part, but does not fully conform to other specifications of this part. You may use "field-grade" equipment for field testing. We also specify in this part and in the standard-setting parts certain cases in which you may use "field-grade" equipment for testing in a laboratory-type environment. (Note: Although "field-grade" equipment is generally more portable than "lab-grade" test equipment, portability is not relevant to whether equipment is considered to be "field-grade" or "lab-grade".)

■ 52. Section 1065.20 is amended by revising paragraphs (a)(2), (b)(2), (f), and (g) to read as follows:

§ 1065.20 Units of measure and overview of calculations.

(a) * * *

(2) We designate brake-specific emissions in grams per kilowatt-hour (g/(kW·hr)), rather than the SI unit of grams per megajoule (g/MJ). In addition, we use the symbol hr to identify hour, rather than the SI convention of using h. This is based on the fact that engines are generally subject to emission standards expressed in g/kW·hr. If we specify engine standards in grams per horsepower-hour (g/(hp·hr)) in the

standard-setting part, convert units as specified in paragraph (d) of this section.

* * * * *

(b) * * *

(2) For all substances, cm³/m³, formerly ppm (volume).

* * * * *

(f) Interpretation of ranges. Interpret a range as a tolerance unless we explicitly identify it as an accuracy, repeatability, linearity, or noise specification. See § 1065.1001 for the definition of tolerance. In this part, we specify two types of ranges:

(1) Whenever we specify a range by a single value and corresponding limit values above and below that value, target any associated control point to that single value. Examples of this type of range include "± 10% of maximum pressure", or "(30 ± 10) kPa".

(2) Whenever we specify a range by the interval between two values, you may target any associated control point to any value within that range. An example of this type of range is "(40 to 50) kPa".

(g) Scaling of specifications with respect to an applicable standard. Because this part 1065 is applicable to a wide range of engines and emission standards, some of the specifications in this part are scaled with respect to an engine's applicable standard or maximum power. This ensures that the specification will be adequate to determine compliance, but not overly burdensome by requiring unnecessarily high-precision equipment. Many of these specifications are given with respect to a "flow-weighted mean" that is expected at the standard or during testing. Flow-weighted mean is the mean of a quantity after it is weighted proportional to a corresponding flow rate. For example, if a gas concentration is measured continuously from the raw exhaust of an engine, its flow-weighted mean concentration is the sum of the products of each recorded concentration times its respective exhaust flow rate, divided by the sum of the recorded flow rates. As another example, the bag concentration from a CVS system is the same as the flow-weighted mean concentration, because the CVS system itself flow-weights the bag concentration. Refer to § 1065.602 for information needed to estimate and calculate flow-weighted means. Wherever a specification is scaled to a value based upon an applicable standard, interpret the standard to be the family emission limit if the engine is certified under an emission credit program in the standard-setting part.

Subpart B—[Amended]

■ 53. Section 1065.101 is amended by revising paragraph (a) and adding paragraph (e) before the figures to read as follows:

§ 1065.101 Overview.

(a) This subpart specifies equipment, other than measurement instruments, related to emission testing. The provisions of this subpart apply for all engine dynamometer testing where engine speeds and loads are controlled to follow a prescribed duty cycle. See subpart J of this part to determine which of the provisions of this subpart apply for field testing. This equipment includes three broad categories—dynamometers, engine fluid systems (such as fuel and intake-air systems), and emission-sampling hardware.

* * * * *

(e) Dynamometer testing involves engine operation over speeds and loads that are controlled to a prescribed duty cycle. Field testing involves measuring emissions over normal in-use operation of a vehicle or piece of equipment. Field testing does not involve operating an engine over a prescribed duty cycle.

* * * * *

■ 54. Section 1065.110 is amended by revising paragraphs (a) introductory text and (e) and adding paragraphs (a)(1)(iv) and (f) to read as follows:

§ 1065.110 Work inputs and outputs, accessory work, and operator demand.

(a) Work. Use good engineering judgment to simulate all engine work inputs and outputs as they typically would operate in use. Account for work inputs and outputs during an emission test by measuring them; or, if they are small, you may show by engineering analysis that disregarding them does not affect your ability to determine the net work output by more than ± 0.5% of the net expected work output over the test interval. Use equipment to simulate the specific types of work, as follows:

(1) * * *

(iv) You may use any device that is already installed on a vehicle, equipment, or vessel to absorb work from the engine's output shaft(s). Examples of these types of devices include a vessel's propeller and a locomotive's generator.

* * * * *

(e) Operator demand for shaft work. Operator demand is defined in § 1065.1001. Command the operator demand and the dynamometer(s) to follow a prescribed duty cycle with set points for engine speed and torque as specified in § 1065.512. Refer to the

standard-setting part to determine the specifications for your duty cycle(s). Use a mechanical or electronic input to control operator demand such that the engine is able to meet the validation criteria in § 1065.514 over each applicable duty cycle. Record feedback values for engine speed and torque as specified in § 1065.512. Using good engineering judgment, you may improve control of operator demand by altering on-engine speed and torque controls. However, if these changes result in unrepresentative testing, you must notify us and recommend other test procedures under § 1065.10(c)(1).

(f) *Other engine inputs.* If your electronic control module requires specific input signals that are not available during dynamometer testing, such as vehicle speed or transmission signals, you may simulate the signals using good engineering judgment. Keep records that describe what signals you simulate and explain why these signals are necessary for representative testing.

■ 55. Section 1065.120 is amended by revising paragraph (a) to read as follows:

§ 1065.120 Fuel properties and fuel temperature and pressure.

(a) Use fuels as specified in the standard-setting part, or as specified in subpart H of this part if fuels are not specified in the standard-setting part.

* * * * *

■ 56. Section 1065.122 is amended by revising paragraphs (a) introductory text, (a)(1), and (c) to read as follows:

§ 1065.122 Engine cooling and lubrication.

(a) *Engine cooling.* Cool the engine during testing so its intake-air, oil, coolant, block, and head temperatures are within their expected ranges for normal operation. You may use auxiliary coolers and fans.

(1) For air-cooled engines only, if you use auxiliary fans you must account for work input to the fan(s) according to § 1065.110.

* * * * *

(c) *Lubricating oil.* Use lubricating oils specified in § 1065.740. For two-stroke engines that involve a specified mixture of fuel and lubricating oil, mix the lubricating oil with the fuel according to the manufacturer's specifications.

* * * * *

■ 57. Section 1065.125 is amended by revising paragraphs (c) and (d) and adding paragraph (e) to read as follows:

§ 1065.125 Engine intake air.

* * * * *

(c) Unless stated otherwise in the standard-setting part, maintain the temperature of intake air to (25 ± 5) °C,

as measured upstream of any engine component.

(d) Use an intake-air restriction that represents production engines. Make sure the intake-air restriction is between the manufacturer's specified maximum for a clean filter and the manufacturer's specified maximum allowed. Measure the static differential pressure of the restriction at the location and at the speed and torque set points specified by the manufacturer. If the manufacturer does not specify a location, measure this pressure upstream of any turbocharger or exhaust gas recirculation system connection to the intake air system. If the manufacturer does not specify speed and torque points, measure this pressure while the engine outputs maximum power. As the manufacturer, you are liable for emission compliance for all values up to the maximum restriction you specify for a particular engine.

(e) This paragraph (e) includes provisions for simulating charge-air cooling in the laboratory. This approach is described in paragraph (e)(1) of this section. Limits on using this approach are described in paragraphs (e)(2) and (3) of this section.

(1) Use a charge-air cooling system with a total intake-air capacity that represents production engines' in-use installation. Design any laboratory charge-air cooling system to minimize accumulation of condensate. Drain any accumulated condensate and completely close all drains before emission testing. Keep the drains closed during the emission test. Maintain coolant conditions as follows:

(i) Maintain a coolant temperature of at least 20 °C at the inlet to the charge-air cooler throughout testing.

(ii) At the engine conditions specified by the manufacturer, set the coolant flow rate to achieve an air temperature within ± 5 °C of the value specified by the manufacturer after the charge-air cooler's outlet. Measure the air-outlet temperature at the location specified by the manufacturer. Use this coolant flow rate set point throughout testing. If the engine manufacturer does not specify engine conditions or the corresponding charge-air cooler air outlet temperature, set the coolant flow rate at maximum engine power to achieve a charge-air cooler air outlet temperature that represents in-use operation.

(iii) If the engine manufacturer specifies pressure-drop limits across the charge-air cooling system, ensure that the pressure drop across the charge-air cooling system at engine conditions specified by the manufacturer is within the manufacturer's specified limit(s). Measure the pressure drop at the manufacturer's specified locations.

(2) The objective of this section is to produce emission results that are representative of in-use operation. If good engineering judgment indicates that the specifications in this section would result in unrepresentative testing (such as overcooling of the intake air), you may use more sophisticated setpoints and controls of charge-air pressure drop, coolant temperature, and flowrate to achieve more representative results.

(3) This approach does not apply for field testing. You may not correct measured emission levels from field testing to account for any differences caused by the simulated cooling in the laboratory.

■ 58. Section 1065.130 is revised to read as follows:

§ 1065.130 Engine exhaust.

(a) *General.* Use the exhaust system installed with the engine or one that represents a typical in-use configuration. This includes any applicable aftertreatment devices.

(b) *Aftertreatment configuration.* If you do not use the exhaust system installed with the engine, configure any aftertreatment devices as follows:

(1) Position any aftertreatment device so its distance from the nearest exhaust manifold flange or turbocharger outlet is within the range specified by the engine manufacturer in the application for certification. If this distance is not specified, position aftertreatment devices to represent typical in-use vehicle configurations.

(2) You may use exhaust tubing that is not from the in-use exhaust system upstream of any aftertreatment device that is of diameter(s) typical of in-use configurations. If you use exhaust tubing that is not from the in-use exhaust system upstream of any aftertreatment device, position each aftertreatment device according to paragraph (b)(1) of this section.

(c) *Sampling system connections.* Connect an engine's exhaust system to any raw sampling location or dilution stage, as follows:

(1) Minimize laboratory exhaust tubing lengths and use a total length of laboratory tubing of no more than 10 m or 50 outside diameters, whichever is greater. The start of laboratory exhaust tubing should be specified as the exit of the exhaust manifold, turbocharger outlet, last aftertreatment device, or the in-use exhaust system, whichever is furthest downstream. The end of laboratory exhaust tubing should be specified as the sample point, or first point of dilution. If laboratory exhaust tubing consists of several different outside tubing diameters, count the

number of diameters of length of each individual diameter, then sum all the diameters to determine the total length of exhaust tubing in diameters. Use the mean outside diameter of any converging or diverging sections of tubing. Use outside hydraulic diameters of any noncircular sections. For multiple stack configurations where all the exhaust stacks are combined, the start of the laboratory exhaust tubing may be taken at the last joint of where all the stacks are combined.

(2) You may install short sections of flexible laboratory exhaust tubing at any location in the engine or laboratory exhaust systems. You may use up to a combined total of 2 m or 10 outside diameters of flexible exhaust tubing.

(3) Insulate any laboratory exhaust tubing downstream of the first 25 outside diameters of length.

(4) Use laboratory exhaust tubing materials that are smooth-walled, electrically conductive, and not reactive with exhaust constituents. Stainless steel is an acceptable material.

(5) We recommend that you use laboratory exhaust tubing that has either a wall thickness of less than 2 mm or is air gap-insulated to minimize temperature differences between the wall and the exhaust.

(6) We recommend that you connect multiple exhaust stacks from a single engine into one stack upstream of any emission sampling. To ensure mixing of the multiple exhaust streams before emission sampling, you may configure the exhaust system with turbulence generators, such as orifice plates or fins, to achieve good mixing. We recommend a minimum Reynolds number, $Re\#$, of 4000 for the combined exhaust stream, where $Re\#$ is based on the inside diameter of the single stack. $Re\#$ is defined in § 1065.640.

(d) *In-line instruments.* You may insert instruments into the laboratory exhaust tubing, such as an in-line smoke meter. If you do this, you may leave a length of up to 5 outside diameters of laboratory exhaust tubing uninsulated on each side of each instrument, but you must leave a length of no more than 25 outside diameters of laboratory exhaust tubing uninsulated in total, including any lengths adjacent to in-line instruments.

(e) *Leaks.* Minimize leaks sufficiently to ensure your ability to demonstrate compliance with the applicable standards. We recommend performing a chemical balance of fuel, intake air, and exhaust according to § 1065.655 to verify exhaust system integrity.

(f) *Grounding.* Electrically ground the entire exhaust system.

(g) *Forced cooldown.* You may install a forced cooldown system for an exhaust aftertreatment device according to § 1065.530(a)(1)(i).

(h) *Exhaust restriction.* As the manufacturer, you are liable for emission compliance for all values up to the maximum restriction(s) you specify for a particular engine. Measure and set exhaust restriction(s) at the location(s) and at the engine speed and torque values specified by the manufacturer. Also, for variable-restriction aftertreatment devices, measure and set exhaust restriction(s) at the aftertreatment condition (degreening/aging and regeneration/loading level) specified by the manufacturer. If the manufacturer does not specify a location, measure this pressure downstream of any turbocharger. If the manufacturer does not specify speed and torque points, measure pressure while the engine produces maximum power. Use an exhaust-restriction setpoint that represents a typical in-use value, if available. If a typical in-use value for exhaust restriction is not available, set the exhaust restriction at (80 to 100)% of the maximum exhaust restriction specified by the manufacturer, or if the maximum is 5 kPa or less, the set point must be no less than 1.0 kPa from the maximum. For example, if the maximum back pressure is 4.5 kPa, do not use an exhaust restriction set point that is less than 3.5 kPa.

(i) *Open crankcase emissions.* If the standard-setting part requires measuring open crankcase emissions, you may either measure open crankcase emissions separately using a method that we approve in advance, or route open crankcase emissions directly into the exhaust system for emission measurement. If the engine is not already configured to route open crankcase emissions for emission measurement, route open crankcase emissions as follows:

(1) Use laboratory tubing materials that are smooth-walled, electrically conductive, and not reactive with crankcase emissions. Stainless steel is an acceptable material. Minimize tube lengths. We also recommend using heated or thin-walled or air gap-insulated tubing to minimize temperature differences between the wall and the crankcase emission constituents.

(2) Minimize the number of bends in the laboratory crankcase tubing and maximize the radius of any unavoidable bend.

(3) Use laboratory crankcase exhaust tubing that meets the engine

manufacturer's specifications for crankcase back pressure.

(4) Connect the crankcase exhaust tubing into the raw exhaust downstream of any aftertreatment system, downstream of any installed exhaust restriction, and sufficiently upstream of any sample probes to ensure complete mixing with the engine's exhaust before sampling. Extend the crankcase exhaust tube into the free stream of exhaust to avoid boundary-layer effects and to promote mixing. You may orient the crankcase exhaust tube's outlet in any direction relative to the raw exhaust flow.

■ 59. Section 1065.140 is revised to read as follows:

§ 1065.140 Dilution for gaseous and PM constituents.

(a) *General.* You may dilute exhaust with ambient air, synthetic air, or nitrogen. For gaseous emission measurement the diluent must be at least 15°C. Note that the composition of the diluent affects some gaseous emission measurement instruments' response to emissions. We recommend diluting exhaust at a location as close as possible to the location where ambient air dilution would occur in use.

(b) *Dilution-air conditions and background concentrations.* Before a diluent is mixed with exhaust, you may precondition it by increasing or decreasing its temperature or humidity. You may also remove constituents to reduce their background concentrations. The following provisions apply to removing constituents or accounting for background concentrations:

(1) You may measure constituent concentrations in the diluent and compensate for background effects on test results. See § 1065.650 for calculations that compensate for background concentrations.

(2) Either measure these background concentrations the same way you measure diluted exhaust constituents, or measure them in a way that does not affect your ability to demonstrate compliance with the applicable standards. For example, you may use the following simplifications for background sampling:

(i) You may disregard any proportional sampling requirements.

(ii) You may use unheated gaseous sampling systems.

(iii) You may use unheated PM sampling systems.

(iv) You may use continuous sampling if you use batch sampling for diluted emissions.

(v) You may use batch sampling if you use continuous sampling for diluted emissions.

(3) For removing background PM, we recommend that you filter all dilution air, including primary full-flow dilution air, with high-efficiency particulate air (HEPA) filters that have an initial minimum collection efficiency specification of 99.97% (see § 1065.1001 for procedures related to HEPA-filtration efficiencies). Ensure that HEPA filters are installed properly so that background PM does not leak past the HEPA filters. If you choose to correct for background PM without using HEPA filtration, demonstrate that the background PM in the dilution air contributes less than 50% to the net PM collected on the sample filter. You may correct net PM without restriction if you use HEPA filtration.

(c) *Full-flow dilution; constant-volume sampling (CVS)*. You may dilute the full flow of raw exhaust in a dilution tunnel that maintains a nominally constant volume flow rate, molar flow rate or mass flow rate of diluted exhaust, as follows:

(1) *Construction*. Use a tunnel with inside surfaces of 300 series stainless steel. Electrically ground the entire dilution tunnel. We recommend a thin-walled and insulated dilution tunnel to minimize temperature differences between the wall and the exhaust gases.

(2) *Pressure control*. Maintain static pressure at the location where raw exhaust is introduced into the tunnel within ± 1.2 kPa of atmospheric pressure. You may use a booster blower to control this pressure. If you test an engine using more careful pressure control and you show by engineering analysis or by test data that you require this level of control to demonstrate compliance at the applicable standards, we will maintain the same level of static pressure control when we test that engine.

(3) *Mixing*. Introduce raw exhaust into the tunnel by directing it downstream along the centerline of the tunnel. You may introduce a fraction of dilution air radially from the tunnel's inner surface to minimize exhaust interaction with the tunnel walls. You may configure the system with turbulence generators such as orifice plates or fins to achieve good mixing. We recommend a minimum Reynolds number, *Re*#, of 4000 for the diluted exhaust stream, where *Re*# is based on the inside diameter of the dilution tunnel. *Re*# is defined in § 1065.640.

(4) *Flow measurement preconditioning*. You may condition the diluted exhaust before measuring its flow rate, as long as this conditioning takes place downstream of any heated HC or PM sample probes, as follows:

(i) You may use flow straighteners, pulsation dampeners, or both of these.

(ii) You may use a filter.

(iii) You may use a heat exchanger to control the temperature upstream of any flow meter, but you must take steps to prevent aqueous condensation as described in paragraph (c)(6) of this section.

(5) *Flow measurement*. Section 1065.240 describes measurement instruments for diluted exhaust flow.

(6) *Aqueous condensation*. To ensure that you measure a flow that corresponds to a measured concentration, you may either prevent aqueous condensation between the sample probe location and the flow meter inlet in the dilution tunnel or you may allow aqueous condensation to occur and then measure humidity at the flow meter inlet. You may heat or insulate the dilution tunnel walls, as well as the bulk stream tubing downstream of the tunnel to prevent aqueous condensation. Calculations in § 1065.645 and § 1065.650 account for either method of addressing humidity in the diluted exhaust. Note that preventing aqueous condensation involves more than keeping pure water in a vapor phase (see § 1065.1001).

(7) *Flow compensation*. Maintain nominally constant molar, volumetric or mass flow of diluted exhaust. You may maintain nominally constant flow by either maintaining the temperature and pressure at the flow meter or by directly controlling the flow of diluted exhaust. You may also directly control the flow of proportional samplers to maintain proportional sampling. For an individual test, validate proportional sampling as described in § 1065.545.

(d) *Partial-flow dilution (PFD)*. Except as specified in this paragraph (d), you may dilute a partial flow of raw or previously diluted exhaust before measuring emissions. § 1065.240 describes PFD-related flow measurement instruments. PFD may consist of constant or varying dilution ratios as described in paragraphs (d)(2) and (3) of this section. An example of a constant dilution ratio PFD is a "secondary dilution PM" measurement system.

(1) *Applicability*. (i) You may not use PFD if the standard-setting part prohibits it.

(ii) You may use PFD to extract a proportional raw exhaust sample for any batch or continuous PM emission sampling over any transient duty cycle only if we have explicitly approved it according to § 1065.10 as an alternative procedure to the specified procedure for full-flow CVS.

(iii) You may use PFD to extract a proportional raw exhaust sample for any batch or continuous gaseous emission sampling.

(iv) You may use PFD to extract a proportional raw exhaust sample for any batch or continuous PM emission sampling over any steady-state duty cycle or its ramped-modal cycle (RMC) equivalent.

(v) You may use PFD to extract a proportional raw exhaust sample for any batch or continuous field-testing.

(vi) You may use PFD to extract a proportional diluted exhaust sample from a CVS for any batch or continuous emission sampling.

(vii) You may use PFD to extract a constant raw or diluted exhaust sample for any continuous emission sampling.

(2) *Constant dilution-ratio PFD*. Do one of the following for constant dilution-ratio PFD:

(i) Dilute an already proportional flow. For example, you may do this as a way of performing secondary dilution from a CVS tunnel to achieve overall dilution ratio for PM sampling.

(ii) Continuously measure constituent concentrations. For example, you might dilute to precondition a sample of raw exhaust to control its temperature, humidity, or constituent concentrations upstream of continuous analyzers. In this case, you must take into account the dilution ratio before multiplying the continuous concentration by the sampled exhaust flow rate.

(iii) Extract a proportional sample from a separate constant dilution ratio PFD system. For example, you might use a variable-flow pump to proportionally fill a gaseous storage medium such as a bag from a PFD system. In this case, the proportional sampling must meet the same specifications as varying dilution ratio PFD in paragraph (d)(3) of this section.

(iv) For each mode of a discrete-mode test (such as a locomotive notch setting or a specific setting for speed and torque), use a constant dilution ratio for any PM sampling. You must change the overall PM sampling system dilution ratio between modes so that the dilution ratio on the mode with the highest exhaust flow rate meets § 1065.140(e)(2) and the dilution ratios on all other modes is higher than this (minimum) dilution ratio by the ratio of the maximum exhaust flow rate to the exhaust flow rate of the corresponding other mode. This is the same dilution ratio requirement for RMC or field transient testing. You must account for this change in dilution ratio in your emission calculations.

(3) Varying dilution-ratio PFD. All the following provisions apply for varying dilution-ratio PFD:

(i) Use a control system with sensors and actuators that can maintain proportional sampling over intervals as short as 200 ms (i.e., 5 Hz control).

(ii) For control input, you may use any sensor output from one or more measurements; for example, intake-air flow, fuel flow, exhaust flow, engine speed, and intake manifold temperature and pressure.

(iii) Account for any emission transit time in the PFD system, as necessary.

(iv) You may use preprogrammed data if they have been determined for the specific test site, duty cycle, and test engine from which you dilute emissions.

(v) We recommend that you run practice cycles to meet the validation criteria in § 1065.545. Note that you must validate every emission test by meeting the validation criteria with the data from that specific test. Data from previously validated practice cycles or other tests may not be used to validate a different emission test.

(vi) You may not use a PFD system that requires preparatory tuning or calibration with a CVS or with the emission results from a CVS. Rather, you must be able to independently calibrate the PFD.

(e) *Dilution air temperature, dilution ratio, residence time, and temperature control of PM samples.* Dilute PM samples at least once upstream of transfer lines. You may dilute PM samples upstream of a transfer line using full-flow dilution, or partial-flow dilution immediately downstream of a PM probe. In the case of partial-flow dilution, you may have up to 26 cm of insulated length between the end of the probe and the dilution stage, but we recommend that the length be as short as practical. Configure dilution systems as follows:

(1) Set the diluent (i.e., dilution air) temperature to (25 ± 5) °C. Use good engineering judgment to select a location to measure this temperature. We recommend that you measure this temperature as close as practical upstream of the point where diluent mixes with raw exhaust.

(2) For any PM dilution system (i.e., CVS or PFD), dilute raw exhaust with diluent such that the minimum overall ratio of diluted exhaust to raw exhaust is within the range of (5:1–7:1) and is at least 2:1 for any primary dilution stage. Base this minimum value on the maximum engine exhaust flow rate for a given test interval. Either measure the maximum exhaust flow during a practice run of the test interval or

estimate it based on good engineering judgment (for example, you might rely on manufacturer-published literature).

(3) Configure any PM dilution system to have an overall residence time of (1 to 5) s, as measured from the location of initial diluent introduction to the location where PM is collected on the sample media. Also configure the system to have a residence time of at least 0.5 s, as measured from the location of final diluent introduction to the location where PM is collected on the sample media. When determining residence times within sampling system volumes, use an assumed flow temperature of 25 °C and pressure of 101.325 kPa.

(4) Control sample temperature to a (47 ± 5) °C tolerance, as measured anywhere within 20 cm upstream or downstream of the PM storage media (such as a filter). Measure this temperature with a bare-wire junction thermocouple with wires that are (0.500 ± 0.025) mm diameter, or with another suitable instrument that has equivalent performance. The intent of these specifications is to minimize heat transfer to or from the emissions sample prior to the final stage of dilution. This is accomplished by initially cooling the sample through dilution.

■ 60. Section 1065.145 is revised to read as follows:

§ 1065.145 Gaseous and PM probes, transfer lines, and sampling system components.

(a) *Continuous and batch sampling.* Determine the total mass of each constituent with continuous or batch sampling, as described in § 1065.15(c)(2). Both types of sampling systems have probes, transfer lines, and other sampling system components that are described in this section.

(b) *Gaseous and PM sample probes.* A probe is the first fitting in a sampling system. It protrudes into a raw or diluted exhaust stream to extract a sample, such that its inside and outside surfaces are in contact with the exhaust. A sample is transported out of a probe into a transfer line, as described in paragraph (c) of this section. The following provisions apply to sample probes:

(1) *Probe design and construction.* Use sample probes with inside surfaces of 300 series stainless steel or, for raw exhaust sampling, use any nonreactive material capable of withstanding raw exhaust temperatures. Locate sample probes where constituents are mixed to their mean sample concentration. Take into account the mixing of any crankcase emissions that may be routed into the raw exhaust. Locate each probe

to minimize interference with the flow to other probes. We recommend that all probes remain free from influences of boundary layers, wakes, and eddies—especially near the outlet of a raw-exhaust tailpipe where unintended dilution might occur. Make sure that purging or back-flushing of a probe does not influence another probe during testing. You may use a single probe to extract a sample of more than one constituent as long as the probe meets all the specifications for each constituent.

(2) *Probe installation on multi-stack engines.* We recommend combining multiple exhaust streams from multi-stack engines before emission sampling as described in § 1065.130(c)(6). If this is impractical, you may install symmetrical probes and transfer lines in each stack. In this case, each stack must be installed such that similar exhaust velocities are expected at each probe location. Use identical probe and transfer line diameters, lengths, and bends for each stack. Minimize the individual transfer line lengths, and manifold the individual transfer lines into a single transfer line to route the combined exhaust sample to analyzers and/or batch samplers. For PM sampling the manifold design must merge the individual sample streams with a maximum angle of 12.5° relative to the single sample stream's flow. Note that the manifold must meet the same specifications as the transfer line according to paragraph (c) of this section. If you use this probe configuration and you determine your exhaust flow rates with a chemical balance of exhaust gas concentrations and either intake air flow or fuel flow, then show by prior testing that the concentration of O₂ in each stack remains within 5% of the mean O₂ concentration throughout the entire duty cycle.

(3) *Gaseous sample probes.* Use either single-port or multi-port probes for sampling gaseous emissions. You may orient these probes in any direction relative to the raw or diluted exhaust flow. For some probes, you must control sample temperatures, as follows:

(i) For probes that extract NO_x from diluted exhaust, control the probe's wall temperature to prevent aqueous condensation.

(ii) For probes that extract hydrocarbons for THC or NMHC analysis from the diluted exhaust of compression-ignition engines, 2-stroke spark-ignition engines, or 4-stroke spark-ignition engines below 19 kW, we recommend heating the probe to minimize hydrocarbon contamination consistent with good engineering

judgment. If you routinely fail the contamination check in the 1065.520 pretest check, we recommend heating the probe section to approximately 190 °C to minimize contamination.

(4) *PM sample probes.* Use PM probes with a single opening at the end. Orient PM probes to face directly upstream. If you shield a PM probe's opening with a PM pre-classifier such as a hat, you may not use the preclassifier we specify in paragraph (e)(1) of this section. We recommend sizing the inside diameter of PM probes to approximate isokinetic sampling at the expected mean flow rate.

(c) *Transfer lines.* You may use transfer lines to transport an extracted sample from a probe to an analyzer, storage medium, or dilution system, noting certain restrictions for PM sampling in § 1065.140(e). Minimize the length of all transfer lines by locating analyzers, storage media, and dilution systems as close to probes as practical. We recommend that you minimize the number of bends in transfer lines and that you maximize the radius of any unavoidable bend. Avoid using 90° elbows, tees, and cross-fittings in transfer lines. Where such connections and fittings are necessary, take steps, using good engineering judgment, to ensure that you meet the temperature tolerances in this paragraph (c). This may involve measuring temperature at various locations within transfer lines and fittings. You may use a single transfer line to transport a sample of more than one constituent, as long as the transfer line meets all the specifications for each constituent. The following construction and temperature tolerances apply to transfer lines:

(1) *Gaseous samples.* Use transfer lines with inside surfaces of 300 series stainless steel, PTFE, Viton™, or any other material that you demonstrate has better properties for emission sampling. For raw exhaust sampling, use a non-reactive material capable of withstanding raw exhaust temperatures. You may use in-line filters if they do not react with exhaust constituents and if the filter and its housing meet the same temperature requirements as the transfer lines, as follows:

(i) For NO_x transfer lines upstream of either an NO₂-to-NO converter that meets the specifications of § 1065.378 or a chiller that meets the specifications of § 1065.376, maintain a sample temperature that prevents aqueous condensation.

(ii) For THC transfer lines for testing compression-ignition engines, 2-stroke spark-ignition engines, or 4-stroke spark-ignition engines below 19 kW, maintain a wall temperature tolerance

throughout the entire line of (191 ± 11) °C. If you sample from raw exhaust, you may connect an unheated, insulated transfer line directly to a probe. Design the length and insulation of the transfer line to cool the highest expected raw exhaust temperature to no lower than 191 °C, as measured at the transfer line's outlet. For dilute sampling, you may use a transition zone between the probe and transfer line of up to 92 cm to allow your wall temperature to transition to (191 ± 11) °C.

(2) *PM samples.* We recommend heated transfer lines or a heated enclosure to minimize temperature differences between transfer lines and exhaust constituents. Use transfer lines that are inert with respect to PM and are electrically conductive on the inside surfaces. We recommend using PM transfer lines made of 300 series stainless steel. Electrically ground the inside surface of PM transfer lines.

(d) *Optional sample-conditioning components for gaseous sampling.* You may use the following sample-conditioning components to prepare gaseous samples for analysis, as long as you do not install or use them in a way that adversely affects your ability to show that your engines comply with all applicable gaseous emission standards.

(1) *NO₂-to-NO converter.* You may use an NO₂-to-NO converter that meets the efficiency-performance check specified in § 1065.378 at any point upstream of a NO_x analyzer, sample bag, or other storage medium.

(2) *Sample dryer.* You may use either type of sample dryer described in this paragraph (d)(2) to decrease the effects of water on gaseous emission measurements. You may not use a chemical dryer, or use dryers upstream of PM sample filters.

(i) *Osmotic-membrane.* You may use an osmotic-membrane dryer upstream of any gaseous analyzer or storage medium, as long as it meets the temperature specifications in paragraph (c)(1) of this section. Because osmotic-membrane dryers may deteriorate after prolonged exposure to certain exhaust constituents, consult with the membrane manufacturer regarding your application before incorporating an osmotic-membrane dryer. Monitor the dewpoint, T_{dew} , and absolute pressure, p_{total} , downstream of an osmotic-membrane dryer. You may use continuously recorded values of T_{dew} and p_{total} in the amount of water calculations specified in § 1065.645. If you do not continuously record these values, you may use their peak values observed during a test or their alarm setpoints as constant values in the calculations specified in § 1065.645.

You may also use a nominal p_{total} , which you may estimate as the dryer's lowest absolute pressure expected during testing.

(ii) *Thermal chiller.* You may use a thermal chiller upstream of some gas analyzers and storage media. You may not use a thermal chiller upstream of a THC measurement system for compression-ignition engines, 2-stroke spark-ignition engines, or 4-stroke spark-ignition engines below 19 kW. If you use a thermal chiller upstream of an NO₂-to-NO converter or in a sampling system without an NO₂-to-NO converter, the chiller must meet the NO₂ loss-performance check specified in § 1065.376. Monitor the dewpoint, T_{dew} , and absolute pressure, p_{total} , downstream of a thermal chiller. You may use continuously recorded values of T_{dew} and p_{total} in the emission calculations specified in § 1065.650. If you do not continuously record these values, you may use the maximum temperature and minimum pressure values observed during a test or the high alarm temperature setpoint and the low alarm pressure setpoint as constant values in the amount of water calculations specified in § 1065.645. You may also use a nominal p_{total} , which you may estimate as the dryer's lowest absolute pressure expected during testing. If it is valid to assume the degree of saturation in the thermal chiller, you may calculate T_{dew} based on the known chiller performance and continuous monitoring of chiller temperature, T_{chiller} . If you do not continuously record values of T_{chiller} , you may use its peak value observed during a test, or its alarm setpoint, as a constant value to determine a constant amount of water according to § 1065.645. If it is valid to assume that T_{chiller} is equal to T_{dew} , you may use T_{chiller} in lieu of T_{dew} according to § 1065.645. If it is valid to assume a constant temperature offset between T_{chiller} and T_{dew} , due to a known and fixed amount of sample reheat between the chiller outlet and the temperature measurement location, you may factor in this assumed temperature offset value into emission calculations. If we ask for it, you must show by engineering analysis or by data the validity of any assumptions allowed by this paragraph (d)(2)(ii).

(3) *Sample pumps.* You may use sample pumps upstream of an analyzer or storage medium for any gas. Use sample pumps with inside surfaces of 300 series stainless steel, PTFE, or any other material that you demonstrate has better properties for emission sampling. For some sample pumps, you must control temperatures, as follows:

(i) If you use a NO_x sample pump upstream of either an NO₂-to-NO converter that meets § 1065.378 or a chiller that meets § 1065.376, it must be heated to prevent aqueous condensation.

(ii) For testing compression-ignition engines, 2-stroke spark-ignition engines, or 4-stroke spark-ignition engines below 19 kW, if you use a THC sample pump upstream of a THC analyzer or storage medium, its inner surfaces must be heated to a tolerance of (191 ± 11) °C.

(4) *Ammonia Scrubber*. You may use ammonia scrubbers for any or all gaseous sampling systems to prevent interference with NH₃, poisoning of the NO₂-to-NO converter, and deposits in the sampling system or analyzers. Follow the ammonia scrubber manufacturer's recommendations or use good engineering judgment in applying ammonia scrubbers.

(e) *Optional sample-conditioning components for PM sampling*. You may use the following sample-conditioning components to prepare PM samples for analysis, as long as you do not install or use them in a way that adversely affects your ability to show that your engines comply with the applicable PM emission standards. You may condition PM samples to minimize positive and negative biases to PM results, as follows:

(1) *PM preclassifier*. You may use a PM preclassifier to remove large-diameter particles. The PM preclassifier may be either an inertial impactor or a cyclonic separator. It must be constructed of 300 series stainless steel. The preclassifier must be rated to remove at least 50% of PM at an aerodynamic diameter of 10 μm and no more than 1% of PM at an aerodynamic diameter of 1 μm over the range of flow rates for which you use it. Follow the preclassifier manufacturer's instructions for any periodic servicing that may be necessary to prevent a buildup of PM. Install the preclassifier in the dilution system downstream of the last dilution stage. Configure the preclassifier outlet with a means of bypassing any PM sample media so the preclassifier flow may be stabilized before starting a test. Locate PM sample media within 75 cm downstream of the preclassifier's exit. You may not use this preclassifier if you use a PM probe that already has a preclassifier. For example, if you use a hat-shaped preclassifier that is located immediately upstream of the probe in such a way that it forces the sample flow to change direction before entering the probe, you may not use any other preclassifier in your PM sampling system.

(2) *Other components*. You may request to use other PM conditioning

components upstream of a PM preclassifier, such as components that condition humidity or remove gaseous-phase hydrocarbons from the diluted exhaust stream. You may use such components only if we approve them under § 1065.10.

■ 61. Section 1065.170 is amended by revising the introductory text and paragraphs (a) and (c)(1) to read as follows:

§ 1065.170 Batch sampling for gaseous and PM constituents.

Batch sampling involves collecting and storing emissions for later analysis. Examples of batch sampling include collecting and storing gaseous emissions in a bag or collecting and storing PM on a filter. You may use batch sampling to store emissions that have been diluted at least once in some way, such as with CVS, PFD, or BMD. You may use batch-sampling to store undiluted emissions.

(a) *Sampling methods*. If you extract from a constant-volume flow rate, sample at a constant-volume flow rate as follows:

(1) Validate proportional sampling after an emission test as described in § 1065.545. Use good engineering judgment to select storage media that will not significantly change measured emission levels (either up or down). For example, do not use sample bags for storing emissions if the bags are permeable with respect to emissions or if they offgas emissions to the extent that it affects your ability to demonstrate compliance with the applicable gaseous emission standards. As another example, do not use PM filters that irreversibly absorb or adsorb gases to the extent that it affects your ability to demonstrate compliance with the applicable PM emission standard.

(2) You must follow the requirements in § 1065.140(e)(2) related to PM dilution ratios. For each filter, if you expect the net PM mass on the filter to exceed 400 μg, assuming a 38 mm diameter filter stain area, you may take the following actions in sequence:

(i) First, reduce filter face velocity as needed to target a filter loading of 400 μg, down to 50 cm/s or less.

(ii) Then, for discrete-mode testing only, you may reduce sample time as needed to target a filter loading of 400 μg, but not below the minimum sample time specified in the standard-setting part.

(iii) Then, increase overall dilution ratio above the values specified in § 1065.140(e)(2) to target a filter loading of 400 μg.

* * * * *

(c) * * *

(1) If you use filter-based sampling media to extract and store PM for measurement, your procedure must meet the following specifications:

(i) If you expect that a filter's total surface concentration of PM will exceed 400 μg, assuming a 38 mm diameter filter stain area, for a given test interval, you may use filter media with a minimum initial collection efficiency of 98%; otherwise you must use a filter media with a minimum initial collection efficiency of 99.7%.

Collection efficiency must be measured as described in ASTM D2986–95a (incorporated by reference in § 1065.1010), though you may rely on the sample-media manufacturer's measurements reflected in their product ratings to show that you meet this requirement.

(ii) The filter must be circular, with an overall diameter of 46.50 ± 0.6 mm and an exposed diameter of at least 38 mm. See the cassette specifications in paragraph (c)(1)(vii) of this section.

(iii) We highly recommend that you use a pure PTFE filter material that does not have any flow-through support bonded to the back and has an overall thickness of 40 ± 20 μm. An inert polymer ring may be bonded to the periphery of the filter material for support and for sealing between the filter cassette parts. We consider Polymethylpentene (PMP) and PTFE inert materials for a support ring, but other inert materials may be used. See the cassette specifications in paragraph (c)(1)(vii) of this section. We allow the use of PTFE-coated glass fiber filter material, as long as this filter media selection does not affect your ability to demonstrate compliance with the applicable standards, which we base on a pure PTFE filter material. Note that we will use pure PTFE filter material for compliance testing, and we may require you to use pure PTFE filter material for any compliance testing we require, such as for selective enforcement audits.

(iv) You may request to use other filter materials or sizes under the provisions of § 1065.10.

(v) To minimize turbulent deposition and to deposit PM evenly on a filter, use a 12.5° (from center) divergent cone angle to transition from the transfer-line inside diameter to the exposed diameter of the filter face. Use 300 series stainless steel for this transition.

(vi) Maintain a filter face velocity near 100 cm/s with less than 5% of the recorded flow values exceeding 100 cm/s, unless you expect either the net PM mass on the filter to exceed 400 μg, assuming a 38 mm diameter filter stain area. Measure face velocity as the volumetric flow rate of the sample at the

pressure upstream of the filter and temperature of the filter face as measured in § 1065.140(e), divided by the filter's exposed area. You may use the exhaust stack or CVS tunnel pressure for the upstream pressure if the pressure drop through the PM sampler up to the filter is less than 2 kPa.

(vii) Use a clean cassette designed to the specifications of Figure 1 of § 1065.170 and made of any of the following materials: Delrin™, 300 series stainless steel, polycarbonate, acrylonitrile-butadiene-styrene (ABS) resin, or conductive polypropylene. We recommend that you keep filter cassettes clean by periodically washing or wiping them with a compatible solvent applied using a lint-free cloth. Depending upon your cassette material, ethanol (C₂H₅OH) might be an acceptable solvent. Your cleaning frequency will depend on your engine's PM and HC emissions.

(viii) If you store filters in cassettes in an automatic PM sampler, cover or seal individual filter cassettes after sampling to prevent communication of semi-volatile matter from one filter to another.

* * * * *

■ 62. Section 1065.190 is amended by revising paragraphs (c), (e), (f) and (g) to read as follows:

§ 1065.190 PM-stabilization and weighing environments for gravimetric analysis.

* * * * *

(c) Verify the cleanliness of the PM-stabilization environment using reference filters, as described in § 1065.390(d).

* * * * *

(e) Verify the following ambient conditions using measurement instruments that meet the specifications in subpart C of this part:

(1) Continuously measure dewpoint and ambient temperature. Use these values to determine if the stabilization and weighing environments have remained within the tolerances specified in paragraph (d) of this section for at least 60 min. before weighing sample media (e.g., filters). We recommend that you use an interlock that automatically prevents the balance from reporting values if either of the environments have not been within the applicable tolerances for the past 60 min.

(2) Continuously measure atmospheric pressure within the weighing environment. An acceptable alternative is to use a barometer that measures atmospheric pressure outside the weighing environment, as long as you can ensure that atmospheric

pressure at the balance is always within ±100 Pa of that outside environment during weighing operations. Record atmospheric pressure as you weigh filters, and use these pressure values to perform the buoyancy correction in § 1065.690.

(f) We recommend that you install a balance as follows:

(1) Install the balance on a vibration-isolation platform to isolate it from external noise and vibration.

(2) Shield the balance from convective airflow with a static-dissipating draft shield that is electrically grounded.

(3) Follow the balance manufacturer's specifications for all preventive maintenance.

(4) Operate the balance manually or as part of an automated weighing system.

(g) Minimize static electric charge in the balance environment, as follows:

(1) Electrically ground the balance.

(2) Use 300 series stainless steel tweezers if PM sample media (e.g., filters) must be handled manually.

(3) Ground tweezers with a grounding strap, or provide a grounding strap for the operator such that the grounding strap shares a common ground with the balance. Make sure grounding straps have an appropriate resistor to protect operators from accidental shock.

(4) Provide a static-electricity neutralizer that is electrically grounded in common with the balance to remove static charge from PM sample media (e.g., filters), as follows:

(i) You may use radioactive neutralizers such as a Polonium (²¹⁰Po) source. Replace radioactive sources at the intervals recommended by the neutralizer manufacturer.

(ii) You may use other neutralizers, such as corona-discharge ionizers. If you use a corona-discharge ionizer, we recommend that you monitor it for neutral net charge according to the ionizer manufacturer's recommendations.

(5) We recommend that you use a device to monitor the static charge of PM sample media (e.g., filter) surface.

(6) We recommend that you neutralize PM sample media (e.g., filters) to within ±2.0 V of neutral. Measure static voltages as follows:

(i) Measure static voltage of PM sample media (e.g., filters) according to the electrostatic voltmeter manufacturer's instructions.

(ii) Measure static voltage of PM sample media (e.g., filters) while the media is at least 15 cm away from any grounded surfaces to avoid mirror image charge interference.

■ 63. Section 1065.195 is amended by revising paragraphs (a) and (c)(4) to read as follows:

§ 1065.195 PM-stabilization environment for in-situ analyzers.

(a) This section describes the environment required to determine PM in-situ. For in-situ analyzers, such as an inertial balance, this is the environment within a PM sampling system that surrounds the PM sample media (e.g., filters). This is typically a very small volume.

* * * * *

(c) * * *

(4) *Absolute pressure.* Use good engineering judgment to maintain a tolerance of absolute pressure if your PM measurement instrument requires it.

* * * * *

Subpart C—[Amended]

■ 64. Section 1065.201 is amended by revising paragraphs (a) and (b) and adding paragraph (h) to read as follows:

§ 1065.201 Overview and general provisions.

(a) *Scope.* This subpart specifies measurement instruments and associated system requirements related to emission testing in a laboratory or similar environment and in the field. This includes laboratory instruments and portable emission measurement systems (PEMS) for measuring engine parameters, ambient conditions, flow-related parameters, and emission concentrations.

(b) *Instrument types.* You may use any of the specified instruments as described in this subpart to perform emission tests. If you want to use one of these instruments in a way that is not specified in this subpart, or if you want to use a different instrument, you must first get us to approve your alternate procedure under § 1065.10. Where we specify more than one instrument for a particular measurement, we may identify which instrument serves as the reference for comparing with an alternate procedure.

* * * * *

(h) *Recommended practices.* This subpart identifies a variety of recommended but not required practices for proper measurements. We believe in most cases it is necessary to follow these recommended practices for accurate and repeatable measurements and we intend to follow them as much as possible for our testing. However, we do not specifically require you to follow these recommended practices to perform a valid test, as long as you meet the required calibrations and verifications of measurement systems specified in subpart D of this part.

■ 65. Section 1065.210 is amended by revising paragraph (a) before the figure to read as follows:

§ 1065.210 Work input and output sensors.

(a) *Application.* Use instruments as specified in this section to measure work inputs and outputs during engine operation. We recommend that you use sensors, transducers, and meters that meet the specifications in Table 1 of § 1065.205. Note that your overall systems for measuring work inputs and outputs must meet the linearity verifications in § 1065.307. We recommend that you measure work inputs and outputs where they cross the system boundary as shown in Figure 1 of § 1065.210. The system boundary is different for air-cooled engines than for liquid-cooled engines. If you choose to measure work before or after a work conversion, relative to the system boundary, use good engineering judgment to estimate any work-conversion losses in a way that avoids overestimation of total work. For example, if it is impractical to instrument the shaft of an exhaust turbine generating electrical work, you may decide to measure its converted electrical work. As another example, you may decide to measure the tractive (i.e., electrical output) power of a locomotive, rather than the brake power of the locomotive engine. In these cases, divide the electrical work by accurate values of electrical generator efficiency ($\eta < 1$), or assume an efficiency of 1 ($\eta = 1$), which would over-estimate brake-specific emissions. For the example of using locomotive tractive power with a generator efficiency of 1 ($\eta = 1$), this means using the tractive power as the brake power in emission calculations. Do not underestimate any work conversion efficiencies for any components outside the system boundary that do not return work into the system boundary. And do not overestimate any work conversion efficiencies for components outside the system boundary that do return work into the system boundary. In all cases, ensure that you are able to accurately demonstrate compliance with the applicable standards.

* * * * *

■ 66. Section 1065.215 is amended by revising paragraph (e) to read as follows:

§ 1065.215 Pressure transducers, temperature sensors, and dewpoint sensors.

* * * * *

(e) *Dewpoint.* For PM-stabilization environments, we recommend chilled-surface hygrometers, which include chilled mirror detectors and chilled surface acoustic wave (SAW) detectors. For other applications, we recommend thin-film capacitance sensors. You may use other dewpoint sensors, such as a wet-bulb/dry-bulb psychrometer, where appropriate.

■ 67. Section 1065.220 is amended by revising paragraph (d) to read as follows:

§ 1065.220 Fuel flow meter.

* * * * *

(d) *Flow conditioning.* For any type of fuel flow meter, condition the flow as needed to prevent wakes, eddies, circulating flows, or flow pulsations from affecting the accuracy or repeatability of the meter. You may accomplish this by using a sufficient length of straight tubing (such as a length equal to at least 10 pipe diameters) or by using specially designed tubing bends, straightening fins, or pneumatic pulsation dampeners to establish a steady and predictable velocity profile upstream of the meter. Condition the flow as needed to prevent any gas bubbles in the fuel from affecting the fuel meter.

■ 68. Section 1065.265 is amended by revising paragraph (c) to read as follows:

§ 1065.265 Nonmethane cutter.

* * * * *

(c) *Configuration.* Configure the nonmethane cutter with a bypass line if it is needed for the verification described in § 1065.365.

* * * * *

■ 69. Section 1065.270 is amended by revising paragraphs (c) and (d) introductory text to read as follows:

§ 1065.270 Chemiluminescent detector.

* * * * *

(c) *NO₂-to-NO converter.* Place upstream of the CLD an internal or external NO₂-to-NO converter that meets the verification in § 1065.378. Configure the converter with a bypass line if it is needed to facilitate this verification.

(d) *Humidity effects.* You must maintain all CLD temperatures to

prevent aqueous condensation. If you remove humidity from a sample upstream of a CLD, use one of the following configurations:

* * * * *

■ 70. Section 1065.280 is revised to read as follows:

§ 1065.280 Paramagnetic and magnetopneumatic O₂ detection analyzers.

(a) *Application.* You may use a paramagnetic detection (PMD) or magnetopneumatic detection (MPD) analyzer to measure O₂ concentration in raw or diluted exhaust for batch or continuous sampling. You may use O₂ measurements with intake air or fuel flow measurements to calculate exhaust flow rate according to § 1065.650.

(b) *Component requirements.* We recommend that you use a PMD or MPD analyzer that meets the specifications in Table 1 of § 1065.205. Note that it must meet the linearity verification in § 1065.307. You may use a PMD or MPD that has compensation algorithms that are functions of other gaseous measurements and the engine's known or assumed fuel properties. The target value for any compensation algorithm is 0.0% (that is, no bias high and no bias low), regardless of the uncompensated signal's bias.

■ 71. Section 1065.290 is amended by revising paragraph (c)(1) to read as follows:

§ 1065.290 PM gravimetric balance.

* * * * *

(c) * * *

(1) Use a pan that centers the PM sample media (such as a filter) on the weighing pan. For example, use a pan in the shape of a cross that has upswep tips that center the PM sample media on the pan.

* * * * *

Subpart D—[Amended]

■ 72. Section 1065.303 is revised to read as follows:

§ 1065.303 Summary of required calibration and verifications.

The following table summarizes the required and recommended calibrations and verifications described in this subpart and indicates when these have to be performed:

TABLE 1 OF § 1065.303.—SUMMARY OF REQUIRED CALIBRATION AND VERIFICATIONS

Type of calibration or verification	Minimum frequency ^a
§ 1065.305: Accuracy, repeatability and noise ...	Accuracy: Not required, but recommended for initial installation. Repeatability: Not required, but recommended for initial installation. Noise: Not required, but recommended for initial installation.

TABLE 1 OF § 1065.303.—SUMMARY OF REQUIRED CALIBRATION AND VERIFICATIONS—Continued

Type of calibration or verification	Minimum frequency ^a
§ 1065.307: Linearity	Speed: Upon initial installation, within 370 days before testing and after major maintenance. Torque: Upon initial installation, within 370 days before testing and after major maintenance. Electrical power: Upon initial installation, within 370 days before testing and after major maintenance. Clean gas and diluted exhaust flows: Upon initial installation, within 370 days before testing and after major maintenance, unless flow is verified by propane check or by carbon or oxygen balance. Raw exhaust flow: Upon initial installation, within 185 days before testing and after major maintenance, unless flow is verified by propane check or by carbon or oxygen balance. Gas analyzers: Upon initial installation, within 35 days before testing and after major maintenance. PM balance: Upon initial installation, within 370 days before testing and after major maintenance. Stand-alone pressure and temperature: Upon initial installation, within 370 days before testing and after major maintenance.
§ 1065.308: Continuous analyzer system response and recording.	Upon initial installation, after system reconfiguration, and after major maintenance.
§ 1065.309: Continuous analyzer uniform response.	Upon initial installation, after system reconfiguration, and after major maintenance.
§ 1065.310: Torque	Upon initial installation and after major maintenance.
§ 1065.315: Pressure, temperature, dewpoint	Upon initial installation and after major maintenance.
§ 1065.320: Fuel flow	Upon initial installation and after major maintenance.
§ 1065.325: Intake flow	Upon initial installation and after major maintenance.
§ 1065.330: Exhaust flow	Upon initial installation and after major maintenance.
§ 1065.340: Diluted exhaust flow (CVS)	Upon initial installation and after major maintenance.
§ 1065.341: CVS and batch sampler verification ^b .	Upon initial installation, within 35 days before testing, and after major maintenance.
§ 1065.345: Vacuum leak	Before each laboratory test according to subpart F of this part and before each field test according to subpart J of this part.
§ 1065.350: CO ₂ NDIR H ₂ O interference	Upon initial installation and after major maintenance.
§ 1065.355: CO NDIR CO ₂ and H ₂ O interference.	Upon initial installation and after major maintenance.
§ 1065.360: FID calibration THC FID optimization, and THC FID verification.	Calibrate all FID analyzers: Upon initial installation and after major maintenance. Optimize and determine CH ₄ response for THC FID analyzers: upon initial installation and after major maintenance. Verify CH ₄ response for THC FID analyzers: Upon initial installation, within 185 days before testing, and after major maintenance.
§ 1065.362: Raw exhaust FID O ₂ interference ...	For all FID analyzers: Upon initial installation, and after major maintenance. For THC FID analyzers: Upon initial installation, after major maintenance, and after FID optimization according to § 1065.360.
§ 1065.365: Nonmethane cutter penetration	Upon initial installation, within 185 days before testing, and after major maintenance.
§ 1065.370: CLD CO ₂ and H ₂ O quench	Upon initial installation and after major maintenance.
§ 1065.372: NDUV HC and H ₂ O interference	Upon initial installation and after major maintenance.
§ 1065.376: Chiller NO ₂ penetration	Upon initial installation and after major maintenance.
§ 1065.378: NO ₂ -to-NO converter conversion	Upon initial installation, within 35 days before testing, and after major maintenance.
§ 1065.390: PM balance and weighing	Independent verification: Upon initial installation, within 370 days before testing, and after major maintenance. Zero, span, and reference sample verifications: Within 12 hours of weighing, and after major maintenance.
§ 1065.395: Inertial PM balance and weighing ..	Independent verification: Upon initial installation, within 370 days before testing, and after major maintenance. Other verifications: Upon initial installation and after major maintenance.

^a Perform calibrations and verifications more frequently, according to measurement system manufacturer instructions and good engineering judgment.

^b The CVS verification described in § 1065.341 is not required for systems that agree within ± 2% based on a chemical balance of carbon or oxygen of the intake air, fuel, and diluted exhaust.

■ 73. Section 1065.305 is amended by revising paragraphs (d)(4), (d)(8), and (d)(9)(iii) to read as follows:

§ 1065.305 Verifications for accuracy, repeatability, and noise.

* * * * *

(d) * * *

(4) Use the instrument to quantify a NIST-traceable reference quantity, y_{ref} . For gas analyzers the reference gas must meet the specifications of § 1065.750.

Select a reference quantity near the mean value expected during testing. For all gas analyzers, use a quantity near the flow-weighted mean concentration expected at the standard or expected during testing, whichever is greater. For noise verification, use the same zero gas from paragraph (e) of this section as the reference quantity. In all cases, allow time for the instrument to stabilize while it measures the reference quantity. Stabilization time may include

time to purge an instrument and time to account for its response.

* * * * *

(8) Repeat the steps specified in paragraphs (d)(2) through (7) of this section until you have ten arithmetic means ($\bar{y}_1, \bar{y}_2, \bar{y}_i, \dots, \bar{y}_{10}$), ten standard deviations, ($\sigma_1, \sigma_2, \sigma_i, \dots, \sigma_{10}$), and ten errors ($\epsilon_1, \epsilon_2, \epsilon_i, \dots, \epsilon_{10}$).

(9) * * *

(iii) *Noise*. Noise is two times the root-mean-square of the ten standard

deviations (that is, noise = $2 \cdot rms_{\sigma}$) when the reference signal is a zero-quantity signal. Refer to the example of a root-mean-square calculation in § 1065.602. We recommend that instrument noise be within the specifications in Table 1 of § 1065.205.

* * * * *

■ 74. Section 1065.307 is amended by revising paragraphs (b), (c)(6), (c)(13), and Table 1 and adding paragraphs (d)(8) and (e) before the newly revised table to read as follows:

§ 1065.307 Linearity verification.

* * * * *

(b) *Performance requirements.* If a measurement system does not meet the applicable linearity criteria in Table 1 of this section, correct the deficiency by recalibrating, servicing, or replacing components as needed. Repeat the linearity verification after correcting the deficiency to ensure that the measurement system meets the linearity criteria. Before you may use a measurement system that does not meet linearity criteria, you must demonstrate to us that the deficiency does not adversely affect your ability to demonstrate compliance with the applicable standards.

(c) * * *

(6) For all measured quantities, use instrument manufacturer recommendations and good engineering judgment to select reference values, y_{refi} , that cover a range of values that you expect would prevent extrapolation beyond these values during emission testing. We recommend selecting a zero reference signal as one of the reference values of the linearity verification. For stand-alone pressure and temperature linearity verifications, we recommend at least three reference values. For all other linearity verifications select at least ten reference values.

* * * * *

(13) Use the arithmetic means, \bar{y}_i , and reference values, \bar{y}_{refi} , to calculate least-squares linear regression parameters and statistical values to compare to the minimum performance criteria specified in Table 1 of this section. Use the calculations described in § 1065.602. Using good engineering judgment, you may weight the results of individual

data pairs (i.e., (y_{refi}, \bar{y}_i)), in the linear regression calculations.

(d) * * *

(8) *Temperature.* You may perform the linearity verification for temperature measurement systems with thermocouples, RTDs, and thermistors by removing the sensor from the system and using a simulator in its place. Use a NIST-traceable simulator that is independently calibrated and, as appropriate, cold-junction compensated. The simulator uncertainty scaled to temperature must be less than 0.5% of T_{max} . If you use this option, you must use sensors that the supplier states are accurate to better than 0.5% of T_{max} compared with their standard calibration curve.

(e) *Measurement systems that require linearity verification.* Table 1 of this section indicates measurement systems that require linearity verifications, subject to the following provisions:

(1) Perform a linearity verification more frequently based on the instrument manufacturer's recommendation or good engineering judgment.

(2) The expression "min" refers to the minimum reference value used during the linearity verification. Note that this value may be zero or a negative value depending on the signal.

(3) The expression "max" generally refers to the maximum reference value used during the linearity verification. For example for gas dividers, x_{max} is the undivided, undiluted, span gas concentration. The following are special cases where "max" refers to a different value:

(i) For linearity verification with a PM balance, m_{max} refers to the typical mass of a PM filter.

(ii) For linearity verification of torque, T_{max} refers to the manufacturer's specified engine torque peak value of the lowest torque engine to be tested.

(4) The specified ranges are inclusive. For example, a specified range of 0.98–1.02 for a_1 means $0.98 \leq a_1 \leq 1.02$.

(5) These linearity verifications are optional for systems that pass the flow-rate verification for diluted exhaust as described in § 1065.341 (the propane check) or for systems that agree within $\pm 2\%$ based on a chemical balance of

carbon or oxygen of the intake air, fuel, and exhaust.

(6) You must meet the a_1 criteria for these quantities only if the absolute value of the quantity is required, as opposed to a signal that is only linearly proportional to the actual value.

(7) The following provisions apply for stand-alone temperature measurements:

(i) The following temperature linearity checks are required:

- (A) Air intake.
- (B) Aftertreatment bed(s), for engines tested with aftertreatment devices subject to cold-start testing.
- (C) Dilution air for PM sampling, including CVS, double-dilution, and partial-flow systems.
- (D) PM sample, if applicable.
- (E) Chiller sample, for gaseous sampling systems that use chillers to dry samples.

(ii) The following temperature linearity checks are required only if specified by the engine manufacturer:

- (A) Fuel inlet.
- (B) Air outlet to the test cell's charge air cooler air outlet, for engines tested with a laboratory heat exchanger that simulates an installed charge air cooler.
- (C) Coolant inlet to the test cell's charge air cooler, for engines tested with a laboratory heat exchanger that simulates an installed charge air cooler.
- (D) Oil in the sump/pan.
- (E) Coolant before the thermostat, for liquid-cooled engines.

(8) The following provisions apply for stand-alone pressure measurements:

(i) The following pressure linearity checks are required:

- (A) Air intake restriction.
- (B) Exhaust back pressure.
- (C) Barometer.
- (D) CVS inlet gage pressure.
- (E) Chiller sample, for gaseous sampling systems that use chillers to dry samples.

(ii) The following pressure linearity checks are required only if specified by the engine manufacturer:

- (A) The test cell's charge air cooler and interconnecting pipe pressure drop, for turbo-charged engines tested with a laboratory heat exchanger that simulates an installed charge air cooler.
- (B) Fuel outlet.

TABLE 1 OF § 1065.307.—MEASUREMENT SYSTEMS THAT REQUIRE LINEARITY VERIFICATIONS

Measurement system	Quantity	Minimum verification frequency	Linearity criteria			
			$ x_{min}(a_1 - 1) + a_0 $	a_1	SEE	r^2
Engine speed	f_n	Within 370 days before testing	$\leq 0.05\% f_{nmax}$	0.98–1.02	$\leq 2\% \cdot f_{nmax}$	≥ 0.990
Engine torque	T	Within 370 days before testing	$\leq 1\% \cdot T_{max}$	0.98–1.02	$\leq 2\% \cdot T_{max}$	≥ 0.990
Electrical work	W	Within 370 days before testing	$\leq 1\% \cdot T_{max}$	0.98–1.02	$\leq 2\% \cdot T_{max}$	≥ 0.990
Fuel flow rate	\dot{m}	Within 370 days before testing ^d	$\leq 1\% \cdot \dot{m}_{max}$	0.98–1.02	$\leq 2\% \cdot \dot{m}_{max}$	≥ 0.990

TABLE 1 OF § 1065.307.—MEASUREMENT SYSTEMS THAT REQUIRE LINEARITY VERIFICATIONS—Continued

Measurement system	Quantity	Minimum verification frequency	Linearity criteria			
			$ x_{\min}(a_1 - 1) + a_0 $	a_1	SEE	r^2
Intake-air flow rate	\dot{n}	Within 370 days before testing	$\leq 1\% \cdot \dot{n}_{\max}$	0.98–1.02	$\leq 2\% \cdot \dot{n}_{\max}$	≥ 0.990
Dilution air flow rate	\dot{n}	Within 370 days before testing	$\leq 1\% \cdot \dot{n}_{\max}$	0.98–1.02	$\leq 2\% \cdot \dot{n}_{\max}$	≥ 0.990
Diluted exhaust flow rate	\dot{n}	Within 370 days before testing	$\leq 1\% \cdot \dot{n}_{\max}$	0.98–1.02	$\leq 2\% \cdot \dot{n}_{\max}$	≥ 0.990
Raw exhaust flow rate	\dot{n}	Within 185 days before testing	$\leq 1\% \cdot \dot{n}_{\max}$	0.98–1.02	$\leq 2\% \cdot \dot{n}_{\max}$	≥ 0.990
Batch sampler flow rates	\dot{n}	Within 370 days before testing	$\leq 1\% \cdot \dot{n}_{\max}$	0.98–1.02	$\leq 2\% \cdot \dot{n}_{\max}$	≥ 0.990
Gas dividers	x/x_{span}	Within 370 days before testing	$\leq 0.5\% \cdot x_{\max}$	0.98–1.02	$\leq 2\% \cdot x_{\max}$	≥ 0.990
Gas analyzers for laboratory testing.	x	Within 35 days before testing ...	$\leq 0.5\% \cdot x_{\max}$	0.99–1.01	$\leq 1\% \cdot x_{\max}$	≥ 0.998
Gas analyzers for field testing ..	x	Within 35 days before testing ...	$\leq 1\% \cdot x_{\max}$	0.99–1.01	$\leq 1\% \cdot x_{\max}$	≥ 0.998
PM balance	m	Within 370 days before testing	$\leq 1\% \cdot m_{\max}$	0.99–1.01	$\leq 1\% \cdot m_{\max}$	≥ 0.998
Stand-alone pressures	p	Within 370 days before testing	$\leq 1\% \cdot p_{\max}$	0.99–1.01	$\leq 1\% \cdot p_{\max}$	≥ 0.998
Analog-to-digital conversion of stand-alone temperature signals.	T	Within 370 days before testing	$\leq 1\% \cdot T_{\max}$	0.99–1.01	$\leq 1\% \cdot T_{\max}$	≥ 0.998

■ 75. Section 1065.308 is revised to read as follows:

§ 1065.308 Continuous gas analyzer system-response and updating-recording verification—general.

This section describes a general verification procedure for continuous gas analyzer system response and update recording. See § 1065.309 for verification procedures that apply for systems or components involving H₂O correction.

(a) *Scope and frequency.* Perform this verification after installing or replacing a gas analyzer that you use for continuous sampling. Also perform this verification if you reconfigure your system in a way that would change system response. For example, perform this verification if you add a significant volume to the transfer lines by increasing their length or adding a filter; or if you reduce the frequency at which you sample and record gas-analyzer concentrations. You do not have to perform this verification for gas analyzer systems used only for discrete-mode testing.

(b) *Measurement principles.* This test verifies that the updating and recording frequencies match the overall system response to a rapid change in the value of concentrations at the sample probe. Gas analyzer systems must be optimized such that their overall response to a rapid change in concentration is updated and recorded at an appropriate frequency to prevent loss of information. This test also verifies that continuous gas analyzer systems meet a minimum response time.

(c) *System requirements.* To demonstrate acceptable updating and recording with respect to the system's overall response, use good engineering judgment to select one of the following criteria that your system must meet:

(1) The product of the mean rise time and the frequency at which the system records an updated concentration must be at least 5, and the product of the mean fall time and the frequency at which the system records an updated concentration must be at least 5. This criterion makes no assumption regarding the frequency content of changes in emission concentrations during emission testing; therefore, it is valid for any testing. In any case the mean rise time and the mean fall time must be no more than 10 seconds.

(2) The frequency at which the system records an updated concentration must be at least 5 Hz. This criterion assumes that the frequency content of significant changes in emission concentrations during emission testing do not exceed 1 Hz. In any case the mean rise time and the mean fall time must be no more than 10 seconds.

(3) You may use other criteria if we approve the criteria in advance.

(4) You may meet the overall PEMS verification in § 1065.920 instead of the verification in this section for field testing with PEMS.

(d) *Procedure.* Use the following procedure to verify the response of a continuous gas analyzer system:

(1) *Instrument setup.* Follow the analyzer system manufacturer's start-up and operating instructions. Adjust the system as needed to optimize performance.

(2) *Equipment setup.* We recommend using minimal lengths of gas transfer lines between all connections and fast-acting three-way valves (2 inlets, 1 outlet) to control the flow of zero and blended span gases to the analyzers. You may use a gas mixing or blending device to equally blend an NO-CO-CO₂-C₃H₈-CH₄, balance N₂ span gas with a span gas of NO₂, balance purified synthetic air. Standard binary span

gases may also be used, where applicable, in place of blended NO-CO-CO₂-C₃H₈-CH₄, balance N₂ span gas, but separate response tests must then be run for each analyzer. In designing your experimental setup, avoid pressure pulsations due to stopping the flow through the gas-blending device. Note that you may omit any of these gas constituents if they are not relevant to your analyzers for this verification.

(3) *Data collection.* (i) Start the flow of zero gas.

(ii) Allow for stabilization, accounting for transport delays and the slowest instrument's full response.

(iii) Start recording data at the frequency used during emission testing. Each recorded value must be a unique updated concentration measured by the analyzer; you may not use interpolation to increase the number of recorded values.

(iv) Switch the flow to allow the blended span gases to flow to the analyzer.

(v) Allow for transport delays and the slowest instrument's full response.

(vi) Repeat the steps in paragraphs (d)(3)(i) through (v) of this section to record seven full cycles, ending with zero gas flowing to the analyzers.

(vii) Stop recording.

(e) *Performance evaluation.* (1) If you chose to demonstrate compliance with paragraph (c)(1) of this section, use the data from paragraph (d)(3) of this section to calculate the mean rise time, t_{10-90} , and mean fall time, t_{10-90} , for each of the analyzers. Multiply these times (in seconds) by their respective recording frequencies in Hertz (1/second). The value for each result must be at least 5. If the value is less than 5, increase the recording frequency or adjust the flows or design of the sampling system to increase the rise time and fall time as needed. You may

also configure digital filters to increase rise and fall times. The mean rise time and mean fall time must be no greater than 10 seconds.

(2) If a measurement system fails the criterion in paragraph (e)(1) of this section, ensure that signals from the system are updated and recorded at a frequency of at least 5 Hz. In any case, the mean rise time and mean fall time must be no greater than 10 seconds.

(3) If a measurement system fails the criteria in paragraphs (e)(1) and (2) of this section, you may use the continuous analyzer system only if the deficiency does not adversely affect your ability to show compliance with the applicable standards.

■ 76. Section 1065.309 is revised to read as follows:

§ 1065.309 Continuous gas analyzer system-response and updating-recording verification—with humidified-response verification.

This section describes a verification procedure for continuous gas analyzer system response and update recording for systems or components involving H₂O correction. See § 1065.308 for verification procedures that apply for systems not involving humidification.

(a) *Scope and frequency.* Perform this verification to determine a continuous gas analyzer's response, where one analyzer's response is compensated by another's to quantify a gaseous emission. For this check we consider water vapor a gaseous constituent. You do not have to perform this verification for batch gas analyzer systems or for continuous analyzer systems that are only used for discrete-mode testing. Perform this verification after initial installation (i.e. test cell commissioning). The verification in this section is required for initial installation of systems or components involving H₂O correction. For later verifications, you may use the procedures specified in § 1065.308, as long as your system includes no replacement components involving H₂O correction that have never been verified using the procedures in this section.

(b) *Measurement principles.* This procedure verifies the time-alignment and uniform response of continuously combined gas measurements. For this procedure, ensure that all compensation algorithms and humidity corrections are turned on.

(c) *System requirements.* Demonstrate that continuously combined concentration measurements have a uniform rise and fall during a system response to a rapid change in multiple gas concentrations. You must meet one of the following criteria:

(1) The product of the mean rise time and the frequency at which the system records an updated concentration must be at least 5, and the product of the mean fall time and the frequency at which the system records an updated concentration must be at least 5. This criterion makes no assumption regarding the frequency content of changes in emission concentrations during emission testing; therefore, it is valid for any testing. In no case may the mean rise time or the mean fall time be more than 10 seconds.

(2) The frequency at which the system records an updated concentration must be at least 5 Hz. This criterion assumes that the frequency content of significant changes in emission concentrations during emission testing do not exceed 1 Hz. In no case may the mean rise time or the mean fall time be more than 10 seconds.

(3) You may use other criteria if we approve them in advance.

(4) You may meet the overall PEMS verification in § 1065.920 instead of the verification in this section for field testing with PEMS.

(d) *Procedure.* Use the following procedure to verify the response of a continuous gas analyzer system:

(1) *Instrument setup.* Follow the analyzer system manufacturer's start-up and operating instructions. Adjust the system as needed to optimize performance.

(2) *Equipment setup.* We recommend using minimal lengths of gas transfer lines between all connections and fast-acting three-way valves (2 inlets, 1 outlet) to control the flow of zero and blended span gases to the analyzers. You may use a gas blending or mixing device to equally blend a span gas of NO-CO-CO₂-C₃H₈-CH₄, balance N₂, with a span gas of NO₂, balance purified synthetic air. Standard binary span gases may be used, where applicable, in place of blended NO-CO-CO₂-C₃H₈-CH₄, balance N₂ span gas, but separate response tests must then be run for each analyzer. In designing your experimental setup, avoid pressure pulsations due to stopping the flow through the gas blending device. Span gases must be humidified before entering the analyzer; however, you may not humidify NO₂ span gas by passing it through a sealed humidification vessel that contains water. We recommend humidifying your NO-CO-CO₂-C₃H₈-CH₄, balance N₂ blended gas by flowing the gas mixture through a sealed vessel that humidifies the gas by bubbling it through distilled water and then mixing the gas with dry NO₂ gas, balance purified synthetic air. If your system does not use a sample dryer to

remove water from the sample gas, you must humidify your span gas by flowing the gas mixture through a sealed vessel that humidifies the gas to the highest sample dewpoint that you estimate during emission sampling by bubbling it through distilled water. If your system uses a sample dryer during testing that has passed the sample dryer verification check in § 1065.342, you may introduce the humidified gas mixture downstream of the sample dryer by bubbling it through distilled water in a sealed vessel at (25 ± 10) °C, or a temperature greater than the dewpoint determined in § 1065.145(d)(2). In all cases, maintain the humidified gas temperature downstream of the vessel at least 5 °C above its local dewpoint in the line. We recommend that you heat all gas transfer lines and valves located downstream of the vessel as needed to avoid condensation. Note that you may omit any of these gas constituents if they are not relevant to your analyzers for this verification. If any of your gas constituents are not susceptible to water compensation, you may perform the response check for these analyzers without humidification.

(3) *Data collection.* (i) Start the flow of zero gas.

(ii) Allow for stabilization, accounting for transport delays and the slowest instrument's full response.

(iii) Start recording data at the frequency used during emission testing. Each recorded value must be a unique updated concentration measured by the analyzer; you may not use interpolation to increase the number of recorded values.

(iv) Switch the flow to allow the blended span gases to flow to the analyzers.

(v) Allow for transport delays and the slowest instrument's full response.

(vi) Repeat the steps in paragraphs (d)(3)(i) through (v) of this section to record seven full cycles, ending with zero gas flowing to the analyzers.

(vii) Stop recording.

(e) *Performance evaluations.* (1) If you chose to demonstrate compliance with paragraph (c)(1) of this section, use the data from paragraph (d)(3) of this section to calculate the mean rise time, t_{10-90} , and mean fall time, t_{90-10} , for each of the analyzers. Multiply these times (in seconds) by their respective recording frequencies in Hz (1/second). The value for each result must be at least 5. If the value is less than 5, increase the recording frequency or adjust the flows or design of the sampling system to increase the rise time and fall time as needed. You may also configure digital filters to increase rise and fall times. In no case may the

mean rise time or mean fall time be greater than 10 seconds.

(2) If a measurement system fails the criterion in paragraph (e)(1) of this section, ensure that signals from the system are updated and recorded at a frequency of at least 5 Hz. In no case may the mean rise time or mean fall time be greater than 10 seconds.

(3) If a measurement system fails the criteria in paragraphs (e)(1) and (2) of this section, you may use the continuous analyzer system only if the deficiency does not adversely affect your ability to show compliance with the applicable standards.

■ 77. Section 1065.310 is amended by revising paragraph (d) to read as follows:

§ 1065.310 Torque calibration.

* * * * *

(d) *Strain gage or proving ring calibration.* This technique applies force either by hanging weights on a lever arm (these weights and their lever arm length are not used as part of the reference torque determination) or by operating the dynamometer at different torques. Apply at least six force combinations for each applicable torque-measuring range, spacing the force quantities about equally over the range. Oscillate or rotate the dynamometer during calibration to reduce frictional static hysteresis. In this case, the reference torque is determined by multiplying the force output from the reference meter (such as a strain gage or proving ring) by its effective lever-arm length, which you measure from the point where the force measurement is

made to the dynamometer's rotational axis. Make sure you measure this length perpendicular to the reference meter's measurement axis and perpendicular to the dynamometer's rotational axis.

■ 78. Section 1065.315 is amended by revising paragraph (a)(2) to read as follows:

§ 1065.315 Pressure, temperature, and dewpoint calibration.

(a) * * *

(2) *Temperature.* We recommend digital dry-block or stirred-liquid temperature calibrators, with data logging capabilities to minimize transcription errors. We recommend using calibration reference quantities that are NIST-traceable within 0.5% uncertainty. You may perform the linearity verification for temperature measurement systems with thermocouples, RTDs, and thermistors by removing the sensor from the system and using a simulator in its place. Use a NIST-traceable simulator that is independently calibrated and, as appropriate, cold-junction compensated. The simulator uncertainty scaled to temperature must be less than 0.5% of T_{max} . If you use this option, you must use sensors that the supplier states are accurate to better than 0.5% of T_{max} compared with their standard calibration curve.

* * * * *

■ 79. Section 1065.340 is amended by revising paragraphs (f)(5), (f)(6)(ii), (f)(7), (f)(9), (f)(10), (g)(6)(i), and Figure 1 to read as follows:

§ 1065.340 Diluted exhaust flow (CVS) calibration.

* * * * *

(f) * * *

(5) Set the variable restrictor to its wide-open position. Instead of a variable restrictor, you may alternately vary the pressure downstream of the CFV by varying blower speed or by introducing a controlled leak. Note that some blowers have limitations on nonloaded conditions.

(6) * * *

(ii) The mean dewpoint of the calibration air, \bar{T}_{dew} . See § 1065.640 for permissible assumptions during emission measurements.

* * * * *

(7) Incrementally close the restrictor valve or decrease the downstream pressure to decrease the differential pressure across the CFV, $\Delta\bar{p}_{CFV}$.

* * * * *

(9) Determine C_d and the lowest allowable pressure ratio, r , according to § 1065.640.

(10) Use C_d to determine CFV flow during an emission test. Do not use the CFV below the lowest allowed r , as determined in § 1065.640.

* * * * *

(g) * * *

(6) * * *

(i) The mean flow rate of the reference flow meter, \bar{n}_{ref} . This may include several measurements of different quantities, such as reference meter pressures and temperatures, for calculating \bar{n}_{ref} .

* * * * *

BILLING CODE 6560-50-P

Figure 1 of 1065.340 CVS calibration configurations.

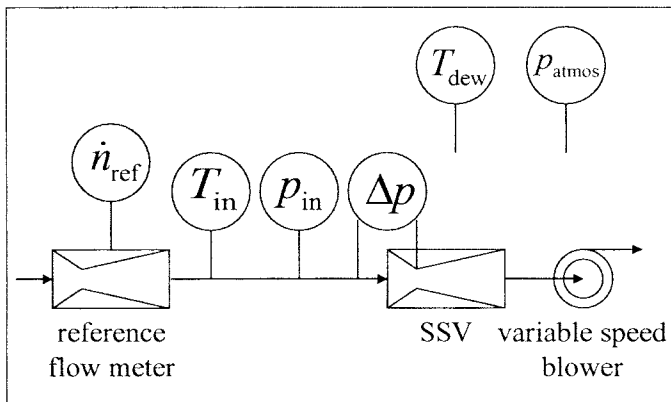
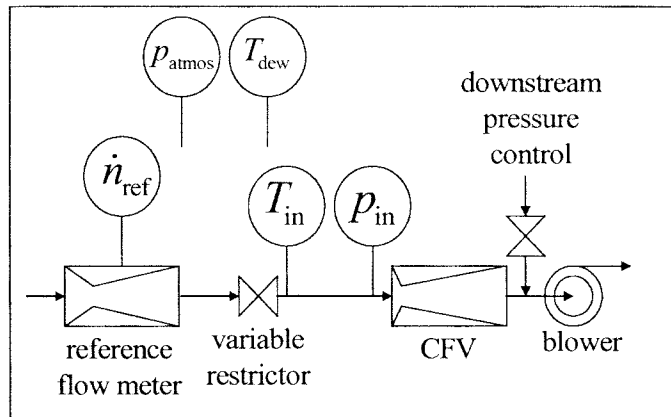
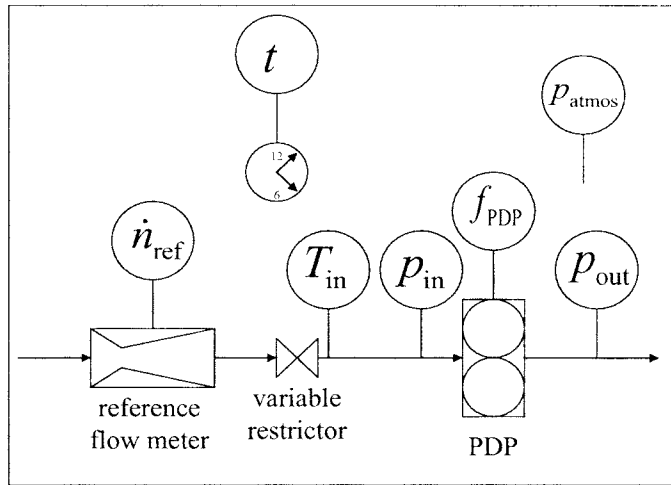

■ 80. Section 1065.341 is amended by revising paragraphs (d) introductory text, (d)(7), and (g) introductory text to read as follows:

§ 1065.341 CVS and batch sampler verification (propane check).

* * * * *

(d) If you performed the vacuum-side leak verification of the HC sampling system as described in paragraph (c)(8) of this section, you may use the HC contamination procedure in § 1065.520(g) to verify HC contamination. Otherwise, zero, span, and verify contamination of the HC sampling system, as follows:

* * * * *

(7) When the overflow HC concentration does not exceed 2 $\mu\text{mol/mol}$, record this value as X_{THCinit} and use it to correct for HC contamination as described in § 1065.660.

* * * * *

(g) You may repeat the propane check to verify a batch sampler, such as a PM secondary dilution system.

* * * * *

■ 81. A new § 1065.342 is added to read as follows:

§ 1065.342 Sample dryer verification.

(a) *Scope and frequency.* If you use a sample dryer as allowed in § 1065.145(d)(2) to remove water from the sample gas, verify the performance upon installation, after major maintenance, for thermal chiller. For osmotic membrane dryers, verify the performance upon installation, after major maintenance, and within 35 days of testing.

(b) *Measurement principles.* Water can inhibit an analyzer's ability to properly measure the exhaust component of interest and thus is sometimes removed before the sample gas reaches the analyzer. For example water can negatively interfere with a CLD's NO_x response through collisional quenching and can positively interfere with an NDIR analyzer by causing a response similar to CO.

(c) *System requirements.* The sample dryer must meet the specifications as determined in § 1065.145(d)(2) for dewpoint, T_{dew} , and absolute pressure, p_{total} , downstream of the osmotic-membrane dryer or thermal chiller.

(d) *Sample dryer verification procedure.* Use the following method to determine sample dryer performance, or use good engineering judgment to develop a different protocol:

(1) Use PTFE or stainless steel tubing to make necessary connections.

(2) Humidify N_2 or purified air by bubbling it through distilled water in a sealed vessel that humidifies the gas to

the highest sample dewpoint that you estimate during emission sampling.

(3) Introduce the humidified gas upstream of the sample dryer.

(4) Downstream of the vessel, maintain the humidified gas temperature at least 5 °C above its dewpoint.

(5) Measure the humidified gas dewpoint, T_{dew} , and pressure, p_{total} , as close as possible to the inlet of the sample dryer to verify the dewpoint is the highest that you estimated during emission sampling.

(6) Measure the humidified gas dewpoint, T_{dew} , and pressure, p_{total} , as close as possible to the outlet of the sample dryer.

(7) The sample dryer meets the verification if the results of paragraph (d)(6) of this section are less than the dew point corresponding to the sample dryer specifications as determined in § 1065.145(d)(2) plus 2 °C or if the mole fraction from (d)(6) is less than the corresponding sample dryer specifications plus 0.002 mol/mol.

(e) *Alternate sample dryer verification procedure.* The following method may be used in place of the sample dryer verification procedure in (d) of this section. If you use a humidity sensor for continuous monitoring of dewpoint at the sample dryer outlet you may skip the performance check in § 1065.342(d), but you must make sure that the dryer outlet humidity is below the minimum values used for quench, interference, and compensation checks.

■ 82. Section 1065.345 is revised to read as follows:

§ 1065.345 Vacuum-side leak verification.

(a) *Scope and frequency.* Verify that there are no significant vacuum-side leaks using one of the leak tests described in this section upon initial sampling system installation, after maintenance such as pre-filter changes, and within eight hours before each duty-cycle sequence. This verification does not apply to any full-flow portion of a CVS dilution system.

(b) *Measurement principles.* A leak may be detected either by measuring a small amount of flow when there should be zero flow, or by detecting the dilution of a known concentration of span gas when it flows through the vacuum side of a sampling system.

(c) *Low-flow leak test.* Test a sampling system for low-flow leaks as follows:

(1) Seal the probe end of the system by taking one of the following steps:

(i) Cap or plug the end of the sample probe.

(ii) Disconnect the transfer line at the probe and cap or plug the transfer line.

(iii) Close a leak-tight valve located in the sample transfer line within 92 cm of the probe.

(2) Operate all vacuum pumps. After stabilizing, verify that the flow through the vacuum-side of the sampling system is less than 0.5% of the system's normal in-use flow rate. You may estimate typical analyzer and bypass flows as an approximation of the system's normal in-use flow rate.

(d) *Dilution-of-span-gas leak test.* You may use any gas analyzer for this test.

If you use a FID for this test, correct for any HC contamination in the sampling system according to § 1065.660. To avoid misleading results from this test, we recommend using only analyzers that have a repeatability of 0.5% or better at the span gas concentration used for this test. Perform a vacuum-side leak test as follows:

(1) Prepare a gas analyzer as you would for emission testing.

(2) Supply span gas to the analyzer port and verify that it measures the span gas concentration within its expected measurement accuracy and repeatability.

(3) Route overflow span gas to one of the following locations in the sampling system:

(i) The end of the sample probe.

(ii) Disconnect the transfer line at the probe connection, and overflow the span gas at the open end of the transfer line.

(iii) A three-way valve installed in-line between a probe and its transfer line, such as a system overflow zero and span port.

(4) Verify that the measured overflow span gas concentration is within $\pm 0.5\%$ of the span gas concentration. A measured value lower than expected indicates a leak, but a value higher than expected may indicate a problem with the span gas or the analyzer itself. A measured value higher than expected does not indicate a leak.

(e) *Vacuum-decay leak test.* To perform this test you must apply a vacuum to the vacuum-side volume of your sampling system and then observe the leak rate of your system as a decay in the applied vacuum. To perform this test you must know the vacuum-side volume of your sampling system to within $\pm 10\%$ of its true volume. For this test you must also use measurement instruments that meet the specifications of subpart C of this part and of this subpart D. Perform a vacuum-decay leak test as follows:

(1) Seal the probe end of the system as close to the probe opening as possible by taking one of the following steps:

(i) Cap or plug the end of the sample probe.

(ii) Disconnect the transfer line at the probe and cap or plug the transfer line.

(iii) Close a leak-tight valve in-line between a probe and transfer line.

(2) Operate all vacuum pumps. Draw a vacuum that is representative of normal operating conditions. In the case of sample bags, we recommend that you repeat your normal sample bag pump-down procedure twice to minimize any trapped volumes.

(3) Turn off the sample pumps and seal the system. Measure and record the absolute pressure of the trapped gas and optionally the system absolute temperature. Wait long enough for any transients to settle and long enough for a leak at 0.5% to have caused a pressure change of at least 10 times the resolution of the pressure transducer, then again record the pressure and optionally temperature.

(4) Calculate the leak flow rate based on an assumed value of zero for pumped-down bag volumes and based on known values for the sample system volume, the initial and final pressures, optional temperatures, and elapsed time. Using the calculations specified in 1065.644, verify that the vacuum-decay leak flow rate is less than 0.5% of the system's normal in-use flow rate.

■ 83. Section 1065.350 is amended by revising paragraphs (c) and (d) to read as follows:

§ 1065.350 H₂O interference verification for CO₂ NDIR analyzers.

* * * * *

(c) *System requirements.* A CO₂ NDIR analyzer must have an H₂O interference that is within (0.0 ± 0.4) mmol/mol, though we strongly recommend a lower interference that is within (0.0 ± 0.2) mmol/mol.

(d) *Procedure.* Perform the interference verification as follows:

(1) Start, operate, zero, and span the CO₂ NDIR analyzer as you would before an emission test.

(2) Create a humidified test gas by bubbling zero air that meets the specifications in § 1065.750 through distilled water in a sealed vessel. If the sample is not passed through a dryer, control the vessel temperature to generate an H₂O level at least as high as the maximum expected during testing. If the sample is passed through a dryer during testing, control the vessel temperature to generate an H₂O level at least as high as the level determined in § 1065.145(d)(2).

(3) Introduce the humidified test gas into the sample system. You may introduce it downstream of any sample dryer, if one is used during testing.

(4) Measure the humidified test gas dewpoint, T_{dew} , and pressure, p_{total} , as

close as possible to the inlet of the analyzer.

(5) Downstream of the vessel, maintain the humidified test gas temperature at least 5 °C above its dewpoint.

(6) Allow time for the analyzer response to stabilize. Stabilization time may include time to purge the transfer line and to account for analyzer response.

(7) While the analyzer measures the sample's concentration, record 30 seconds of sampled data. Calculate the arithmetic mean of this data. The analyzer meets the interference verification if this value is within (0 ± 0.4) mmol/mol.

* * * * *

■ 84. Section 1065.355 is amended by revising paragraph (d) to read as follows:

§ 1065.355 H₂O and CO₂ interference verification for CO NDIR analyzers.

* * * * *

(d) *Procedure.* Perform the interference verification as follows:

(1) Start, operate, zero, and span the CO NDIR analyzer as you would before an emission test.

(2) Create a humidified CO₂ test gas by bubbling a CO₂ span gas through distilled water in a sealed vessel. If the sample is not passed through a dryer, control the vessel temperature to generate an H₂O level at least as high as the maximum expected during testing. If the sample is passed through a dryer during testing, control the vessel temperature to generate an H₂O level at least as high as the level determined in § 1065.145(d)(2). Use a CO₂ span gas concentration at least as high as the maximum expected during testing.

(3) Introduce the humidified CO₂ test gas into the sample system. You may introduce it downstream of any sample dryer, if one is used during testing.

(4) Measure the humidified CO₂ test gas dewpoint, T_{dew} , and pressure, p_{total} , as close as possible to the inlet of the analyzer.

(5) Downstream of the vessel, maintain the humidified gas temperature at least 5 °C above its dewpoint.

(6) Allow time for the analyzer response to stabilize. Stabilization time may include time to purge the transfer line and to account for analyzer response.

(7) While the analyzer measures the sample's concentration, record its output for 30 seconds. Calculate the arithmetic mean of this data.

(8) The analyzer meets the interference verification if the result of paragraph (d)(7) of this section meets

the tolerance in paragraph (c) of this section.

(9) You may also run interference procedures for CO₂ and H₂O separately. If the CO₂ and H₂O levels used are higher than the maximum levels expected during testing, you may scale down each observed interference value by multiplying the observed interference by the ratio of the maximum expected concentration value to the actual value used during this procedure. You may run the separate interference procedures concentrations of H₂O (down to 0.025 mol/mol H₂O content) that are lower than the maximum levels expected during testing, but you must scale up the observed H₂O interference by multiplying the observed interference by the ratio of the maximum expected H₂O concentration value to the actual value used during this procedure. The sum of the two scaled interference values must meet the tolerance in paragraph (c) of this section.

* * * * *

■ 85. Section 1065.360 is revised to read as follows:

§ 1065.360 FID optimization and verification.

(a) *Scope and frequency.* For all FID analyzers, calibrate the FID upon initial installation. Repeat the calibration as needed using good engineering judgment. For a FID that measures THC, perform the following steps:

(1) Optimize the response to various hydrocarbons after initial analyzer installation and after major maintenance as described in paragraph (c) of this section.

(2) Determine the methane (CH₄) response factor after initial analyzer installation and after major maintenance as described in paragraph (d) of this section.

(3) Verify the methane (CH₄) response within 185 days before testing as described in paragraph (e) of this section.

(b) *Calibration.* Use good engineering judgment to develop a calibration procedure, such as one based on the FID-analyzer manufacturer's instructions and recommended frequency for calibrating the FID.

Alternately, you may remove system components for off-site calibration. For a FID that measures THC, calibrate using C₃H₈ calibration gases that meet the specifications of § 1065.750. For a FID that measures CH₄, calibrate using CH₄ calibration gases that meet the specifications of § 1065.750. We recommend FID analyzer zero and span gases that contain approximately the flow-weighted mean concentration of O₂

expected during testing. If you use a FID to measure methane (CH_4) downstream of a nonmethane cutter, you may calibrate that FID using CH_4 calibration gases with the cutter. Regardless of the calibration gas composition, calibrate on a carbon number basis of one (C_1). For example, if you use a C_3H_8 span gas of concentration $200 \mu\text{mol/mol}$, span the FID to respond with a value of $600 \mu\text{mol/mol}$. As another example, if you use a CH_4 span gas with a concentration of $200 \mu\text{mol/mol}$, span the FID to respond with a value of $200 \mu\text{mol/mol}$.

(c) *THC FID response optimization.* This procedure is only for FID analyzers that measure THC. Use good engineering judgment for initial instrument start-up and basic operating adjustment using FID fuel and zero air. Heated FIDs must be within their required operating temperature ranges. Optimize FID response at the most common analyzer range expected during emission testing. Optimization involves adjusting flows and pressures of FID fuel, burner air, and sample to minimize response variations to various hydrocarbon species in the exhaust. Use good engineering judgment to trade off peak FID response to propane calibration gases to achieve minimal response variations to different hydrocarbon species. For an example of trading off response to propane for relative responses to other hydrocarbon species, see SAE 770141 (incorporated by reference in § 1065.1010). Determine the optimum flow rates and/or pressures for FID fuel, burner air, and sample and record them for future reference.

(d) *THC FID CH_4 response factor determination.* This procedure is only for FID analyzers that measure THC. Since FID analyzers generally have a different response to CH_4 versus C_3H_8 , determine each THC FID analyzer's CH_4 response factor, $RF_{\text{CH}_4[\text{THC-FID}]}$, after FID optimization. Use the most recent $RF_{\text{CH}_4[\text{THC-FID}]}$ measured according to this section in the calculations for HC determination described in § 1065.660 to compensate for CH_4 response. Determine $RF_{\text{CH}_4[\text{THC-FID}]}$ as follows, noting that you do not determine $RF_{\text{CH}_4[\text{THC-FID}]}$ for FIDs that are calibrated and spanned using CH_4 with a nonmethane cutter:

(1) Select a C_3H_8 span gas concentration that you use to span your analyzers before emission testing. Use only span gases that meet the specifications of § 1065.750. Record the C_3H_8 concentration of the gas.

(2) Select a CH_4 span gas concentration that you use to span your analyzers before emission testing. Use only span gases that meet the

specifications of § 1065.750. Record the CH_4 concentration of the gas.

(3) Start and operate the FID analyzer according to the manufacturer's instructions.

(4) Confirm that the FID analyzer has been calibrated using C_3H_8 . Calibrate on a carbon number basis of one (C_1). For example, if you use a C_3H_8 span gas of concentration $200 \mu\text{mol/mol}$, span the FID to respond with a value of $600 \mu\text{mol/mol}$.

(5) Zero the FID with a zero gas that you use for emission testing.

(6) Span the FID with the C_3H_8 span gas that you selected under paragraph (d)(1) of this section.

(7) Introduce at the sample port of the FID analyzer, the CH_4 span gas that you selected under paragraph (d)(2) of this section.

(8) Allow time for the analyzer response to stabilize. Stabilization time may include time to purge the analyzer and to account for its response.

(9) While the analyzer measures the CH_4 concentration, record 30 seconds of sampled data. Calculate the arithmetic mean of these values.

(10) Divide the mean measured concentration by the recorded span concentration of the CH_4 calibration gas. The result is the FID analyzer's response factor for CH_4 , $RF_{\text{CH}_4[\text{THC-FID}]}$.

(e) *THC FID methane (CH_4) response verification.* This procedure is only for FID analyzers that measure THC. If the value of $RF_{\text{CH}_4[\text{THC-FID}]}$ from paragraph (d) of this section is within $\pm 5.0\%$ of its most recent previously determined value, the THC FID passes the methane response verification. For example, if the most recent previous value for $RF_{\text{CH}_4[\text{THC-FID}]}$ was 1.05 and it changed by ± 0.05 to become 1.10 or it changed by -0.05 to become 1.00, either case would be acceptable because $\pm 4.8\%$ is less than $\pm 5.0\%$. Verify $RF_{\text{CH}_4[\text{THC-FID}]}$ as follows:

(1) First verify that the flow rates and/or pressures of FID fuel, burner air, and sample are each within $\pm 0.5\%$ of their most recent previously recorded values, as described in paragraph (c) of this section. You may adjust these flow rates as necessary. Then determine the $RF_{\text{CH}_4[\text{THC-FID}]}$ as described in paragraph (d) of this section and verify that it is within the tolerance specified in this paragraph (e).

(2) If $RF_{\text{CH}_4[\text{THC-FID}]}$ is not within the tolerance specified in this paragraph (e), re-optimize the FID response as described in paragraph (c) of this section.

(3) Determine a new $RF_{\text{CH}_4[\text{THC-FID}]}$ as described in paragraph (d) of this section. Use this new value of $RF_{\text{CH}_4[\text{THC-FID}]}$ in the calculations for HC

determination, as described in § 1065.660.

■ 86. Section 1065.362 is amended by revising paragraph (d) to read as follows:

§ 1065.362 Non-stoichiometric raw exhaust FID O_2 interference verification.

* * * * *

(d) *Procedure.* Determine FID O_2 interference as follows, noting that you may use one or more gas dividers to create the reference gas concentrations that are required to perform this verification:

(1) Select three span reference gases that contain a C_3H_8 concentration that you use to span your analyzers before emission testing. Use only span gases that meet the specifications of § 1065.750. You may use CH_4 span reference gases for FIDs calibrated on CH_4 with a nonmethane cutter. Select the three balance gas concentrations such that the concentrations of O_2 and N_2 represent the minimum, maximum, and average O_2 concentrations expected during testing. The requirement for using the average O_2 concentration can be removed if you choose to calibrate the FID with span gas balanced with the average expected oxygen concentration.

(2) Confirm that the FID analyzer meets all the specifications of § 1065.360.

(3) Start and operate the FID analyzer as you would before an emission test. Regardless of the FID burner's air source during testing, use zero air as the FID burner's air source for this verification.

(4) Zero the FID analyzer using the zero gas used during emission testing.

(5) Span the FID analyzer using a span gas that you use during emission testing.

(6) Check the zero response of the FID analyzer using the zero gas used during emission testing. If the mean zero response of 30 seconds of sampled data is within $\pm 0.5\%$ of the span reference value used in paragraph (d)(5) of this section, then proceed to the next step; otherwise restart the procedure at paragraph (d)(4) of this section.

(7) Check the analyzer response using the span gas that has the minimum concentration of O_2 expected during testing. Record the mean response of 30 seconds of stabilized sample data as

$X_{\text{O}_2\text{minHC}}$.

(8) Check the zero response of the FID analyzer using the zero gas used during emission testing. If the mean zero response of 30 seconds of stabilized sample data is within $\pm 0.5\%$ of the span reference value used in paragraph (d)(5) of this section, then proceed to the next step; otherwise restart the procedure at paragraph (d)(4) of this section.

(9) Check the analyzer response using the span gas that has the average concentration of O₂ expected during testing. Record the mean response of 30 seconds of stabilized sample data as $X_{O_2\text{avgHC}}$.

(10) Check the zero response of the FID analyzer using the zero gas used during emission testing. If the mean zero response of 30 seconds of stabilized sample data is within $\pm 0.5\%$ of the span reference value used in paragraph (d)(5) of this section, proceed to the next step; otherwise restart the procedure at paragraph (d)(4) of this section.

(11) Check the analyzer response using the span gas that has the maximum concentration of O₂ expected during testing. Record the mean response of 30 seconds of stabilized sample data as $X_{O_2\text{maxHC}}$.

(12) Check the zero response of the FID analyzer using the zero gas used during emission testing. If the mean zero response of 30 seconds of stabilized sample data is within $\pm 0.5\%$ of the span reference value used in paragraph (d)(5) of this section, then proceed to the next step; otherwise restart the procedure at paragraph (d)(4) of this section.

(13) Calculate the percent difference between $X_{O_2\text{maxHC}}$ and its reference gas concentration. Calculate the percent difference between $X_{O_2\text{avgHC}}$ and its reference gas concentration. Calculate the percent difference between $X_{O_2\text{minHC}}$ and its reference gas concentration. Determine the maximum percent difference of the three. This is the O₂ interference.

(14) If the O₂ interference is within $\pm 2\%$, the FID passes the O₂ interference verification; otherwise perform one or more of the following to address the deficiency:

(i) Repeat the verification to determine if a mistake was made during the procedure.

(ii) Select zero and span gases for emission testing that contain higher or lower O₂ concentrations and repeat the verification.

(iii) Adjust FID burner air, fuel, and sample flow rates. Note that if you adjust these flow rates on a THC FID to meet the O₂ interference verification, you have reset RF_{CH_4} for the next RF_{CH_4} verification according to § 1065.360. Repeat the O₂ interference verification after adjustment and determine RF_{CH_4} .

(iv) Repair or replace the FID and repeat the O₂ interference verification.

(v) Demonstrate that the deficiency does not adversely affect your ability to demonstrate compliance with the applicable emission standards.

■ 87. Section 1065.365 is revised to read as follows:

§ 1065.365 Nonmethane cutter penetration fractions.

(a) *Scope and frequency.* If you use a FID analyzer and a nonmethane cutter (NMC) to measure methane (CH₄), determine the nonmethane cutter's penetration fractions of methane, PF_{CH_4} , and ethane, $PF_{C_2H_6}$. As detailed in this section, these penetration fractions may be determined as a combination of NMC penetration fractions and FID analyzer response factors, depending on your particular NMC and FID analyzer configuration. Perform this verification after installing the nonmethane cutter. Repeat this verification within 185 days of testing to verify that the catalytic activity of the cutter has not deteriorated. Note that because nonmethane cutters can deteriorate rapidly and without warning if they are operated outside of certain ranges of gas concentrations and outside of certain temperature ranges, good engineering judgment may dictate that you determine a nonmethane cutter's penetration fractions more frequently.

(b) *Measurement principles.* A nonmethane cutter is a heated catalyst that removes nonmethane hydrocarbons from an exhaust sample stream before the FID analyzer measures the remaining hydrocarbon concentration. An ideal nonmethane cutter would have a methane penetration fraction, PF_{CH_4} , of 1.000, and the penetration fraction for all other nonmethane hydrocarbons would be 0.000, as represented by $PF_{C_2H_6}$. The emission calculations in § 1065.660 use the measured values from this verification to account for less than ideal NMC performance.

(c) *System requirements.* We do not limit NMC penetration fractions to a certain range. However, we recommend that you optimize a nonmethane cutter by adjusting its temperature to achieve a $PF_{CH_4} > 0.85$ and a $PF_{C_2H_6} < 0.02$, as determined by paragraphs (d), (e), or (f) of this section, as applicable. If we use a nonmethane cutter for testing, it will meet this recommendation. If adjusting NMC temperature does not result in achieving both of these specifications simultaneously, we recommend that you replace the catalyst material. Use the most recently determined penetration values from this section to calculate HC emissions according to § 1065.660 and § 1065.665 as applicable.

(d) *Procedure for a FID calibrated with the NMC.* The method described in this paragraph (d) is recommended over the procedures specified in paragraphs (e) and (f) of this section. If your FID arrangement is such that a FID is always calibrated to measure CH₄ with the NMC, then span that FID with the NMC using a CH₄ span gas, set the product of

that FID's CH₄ response factor and CH₄ penetration fraction, $RFPF_{CH_4[NMC-FID]}$, equal to 1.0 for all emission calculations, and determine its combined ethane (C₂H₆) response factor and penetration fraction, $RFPF_{C_2H_6[NMC-FID]}$ as follows:

(1) Select a CH₄ gas mixture and a C₂H₆ analytical gas mixture and ensure that both mixtures meet the specifications of § 1065.750. Select a CH₄ concentration that you would use for spanning the FID during emission testing and select a C₂H₆ concentration that is typical of the peak NMHC concentration expected at the hydrocarbon standard or equal to THC analyzer's span value.

(2) Start, operate, and optimize the nonmethane cutter according to the manufacturer's instructions, including any temperature optimization.

(3) Confirm that the FID analyzer meets all the specifications of § 1065.360.

(4) Start and operate the FID analyzer according to the manufacturer's instructions.

(5) Zero and span the FID with the cutter and use CH₄ span gas to span the FID with the cutter. Note that you must span the FID on a C₁ basis. For example, if your span gas has a CH₄ reference value of 100 $\mu\text{mol/mol}$, the correct FID response to that span gas is 100 $\mu\text{mol/mol}$ because there is one carbon atom per CH₄ molecule.

(6) Introduce the C₂H₆ analytical gas mixture upstream of the nonmethane cutter.

(7) Allow time for the analyzer response to stabilize. Stabilization time may include time to purge the nonmethane cutter and to account for the analyzer's response.

(8) While the analyzer measures a stable concentration, record 30 seconds of sampled data. Calculate the arithmetic mean of these data points.

(9) Divide the mean by the reference value of C₂H₆, converted to a C₁ basis. The result is the C₂H₆ combined response factor and penetration fraction, $RFPF_{C_2H_6[NMC-FID]}$. Use this combined response factor and penetration fraction and the product of the CH₄ response factor and CH₄ penetration fraction, $RFPF_{CH_4[NMC-FID]}$, set to 1.0 in emission calculations according to § 1065.660(b)(2)(i) or § 1065.665, as applicable.

(e) *Procedure for a FID calibrated with propane, bypassing the NMC.* If you use a FID with an NMC that is calibrated with propane, C₃H₈, by bypassing the NMC, determine its penetration fractions, $PF_{C_2H_6[NMC-FID]}$ and $PF_{CH_4[NMC-FID]}$, as follows:

(1) Select CH₄ and C₂H₆ analytical gas mixtures that meet the specifications of § 1065.750 with the CH₄ concentration typical of its peak concentration expected at the hydrocarbon standard and the C₂H₆ concentration typical of the peak total hydrocarbon (THC) concentration expected at the hydrocarbon standard or the THC analyzer span value.

(2) Start and operate the nonmethane cutter according to the manufacturer's instructions, including any temperature optimization.

(3) Confirm that the FID analyzer meets all the specifications of § 1065.360.

(4) Start and operate the FID analyzer according to the manufacturer's instructions.

(5) Zero and span the FID as you would during emission testing. Span the FID by bypassing the cutter and by using C₃H₈ span gas to span the FID. Note that you must span the FID on a C₁ basis. For example, if your span gas has a propane reference value of 100 μmol/mol, the correct FID response to that span gas is 300 μmol/mol because there are three carbon atoms per C₃H₈ molecule.

(6) Introduce the C₂H₆ analytical gas mixture upstream of the nonmethane cutter at the same point the zero gas was introduced.

(7) Allow time for the analyzer response to stabilize. Stabilization time may include time to purge the nonmethane cutter and to account for the analyzer's response.

(8) While the analyzer measures a stable concentration, record 30 seconds of sampled data. Calculate the arithmetic mean of these data points.

(9) Reroute the flow path to bypass the nonmethane cutter, introduce the C₂H₆ analytical gas mixture to the bypass, and repeat the steps in paragraphs (e)(7) through (8) of this section.

(10) Divide the mean C₂H₆ concentration measured through the nonmethane cutter by the mean concentration measured after bypassing the nonmethane cutter. The result is the C₂H₆ penetration fraction, $PF_{C_2H_6[NMC-FID]}$. Use this penetration fraction according to § 1065.660(b)(2)(ii) or § 1065.665, as applicable.

(11) Repeat the steps in paragraphs (e)(6) through (10) of this section, but with the CH₄ analytical gas mixture instead of C₂H₆. The result will be the CH₄ penetration fraction, $PF_{CH_4[NMC-FID]}$. Use this penetration fraction according to § 1065.660(b)(2)(ii) or § 1065.665, as applicable.

(f) *Procedure for a FID calibrated with methane, bypassing the NMC.* If you use

a FID with an NMC that is calibrated with methane, CH₄, by bypassing the NMC, determine its combined ethane (C₂H₆) response factor and penetration fraction, $RFPF_{C_2H_6[NMC-FID]}$, as well as its CH₄ penetration fraction, $PF_{CH_4[NMC-FID]}$, as follows:

(1) Select CH₄ and C₂H₆ analytical gas mixtures that meet the specifications of § 1065.750, with the CH₄ concentration typical of its peak concentration expected at the hydrocarbon standard and the C₂H₆ concentration typical of the peak total hydrocarbon (THC) concentration expected at the hydrocarbon standard or the THC analyzer span value.

(2) Start and operate the nonmethane cutter according to the manufacturer's instructions, including any temperature optimization.

(3) Confirm that the FID analyzer meets all the specifications of § 1065.360.

(4) Start and operate the FID analyzer according to the manufacturer's instructions.

(5) Zero and span the FID as you would during emission testing. Span the FID with CH₄ span gas by bypassing the cutter. Note that you must span the FID on a C₁ basis. For example, if your span gas has a methane reference value of 100 μmol/mol, the correct FID response to that span gas is 100 μmol/mol because there is one carbon atom per CH₄ molecule.

(6) Introduce the C₂H₆ analytical gas mixture upstream of the nonmethane cutter at the same point the zero gas was introduced.

(7) Allow time for the analyzer response to stabilize. Stabilization time may include time to purge the nonmethane cutter and to account for the analyzer's response.

(8) While the analyzer measures a stable concentration, record 30 seconds of sampled data. Calculate the arithmetic mean of these data points.

(9) Reroute the flow path to bypass the nonmethane cutter, introduce the C₂H₆ analytical gas mixture to the bypass, and repeat the steps in paragraphs (e)(7) and (8) of this section.

(10) Divide the mean C₂H₆ concentration measured through the nonmethane cutter by the mean concentration measured after bypassing the nonmethane cutter. The result is the C₂H₆ combined response factor and penetration fraction, $RFPF_{C_2H_6[NMC-FID]}$. Use this combined response factor and penetration fraction according to § 1065.660(b)(2)(iii) or § 1065.665, as applicable.

(11) Repeat the steps in paragraphs (e)(6) through (10) of this section, but with the CH₄ analytical gas mixture

instead of C₂H₆. The result will be the CH₄ penetration fraction, $PF_{CH_4[NMC-FID]}$. Use this penetration fraction according to § 1065.660(b)(2)(iii) or § 1065.665, as applicable.

■ 88. Section 1065.370 is amended by revising paragraphs (d), (e), and (g)(1) to read as follows:

§ 1065.370 CLD CO₂ and H₂O quench verification.

* * * * *

(d) *CO₂ quench verification procedure.* Use the following method to determine CO₂ quench, or use good engineering judgment to develop a different protocol:

(1) Use PTFE or stainless steel tubing to make necessary connections.

(2) Connect a pressure-regulated CO₂ span gas to the port of a gas divider that meets the specifications in § 1065.248 at the appropriate time. Use a CO₂ span gas that meets the specifications of § 1065.750 and attempt to use a concentration that is approximately twice the maximum CO₂ concentration expected to enter the CLD sample port during testing, if available.

(3) Connect a pressure-regulated purified N₂ gas to the port of a gas divider that meets the specifications in § 1065.248 at the appropriate time. Use a purified N₂ gas that meets the specifications of § 1065.750.

(4) Connect a pressure-regulated NO span gas to the port of the gas divider that meets the specifications in § 1065.248. Use an NO span gas that meets the specifications of § 1065.750. Attempt to use an NO concentration that is approximately twice the maximum NO concentration expected during testing, if available.

(5) Configure the gas divider such that nearly equal amounts of the span gas and balance gas are blended with each other. Apply viscosity corrections as necessary to appropriately ensure correct gas division.

(6) While flowing NO and CO₂ through the gas divider, stabilize the CO₂ concentration downstream of the gas divider and measure the CO₂ concentration with an NDIR analyzer that has been prepared for emission testing. You may alternatively determine the CO₂ concentration from the gas divider cut-point, applying viscosity correction as necessary to ensure accurate gas division. Record this concentration, x_{CO_2meas} , and use it in the quench verification calculations in § 1065.675.

(7) Measure the NO concentration downstream of the gas divider. If the CLD has an operating mode in which it detects NO-only, as opposed to total NO_x, operate the CLD in the NO-only

operating mode. Record this concentration, X_{NO,CO_2} , and use it in the quench verification calculations in § 1065.675.

(8) Switch the flow of CO₂ off and start the flow of 100% purified N₂ to the inlet port of the gas divider. Monitor the CO₂ at the gas divider's outlet until its concentration stabilizes at zero.

(9) Measure NO concentration at the gas divider's outlet. Record this value, X_{NO,N_2} , and use it in the quench verification calculations in § 1065.675.

(10) Use the values recorded according to this paragraph (d) of this section and paragraph (e) of this section to calculate quench as described in § 1065.675.

(e) *H₂O quench verification procedure.* Use the following method to determine H₂O quench, or use good engineering judgment to develop a different protocol:

(1) Use PTFE or stainless steel tubing to make necessary connections.

(2) If the CLD has an operating mode in which it detects NO-only, as opposed to total NO_x, operate the CLD in the NO-only operating mode.

(3) Measure an NO calibration span gas that meets the specifications of § 1065.750 and is near the maximum concentration expected during testing. Record this concentration, X_{NOdry} .

(4) Humidify the NO span gas by bubbling it through distilled water in a sealed vessel. If the sample is not passed through a dryer, control the vessel temperature to generate an H₂O level at least as high as the maximum expected during testing. If the sample is passed through a dryer during testing, control the vessel temperature to generate an H₂O level at least as high as the level determined in § 1065.145(d)(2). We recommend that you humidify the gas to the highest sample dewpoint that you estimate at the CLD inlet during emission sampling. Regardless of the humidity during this test, the quench verification calculations in § 1065.675 scale the recorded quench to the highest dewpoint expected for flow entering the CLD sample port during emission sampling.

(5) Introduce the humidified NO test gas into the sample system. You may introduce it downstream of any sample dryer, if one is used during testing.

(6) Measure the humidified gas dewpoint, T_{dew} , and pressure, p_{total} , as close as possible to the analyzer inlet.

(7) Downstream of the vessel, maintain the humidified NO test gas temperature at least 5 °C above its dewpoint.

(8) Allow time for the analyzer response to stabilize. Stabilization time may include time to purge the transfer

line and to account for analyzer response.

(9) While the analyzer measures the sample's concentration, record the analyzer's output for 30 seconds. Calculate the arithmetic mean of these data. This mean is X_{NOmeas} .

(10) Set X_{NOWet} equal to X_{NOmeas} from paragraph (e)(9) of this section.

(11) Use X_{NOWet} to calculate the quench according to § 1065.675.

* * * * *

(g) * * *

(1) You may omit this verification if you can show by engineering analysis that for your NO_x sampling system and your emission calculations procedures, the combined CO₂ and H₂O interference for your NO_x CLD analyzer always affects your brake-specific NO_x emission results within no more than ±1.0% of the applicable NO_x standard.

* * * * *

■ 89. Section 1065.372 is amended by revising paragraphs (d)(7) and (e)(1) to read as follows:

§ 1065.372 NDUV analyzer HC and H₂O interference verification.

* * * * *

(d) * * *

(7) Multiply this difference by the ratio of the flow-weighted mean HC concentration expected at the standard to the HC concentration measured during the verification. The analyzer meets the interference verification of this section if this result is within ±2% of the NO_x concentration expected at the standard.

(e) * * *

(1) You may omit this verification if you can show by engineering analysis that for your NO_x sampling system and your emission calculations procedures, the combined HC and H₂O interference for your NO_x NDUV analyzer always affects your brake-specific NO_x emission results by less than 0.5% of the applicable NO_x standard.

* * * * *

■ 90. Section 1065.376 is revised to read as follows:

§ 1065.376 Chiller NO₂ penetration.

(a) *Scope and frequency.* If you use a chiller to dry a sample upstream of a NO_x measurement instrument, but you don't use an NO₂-to-NO converter upstream of the chiller, you must perform this verification for chiller NO₂ penetration. Perform this verification after initial installation and after major maintenance.

(b) *Measurement principles.* A chiller removes water, which can otherwise interfere with a NO_x measurement. However, liquid water remaining in an

improperly designed chiller can remove NO₂ from the sample. If a chiller is used without an NO₂-to-NO converter upstream, it could remove NO₂ from the sample prior NO_x measurement.

(c) *System requirements.* A chiller must allow for measuring at least 95% of the total NO₂ at the maximum expected concentration of NO₂.

(d) *Procedure.* Use the following procedure to verify chiller performance:

(1) *Instrument setup.* Follow the analyzer and chiller manufacturers' start-up and operating instructions. Adjust the analyzer and chiller as needed to optimize performance.

(2) *Equipment setup and data collection.* (i) Zero and span the total NO_x gas analyzer(s) as you would before emission testing.

(ii) Select an NO₂ calibration gas, balance gas of dry air, that has an NO₂ concentration within ±5% of the maximum NO₂ concentration expected during testing.

(iii) Overflow this calibration gas at the gas sampling system's probe or overflow fitting. Allow for stabilization of the total NO_x response, accounting only for transport delays and instrument response.

(iv) Calculate the mean of 30 seconds of recorded total NO_x data and record this value as X_{NOxref} .

(v) Stop flowing the NO₂ calibration gas.

(vi) Next saturate the sampling system by overflowing a dewpoint generator's output, set at a dewpoint of 50 °C, to the gas sampling system's probe or overflow fitting. Sample the dewpoint generator's output through the sampling system and chiller for at least 10 minutes until the chiller is expected to be removing a constant rate of water.

(vii) Immediately switch back to overflowing the NO₂ calibration gas used to establish X_{NOxref} . Allow for stabilization of the total NO_x response, accounting only for transport delays and instrument response. Calculate the mean of 30 seconds of recorded total NO_x data and record this value as

$X_{NOxmeas}$.

(viii) Correct $X_{NOxmeas}$ to X_{NOxdry} based upon the residual water vapor that passed through the chiller at the chiller's outlet temperature and pressure.

(3) *Performance evaluation.* If X_{NOxdry} is less than 95% of X_{NOxref} , repair or replace the chiller.

(e) *Exceptions.* The following exceptions apply:

(1) You may omit this verification if you can show by engineering analysis that for your NO_x sampling system and your emission calculations procedures, the chiller always affects your brake-

specific NO_x emission results by less than 0.5% of the applicable NO_x standard.

(2) You may use a chiller that you determine does not meet this verification, as long as you try to correct the problem and the measurement deficiency does not adversely affect your ability to show that engines comply with all applicable emission standards.

■ 91. Section 1065.378 is amended by revising paragraphs (d) and (e)(1) to read as follows:

§ 1065.378 NO₂-to-NO converter conversion verification.

* * * * *

(d) *Procedure.* Use the following procedure to verify the performance of a NO₂-to-NO converter:

(1) *Instrument setup.* Follow the analyzer and NO₂-to-NO converter manufacturers' start-up and operating instructions. Adjust the analyzer and converter as needed to optimize performance.

(2) *Equipment setup.* Connect an ozonator's inlet to a zero-air or oxygen source and connect its outlet to one port of a three-way tee fitting. Connect an NO span gas to another port, and

connect the NO₂-to-NO converter inlet to the last port.

(3) *Adjustments and data collection.* Perform this check as follows:

(i) Set ozonator air off, turn ozonator power off, and set the analyzer to NO mode. Allow for stabilization, accounting only for transport delays and instrument response.

(ii) Use an NO concentration that is representative of the peak total NO_x concentration expected during testing. The NO₂ content of the gas mixture shall be less than 5% of the NO concentration. Record the concentration of NO by calculating the mean of 30 seconds of sampled data from the analyzer and record this value as x_{NOref} .

(iii) Turn on the ozonator O₂ supply and adjust the O₂ flow rate so the NO indicated by the analyzer is about 10 percent less than x_{NOref} . Record the concentration of NO by calculating the mean of 30 seconds of sampled data from the analyzer and record this value as $x_{NO+O2mix}$.

(iv) Switch the ozonator on and adjust the ozone generation rate so the NO measured by the analyzer is 20 percent of x_{NOref} , while maintaining at least 10 percent unreacted NO. Record the concentration of NO by calculating the

mean of 30 seconds of sampled data from the NO_x analyzer and record this value as x_{NOmeas} .

(v) Switch the NO_x analyzer to NO_x mode and measure total NO_x. Record the concentration of NO_x by calculating the mean of 30 seconds of sampled data from the analyzer and record this value as $x_{NOxmeas}$.

(vi) Switch off the ozonator but maintain gas flow through the system. The NO_x analyzer will indicate the NO_x in the NO + O₂ mixture. Record the concentration of NO_x by calculating the mean of 30 seconds of sampled data from the analyzer and record this value as $x_{NOx+O2mix}$.

(vii) Turn off the ozonator O₂ supply. The NO_x analyzer will indicate the NO_x in the original NO-in-N₂ mixture. Record the concentration of NO_x by calculating the mean of 30 seconds of sampled data from the analyzer and record this value as x_{NOxref} . This value should be no more than 5 percent above the x_{NOref} value.

(4) *Performance evaluation.* Calculate the efficiency of the NO_x converter efficiency by substituting the concentrations obtained into the following equation:

$$\text{Efficiency (\%)} = \left(1 + \frac{x_{NOxmeas} - x_{NOx+O2mix}}{x_{NO+O2mix} - x_{NOmeas}} \right) \times 100$$

(5) If the result is less than 95%, repair or replace the NO₂-to-NO converter.

(e) * * *

(1) You may omit this verification if you can show by engineering analysis that for your NO_x sampling system and your emission calculations procedures, the converter always affects your brake-specific NO_x emission results by less than 0.5% of the applicable NO_x standard.

* * * * *

■ 92. Section 1065.390 is revised to read as follows:

§ 1065.390 PM balance verifications and weighing process verification.

(a) *Scope and frequency.* This section describes three verifications.

(1) Independent verification of PM balance performance within 370 days before weighing any filter.

(2) Zero and span the balance within 12 h before weighing any filter.

(3) Verify that the mass determination of reference filters before and after a filter weighing session are less than a specified tolerance.

(b) *Independent verification.* Have the balance manufacturer (or a representative approved by the balance manufacturer) verify the balance performance within 370 days of testing.

(c) *Zeroing and spanning.* You must verify balance performance by zeroing and spanning it with at least one calibration weight, and any weights you use must that meet the specifications in § 1065.790 to perform this verification.

(1) Use a manual procedure in which you zero the balance and span the balance with at least one calibration weight. If you normally use mean values by repeating the weighing process to improve the accuracy and precision of PM measurements, use the same process to verify balance performance.

(2) You may use an automated procedure to verify balance performance. For example many balances have internal calibration weights that are used automatically to verify balance performance. Note that if you use internal balance weights, the weights must meet the specifications in § 1065.790 to perform this verification.

(d) *Reference sample weighing.* Verify all mass readings during a weighing

session by weighing reference PM sample media (e.g., filters) before and after a weighing session. A weighing session may be as short as desired, but no longer than 80 hours, and may include both pre-test and post-test mass readings. We recommend that weighing sessions be eight hours or less. Successive mass determinations of each reference PM sample media (e.g., filter) must return the same value within ±10 µg or ±10% of the net PM mass expected at the standard (if known), whichever is higher. If successive reference PM sample media (e.g., filter) weighing events fail this criterion, invalidate all individual test media (e.g., filter) mass readings occurring between the successive reference media (e.g., filter) mass determinations. You may reweigh these media (e.g., filter) in another weighing session. If you invalidate a pre-test media (e.g., filter) mass determination, that test interval is void. Perform this verification as follows:

(1) Keep at least two samples of unused PM sample media (e.g., filters) in the PM-stabilization environment. Use these as references. If you collect

PM with filters, select unused filters of the same material and size for use as references. You may periodically replace references, using good engineering judgment.

(2) Stabilize references in the PM stabilization environment. Consider references stabilized if they have been in the PM-stabilization environment for a minimum of 30 min, and the PM-stabilization environment has been within the specifications of § 1065.190(d) for at least the preceding 60 min.

(3) Exercise the balance several times with a reference sample. We recommend weighing ten samples without recording the values.

(4) Zero and span the balance. Using good engineering judgment, place a test mass such as a calibration weight on the balance, then remove it. After spanning, confirm that the balance returns to a zero reading within the normal stabilization time.

(5) Weigh each of the reference media (e.g., filters) and record their masses. We recommend using substitution weighing as described in § 1065.590(j). If you normally use mean values by repeating the weighing process to improve the accuracy and precision of the reference media (e.g., filter) mass, you must use mean values of sample media (e.g., filter) masses.

(6) Record the balance environment dewpoint, ambient temperature, and atmospheric pressure.

(7) Use the recorded ambient conditions to correct results for buoyancy as described in § 1065.690. Record the buoyancy-corrected mass of each of the references.

(8) Subtract each reference media's (e.g., filter's) buoyancy-corrected reference mass from its previously measured and recorded buoyancy-corrected mass.

(9) If any of the reference filters' observed mass changes by more than that allowed under this paragraph, you must invalidate all PM mass determinations made since the last successful reference media (e.g., filter) mass validation. You may discard reference PM media (e.g., filters) if only one of the filter's mass changes by more than the allowable amount and you can positively identify a special cause for that filter's mass change that would not have affected other in-process filters. Thus, the validation can be considered a success. In this case, you do not have to include the contaminated reference media when determining compliance with paragraph (d)(10) of this section, but the affected reference filter must be immediately

discarded and replaced prior to the next weighing session.

(10) If any of the reference masses change by more than that allowed under this paragraph (d), invalidate all PM results that were determined between the two times that the reference masses were determined. If you discarded reference PM sample media according to paragraph (d)(9) of this section, you must still have at least one reference mass difference that meets the criteria in this paragraph (d). Otherwise, you must invalidate all PM results that were determined between the two times that the reference media (e.g., filters) masses were determined.

Subpart E—[Amended]

■ 93. Section 1065.405 is revised to read as follows:

§ 1065.405 Test engine preparation and maintenance.

This part 1065 describes how to test engines for a variety of purposes, including certification testing, production-line testing, and in-use testing. Depending on which type of testing is being conducted, different preparation and maintenance requirements apply for the test engine.

(a) If you are testing an emission-data engine for certification, make sure it is built to represent production engines. This includes governors that you normally install on production engines. Production engines should also be tested with their installed governors. If you do not install governors on production engines, simulate a governor that is representative of a governor that others will install on your production engines.

(b) Testing generally occurs only after the test engine has undergone a stabilization step (or in-use operation). If the engine has not already been stabilized, run the test engine, with all emission control systems operating, long enough to stabilize emission levels. Note that you must generally use the same stabilization procedures for emission-data engines for which you apply the same deterioration factors so low-hour emission-data engines are consistent with the low-hour engine used to develop the deterioration factor.

(1) Unless otherwise specified in the standard-setting part, you may consider emission levels stable without measurement after 50 h of operation. If the engine needs less operation to stabilize emission levels, record your reasons and the methods for doing this, and give us these records if we ask for them. If the engine will be tested for certification as a low-hour engine, see

the standard-setting part for limits on testing engines to establish low-hour emission levels.

(2) You may stabilize emissions from a catalytic exhaust aftertreatment device by operating it on a different engine, consistent with good engineering judgment. Note that good engineering judgment requires that you consider both the purpose of the test and how your stabilization method will affect the development and application of deterioration factors. For example, this method of stabilization is generally not appropriate for production engines. We may also allow you to stabilize emissions from a catalytic exhaust aftertreatment device by operating it on an engine-exhaust simulator.

(c) Record any maintenance, modifications, parts changes, diagnostic or emissions testing and document the need for each event. You must provide this information if we request it.

(d) For accumulating operating hours on your test engines, select engine operation that represents normal in-use operation for the engine family.

(e) If your engine will be used in a vehicle equipped with a canister for storing evaporative hydrocarbons for eventual combustion in the engine and the test sequence involves a cold-start or hot-start duty cycle, attach a canister to the engine before running an emission test. You may omit using an evaporative canister for any hot-stabilized duty cycles. You may request to omit using an evaporative canister during testing if you can show that it would not affect your ability to show compliance with the applicable emission standards. You may operate the engine without an installed canister for service accumulation. Prior to an emission test, use the following steps to attach a canister to your engine:

(1) Use a canister and plumbing arrangement that represents the in-use configuration of the largest capacity canister in all expected applications.

(2) Use a canister that is fully loaded with fuel vapors.

(3) Connect the canister's purge port to the engine.

(4) Plug the canister port that is normally connected to the fuel tank.

■ 94. Section 1065.410 is amended by revising paragraphs (c) and (d) to read as follows:

§ 1065.410 Maintenance limits for stabilized test engines.

* * * * *

(c) Keep a record of the inspection and update your application to document any changes as a result of the inspection. You may use equipment, instruments, or engineering grade tools

to identify bad engine components. Any equipment, instruments, or tools used for scheduled maintenance on emission data engines must be representative of what is planned to be available to dealerships and other service outlets.

(d) If we determine that a part failure, system malfunction, or associated repairs have made the engine's emission controls unrepresentative of production engines, you may no longer use it as an emission-data engine. Also, if your test engine has a major mechanical failure that requires you to take it apart, you may no longer use it as an emission-data engine.

* * * * *

■ 95. Section 1065.415 is amended by revising the introductory text and removing paragraph (a)(3) to read as follows:

§ 1065.415 Durability demonstration.

If the standard-setting part requires durability testing, you must accumulate service in a way that represents how you expect the engine to operate in use. You may accumulate service hours using an accelerated schedule, such as through continuous operation or by using duty cycles that are more aggressive than in-use operation, subject to any pre-approval requirements established in the applicable standard-setting part.

* * * * *

■ 96. The heading to subpart F of part 1065 is revised to read as follows:

Subpart F—Performing an Emission Test Over Specified Duty Cycles

97. Section 1065.501 is amended by revising paragraphs (a) introductory text, (a)(1), and (b) to read as follows:

§ 1065.501 Overview.

(a) Use the procedures detailed in this subpart to measure engine emissions over a specified duty cycle. Refer to subpart J of this part for field test procedures that describe how to measure emissions during in-use engine operation. This section describes how to:

(1) Map your engine, if applicable, by recording specified speed and torque data, as measured from the engine's primary output shaft.

* * * * *

(b) An emission test generally consists of measuring emissions and other parameters while an engine follows one or more duty cycles that are specified in the standard-setting part. There are two general types of duty cycles:

(1) *Transient cycles.* Transient duty cycles are typically specified in the standard-setting part as a second-by-

second sequence of speed commands and normalized torque (or power) commands. Operate an engine over a transient cycle such that the speed and torque of the engine's primary output shaft follows the target values.

Proportionally sample emissions and other parameters and use the calculations in subpart G of this part to calculate emissions. Start a transient test according to the standard-setting part, as follows:

(i) A cold-start transient cycle where you start to measure emissions just before starting an engine that has not been warmed up.

(ii) A hot-start transient cycle where you start to measure emissions just before starting a warmed-up engine.

(iii) A hot running transient cycle where you start to measure emissions after an engine is started, warmed up, and running.

(2) *Steady-state cycles.* Steady-state duty cycles are typically specified in the standard-setting part as a list of discrete operating points (modes or notches), where each operating point has one value of a normalized speed command and one value of a normalized torque (or power) command. Ramped-modal cycles for steady-state testing also list test times for each mode and transition times between modes where speed and torque are linearly ramped between modes, even for cycles with % power. Start a steady-state cycle as a hot running test, where you start to measure emissions after an engine is started, warmed up and running. You may run a steady-state duty cycle as a discrete-mode cycle or a ramped-modal cycle, as follows:

(i) *Discrete-mode cycles.* Before emission sampling, stabilize an engine at the first discrete mode. Sample emissions and other parameters for that mode and then stop emission sampling. Record mean values for that mode, and then stabilize the engine at the next mode. Continue to sample each mode discretely and calculate weighted emission results according to the standard-setting part.

(ii) *Ramped-modal cycles.* Perform ramped-modal cycles similar to the way you would perform transient cycles, except that ramped-modal cycles involve mostly steady-state engine operation. Generate a ramped-modal duty cycle as a sequence of second-by-second (1 Hz) reference speed and torque points. Run the ramped-modal duty cycle in the same manner as a transient cycle and use the 1 Hz reference speed and torque values to validate the cycle, even for cycles with % power. Proportionally sample emissions and other parameters during

the cycle and use the calculations in subpart G of this part to calculate emissions.

* * * * *

■ 98. Section 1065.510 is revised to read as follows:

§ 1065.510 Engine mapping.

(a) *Applicability, scope, and frequency.* An engine map is a data set that consists of a series of paired data points that represent the maximum brake torque versus engine speed, measured at the engine's primary output shaft. Map your engine if the standard-setting part requires engine mapping to generate a duty cycle for your engine configuration. Map your engine while it is connected to a dynamometer or other device that can absorb work output from the engine's primary output shaft according to § 1065.110. Configure any auxiliary work inputs and outputs such as hybrid, turbo-compounding, or thermoelectric systems to represent their in-use configurations, and use the same configuration for emission testing. See Figure 1 of § 1065.210. This may involve configuring initial states of charge and rates and times of auxiliary-work inputs and outputs. We recommend that you contact the Designated Compliance Officer before testing to determine how you should configure any auxiliary-work inputs and outputs. Use the most recent engine map to transform a normalized duty cycle from the standard-setting part to a reference duty cycle specific to your engine. Normalized duty cycles are specified in the standard-setting part. You may update an engine map at any time by repeating the engine-mapping procedure. You must map or re-map an engine before a test if any of the following apply:

(1) If you have not performed an initial engine map.

(2) If the atmospheric pressure near the engine's air inlet is not within ± 5 kPa of the atmospheric pressure recorded at the time of the last engine map.

(3) If the engine or emission-control system has undergone changes that might affect maximum torque performance. This includes changing the configuration of auxiliary work inputs and outputs.

(4) If you capture an incomplete map on your first attempt or you do not complete a map within the specified time tolerance. You may repeat mapping as often as necessary to capture a complete map within the specified time.

(b) *Mapping variable-speed engines.* Map variable-speed engines as follows:

(1) Record the atmospheric pressure.

(2) Warm up the engine by operating it. We recommend operating the engine at any speed and at approximately 75% of its expected maximum power. Continue the warm-up until the engine coolant, block, or head absolute temperature is within $\pm 2\%$ of its mean value for at least 2 min or until the engine thermostat controls engine temperature.

(3) Operate the engine at its warm idle speed.

(i) For engines with a low-speed governor, set the operator demand to minimum, use the dynamometer or other loading device to target a torque of zero on the engine's primary output shaft, and allow the engine to govern the speed. Measure this warm idle speed; we recommend recording at least 30 values of speed and using the mean of those values.

(ii) For engines without a low-speed governor, set the dynamometer to target a torque of zero on the engine's primary output shaft, and manipulate the operator demand to control the speed to target the manufacturer-declared value for the lowest engine speed possible with minimum load (also known as manufacturer-declared warm idle speed).

(iii) For all variable-speed engines (with or without a low-speed governor), if a nonzero idle torque is representative of in-use operation, you may target the manufacturer-declared idle torque. If you measure the warm idle speed with the manufacturer-declared torque at this step, you may omit the speed measurement in paragraph (b)(6) of this section.

(4) Set operator demand to maximum and control engine speed at $(95 \pm 1)\%$ of its warm idle speed determined above for at least 15 seconds. For engines with reference duty cycles whose lowest speed is greater than warm idle speed, you may start the map at $(95 \pm 1)\%$ of the lowest reference speed.

(5) Perform one of the following:

(i) For any engine subject only to steady-state duty cycles (i.e., discrete-mode or ramped-modal), you may perform an engine map by using discrete speeds. Select at least 20 evenly spaced setpoints between warm idle and the highest speed above maximum mapped power at which (50 to 75)% of maximum power occurs. If this highest speed is unsafe or unrepresentative (e.g., for ungoverned engines), use good engineering judgment to map up to the maximum safe speed or the maximum representative speed. At each setpoint, stabilize speed and allow torque to stabilize. Record the mean speed and torque at each setpoint. We recommend that you stabilize an engine for at least

15 seconds at each setpoint and record the mean feedback speed and torque of the last (4 to 6) seconds. Use linear interpolation to determine intermediate speeds and torques. Use this series of speeds and torques to generate the power map as described in paragraph (e) of this section.

(ii) For any variable-speed engine, you may perform an engine map by using a continuous sweep of speed by continuing to record the mean feedback speed and torque at 1 Hz or more frequently and increasing speed at a constant rate such that it takes (4 to 6) min to sweep from 95% of warm idle to the highest speed above maximum power at which (50 to 75)% of maximum power occurs. If this highest speed is unsafe or unrepresentative (e.g., for ungoverned engines), use good engineering judgment to map up to the maximum safe speed or the maximum representative speed. Stop recording after you complete the sweep. From the series of mean speed and maximum torque values, use linear interpolation to determine intermediate values. Use this series of speeds and torques to generate the power map as described in paragraph (e) of this section.

(6) For engines with a low-speed governor, if a nonzero idle torque is representative of in-use operation, operate the engine at warm idle with the manufacturer-declared idle torque. Set the operator demand to minimum, use the dynamometer to target the declared idle torque, and allow the engine to govern the speed. Measure this speed and use it as the warm idle speed for cycle generation in § 1065.512. We recommend recording at least 30 values of speed and using the mean of those values. You may map the idle governor at multiple load levels and use this map to determine the measured warm idle speed at the declared idle torque.

(c) *Negative torque mapping.* If your engine is subject to a reference duty cycle that specifies negative torque values (i.e., engine motoring), generate a motoring map by any of the following procedures:

(1) Multiply the positive torques from your map by -40% . Use linear interpolation to determine intermediate values.

(2) Map the amount of negative torque required to motor the engine by repeating paragraph (b) of this section with minimum operator demand.

(3) Determine the amount of negative torque required to motor the engine at the following two points near the ends of the engine's speed range. Operate the engine at these two points at minimum operator demand. Use linear

interpolation to determine intermediate values.

(i) *Low-speed point.* For engines without a low-speed governor, determine the amount of negative torque at warm idle speed. For engines with a low-speed governor, motor the engine above warm idle speed so the governor is inactive and determine the amount of negative torque at that speed.

(ii) *High-speed point.* For engines without a high-speed governor, determine the amount of negative torque at the maximum safe speed or the maximum representative speed. For engines with a high-speed governor, determine the amount of negative torque at a speed at or above n_{hi} per § 1065.610(c)(2).

(d) *Mapping constant-speed engines.* For constant-speed engines, generate a map as follows:

(1) Record the atmospheric pressure.

(2) Warm up the engine by operating it. We recommend operating the engine at approximately 75% of the engine's expected maximum power. Continue the warm-up until the engine coolant, block, or head absolute temperature is within $\pm 2\%$ of its mean value for at least 2 min or until the engine thermostat controls engine temperature.

(3) You may operate the engine with a production constant-speed governor or simulate a constant-speed governor by controlling engine speed with an operator demand control system described in § 1065.110. Use either isochronous or speed-droop governor operation, as appropriate.

(4) With the governor or simulated governor controlling speed using operator demand, operate the engine at no-load governed speed (at high speed, not low idle) for at least 15 seconds.

(5) Record at 1 Hz the mean of feedback speed and torque. Use the dynamometer to increase torque at a constant rate. Unless the standard-setting part specifies otherwise, complete the map such that it takes (2 to 4) min to sweep from no-load governed speed to the lowest speed below maximum mapped power at which the engine develops (85–95)% of maximum mapped power. You may map your engine to lower speeds. Stop recording after you complete the sweep. Use this series of speeds and torques to generate the power map as described in paragraph (e) of this section.

(e) *Power mapping.* For all engines, create a power-versus-speed map by transforming torque and speed values to corresponding power values. Use the mean values from the recorded map data. Do not use any interpolated values. Multiply each torque by its corresponding speed and apply the

appropriate conversion factors to arrive at units of power (kW). Interpolate intermediate power values between these power values, which were calculated from the recorded map data.

(f) *Measured and declared test speeds and torques.* You must select test speeds and torques for cycle generation as required in this paragraph (f).

“Measured” values are either directly measured during the engine mapping process or they are determined from the engine map. “Declared” values are specified by the manufacturer. When both measured and declared values are available, you may use declared test speeds and torques instead of measured speeds and torques if they meet the criteria in this paragraph (f). Otherwise, you must use measured speeds and torques derived from the engine map.

(1) *Measured speeds and torques.* Determine the applicable speeds and torques for the duty cycles you will run:

(i) Measured maximum test speed for variable-speed engines according to § 1065.610.

(ii) Measured maximum test torque for constant-speed engines according to § 1065.610.

(iii) Measured “A”, “B”, and “C” speeds for variable-speed engines according to § 1065.610.

(iv) Measured intermediate speed for variable-speed engines according to § 1065.610.

(v) For variable-speed engines with a low-speed governor, measure warm idle speed according to § 1065.510(b) and use this speed for cycle generation in § 1065.512. For engines with no low-speed governor, instead use the manufacturer-declared warm idle speed.

(2) *Required declared speeds.* You must declare the lowest engine speed possible with minimum load (i.e., manufacturer-declared warm idle speed). This is applicable only to variable-speed engines with no low-speed governor. For engines with no low-speed governor, the declared warm idle speed is used for cycle generation in § 1065.512. Declare this speed in a way that is representative of in-use operation. For example, if your engine is typically connected to an automatic transmission or a hydrostatic transmission, declare this speed at the idle speed at which your engine operates when the transmission is engaged.

(3) *Optional declared speeds.* You may use declared speeds instead of measured speeds as follows:

(i) You may use a declared value for maximum test speed for variable-speed engines if it is within (97.5 to 102.5)% of the corresponding measured value. You may use a higher declared speed if

the length of the “vector” at the declared speed is within 2.0% of the length of the “vector” at the measured value. The term vector refers to the square root of the sum of normalized engine speed squared and the normalized full-load power (at that speed) squared, consistent with the calculations in § 1065.610.

(ii) You may use a declared value for intermediate, “A”, “B”, or “C” speeds for steady-state tests if the declared value is within (97.5 to 102.5)% of the corresponding measured value.

(4) *Required declared torques.* If a nonzero idle or minimum torque is representative of in-use operation, you must declare the appropriate torque as follows:

(i) For variable-speed engines, declare a warm idle torque that is representative of in-use operation. For example, if your engine is typically connected to an automatic transmission or a hydrostatic transmission, declare the torque that occurs at the idle speed at which your engine operates when the transmission is engaged. Use this value for cycle generation. You may use multiple warm idle torques and associated idle speeds in cycle generation for representative testing. For example, for cycles that start the engine and begin with idle, you may start a cycle in idle with the transmission in neutral with zero torque and later switch to a different idle with the transmission in drive with the Curb-Idle Transmission Torque (CITT). For variable-speed engines intended primarily for propulsion of a vehicle with an automatic transmission where that engine is subject to a transient duty cycle with idle operation, you must declare a CITT. You must specify a CITT based on typical applications at the mean of the range of idle speeds you specify at stabilized temperature conditions.

(ii) For constant-speed engines, declare a warm minimum torque that is representative of in-use operation. For example, if your engine is typically connected to a machine that does not operate below a certain minimum torque, declare this torque and use it for cycle generation.

(5) *Optional declared torques.* For constant-speed engines you may declare a maximum test torque. You may use the declared value for cycle generation if it is within (95 to 100)% of the measured value.

(g) *Other mapping procedures.* You may use other mapping procedures if you believe the procedures specified in this section are unsafe or unrepresentative for your engine. Any alternate techniques you use must satisfy the intent of the specified

mapping procedures, which is to determine the maximum available torque at all engine speeds that occur during a duty cycle. Identify any deviations from this section’s mapping procedures when you submit data to us. ■ 99. Section 1065.512 is revised to read as follows:

§ 1065.512 Duty cycle generation.

(a) Generate duty cycles according to this section if the standard-setting part requires engine mapping to generate a duty cycle for your engine configuration. The standard-setting part generally defines applicable duty cycles in a normalized format. A normalized duty cycle consists of a sequence of paired values for speed and torque or for speed and power.

(b) Transform normalized values of speed, torque, and power using the following conventions:

(1) *Engine speed for variable-speed engines.* For variable-speed engines, normalized speed may be expressed as a percentage between warm idle speed, f_{idle} , and maximum test speed, f_{ttest} , or speed may be expressed by referring to a defined speed by name, such as “warm idle,” “intermediate speed,” or “A,” “B,” or “C” speed. Section 1065.610 describes how to transform these normalized values into a sequence of reference speeds, f_{ref} . Running duty cycles with negative or small normalized speed values near warm idle speed may cause low-speed idle governors to activate and the engine torque to exceed the reference torque even though the operator demand is at a minimum. In such cases, we recommend controlling the dynamometer so it gives priority to follow the reference torque instead of the reference speed and let the engine govern the speed. Note that the cycle-validation criteria in § 1065.514 allow an engine to govern itself. This allowance permits you to test engines with enhanced-idle devices and to simulate the effects of transmissions such as automatic transmissions. For example, an enhanced-idle device might be an idle speed value that is normally commanded only under cold-start conditions to quickly warm up the engine and aftertreatment devices. In this case, negative and very low normalized speeds will generate reference speeds below this higher enhanced idle speed and we recommend controlling the dynamometer so it gives priority to follow the reference torque, controlling the operator demand so it gives priority to follow reference speed and let the engine govern the speed when the operator demand is at minimum.

(2) *Engine torque for variable-speed engines.* For variable-speed engines, normalized torque is expressed as a percentage of the mapped torque at the corresponding reference speed. Section 1065.610 describes how to transform normalized torques into a sequence of reference torques, T_{ref} . Section 1065.610 also describes special requirements for modifying transient duty cycles for variable-speed engines intended primarily for propulsion of a vehicle with an automatic transmission. Section 1065.610 also describes under what conditions you may command T_{ref} greater than the reference torque you calculated from a normalized duty cycle. This provision permits you to command T_{ref} values that are limited by a declared minimum torque. For any negative torque commands, command minimum operator demand and use the dynamometer to control engine speed to the reference speed, but if reference speed is so low that the idle governor activates, we recommend using the dynamometer to control torque to zero, CITT, or a declared minimum torque as appropriate. Note that you may omit power and torque points during motoring from the cycle-validation criteria in § 1065.514. Also, use the maximum mapped torque at the minimum mapped speed as the maximum torque for any reference speed at or below the minimum mapped speed.

(3) *Engine torque for constant-speed engines.* For constant-speed engines, normalized torque is expressed as a percentage of maximum test torque, T_{test} . Section 1065.610 describes how to transform normalized torques into a sequence of reference torques, T_{ref} . Section 1065.610 also describes under what conditions you may command T_{ref} greater than the reference torque you calculated from the normalized duty cycle. This provision permits you to command T_{ref} values that are limited by a declared minimum torque.

(4) *Engine power.* For all engines, normalized power is expressed as a percentage of mapped power at maximum test speed, f_{intest} , unless otherwise specified by the standard-setting part. Section 1065.610 describes how to transform these normalized values into a sequence of reference powers, P_{ref} . Convert these reference powers to corresponding torques for operator demand and dynamometer control. Use the reference speed associated with each reference power point for this conversion. As with cycles specified with % torque, issue torque commands more frequently and linearly interpolate between these reference

torque values generated from cycles with % power.

(5) *Ramped-modal cycles.* For ramped modal cycles, generate reference speed and torque values at 1 Hz and use this sequence of points to run the cycle and validate it in the same manner as with a transient cycle. During the transition between modes, linearly ramp the denormalized reference speed and torque values between modes to generate reference points at 1 Hz. Do not linearly ramp the normalized reference torque values between modes and then denormalize them. Do not linearly ramp normalized or denormalized reference power points. These cases will produce nonlinear torque ramps in the denormalized reference torques. If the speed and torque ramp runs through a point above the engine's torque curve, continue to command the reference torques and allow the operator demand to go to maximum. Note that you may omit power and either torque or speed points from the cycle-validation criteria under these conditions as specified in § 1065.514.

(c) For variable-speed engines, command reference speeds and torques sequentially to perform a duty cycle. Issue speed and torque commands at a frequency of at least 5 Hz for transient cycles and at least 1 Hz for steady-state cycles (i.e., discrete-mode and ramped-modal). Linearly interpolate between the 1 Hz reference values specified in the standard-setting part to determine more frequently issued reference speeds and torques. During an emission test, record the feedback speeds and torques at a frequency of at least 5 Hz for transient cycles and at least 1 Hz for steady-state cycles. For transient cycles, you may record the feedback speeds and torques at lower frequencies (as low as 1 Hz) if you record the average value over the time interval between recorded values. Calculate the average values based on feedback values updated at a frequency of at least 5 Hz. Use these recorded values to calculate cycle-validation statistics and total work.

(d) For constant-speed engines, operate the engine with the same production governor you used to map the engine in § 1065.510 or simulate the in-use operation of a governor the same way you simulated it to map the engine in § 1065.510. Command reference torque values sequentially to perform a duty cycle. Issue torque commands at a frequency of at least 5 Hz for transient cycles and at least 1 Hz for steady-state cycles (i.e., discrete-mode, ramped-modal). Linearly interpolate between the 1 Hz reference values specified in the standard-setting part to determine more frequently issued reference torque

values. During an emission test, record the feedback speeds and torques at a frequency of at least 5 Hz for transient cycles and at least 1 Hz for steady-state cycles. For transient cycles, you may record the feedback speeds and torques at lower frequencies (as low as 1 Hz) if you record the average value over the time interval between recorded values. Calculate the average values based on feedback values updated at a frequency of at least 5 Hz. Use these recorded values to calculate cycle-validation statistics and total work.

(e) You may perform practice duty cycles with the test engine to optimize operator demand and dynamometer controls to meet the cycle-validation criteria specified in § 1065.514.

■ 100. Section 1065.514 is revised to read as follows:

§ 1065.514 Cycle-validation criteria for operation over specified duty cycles.

Validate the execution of your duty cycle according to this section unless the standard-setting part specifies otherwise. This section describes how to determine if the engine's operation during the test adequately matched the reference duty cycle. This section applies only to speed, torque, and power from the engine's primary output shaft. Other work inputs and outputs are not subject to cycle-validation criteria. You must compare the original reference duty cycle points generated as described in § 1065.512 to the corresponding feedback values recorded during the test. You may compare reference duty cycle points recorded during the test to the corresponding feedback values recorded during the test as long as the recorded reference values match the original points generated in § 1065.512. The number of points in the validation regression are based on the number of points in the original reference duty cycle generated in § 1065.512. For example if the original cycle has 1199 reference points at 1 Hz, then the regression will have up to 1199 pairs of reference and feedback values at the corresponding moments in the test. The feedback speed and torque signals may be filtered—either in real-time while the test is run or afterward in the analysis program. Any filtering that is used on the feedback signals used for cycle validation must also be used for calculating work. Feedback signals for control loops may use different filtering.

(a) *Testing performed by EPA.* Our tests must meet the specifications of paragraph (f) of this section, unless we determine that failing to meet the specifications is related to engine performance rather than to

shortcomings of the dynamometer or other laboratory equipment.

(b) *Testing performed by manufacturers.* Emission tests that meet the specifications of paragraph (f) of this section satisfy the standard-setting part's requirements for duty cycles. You may ask to use a dynamometer or other laboratory equipment that cannot meet those specifications. We will approve your request as long as using the alternate equipment does not adversely

affect your ability to show compliance with the applicable emission standards.

(c) *Time-alignment.* Because time lag between feedback values and the reference values may bias cycle-validation results, you may advance or delay the entire sequence of feedback engine speed and torque pairs to synchronize them with the reference sequence. If you advance or delay feedback signals for cycle validation, you must make the same adjustment for

calculating work. You may use linear interpolation between successive recorded feedback signals to time shift an amount that is a fraction of the recording period.

(d) *Omitting additional points.* Besides engine cranking, you may omit additional points from cycle-validation statistics as described in the following table:

TABLE 1 OF § 1065.514.—PERMISSIBLE CRITERIA FOR OMITTING POINTS FROM DUTY-CYCLE REGRESSION STATISTICS

When operator demand is at its . . .	you may omit . . .	if . . .
For reference duty cycles that are specified in terms of speed and torque (f_{nref} , T_{ref}):		
minimum	power and torque	$T_{ref} < 0\%$ (motoring).
minimum	power and speed	$f_{nref} = 0\%$ (idle speed) and $T_{ref} = 0\%$ (idle torque) and $T_{ref} - (2\% \cdot T_{max\ mapped}) < T < T_{ref} + (2\% \cdot T_{max\ mapped})$.
minimum	power and either torque or speed.	$f_n > f_{nref}$ or $T > T_{ref}$ but not if $f_n > (f_{nref} \cdot 102\%)$ and $T > T_{ref} + (2\% \cdot T_{max\ mapped})$.
maximum	power and either torque or speed.	$f_n < f_{nref}$ or $T < T_{ref}$ but not if $f_n < (f_{nref} \cdot 98\%)$ and $T < T_{ref} - (2\% \cdot T_{max\ mapped})$.
For reference duty cycles that are specified in terms of speed and power (f_{nref} , P_{ref}):		
minimum	power and torque	$< P_{ref} < 0\%$ (motoring).
minimum	power and speed	$f_{nref} = 0\%$ (idle speed) and $P_{ref} = 0\%$ (idle power) and $P_{ref} - (2\% \cdot P_{max\ mapped}) < P < P_{ref} + (2\% \cdot P_{max\ mapped})$.
minimum	power and either torque or speed.	$f_n > f_{nref}$ or $P > P_{ref}$ but not if $f_n > (f_{nref} \cdot 102\%)$ and $P > P_{ref} + (2\% \cdot P_{max\ mapped})$.
maximum	power and either torque or speed.	$f_n < f_{nref}$ or $P < P_{ref}$ but not if $f_n < (f_{nref} \cdot 98\%)$ and $P < P_{ref} - (2\% \cdot P_{max\ mapped})$.

(e) *Statistical parameters.* Use the remaining points to calculate regression statistics described in § 1065.602. Round calculated regression statistics to the same number of significant digits as the criteria to which they are compared. Refer to Table 2 of § 1065.514 for the default criteria and refer to the standard-setting part to determine if there are other criteria for your engine. Calculate the following regression statistics:

(1) Slopes for feedback speed, a_{1fm} , feedback torque, a_{1T} , and feedback power a_{1P} .

(2) Intercepts for feedback speed, a_{0fm} , feedback torque, a_{0T} , and feedback power a_{0P} .

(3) Standard estimates of error for feedback speed, SEE_{fm} , feedback torque, SEE_T , and feedback power SEE_P .

(4) Coefficients of determination for feedback speed, r^2_{fm} , feedback torque, r^2_T , and feedback power r^2_P .

(f) *Cycle-validation criteria.* Unless the standard-setting part specifies otherwise, use the following criteria to validate a duty cycle:

(1) For variable-speed engines, apply all the statistical criteria in Table 2 of this section.

(2) For constant-speed engines, apply only the statistical criteria for torque in Table 2 of this section.

(3) For discrete-mode steady-state testing, apply cycle-validation criteria using one of the following approaches:

(i) Treat the sampling periods from the series of test modes as a continuous sampling period, analogous to ramped-modal testing and apply statistical

criteria as described in paragraph (f)(1) or (2) of this section.

(ii) Evaluate each mode separately to validate the duty cycle. For variable-speed engines, all speed values measured during the sampling period for each mode would need to stay within a tolerance of 2 percent of the reference value, and all load values would need to stay within a tolerance of 2 percent or ± 0.27 N·m of the reference value, whichever is greater. Also, the mean speed value during the sampling period for each mode would need to be within 1 percent of the reference value, and the mean load value would need to stay within 1 percent or ± 0.12 N·m of the reference value, whichever is greater. The same torque criteria apply for constant-speed engines but the speed criteria do not apply.

TABLE 2 OF § 1065.514.—DEFAULT STATISTICAL CRITERIA FOR VALIDATING DUTY CYCLES

Parameter	Speed	Torque	Power
Slope, a_1	$0.950 \leq a_1 \leq 1.030$	$0.830 \leq a_1 \leq 1.030$	$0.830 \leq a_1 \leq 1.030$.
Absolute value of intercept, $ a_0 $	$\leq 10\%$ of warm idle	$\leq 2.0\%$ of maximum mapped torque.	$\leq 2.0\%$ of maximum mapped power.
Standard error of estimate, SEE ...	$\leq 5.0\%$ of maximum test speed ...	$\leq 10\%$ of maximum mapped torque.	$\leq 10\%$ of maximum mapped power.
Coefficient of determination, r^2	≥ 0.970	≥ 0.850	≥ 0.910 .

■ 101. Section 1065.520 is revised to read as follows:

§ 1065.520 Pre-test verification procedures and pre-test data collection.

(a) If your engine must comply with a PM standard, follow the procedures for PM sample preconditioning and tare weighing according to § 1065.590.

(b) Unless the standard-setting part specifies different tolerances, verify that ambient conditions are within the following tolerances before the test:

(1) Ambient temperature of (20 to 30) °C.

(2) Atmospheric pressure of (80.000 to 103.325) kPa and within ± 5 kPa of the value recorded at the time of the last engine map.

(3) Dilution air conditions as specified in § 1065.140, except in cases where you preheat your CVS before a cold start test.

(c) You may test engines at any intake-air humidity, and we may test engines at any intake-air humidity.

(d) Verify that auxiliary-work inputs and outputs are configured as they were during engine mapping, as described in § 1065.510(a).

(e) You may perform a final calibration of the speed, torque, and proportional-flow control systems, which may include performing practice duty cycles.

(f) You may perform the following recommended procedure to precondition sampling systems:

(1) Start the engine and use good engineering judgment to bring it to one of the following:

(i) 100% torque at any speed above its peak-torque speed.

(ii) 100% operator demand.

(2) Operate any dilution systems at their expected flow rates. Prevent aqueous condensation in the dilution systems.

(3) Operate any PM sampling systems at their expected flow rates.

(4) Sample PM for at least 10 min using any sample media. You may change sample media during preconditioning. You may discard preconditioning samples without weighing them.

(5) You may purge any gaseous sampling systems during preconditioning.

(6) You may conduct calibrations or verifications on any idle equipment or analyzers during preconditioning.

(7) Proceed with the test sequence described in § 1065.530(a)(1).

(g) Verify the amount of nonmethane contamination in the exhaust and background HC sampling systems within eight hours of starting each duty-cycle sequence for laboratory tests. You

may verify the contamination of a background HC sampling system by reading the last bag fill and purge using zero gas. For any NMHC measurement system that involves separately measuring methane and subtracting it from a THC measurement, verify the amount of THC contamination using only the THC analyzer response. There is no need to operate any separate methane analyzer for this verification, however you may measure and correct for THC contamination in the CH₄ sample train for the cases where NMHC is determined by subtracting CH₄ from THC, using an NMC as configured in § 1065.365(d), (e), and (f); and the calculations in § 1065.660(b)(2). Perform this verification as follows:

(1) Select the HC analyzer range for measuring the flow-weighted mean concentration expected at the HC standard.

(2) Zero the HC analyzer at the analyzer zero or sample port. Note that FID zero and span balance gases may be any combination of purified air or purified nitrogen that meets the specifications of § 1065.750. We recommend FID analyzer zero and span gases that contain approximately the flow-weighted mean concentration of O₂ expected during testing.

(3) Span the HC analyzer using span gas introduced at the analyzer span or sample port. Span on a carbon number basis of one (C₁). For example, if you use a C₃H₈ span gas of concentration 200 $\mu\text{mol/mol}$, span the FID to respond with a value of 600 $\mu\text{mol/mol}$.

(4) Overflow zero gas at the HC probe or into a fitting between the HC probe and its transfer line.

(5) Measure the THC concentration in the sampling and background systems as follows:

(i) For continuous sampling, record the mean THC concentration as overflow zero air flows.

(ii) For batch sampling, fill the sample medium (e.g., filter) and record its mean THC concentration.

(iii) For the background system, record the mean THC concentration of the last fill and purge.

(6) Record this value as the initial THC concentration, $x_{\text{THC}[\text{THC-FID}]_{\text{init}}}$, and use it to correct measured values as described in § 1065.660.

(7) If any of the $x_{\text{THC}[\text{THC-FID}]_{\text{init}}}$ values exceed the greatest of the following values, determine the source of the contamination and take corrective action, such as purging the system during an additional preconditioning cycle or replacing contaminated portions:

(i) 2% of the flow-weighted mean wet, net concentration expected at the HC (THC or NMHC) standard.

(ii) 2% of the flow-weighted mean wet, net concentration of HC (THC or NMHC) measured during testing.

(iii) 2 $\mu\text{mol/mol}$.

(8) If corrective action does not resolve the deficiency, you may request to use the contaminated system as an alternate procedure under § 1065.10.

■ 102. Section 1065.525 is revised to read as follows:

§ 1065.525 Engine starting, restarting, shutdown, and optional repeating of void discrete modes.

(a) Start the engine using one of the following methods:

(1) Start the engine as recommended in the owners manual using a production starter motor or air-start system and either an adequately charged battery, a suitable power supply, or a suitable compressed air source.

(2) Use the dynamometer to start the engine. To do this, motor the engine within $\pm 25\%$ of its typical in-use cranking speed. Stop cranking within 1 second of starting the engine.

(b) If the engine does not start after 15 seconds of cranking, stop cranking and determine why the engine failed to start, unless the owners manual or the service-repair manual describes the longer cranking time as normal.

(c) Respond to engine stalling with the following steps:

(1) If the engine stalls during warm-up before emission sampling begins, restart the engine and continue warm-up.

(2) If the engine stalls during preconditioning before emission sampling begins, restart the engine and restart the preconditioning sequence.

(3) If the engine stalls at any time after emission sampling begins for a transient test or ramped-modal cycle test, the test is void.

(4) Except as described in paragraph (d) of this section, void the test if the engine stalls at any time after emission sampling begins.

(d) If emission sampling is interrupted during one of the modes of a discrete-mode test, you may void the results only for that individual mode and perform the following steps to continue the test:

(1) If the engine has stalled, restart the engine.

(2) Use good engineering judgment to restart the test sequence using the appropriate steps in § 1065.530(b).

(3) Precondition the engine by operating at the previous mode for approximately the same amount of time it operated at that mode for the last emission measurement.

(4) Advance to the mode at which the engine stalled and continue with the duty cycle as specified in the standard-setting part.

(5) Complete the remainder of the test according to the requirements in this subpart.

(e) Shut down the engine according to the manufacturer's specifications.

■ 103. Section 1065.530 is revised to read as follows:

§ 1065.530 Emission test sequence.

(a) Time the start of testing as follows:

(1) Perform one of the following if you precondition sampling systems as described in § 1065.520(f):

(i) For cold-start duty cycles, shut down the engine. Unless the standard-setting part specifies that you may only perform a natural engine cooldown, you may perform a forced engine cooldown. Use good engineering judgment to set up systems to send cooling air across the engine, to send cool oil through the engine lubrication system, to remove heat from coolant through the engine cooling system, and to remove heat from any exhaust aftertreatment systems. In the case of a forced aftertreatment cooldown, good engineering judgment would indicate that you not start flowing cooling air until the aftertreatment system has cooled below its catalytic activation temperature. For platinum-group metal catalysts, this temperature is about 200 °C. Once the aftertreatment system has naturally cooled below its catalytic activation temperature, good engineering judgment would indicate that you use clean air with a temperature of at least 15 °C, and direct the air through the aftertreatment system in the normal direction of exhaust flow. Do not use any cooling procedure that results in unrepresentative emissions (see § 1065.10(c)(1)). You may start a cold-start duty cycle when the temperatures of an engine's lubricant, coolant, and aftertreatment systems are all between (20 and 30) °C.

(ii) For hot-start emission measurements, shut down the engine. Start the hot-start duty cycle as specified in the standard-setting part.

(iii) For testing that involves hot-stabilized emission measurements, such as any steady-state testing, you may continue to operate the engine at maximum test speed and 100% torque if that is the first operating point. Otherwise, operate the engine at warm idle or the first operating point of the duty cycle. In any case, start the emission test within 10 min after you complete the preconditioning procedure.

(2) If you do not precondition sampling systems, perform one of the following:

(i) For cold-start duty cycles, prepare the engine according to paragraph (a)(1)(i) of this section.

(ii) For hot-start emission measurements, first operate the engine at any speed above peak-torque speed and at (65 to 85)% of maximum mapped power until either the engine coolant, block, or head absolute temperature is within $\pm 2\%$ of its mean value for at least 2 min or until the engine thermostat controls engine temperature. Shut down the engine. Start the duty cycle within 20 min of engine shutdown.

(iii) For testing that involves hot-stabilized emission measurements, bring the engine either to warm idle or the first operating point of the duty cycle. Start the test within 10 min of achieving temperature stability. Determine temperature stability either as the point at which the engine coolant, block, or head absolute temperature is within $\pm 2\%$ of its mean value for at least 2 min, or as the point at which the engine thermostat controls engine temperature.

(b) Take the following steps before emission sampling begins:

(1) For batch sampling, connect clean storage media, such as evacuated bags or tare-weighted filters.

(2) Start all measurement instruments according to the instrument manufacturer's instructions and using good engineering judgment.

(3) Start dilution systems, sample pumps, cooling fans, and the data-collection system.

(4) Pre-heat or pre-cool heat exchangers in the sampling system to within their operating temperature tolerances for a test.

(5) Allow heated or cooled components such as sample lines, filters, chillers, and pumps to stabilize at their operating temperatures.

(6) Verify that there are no significant vacuum-side leaks according to § 1065.345.

(7) Adjust the sample flow rates to desired levels, using bypass flow, if desired.

(8) Zero or re-zero any electronic integrating devices, before the start of any test interval.

(9) Select gas analyzer ranges. You may automatically or manually switch gas analyzer ranges during a test only if switching is performed by changing the span over which the digital resolution of the instrument is applied. During a test you may not switch the gains of an analyzer's analog operational amplifier(s).

(10) Zero and span all continuous analyzers using NIST-traceable gases

that meet the specifications of § 1065.750. Span FID analyzers on a carbon number basis of one (1), C_1 . For example, if you use a C_3H_8 span gas of concentration 200 $\mu\text{mol/mol}$, span the FID to respond with a value of 600 $\mu\text{mol/mol}$. Span FID analyzers consistent with the determination of their respective response factors, *RF*, and penetration fractions, *PF*, according to § 1065.365.

(11) We recommend that you verify gas analyzer responses after zeroing and spanning by sampling a calibration gas that has a concentration near one-half of the span gas concentration. Based on the results and good engineering judgment, you may decide whether or not to re-zero, re-span, or re-calibrate a gas analyzer before starting a test.

(12) If you correct for dilution air background concentrations of engine exhaust constituents, start measuring and recording background concentrations.

(13) Drain any condensate from the intake air system and close any intake air condensate drains that are not normally open during in-use operation.

(c) Start testing as follows:

(1) If an engine is already running and warmed up, and starting is not part of the duty cycle, perform the following for the various duty cycles:

(i) Transient and steady-state ramped-modal cycles. Simultaneously start running the duty cycle, sampling exhaust gases, recording data, and integrating measured values.

(ii) Steady-state discrete-mode cycles. Control the engine operation to match the first mode in the test cycle. This will require controlling engine speed and load, engine load, or other operator demand settings, as specified in the standard-setting part. Follow the instructions in the standard-setting part to determine how long to stabilize engine operation at each mode, how long to sample emissions at each mode, and how to transition between modes.

(2) If engine starting is part of the duty cycle, initiate data logging, sampling of exhaust gases, and integrating measured values before attempting to start the engine. Initiate the duty cycle when the engine starts.

(d) At the end of each test interval, continue to operate all sampling and dilution systems to allow the sampling system's response time to elapse. Then stop all sampling and recording, including the recording of background samples. Finally, stop any integrating devices and indicate the end of the duty cycle in the recorded data.

(e) Shut down the engine if you have completed testing or if it is part of the duty cycle.

(f) If testing involves another duty cycle after a soak period with the engine off, start a timer when the engine shuts down, and repeat the steps in paragraphs (b) through (e) of this section as needed.

(g) Take the following steps after emission sampling is complete:

(1) For any proportional batch sample, such as a bag sample or PM sample, verify that proportional sampling was maintained according to § 1065.545. Void any samples that did not maintain proportional sampling according to § 1065.545.

(2) Place any used PM samples into covered or sealed containers and return them to the PM-stabilization environment. Follow the PM sample post-conditioning and total weighing procedures in § 1065.595.

(3) As soon as practical after the duty cycle is complete, or during the soak period if practical, perform the following:

(i) Zero and span all batch gas analyzers no later than 30 minutes after the duty cycle is complete, or during the soak period if practical.

(ii) Analyze any conventional gaseous batch samples no later than 30 minutes after the duty cycle is complete, or during the soak period if practical.

(iii) Analyze background samples no later than 60 minutes after the duty cycle is complete.

(iv) Analyze non-conventional gaseous batch samples, such as ethanol (NMCHE) as soon as practical using good engineering judgment.

(4) After quantifying exhaust gases, verify drift as follows:

(i) For batch and continuous gas analyzers, record the mean analyzer value after stabilizing a zero gas to the analyzer. Stabilization may include time to purge the analyzer of any sample gas, plus any additional time to account for analyzer response.

(ii) Record the mean analyzer value after stabilizing the span gas to the analyzer. Stabilization may include time to purge the analyzer of any sample gas, plus any additional time to account for analyzer response.

(iii) Use these data to validate and correct for drift as described in § 1065.550.

(h) Unless the standard-setting part specifies otherwise, determine whether or not the test meets the cycle-validation criteria in § 1065.514.

(1) If the criteria void the test, you may retest using the same denormalized duty cycle, or you may re-map the engine, denormalize the reference duty cycle based on the new map and retest the engine using the new denormalized duty cycle.

(2) If the criteria void the test for a constant-speed engine only during commands of maximum test torque, you may do the following:

(i) Determine the first and last feedback speeds at which maximum test torque was commanded.

(ii) If the last speed is greater than or equal to 90% of the first speed, the test is void. You may retest using the same denormalized duty cycle, or you may re-map the engine, denormalize the reference duty cycle based on the new map and retest the engine using the new denormalized duty cycle.

(iii) If the last speed is less than 90% of the first speed, reduce maximum test torque by 5%, and proceed as follows:

(A) Denormalize the entire duty cycle based on the reduced maximum test torque according to § 1065.512.

(B) Retest the engine using the denormalized test cycle that is based on the reduced maximum test torque.

(C) If your engine still fails the cycle criteria, reduce the maximum test torque by another 5% of the original maximum test torque.

(D) If your engine fails after repeating this procedure four times, such that your engine still fails after you have reduced the maximum test torque by 20% of the original maximum test torque, notify us and we will consider specifying a more appropriate duty cycle for your engine under the provisions of § 1065.10(c).

(i) [Reserved]

(j) Measure and record ambient temperature, pressure, and humidity, as appropriate.

■ 104. Section 1065.545 is revised to read as follows:

§ 1065.545 Validation of proportional flow control for batch sampling and minimum dilution ratio for PM batch sampling.

For any proportional batch sample such as a bag or PM filter, demonstrate that proportional sampling was maintained using one of the following, noting that you may omit up to 5% of the total number of data points as outliers:

(a) For any pair of flow meters, use recorded sample and total flow rates, where total flow rate means the raw exhaust flow rate for raw exhaust sampling and the dilute exhaust flow rate for CVS sampling, or their 1 Hz means with the statistical calculations in § 1065.602. Determine the standard error of the estimate, *SEE*, of the sample flow rate versus the total flow rate. For each test interval, demonstrate that *SEE* was less than or equal to 3.5% of the mean sample flow rate.

(b) For any pair of flow meters, use recorded sample and total flow rates,

where total flow rate means the raw exhaust flow rate for raw exhaust sampling and the dilute exhaust flow rate for CVS sampling, or their 1 Hz means to demonstrate that each flow rate was constant within $\pm 2.5\%$ of its respective mean or target flow rate. You may use the following options instead of recording the respective flow rate of each type of meter:

(1) *Critical-flow venturi option.* For critical-flow venturis, you may use recorded venturi-inlet conditions or their 1 Hz means. Demonstrate that the flow density at the venturi inlet was constant within $\pm 2.5\%$ of the mean or target density over each test interval. For a CVS critical-flow venturi, you may demonstrate this by showing that the absolute temperature at the venturi inlet was constant within $\pm 4\%$ of the mean or target absolute temperature over each test interval.

(2) *Positive-displacement pump option.* You may use recorded pump-inlet conditions or their 1 Hz means. Demonstrate that the flow density at the pump inlet was constant within $\pm 2.5\%$ of the mean or target density over each test interval. For a CVS pump, you may demonstrate this by showing that the absolute temperature at the pump inlet was constant within $\pm 2\%$ of the mean or target absolute temperature over each test interval.

(c) Using good engineering judgment, demonstrate with an engineering analysis that the proportional-flow control system inherently ensures proportional sampling under all circumstances expected during testing. For example, you might use CFVs for both sample flow and total flow and demonstrate that they always have the same inlet pressures and temperatures and that they always operate under critical-flow conditions.

(d) Use measured or calculated flows and/or tracer gas concentrations (e.g., CO₂) to determine the minimum dilution ratio for PM batch sampling over the test interval.

■ 105. Section 1065.550 is revised to read as follows:

§ 1065.550 Gas analyzer range validation, drift validation, and drift correction.

(a) *Range validation.* If an analyzer operated above 100% of its range at any time during the test, perform the following steps:

(1) For batch sampling, re-analyze the sample using the lowest analyzer range that results in a maximum instrument response below 100%. Report the result from the lowest range from which the analyzer operates below 100% of its range.

(2) For continuous sampling, repeat the entire test using the next higher analyzer range. If the analyzer again operates above 100% of its range, repeat the test using the next higher range. Continue to repeat the test until the analyzer always operates at less than 100% of its range.

(b) *Drift validation and drift correction.* Calculate two sets of brake-specific emission results. Calculate one set using the data before drift correction and calculate the other set after correcting all the data for drift according to § 1065.672. Use the two sets of brake-specific emission results as follows:

(1) This test is validated for drift if, for each regulated pollutant, the difference between the uncorrected and the corrected brake-specific emission values is within $\pm 4\%$ of the uncorrected results or applicable standard, whichever is greater. If not, the entire test is void.

(2) If the test is validated for drift, you must use only the drift-corrected emission results when reporting emissions, unless you demonstrate to us that using the drift-corrected results adversely affects your ability to demonstrate that your engine complies with the applicable standards.

■ 106. Section 1065.590 is revised to read as follows:

§ 1065.590 PM sampling media (e.g., filters) preconditioning and tare weighing.

Before an emission test, take the following steps to prepare PM sampling media (e.g., filters) and equipment for PM measurements:

(a) Make sure the balance and PM-stabilization environments meet the periodic verifications in § 1065.390.

(b) Visually inspect unused sample media (e.g., filters) for defects and discard defective media.

(c) To handle PM sampling media (e.g., filters), use electrically grounded tweezers or a grounding strap, as described in § 1065.190.

(d) Place unused sample media (e.g., filters) in one or more containers that are open to the PM-stabilization environment. If you are using filters, you may place them in the bottom half of a filter cassette.

(e) Stabilize sample media (e.g., filters) in the PM-stabilization environment. Consider an unused sample medium stabilized as long as it has been in the PM-stabilization environment for a minimum of 30 min, during which the PM-stabilization environment has been within the specifications of § 1065.190.

(f) Weigh the sample media (e.g., filters) automatically or manually, as follows:

(1) For automatic weighing, follow the automation system manufacturer's instructions to prepare samples for weighing. This may include placing the samples in a special container.

(2) For manual weighing, use good engineering judgment to determine if substitution weighing is necessary to show that an engine meets the applicable standard. You may follow the substitution weighing procedure in paragraph (j) of this section, or you may develop your own procedure.

(g) Correct the measured mass of each sample medium (e.g., filter) for buoyancy as described in § 1065.690. These buoyancy-corrected values are subsequently subtracted from the post-test mass of the corresponding sample media (e.g., filters) and collected PM to determine the mass of PM emitted during the test.

(h) You may repeat measurements to determine the mean mass of each sample medium (e.g., filter). Use good engineering judgment to exclude outliers from the calculation of mean mass values.

(i) If you use filters as sample media, load unused filters that have been tare-weighed into clean filter cassettes and place the loaded cassettes in a clean, covered or sealed container before removing them from the stabilization environment for transport to the test site for sampling. We recommend that you keep filter cassettes clean by periodically washing or wiping them with a compatible solvent applied using a lint-free cloth. Depending upon your cassette material, ethanol (C_2H_5OH) might be an acceptable solvent. Your cleaning frequency will depend on your engine's level of PM and HC emissions.

(j) Substitution weighing involves measurement of a reference weight before and after each weighing of PM sampling media (e.g., filters). While substitution weighing requires more measurements, it corrects for a balance's zero-drift and it relies on balance linearity only over a small range. This is most advantageous when quantifying net PM masses that are less than 0.1% of the sample medium's mass. However, it may not be advantageous when net PM masses exceed 1% of the sample medium's mass. If you utilize substitution weighing, it must be used for both pre-test and post-test weighing. The same substitution weight must be used for both pre-test and post-test weighing. Correct the mass of the substitution weight for buoyancy if the density of the substitution weight is less than 2.0 g/cm³. The following steps are an example of substitution weighing:

(1) Use electrically grounded tweezers or a grounding strap, as described in § 1065.190.

(2) Use a static neutralizer as described in § 1065.190 to minimize static electric charge on any object before it is placed on the balance pan.

(3) Select a substitution weight that meets the requirements for calibration weights found in § 1065.790. The substitution weight must also have the same density as the weight you use to span the microbalance, and be similar in mass to an unused sample medium (e.g., filter). A 47 mm PTFE membrane filter will typically have a mass in the range of 80 to 100 mg.

(4) Record the stable balance reading, then remove the calibration weight.

(5) Weigh an unused sample medium (e.g., a new filter), record the stable balance reading and record the balance environment's dewpoint, ambient temperature, and atmospheric pressure.

(6) Reweigh the calibration weight and record the stable balance reading.

(7) Calculate the arithmetic mean of the two calibration-weight readings that you recorded immediately before and after weighing the unused sample. Subtract that mean value from the unused sample reading, then add the true mass of the calibration weight as stated on the calibration-weight certificate. Record this result. This is the unused sample's tare weight without correcting for buoyancy.

(8) Repeat these substitution-weighing steps for the remainder of your unused sample media.

(9) Once weighing is completed, follow the instructions given in paragraphs (g) through (i) of this section.

■ 107. Section 1065.595 is revised to read as follows:

§ 1065.595 PM sample post-conditioning and total weighing.

After testing is complete, return the sample media (e.g., filters) to the weighing and PM-stabilization environments.

(a) Make sure the weighing and PM-stabilization environments meet the ambient condition specifications in § 1065.190(e)(1). If those specifications are not met, leave the test sample media (e.g., filters) covered until proper conditions have been met.

(b) In the PM-stabilization environment, remove PM samples from sealed containers. If you use filters, you may remove them from their cassettes before or after stabilization. We recommend always removing the top portion of the cassette before stabilization. When you remove a filter from a cassette, separate the top half of

the cassette from the bottom half using a cassette separator designed for this purpose.

(c) To handle PM samples, use electrically grounded tweezers or a grounding strap, as described in § 1065.190.

(d) Visually inspect the sampling media (e.g., filters) and collected particulate. If either the sample media (e.g., filters) or particulate sample appear to have been compromised, or the particulate matter contacts any surface other than the filter, the sample may not be used to determine particulate emissions. In the case of contact with another surface, clean the affected surface before continuing.

(e) To stabilize PM samples, place them in one or more containers that are open to the PM-stabilization environment, as described in § 1065.190. If you expect that a sample medium's (e.g., filter's) total surface concentration of PM will be less than 400 µg, assuming a 38 mm diameter filter stain area, expose the filter to a PM-stabilization environment meeting the specifications of § 1065.190 for at least 30 minutes before weighing. If you expect a higher PM concentration or do not know what PM concentration to expect, expose the filter to the stabilization environment for at least 60 minutes before weighing. Note that 400 µg on sample media (e.g., filters) is an approximate net mass of 0.07 g/kW-hr for a hot-start test with compression-ignition engines tested according to 40 CFR part 86, subpart N, or 50 mg/mile for light-duty vehicles tested according to 40 CFR part 86, subpart B.

(f) Repeat the procedures in § 1065.590(f) through (i) to determine post-test mass of the sample media (e.g., filters).

(g) Subtract each buoyancy-corrected tare mass of the sample medium (e.g., filter) from its respective buoyancy-corrected mass. The result is the net PM mass, m_{PM} . Use m_{PM} in emission calculations in § 1065.650.

Subpart G—[Amended]

■ 108. Section 1065.601 is amended by revising paragraph (c)(1) to read as follows:

§ 1065.601 Overview.

* * * * *

(c) * * *

(1) Mass-based emission calculations prescribed by the International Organization for Standardization (ISO), according to ISO 8178, except the following:

(i) ISO 8178-1 Section 14.4, NO_x Correction for Humidity and

Temperature. See § 1065.670 for approved methods for humidity corrections.

(ii) ISO 8178-1 Section 15.1, Particulate Correction Factor for Humidity.

* * * * *

■ 109. Section 1065.602 is amended by revising paragraphs (f)(3) before the table and (l) introductory text to read as follows:

§ 1065.602 Statistics.

* * * * *

(f) * * *

(3) Use Table 1 of this section to compare t to the t_{crit} values tabulated versus the number of degrees of freedom. If t is less than t_{crit} , then t passes the t -test. The Microsoft Excel software package contains a TINV function that returns results equivalent to § 1065.602 Table 1 and may be used in place of Table 1.

* * * * *

(l) *Flow-weighted mean concentration.* In some sections of this part, you may need to calculate a flow-weighted mean concentration to determine the applicability of certain provisions. A flow-weighted mean is the mean of a quantity after it is weighted proportional to a corresponding flow rate. For example, if a gas concentration is measured continuously from the raw exhaust of an engine, its flow-weighted mean concentration is the sum of the products of each recorded concentration times its respective exhaust molar flow rate, divided by the sum of the recorded flow rate values. As another example, the bag concentration from a CVS system is the same as the flow-weighted mean concentration because the CVS system itself flow-weights the bag concentration. You might already expect a certain flow-weighted mean concentration of an emission at its standard based on previous testing with similar engines or testing with similar equipment and instruments. If you need to estimate your expected flow-weighted mean concentration of an emission at its standard, we recommend using the following examples as a guide for how to estimate the flow-weighted mean concentration expected at the standard. Note that these examples are not exact and that they contain assumptions that are not always valid. Use good engineering judgment to determine if you can use similar assumptions.

* * * * *

■ 110. Section 1065.610 is revised to read as follows:

§ 1065.610 Duty cycle generation.

This section describes how to generate duty cycles that are specific to

your engine, based on the normalized duty cycles in the standard-setting part. During an emission test, use a duty cycle that is specific to your engine to command engine speed, torque, and power, as applicable, using an engine dynamometer and an engine operator demand. Paragraph (a) of this section describes how to “normalize” your engine’s map to determine the maximum test speed and torque for your engine. The rest of this section describes how to use these values to “denormalize” the duty cycles in the standard-setting parts, which are all published on a normalized basis. Thus, the term “normalized” in paragraph (a) of this section refers to different values than it does in the rest of the section.

(a) *Maximum test speed, f_{ntest} .* This section generally applies to duty cycles for variable-speed engines. For constant-speed engines subject to duty cycles that specify normalized speed commands, use the no-load governed speed as the measured f_{ntest} . This is the highest engine speed where an engine outputs zero torque. For variable-speed engines, determine the measured f_{ntest} from the power-versus-speed map, generated according to § 1065.510, as follows:

(1) Based on the map, determine maximum power, P_{max} , and the speed at which maximum power occurred, f_{nPmax} . Divide every recorded power by P_{max} and divide every recorded speed by f_{nPmax} . The result is a normalized power-versus-speed map. Your measured f_{ntest} is the speed at which the sum of the squares of normalized speed and power is maximum, as follows:

$$f_{ntest} = f_{ni} \text{ at the maximum of } (f_{nnormi}^2 + P_{normi}^2)$$

Eq. 1065.610-1

Where:

f_{ntest} = maximum test speed.

i = an indexing variable that represents one recorded value of an engine map.

f_{nnormi} = an engine speed normalized by dividing it by f_{nPmax} .

P_{normi} = an engine power normalized by dividing it by P_{max} .

Example:

$$\begin{aligned} (f_{nnorm1} = 1.002, P_{norm1} = 0.978, f_{n1} = 2359.71) \\ (f_{nnorm2} = 1.004, P_{norm2} = 0.977, f_{n2} = 2364.42) \\ (f_{nnorm3} = 1.006, P_{norm3} = 0.974, f_{n3} = 2369.13) \\ (f_{nnorm12} + P_{norm12})^2 = (1.002^2 + 0.978^2) = 1.960 \\ (f_{nnorm22} + P_{norm22})^2 = (1.004^2 + 0.977^2) = 1.963 \\ (f_{nnorm32} + P_{norm32})^2 = (1.006^2 + 0.974^2) = 1.961 \\ \text{maximum} = 1.963 \text{ at } i = 2 \\ f_{ntest} = 2364.42 \text{ rev/min} \end{aligned}$$

(2) For variable-speed engines, transform normalized speeds to reference speeds according to paragraph (c) of this section by using the measured maximum test speed determined according to paragraph (a)(1) of this section—or use your declared maximum test speed, as allowed in § 1065.510.

(3) For constant-speed engines, transform normalized speeds to reference speeds according to paragraph (c) of this section by using the measured no-load governed speed—or use your declared maximum test speed, as allowed in § 1065.510.

(b) *Maximum test torque, T_{test} .* For constant-speed engines, determine the measured T_{test} from the power-versus-speed map, generated according to § 1065.510, as follows:

(1) Based on the map, determine maximum power, P_{max} , and the speed at which maximum power occurs, $f_{nP_{\text{max}}}$. Divide every recorded power by P_{max} and divide every recorded speed by $f_{nP_{\text{max}}}$. The result is a normalized power-versus-speed map. Your measured T_{test} is the torque at which the sum of the squares of normalized speed and power is maximum, as follows:

$$T_{\text{test}} = T_i \text{ at the maximum of } (f_{n\text{norm}i}^2 + P_{\text{norm}i}^2)$$

Eq. 1065.610–2

Where:

T_{test} = maximum test torque.

Example:

$$(f_{n\text{norm}1} = 1.002, P_{\text{norm}1} = 0.978, T_1 = 722.62 \text{ N} \cdot \text{m})$$

$$(f_{n\text{norm}2} = 1.004, P_{\text{norm}2} = 0.977, T_2 = 720.44 \text{ N} \cdot \text{m})$$

$$(f_{n\text{norm}3} = 1.006, P_{\text{norm}3} = 0.974, T_3 = 716.80 \text{ N} \cdot \text{m})$$

$$(f_{n\text{norm}1}^2 + P_{\text{norm}1}^2) = (1.002^2 + 0.978^2) = 1.960$$

$$(f_{n\text{norm}2}^2 + P_{\text{norm}2}^2) = (1.004^2 + 0.977^2) = 1.963$$

$$(f_{n\text{norm}3}^2 + P_{\text{norm}3}^2) = (1.006^2 + 0.974^2) = 1.961$$

$$\text{maximum} = 1.963 \text{ at } i = 2$$

$$T_{\text{test}} = 720.44 \text{ N} \cdot \text{m}$$

(2) Transform normalized torques to reference torques according to paragraph (d) of this section by using the measured maximum test torque determined according to paragraph (b)(1) of this section—or use your declared maximum test torque, as allowed in § 1065.510.

(c) *Generating reference speed values from normalized duty cycle speeds.*

Transform normalized speed values to reference values as follows:

(1) *% speed.* If your normalized duty cycle specifies % speed values, use your warm idle speed and your maximum test speed to transform the duty cycle, as follows:

$$f_{\text{href}} = \% \text{ speed} \cdot (f_{\text{ntest}} - f_{\text{nidle}}) + f_{\text{nidle}}$$

Eq. 1065.610–3

Example:

$$\% \text{ speed} = 85\%$$

$$f_{\text{ntest}} = 2364 \text{ rev/min}$$

$$f_{\text{nidle}} = 650 \text{ rev/min}$$

$$f_{\text{href}} = 85\% \cdot (2364 - 650) + 650$$

$$f_{\text{href}} = 2107 \text{ rev/min}$$

(2) *A, B, and C speeds.* If your normalized duty cycle specifies speeds as A, B, or C values, use your power-

versus-speed curve to determine the lowest speed below maximum power at which 50% of maximum power occurs. Denote this value as n_{lo} . Take n_{lo} to be warm idle speed if all power points at speeds below the maximum power speed are higher than 50% of maximum power. Also determine the highest speed above maximum power at which 70% of maximum power occurs. Denote this value as n_{hi} . If all power points at speeds above the maximum power speed are higher than 70% of maximum power, take n_{hi} to be the declared maximum safe engine speed or the declared maximum representative engine speed, whichever is lower. Use n_{hi} and n_{lo} to calculate reference values for A, B, or C speeds as follows:

$$f_{\text{hrefA}} = 0.25 \cdot (n_{hi} - n_{lo}) + n_{lo}$$

Eq. 1065.610–4

$$f_{\text{hrefB}} = 0.50 \cdot (n_{hi} - n_{lo}) + n_{lo}$$

Eq. 1065.610–5

$$f_{\text{hrefC}} = 0.75 \cdot (n_{hi} - n_{lo}) + n_{lo}$$

Eq. 1065.610–6

Example:

$$n_{lo} = 1005 \text{ rev/min}$$

$$n_{hi} = 2385 \text{ rev/min}$$

$$f_{\text{hrefA}} = 0.25 \cdot (2385 - 1005) + 1005$$

$$f_{\text{hrefB}} = 0.50 \cdot (2385 - 1005) + 1005$$

$$f_{\text{hrefC}} = 0.75 \cdot (2385 - 1005) + 1005$$

$$f_{\text{hrefA}} = 1350 \text{ rev/min}$$

$$f_{\text{hrefB}} = 1695 \text{ rev/min}$$

$$f_{\text{hrefC}} = 2040 \text{ rev/min}$$

(3) *Intermediate speed.* If your normalized duty cycle specifies a speed as “intermediate speed,” use your torque-versus-speed curve to determine the speed at which maximum torque occurs. This is peak torque speed. Identify your reference intermediate speed as one of the following values:

(i) Peak torque speed if it is between (60 and 75)% of maximum test speed.

(ii) 60% of maximum test speed if peak torque speed is less than 60% of maximum test speed.

(iii) 75% of maximum test speed if peak torque speed is greater than 75% of maximum test speed.

(d) *Generating reference torques from normalized duty-cycle torques.*

Transform normalized torques to reference torques using your map of maximum torque versus speed.

(1) *Reference torque for variable-speed engines.* For a given speed point, multiply the corresponding % torque by the maximum torque at that speed, according to your map. If your engine is subject to a reference duty cycle that specifies negative torque values (i.e., engine motoring), use negative torque for those motoring points (i.e., the motoring torque). If you map negative torque as allowed under § 1065.510 (c)(2) and the low-speed governor activates, resulting in positive torques,

you may replace those positive motoring mapped torques with negative values between zero and the largest negative motoring torque. For both maximum and motoring torque maps, linearly interpolate mapped torque values to determine torque between mapped speeds. If the reference speed is below the minimum mapped speed (i.e., 95% of idle speed or 95% of lowest required speed, whichever is higher), use the mapped torque at the minimum mapped speed as the reference torque. The result is the reference torque for each speed point.

(2) *Reference torque for constant-speed engines.* Multiply a % torque value by your maximum test torque. The result is the reference torque for each point.

(3) *Required deviations.* We require the following deviations for variable-speed engines intended primarily for propulsion of a vehicle with an automatic transmission where that engine is subject to a transient duty cycle with idle operation. These deviations are intended to produce a more representative transient duty cycle for these applications. For steady-state duty cycles or transient duty cycles with no idle operation, these requirements do not apply. Idle points for steady state duty cycles of such engines are to be run at conditions simulating neutral or park on the transmission.

(i) Zero-percent speed is the warm idle speed measured according to § 1065.510(b)(6) with CITT applied, i.e., measured warm idle speed in drive.

(ii) If the cycle begins with a set of contiguous idle points (zero-percent speed, and zero-percent torque), leave the reference torques set to zero for this initial contiguous idle segment. This is to represent free idle operation with the transmission in neutral or park at the start of the transient duty cycle, after the engine is started. If the initial idle segment is longer than 24 s, change the reference torques for the remaining idle points in the initial contiguous idle segment to CITT (i.e., change idle points corresponding to 25 s to the end of the initial idle segment to CITT). This is to represent shifting the transmission to drive.

(iii) For all other idle points, change the reference torque to CITT. This is to represent the transmission operating in drive.

(iv) If the engine is intended primarily for automatic transmissions with a Neutral-When-Stationary feature that automatically shifts the transmission to neutral after the vehicle is stopped for a designated time and automatically shifts back to drive when the operator increases demand (i.e., pushes the

accelerator pedal), change the reference torque back to zero for idle points in drive after the designated time.

(v) For all points with normalized speed at or below zero percent and reference torque from zero to CITT, set the reference torque to CITT. This is to provide smoother torque references below idle speed.

(vi) For motoring points, make no changes.

(vii) For consecutive points with reference torques from zero to CITT that immediately follow idle points, change their reference torques to CITT. This is to provide smooth torque transition out of idle operation. This does not apply if the Neutral-When-Stationary feature is used and the transmission has shifted to neutral.

(viii) For consecutive points with reference torque from zero to CITT that immediately precede idle points, change their reference torques to CITT. This is to provide smooth torque transition into idle operation.

(4) *Permissible deviations for any engine.* If your engine does not operate below a certain minimum torque under normal in-use conditions, you may use a declared minimum torque as the reference value instead of any value denormalized to be less than the declared value. For example, if your engine is connected to a hydrostatic transmission and it has a minimum torque even when all the driven

hydraulic actuators and motors are stationary and the engine is at idle, then you may use this declared minimum torque as a reference torque value instead of any reference torque value generated under paragraph (d)(1) or (2) of this section that is between zero and this declared minimum torque.

(e) *Generating reference power values from normalized duty cycle powers.*

Transform normalized power values to reference speed and power values using your map of maximum power versus speed.

(1) First transform normalized speed values into reference speed values. For a given speed point, multiply the corresponding % power by the mapped power at maximum test speed, f_{ntest} , unless specified otherwise by the standard-setting part. The result is the reference power for each speed point, P_{ref} . Convert these reference powers to corresponding torques for operator demand and dynamometer control and for duty cycle validation per 1065.514. Use the reference speed associated with each reference power point for this conversion. As with cycles specified with % torque, linearly interpolate between these reference torque values generated from cycles with % power.

(2) Permissible deviations for any engine. If your engine does not operate below a certain power under normal in-use conditions, you may use a declared

minimum power as the reference value instead of any value denormalized to be less than the declared value. For example, if your engine is directly connected to a propeller, it may have a minimum power called idle power. In this case, you may use this declared minimum power as a reference power value instead of any reference power value generated per paragraph (e)(1) of this section that is from zero to this declared minimum power.

■ 111. Section 1065.640 is amended by revising paragraphs (a) and (e) and redesignating the second "Table 3" as "Table 4" to read as follows:

§ 1065.640 Flow meter calibration calculations.

* * * * *

(a) *Reference meter conversions.* The calibration equations in this section use molar flow rate, \dot{n}_{ref} , as a reference quantity. If your reference meter outputs a flow rate in a different quantity, such as standard volume rate, \dot{V}_{stdref} , actual volume rate, \dot{V}_{actref} , or mass rate, \dot{m}_{ref} , convert your reference meter output to a molar flow rate using the following equations, noting that while values for volume rate, mass rate, pressure, temperature, and molar mass may change during an emission test, you should ensure that they are as constant as practical for each individual set point during a flow meter calibration:

$$\dot{n}_{ref} = \frac{\dot{V}_{stdref} \cdot p_{std}}{T_{std} \cdot R} = \frac{\dot{V}_{actref} \cdot p_{act}}{T_{act} \cdot R} = \frac{\dot{m}_{ref}}{M_{mix}} \quad \text{Eq. 1065.640-1}$$

Where:

\dot{N}_{ref} = reference molar flow rate.

\dot{V}_{stdref} = reference volume flow rate, corrected to a standard pressure and a standard temperature.

\dot{V}_{actref} = reference volume flow rate at the actual pressure and temperature of the flow rate.

\dot{N}_{ref} = reference mass flow.

p_{std} = standard pressure.

p_{act} = actual pressure of the flow rate.

T_{std} = standard temperature.

T_{act} = actual temperature of the flow rate.

R = molar gas constant.

M_{mix} = molar mass of the flow rate.

Example 1:

$\dot{V}_{stdref} = 1000.00 \text{ ft}^3/\text{min} = 0.471948 \text{ m}^3/\text{s}$

$p = 29.9213 \text{ in Hg @ } 32 \text{ }^\circ\text{F} = 101325 \text{ Pa}$

$T = 68.0 \text{ }^\circ\text{F} = 293.15 \text{ K}$

$R = 8.314472 \text{ J}/(\text{mol} \cdot \text{K})$

$$\dot{n}_{ref} = \frac{0.471948 \cdot 101325}{293.15 \cdot 8.314472}$$

$\dot{N}_{ref} = 19.169 \text{ mol/s}$

Example 2:

$\dot{M}_{ref} = 17.2683 \text{ kg/min} = 287.805 \text{ g/s}$

$M_{mix} = 28.7805 \text{ g/mol}$

$$\dot{n}_{ref} = \frac{287.05}{28.7805}$$

$\dot{n}_{ref} = 10.0000 \text{ mol/s}$

(e) *CFV calibration.* Some CFV flow meters consist of a single venturi and some consist of multiple venturis, where different combinations of venturis are used to meter different flow rates. For CFV flow meters that consist of multiple venturis, either calibrate each venturi independently to determine a separate discharge coefficient, C_d , for each venturi, or calibrate each combination of venturis as one venturi. In the case where you calibrate a combination of venturis, use the sum of the active venturi throat areas as A_t , the square root of the sum of the squares of the active venturi throat diameters as d_t , and the ratio of the venturi throat to inlet diameters as the ratio of the square root of the sum

of the active venturi throat diameters (d_i) to the diameter of the common entrance to all of the venturis (D). To determine the C_d for a single venturi or a single combination of venturis, perform the following steps:

(1) Use the data collected at each calibration set point to calculate an individual C_d for each point using Eq. 1065.640-4.

(2) Calculate the mean and standard deviation of all the C_d values according to Eqs. 1065.602-1 and 1065.602-2.

(3) If the standard deviation of all the C_d values is less than or equal to 0.3% of the mean C_d , use the mean C_d in Eq. 1065.642-6, and use the CFV only down to the lowest r measured during calibration using the following equation:

$$r = 1 - \frac{\Delta p}{p_{in}} \quad \text{Eq. 1065.640-13}$$

(4) If the standard deviation of all the C_d values exceeds 0.3% of the mean C_d ,

omit the C_d values corresponding to the data point collected at the lowest r measured during calibration.

(5) If the number of remaining data points is less than seven, take corrective action by checking your calibration data or repeating the calibration process. If you repeat the calibration process, we recommend checking for leaks, applying tighter tolerances to measurements and allowing more time for flows to stabilize.

(6) If the number of remaining C_d values is seven or greater, recalculate

the mean and standard deviation of the remaining C_d values.

(7) If the standard deviation of the remaining C_d values is less than or equal to 0.3% of the mean of the remaining C_d , use that mean C_d in Eq. 1065.642–6, and use the CFV values only down to the lowest r associated with the remaining C_d .

(8) If the standard deviation of the remaining C_d still exceeds 0.3% of the mean of the remaining C_d values, repeat the steps in paragraph (e)(4) through (8) of this section.

■ 112. Section 1065.642 is amended by revising paragraph (b) to read as follows:

§ 1065.642 SSV, CFV, and PDP molar flow rate calculations.

* * * * *

(b) *SSV molar flow rate.* Based on the C_d versus $Re^{\#}$ equation you determined according to § 1065.640, calculate SSV molar flow rate, \dot{n} during an emission test as follows:

$$\dot{n} = C_d \cdot C_f \cdot \frac{A_t \cdot P_{in}}{\sqrt{Z \cdot M_{mix} \cdot R \cdot T_{in}}} \quad \text{Eq. 1065.642-3}$$

Example:

$$A_t = 0.01824 \text{ m}^2$$

$$P_{in} = 99132 \text{ Pa}$$

$$Z = 1$$

$$M_{mix} = 28.7805 \text{ g/mol} = 0.0287805 \text{ kg/mol}$$

$$R = 8.314472 \text{ J/(mol}\cdot\text{K)}$$

$$T_{in} = 298.15 \text{ K}$$

$$Re^{\#} = 7.232 \cdot 10$$

$$y = 1.399$$

$$\beta = 0.8$$

$$\Delta p = 2.312 \text{ kPa}$$

Using Eq. 1065.640–7,

$$r_{ssv} = 0.997$$

Using Eq. 1065.640–6,

$$C_f = 0.274$$

Using Eq. 1065.640–5,

$$C_d = 0.990$$

$$\dot{n} = 0.990 \cdot 0.274 \cdot \frac{0.01824 \cdot 99132}{\sqrt{1 \cdot 0.0287805 \cdot 8.314472 \cdot 298.15}}$$

$$\dot{n} = 58.173 \text{ mol/s}$$

* * * * *

■ 113. A new § 1065.644 is added to read as follows:

§ 1065.644 Vacuum-decay leak rate.

This section describes how to calculate the leak rate of a vacuum-decay leak verification, which is described in § 1065.345(e). Use Eq. 1065.644–1 to calculate the leak rate, \dot{n}_{leak} , and compare it to the criterion specified in § 1065.345(e).

$$\dot{n}_{leak} = \frac{V_{vac}}{R} \cdot \left(\frac{p_2 - p_1}{T_2 - T_1} \right) \quad \text{Eq. 1065.644-1}$$

Where:

V_{vac} = geometric volume of the vacuum-side of the sampling system.

R = molar gas constant.

p_2 = Vacuum-side absolute pressure at time t_2 .

T_2 = Vacuum-side absolute temperature at time t_2 .

p_1 = Vacuum-side absolute pressure at time t_1 .

T_1 = Vacuum-side absolute temperature at time t_1 .

t_2 = time at completion of vacuum-decay leak verification test.

t_1 = time at start of vacuum-decay leak verification test.

Example:

$$V_{vac} = 2.0000 \text{ L} = 0.00200 \text{ m}^3$$

$$R = 8.314472 \text{ J/(mol}\cdot\text{K)}$$

$$p_2 = 50.600 \text{ kPa} = 50600 \text{ Pa}$$

$$T_2 = 293.15 \text{ K}$$

$$p_1 = 25.300 \text{ kPa} = 25300 \text{ Pa}$$

$$T_1 = 293.15 \text{ K}$$

$$t_2 = 10:57:35 \text{ AM}$$

$$t_1 = 10:56:25 \text{ AM}$$

$$\dot{n}_{leak} = \frac{0.0002}{8.314472} \cdot \left(\frac{50600 - 25300}{293.15 - 293.15} \right) \cdot \frac{1}{(10:57:35 - 10:56:25)}$$

$$\dot{n}_{leak} = \frac{0.000200}{8.314472} \cdot \frac{86.304}{70}$$

$$\dot{n}_{leak} = 0.00030 \text{ mol/s}$$

■ 114. Section 1065.645 is revised to read as follows:

§ 1065.645 Amount of water in an ideal gas.

This section describes how to determine the amount of water in an ideal gas, which you need for various performance verifications and emission

calculations. Use the equation for the vapor pressure of water in paragraph (a) of this section or another appropriate equation and, depending on whether you measure dewpoint or relative humidity, perform one of the

calculations in paragraph (b) or (c) of this section.

(a) *Vapor pressure of water.* Calculate the vapor pressure of water for a given saturation temperature condition, T_{sat} , as follows, or use good engineering

judgment to use a different relationship of the vapor pressure of water to a given saturation temperature condition:

(1) For humidity measurements made at ambient temperatures from (0 to 100) °C, or for humidity

measurements made over super-cooled water at ambient temperatures from (–50 to 0) °C, use the following equation:

$$-\log_{10}(p_{\text{H}_2\text{O}}) = 10.79574 \cdot \left(\frac{273.16}{T_{\text{sat}}} - 1 \right) + 5.02800 \cdot \log_{10} \left(\frac{T_{\text{sat}}}{273.16} \right) + 1.50475 \cdot 10^{-4} \cdot \left(10^{-8.2969 \cdot \left(\frac{T_{\text{sat}}}{273.16} - 1 \right)} - 1 \right) \\ + 0.42873 \cdot 10^{-3} \cdot \left(1 - 10^{-4.76955 \cdot \left(1 - \frac{273.16}{T_{\text{sat}}} \right)} \right) + 0.21386 \quad \text{Eq. 1065.645-1}$$

Where:

$p_{\text{H}_2\text{O}}$ = vapor pressure of water at saturation temperature condition, kPa.

T_{sat} = saturation temperature of water at measured conditions, K.

Example:

$T_{\text{sat}} = 9.5$ °C

$T_{\text{dsat}} = 9.5 + 273.15 = 282.65$ K

$$-\log_{10}(p_{\text{H}_2\text{O}}) = 10.79574 \cdot \left(\frac{273.16}{282.65} - 1 \right) + 5.02800 \cdot \log_{10} \left(\frac{282.65}{273.16} \right) + 1.50475 \cdot 10^{-4} \cdot \left(10^{-8.2969 \cdot \left(\frac{282.65}{273.16} - 1 \right)} - 1 \right) \\ + 0.42873 \cdot 10^{-3} \cdot \left(1 - 10^{-4.76955 \cdot \left(1 - \frac{273.16}{282.65} \right)} \right) + 0.21386$$

$-\log_{10}(p_{\text{H}_2\text{O}}) = -0.073974$

$p_{\text{H}_2\text{O}} = 10^{0.073974} = 1.18569$ kPa

(2) For humidity measurements over ice at ambient temperatures from (–100 to 0) °C, use the following equation:

$$-\log_{10}(p_{\text{sat}}) = 9.09685 \cdot \left(\frac{273.16}{T_{\text{sat}}} - 1 \right) + 3.56654 \cdot \log_{10} \left(\frac{273.16}{T_{\text{sat}}} \right) + 0.87682 \cdot \left(\frac{T_{\text{sat}}}{273.16} - 1 \right) + 0.21386 \quad \text{Eq. 1065.645-2}$$

Example:

$T_{\text{ice}} = -15.4$ °C

$T_{\text{ice}} = -15.4 + 273.15 = 257.75$ K

$$-\log_{10}(p_{\text{sat}}) = 9.09685 \cdot \left(\frac{273.16}{257.75} - 1 \right) + 3.56654 \cdot \log_{10} \left(\frac{273.16}{257.75} \right) + 0.87682 \cdot \left(\frac{257.75}{273.16} - 1 \right) + 0.21386$$

$-\log_{10}(p_{\text{H}_2\text{O}}) = -0.79821$

$p_{\text{H}_2\text{O}} = 10^{0.79821} = 0.15914$ kPa

(b) *Dewpoint.* If you measure humidity as a dewpoint, determine the amount of water in an ideal gas, $x_{\text{H}_2\text{O}}$, as follows:

$$x_{\text{H}_2\text{O}} = \frac{p_{\text{H}_2\text{O}}}{p_{\text{abs}}} \quad \text{Eq. 1065.645-3}$$

Where:

$x_{\text{H}_2\text{O}}$ = amount of water in an ideal gas.

$p_{\text{H}_2\text{O}}$ = water vapor pressure at the measured dewpoint, $T_{\text{sat}} = T_{\text{dew}}$.

p_{abs} = wet static absolute pressure at the location of your dewpoint measurement.

Example:

$p_{\text{abs}} = 99.980$ kPa

$T_{\text{sat}} = T_{\text{dew}} = 9.5$ °C

Using Eq. 1065.645–2,

$p_{\text{H}_2\text{O}} = 1.18489$ kPa

$x_{\text{H}_2\text{O}} = 1.18489/99.980$

$x_{\text{H}_2\text{O}} = 0.011851$ mol/mol

(c) *Relative humidity.* If you measure humidity as a relative humidity, RH %, determine the amount of water in an ideal gas, $x_{\text{H}_2\text{O}}$, as follows:

$$x_{\text{H}_2\text{O}} = \frac{\text{RH}\% \cdot p_{\text{H}_2\text{O}}}{p_{\text{abs}}} \quad \text{Eq. 1065.645-4}$$

Where:

$x_{\text{H}_2\text{O}}$ = amount of water in an ideal gas.

RH % = relative humidity.

$p_{\text{H}_2\text{O}}$ = water vapor pressure at 100% relative humidity at the location of your relative humidity measurement, $T_{\text{sat}} = T_{\text{amb}}$.

p_{abs} = wet static absolute pressure at the location of your relative humidity measurement.

Example:

RH % = 50.77%

$p_{\text{abs}} = 99.980$ kPa

$T_{\text{sat}} = T_{\text{amb}} = 20$ °C

Using Eq. 1065.645–2,

$p_{\text{H}_2\text{O}} = 2.3371$ kPa

$x_{\text{H}_2\text{O}} = (50.77\% \cdot 2.3371)/99.980$

$x_{\text{H}_2\text{O}} = 0.011868$ mol/mol

■ 115. Section 1065.650 is revised to read as follows:

§ 1065.650 Emission calculations.

(a) *General.* Calculate brake-specific emissions over each test interval in a duty cycle. Refer to the standard-setting part for any calculations you might need to determine a composite result, such as a calculation that weights and sums the

results of individual test intervals in a duty cycle. For summations of continuous signals, each indexed value (i.e., “*i*”) represents (or approximates) the mean value of the parameter for its respective time interval, Δt .

(b) We specify three alternative ways to calculate brake-specific emissions, as follows:

(1) For any testing, you may calculate the total mass of emissions, as described in paragraph (c) of this section, and divide it by the total work generated over the test interval, as described in paragraph (d) of this section, using the following equation:

$$e = \frac{m}{W} \quad \text{Eq. 1065.650-1}$$

Example:

$$\begin{aligned} m_{\text{NO}_x} &= 64.975 \text{ g} \\ W &= 25.783 \text{ kW}\cdot\text{hr} \\ e_{\text{NO}_x} &= 64.975/25.783 \\ e_{\text{NO}_x} &= 2.520 \text{ g}/(\text{kW}\cdot\text{hr}) \end{aligned}$$

(2) For discrete-mode steady-state testing, you may calculate the ratio of emission mass rate to power, as described in paragraph (e) of this section, using the following equation:

$$e = \frac{\bar{m}}{P} \quad \text{Eq. 1065.650-2}$$

(3) For field testing, you may calculate the ratio of total mass to total work, where these individual values are determined as described in paragraph (f) of this section. You may also use this approach for laboratory testing, consistent with good engineering judgment. This is a special case in which you use a signal linearly proportional to raw exhaust molar flow rate to determine a value proportional to total emissions. You then use the same linearly proportional signal to determine total work using a chemical balance of fuel, intake air, and exhaust as described in § 1065.655, plus information about your engine's brake-specific fuel consumption. Under this method, flow meters need not meet accuracy specifications, but they must meet the applicable linearity and repeatability specifications in subpart D or subpart J of this part. The result is a brake-specific emission value calculated as follows:

$$e = \frac{\tilde{m}}{\tilde{W}} \quad \text{Eq. 1065.650-3}$$

Example:

$$\begin{aligned} \tilde{m} &= 805.5 \sim \text{g} \\ \tilde{W} &= 52.102 \sim \text{kW}\cdot\text{hr} \\ e_{\text{CO}} &= 805.5/52.102 \\ e_{\text{CO}} &= 2.520 \text{ g}/(\text{kW}\cdot\text{hr}) \end{aligned}$$

(c) *Total mass of emissions.* To calculate the total mass of an emission,

multiply a concentration by its respective flow. For all systems, make preliminary calculations as described in paragraph (c)(1) of this section, then use the method in paragraphs (c)(2) through (4) of this section that is appropriate for your system. Calculate the total mass of emissions as follows:

(1) *Concentration corrections.* Perform the following sequence of preliminary calculations on recorded concentrations:

(i) Correct all THC and CH_4 concentrations, including continuous readings, sample bags readings, and dilution air background readings, for initial contamination, as described in § 1065.660(a).

(ii) Correct all concentrations measured on a “dry” basis to a “wet” basis, including dilution air background concentrations, as described in § 1065.659.

(iii) Calculate all THC and NMHC concentrations, including dilution air background concentrations, as described in § 1065.660.

(iv) For emission testing with an oxygenated fuel, calculate any HC concentrations, including dilution air background concentrations, as described in § 1065.665. See subpart I of this part for testing with oxygenated fuels.

(v) Correct all the NO_x concentrations, including dilution air background concentrations, for intake-air humidity as described in § 1065.670.

(vi) Compare the background corrected mass of NMHC to background corrected mass of THC. If the background corrected mass of NMHC is greater than 0.98 times the background corrected mass of THC, take the background corrected mass of NMHC to be 0.98 times the background corrected mass of THC. If you omit the NMHC calculations as described in § 1065.660(b)(1), take the background corrected mass of NMHC to be 0.98 times the background corrected mass of THC.

(vii) Calculate brake-specific emissions before and after correcting for drift, including dilution air background concentrations, according to § 1065.672.

(2) *Continuous sampling.* For continuous sampling, you must frequently record a continuously updated concentration signal. You may measure this concentration from a changing flow rate or a constant flow rate (including discrete-mode steady-state testing), as follows:

(i) *Varying flow rate.* If you continuously sample from a changing exhaust flow rate, time align and then multiply concentration measurements by the flow rate from which you extracted it. Use good engineering judgment to time align flow and

concentration data to match t_{50} rise or fall times to within ± 1 s. We consider the following to be examples of changing flows that require a continuous multiplication of concentration times molar flow rate: raw exhaust, exhaust diluted with a constant flow rate of dilution air, and CVS dilution with a CVS flowmeter that does not have an upstream heat exchanger or electronic flow control. This multiplication results in the flow rate of the emission itself. Integrate the emission flow rate over a test interval to determine the total emission. If the total emission is a molar quantity, convert this quantity to a mass by multiplying it by its molar mass, M . The result is the mass of the emission, m . Calculate m for continuous sampling with variable flow using the following equations:

$$m = M \cdot \sum_{i=1}^N x_i \cdot \dot{n}_i \cdot \Delta t \quad \text{Eq. 1065.650-4}$$

Where:

$$\Delta t = 1/f_{\text{record}} \quad \text{Eq. 1065.650-5}$$

Example:

$$\begin{aligned} M_{\text{NMHC}} &= 13.875389 \text{ g/mol} \\ N &= 1200 \\ x_{\text{NMHC1}} &= 84.5 \mu\text{mol/mol} = 84.5 \cdot 10^{-6} \text{ mol/mol} \\ x_{\text{NMHC2}} &= 86.0 \mu\text{mol/mol} = 86.0 \cdot 10^{-6} \text{ mol/mol} \\ \dot{n}_{\text{exh1}} &= 2.876 \text{ mol/s} \\ \dot{n}_{\text{exh2}} &= 2.224 \text{ mol/s} \\ f_{\text{record}} &= 1 \text{ Hz} \\ \text{Using Eq. 1065.650-5,} \\ \Delta t &= 1/1 = 1 \text{ s} \\ m_{\text{NMHC}} &= 13.875389 \cdot (84.5 \cdot 10^{-6} \cdot 2.876 + \\ &\quad 86.0 \cdot 10^{-6} \cdot 2.224 + \dots + x_{\text{NMHC1200}} \cdot \dot{n}_{\text{exh}}) \\ &\quad \cdot 1 \\ m_{\text{NMHC}} &= 25.53 \text{ g} \end{aligned}$$

(ii) *Constant flow rate.* If you continuously sample from a constant exhaust flow rate, use the same emission calculations described in paragraph (c)(2)(i) of this section or calculate the mean or flow-weighted concentration recorded over the test interval and treat the mean as a batch sample, as described in paragraph (c)(3)(ii) of this section. We consider the following to be examples of constant exhaust flows: CVS diluted exhaust with a CVS flowmeter that has either an upstream heat exchanger, electronic flow control, or both.

(3) *Batch sampling.* For batch sampling, the concentration is a single value from a proportionally extracted batch sample (such as a bag, filter, impinger, or cartridge). In this case, multiply the mean concentration of the batch sample by the total flow from which the sample was extracted. You may calculate total flow by integrating a changing flow rate or by determining

the mean of a constant flow rate, as follows:

(i) *Varying flow rate.* If you collect a batch sample from a changing exhaust flow rate, extract a sample proportional to the changing exhaust flow rate. We consider the following to be examples of changing flows that require proportional sampling: Raw exhaust, exhaust diluted with a constant flow rate of dilution air, and CVS dilution with a CVS flowmeter that does not have an upstream heat exchanger or electronic flow control. Integrate the flow rate over a test interval to determine the total flow from which you extracted the proportional sample. Multiply the mean concentration of the batch sample by the total flow from which the sample was extracted. If the total emission is a molar quantity, convert this quantity to a mass by multiplying it by its molar mass, M . The result is the mass of the emission, m . In the case of PM emissions, where the mean PM concentration is already in units of mass per mole of sample, \bar{M}_{PM} , simply multiply it by the total flow. The result is the total mass of PM, m_{PM} . Calculate m for batch sampling with variable flow using the following equation:

$$m = M \cdot \bar{x} \cdot \sum_{i=1}^N \dot{n}_i \cdot \Delta t \quad \text{Eq. 1065.650-6}$$

Example:

$$M_{NOx} = 46.0055 \text{ g/mol}$$

$$N = 9000$$

$$\bar{x}_{NOx} = 85.6 \text{ } \mu\text{mol/mol} = 85.6 \cdot 10^{-6} \text{ mol/mol}$$

$$\dot{n}_{dexh1} = 25.534 \text{ mol/s}$$

$$\dot{n}_{dexh2} = 26.950 \text{ mol/s}$$

$$f_{record} = 5 \text{ Hz}$$

Using Eq. 1065.650-5,

$$\Delta t = 1/5 = 0.2$$

$$m_{NOx} = 46.0055 \cdot 85.6 \cdot 10^{-6} \cdot (25.534 + 26.950 + \dots + \dot{n}_{exh9000}) \cdot 0.2$$

$$m_{NOx} = 4.201 \text{ g}$$

(ii) *Constant flow rate.* If you batch sample from a constant exhaust flow rate, extract a sample at a proportional or constant flow rate. We consider the following to be examples of constant exhaust flows: CVS diluted exhaust with a CVS flow meter that has either an upstream heat exchanger, electronic flow control, or both. Determine the mean molar flow rate from which you extracted the constant flow rate sample. Multiply the mean concentration of the batch sample by the mean molar flow rate of the exhaust from which the sample was extracted, and multiply the result by the time of the test interval. If the total emission is a molar quantity, convert this quantity to a mass by multiplying it by its molar mass, M . The result is the mass of the emission, m . In the case of PM emissions, where the mean PM concentration is already in

units of mass per mole of sample, \bar{M}_{PM} , simply multiply it by the total flow, and the result is the total mass of PM, m_{PM} . Calculate m for sampling with constant flow using the following equations:

$$m = M \cdot \bar{x} \cdot \bar{n} \cdot \Delta t \quad \text{Eq. 1065.650-7}$$

and for PM or any other analysis of a batch sample that yields a mass per mole of sample,

$$\bar{M} = M \cdot \bar{x} \quad \text{Eq. 1065.650-8}$$

Example:

$$\bar{M}_{PM} = 144.0 \text{ } \mu\text{g/mol} = 144.0 \cdot 10^{-6} \text{ g/mol}$$

$$\dot{n}_{dexh} = 57.692 \text{ mol/s}$$

$$\Delta t = 1200 \text{ s}$$

$$m_{PM} = 144.0 \cdot 10^{-6} \cdot 57.692 \cdot 1200$$

$$m_{PM} = 9.9692 \text{ g}$$

(4) *Additional provisions for diluted exhaust sampling; continuous or batch.* The following additional provisions apply for sampling emissions from diluted exhaust:

(i) For sampling with a constant dilution ratio (DR) of diluted exhaust versus exhaust flow (e.g., secondary dilution for PM sampling), calculate m using the following equation:

$$m = m_{dil} \cdot (DR) \quad \text{Eq. 1065.650-9}$$

Example:

$$m_{PMdil} = 6.853 \text{ g}$$

$$DR = 6:1$$

$$m_{PM} = 6.853 \cdot (6)$$

$$m_{PM} = 41.118 \text{ g}$$

(ii) For continuous or batch sampling, you may measure background emissions in the dilution air. You may then subtract the measured background emissions, as described in § 1065.667.

(d) *Total work.* To calculate total work from the engine's primary output shaft, numerically integrate feedback power over a test interval. Before integrating, adjust the speed and torque data for the time alignment used in § 1065.514(c). Any advance or delay used on the feedback signals for cycle validation must also be used for calculating work. Account for work of accessories according to § 1065.110. Exclude any work during cranking and starting. Exclude work during actual motoring operation (negative feedback torques), unless the engine was connected to one or more energy storage devices. Examples of such energy storage devices include hybrid powertrain batteries and hydraulic accumulators, like the ones illustrated in Figure 1 of § 1065.210. Exclude any work during reference zero-load idle periods (0% speed or idle speed with 0 N·m reference torque). Note, that there must be two consecutive reference zero load idle points to establish a period where this applies. Include work during idle points

with simulated minimum torque such as Curb Idle Transmissions Torque (CITT) for automatic transmissions in "drive". The work calculation method described in paragraphs (b)(1) through (7) of this section meets these requirements using rectangular integration. You may use other logic that gives equivalent results. For example, you may use a trapezoidal integration method as described in paragraph (b)(8) of this section.

(1) Time align the recorded feedback speed and torque values by the amount used in § 1065.514(c).

(2) Calculate shaft power at each point during the test interval by multiplying all the recorded feedback engine speeds by their respective feedback torques.

(3) Adjust (reduce) the shaft power values for accessories according to § 1065.110.

(4) Set all power values during any cranking or starting period to zero. See § 1065.525 for more information about engine cranking.

(5) Set all negative power values to zero, unless the engine was connected to one or more energy storage devices. If the engine was tested with an energy storage device, leave negative power values unaltered.

(6) Set all power values to zero during idle periods with a corresponding reference torque of 0 N·m.

(7) Integrate the resulting values for power over the test interval. Calculate total work as follows:

$$W = \sum_{i=1}^N P_i \cdot \Delta t \quad \text{Eq. 1065.650-10}$$

$$P_i = f_{ni} \cdot T_i \quad \text{Eq. 1065.650-11}$$

Example:

$$N = 9000$$

$$f_{n1} = 1800.2 \text{ rev/min}$$

$$f_{n2} = 1805.8 \text{ rev/min}$$

$$T_1 = 177.23 \text{ N·m}$$

$$T_2 = 175.00 \text{ N·m}$$

$$C_{rev} = 2 \cdot \pi \text{ rad/rev}$$

$$C_{t1} = 60 \text{ s/min}$$

$$C_p = 1000 \text{ (N·m·rad/s)/kW}$$

$$f_{record} = 5 \text{ Hz}$$

$$C_{t2} = 3600 \text{ s/hr}$$

$$P_1 = \frac{1800.2 \cdot 177.23 \cdot 2 \cdot 3.14159}{60 \cdot 1000}$$

$$P_1 = 33.41 \text{ kW}$$

$$P_2 = 33.09 \text{ kW}$$

Using Eq. 1065.650-5,

$$\Delta t = 1/5 = 0.2 \text{ s}$$

$$W = \frac{(33.41 + 33.09 + \dots + P_{9000}) \cdot 0.2}{3600}$$

$$W = 16.875 \text{ kW·hr}$$

(8) You may use a trapezoidal integration method instead of the

rectangular integration described in this paragraph (b). To do this, you must integrate the fraction of work between points where the torque is positive. You may assume that speed and torque are linear between data points. You may not set negative values to zero before running the integration.

(e) *Steady-state mass rate divided by power.* To determine steady-state brake-specific emissions for a test interval as described in paragraph (b)(2) of this section, calculate the mean steady-state mass rate of the emission, \bar{m} , and the mean steady-state power, \bar{P} as follows:

(1) To calculate \bar{m} , multiply its mean concentration, \bar{x} , by its corresponding mean molar flow rate, \bar{n} . If the result is a molar flow rate, convert this quantity to a mass rate by multiplying it by its molar mass, M . The result is the mean mass rate of the emission, \bar{m} . In the case of PM emissions, where the mean PM concentration is already in units of mass per mole of sample, \bar{M}_{PM} , simply

multiply it by the mean molar flow rate, \bar{n} . The result is the mass rate of PM, \bar{m}_{PM} . Calculate \bar{m} using the following equation:

$$\bar{m} = M \cdot \bar{x} \cdot \bar{n} \quad \text{Eq. 1065.650-12}$$

(2) Calculate \bar{P} using the following equation:

$$\bar{P} = \bar{f}_n \cdot \bar{T} \quad \text{Eq. 1065.650-13}$$

(3) Divide emission mass rate by power to calculate a brake-specific emission result as described in paragraph (b)(2) of this section.

(4) The following example shows how to calculate mass of emissions using mean mass rate and mean power:

$$\begin{aligned} M_{CO} &= 28.0101 \text{ g/mol} \\ \bar{x}_{CO} &= 12.00 \text{ mmol/mol} = 0.01200 \text{ mol/mol} \\ \bar{n} &= 1.530 \text{ mol/s} \\ \bar{f}_n &= 3584.5 \text{ rev/min} = 375.37 \text{ rad/s} \\ \bar{T} &= 121.50 \text{ N}\cdot\text{m} \end{aligned}$$

$$\begin{aligned} \bar{m} &= 28.0101 \cdot 0.01200 \cdot 1.530 \\ \bar{m} &= 0.514 \text{ g/s} = 1850.4 \text{ g/hr} \\ \bar{P} &= 121.5 \cdot 375.37 \\ \bar{P} &= 45607 \\ W &= 45.607 \text{ kW} \\ e_{CO} &= 1850.4/45.61 \\ e_{CO} &= 40.57 \text{ g/(kW}\cdot\text{hr)} \end{aligned}$$

(f) *Ratio of total mass of emissions to total work.* To determine brake-specific emissions for a test interval as described in paragraph (b)(3) of this section, calculate a value proportional to the total mass of each emission. Divide each proportional value by a value that is similarly proportional to total work.

(1) *Total mass.* To determine a value proportional to the total mass of an emission, determine total mass as described in paragraph (c) of this section, except substitute for the molar flow rate, \dot{n} , or the total flow, n , with a signal that is linearly proportional to molar flow rate, \tilde{n} , or linearly proportional to total flow, \tilde{n} as follows:

$$\tilde{m}_{\text{fuel}} = \frac{1}{w_{\text{fuel}}} \cdot \frac{M_c \cdot \tilde{n}_i \cdot x_{\text{Ccombdry}i}}{1 + x_{\text{H}_2\text{Oexhdry}i}} \quad \text{Eq. 1065.650-14}$$

(2) *Total work.* To calculate a value proportional to total work over a test interval, integrate a value that is proportional to power. Use information about the brake-specific fuel consumption of your engine, e_{fuel} , to convert a signal proportional to fuel flow rate to a signal proportional to power. To determine a signal proportional to fuel flow rate, divide a signal that is proportional to the mass rate of carbon products by the fraction of carbon in your fuel, w_c . For your fuel, you may use a measured w_c or you may use the default values in Table 1 of § 1065.655. Calculate the mass rate of carbon from the amount of carbon and water in the exhaust, which you determine with a chemical balance of

fuel, intake air, and exhaust as described in § 1065.655. In the chemical balance, you must use concentrations from the flow that generated the signal proportional to molar flow rate, \tilde{n} , in paragraph (e)(1) of this section. Calculate a value proportional to total work as follows:

$$W = \sum_{i=1}^N \tilde{P}_i \cdot \Delta t \quad \text{Eq. 1065.650-15}$$

Where:

$$\tilde{P}_i = \frac{\tilde{m}_{\text{fuel}i}}{e_{\text{fuel}}} \quad \text{Eq. 1065.650-16}$$

(3) *Brake-specific emissions.* Divide the value proportional to total mass by

the value proportional to total work to determine brake-specific emissions, as described in paragraph (b)(3) of this section.

(4) *Example.* The following example shows how to calculate mass of emissions using proportional values:

$$\begin{aligned} N &= 3000 \\ f_{\text{record}} &= 5 \text{ Hz} \\ e_{\text{fuel}} &= 285 \text{ g/(kW}\cdot\text{hr)} \\ w_{\text{fuel}} &= 0.869 \text{ g/g} \\ M_c &= 12.0107 \text{ g/mol} \\ \tilde{n}_1 &= 3.922 \text{ mol/s} = 14119.2 \text{ mol/hr} \\ x_{\text{Ccombdry}1} &= 91.634 \text{ mmol/mol} = 0.091634 \\ &\quad \text{mol/mol} \\ x_{\text{H}_2\text{Oexh}1} &= 27.21 \text{ mmol/mol} = 0.02721 \text{ mol/mol} \\ &\quad \text{mol} \\ &\text{Using Eq. 1065.650-5,} \\ &\Delta t = 0.2 \text{ s} \end{aligned}$$

$$\tilde{W} = \frac{12.0107 \left[\frac{3.922 \cdot 0.091634}{1 + 0.02721} + \frac{\tilde{n}_2 \cdot x_{\text{Ccombdry}2}}{1 + x_{\text{H}_2\text{Oexh}2}} + \dots + \frac{\tilde{n}_{3000} \cdot x_{\text{Ccombdry}3000}}{1 + x_{\text{H}_2\text{Oexh}3000}} \right] \cdot 0.2}{285 \cdot 0.869}$$

$$\tilde{W} = 5.09 \text{ (kW}\cdot\text{hr)}$$

(g) *Rounding.* Round emission values only after all calculations are complete and the result is in g/(kW·hr) or units equivalent to the units of the standard, such as g/(hp·hr). See the definition of "Round" in § 1065.1001.

■ 116. Section 1065.655 is revised to read as follows:

§ 1065.655 Chemical balances of fuel, intake air, and exhaust.

(a) *General.* Chemical balances of fuel, intake air, and exhaust may be used to calculate flows, the amount of water in

their flows, and the wet concentration of constituents in their flows. With one flow rate of either fuel, intake air, or exhaust, you may use chemical balances to determine the flows of the other two. For example, you may use chemical balances along with either intake air or fuel flow to determine raw exhaust flow.

(b) *Procedures that require chemical balances.* We require chemical balances when you determine the following:

(1) A value proportional to total work, \bar{W} , when you choose to determine brake-specific emissions as described in § 1065.650(e).

(2) The amount of water in a raw or diluted exhaust flow, $x_{H_2O_{exh}}$, when you do not measure the amount of water to correct for the amount of water removed by a sampling system. Correct for removed water according to § 1065.659(c)(2).

(3) The flow-weighted mean fraction of dilution air in diluted exhaust, $x_{dil/exh}$, when you do not measure dilution air flow to correct for background emissions as described in § 1065.667(c). Note that if you use chemical balances for this purpose, you are assuming that your exhaust is stoichiometric, even if it is not.

(c) *Chemical balance procedure.* The calculations for a chemical balance involve a system of equations that require iteration. We recommend using a computer to solve this system of equations. You must guess the initial values of up to three quantities: The amount of water in the measured flow, $x_{H_2O_{exh}}$, fraction of dilution air in diluted exhaust, $x_{dil/exh}$, and the amount of products on a C_1 basis per dry mole of dry measured flow, $x_{C_{comb}dry}$. You may use time-weighted mean values of combustion air humidity and dilution air humidity in the chemical balance; as long as your combustion air and dilution air humidities remain within tolerances of ± 0.0025 mol/mol of their respective mean values over the test interval. For each emission concentration, x , and amount of water, $x_{H_2O_{exh}}$, you must determine their completely dry concentrations, x_{dry} and $x_{H_2O_{exhdry}}$. You must also use your fuel's atomic hydrogen-to-carbon ratio, α , and oxygen-to-carbon ratio, β . For your fuel, you may measure α and β or you may use the default values in Table 1 of § 1065.650. Use the following steps to complete a chemical balance:

(1) Convert your measured concentrations such as, x_{CO_2meas} , $x_{NO_{meas}}$, and $x_{H_2O_{int}}$, to dry concentrations by dividing them by one

minus the amount of water present during their respective measurements; for example: $x_{H_2O \times CO_2meas}$, $x_{H_2O \times NO_{meas}}$, and $x_{H_2O_{int}}$. If the amount of water present during a "wet" measurement is the same as the unknown amount of water in the exhaust flow, $x_{H_2O_{exh}}$, iteratively solve for that value in the system of equations. If you measure only total NO_x and not NO and NO_2 separately, use good engineering judgment to estimate a split in your total NO_x concentration between NO and NO_2 for the chemical balances. For example, if you measure emissions from a stoichiometric spark-ignition engine, you may assume all NO_x is NO . For a compression-ignition engine, you may assume that your molar concentration of NO_x , x_{NO_x} , is 75% NO and 25% NO_2 . For NO_2 storage aftertreatment systems, you may assume x_{NO_x} is 25% NO and 75% NO_2 . Note that for calculating the mass of NO_x emissions, you must use the molar mass of NO_2 for the effective molar mass of all NO_x species, regardless of the actual NO_2 fraction of NO_x .

(2) Enter the equations in paragraph (c)(4) of this section into a computer program to iteratively solve for $x_{H_2O_{exh}}$, $x_{C_{comb}dry}$, and $x_{dil/exh}$. Use good engineering judgment to guess initial values for $x_{H_2O_{exh}}$, $x_{C_{comb}dry}$, and $x_{dil/exh}$. We recommend guessing an initial amount of water that is about twice the amount of water in your intake or dilution air. We recommend guessing an initial value of $x_{C_{comb}dry}$ as the sum of your measured CO_2 , CO , and THC values. We also recommend guessing an initial $x_{dil/exh}$ between 0.75 and 0.95, such as 0.8. Iterate values in the system of equations until the most recently updated guesses are all within $\pm 1\%$ of their respective most recently calculated values.

(3) Use the following symbols and subscripts in the equations for this paragraph (c):

$x_{dil/exh}$ = Amount of dilution gas or excess air per mole of exhaust.

$x_{H_2O_{exh}}$ = Amount of water in exhaust per mole of exhaust.

$x_{C_{comb}dry}$ = Amount of carbon from fuel in the exhaust per mole of dry exhaust.

$x_{H_2O_{exhdry}}$ = Amount of water in exhaust per dry mole of dry exhaust.

$x_{prod/intdry}$ = Amount of dry stoichiometric products per dry mole of intake air.

$x_{dil/exhdry}$ = Amount of dilution gas and/or excess air per mole of dry exhaust.

$x_{int/exhdry}$ = Amount of intake air required to produce actual combustion products per mole of dry (raw or diluted) exhaust.

$x_{raw/exhdry}$ = Amount of undiluted exhaust, without excess air, per mole of dry (raw or diluted) exhaust.

x_{O_2int} = Amount of intake air O_2 per mole of intake air.

$x_{CO_2intdry}$ = Amount of intake air CO_2 per mole of dry intake air. You may use $x_{CO_2intdry} = 375 \mu\text{mol/mol}$, but we recommend measuring the actual concentration in the intake air.

$x_{H_2O_{intdry}}$ = Amount of intake air H_2O per mole of dry intake air.

x_{CO_2int} = Amount of intake air CO_2 per mole of intake air.

x_{CO_2dil} = Amount of dilution gas CO_2 per mole of dilution gas.

$x_{CO_2dildry}$ = Amount of dilution gas CO_2 per mole of dry dilution gas. If you use air as diluent, you may use $x_{CO_2dildry} = 375 \mu\text{mol/mol}$, but we recommend measuring the actual concentration in the intake air.

$x_{H_2O_{dildry}}$ = Amount of dilution gas H_2O per mole of dry dilution gas.

$x_{H_2O_{dil}}$ = Amount of dilution gas H_2O per mole of dilution gas.

$x_{[emission]meas}$ = Amount of measured emission in the sample at the respective gas analyzer.

$x_{[emission]dry}$ = Amount of emission per dry mole of dry sample.

$x_{H_2O[emission]meas}$ = Amount of water in sample at emission-detection location. Measure or estimate these values according to § 1065.145(d)(2).

$x_{H_2O_{int}}$ = Amount of water in the intake air, based on a humidity measurement of intake air.

α = Atomic hydrogen-to-carbon ratio in fuel.
 β = Atomic oxygen-to-carbon ratio in fuel.

(4) Use the following equations to iteratively solve for $x_{dil/exh}$, $x_{H_2O_{exh}}$, and $x_{C_{comb}dry}$:

$$x_{dil/exh} = 1 - \frac{x_{raw/exhdry}}{1 + x_{H_2O_{exhdry}}} \quad \text{Eq. 1065.655-1}$$

$$x_{H_2O_{exh}} = \frac{x_{H_2O_{exhdry}}}{1 + x_{H_2O_{exhdry}}} \quad \text{Eq. 1065.655-2}$$

$$x_{C_{comb}dry} = x_{CO_2dry} + x_{COdry} + x_{THCdry} - x_{CO_2dil} \cdot x_{dil/exhdry} - x_{CO_2int} \cdot x_{int/exhdry} \quad \text{Eq. 1065.655-3}$$

$$x_{H_2O_{exhdry}} = \frac{\alpha}{2} (x_{C_{comb}dry} - x_{THCdry}) + x_{H_2O_{dil}} \cdot x_{dil/exhdry} + x_{H_2O_{int}} \cdot x_{int/exhdry} \quad \text{Eq. 1065.655-4}$$

$$x_{\text{dil/exhdry}} = \frac{x_{\text{dil/exh}}}{1 - x_{\text{H}_2\text{Oexh}}} \quad \text{Eq. 1065.655-5}$$

$$x_{\text{int/exhdry}} = \frac{1}{2 \cdot x_{\text{O}_2\text{int}}} \left(\left(\frac{\alpha}{2} - \beta + 2 \right) \cdot (x_{\text{Ccombdry}} - x_{\text{THCdry}}) - (x_{\text{COdry}} - x_{\text{NOdry}} - 2x_{\text{NO}_2\text{dry}}) \right) \quad \text{Eq. 1065.655-6}$$

$$x_{\text{raw/exhdry}} = \frac{1}{2} \left(\left(\frac{\alpha}{2} + \beta \right) \cdot (x_{\text{Ccombdry}} - x_{\text{THCdry}}) + (2x_{\text{THCdry}} + x_{\text{COdry}} - x_{\text{NO}_2\text{dry}}) \right) + x_{\text{int/exhdry}} \quad \text{Eq. 1065.655-7}$$

$$x_{\text{O}_2\text{int}} = \frac{0.209820 - x_{\text{CO}_2\text{intdry}}}{1 + x_{\text{H}_2\text{Ointdry}}} \quad \text{Eq. 1065.655-8}$$

$$x_{\text{CO}_2\text{int}} = \frac{x_{\text{CO}_2\text{intdry}}}{1 + x_{\text{H}_2\text{Ointdry}}} \quad \text{Eq. 1065.655-9}$$

$$x_{\text{H}_2\text{Ointdry}} = \frac{x_{\text{H}_2\text{Oint}}}{1 - x_{\text{H}_2\text{Oint}}} \quad \text{Eq. 1065.655-10}$$

$$x_{\text{CO}_2\text{dil}} = \frac{x_{\text{CO}_2\text{dildry}}}{1 + x_{\text{H}_2\text{Odildry}}} \quad \text{Eq. 1065.655-11}$$

$$x_{\text{H}_2\text{Odildry}} = \frac{x_{\text{H}_2\text{Odil}}}{1 - x_{\text{H}_2\text{Odil}}} \quad \text{Eq. 1065.655-12}$$

$$x_{\text{COdry}} = \frac{x_{\text{COmeas}}}{1 - x_{\text{H}_2\text{OCOmeas}}} \quad \text{Eq. 1065.655-13}$$

$$x_{\text{CO}_2\text{dry}} = \frac{x_{\text{CO}_2\text{meas}}}{1 - x_{\text{H}_2\text{OCO}_2\text{meas}}} \quad \text{Eq. 1065.655-14}$$

$$x_{\text{NOdry}} = \frac{x_{\text{NOmeas}}}{1 - x_{\text{H}_2\text{ONomeas}}} \quad \text{Eq. 1065.655-15}$$

$$x_{\text{NO}_2\text{dry}} = \frac{x_{\text{NO}_2\text{meas}}}{1 - x_{\text{H}_2\text{ONO}_2\text{meas}}} \quad \text{Eq. 1065.655-16}$$

$$x_{\text{THCdry}} = \frac{x_{\text{THCmeas}}}{1 - x_{\text{H}_2\text{OTHCmeas}}} \quad \text{Eq. 1065.655-17}$$

(5) The following example is a solution for $x_{\text{dil/exh}}$, $x_{\text{H}_2\text{Oexh}}$, and x_{Ccombdry} using the equations in paragraph (c)(4) of this section:

$$x_{\text{dil/exh}} = 1 - \frac{0.182}{1 + \frac{35.18}{1000}} = 0.824 \text{ mol/mol}$$

$$x_{\text{H}_2\text{Oexh}} = \frac{35.18}{1 + \frac{35.18}{1000}} = 33.98 \text{ mmol/mol}$$

$$x_{\text{Ccombdry}} = 0.025 + \frac{29.3}{1000000} + \frac{47.6}{1000000} - \frac{0.371}{1000} \cdot 0.853 - \frac{0.369}{1000} \cdot 0.171 = 0.0247 \text{ mol/mol}$$

$$x_{\text{H}_2\text{Oexhdry}} = \frac{1.8}{2} \left(0.0247 - \frac{47.6}{1000000} \right) + 0.012 \cdot 0.853 + 0.017 \cdot 0.171 = 0.035 \text{ mol/mol}$$

$$x_{\text{dil/exhdry}} = \frac{0.824}{1 - 0.034} = 0.853 \text{ mol/mol}$$

$$x_{\text{int/exhdry}} = \frac{1}{2 \cdot 0.206} \left(\left(\frac{1.8}{2} - 0.050 + 2 \right) \cdot \left(0.0247 - \frac{47.6}{1000000} \right) - \left(\frac{29.3}{1000000} - \frac{50.4}{1000000} - 2 \cdot \frac{12.1}{1000000} \right) \right) = 0.171 \text{ mol/mol}$$

$$x_{\text{raw/exhdry}} = \frac{1}{2} \left(\left(\frac{1.8}{2} + 0.050 \right) \cdot \left(0.0247 - \frac{47.6}{1000000} \right) + \left(2 \cdot \frac{47.6}{1000000} + \frac{29.3}{1000000} - \frac{12.1}{1000000} \right) \right) + 0.171 = 0.182 \text{ mol/mol}$$

$$x_{\text{O}_2\text{int}} = \frac{0.209820 - 0.000375}{1 + \frac{17.22}{1000}} = 0.206 \text{ mol/mol}$$

$$x_{\text{CO}_2\text{int}} = \frac{0.000375 \times 1000}{1 + \frac{17.22}{1000}} = 0.371 \text{ mmol/mol}$$

$$x_{\text{H}_2\text{Ointdry}} = \frac{16.93}{1 - \frac{16.93}{1000}} = 17.22 \text{ mmol/mol}$$

$$x_{\text{CO}_2\text{dry}} = \frac{29.0}{1 - \frac{8.601}{1000}} = 29.3 \text{ mmol/mol}$$

$$x_{\text{NO}_2\text{dry}} = \frac{12.0}{1 - \frac{8.601}{1000}} = 12.1 \text{ mmol/mol}$$

$$x_{\text{CO}_2\text{dil}} = \frac{0.375}{1 + \frac{12.01}{1000}} = 0.37 \text{ mmol/mol}$$

$$x_{\text{CO}_2\text{dry}} = \frac{24.98}{1 - \frac{8.601}{1000}} = 25.2 \text{ mmol/mol}$$

$$x_{\text{THCdry}} = \frac{46}{1 - \frac{33.98}{1000}} = 47.6 \text{ mmol/mol}$$

$$\alpha = 1.8$$

$$\beta = 0.05$$

$$x_{\text{H}_2\text{Odildry}} = \frac{11.87}{1 - \frac{11.87}{1000}} = 12.01 \text{ mmol/mol}$$

$$x_{\text{NO}_2\text{dry}} = \frac{50.0}{1 - \frac{8.601}{1000}} = 50.4 \text{ mmol/mol}$$

TABLE 1 OF § 1065.655.—DEFAULT VALUES OF ATOMIC HYDROGEN-TO-CARBON RATIO, α , ATOMIC OXYGEN-TO-CARBON RATIO, β , AND CARBON MASS FRACTION OF FUEL, w_C , FOR VARIOUS FUELS

Fuel	Atomic hydrogen and oxygen-to-carbon ratios CH α O β	Carbon mass concentration, w_C g/g
Gasoline	CH _{1.85} O ₀	0.866
#2 Diesel	CH _{1.80} O ₀	0.869
#1 Diesel	CH _{1.93} O ₀	0.861
Liquified Petroleum Gas	CH _{2.64} O ₀	0.819
Natural gas	CH _{3.78} O _{0.016}	0.747
Ethanol	CH ₃ O _{0.5}	0.521
Methanol	CH ₄ O ₁	0.375

(d) *Calculated raw exhaust molar flow rate from measured intake air molar flow rate or fuel mass flow rate.* You may calculate the raw exhaust molar flow rate from which you sampled emissions, \dot{n}_{exh} , based on the measured intake air molar flow rate, \dot{n}_{int} , or the measured fuel mass flow rate, \dot{m}_{fuel} , and the values calculated using the chemical balance in paragraph (c) of this section. Note that the chemical balance must be based on raw exhaust gas

concentrations. Solve for the chemical balance in paragraph (c) of this section at the same frequency that you update and record \dot{n}_{int} or \dot{m}_{fuel} .

(1) *Crankcase flow rate.* If engines are not subject to crankcase controls under the standard-setting part, you may calculate raw exhaust flow based on \dot{n}_{int} or \dot{m}_{fuel} using one of the following:
(i) You may measure flow rate through the crankcase vent and subtract it from the calculated exhaust flow.

(ii) You may estimate flow rate through the crankcase vent by engineering analysis as long as the uncertainty in your calculation does not adversely affect your ability to show that your engines comply with applicable emission standards.

(iii) You may assume your crankcase vent flow rate is zero.

(2) *Intake air molar flow rate calculation.* Based on \dot{n}_{int} , calculate \dot{n}_{exh} as follows:

$$\dot{n}_{exh} = \frac{\dot{n}_{int}}{\left(1 + \frac{(x_{int/exhdry} - x_{raw/exhdry})}{(1 + x_{H2Oexhdry})}\right)} \quad \text{Eq. 1065.655-18}$$

Where:

\dot{n}_{exh} = raw exhaust molar flow rate from which you measured emissions.
 \dot{n}_{int} = intake air molar flow rate including humidity in intake air.

Example:

\dot{n}_{int} = 3.780 mol/s
 $x_{int/exhdry}$ = 0.69021 mol/mol

$x_{raw/exhdry}$ = 1.10764 mol/mol
 $x_{H2Oexhdry}$ = 107.64 mmol/mol = 0.10764 mol/mol

$$\dot{n}_{exh} = \frac{3.780}{\left(1 + \frac{(0.69021 - 1.10764)}{(1 + 0.10764)}\right)}$$

\dot{n}_{exh} = 6.066 mol/s

(3) *Fuel mass flow rate calculation.* Based on \dot{m}_{fuel} , calculate \dot{n}_{exh} as follows:

$$\dot{n}_{exh} = \frac{\dot{m}_{fuel} \cdot w_C \cdot (1 + x_{H2Oexhdry})}{M_C \cdot x_{Ccombdry}} \quad \text{Eq. 1065.655-19}$$

Where:

\dot{n}_{exh} = raw exhaust molar flow rate from which you measured emissions.
 \dot{m}_{fuel} = fuel flow rate including humidity in intake air.

Example:

\dot{m}_{fuel} = 7.559 g/s
 w_C = 0.869 g/g
 M_C = 12.0107 g/mol
 $x_{Ccombdry}$ = 99.87 mmol/mol = 0.09987 mol/mol
 $x_{H2Oexhdry}$ = 107.64 mmol/mol = 0.10764 mol/mol

$$\dot{n}_{exh} = \frac{7.559 \cdot 0.869 \cdot (1 + 0.10764)}{12.0107 \cdot 0.09987}$$

\dot{n}_{exh} = 6.066 mol/s

■ 117. Section 1065.659 is revised to read as follows:

§ 1065.659 Removed water correction.

(a) If you remove water upstream of a concentration measurement, x , or upstream of a flow measurement, n , correct for the removed water. Perform this correction based on the amount of water at the concentration measurement, $x_{H2O[emission]meas}$, and at

the flow meter, x_{H2Oexh} , whose flow is used to determine the concentration's total mass over a test interval.

(b) When using continuous analyzers downstream of a sample dryer for transient and ramped-modal testing, you must correct for removed water using signals from other continuous analyzers. When using batch analyzers downstream of a sample dryer, you must correct for removed water by using signals either from other batch analyzers or from the flow-weighted average concentrations from continuous analyzers. Downstream of where you removed water, you may determine the

amount of water remaining by any of the following:

(1) Measure the dewpoint and absolute pressure downstream of the water removal location and calculate the amount of water remaining as described in § 1065.645.

(2) When saturated water vapor conditions exist at a given location, you may use the measured temperature at that location as the dewpoint for the downstream flow. If we ask, you must demonstrate how you know that saturated water vapor conditions exist. Use good engineering judgment to measure the temperature at the appropriate location to accurately reflect the dewpoint of the flow. Note that if you use this option and the water

correction in paragraph (d) of this section results in a corrected value that is greater than the measured value, your saturation assumption is invalid and you must determine the water content according to paragraph (b)(1) of this section.

(3) You may also use a nominal value of absolute pressure based on an alarm set point, a pressure regulator set point, or good engineering judgment.

(4) Set $x_{\text{H}_2\text{O}[\text{emission}]_{\text{meas}}}$ equal to that of the measured upstream humidity condition if it is lower than the dryer saturation conditions.

(c) For a corresponding concentration or flow measurement where you did not remove water, you may determine the amount of initial water by any of the following:

(1) Use any of the techniques described in paragraph (b) of this section.

(2) If the measurement comes from raw exhaust, you may determine the amount of water based on intake-air humidity, plus a chemical balance of fuel, intake air and exhaust as described in § 1065.655.

(3) If the measurement comes from diluted exhaust, you may determine the amount of water based on intake-air humidity, dilution air humidity, and a chemical balance of fuel, intake air, and exhaust as described in § 1065.655.

(d) Perform a removed water correction to the concentration measurement using the following equation:

$$x = x_{[\text{emission}]_{\text{meas}}} \cdot \left[\frac{1 - x_{\text{H}_2\text{Oexh}}}{1 - x_{\text{H}_2\text{O}[\text{emission}]_{\text{meas}}}} \right] \quad \text{Eq. 1065.659-1}$$

Example:

$$x_{\text{COmeas}} = 29.0 \text{ } \mu\text{mol/mol}$$

$$x_{\text{H}_2\text{OCOmeas}} = 8.601 \text{ mmol/mol} = 0.008601 \text{ mol/mol}$$

$$x_{\text{H}_2\text{Oexh}} = 34.04 \text{ mmol/mol} = 0.03404 \text{ mol/mol}$$

$$x_{\text{CO}} = 29.0 \cdot \left[\frac{1 - 0.03404}{1 - 0.008601} \right]$$

$$x_{\text{CO}} = 28.3 \text{ } \mu\text{mol/mol}$$

■ 118. Section 1065.660 is revised to read as follows:

§ 1065.660 THC and NMHC determination.

(a) *THC determination and THC/CH₄ initial contamination corrections.* (1) If we require you to determine THC emissions, calculate $x_{\text{THC}[\text{THC-FID}]}$ using the initial THC contamination concentration $x_{\text{THC}[\text{THC-FID}]_{\text{init}}}$ from § 1065.520 as follows:

$$x_{\text{THC}[\text{THC-FID}]_{\text{cor}}} = x_{\text{THC}[\text{THC-FID}]_{\text{uncor}}} - x_{\text{THC}[\text{THC-FID}]_{\text{init}}} \quad \text{Eq. 1065.660-1}$$

Example:

$$x_{\text{THCuncor}} = 150.3 \text{ } \mu\text{mol/mol}$$

$$x_{\text{THCinit}} = 1.1 \text{ } \mu\text{mol/mol}$$

$$x_{\text{THCcor}} = 150.3 - 1.1$$

$$x_{\text{THCcor}} = 149.2 \text{ } \mu\text{mol/mol}$$

(2) For the NMHC determination described in paragraph (b) of this section, correct $x_{\text{THC}[\text{THC-FID}]}$ for initial HC contamination using Eq. 1065.660-1. You may correct for initial

contamination of the CH₄ sample train using Eq. 1065.660-1, substituting in CH₄ concentrations for THC.

(b) *NMHC determination.* Use one of the following to determine NMHC concentration, x_{NMHC} :

(1) If you do not measure CH₄, you may determine NMHC concentrations as described in § 1065.650(c)(1)(vi).

(2) For nonmethane cutters, calculate x_{NMHC} using the nonmethane cutter's

penetration fractions (PF) of CH₄ and C₂H₆ from § 1065.365, and using the HC contamination and wet-to-dry corrected THC concentration $x_{\text{THC}[\text{THC-FID}]_{\text{cor}}}$ as determined in paragraph (a) of this section.

(i) Use the following equation for penetration fractions determined using an NMC configuration as outlined in § 1065.365(d):

$$x_{\text{NMHC}} = \frac{x_{\text{THC}[\text{THC-FID}]_{\text{cor}}} - x_{\text{THC}[\text{NMC-FID}]} \cdot RF_{\text{CH}_4[\text{THC-FID}]}}{1 - RFPF_{\text{C}_2\text{H}_6[\text{NMC-FID}]} \cdot RF_{\text{CH}_4[\text{THC-FID}]}} \quad \text{Eq. 1065.660-2}$$

Where:

x_{NMHC} = concentration of NMHC.

$x_{\text{THC}[\text{THC-FID}]_{\text{cor}}}$ = concentration of THC, HC contamination and dry-to-wet corrected, as measured by the THC FID during sampling while bypassing the NMC.

$x_{\text{THC}[\text{NMC-FID}]}$ = concentration of THC, HC contamination (optional) and dry-to-wet corrected, as measured by the THC FID during sampling through the NMC.

$RF_{\text{CH}_4[\text{THC-FID}]}$ = response factor of THC FID to CH₄, according to § 1065.360(d).

$RFPF_{\text{C}_2\text{H}_6[\text{NMC-FID}]}$ = nonmethane cutter combined ethane response factor and penetration fraction, according to § 1065.365(d).

Example:

$$x_{\text{THC}[\text{THC-FID}]_{\text{cor}}} = 150.3 \text{ } \mu\text{mol/mol}$$

$$x_{\text{THC}[\text{NMC-FID}]} = 20.5 \text{ } \mu\text{mol/mol}$$

$$RFPF_{\text{C}_2\text{H}_6[\text{NMC-FID}]} = 0.019$$

$$RF_{\text{CH}_4[\text{THC-FID}]} = 1.05$$

$$x_{\text{NMHC}} = \frac{150.3 - 20.5 \cdot 1.05}{1 - 0.019 \cdot 1.05}$$

$$x_{\text{NMHC}} = 130.4 \text{ } \mu\text{mol/mol}$$

(ii) For penetration fractions determined using an NMC configuration as outlined in § 1065.365(e), use the following equation:

$$x_{\text{NMHC}} = \frac{x_{\text{THC}[\text{THC-FID}]_{\text{cor}}} \cdot PF_{\text{CH}_4[\text{NMC-FID}]} - x_{\text{THC}[\text{NMC-FID}]}}{PF_{\text{CH}_4[\text{NMC-FID}]} - PF_{\text{C}_2\text{H}_6[\text{NMC-FID}]}} \quad \text{Eq. 1065.660-3}$$

Where:

x_{NMHC} = concentration of NMHC.

$x_{\text{THC}[\text{THC-FID}]_{\text{cor}}}$ = concentration of THC, HC contamination and dry-to-wet corrected, as measured by the THC FID during sampling while bypassing the NMC.

$PF_{\text{CH}_4[\text{NMC-FID}]}$ = nonmethane cutter CH_4 penetration fraction, according to § 1065.365(e).

$x_{\text{THC}[\text{NMC-FID}]}$ = concentration of THC, HC contamination (optional) and dry-to-wet

corrected, as measured by the THC FID during sampling through the NMC.

$PF_{\text{C}_2\text{H}_6[\text{NMC-FID}]}$ = nonmethane cutter ethane penetration fraction, according to § 1065.365(e).

Example:

$x_{\text{THC}[\text{THC-FID}]_{\text{cor}}} = 150.3 \mu\text{mol/mol}$

$PF_{\text{CH}_4[\text{NMC-FID}]} = 0.990$

$x_{\text{THC}[\text{NMC-FID}]} = 20.5 \mu\text{mol/mol}$

$PF_{\text{C}_2\text{H}_6[\text{NMC-FID}]} = 0.020$

$$x_{\text{NMHC}} = \frac{150.3 \cdot 0.990 - 20.5}{0.990 - 0.020}$$

$x_{\text{NMHC}} = 132.3 \mu\text{mol/mol}$

(iii) For penetration fractions determined using an NMC configuration as outlined in § 1065.365(f), use the following equation:

$$x_{\text{NMHC}} = \frac{x_{\text{THC}[\text{THC-FID}]_{\text{cor}}} \cdot PF_{\text{CH}_4[\text{NMC-FID}]} - x_{\text{THC}[\text{NMC-FID}]} \cdot RF_{\text{CH}_4[\text{THC-FID}]}}{PF_{\text{CH}_4[\text{NMC-FID}]} - RFPF_{\text{C}_2\text{H}_6[\text{NMC-FID}]} \cdot RF_{\text{CH}_4[\text{THC-FID}]}} \quad \text{Eq. 1065.660-4}$$

Where:

x_{NMHC} = concentration of NMHC.

$x_{\text{THC}[\text{THC-FID}]_{\text{cor}}}$ = concentration of THC, HC contamination and dry-to-wet corrected, as measured by the THC FID during sampling while bypassing the NMC.

$PF_{\text{CH}_4[\text{NMC-FID}]}$ = nonmethane cutter CH_4 penetration fraction, according to § 1065.365(f).

$x_{\text{THC}[\text{NMC-FID}]}$ = concentration of THC, HC contamination (optional) and dry-to-wet corrected, as measured by the THC FID during sampling through the NMC.

$RFPF_{\text{C}_2\text{H}_6[\text{NMC-FID}]}$ = nonmethane cutter CH_4 combined ethane response factor and penetration fraction, according to § 1065.365(f).

$RF_{\text{CH}_4[\text{THC-FID}]}$ = response factor of THC FID to CH_4 , according to § 1065.360(d).

Example:

$x_{\text{THC}[\text{THC-FID}]_{\text{cor}}} = 150.3 \mu\text{mol/mol}$

$PF_{\text{CH}_4[\text{NMC-FID}]} = 0.990$

$x_{\text{THC}[\text{NMC-FID}]} = 20.5 \mu\text{mol/mol}$

$RFPF_{\text{C}_2\text{H}_6[\text{NMC-FID}]} = 0.019$

$RF_{\text{CH}_4[\text{THC-FID}]} = 0.980$

$$x_{\text{NMHC}} = \frac{150.3 \cdot 0.990 - 20.5 \cdot 0.980}{0.990 - 0.019 \cdot 0.980}$$

$x_{\text{NMHC}} = 132.5 \mu\text{mol/mol}$

(3) For a gas chromatograph, calculate x_{NMHC} using the THC analyzer's response factor (RF) for CH_4 , from § 1065.360, and the HC contamination and wet-to-dry corrected initial THC concentration $x_{\text{THC}[\text{THC-FID}]_{\text{cor}}}$ as determined in section (a) above as follows:

$$x_{\text{NMHC}} = x_{\text{THC}[\text{THC-FID}]_{\text{cor}}} - RF_{\text{CH}_4[\text{THC-FID}]} \cdot x_{\text{CH}_4} \quad \text{Eq. 1065.660-5}$$

Where:

x_{NMHC} = concentration of NMHC.

$x_{\text{THC}[\text{THC-FID}]_{\text{cor}}}$ = concentration of THC, HC contamination and dry-to-wet corrected, as measured by the THC FID.

x_{CH_4} = concentration of CH_4 , HC contamination (optional) and dry-to-wet corrected, as measured by the gas chromatograph FID.

$RF_{\text{CH}_4[\text{THC-FID}]}$ = response factor of THC-FID to CH_4 .

Example:

$x_{\text{THC}[\text{THC-FID}]_{\text{cor}}} = 145.6 \mu\text{mol/mol}$

$RF_{\text{CH}_4[\text{THC-FID}]} = 0.970$

$x_{\text{CH}_4} = 18.9 \mu\text{mol/mol}$

$x_{\text{NMHC}} = 145.6 - 0.970 \cdot 18.9$

$x_{\text{NMHC}} = 127.3 \mu\text{mol/mol}$

■ 119. Section 1065.665 is revised to read as follows:

§ 1065.665 THCE and NMHCE determination.

(a) If you measured an oxygenated hydrocarbon's mass concentration, first calculate its molar concentration in the exhaust sample stream from which the

sample was taken (raw or diluted exhaust), and convert this into a C_1 -equivalent molar concentration. Add these C_1 -equivalent molar concentrations to the molar concentration of NOTHC. The result is the molar concentration of THCE. Calculate THCE concentration using the following equations, noting that equation 1065.665-3 is only required if you need to convert your OHC concentration from mass to moles:

$$x_{\text{THCE}} = x_{\text{NOTHC}} + \sum_{i=1}^N (x_{\text{OHC}_i} - x_{\text{OHC}_i\text{-init}}) \quad \text{Eq. 1065.665-1}$$

$$x_{\text{NOTHC}} = x_{\text{THC}[\text{THC-FID}]_{\text{cor}}} - \sum_{i=1}^N (x_{\text{OHC}_i} \cdot RF_{\text{OHC}_i[\text{THC-FID}]}) \quad \text{Eq. 1065.665-2}$$

$$x_{\text{OHC}i} = \frac{\frac{m_{\text{dexhOHC}i}}{M_{\text{OHC}i}}}{\frac{m_{\text{dexh}}}{M_{\text{dexh}}}} = \frac{n_{\text{dexhOHC}i}}{n_{\text{dexh}}} \quad \text{Eq. 1065.665-3}$$

Where:

x_{THCE} = The C₁-equivalent sum of the concentration of carbon mass contributions of non-oxygenated hydrocarbons, alcohols, and aldehydes.
 x_{NOTHC} = The C₁-equivalent sum of the concentration of nonoxygenated THC.
 $x_{\text{OHC}i}$ = The C₁-equivalent concentration of oxygenated species *i* in diluted exhaust, not corrected for initial contamination.
 $x_{\text{OHC}i\text{-init}}$ = The C₁-equivalent concentration of the initial system contamination

(optional) of oxygenated species *i*, dry-to-wet corrected.

$x_{\text{THC}[\text{THC-FID}]_{\text{cor}}}$ = The C₁-equivalent response to NOTHC and all OHC in diluted exhaust, HC contamination and dry-to-wet corrected, as measured by the THC-FID.

$RF_{\text{OHC}i[\text{THC-FID}]}$ = The response factor of the FID to species *i* relative to propane on a C₁-equivalent basis.

$C^{\#}$ = The mean number of carbon atoms in the particular compound.

M_{dexh} = The molar mass of diluted exhaust as determined in § 1065.340.

$m_{\text{dexhOHC}i}$ = The mass of oxygenated species *i* in dilute exhaust.

$M_{\text{OHC}i}$ = The C₁-equivalent molecular weight of oxygenated species *i*.

m_{dexh} = The mass of diluted exhaust.

$n_{\text{dexhOHC}i}$ = The number of moles of oxygenated species *i* in total diluted exhaust flow.

n_{dexh} = The total diluted exhaust flow.

(b) If we require you to determine NMHCE, use the following equation:

$$x_{\text{NMHCE}} = x_{\text{THCE}} - RF_{\text{CH}_4[\text{THC-FID}]} \cdot x_{\text{CH}_4} \quad \text{Eq. 1065.665-4}$$

Where:

x_{NMHCE} = The C₁-equivalent sum of the concentration of carbon mass contributions of non-oxygenated NMHC, alcohols, and aldehydes.

$RF_{\text{CH}_4[\text{THC-FID}]}$ = response factor of THC-FID to CH₄.

x_{CH_4} = concentration of CH₄, HC contamination (optional) and dry-to-wet corrected, as measured by the gas chromatograph FID.

(c) The following example shows how to determine NMHCE emissions based on ethanol (C₂H₅OH), methanol (CH₃OH), acetaldehyde (C₂H₄O), and formaldehyde (HCHO) as C₁-equivalent molar concentrations:

$x_{\text{THC}[\text{THC-FID}]_{\text{cor}}} = 145.6 \mu\text{mol/mol}$

$x_{\text{CH}_4} = 18.9 \mu\text{mol/mol}$

$x_{\text{C}_2\text{H}_5\text{OH}} = 100.8 \mu\text{mol/mol}$

$x_{\text{CH}_3\text{OH}} = 1.1 \mu\text{mol/mol}$

$x_{\text{C}_2\text{H}_4\text{O}} = 19.1 \mu\text{mol/mol}$

$x_{\text{HCHO}} = 1.3 \mu\text{mol/mol}$

$RF_{\text{CH}_4[\text{THC-FID}]} = 1.07$

$RF_{\text{C}_2\text{H}_5\text{OH}[\text{THC-FID}]} = 0.76$

$RF_{\text{CH}_3\text{OH}[\text{THC-FID}]} = 0.74$

$RF_{\text{H}_2\text{H}_4\text{O}[\text{THC-FID}]} = 0.50$

$RF_{\text{HCHO}[\text{THC-FID}]} = 0.0$

$x_{\text{NMHCE}} = x_{\text{THC}[\text{THC-FID}]_{\text{cor}}} - (x_{\text{C}_2\text{H}_5\text{OH}} \cdot$

$RF_{\text{C}_2\text{H}_5\text{OH}[\text{THC-FID}]} + x_{\text{CH}_3\text{OH}} \cdot$

$RF_{\text{CH}_3\text{OH}[\text{THC-FID}]} + x_{\text{C}_2\text{H}_4\text{O}} \cdot$

$RF_{\text{C}_2\text{H}_4\text{O}[\text{THC-FID}]} + x_{\text{HCHO}} \cdot$

$RF_{\text{HCHO}[\text{THC-FID}]} + x_{\text{C}_2\text{H}_5\text{OH}} + x_{\text{CH}_3\text{OH}}$

$+ x_{\text{C}_2\text{H}_4\text{O}} + x_{\text{HCHO}} - (RF_{\text{CH}_4[\text{THC-FID}]} \cdot$

$x_{\text{CH}_4})$

$x_{\text{NMHCE}} = 145.6 - (100.8 \cdot 0.76 + 1.1 \cdot$

$0.74 + 19.1 \cdot 0.50 + 1.3 \cdot 0) + 100.8$

$+ 1.1 + 19.1 + 1.3 - (1.07 \cdot 18.9)$

$x_{\text{NMHCE}} = 160.71 \mu\text{mol/mol}$

■ 120. Section 1065.667 is amended by revising paragraph (b) to read as follows:

§ 1065.667 Dilution air background emission correction.

* * * * *

(b) You may determine the total flow of dilution air by a direct flow measurement. In this case, calculate the total mass of background as described in § 1065.650(b), using the dilution air flow, n_{dil} . Subtract the background mass from the total mass. Use the result in brake-specific emission calculations.

* * * * *

■ 121. Section 1065.670 is amended by revising the introductory text to read as follows:

§ 1065.670 NO_x intake-air humidity and temperature corrections.

See the standard-setting part to determine if you may correct NO_x emissions for the effects of intake-air humidity or temperature. Use the NO_x intake-air humidity and temperature corrections specified in the standard-setting part instead of the NO_x intake-air humidity correction specified in this part 1065. If the standard-setting part does not prohibit correcting NO_x emissions for intake-air humidity according to this part 1065, first apply any NO_x corrections for background emissions and water removal from the

exhaust sample, then correct NO_x concentrations for intake-air humidity. You may use a time-weighted mean combustion air humidity to calculate this correction if your combustion air humidity remains within a tolerance of ± 0.0025 mol/mol of the mean value over the test interval. For intake-air humidity correction, use one of the following approaches:

* * * * *

■ 122. Section 1065.675 is revised to read as follows:

§ 1065.675 CLD quench verification calculations.

Perform CLD quench-check calculations as follows:

(a) Calculate the amount of water in the span gas, $x_{\text{H}_2\text{Ospan}}$, assuming complete saturation at the span-gas temperature.

(b) Estimate the expected amount of water and CO₂ in the exhaust you sample, $x_{\text{H}_2\text{Oexp}}$ and $x_{\text{CO}_2\text{exp}}$, respectively, by considering the maximum expected amounts of water in combustion air, fuel combustion products, and dilution air concentrations (if applicable).

(c) Set $x_{\text{H}_2\text{Oexp}}$ equal to $x_{\text{H}_2\text{Omeas}}$ if you are using a sample dryer that passes the sample dryer verification check in § 1065.342.

(d) Calculate water quench as follows:

$$quench = \left(\frac{\frac{x_{NOwet}}{1 - x_{H2Omeas}}}{x_{NOdry}} - 1 \right) \cdot \frac{x_{H2Oexp}}{x_{H2Omeas}} + \frac{x_{NO,CO2} - x_{NO,N2}}{x_{NO,N2}} \cdot \frac{x_{CO2exp}}{x_{CO2meas}} \quad \text{Eq. 1065.675-1}$$

Where:

quench = amount of CLD quench.

x_{NOdry} = measured concentration of NO upstream of a bubbler, according to § 1065.370.

x_{NOwet} = measured concentration of NO downstream of a bubbler, according to § 1065.370.

x_{H2Oexp} = expected maximum amount of water entering the CLD sample port during emission testing.

$x_{H2Omeas}$ = measured amount of water entering the CLD sample port during the quench verification specified in § 1065.370.

$x_{NO,CO2}$ = measured concentration of NO when NO span gas is blended with CO₂ span gas, according to § 1065.370.

$x_{NO,N2}$ = measured concentration of NO when NO span gas is blended with N₂ span gas, according to § 1065.370.

x_{CO2exp} = expected maximum amount of CO₂ entering the CLD sample port during emission testing.

$x_{CO2meas}$ = measured amount of CO₂ entering the CLD sample port during the quench verification specified in § 1065.370.

Example:

x_{NOdry} = 1800.0 μmol/mol

x_{NOwet} = 1760.5 μmol/mol

x_{H2Oexp} = 0.030 mol/mol

$x_{H2Omeas}$ = 0.017 mol/mol

$x_{NO,CO2}$ = 1480.2 μmol/mol

$x_{NO,N2}$ = 1500.8 μmol/mol

x_{CO2exp} = 2.00%

$x_{CO2meas}$ = 3.00%

$$quench = \left(\frac{\frac{1760.5}{1 - 0.017}}{1800.0} - 1 \right) \cdot \frac{0.030}{0.017} + \frac{1480.2 - 1500.8}{1500.8} \cdot \frac{2.00}{3.00}$$

$quench = -0.00888 - 0.00915 = -1.80\%$

■ 123. Section 1065.690 is amended by revising paragraph (e) to read as follows:

§ 1065.690 Buoyancy correction for PM sample media.

* * * * *

(e) *Correction calculation.* Correct the PM sample media for buoyancy using the following equations:

$$m_{cor} = m_{uncor} \cdot \left[\frac{1 - \frac{\rho_{air}}{\rho_{weight}}}{1 - \frac{\rho_{air}}{\rho_{media}}} \right] \quad \text{Eq. 1065.690-1}$$

Where:

m_{cor} = PM mass corrected for buoyancy.

m_{uncor} = PM mass uncorrected for buoyancy.

ρ_{air} = density of air in balance environment.

ρ_{weight} = density of calibration weight used to span balance.

ρ_{media} = density of PM sample media, such as a filter.

M_{mix} = 28.83563 g/mol
 R = 8.314472 J/(mol · K)
 T_{amb} = 20 °C

$$\rho_{air} = \frac{99.980 \cdot 28.83563}{8.314472 \cdot 293.15}$$

ρ_{air} = 1.18282 kg/m³
 m_{uncorr} = 100.0000 mg
 ρ_{weight} = 8000 kg/m³
 ρ_{media} = 920 kg/m³

$$\rho_{air} = \frac{p_{abs} \cdot M_{mix}}{R \cdot T_{amb}} \quad \text{Eq. 1065.690-2}$$

Where:

p_{abs} = absolute pressure in balance environment.

M_{mix} = molar mass of air in balance environment.

R = molar gas constant.

T_{amb} = absolute ambient temperature of balance environment.

Example:

p_{abs} = 99.980 kPa

$T_{sat} = T_{dew} = 9.5$ °C

Using Eq. 1065.645–2,

$p_{H2O} = 1.1866$ kPa

Using Eq. 1065.645–3,

$x_{H2O} = 0.011868$ mol/mol

Using Eq. 1065.640–9,

$$m_{cor} = 100.0000 \cdot \left[\frac{1 - \frac{1.18282}{8000}}{1 - \frac{1.18282}{920}} \right]$$

m_{cor} 100.1139 mg

■ 124. Section 1065.695 is amended by revising paragraph (c)(7)(ix) to read as follows:

§ 1065.695 Data requirements.

* * * * *

(c) * * *

(7) * * *

(ix) Warm-idle speed value.

* * * * *

Subpart H—[Amended]

■ 125. Section 1065.701 is amended by revising paragraphs (b), (c), and (e) to read as follows:

§ 1065.701 General requirements for test fuels.

* * * * *

(b) *Fuels meeting alternate specifications.* We may allow you to use a different test fuel (such as California Phase 2 gasoline) if it does not affect your ability to show that your engines would comply with all applicable emission standards using the fuel specified in this subpart.

(c) *Fuels not specified in this subpart.* If you produce engines that run on a type of fuel (or mixture of fuels) that we do not specify in this subpart, you must get our written approval to establish the appropriate test fuel. See the standard-setting part for provisions related to

fuels and fuel mixtures not specified in this subpart.

(1) For engines designed to operate on a single fuel, we will generally allow you to use the fuel if you show us all the following things are true:

(i) Show that your engines will use only the designated fuel in service.

(ii) Show that this type of fuel is commercially available.

(iii) Show that operating the engines on the fuel we specify would be inappropriate, as in the following examples:

(A) The engine will not run on the specified fuel.

(B) The engine or emission controls will not be durable or work properly when operating with the specified fuel.

(C) The measured emission results would otherwise be substantially unrepresentative of in-use emissions.

(2) For engines that are designed to operate on different fuel types, the provisions of paragraphs (c)(1)(ii) and (iii) of this section apply with respect to each fuel type.

(3) For engines that are designed to operate on different fuel types as well as

continuous mixtures of those fuels, we may require you to test with either the worst-case fuel mixture or the most representative fuel mixture, unless the standard-setting part specifies otherwise.

* * * * *

(e) *Service accumulation and field testing fuels.* If we do not specify a service-accumulation or field-testing fuel in the standard-setting part, use an appropriate commercially available fuel such as those meeting minimum specifications from the following table:

TABLE 1 OF § 1065.701.—EXAMPLES OF SERVICE-ACCUMULATION AND FIELD-TESTING FUELS

Fuel category	Subcategory	Reference procedure ¹
Diesel	Light distillate and light blends with residual	ASTM D975–07b.
	Middle distillate	ASTM D6751–07b.
	Biodiesel (B100)	ASTM D6985–04a.
Intermediate and residual fuel	All	See § 1065.705.
Gasoline	Motor vehicle gasoline	ASTM D4814–07a.
	Minor oxygenated gasoline blends	ASTM D4814–07a.
	Ethanol (Ed75–85)	ASTM D5798–07.
Alcohol	Methanol (M70–M85)	ASTM D5797–07.
	Aviation gasoline	ASTM D910–07.
Aviation fuel	Gas turbine	ASTM D1655–07e01.
	Jet B wide cut	ASTM D6615–06.
	General	ASTM D2880–03.

¹ ASTM specifications are incorporated by reference in § 1065.1010.

■ 126. Section 1065.703 is amended by revising Table 1 to read as follows:

§ 1065.703 Distillate diesel fuel.

* * * * *

TABLE 1 OF § 1065.703.—TEST FUEL SPECIFICATIONS FOR DISTILLATE DIESEL FUEL

Item	Units	Ultra low sulfur	Low sulfur	High sulfur	Reference procedure ¹
Cetane Number		40–50	40–50	40–50	ASTM D613–05.
Distillation range	°C				
Initial boiling point		171–204	171–204	171–204	ASTM D86–07a.
10 pct. point		204–238	204–238	204–238	
50 pct. point		243–282	243–282	243–282	
90 pct. point		293–332	293–332	293–332	
Endpoint		321–366	321–366	321–366	
Gravity	° API	32–37	32–37	32–37	ASTM D4052–96e01.
Total sulfur	mg/kg	7–15	300–500	2000–4000	ASTM D2622–07.
Aromatics, min. (Remainder shall be paraffins, naphthalenes, and olefins).	g/kg	100	100	100	ASTM D5186–03.
Flashpoint, min.	°C	54	54	54	ASTM D93–07.
Kinematic Viscosity	cSt	2.0–3.2	2.0–3.2	2.0–3.2	ASTM D445–06.

¹ ASTM procedures are incorporated by reference in § 1065.1010. See § 1065.701(d) for other allowed procedures.

■ 127. A new § 1065.705 is added to read as follows:

§ 1065.705 Residual and intermediate residual fuel.

This section describes the specifications for fuels meeting the

definition of residual fuel in 40 CFR 80.2, including fuels marketed as intermediate fuel. Residual fuels for service accumulation and any testing must meet the following specifications:

(a) The fuel must be a commercially available fuel that is representative of

the fuel that will be used by the engine in actual use.

(b) The fuel must meet the specifications for one of the categories in the following table:

TABLE 1 OF § 1065.705.—SERVICE ACCUMULATION AND TEST FUEL SPECIFICATIONS FOR RESIDUAL FUEL

Characteristic	Unit	Category ISO-F-										Test method reference ¹	
		RMA 30	RMB 30	RMD 80	RME 180	RMF 180	RMG 380	RMH 380	RMK 380	RMH 700	RMK 700		
Density at 15 °C, max.	kg/m ³	960.0	975.0	980.0	991.0		991.0		1010.0	991.0	1010.0	ISO 3675 or ISO 12185:1998/Cor 1:2001 (see also ISO 8217:2005(E) 7.1).	
Kinematic viscosity at 50 °C, max.	cSt	30.0		80.0	180.0		380.0		700.0			ISO 3104:1994/Cor 1:1997.	
Flash point, min	°C	60	60	60	60		60		60			ISO 2719 (see also ISO 8217:2005(E) 7.2).	
Pour point (upper):													
Winter quality, max.	°C	0	24	30	30		30		30			ISO 3016.	
Summer quality, max.	6	24	30	30		30		30			ISO 3016.	
Carbon residue, max.	(kg/kg)%	10		14	15	20	18	22	22			ISO 10370:1993/Cor 1:1996.	
Ash, max.	(kg/kg)%	0.10		0.10	0.10	0.15	0.15		0.15			ISO 6245.	
Water, max	(m ³ /m ³)%	0.5		0.5	0.5		0.5		0.5			ISO 3733.	
Sulfur, max	(kg/kg)%	3.50		4.00	4.50		4.50		4.50			ISO 8754 or ISO 14596:1998/Cor 1:1999 (see also ISO 8217:2005(E) 7.3).	
Vanadium, max	mg/kg	150		350	200	500	300	600	600			ISO 14597 or IP 501 or IP 470 (see also ISO 8217:2005(E) 7.8).	
Total sediment potential, max.	(kg/kg)%	0.10		0.10	0.10		0.10		0.10			ISO 10307-2 (see also ISO 8217:2005(E) 7.6).	
Aluminium plus silicon, max.	mg/kg	80		80	80		80		80			ISO 10478 or IP 501 or IP 470 (see also ISO 8217:2005(E) 7.9).	
Used lubricating oil (ULO), max.	Fuel shall be free of ULO. We consider a fuel to be free of ULO if one or more of the elements zinc, phosphorus, or calcium is at or below the specified limits. We consider a fuel to contain ULO if all three elements exceed the specified limits.										IP 501 or IP 470 (see ISO 8217:2005(E) 7.7). IP 501 or IP 500 (see ISO 8217:2005(E) 7.7). IP 501 or IP 470 (see ISO 8217:2005(E) 7.7).	
Zinc	mg/kg												15
Phosphorus												15
Calcium												30

¹ ISO procedures are incorporated by reference in § 1065.1010. See § 1065.701(d) for other allowed procedures.

■ 128. Section 1065.710 is amended by **§ 1065.710 Gasoline.**
revising Table 1 to read as follows: * * * * *

TABLE 1 OF § 1065.710.—TEST FUEL SPECIFICATIONS FOR GASOLINE

Item	Units	General testing	Low-temperature testing	Reference procedure ¹
Distillation Range:				
Initial boiling point	°C	24–35 ²	24–36.	ASTM D86–07a.
10% point	°C	49–57	37–48	
50% point	°C	93–110	82–101.	
90% point	°C	149–163	158–174.	
End point	°C	Maximum, 213	Maximum, 212.	
Hydrocarbon composition:				
Olefins	m ³ /m ³	Maximum, 0.10	Maximum, 0.175	ASTM D1319–03.
Aromatics	Maximum, 0.35	Maximum, 0.304.	
Saturates	Remainder	Remainder.	
Lead (organic)	g/liter	Maximum, 0.013	Maximum, 0.013	ASTM D3237–06e01.
Phosphorous	g/liter	Maximum, 0.0013	Maximum, 0.005	ASTM D3231–07.
Total sulfur	mg/kg	Maximum, 80	Maximum, 80	ASTM D2622–07.

TABLE 1 OF § 1065.710.—TEST FUEL SPECIFICATIONS FOR GASOLINE

Item	Units	General testing	Low-temperature testing	Reference procedure ¹
Volatility (Reid Vapor Pressure)	kPa	60.0–63.4 ^{2,3}	77.2–81.4	ASTM D5191–07.

¹ ASTM procedures are incorporated by reference in § 1065.1010. See § 1065.701(d) for other allowed procedures.
² For testing at altitudes above 1,219 m, the specified volatility range is (52.0 to 55.2) kPa and the specified initial boiling point range is (23.9 to 40.6) °C.
³ For testing unrelated to evaporative emissions, the specified range is (55.2 to 63.4) kPa.

■ 129. Section 1065.715 is revised to read as follows:

§ 1065.715 Natural gas.

- (a) Except as specified in paragraph (b) of this section, natural gas for testing

must meet the specifications in the following table:

TABLE 1 OF § 1065.715.—TEST FUEL SPECIFICATIONS FOR NATURAL GAS

Item	Value ¹
Methane, CH ₄	Minimum, 0.87 mol/mol.
Ethane, C ₂ H ₆	Maximum, 0.055 mol/mol.
Propane, C ₃ H ₈	Maximum, 0.012 mol/mol.
Butane, C ₄ H ₁₀	Maximum, 0.0035 mol/mol.
Pentane, C ₅ H ₁₂	Maximum, 0.0013 mol/mol.
C ₆ and higher	Maximum, 0.001 mol/mol.
Oxygen	Maximum, 0.001 mol/mol.
Inert gases (sum of CO ₂ and N ₂)	Maximum, 0.051 mol/mol.

¹ All parameters are based on the reference procedures in ASTM D1945–03 (incorporated by reference in § 1065.1010). See § 1065.701(d) for other allowed procedures.

(b) In certain cases you may use test fuel not meeting the specifications in paragraph (a) of this section, as follows:

(1) You may use fuel that your in-use engines normally use, such as pipeline natural gas.

(2) You may use fuel meeting alternate specifications if the standard-setting part allows it.

(3) You may ask for approval to use fuel that does not meet the

specifications in paragraph (a) of this section, but only if using the fuel would not adversely affect your ability to demonstrate compliance with the applicable standards.

(c) When we conduct testing using natural gas, we will use fuel that meets the specifications in paragraph (a) of this section.

(d) At ambient conditions, natural gas must have a distinctive odor detectable

down to a concentration in air not more than one-fifth the lower flammable limit.

■ 130. Section 1065.720 is revised to read as follows:

§ 1065.720 Liquefied petroleum gas.

- (a) Except as specified in paragraph (b) of this section, liquefied petroleum gas for testing must meet the specifications in the following table:

TABLE 1 OF § 1065.720.—TEST FUEL SPECIFICATIONS FOR LIQUEFIED PETROLEUM GAS

Item	Value	Reference procedure ¹
Propane, C ₃ H ₈	Minimum, 0.85 m ³ /m ³	ASTM D2163–05.
Vapor pressure at 38 °C	Maximum, 1400 kPa	ASTM D1267–02 or 2598–02 ² .
Volatility residue (evaporated temperature, 35 °C)	Maximum, –38 °C	ASTM D1837–02a.
Butanes	Maximum, 0.05 m ³ /m ³	ASTM D2163–05.
Butenes	Maximum, 0.02 m ³ /m ³	ASTM D2163–05.
Pentenes and heavier	Maximum, 0.005 m ³ /m ³	ASTM D2163–05.
Propene	Maximum, 0.1 m ³ /m ³	ASTM D2163–05.
Residual matter (residue on evap. of 100 ml oil stain observ.)	Maximum, 0.05 ml pass ³	ASTM D2158–05.
Corrosion, copper strip	Maximum, No. 1	ASTM D1838–07.
Sulfur	Maximum, 80 mg/kg	ASTM D2784–06.
Moisture content	pass	ASTM D2713–91.

¹ ASTM procedures are incorporated by reference in § 1065.1010. See § 1065.701(d) for other allowed procedures.
² If these two test methods yield different results, use the results from ASTM D1267–02.
³ The test fuel must not yield a persistent oil ring when you add 0.3 ml of solvent residue mixture to a filter paper in 0.1 ml increments and examine it in daylight after two minutes.

(b) In certain cases you may use test fuel not meeting the specifications in paragraph (a) of this section, as follows:

(1) You may use fuel that your in-use engines normally use, such as commercial-quality liquefied petroleum gas.

(2) You may use fuel meeting alternate specifications if the standard-setting part allows it.

(3) You may ask for approval to use fuel that does not meet the specifications in paragraph (a) of this section, but only if using the fuel would

not adversely affect your ability to demonstrate compliance with the applicable standards.

(c) When we conduct testing using liquefied petroleum gas, we will use fuel that meets the specifications in paragraph (a) of this section.

(d) At ambient conditions, liquefied petroleum gas must have a distinctive odor detectable down to a concentration in air not more than one-fifth the lower flammable limit.

■ 131. Section 1065.750 is amended by revising paragraph (a) to read as follows:

§ 1065.750 Analytical Gases.

* * * * *

(a) Subparts C, D, F, and J of this part refer to the following gas specifications:

(1) Use purified gases to zero measurement instruments and to blend with calibration gases. Use gases with contamination no higher than the highest of the following values in the gas cylinder or at the outlet of a zero-gas generator:

(i) 2% contamination, measured relative to the flow-weighted mean

concentration expected at the standard. For example, if you would expect a flow-weighted CO concentration of 100.0 μmol/mol, then you would be allowed to use a zero gas with CO contamination less than or equal to 2.000 μmol/mol.

(ii) Contamination as specified in the following table:

TABLE 1 OF § 1065.750.—GENERAL SPECIFICATIONS FOR PURIFIED GASES

Constituent	Purified synthetic air ¹	Purified N ₂ ¹
THC (C ₁ equivalent)	< 0.05 μmol/mol	< 0.05 μmol/mol.
CO	< 1 μmol/mol	< 1 μmol/mol.
CO ₂	< 10 μmol/mol	< 10 μmol/mol.
O ₂	0.205 to 0.215 mol/mol	< 2 μmol/mol.
NO _x	< 0.02 μmol/mol	< 0.02 μmol/mol.

¹ We do not require these levels of purity to be NIST-traceable.

(2) Use the following gases with a FID analyzer:

(i) *FID fuel*. Use FID fuel with a stated H₂ concentration of (0.39 to 0.41) mol/mol, balance He, and a stated total hydrocarbon concentration of 0.05 μmol/mol or less.

(ii) *FID burner air*. Use FID burner air that meets the specifications of purified air in paragraph (a)(1) of this section. For field testing, you may use ambient air.

(iii) *FID zero gas*. Zero flame-ionization detectors with purified gas that meets the specifications in paragraph (a)(1) of this section, except that the purified gas O₂ concentration may be any value. Note that FID zero balance gases may be any combination of purified air and purified nitrogen. We recommend FID analyzer zero gases that contain approximately the expected flow-weighted mean concentration of O₂ in the exhaust sample during testing.

(iv) *FID propane span gas*. Span and calibrate THC FID with span concentrations of propane, C₃H₈. Calibrate on a carbon number basis of one (C₁). For example, if you use a C₃H₈ span gas of concentration 200 μmol/mol, span a FID to respond with a value of 600 μmol/mol. Note that FID span balance gases may be any combination of purified air and purified nitrogen. We recommend FID analyzer span gases that contain approximately the flow-weighted mean concentration of O₂ expected during testing. If the expected O₂ concentration in the exhaust sample is zero, we recommend using a balance gas of purified nitrogen.

(v) *FID methane span gas*. If you always span and calibrate a CH₄ FID with a nonmethane cutter, then span and calibrate the FID with span concentrations of methane, CH₄.

Calibrate on a carbon number basis of one (C₁). For example, if you use a CH₄ span gas of concentration 200 μmol/mol, span a FID to respond with a value of 200 μmol/mol. Note that FID span balance gases may be any combination of purified air and purified nitrogen. We recommend FID analyzer span gases that contain approximately the expected flow-weighted mean concentration of O₂ in the exhaust sample during testing. If the expected O₂ concentration in the exhaust sample is zero, we recommend using a balance gas of purified nitrogen.

(3) Use the following gas mixtures, with gases traceable within ± 1.0% of the NIST-accepted value or other gas standards we approve:

(i) CH₄, balance purified synthetic air and/or N₂ (as applicable).

(ii) C₂H₆, balance purified synthetic air and/or N₂ (as applicable).

(iii) C₃H₈, balance purified synthetic air and/or N₂ (as applicable).

(iv) CO, balance purified N₂.

(v) CO₂, balance purified N₂.

(vi) NO, balance purified N₂.

(vii) NO₂, balance purified synthetic air.

(viii) O₂, balance purified N₂.

(ix) C₃H₈, CO, CO₂, NO, balance purified N₂.

(x) C₃H₈, CH₄, CO, CO₂, NO, balance purified N₂.

(4) You may use gases for species other than those listed in paragraph (a)(3) of this section (such as methanol in air, which you may use to determine response factors), as long as they are traceable to within ± 3.0% of the NIST-accepted value or other similar standards we approve, and meet the stability requirements of paragraph (b) of this section.

(5) You may generate your own calibration gases using a precision

blending device, such as a gas divider, to dilute gases with purified N₂ or purified synthetic air. If your gas dividers meet the specifications in § 1065.248, and the gases being blended meet the requirements of paragraphs (a)(1) and (3) of this section, the resulting blends are considered to meet the requirements of this paragraph (a).

* * * * *

Subpart I—[Amended]

■ 132. Section 1065.805 is amended by revising paragraphs (a), (b), and (c) to read as follows:

§ 1065.805 Sampling system.

(a) Dilute engine exhaust, and use batch sampling to collect proportional flow-weighted dilute samples of the applicable alcohols and carbonyls. You may not use raw sampling for alcohols and carbonyls.

(b) You may collect background samples for correcting dilution air for background concentrations of alcohols and carbonyls.

(c) Maintain sample temperatures within the dilution tunnel, probes, and sample lines high enough to prevent aqueous condensation up to the point where a sample is collected to prevent loss of the alcohols and carbonyls by dissolution in condensed water. Use good engineering judgment to ensure that surface reactions of alcohols and carbonyls do not occur, as surface decomposition of methanol has been shown to occur at temperatures greater than 120 °C in exhaust from methanol-fueled engines.

* * * * *

■ 133. Section 1065.845 is amended by revising the introductory text to read as follows:

§ 1065.845 Response factor determination.

Since FID analyzers generally have an incomplete response to alcohols and carbonyls, determine each FID analyzer's alcohol/carbonyl response factor (such as RF_{MeOH}) after FID optimization to subtract those responses from the FID reading. You are not required to determine the response factor for a compound unless you will subtract its response to compensate for a response. Formaldehyde response is assumed to be zero and does not need to be determined. Use the most recent alcohol/carbonyl response factors to compensate for alcohol/carbonyl response.

* * * *

Subpart J—[Amended]

■ 134. Section 1065.901 is amended by revising paragraphs (b) introductory text and (b)(2) to read as follows:

§ 1065.901 Applicability.

* * * *

(b) *Laboratory testing.* You may use PEMS for any testing in a laboratory or similar environment without restriction or prior approval if the PEMS meets all applicable specifications for laboratory testing. You may also use PEMS for any testing in a laboratory or similar environment if we approve it in advance, subject to the following provisions: * * *

(2) Do not apply any PEMS-related field-testing adjustments or measurement allowances to laboratory emission results or standards.

* * * *

■ 135. Section 1065.905 is amended by revising paragraphs (c)(14) and (e) introductory text to read as follows:

§ 1065.905 General provisions.

* * * *

(c) * * *

(14) Does any special measurement allowance apply to field-test emission results or standards, based on using PEMS for field-testing versus using laboratory equipment and instruments for laboratory testing?

* * * *

(e) *Laboratory testing using PEMS.* You may use PEMS for testing in a laboratory as described in § 1065.901(b). Use the following procedures and specifications when using PEMS for laboratory testing:

* * * *

■ 136. Section 1065.910 is revised to read as follows:

§ 1065.910 PEMS auxiliary equipment for field testing.

For field testing you may use various types of auxiliary equipment to attach PEMS to a vehicle or engine and to power PEMS.

(a) When you use PEMS, you may route engine intake air or exhaust through a flow meter. Route the engine intake air or exhaust as follows:

(1) *Flexible connections.* Use short flexible connectors where necessary.

(i) You may use flexible connectors to enlarge or reduce the pipe diameters to match that of your test equipment.

(ii) We recommend that you use flexible connectors that do not exceed a length of three times their largest inside diameter.

(iii) We recommend that you use four-ply silicone-fiberglass fabric with a temperature rating of at least 315 °C for flexible connectors. You may use connectors with a spring-steel wire helix for support and you may use Nomex™ coverings or linings for durability. You may also use any other nonreactive material with equivalent permeation-resistance and durability, as long as it seals tightly.

(iv) Use stainless-steel hose clamps to seal flexible connectors, or use clamps that seal equivalently.

(v) You may use additional flexible connectors to connect to flow meters.

(2) *Tubing.* Use rigid 300 series stainless steel tubing to connect between flexible connectors. Tubing may be straight or bent to accommodate vehicle geometry. You may use “T” or “Y” fittings made of 300 series stainless steel tubing to join multiple connections, or you may cap or plug redundant flow paths if the engine manufacturer recommends it.

(3) *Flow restriction.* Use flowmeters, connectors, and tubing that do not increase flow restriction so much that it exceeds the manufacturer's maximum specified value. You may verify this at the maximum exhaust flow rate by measuring pressure at the manufacturer-specified location with your system connected. You may also perform an engineering analysis to verify an acceptable configuration, taking into account the maximum exhaust flow rate expected, the field test system's flexible connectors, and the tubing's characteristics for pressure drops versus flow.

(b) For vehicles or other motive equipment, we recommend installing PEMS in the same location where a passenger might sit. Follow PEMS manufacturer instructions for installing PEMS in cargo spaces, engine spaces, or externally such that PEMS is directly exposed to the outside environment. We

recommend locating PEMS where it will be subject to minimal sources of the following parameters:

- (1) Ambient temperature changes.
- (2) Ambient pressure changes.
- (3) Electromagnetic radiation.
- (4) Mechanical shock and vibration.
- (5) Ambient hydrocarbons—if using a FID analyzer that uses ambient air as FID burner air.

(c) Use mounting hardware as required for securing flexible connectors, ambient sensors, and other equipment. Use structurally sound mounting points such as vehicle frames, trailer hitch receivers, walkspaces, and payload tie-down fittings. We recommend mounting hardware such as clamps, suction cups, and magnets that are specifically designed for your application. We also recommend considering mounting hardware such as commercially available bicycle racks, trailer hitches, and luggage racks where applicable.

(d) Field testing may require portable electrical power to run your test equipment. Power your equipment, as follows:

(1) You may use electrical power from the vehicle, equipment, or vessel, up to the highest power level, such that all the following are true:

(i) The power system is capable of safely supplying power, such that the power demand for testing does not overload the power system.

(ii) The engine emissions do not change significantly as a result of the power demand for testing.

(iii) The power demand for testing does not increase output from the engine by more than 1% of its maximum power.

(2) You may install your own portable power supply. For example, you may use batteries, fuel cells, a portable generator, or any other power supply to supplement or replace your use of vehicle power. You may connect an external power source directly to the vehicle's, vessel's, or equipment's power system; however, during a test interval (such as an NTE event) you must not supply power to the vehicle's power system in excess of 1% of the engine's maximum power.

■ 137. Section 1065.915 is amended by revising paragraph (a) before the table and paragraphs (c), (d)(1), and (d)(5)(iii)(B) to read as follows:

§ 1065.915 PEMS instruments.

(a) *Instrument specifications.* We recommend that you use PEMS that meet the specifications of subpart C of this part. For unrestricted use of PEMS in a laboratory or similar environment, use a PEMS that meets the same

specifications as each lab instrument it replaces. For field testing or for testing with PEMS in a laboratory or similar environment, under the provisions of § 1065.905(b), the specifications in the following table apply instead of the specifications in Table 1 of § 1065.205.

(c) *Field-testing ambient effects on PEMS.* We recommend that you use PEMS that are only minimally affected by ambient conditions such as temperature, pressure, humidity, physical orientation, mechanical shock and vibration, electromagnetic radiation, and ambient hydrocarbons. Follow the PEMS manufacturer's instructions for proper installation to isolate PEMS from ambient conditions that affect their performance. If a PEMS is inherently affected by ambient conditions that you cannot control, you may monitor those conditions and adjust the PEMS signals to compensate for the ambient effect. The standard-setting part may also specify the use of one or more field-testing adjustments or measurement allowances that you apply to results or standards to account for ambient effects on PEMS.

(d) * * *

(1) *Recording ECM signals.* If your ECM updates a broadcast signal more or less frequently than 1 Hz, process data as follows:

(i) If your ECM updates a broadcast signal more frequently than 1 Hz, use PEMS to sample and record the signal's value more frequently. Calculate and record the 1 Hz mean of the more frequently updated data.

(ii) If your ECM updates a broadcast signal less frequently than 1 Hz, use PEMS to sample and record the signal's value at the most frequent rate. Linearly interpolate between recorded values and record the interpolated values at 1 Hz.

(iii) Optionally, you may use PEMS to electronically filter the ECM signals to meet the rise time and fall time specifications in Table 1 of this section. Record the filtered signal at 1 Hz.

* * * * *

(5) * * *

(iii) * * *

(B) Use a single BSFC value that approximates the BSFC value over a test interval (as defined in subpart K of this part). This value may be a nominal BSFC value for all engine operation determined over one or more laboratory duty cycles, or it may be any other BSFC that you determine. If you use a nominal BSFC, we recommend that you select a value based on the BSFC measured over laboratory duty cycles that best represent the range of engine operation that defines a test interval for field-

testing. You may use the methods of this paragraph (d)(5)(iii)(B) only if it does not adversely affect your ability to demonstrate compliance with applicable standards.

* * * * *

■ 138. Section 1065.920 is amended by revising paragraphs (a), (b)(4)(iii), and (b)(7) introductory text to read as follows:

§ 1065.920 PEMS calibrations and verifications.

(a) *Subsystem calibrations and verifications.* Use all the applicable calibrations and verifications in subpart D of this part, including the linearity verifications in § 1065.307, to calibrate and verify PEMS. Note that a PEMS does not have to meet the system-response specifications of § 1065.308 if it meets the overall verification described in paragraph (b) of this section. This section does not apply to ECM signals.

(b) * * *

(4) * * *

(iii) If the standard-setting part specifies the use of a measurement allowance for field testing, also apply the measurement allowance during calibration using good engineering judgment. If the measurement allowance is normally added to the standard, this means you must subtract the measured PEMS brake-specific emission result.

* * * * *

(7) The PEMS passes this verification if any one of the following are true for each constituent:

* * * * *

■ 139. Section 1065.925 is amended by revising paragraph (h) to read as follows:

§ 1065.925 PEMS preparation for field testing.

* * * * *

(h) Verify the amount of contamination in the PEMS HC sampling system as follows:

(1) Select the HC analyzers' ranges for measuring the maximum concentration expected at the HC standard.

(2) Zero the HC analyzers using a zero gas or ambient air introduced at the analyzer port. When zeroing the FIDs, use the FIDs' burner air that would be used for in-use measurements (generally either ambient air or a portable source of burner air).

(3) Span the HC analyzers using span gas introduced at the analyzer port. When spanning the FIDs, use the FIDs' burner air that would be used in-use (for example, use ambient air or a portable source of burner air).

(4) Overflow zero or ambient air at the HC probe or into a fitting between the HC probe and the transfer line.

(5) Measure the HC concentration in the sampling system:

(i) For continuous sampling, record the mean HC concentration as overflow zero air flows.

(ii) For batch sampling, fill the sample medium and record its mean concentration.

(6) Record this value as the initial HC concentration, x_{HCinit} , and use it to correct measured values as described in § 1065.660.

(7) If the initial HC concentration exceeds the greater of the following values, determine the source of the contamination and take corrective action, such as purging the system or replacing contaminated portions:

(i) 2% of the flow-weighted mean concentration expected at the standard or measured during testing.

(ii) 2 $\mu\text{mol/mol}$.

(8) If corrective action does not resolve the deficiency, you may use a contaminated HC system if it does not prevent you from demonstrating compliance with the applicable emission standards.

■ 140. Section 1065.935 is amended by revising paragraphs (e)(1) and (g)(5) to read as follows:

§ 1065.935 Emission test sequence for field testing.

* * * * *

(e) * * *

(1) Continue sampling as needed to get an appropriate amount of emission measurement, according to the standard setting part. If the standard-setting part does not describe when to stop sampling, develop a written protocol before you start testing to establish how you will stop sampling. You may not determine when to stop testing based on emission results.

* * * * *

(g) * * *

(5) Invalidate any test intervals that do not meet the drift criterion in § 1065.550. For NMHC, invalidate any test intervals if the difference between the uncorrected and the corrected brake-specific NMHC emission values are within $\pm 10\%$ of the uncorrected results or the applicable standard, whichever is greater. For test intervals that do meet the drift criterion, correct those test intervals for drift according to § 1065.672 and use the drift corrected results in emissions calculations.

* * * * *

Subpart K—[Amended]

■ 141. Section 1065.1001 is amended by revising the definitions for “Designated Compliance Officer”, “Regression statistics” and “Tolerance” and adding definitions in alphabetical order for “Dilution ratio”, “Measurement allowance”, “Mode”, “NIST-accepted”, “Recommend”, “Uncertainty”, and “Work” to read as follows:

§ 1065.1001 Definitions.

* * * * *

Designated Compliance Officer means the Director, Compliance and Innovative Strategies Division (6405–J), U.S. Environmental Protection Agency, 1200 Pennsylvania Ave., NW., Washington, DC 20460.

* * * * *

Dilution ratio (DR) means the amount of diluted exhaust per amount of undiluted exhaust.

* * * * *

Measurement allowance means a specified adjustment in the applicable emission standard or a measured emission value to reflect the relative quality of the measurement. See the

standard-setting part to determine whether any measurement allowances apply for your testing. Measurement allowances generally apply only for field testing and are intended to account for reduced accuracy or precision that result from using field-grade measurement systems.

Mode means one of the following:

- (1) A distinct combination of engine speed and load for steady-state testing.
- (2) A continuous combination of speeds and loads specifying a transition during a ramped-modal test.
- (3) A distinct operator demand setting, such as would occur when testing locomotives or constant-speed engines.

NIST-accepted means relating to a value that has been assigned or named by NIST.

* * * * *

Recommend has the meaning given in § 1065.201.

Regression statistics means any of the regression statistics specified in § 1065.602.

* * * * *

Tolerance means the interval in which at least 95% of a set of recorded

values of a certain quantity must lie. Use the specified recording frequencies and time intervals to determine if a quantity is within the applicable tolerance. The concept of tolerance is intended to address random variability. You may not take advantage of the tolerance specification to incorporate a bias into a measurement.

* * * * *

Uncertainty means uncertainty with respect to NIST-traceability. See the definition of NIST-traceable in this section.

* * * * *

Work has the meaning given in § 1065.110.

* * * * *

■ 142. Section 1065.1005 is amended by revising paragraphs (a) and (g) to read as follows:

§ 1065.1005 Symbols, abbreviations, acronyms, and units of measure.

* * * * *

(a) *Symbols for quantities.* This part uses the following symbols and units of measure for various quantities:

Symbol	Quantity	Unit	Unit symbol	Base SI units
%	percent	0.01	%	10 ⁻²
α	atomic hydrogen to carbon ratio	mole per mole	mol/mol	1
A	area	square meter	m ²	m ²
A ₀	intercept of least squares regression			
A ₁	slope of least squares regression			
β	ratio of diameters	meter per meter	m/m	1
β	atomic oxygen to carbon ratio	mole per mole	mol/mol	1
C [#]	number of carbon atoms in a molecule			
d	Diameter	meter	m	m
DR	dilution ratio	mole per mol	mol/mol	1
ε	error between a quantity and its reference			
e	brake-specific basis	gram per kilowatt hour	g/(kW · h)	g · 3.6 ⁻¹ · 10 ⁶ · m ⁻² · kg · s ²
F	F-test statistic			
f	frequency	hertz	Hz	s ⁻¹
f _n	rotational frequency (shaft)	revolutions per minute	rev/min	2 · pi · 60 ⁻¹ · s ⁻¹
γ	ratio of specific heats	(joule per kilogram kelvin) per (joule per kilogram kelvin).	(J/(kg · K))/(J/(kg · K)).	1
K	correction factor			1
l	length	meter	m	m
μ	viscosity, dynamic	pascal second	Pa·s	m ⁻¹ · kg · s ⁻¹
M	molar mass ¹	gram per mole	g/mol	10 ⁻³ · kg · mol ⁻¹
m	mass	kilogram	kg	kg
ṁ	mass rate	kilogram per second	kg/s	kg · s ⁻¹
ν	viscosity, kinematic	meter squared per second	m ² /s	m ² · s ⁻¹
N	total number in series			
n	amount of substance	mole	mol	mol
ṅ	amount of substance rate	mole per second	mol/s	mol · s ⁻¹
P	power	kilowatt	kW	10 ³ · m ² · kg · s ⁻³
PF	penetration fraction			
p	pressure	pascal	Pa	m ⁻¹ · kg · s ⁻²
ρ	mass density	kilogram per cubic meter	kg/m ³	kg · m ⁻³
r	ratio of pressures	pascal per pascal	Pa/Pa	1
R ²	coefficient of determination			
Ra	average surface roughness	micrometer	μm	m ⁻⁶
Re [#]	Reynolds number			
RF	response factor			
RH%	relative humidity	0.01	%	10 ⁻²
σ	non-biased standard deviation			
S	Sutherland constant	kelvin	K	K

Symbol	Quantity	Unit	Unit symbol	Base SI units
SEE	standard estimate of error			
T	absolute temperature	kelvin	K	K
T	Celsius temperature	degree Celsius	°C	K-273.15
T	torque (moment of force)	newton meter	N · m	m ² · kg · s ⁻²
t	time	second	s	s
Δt	time interval, period, 1/frequency	second	s	s
V	volume	cubic meter	m ³	m ³
V	volume rate	cubic meter per second	m ³ /s	m ³ · s ⁻¹
W	work	kilowatt hour	kW · h	3.6 · 10 ⁻⁶ · m ² · kg · s ⁻²
w _c	carbon mass concentration	gram per gram	g/g	1
x	amount of substance mole fraction ²	mole per mole	mol/mol	(¹)
\bar{x}	flow-weighted mean concentration	mole per mole	mol/mol	1
y	generic variable			

¹ See paragraph (f)(2) of this section for the values to use for molar masses. Note that in the cases of NO_x and HC, the regulations specify effective molar masses based on assumed speciation rather than actual speciation.

² Note that mole fractions for THC, THCE, NMHC, NMHCE, and NOTHC are expressed on a C1 equivalent basis.

* * * * *

(g) *Other acronyms and abbreviations.*
 This part uses the following additional abbreviations and acronyms:
 ASTM American Society for Testing and Materials
 BMD bag mini-diluter
 BSFC brake-specific fuel consumption
 CARB California Air Resources Board
 CFR Code of Federal Regulations
 CFV critical-flow venturi
 CI compression-ignition
 CITT Curb Idle Transmission Torque
 CLD chemiluminescent detector
 CVS constant-volume sampler
 DF deterioration factor
 ECM electronic control module
 EFC electronic flow control
 EGR exhaust gas recirculation
 EPA Environmental Protection Agency
 FEL Family Emission Limit
 FID flame-ionization detector
 IBP initial boiling point
 ISO International Organization for Standardization
 LPG liquefied petroleum gas
 NDIR nondispersive infrared
 NDUV nondispersive ultraviolet

NIST National Institute for Standards and Technology
 PDP positive-displacement pump
 PEMS portable emission measurement system
 PFD partial-flow dilution
 PMP Polymethylpentene
 pt. a single point at the mean value expected at the standard
 PTFE polytetrafluoroethylene (commonly known as Teflon™)
 RE rounding error
 RMC ramped-modal cycle
 RMS root-mean square
 RTD resistive temperature detector
 SSV subsonic venturi
 SI spark-ignition
 UCL upper confidence limit
 UFM ultrasonic flow meter
 U.S.C. United States Code
 ■ 143. Section 1065.1010 is revised to read as follows:
§ 1065.1010 Reference materials.
 Documents listed in this section have been incorporated by reference into this part. The Director of the Federal Register approved the incorporation by

reference as prescribed in 5 U.S.C. 552(a) and 1 CFR part 51. Anyone may inspect copies at the U.S. EPA, Air and Radiation Docket and Information Center, 1301 Constitution Ave., NW., Room B102, EPA West Building, Washington, DC 20460 or at the National Archives and Records Administration (NARA). For information on the availability of this material at NARA, call 202-741-6030, or go to: http://www.archives.gov/federal_register/code_of_federal_regulations/ibr_locations.html.
 (a) *ASTM material.* Table 1 of this section lists material from the American Society for Testing and Materials that we have incorporated by reference. The first column lists the number and name of the material. The second column lists the sections of this part where we reference it. Anyone may purchase copies of these materials from the American Society for Testing and Materials, 100 Barr Harbor Dr., P.O. Box C700, West Conshohocken, PA 19428 or www.astm.com. Table 1 follows:

TABLE 1 OF § 1065.1010.—ASTM MATERIALS

Document No. and name	Part 1065 reference
ASTM D86-07a, Standard Test Method for Distillation of Petroleum Products at Atmospheric Pressure	1065.703, 1065.710
ASTM D93-07, Standard Test Methods for Flash Point by Pensky-Martens Closed Cup Tester	1065.703
ASTM D445-06, Standard Test Method for Kinematic Viscosity of Transparent and Opaque Liquids (and the Calculation of Dynamic Viscosity)	1065.703
ASTM D613-05, Standard Test Method for Cetane Number of Diesel Fuel Oil	1065.703
ASTM D910-07, Standard Specification for Aviation Gasolines	1065.701
ASTM D975-07b, Standard Specification for Diesel Fuel Oils	1065.701
ASTM D1267-02 (Reapproved 2007), Standard Test Method for Gage Vapor Pressure of Liquefied Petroleum (LP) Gases (LP-Gas Method)	1065.720
ASTM D1319-03, Standard Test Method for Hydrocarbon Types in Liquid Petroleum Products by Fluorescent Indicator Adsorption	1065.710
ASTM D1655-07e01, Standard Specification for Aviation Turbine Fuels	1065.701
ASTM D1837-02a (Reapproved 2007), Standard Test Method for Volatility of Liquefied Petroleum (LP) Gases	1065.720
ASTM D1838-07, Standard Test Method for Copper Strip Corrosion by Liquefied Petroleum (LP) Gases	1065.720
ASTM D1945-03, Standard Test Method for Analysis of Natural Gas by Gas Chromatography	1065.715
ASTM D2158-05, Standard Test Method for Residues in Liquefied Petroleum (LP) Gases	1065.720

TABLE 1 OF § 1065.1010.—ASTM MATERIALS—Continued

Document No. and name	Part 1065 reference
ASTM D2163–05, Standard Test Method for Analysis of Liquefied Petroleum (LP) Gases and Propene Concentrates by Gas Chromatography	1065.720
ASTM D2598–02 (Reapproved 2007), Standard Practice for Calculation of Certain Physical Properties of Liquefied Petroleum (LP) Gases from Compositional Analysis	1065.720
ASTM D2622–07, Standard Test Method for Sulfur in Petroleum Products by Wavelength Dispersive X-ray Fluorescence Spectrometry	1065.703, 1065.710
ASTM D2713–91 (Reapproved 2001), Standard Test Method for Dryness of Propane (Valve Freeze Method)	1065.720
ASTM D2784–06, Standard Test Method for Sulfur in Liquefied Petroleum Gases (Oxy-Hydrogen Burner or Lamp)	1065.720
ASTM D2880–03, Standard Specification for Gas Turbine Fuel Oils	1065.701
ASTM D2986–95a (Reapproved 1999), Standard Practice for Evaluation of Air Assay Media by the Monodisperse DOP (Diocetyl Phthalate) Smoke Test	1065.170
ASTM D3231–07, Standard Test Method for Phosphorus in Gasoline	1065.710
ASTM D3237–06e01, Standard Test Method for Lead in Gasoline By Atomic Absorption Spectroscopy	1065.710
ASTM D4052–96e01 (Reapproved 2002), Standard Test Method for Density and Relative Density of Liquids by Digital Density Meter	1065.703
ASTM D4814–07a, Standard Specification for Automotive Spark-Ignition Engine Fuel	1065.701
ASTM D5186–03, Standard Test Method for Determination of the Aromatic Content and Polynuclear Aromatic Content of Diesel Fuels and Aviation Turbine Fuels By Supercritical Fluid Chromatography	1065.703
ASTM D5191–07, Standard Test Method for Vapor Pressure of Petroleum Products (Mini Method)	1065.710
ASTM D5797–07, Standard Specification for Fuel Methanol (M70–M85) for Automotive Spark-Ignition Engines	1065.701
ASTM D5798–07, Standard Specification for Fuel Ethanol (Ed75–Ed85) for Automotive Spark-Ignition Engines	1065.701
ASTM D6615–06, Standard Specification for Jet B Wide-Cut Aviation Turbine Fuel	1065.701
ASTM D6751–07b, Standard Specification for Biodiesel Fuel Blend Stock (B100) for Middle Distillate Fuels	1065.701
ASTM D6985–04a, Standard Specification for Middle Distillate Fuel Oil—Military Marine Applications	1065.701
ASTM F1471–93 (Reapproved 2001), Standard Test Method for Air Cleaning Performance of a High-Efficiency Particulate Air Filter System	1065.1001

(b) *ISO material*. Table 2 of this section lists material from the International Organization for Standardization that we have incorporated by reference. The first

column lists the number and name of the material. The second column lists the section of this part where we reference it. Anyone may purchase copies of these materials from the

International Organization for Standardization, Case Postale 56, CH–1211 Geneva 20, Switzerland or www.iso.org. Table 2 follows:

TABLE 2 OF § 1065.1010.—ISO MATERIALS

Document No. and name	Part 1065 reference
ISO 2719:2002, Determination of flash point—Pensky-Martens closed cup method	1065.705
ISO 3016:1994, Petroleum products—Determination of pour point	1065.705
ISO 3104:1994/Cor 1:1997, Petroleum products—Transparent and opaque liquids—Determination of kinematic viscosity and calculation of dynamic viscosity	1065.705
ISO 3675:1998, Crude petroleum and liquid petroleum products—Laboratory determination of density—Hydrometer method	1065.705
ISO 3733:1999, Petroleum products and bituminous materials—Determination of water—Distillation method	1065.705
ISO 6245:2001, Petroleum products—Determination of ash	1065.705
ISO 8217:2005, Petroleum products—Fuels (class F)—Specifications of marine fuels	1065.705
ISO 8754:2003, Petroleum products—Determination of sulfur content—Energy-dispersive X-ray fluorescence spectrometry	1065.705
ISO 10307–2:1993, Petroleum products—Total sediment in residual fuel oils—Part 2: Determination using standard procedures for ageing	1065.705
ISO 10370:1993/Cor 1:1996, Petroleum products—Determination of carbon residue—Micro method	1065.705
ISO 10478:1994, Petroleum products—Determination of aluminium and silicon in fuel oils—Inductively coupled plasma emission and atomic absorption spectroscopy methods	1065.705
ISO 12185:1996/Cor 1:2001, Crude petroleum and petroleum products—Determination of density—Oscillating U-tube method	1065.705
ISO 14596:2007, Petroleum products—Determination of sulfur content—Wavelength-dispersive X-ray fluorescence spectrometry ..	1065.705
ISO 14597:1997, Petroleum products—Determination of vanadium and nickel content—Wavelength-dispersive X-ray fluorescence spectrometry	1065.705
ISO 14644–1:1999, Cleanrooms and associated controlled environments	1065.190

(c) *NIST material*. Table 3 of this section lists material from the National Institute of Standards and Technology that we have incorporated by reference. The first column lists the number and

name of the material. The second column lists the section of this part where we reference it. Anyone may purchase copies of these materials from the Government Printing Office,

Washington, DC 20402 or download them free from the Internet at www.nist.gov. Table 3 follows:

TABLE 3 OF § 1065.1010.—NIST MATERIALS

Document No. and name	Part 1065 reference
ISONIST Special Publication 811, 1995 Edition, Guide for the Use of the International System of Units (SI), Barry N. Taylor, Physics Laboratory.	1065.20, 1065.1001, 1065.1005
NIST Technical Note 1297, 1994 Edition, Guidelines for Evaluating and Expressing the Uncertainty of NIST Measurement Results, Barry N. Taylor and Chris E. Kuyatt.	1065.1001

(d) *SAE material.* Table 4 of this section lists material from the Society of Automotive Engineering that we have incorporated by reference. The first column lists the number and name of the material. The second column lists the sections of this part where we reference it. Anyone may purchase copies of these materials from the Society of Automotive Engineers, 400 Commonwealth Drive, Warrendale, PA 15096 or www.sae.org. Table 4 follows:

TABLE 4 OF § 1065.1010.—SAE MATERIALS

Document No. and name	Part 1065 reference
"Optimization of Flame Ionization Detector for Determination of Hydrocarbon in Diluted Automotive Exhausts," Reschke Glen D., SAE 770141	1065.360
"Relationships Between Instantaneous and Measured Emissions in Heavy Duty Applications," Ganesan B. and Clark N. N., West Virginia University, SAE 2001-01-3536	1065.309

(e) *California Air Resources Board material.* Table 5 of this section lists material from the California Air Resources Board that we have incorporated by reference. The first column lists the number and name of the material. The second column lists the sections of this part where we reference it. Anyone may get copies of these materials from the California Air Resources Board, 9528 Telstar Ave., El Monte, California 91731. Table 5 follows:

TABLE 5 OF § 1065.1010.—CALIFORNIA AIR RESOURCES BOARD MATERIALS

Document No. and name	Part 1065 reference
"California Non-Methane Organic Gas Test Procedures," Amended July 30, 2002, Mobile Source Division, California Air Resources Board	1065.805

(f) *Institute of Petroleum material.* Table 6 of this section lists the Institute of Petroleum standard test methods material from the Energy Institute that we have incorporated by reference. The first column lists the number and name of the material. The second column lists the section of this part where we reference it. Anyone may purchase copies of these materials from the Energy Institute, 61 New Cavendish Street, London, W1G 7AR, UK, +44 (0)20 7467 7100 or www.energyinst.org.uk. Table 6 follows:

TABLE 6 OF § 1065.1010.—INSTITUTE OF PETROLEUM MATERIALS

Document No. and name	Part 1065 reference
IP-470, Determination of aluminum, silicon, vanadium, nickel, iron, calcium, zinc, and sodium in residual fuels by atomic absorption spectrometry	1065.705
IP-500, Determination of the phosphorus content of residual fuels by ultra-violet spectrometry	1065.705
IP-501, Determination of aluminum, silicon, vanadium, nickel, iron, sodium, calcium, zinc and phosphorus in residual fuel oil by ashing, fusion and inductively coupled plasma emission spectrometry	1065.705

PART 1068—GENERAL COMPLIANCE PROVISIONS FOR NONROAD PROGRAMS

■ 144. The authority citation for part 1068 continues to read as follows:

Authority: 42 U.S.C. 7401-7671q.

Subpart A—[Amended]

■ 145. Section 1068.1 is revised by adding paragraphs (a)(6) and (a)(7) and revising paragraphs (b)(4) and (b)(6) to read as follows:

§ 1068.1 Does this part apply to me?

(a) * * *

(6) Locomotives and locomotive engines we regulate under 40 CFR part 1033.

(7) Marine compression-ignition engines we regulate under 40 CFR part 1042.

(b) * * *

(4) Locomotives and locomotive engines we regulate under 40 CFR part 92.

* * * * *

(6) Marine diesel engines we regulate under 40 CFR part 89 or 94.

* * * * *

[FR Doc. E8-7999 Filed 5-5-08; 8:45 am]

BILLING CODE 6560-50-P