

**9A120 Complete unmanned aerial vehicles designed or modified to dispense an aerosol, capable of carrying elements of a payload in the form of a particulate or liquid other than fuel components of such vehicles of volume greater than 20 liters, and having any of the following:**

\* \* \* \* \*

*List of Items Controlled*

*Unit:* \* \* \*

*Related Controls:* See ECCN 9A012 or the U.S. Munitions List Category VIII (22 CFR part 121). Also see ECCN 2B352.h for controls on certain spraying or fogging systems, and components therefor, specially designed or modified for fitting to aircraft, "lighter than air vehicles," or "UAVs."

*Related Definitions:* \* \* \*

*Items:*

\* \* \* \* \*

Dated: July 29, 2005.

**Matthew S. Borman,**

*Deputy Assistant Secretary for Export Administration.*

[FR Doc. 05-15530 Filed 8-4-05; 8:45 am]

BILLING CODE 3510-33-P

**ARCHITECTURAL AND TRANSPORTATION BARRIERS COMPLIANCE BOARD**

**36 CFR Part 1191**

[Docket No. 99-1]

RIN 3014-AA20

**Americans With Disabilities Act (ADA) Accessibility Guidelines for Buildings and Facilities; Architectural Barriers Act (ABA) Accessibility Guidelines; Corrections**

**AGENCY:** Architectural and Transportation Barriers Compliance Board.

**ACTION:** Correcting amendments.

**SUMMARY:** The Architectural and Transportation Barriers Compliance Board (Access Board) published a final rule in the **Federal Register** on July 23, 2004 revising and updating its accessibility guidelines for buildings and facilities covered by the Americans with Disabilities Act of 1990 (ADA) and the Architectural Barriers Act of 1968 (ABA). This document contains correcting amendments to the final rule.

**DATES:** The correcting amendments are effective September 6, 2005.

**FOR FURTHER INFORMATION CONTACT:** Marsha Mazz, Office of Technical and Information Services, Architectural and Transportation Barriers Compliance

Board, 1331 F Street, NW., Suite 1000, Washington, DC 20004-1111. Telephone numbers: (202) 272-0020 (voice); (202) 272-0082 (TTY). E-mail address: [ta@access-board.gov](mailto:ta@access-board.gov).

**SUPPLEMENTARY INFORMATION:** The final rule published in the **Federal Register** on July 23, 2004 (69 FR 44084) revising and updating the accessibility guidelines for buildings and facilities covered by the Americans with Disabilities Act of 1990 (ADA) and the Architectural Barriers Act of 1968 (ABA) contained some errors and omissions, which are corrected by this document.

**Appendix B to Part 1191—Americans With Disabilities Act: Scoping**

The following is a description of the corrections made to Appendix B to Part 1191—Americans with Disabilities Act: Scoping:

1. On page 12, in § 106.5 the term "amusement attractions" is italicized in the second sentence since the term is defined in § 106.5.

2. On page 20, in § 202.5 the word "or" in the term "qualified historic building or facility" is italicized since the term is defined in § 106.5.

3. On page 22, § 203.9 is amended to exclude raised courtroom stations from the general exception for small, elevated employee work areas. There is a specific exception for raised courtroom stations in § 206.2.4.

4. On page 29, § 206.4.4.1 is amended by adding the words "serving each fixed route or group of fixed routes" after the term "public entrance." These words were in § 10.3.1(2) of the former guidelines. The amendment clarifies that, where different entrances serve different transportation fixed routes or groups of fixed routes, at least one public entrance serving each fixed route or group of fixed routes is required to be accessible.

5. On page 34, in § 208.2.3 the term "facilities" is italicized since the term is defined in § 106.5.

6. On page 70, in § 242.3 the term "accessible" is italicized in the second sentence since the term is defined in § 106.5.

**Appendix C to Part 1191—Architectural Barriers Act: Scoping**

The following is a description of the corrections made to Appendix C to Part 1191—Architectural Barriers Act: Scoping:

1. On page 79, in § F106.3 the blank spaces after the words "United States Postal Service" are deleted and a single space is inserted in their place.

2. On page 80, in § F106.5 the term "amusement attractions" is italicized in

the second sentence since the term is defined in § F106.5.

3. On page 87, in § F202.5 the word "or" in the term "qualified historic building or facility" is italicized since the term is defined in § F106.5.

4. On page 97, § F206.4.4.1 is amended by adding the words "serving each fixed route or group of fixed routes" after the term "public entrance." The amendment is consistent with an amendment made to § 206.4.4.1 in Appendix B to Part 1191—Americans with Disabilities Act: Scoping.

5. On page 102, in § F208.2.3 the term "facilities" is italicized since the term is defined in § F106.5; and in § F208.2.4 one indent is removed and the section is placed in-line with § F208.2.3.

6. On page 127, in § F233.1 the indent is removed and the section is placed in-line with § F233.

7. On page 128, in § F233.2 the indent is removed and the section is placed in-line with § F233.1.

**Appendix D to Part 1191—Technical**

The following is a description of the corrections made to Appendix D to Part 1191—Technical:

1. On page 173, in § 407.2.3.1 the word "and" is deleted after the words "complying with 703.2 and 703.4.1."

2. On page 178, in Table 407.2.3.1 the quotation mark is deleted after the letter "P" in the first row of the third column.

3. On page 191, in the advisory note under § 505.4 the word "principle" is deleted and the word "principal" is inserted in its place in the second sentence.

4. On page 197, in the advisory note under § 606.3 the redundant words "and people" are deleted.

5. On page 225, Figure 703.3.1 is revised to correctly reflect the requirements in Table 703.3.1.

6. On page 247, three sections are corrected. In the exception under § 806.2.3, the term "space" is italicized the second time the term is used since the term is defined in §§ 106.5 and F106.5. Section 806.2.4 is amended to clarify that at least one bathroom in an accessible guest room is required to be accessible; to reference the applicable requirements for accessible toilet and bathing fixtures in Chapter 6; and to permit accessible toilet and bathing fixtures to be located in more than one toilet or bathing area, provided that travel between the fixtures does not require travel between other parts of the guest room. In § 806.2.4.1, the italics are deleted in the second part of the word "non-accessible."

7. On pages 248 through 251, the text is shifted due to the corrections on page

247. There are no other corrections on pages 248 and 249.

8. On page 250, in § 809.4 the words “toilet and bathing facility” are deleted and the word “bathroom” is inserted in their place, and the words “through 610” are deleted in the first sentence; and the words “at least” are deleted and the words “no fewer than” are inserted in their place in the second sentence. In the advisory note under § 809.4, the first and second sentences are deleted.

9. On page 251, § 809.5.2.2 is renumbered § 809.5.2.1.

#### **Appendix E to Part 1191—List of Figures and Index**

On pages 299, 300, 302, and 304, the page numbers listed in the index are revised to correctly list the pages where

items are found as a result of the text shifts on pages 248 through 251.

#### **List of Subjects in 36 CFR Part 1191**

Buildings and facilities, Civil rights, Incorporation by reference, Individuals with disabilities, Transportation.

#### **Jan Tuck,**

*Chair, Architectural and Transportation Barriers Compliance Board.*

■ Accordingly, 36 CFR part 1191 is corrected by making the following correcting amendments:

#### **PART 1191—AMERICANS WITH DISABILITIES ACT (ADA) ACCESSIBILITY GUIDELINES FOR BUILDINGS AND FACILITIES; ARCHITECTURAL BARRIERS ACT (ABA) ACCESSIBILITY GUIDELINES**

■ 1. The authority citation for 36 CFR part 1191 continues to read as follows:

**Authority:** 29 U.S.C. 792(b)(3); 42 U.S.C. 12204.

■ 2. Appendix B to Part 1191—Americans with Disabilities Act: Scoping is amended by revising pages 12, 20, 22, 29, 34, and 70 as set forth below.

#### **Appendix B to Part 1191—Americans With Disabilities Act: Scoping**

**BILLING CODE 8150-01-P**

## 106 Definitions

**106.1 General.** For the purpose of this document, the terms defined in 106.5 have the indicated meaning.

**Advisory 106.1 General.** Terms defined in Section 106.5 are italicized in the text of this document.

**106.2 Terms Defined in Referenced Standards.** Terms not defined in 106.5 or in regulations issued by the Department of Justice and the Department of Transportation to implement the Americans with Disabilities Act, but specifically defined in a referenced standard, shall have the specified meaning from the referenced standard unless otherwise stated.

**106.3 Undefined Terms.** The meaning of terms not specifically defined in 106.5 or in regulations issued by the Department of Justice and the Department of Transportation to implement the Americans with Disabilities Act or in referenced standards shall be as defined by collegiate dictionaries in the sense that the context implies.

**106.4 Interchangeability.** Words, terms and phrases used in the singular include the plural and those used in the plural include the singular.

### 106.5 Defined Terms.

**Accessible.** A *site, building, facility*, or portion thereof that complies with this part.

**Accessible Means of Egress.** A continuous and unobstructed way of egress travel from any point in a *building or facility* that provides an *accessible* route to an area of refuge, a horizontal exit, or a *public way*.

**Addition.** An expansion, extension, or increase in the gross floor area or height of a *building or facility*.

**Administrative Authority.** A governmental agency that adopts or enforces regulations and guidelines for the design, construction, or *alteration* of *buildings and facilities*.

**Alteration.** A change to a *building or facility* that affects or could affect the usability of the *building or facility* or portion thereof. *Alterations* include, but are not limited to, remodeling, renovation, rehabilitation, reconstruction, historic restoration, resurfacing of *circulation paths* or *vehicular ways*, changes or rearrangement of the structural parts or *elements*, and changes or rearrangement in the plan configuration of walls and full-height partitions. Normal maintenance, reroofing, painting or wallpapering, or changes to mechanical and electrical systems are not *alterations* unless they affect the usability of the *building or facility*.

**Amusement Attraction.** Any *facility*, or portion of a *facility*, located within an amusement park or theme park which provides amusement without the use of an amusement device. *Amusement attractions* include, but are not limited to, fun houses, barrels, and other attractions without seats.

**Advisory 202.4 Alterations Affecting Primary Function Areas (Continued).** Also, mixed use facilities may include numerous primary function areas for each use. Areas containing a primary function do not include: mechanical rooms, boiler rooms, supply storage rooms, employee lounges or locker rooms, janitorial closets, entrances, corridors, or restrooms.

**202.5 Alterations to Qualified Historic Buildings and Facilities.** *Alterations to a qualified historic building or facility* shall comply with 202.3 and 202.4.

**EXCEPTION:** Where the State Historic Preservation Officer or Advisory Council on Historic Preservation determines that compliance with the requirements for *accessible routes, entrances, or toilet facilities* would threaten or destroy the historic significance of the *building or facility*, the exceptions for *alterations to qualified historic buildings or facilities* for that *element* shall be permitted to apply.

**Advisory 202.5 Alterations to Qualified Historic Buildings and Facilities Exception.**

State Historic Preservation Officers are State appointed officials who carry out certain responsibilities under the National Historic Preservation Act. State Historic Preservation Officers consult with Federal and State agencies, local governments, and private entities on providing access and protecting significant elements of qualified historic buildings and facilities. There are exceptions for alterations to qualified historic buildings and facilities for accessible routes (206.2.1 Exception 1 and 206.2.3 Exception 7); entrances (206.4 Exception 2); and toilet facilities (213.2 Exception 2). When an entity believes that compliance with the requirements for any of these elements would threaten or destroy the historic significance of the building or facility, the entity should consult with the State Historic Preservation Officer. If the State Historic Preservation Officer agrees that compliance with the requirements for a specific element would threaten or destroy the historic significance of the building or facility, use of the exception is permitted. Public entities have an additional obligation to achieve program accessibility under the Department of Justice ADA regulations. See 28 CFR 35.150. These regulations require public entities that operate historic preservation programs to give priority to methods that provide physical access to individuals with disabilities. If alterations to a qualified historic building or facility to achieve program accessibility would threaten or destroy the historic significance of the building or facility, fundamentally alter the program, or result in undue financial or administrative burdens, the Department of Justice ADA regulations allow alternative methods to be used to achieve program accessibility. In the case of historic preservation programs, such as an historic house museum, alternative methods include using audio-visual materials to depict portions of the house that cannot otherwise be made accessible. In the case of other qualified historic properties, such as an historic government office building, alternative methods include relocating programs and services to accessible locations. The Department of Justice ADA regulations also allow public entities to use alternative methods when altering qualified historic buildings or facilities in the rare situations where the State Historic Preservation Officer determines that it is not feasible to provide physical access using the exceptions permitted in Section 202.5 without threatening or destroying the historic significance of the building or facility. See 28 CFR 35.151(d).

**203.9 Employee Work Areas.** *Spaces* and *elements* within *employee work areas* shall only be required to comply with 206.2.8, 207.1, and 215.3 and shall be designed and constructed so that individuals with disabilities can approach, enter, and exit the *employee work area*. *Employee work areas*, or portions of *employee work areas*, other than raised courtroom stations, that are less than 300 square feet (28 m<sup>2</sup>) and elevated 7 inches (180 mm) or more above the finish floor or ground where the elevation is essential to the function of the *space* shall not be required to comply with these requirements or to be on an *accessible* route.

**Advisory 203.9 Employee Work Areas.** Although areas used exclusively by employees for work are not required to be fully accessible, consider designing such areas to include non-required turning spaces, and provide accessible elements whenever possible. Under the ADA, employees with disabilities are entitled to reasonable accommodations in the workplace; accommodations can include alterations to spaces within the facility. Designing employee work areas to be more accessible at the outset will avoid more costly retrofits when current employees become temporarily or permanently disabled, or when new employees with disabilities are hired. Contact the Equal Employment Opportunity Commission (EEOC) at [www.eeoc.gov](http://www.eeoc.gov) for information about title I of the ADA prohibiting discrimination against people with disabilities in the workplace.

**203.10 Raised Refereeing, Judging, and Scoring Areas.** Raised structures used solely for refereeing, judging, or scoring a sport shall not be required to comply with these requirements or to be on an *accessible* route.

**203.11 Water Slides.** Water slides shall not be required to comply with these requirements or to be on an *accessible* route.

**203.12 Animal Containment Areas.** Animal containment areas that are not for *public use* shall not be required to comply with these requirements or to be on an *accessible* route.

**Advisory 203.12 Animal Containment Areas.** Public circulation routes where animals may travel, such as in petting zoos and passageways alongside animal pens in State fairs, are not eligible for the exception.

**203.13 Raised Boxing or Wrestling Rings.** Raised boxing or wrestling rings shall not be required to comply with these requirements or to be on an *accessible* route.

**203.14 Raised Diving Boards and Diving Platforms.** Raised diving boards and diving platforms shall not be required to comply with these requirements or to be on an *accessible* route.

## 204 Protruding Objects

**204.1 General.** Protruding objects on *circulation paths* shall comply with 307.

**EXCEPTIONS:** 1. Within *areas of sport activity*, protruding objects on *circulation paths* shall not be required to comply with 307.

2. Within *play areas*, protruding objects on *circulation paths* shall not be required to comply with 307 provided that ground level *accessible* routes provide vertical clearance in compliance with 1008.2.

four or more entry points are provided for *soft contained play structures*, at least two entry points shall be on an *accessible* route.

**206.3 Location.** *Accessible* routes shall coincide with or be located in the same area as general *circulation paths*. Where *circulation paths* are interior, required *accessible* routes shall also be interior.

**Advisory 206.3 Location.** The accessible route must be in the same area as the general circulation path. This means that circulation paths, such as vehicular ways designed for pedestrian traffic, walks, and unpaved paths that are designed to be routinely used by pedestrians must be accessible or have an accessible route nearby. Additionally, accessible vertical interior circulation must be in the same area as stairs and escalators, not isolated in the back of the facility.

**206.4 Entrances.** *Entrances* shall be provided in accordance with 206.4. *Entrance* doors, doorways, and gates shall comply with 404 and shall be on an *accessible* route complying with 402.

**EXCEPTIONS:** 1. Where an *alteration* includes *alterations* to an *entrance*, and the *building* or *facility* has another *entrance* complying with 404 that is on an *accessible* route, the *altered entrance* shall not be required to comply with 206.4 unless required by 202.4.

2. Where exceptions for *alterations* to *qualified historic buildings or facilities* are permitted by 202.5, no more than one *public entrance* shall be required to comply with 206.4. Where no *public entrance* can comply with 206.4 under criteria established in 202.5 Exception, then either an unlocked *entrance* not used by the public shall comply with 206.4; or a locked *entrance* complying with 206.4 with a notification system or remote monitoring shall be provided.

**206.4.1 Public Entrances.** In addition to *entrances* required by 206.4.2 through 206.4.9, at least 60 percent of all *public entrances* shall comply with 404.

**206.4.2 Parking Structure Entrances.** Where direct access is provided for pedestrians from a parking structure to a *building* or *facility entrance*, each direct access to the *building* or *facility entrance* shall comply with 404.

**206.4.3 Entrances from Tunnels or Elevated Walkways.** Where direct access is provided for pedestrians from a pedestrian tunnel or elevated walkway to a *building* or *facility*, at least one direct *entrance* to the *building* or *facility* from each tunnel or walkway shall comply with 404.

**206.4.4 Transportation Facilities.** In addition to the requirements of 206.4.2, 206.4.3, and 206.4.5 through 206.4.9, transportation *facilities* shall provide *entrances* in accordance with 206.4.4.

**206.4.4.1 Location.** In transportation *facilities*, where different *entrances* serve different transportation fixed routes or groups of fixed routes, at least one *public entrance* serving each fixed route or group of fixed routes shall comply with 404.

**EXCEPTION:** *Entrances* to *key stations* and existing intercity rail stations retrofitted in accordance with 49 CFR 37.49 or 49 CFR 37.51 shall not be required to comply with 206.4.4.1.

**208.2.1 Hospital Outpatient Facilities.** Ten percent of patient and visitor parking *spaces* provided to serve hospital outpatient *facilities* shall comply with 502.

**Advisory 208.2.1 Hospital Outpatient Facilities.** The term “outpatient facility” is not defined in this document but is intended to cover facilities or units that are located in hospitals and that provide regular and continuing medical treatment without an overnight stay. Doctors' offices, independent clinics, or other facilities not located in hospitals are not considered hospital outpatient facilities for purposes of this document.

**208.2.2 Rehabilitation Facilities and Outpatient Physical Therapy Facilities.** Twenty percent of patient and visitor parking *spaces* provided to serve rehabilitation *facilities* specializing in treating conditions that affect mobility and outpatient physical therapy *facilities* shall comply with 502.

**Advisory 208.2.2 Rehabilitation Facilities and Outpatient Physical Therapy Facilities.** Conditions that affect mobility include conditions requiring the use or assistance of a brace, cane, crutch, prosthetic device, wheelchair, or powered mobility aid; arthritic, neurological, or orthopedic conditions that severely limit one's ability to walk; respiratory diseases and other conditions which may require the use of portable oxygen; and cardiac conditions that impose significant functional limitations.

**208.2.3 Residential Facilities.** Parking *spaces* provided to serve residential *facilities* shall comply with 208.2.3.

**208.2.3.1 Parking for Residents.** Where at least one parking *space* is provided for each *residential dwelling unit*, at least one parking *space* complying with 502 shall be provided for each *residential dwelling unit* required to provide mobility features complying with 809.2 through 809.4.

**208.2.3.2 Additional Parking Spaces for Residents.** Where the total number of parking *spaces* provided for each *residential dwelling unit* exceeds one parking *space* per *residential dwelling unit*, 2 percent, but no fewer than one *space*, of all the parking *spaces* not covered by 208.2.3.1 shall comply with 502.

**208.2.3.3 Parking for Guests, Employees, and Other Non-Residents.** Where parking spaces are provided for persons other than residents, parking shall be provided in accordance with Table 208.2.

**208.2.4 Van Parking Spaces.** For every six or fraction of six parking *spaces* required by 208.2 to comply with 502, at least one shall be a van parking *space* complying with 502.

**208.3 Location.** Parking *facilities* shall comply with 208.3

**208.3.1 General.** Parking *spaces* complying with 502 that serve a particular *building* or *facility* shall be located on the shortest *accessible* route from parking to an *entrance* complying with 206.4. Where parking serves more than one *accessible entrance*, parking *spaces* complying with 502 shall be dispersed and located on the shortest *accessible* route to the *accessible entrances*. In parking

**Advisory 240.2.2 Elevated Play Components (Continued).** Play components that are attached to a composite play structure and can be approached from a platform or deck (e.g., climbers and overhead play components) are considered elevated play components. These play components are not considered ground level play components and do not count toward the requirements in 240.2.1.2 regarding the number of ground level play components that must be located on an accessible route.

## 241 Saunas and Steam Rooms

**241 General.** Where provided, saunas and steam rooms shall comply with 612.

**EXCEPTION:** Where saunas or steam rooms are clustered at a single location, no more than 5 percent of the saunas and steam rooms, but no fewer than one, of each type in each cluster shall be required to comply with 612.

## 242 Swimming Pools, Wading Pools, and Spas

**242.1 General.** Swimming pools, wading pools, and spas shall comply with 242.

**242.2 Swimming Pools.** At least two *accessible* means of entry shall be provided for swimming pools. *Accessible* means of entry shall be swimming pool lifts complying with 1009.2; sloped entries complying with 1009.3; transfer walls complying with 1009.4; transfer systems complying with 1009.5; and pool stairs complying with 1009.6. At least one *accessible* means of entry provided shall comply with 1009.2 or 1009.3.

- EXCEPTIONS:**
- 1.** Where a swimming pool has less than 300 linear feet (91 m) of swimming pool wall, no more than one *accessible* means of entry shall be required provided that the *accessible* means of entry is a swimming pool lift complying with 1009.2 or sloped entry complying with 1009.3.
  - 2.** Wave action pools, leisure rivers, sand bottom pools, and other pools where user access is limited to one area shall not be required to provide more than one *accessible* means of entry provided that the *accessible* means of entry is a swimming pool lift complying with 1009.2, a sloped entry complying with 1009.3, or a transfer system complying with 1009.5.
  - 3.** *Catch pools* shall not be required to provide an *accessible* means of entry provided that the *catch pool* edge is on an *accessible* route.

**Advisory 242.2 Swimming Pools.** Where more than one means of access is provided into the water, it is recommended that the means be different. Providing different means of access will better serve the varying needs of people with disabilities in getting into and out of a swimming pool. It is also recommended that where two or more means of access are provided, they not be provided in the same location in the pool. Different locations will provide increased options for entry and exit, especially in larger pools.

**Advisory 242.2 Swimming Pools Exception 1.** Pool walls at diving areas and areas along pool walls where there is no pool entry because of landscaping or adjacent structures are to be counted when determining the number of accessible means of entry required.

**242.3 Wading Pools.** At least one *accessible* means of entry shall be provided for wading pools. *Accessible* means of entry shall comply with sloped entries complying with 1009.3.



■ 3. Appendix C to Part 1191— amended by revising pages 79, 80, 87, 97, Appendix C to Part 1191—  
Architectural Barriers Act: Scoping is 102, 127, and 128 as set forth below. Architectural Barriers Act: Scoping

## ARCHITECTURAL BARRIERS ACT: SCOPING

## ABA CHAPTER 1: APPLICATION AND ADMINISTRATION

**F106 Definitions**

**F106.1 General.** For the purpose of this document, the terms defined in F106.5 have the indicated meaning.

**Advisory F106.1 General.** Terms defined in Section 106.5 are italicized in the text of this document.

**F106.2 Terms Defined in Referenced Standard.** Terms not defined in F106.5 or in regulations issued by the Administrator of the General Services Administration, the Secretary of Defense, the Secretary of Housing and Urban Development, or the United States Postal Service to implement the Architectural Barriers Act but specifically defined in a referenced standard, shall have the specified meaning from the referenced standard unless otherwise stated

**F106.3 Undefined Terms.** The meaning of terms not specifically defined in F106.5 or in regulations issued by the Administrator of the General Services Administration, the Secretary of Defense, the Secretary of Housing and Urban Development, or the United States Postal Service to implement the Architectural Barriers Act or in referenced standards shall be as defined by collegiate dictionaries in the sense that the context implies.

**F106.4 Interchangeability.** Words, terms and phrases used in the singular include the plural and those used in the plural include the singular.

**F106.5 Defined Terms.**

**Accessible.** A *site, building, facility*, or portion thereof that complies with this part.

**Accessible Means of Egress.** A continuous and unobstructed way of egress travel from any point in a *building or facility* that provides an *accessible* route to an area of refuge, a horizontal exit, or a *public way*.

**Addition.** An expansion, extension, or increase in the gross floor area or height of a *building or facility*.

**Administrative Authority.** A governmental agency that adopts or enforces regulations and guidelines for the design, construction, or *alteration of buildings and facilities*.

**Alteration.** A change to a *building or facility* that affects or could affect the usability of the *building or facility* or portion thereof. *Alterations* include, but are not limited to, remodeling, renovation, rehabilitation, reconstruction, historic restoration, resurfacing of *circulation paths or vehicular ways*, changes or rearrangement of the structural parts or *elements*, and changes or rearrangement in the plan configuration of walls and full-height partitions. Normal maintenance, reroofing, painting or wallpapering, or changes to mechanical and electrical systems are not *alterations* unless they affect the usability of the *building or facility*.

**Amusement Attraction.** Any *facility*, or portion of a *facility*, located within an amusement park or theme park which provides amusement without the use of an amusement device. *Amusement attractions* include, but are not limited to, fun houses, barrels, and other attractions without seats.

**Amusement Ride.** A system that moves persons through a fixed course within a defined area for the purpose of amusement.

**Amusement Ride Seat.** A seat that is built-in or mechanically fastened to an *amusement ride* intended to be occupied by one or more passengers.

**Area of Sport Activity.** That portion of a room or *space* where the play or practice of a sport occurs.

**Assembly Area.** A *building* or *facility*, or portion thereof, used for the purpose of entertainment, worship, educational or civic gatherings, or similar purposes. For the purposes of these requirements, *assembly areas* include, but are not limited to, classrooms, lecture halls, courtrooms, public meeting rooms, public hearing rooms, legislative chambers, motion picture houses, auditoria, theaters, playhouses, dinner theaters, concert halls, centers for the performing arts, amphitheatres, arenas, stadiums, grandstands, or convention centers.

**Assistive Listening System (ALS).** An amplification system utilizing transmitters, receivers, and coupling devices to bypass the acoustical *space* between a sound source and a listener by means of induction loop, radio frequency, infrared, or direct-wired equipment.

**Boarding Pier.** A portion of a pier where a boat is temporarily secured for the purpose of embarking or disembarking.

**Boat Launch Ramp.** A sloped surface designed for launching and retrieving trailered boats and other water craft to and from a body of water.

**Boat Slip.** That portion of a pier, main pier, finger pier, or float where a boat is moored for the purpose of berthing, embarking, or disembarking.

**Building.** Any structure used or intended for supporting or sheltering any use or occupancy.

**Catch Pool.** A pool or designated section of a pool used as a terminus for water slide flumes.

**Characters.** Letters, numbers, punctuation marks and typographic symbols.

**Children's Use.** Describes *spaces* and *elements* specifically designed for use primarily by people 12 years old and younger.

**Circulation Path.** An exterior or interior way of passage provided for pedestrian travel, including but not limited to, *walks*, hallways, courtyards, elevators, platform lifts, *ramps*, stairways, and landings.

**Closed-Circuit Telephone.** A telephone with a dedicated line such as a house phone, courtesy phone or phone that must be used to gain entry to a *facility*.

**Advisory F202.3 Alterations.** Although covered entities are permitted to limit the scope of an alteration to individual elements, the alteration of multiple elements within a room or space may provide a cost-effective opportunity to make the entire room or space accessible. Any elements or spaces of the building or facility that are required to comply with these requirements must be made accessible within the scope of the alteration, to the maximum extent feasible. If providing accessibility in compliance with these requirements for people with one type of disability (e.g., people who use wheelchairs) is not feasible, accessibility must still be provided in compliance with the requirements for people with other types of disabilities (e.g., people who have hearing impairments or who have vision impairments) to the extent that such accessibility is feasible.

**F202.3.1 Prohibited Reduction in Access.** An *alteration* that decreases or has the effect of decreasing the *accessibility* of a *building* or *facility* below the requirements for new construction at the time of the *alteration* is prohibited.

**F202.3.2 Extent of Application.** An *alteration* of an existing *element*, *space*, or area of a *building* or *facility* shall not impose a requirement for *accessibility* greater than required for new construction.

**F202.4 Alterations Affecting Primary Function Areas.** In addition to the requirements of F202.3, an *alteration* that affects or could affect the usability of or access to an area containing a primary function shall be made so as to ensure that, to the maximum extent feasible, the path of travel to the *altered* area, including the rest rooms, telephones, and drinking fountains serving the *altered* area, are readily *accessible* to and usable by individuals with disabilities, unless such *alterations* are disproportionate to the overall *alterations* in terms of cost and scope as determined under criteria established by the Administrator of the General Services Administration, the Secretary of Defense, the Secretary of Housing and Urban Development, or the United States Postal Service.

**EXCEPTION:** *Residential dwelling units* shall not be required to comply with F202.4.

**Advisory F202.4 Alterations Affecting Primary Function Areas.** An area of a building or facility containing a major activity for which the building or facility is intended is a primary function area. There can be multiple areas containing a primary function in a single building. Primary function areas are not limited to public use areas. For example, both a bank lobby and the bank's employee areas such as the teller areas and walk-in safe are primary function areas. Also, mixed use facilities may include numerous primary function areas for each use. Areas containing a primary function do not include: mechanical rooms, boiler rooms, supply storage rooms, employee lounges or locker rooms, janitorial closets, entrances, corridors, or restrooms.

**F202.5 Alterations to Qualified Historic Buildings and Facilities.** *Alterations* to a *qualified historic building* or *facility* shall comply with F202.3 and F202.4.

**EXCEPTION:** Where the State Historic Preservation Officer or Advisory Council on Historic Preservation determines that compliance with the requirements for *accessible* routes, *entrances*, or toilet *facilities* would threaten or destroy the historic significance of the *building* or *facility*, the exceptions for *alterations* to *qualified historic buildings* or *facilities* for that *element* shall be permitted to apply.

**F206.3 Location.** *Accessible* routes shall coincide with or be located in the same area as general *circulation paths*. Where *circulation paths* are interior, required *accessible* routes shall also be interior.

**Advisory F206.3 Location.** The accessible route must be in the same area as the general circulation path. This means that circulation paths, such as vehicular ways designed for pedestrian traffic, walks, and unpaved paths that are designed to be routinely used by pedestrians must be accessible or have an accessible route nearby. Additionally, accessible vertical interior circulation must be in the same area as stairs and escalators, not isolated in the back of the facility.

**F206.4 Entrances.** *Entrances* shall be provided in accordance with F206.4. *Entrance* doors, doorways, and gates shall comply with 404 and shall be on an *accessible* route complying with 402.

**EXCEPTIONS:** 1. Where an *alteration* includes *alterations* to an *entrance*, and the *building* or *facility* has another *entrance* complying with 404 that is on an *accessible* route, the *altered entrance* shall not be required to comply with F206.4 unless required by F202.4.

2. Where exceptions for *alterations* to *qualified historic buildings or facilities* are permitted by F202.5, no more than one *public entrance* shall be required to comply with F206.4. Where no *public entrance* can comply with F206.4 under criteria established in F202.5 Exception, then either an unlocked *entrance* not used by the public shall comply with F206.4; or a locked *entrance* complying with F206.4 with a notification system or remote monitoring shall be provided.

**F206.4.1 Public Entrances.** In addition to *entrances* required by F206.4.2 through F206.4.9, at least 60 percent of all *public entrances* shall comply with 404.

**F206.4.2 Parking Structure Entrances.** Where direct access is provided for pedestrians from a parking structure to a *building* or *facility entrance*, each direct access to the *building* or *facility entrance* shall comply with 404.

**F206.4.3 Entrances from Tunnels or Elevated Walkways.** Where direct access is provided for pedestrians from a pedestrian tunnel or elevated walkway to a *building* or *facility*, at least one direct *entrance* to the *building* or *facility* from each tunnel or walkway shall comply with 404.

**F206.4.4 Transportation Facilities.** In addition to the requirements of F206.4.2, F206.4.3, and F206.4.5 through F206.4.9, transportation *facilities* shall provide *entrances* in accordance with F206.4.4.

**F206.4.4.1 Location.** In transportation *facilities*, where different *entrances* serve different transportation fixed routes or groups of fixed routes, at least one *public entrance* serving each fixed route or group of fixed routes shall comply with 404.

**F206.4.4.2 Direct Connections.** Direct connections to other *facilities* shall provide an *accessible* route complying with 404 from the point of connection to boarding platforms and all transportation system *elements* required to be *accessible*. Any *elements* provided to facilitate future direct connections shall be on an *accessible* route connecting boarding platforms and all transportation system *elements* required to be *accessible*.

**Advisory F208.2.2 Rehabilitation Facilities and Outpatient Physical Therapy Facilities.**

Conditions that affect mobility include conditions requiring the use or assistance of a brace, cane, crutch, prosthetic device, wheelchair, or powered mobility aid; arthritic, neurological, or orthopedic conditions that severely limit one's ability to walk; respiratory diseases and other conditions which may require the use of portable oxygen; and cardiac conditions that impose significant functional limitations.

**F208.2.3 Residential Facilities.** Parking *spaces* provided to serve residential *facilities* shall comply with F208.2.3.

**F208.2.3.1 Parking for Residents.** Where at least one parking *space* is provided for each *residential dwelling unit*, at least one parking *space* complying with 502 shall be provided for each *residential dwelling unit* required to provide mobility features complying with 809.2 through 809.4.

**F208.2.3.2 Additional Parking Spaces for Residents.** Where the total number of parking *spaces* provided for each *residential dwelling unit* exceeds one parking *space* per *residential dwelling unit*, 2 percent, but no fewer than one *space*, of all the parking *spaces* not covered by F208.2.3.1 shall comply with 502.

**F208.2.3.3 Parking for Guests, Employees, and Other Non-Residents.** Where parking spaces are provided for persons other than residents, parking shall be provided in accordance with Table F208.2.

**F208.2.4 Van Parking Spaces.** For every six or fraction of six parking *spaces* required by F208.2 to comply with 502, at least one shall be a van parking *space* complying with 502.

**F208.3 Location.** Parking *facilities* shall comply with F208.3

**F208.3.1 General.** Parking *spaces* complying with 502 that serve a particular *building* or *facility* shall be located on the shortest *accessible* route from parking to an *entrance* complying with F206.4. Where parking serves more than one *accessible entrance*, parking *spaces* complying with 502 shall be dispersed and located on the shortest *accessible* route to the *accessible entrances*. In parking *facilities* that do not serve a particular *building* or *facility*, parking *spaces* complying with 502 shall be located on the shortest *accessible* route to an *accessible* pedestrian *entrance* of the parking *facility*.

**EXCEPTIONS:** 1. All van parking *spaces* shall be permitted to be grouped on one level within a multi-story parking *facility*.

2. Parking *spaces* shall be permitted to be located in different parking *facilities* if substantially equivalent or greater *accessibility* is provided in terms of distance from an *accessible entrance* or *entrances*, parking fee, and user convenience.

**Advisory F208.3.1 General Exception 2.** Factors that could affect "user convenience" include, but are not limited to, protection from the weather, security, lighting, and comparative maintenance of the alternative parking site.

**F232.3 Special Holding Cells and Special Housing Cells.** Where special holding cells or special housing cells are provided, at least one cell serving each purpose shall provide mobility features complying with 807.2. Cells subject to this requirement include, but are not limited to, those used for purposes of orientation, protective custody, administrative or disciplinary detention or segregation, detoxification, and medical isolation.

**EXCEPTION:** *Alterations* to cells shall not be required to comply except to the extent determined by regulations issued by the appropriate Federal agency having authority under section 504 of the Rehabilitation Act of 1973.

**F232.4 Medical Care Facilities.** Patient bedrooms or cells required to comply with F223 shall be provided in addition to any medical isolation cells required to comply with F232.3.

**F232.5 Visiting Areas.** Visiting areas shall comply with F232.5.

**F232.5.1 Cubicles and Counters.** At least 5 percent, but no fewer than one, of cubicles shall comply with 902 on both the visitor and detainee sides. Where counters are provided, at least one shall comply with 904.4.2 on both the visitor and detainee or inmate sides.

**EXCEPTION:** The inmate or detainee side of cubicles or counters at non-contact visiting areas not serving holding cells or housing cells required to comply with F232 shall not be required to comply with 902 or 904.4.2.

**F232.5.2 Partitions.** Where solid partitions or security glazing separate visitors from detainees or inmates at least one of each type of cubicle or counter partition shall comply with 904.6.

## **F233 Residential Facilities**

**F233.1 General.** *Facilities with residential dwelling units* shall comply with F233.

**Advisory F233.1 General.** Section F233 outlines the requirements for residential facilities subject to the Architectural Barriers Act. The facilities covered by Section F233, as well as other facilities not covered by this section, may still be subject to other Federal laws such as the Fair Housing Act and Section 504 of the Rehabilitation Act of 1973, as amended. For example, the Fair Housing Act requires that certain residential structures having four or more multi-family dwelling units, regardless of whether they are privately owned or federally assisted, include certain features of accessible and adaptable design according to guidelines established by the U.S. Department of Housing and Urban Development (HUD). These laws and the appropriate regulations should be consulted before proceeding with the design and construction of residential facilities.

Residential facilities containing residential dwelling units provided by entities subject to HUD's Section 504 regulations and residential dwelling units covered by Section F233.3 must comply with the technical and scoping requirements in Chapters 1 through 10 included in this document. Section F233 is not a stand-alone section; this section only addresses the minimum number of residential dwelling units within a facility required to comply with Chapter 8. However, residential facilities must also comply with the requirements of this document. For example: Section F206.5.4 requires all doors and doorways providing user

**Advisory F233.1 General (Continued).** passage in residential dwelling units providing mobility features to comply with Section 404; Section F206.7.6 permits platform lifts to be used to connect levels within residential dwelling units providing mobility features; Section F208 provides general scoping for accessible parking and Section F208.2.3.1 specifies the required number of accessible parking spaces for each residential dwelling unit providing mobility features; Section F228.2 requires mail boxes to be within reach ranges when they serve residential dwelling units providing mobility features; play areas are addressed in Section F240; and swimming pools are addressed in Section F242. There are special provisions applicable to facilities containing residential dwelling units at: Exception 3 to F202.3; Exception to F202.4; F203.9; and Exception 3 to F206.2.3.

**F233.2 Residential Dwelling Units Provided by HUD or Through Grant or Loan Programs Administered by HUD.** Where *facilities with residential dwelling units* are provided by the Department of Housing and Urban Development (HUD), or through a grant or loan program administered by HUD, *residential dwelling units* with mobility features complying with 809.2 through 809.4 shall be provided in a number required by the regulations issued by HUD under Section 504 of the Rehabilitation Act of 1973, as amended. *Residential dwelling units* required to provide mobility features complying with 809.2 through 809.4 shall be on an *accessible* route as required by F206. In addition, *residential dwelling units* with communication features complying with 809.5 shall be provided in a number required by the applicable HUD regulations. *Residential dwelling units* subject to F233.2 shall not be required to comply with F233.3 or F233.4.

**Advisory F233.2 Residential Dwelling Units Provided by HUD or Through Grant or Loan Programs Administered by HUD.** Section F233.2 requires that entities subject to HUD's regulations implementing Section 504 of the Rehabilitation Act of 1973, as amended, provide residential dwelling units containing mobility features and residential dwelling units containing communication features complying with these regulations in a number specified in HUD's Section 504 regulations. Further, the residential dwelling units provided must be dispersed according to HUD's Section 504 criteria. In addition, Section F233.2 defers to HUD the specification of criteria by which the technical requirements of this document will apply to alterations of existing facilities subject to HUD's Section 504 regulations.

**F233.3 Residential Dwelling Units Provided on Military Installations.** *Military installations* with *residential dwelling units* shall comply with F233.3. *Residential dwelling units* on *military installations* subject to F233.3 shall not be required to comply with F233.2 or F233.4.

**F233.3.1 Minimum Number: New Construction.** Newly constructed *facilities with residential dwelling units* shall comply with F233.3.1.

**F233.3.1.1 Residential Dwelling Units with Mobility Features.** On *military installations* with *residential dwelling units*, at least 5 percent, but no fewer than one unit, of the total number of *residential dwelling units* shall provide mobility features complying with 809.2 through 809.4 and shall be on an *accessible* route as required by F206.

■ 4. Appendix D to Part 1191—Technical 191, 197, 225 and 247 through 251 as set Appendix D to Part 1191—Technical is amended by revising pages 173, 178, forth below.

TECHNICAL

CHAPTER 4: ACCESSIBLE ROUTES

**407.2.2.4 Differentiation.** Each destination-oriented elevator in a bank of elevators shall have audible and visible means for differentiation.

**407.2.3 Hoistway Signs.** Signs at elevator hoistways shall comply with 407.2.3.

**407.2.3.1 Floor Designation.** Floor designations complying with 703.2 and 703.4.1 shall be provided on both jambs of elevator hoistway entrances. Floor designations shall be provided in both *tactile characters* and braille. *Tactile characters* shall be 2 inches (51 mm) high minimum. A *tactile star* shall be provided on both jambs at the main entry level.

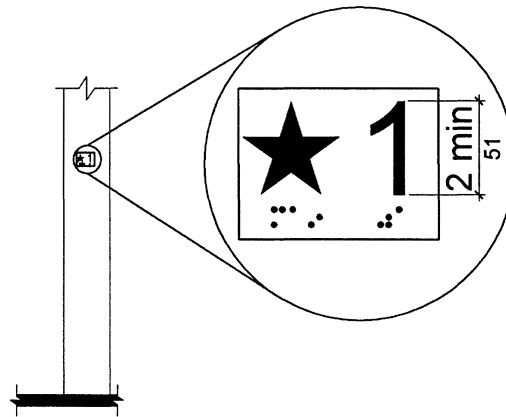

**Figure 407.2.3.1**  
Floor Designations on Jambs of Elevator Hoistway Entrances

**407.2.3.2 Car Designations.** Destination-oriented elevators shall provide *tactile car identification* complying with 703.2 on both jambs of the hoistway immediately below the floor designation. Car designations shall be provided in both *tactile characters* and braille. *Tactile characters* shall be 2 inches (51 mm) high minimum.

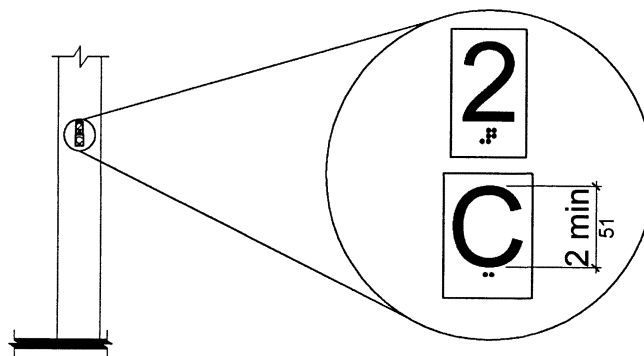

**Figure 407.2.3.2**  
Car Designations on Jambs of Destination-Oriented Elevator Hoistway Entrances



**EXCEPTION:** In existing elevators, where a new car operating panel complying with 407.4.7 is provided, existing car operating panels shall not be required to comply with 407.4.7.

**407.4.7.1 Buttons.** Car control buttons shall comply with 407.4.7.1.











**407.4.7.1.1 Type.** Control buttons shall be identified by *tactile characters* complying with 703.2.

**407.4.7.1.2 Location.** Raised *character* and braille designations shall be placed immediately to the left of the control button to which the designations apply.

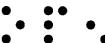
**EXCEPTION:** Where *space* on an existing car operating panel precludes *tactile* markings to the left of the controls, markings shall be placed as near to the control as possible.

**407.4.7.1.3 Symbols.** The control button for the emergency stop, alarm, door open, door close, main entry floor, and phone, shall be identified with *tactile* symbols as shown in Table 407.4.7.1.3.

**Table 407.4.7.1.3 Elevator Control Button Identification**

Control Button	Tactile Symbol	Braille Message
Emergency Stop		  "ST"OP Three cells
Alarm		  AL"AR"M Four cells
Door Open		  OP"EN" Three cells
Door Close		  CLOSE Five cells
Main Entry Floor		  MA"IN" Three cells
Phone		  PH"ONE" Four cells

**407.4.7.1.4 Visible Indicators.** Buttons with floor designations shall be provided with visible indicators to show that a call has been registered. The visible indication shall extinguish when the car arrives at the designated floor.

## 505 Handrails

**505.1 General.** Handrails provided along walking surfaces complying with 403, required at *ramps* complying with 405, and required at stairs complying with 504 shall comply with 505.

**Advisory 505.1 General.** Handrails are required on ramp runs with a rise greater than 6 inches (150 mm) (see 405.8) and on certain stairways (see 504). Handrails are not required on walking surfaces with running slopes less than 1:20. However, handrails are required to comply with 505 when they are provided on walking surfaces with running slopes less than 1:20 (see 403.6). Sections 505.2, 505.3, and 505.10 do not apply to handrails provided on walking surfaces with running slopes less than 1:20 as these sections only reference requirements for ramps and stairs.

**505.2 Where Required.** Handrails shall be provided on both sides of stairs and *ramps*.

**EXCEPTION:** In *assembly areas*, handrails shall not be required on both sides of aisle *ramps* where a handrail is provided at either side or within the aisle width.

**505.3 Continuity.** Handrails shall be continuous within the full length of each stair flight or *ramp* run. Inside handrails on switchback or dogleg stairs and *ramps* shall be continuous between flights or runs.

**EXCEPTION:** In *assembly areas*, handrails on *ramps* shall not be required to be continuous in aisles serving seating.

**505.4 Height.** Top of gripping surfaces of handrails shall be 34 inches (865 mm) minimum and 38 inches (965 mm) maximum vertically above walking surfaces, stair nosings, and *ramp* surfaces. Handrails shall be at a consistent height above walking surfaces, stair nosings, and *ramp* surfaces.

**Advisory 505.4 Height.** The requirements for stair and ramp handrails in this document are for adults. When children are the principal users in a building or facility (e.g., elementary schools), a second set of handrails at an appropriate height can assist them and aid in preventing accidents. A maximum height of 28 inches (710 mm) measured to the top of the gripping surface from the ramp surface or stair nosing is recommended for handrails designed for children. Sufficient vertical clearance between upper and lower handrails, 9 inches (230 mm) minimum, should be provided to help prevent entrapment.

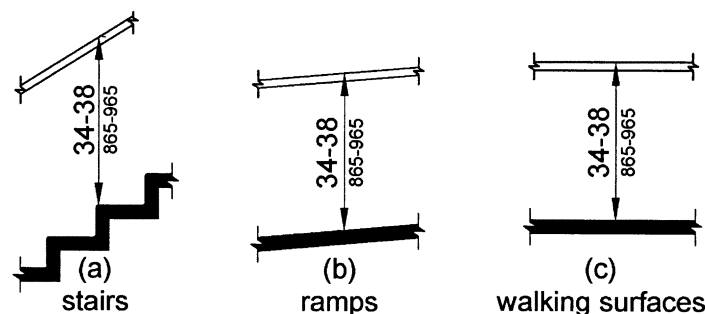

**Figure 505.4**  
**Handrail Height**

**Advisory 602.6 Water Flow.** The purpose of requiring the drinking fountain spout to produce a flow of water 4 inches (100 mm) high minimum is so that a cup can be inserted under the flow of water to provide a drink of water for an individual who, because of a disability, would otherwise be incapable of using the drinking fountain.

**602.7 Drinking Fountains for Standing Persons.** Spout outlets of drinking fountains for standing persons shall be 38 inches (965 mm) minimum and 43 inches (1090 mm) maximum above the finish floor or ground.

### 603 Toilet and Bathing Rooms

**603.1 General.** Toilet and bathing rooms shall comply with 603.

**603.2 Clearances.** Clearances shall comply with 603.2.

**603.2.1 Turning Space.** Turning *space* complying with 304 shall be provided within the room.

**603.2.2 Overlap.** Required clear floor *spaces*, clearance at fixtures, and turning *space* shall be permitted to overlap.

**603.2.3 Door Swing.** Doors shall not swing into the clear floor *space* or clearance required for any fixture. Doors shall be permitted to swing into the required turning *space*.

**EXCEPTIONS:** 1. Doors to a toilet room or bathing room for a single occupant accessed only through a private office and not for *common use* or *public use* shall be permitted to swing into the clear floor *space* or clearance provided the swing of the door can be reversed to comply with 603.2.3.

2. Where the toilet room or bathing room is for individual use and a clear floor *space* complying with 305.3 is provided within the room beyond the arc of the door swing, doors shall be permitted to swing into the clear floor *space* or clearance required for any fixture.

**Advisory 603.2.3 Door Swing Exception 1.** At the time the door is installed, and if the door swing is reversed in the future, the door must meet all the requirements specified in 404. Additionally, the door swing cannot reduce the required width of an accessible route. Also, avoid violating other building or life safety codes when the door swing is reversed.

**603.3 Mirrors.** Mirrors located above lavatories or countertops shall be installed with the bottom edge of the reflecting surface 40 inches (1015 mm) maximum above the finish floor or ground. Mirrors not located above lavatories or countertops shall be installed with the bottom edge of the reflecting surface 35 inches (890 mm) maximum above the finish floor or ground.

**Advisory 603.3 Mirrors.** A single full-length mirror can accommodate a greater number of people, including children. In order for mirrors to be usable by people who are ambulatory and people who use wheelchairs, the top edge of mirrors should be 74 inches (1880 mm) minimum from the floor or ground.

**Table 703.3.1 Braille Dimensions**

Measurement Range	Minimum in Inches Maximum in Inches
Dot base diameter	0.059 (1.5 mm) to 0.063 (1.6 mm)
Distance between two dots in the same cell <sup>1</sup>	0.090 (2.3 mm) to 0.100 (2.5 mm)
Distance between corresponding dots in adjacent cells <sup>1</sup>	0.241 (6.1 mm) to 0.300 (7.6 mm)
Dot height	0.025 (0.6 mm) to 0.037 (0.9 mm)
Distance between corresponding dots from one cell directly below <sup>1</sup>	0.395 (10 mm) to 0.400 (10.2 mm)

1. Measured center to center.

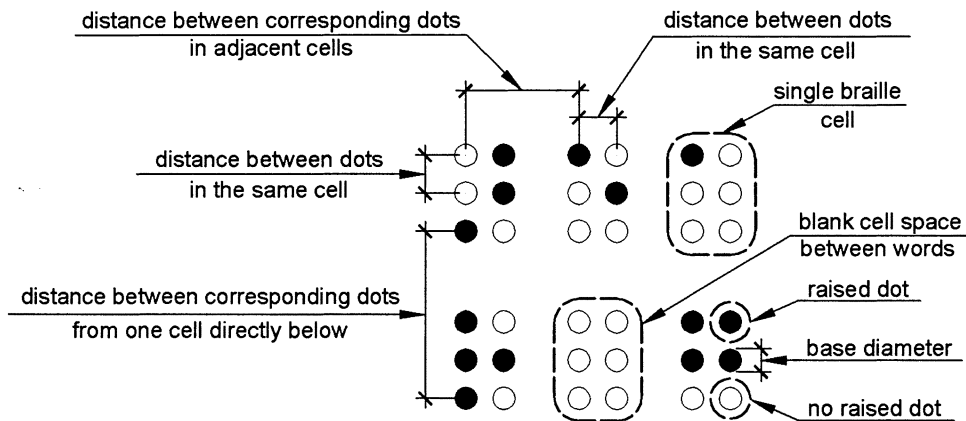

**Figure 703.3.1  
Braille Measurement**

**703.3.2 Position.** Braille shall be positioned below the corresponding text. If text is multi-lined, braille shall be placed below the entire text. Braille shall be separated 3/8 inch (9.5 mm) minimum from any other *tactile characters* and 3/8 inch (9.5 mm) minimum from raised borders and decorative *elements*.

**805.3 Clear Floor or Ground Space.** A clear floor *space* complying with 305 shall be provided on each side of the bed. The clear floor *space* shall be positioned for parallel approach to the side of the bed.

**805.4 Toilet and Bathing Rooms.** Toilet and bathing rooms that are provided as part of a patient or resident sleeping room shall comply with 603. Where provided, no fewer than one water closet, one lavatory, and one bathtub or shower shall comply with the applicable requirements of 603 through 610.

### 806 Transient Lodging Guest Rooms

**806.1 General.** *Transient lodging* guest rooms shall comply with 806. Guest rooms required to provide mobility features shall comply with 806.2. Guest rooms required to provide communication features shall comply with 806.3.

**806.2 Guest Rooms with Mobility Features.** Guest rooms required to provide mobility features shall comply with 806.2.

**Advisory 806.2 Guest Rooms.** The requirements in Section 806.2 do not include requirements that are common to all accessible spaces. For example, closets in guest rooms must comply with the applicable provisions for storage specified in scoping.

**806.2.1 Living and Dining Areas.** Living and dining areas shall be *accessible*.

**806.2.2 Exterior Spaces.** Exterior *spaces*, including patios, terraces and balconies, that serve the guest room shall be *accessible*.

**806.2.3 Sleeping Areas.** At least one sleeping area shall provide a clear floor *space* complying with 305 on both sides of a bed. The clear floor *space* shall be positioned for parallel approach to the side of the bed.

**EXCEPTION:** Where a single clear floor *space* complying with 305 positioned for parallel approach is provided between two beds, a clear floor or ground *space* shall not be required on both sides of a bed.

**806.2.4 Toilet and Bathing Facilities.** At least one bathroom that is provided as part of a guest room shall comply with 603. No fewer than one water closet, one lavatory, and one bathtub or shower shall comply with applicable requirements of 603 through 610. In addition, required roll-in shower compartments shall comply with 608.2.2 or 608.2.3. Toilet and bathing fixtures required to comply with 603 through 610 shall be permitted to be located in more than one toilet or bathing area, provided that travel between fixtures does not require travel between other parts of the guest room.

**806.2.4.1 Vanity Counter Top Space.** If vanity counter top *space* is provided in non-accessible guest toilet or bathing rooms, comparable vanity counter top *space*, in terms of size and proximity to the lavatory, shall also be provided in *accessible* guest toilet or bathing rooms.

**Advisory 806.2.4.1 Vanity Counter Top Space.** This provision is intended to ensure that accessible guest rooms are provided with comparable vanity counter top space.

**806.2.5 Kitchens and Kitchenettes.** Kitchens and kitchenettes shall comply with 804.

**806.2.6 Turning Space.** Turning *space* complying with 304 shall be provided within the guest room.

**806.3 Guest Rooms with Communication Features.** Guest rooms required to provide communication features shall comply with 806.3.

**Advisory 806.3 Guest Rooms with Communication Features.** In guest rooms required to have accessible communication features, consider ensuring compatibility with adaptive equipment used by people with hearing impairments. To ensure communication within the facility, as well as on commercial lines, provide telephone interface jacks that are compatible with both digital and analog signal use. If an audio headphone jack is provided on a speaker phone, a cutoff switch can be included in the jack so that insertion of the jack cuts off the speaker. If a telephone-like handset is used, the external speakers can be turned off when the handset is removed from the cradle. For headset or external amplification system compatibility, a standard subminiature jack installed in the telephone will provide the most flexibility.

**806.3.1 Alarms.** Where emergency warning systems are provided, alarms complying with 702 shall be provided.

**806.3.2 Notification Devices.** Visible notification devices shall be provided to alert room occupants of incoming telephone calls and a door knock or bell. Notification devices shall not be connected to visible alarm signal appliances. Telephones shall have volume controls compatible with the telephone system and shall comply with 704.3. Telephones shall be served by an electrical outlet complying with 309 located within 48 inches (1220 mm) of the telephone to facilitate the use of a *TTY*.

## **807 Holding Cells and Housing Cells**

**807.1 General.** Holding cells and housing cells shall comply with 807.

**807.2 Cells with Mobility Features.** Cells required to provide mobility features shall comply with 807.2.

**807.2.1 Turning Space.** Turning *space* complying with 304 shall be provided within the cell.

**807.2.2 Benches.** Where benches are provided, at least one bench shall comply with 903.

**807.2.3 Beds.** Where beds are provided, clear floor *space* complying with 305 shall be provided on at least one side of the bed. The clear floor *space* shall be positioned for parallel approach to the side of the bed.

**807.2.4 Toilet and Bathing Facilities.** Toilet *facilities* or bathing *facilities* that are provided as part of a cell shall comply with 603. Where provided, no fewer than one water closet, one lavatory, and one bathtub or shower shall comply with the applicable requirements of 603 through 610.

**Advisory 807.2.4 Toilet and Bathing Facilities.** In holding cells, housing cells, or rooms required to be accessible, these requirements do not require a separate toilet room.

**807.3 Cells with Communication Features.** Cells required to provide communication features shall comply with 807.3.

**807.3.1 Alarms.** Where audible emergency alarm systems are provided to serve the occupants of cells, visible alarms complying with 702 shall be provided.

**EXCEPTION:** Visible alarms shall not be required where inmates or detainees are not allowed independent means of egress.

**807.3.2 Telephones.** Telephones, where provided within cells, shall have volume controls complying with 704.3.

## 808 Courtrooms

**808.1 General.** Courtrooms shall comply with 808.

**808.2 Turning Space.** Where provided, areas that are raised or depressed and accessed by *ramps* or platform lifts with entry *ramps* shall provide unobstructed turning *space* complying with 304.

**808.3 Clear Floor Space.** Each jury box and witness stand shall have, within its defined area, clear floor *space* complying with 305.

**EXCEPTION:** In *alterations*, *wheelchair spaces* are not required to be located within the defined area of raised jury boxes or witness stands and shall be permitted to be located outside these *spaces* where *ramp* or platform lift access poses a hazard by restricting or projecting into a means of egress required by the appropriate *administrative authority*.

**808.4 Judges' Benches and Courtroom Stations.** Judges' benches, clerks' stations, bailiffs' stations, deputy clerks' stations, court reporters' stations and litigants' and counsel stations shall comply with 902.

## 809 Residential Dwelling Units

**809.1 General.** *Residential dwelling units* shall comply with 809. *Residential dwelling units* required to provide mobility features shall comply with 809.2 through 809.4. *Residential dwelling units* required to provide communication features shall comply with 809.5.

**809.2 Accessible Routes.** *Accessible* routes complying with Chapter 4 shall be provided within *residential dwelling units* in accordance with 809.2.

**EXCEPTION:** *Accessible* routes shall not be required to or within unfinished attics or unfinished basements.

**809.2.1 Location.** At least one *accessible* route shall connect all *spaces* and *elements* which are a part of the *residential dwelling unit*. Where only one *accessible* route is provided, it shall not pass through bathrooms, closets, or similar *spaces*.

**809.2.2 Turning Space.** All rooms served by an *accessible* route shall provide a turning *space* complying with 304.

**EXCEPTION:** Turning *space* shall not be required in exterior *spaces* 30 inches (760 mm) maximum in depth or width.

**Advisory 809.2.2 Turning Space.** It is generally acceptable to use required clearances to provide wheelchair turning space. For example, in kitchens, 804.3.1 requires at least one work surface with clear floor space complying with 306 to be centered beneath. If designers elect to provide clear floor space that is at least 36 inches (915 mm) wide, as opposed to the required 30 inches (760 mm) wide, that clearance can be part of a T-turn, thereby maximizing efficient use of the kitchen area. However, the overlap of turning space must be limited to one segment of the T-turn so that back-up maneuvering is not restricted. It would, therefore, be unacceptable to use both the clearances under the work surface and the sink as part of a T-turn. See Section 304.3.2 regarding T-turns.

**809.3 Kitchen.** Where a kitchen is provided, it shall comply with 804.

**809.4 Toilet Facilities and Bathing Facilities.** At least one bathroom shall comply with 603. No fewer than one of each type of fixture provided shall comply with applicable requirements of 603 through 610. Toilet and bathing fixtures required to comply with 603 through 610 shall be located in the same toilet and bathing area, such that travel between fixtures does not require travel between other parts of the *residential dwelling unit*.

**Advisory 809.4 Toilet Facilities and Bathing Facilities.** In an effort to promote space efficiency, vanity counter top space in accessible residential dwelling units is often omitted. This omission does not promote equal access or equal enjoyment of the unit. Where comparable units have vanity counter tops, accessible units should also have vanity counter tops located as close as possible to the lavatory for convenient access to toiletries.

**809.5 Residential Dwelling Units with Communication Features.** *Residential dwelling units* required to provide communication features shall comply with 809.5.

**809.5.1 Building Fire Alarm System.** Where a *building* fire alarm system is provided, the system wiring shall be extended to a point within the *residential dwelling unit* in the vicinity of the *residential dwelling unit* smoke detection system.

**809.5.1.1 Alarm Appliances.** Where alarm appliances are provided within a *residential dwelling unit* as part of the *building* fire alarm system, they shall comply with 702.

**809.5.1.2 Activation.** All visible alarm appliances provided within the *residential dwelling unit* for *building* fire alarm notification shall be activated upon activation of the *building* fire alarm in the portion of the *building* containing the *residential dwelling unit*.

**809.5.2 Residential Dwelling Unit Smoke Detection System.** *Residential dwelling unit* smoke detection systems shall comply with NFPA 72 (1999 or 2002 edition) (incorporated by reference, see "Referenced Standards" in Chapter 1).



**809.5.2.1 Activation.** All visible alarm appliances provided within the *residential dwelling unit* for smoke detection notification shall be activated upon smoke detection.

**809.5.3 Interconnection.** The same visible alarm appliances shall be permitted to provide notification of *residential dwelling unit* smoke detection and *building* fire alarm activation.

**809.5.4 Prohibited Use.** Visible alarm appliances used to indicate *residential dwelling unit* smoke detection or *building* fire alarm activation shall not be used for any other purpose within the *residential dwelling unit*.

**809.5.5 Residential Dwelling Unit Primary Entrance.** Communication features shall be provided at the *residential dwelling unit primary entrance* complying with 809.5.5.

**809.5.5.1 Notification.** A hard-wired electric doorbell shall be provided. A button or switch shall be provided outside the *residential dwelling unit primary entrance*. Activation of the button or switch shall initiate an audible tone and visible signal within the *residential dwelling unit*. Where visible doorbell signals are located in sleeping areas, they shall have controls to deactivate the signal.

**809.5.5.2 Identification.** A means for visually identifying a visitor without opening the *residential dwelling unit* entry door shall be provided and shall allow for a minimum 180 degree range of view.

**Advisory 809.5.5.2 Identification.** In doors, peepholes that include prisms clarify the image and should offer a wide-angle view of the hallway or exterior for both standing persons and wheelchair users. Such peepholes can be placed at a standard height and permit a view from several feet from the door.

**809.5.6 Site, Building, or Floor Entrance.** Where a system, including a closed-circuit system, permitting voice communication between a visitor and the occupant of the *residential dwelling unit* is provided, the system shall comply with 708.4.

## 810 Transportation Facilities

**810.1 General.** Transportation *facilities* shall comply with 810.

**810.2 Bus Boarding and Alighting Areas.** Bus boarding and alighting areas shall comply with 810.2.

**Advisory 810.2 Bus Boarding and Alighting Areas.** At bus stops where a shelter is provided, the bus stop pad can be located either within or outside of the shelter.

**810.2.1 Surface.** Bus stop boarding and alighting areas shall have a firm, stable surface.

■ 5. Appendix E to Part 1191—List of Figures and Index is amended by

revising pages 299, 300, 302, and 304 as set forth below.

**Appendix E to Part 1191—List of Figures and Index**

**LIST OF FIGURES AND INDEX**

Gratings (see Openings)

Ground Level Play Components (see Play Areas)

Ground Surfaces (see Floor or Ground Surfaces)

Guest Rooms (see Transient Lodging)

**H**

Handrails

ABA Scoping... 104

ADA Scoping... 36

Common Technical... 148, 149, 156, 165, 166, 167, 190, 191, 192, 193, 194, 261, 265, 271, 272, 273, 276, 283, 289

High Speed Rail

ABA Scoping... 112

ADA Scoping... 44

Historic Buildings and Facilities

ABA Scoping... 87, 92, 93, 97, 105

ADA Scoping... 20, 23, 25, 29, 37

Historic Preservation (see Historic Buildings and Facilities)

Holding Cells (see Cells)

Hospitals (see Medical Care Facilities)

Hotels (see Transient Lodging)

Housing Cells (see Cells)

**I**

ICC/IBC

ABA Referenced Standard... 77

ADA Referenced Standard... 10

Intercity Rail

ABA Scoping... 112

ADA Scoping... 29, 30, 44

**J**

Judges' Benches

ABA Scoping... 94, 99

ADA Scoping... 25, 31

Judicial Facilities

ABA Scoping... 98, 125

ADA Scoping... 30, 57

**K**

Kitchens and Kitchenettes

ABA Scoping... 104

ADA Scoping... 37

Common Technical... 243, 248

Knee and Toe Clearance

Common Technical... 143, 144, 145, 146, 196, 207, 208, 245, 246, 256

**L**

Lavatories

ABA Scoping... 106

ADA Scoping... 38

Common Technical... 197, 207, 208

Leases

ABA Scoping... 88

Light Rail

ABA Scoping... 112

ADA Scoping... 44

Limited-Use/Limited-Application Elevators

Common Technical... 180

Lines of Sight

ABA Scoping... 115

ADA Scoping... 47

Common Technical... 240, 241, 242

Lockers (see also Storage)

ABA Scoping... 121

ADA Scoping... 53

Locker Rooms (see Dressing, Fitting, and Locker Rooms)

Long-Term Care Facilities

ABA Scoping... 103, 117, 118

ADA Scoping... 36, 49, 50

Common Technical... 217, 246

---

**LIST OF FIGURES AND INDEX**

---

**M****Machinery Spaces**

- ABA Scoping... 90
- ADA Scoping... 21

**Mail Boxes**

- ABA Definition of... 81
- ABA Scoping... 89, 124
- ADA Definition of... 14
- ADA Scoping... 56
- Common Technical... 258

**Maneuvering Clearances**

- Common Technical... 157, 160, 161, 166

**Means of Egress**

- ABA Scoping... 100, 104, 108
- ADA Scoping... 32, 36, 40
- Common Technical... 164, 249, 264, 265

**Medical Care Facilities**

- ABA Scoping... 117, 127
- ADA Scoping... 49, 58
- Common Technical... 217, 223

**Mezzanine**

- ABA Definition of... 82
- ABA Scoping... 93, 94, 116
- ADA Definition of... 14
- ADA Scoping... 24, 25, 26, 48
- Common Technical... 254

**Miniature Golf Facilities**

- ABA Scoping... 96, 135
- ADA Scoping... 28, 66
- Common Technical... 273

**Mirrors**

- ABA Scoping... 106
- ADA Scoping... 38
- Common Technical... 197

**Modifications and Waivers**

- ABA Scoping... 72

**Motels (see Transient Lodging)****Multi-Story Buildings and Facilities**

- ABA Scoping... 93
- ADA Scoping... 24

**N****NFPA**

- ABA Referenced Standard... 78
- ADA Referenced Standard... 11
- Common Technical... 223, 250

**O****Openings**

- Common Technical... 142, 255

**Operable Parts**

- ABA Scoping... 91
- ADA Scoping... 23
- Common Technical... 152, 153, 162, 183, 184, 196, 222, 232, 236, 246, 255

**P****Parking**

- ABA Scoping... 85, 89, 92, 97, 100, 101, 102, 103, 104, 107, 108
- ADA Scoping... 23, 29, 33, 34, 35, 36, 39, 40
- Common Technical... 169, 186, 187, 188, 189

**Passenger Loading Zones**

- ABA Scoping... 85, 92, 103
- ADA Scoping... 23, 35
- Common Technical... 189

**Passing Spaces**

- Common Technical... 156

**Percentages, Calculation of**

- ABA... 73
- ADA... 6

**Performance Areas**

- ABA Scoping... 95, 99
- ADA Scoping... 26, 31

**Platform Lifts**

- ABA Scoping... 99, 100
- ADA Scoping... 31, 32
- Common Technical... 154, 184, 249

**LIST OF FIGURES AND INDEX**

Platforms, Golf, Miniature Golf, Saunas and Steam Rooms, Shooting Facilities, Swimming Pools, Wading Pools, or Spas)	Saunas and Steam Rooms ABA Scoping... 139 ADA Scoping... 70 Common Technical... 222
Recreational Boating Facilities (see Boating Facilities)	
Referenced Standards ABA Scoping... 75, 76, 78, 100, 108 ADA Scoping... 8, 9, 11, 32, 40 Common Technical... 164, 170, 180, 182, 184, 223, 250, 255, 271, 276	Seats, Tub and Shower Common Technical... 219
Rehabilitation Facilities (see Medical Care Facilities)	Security Barriers ABA Scoping... 100 ADA Scoping... 32
Residential Dwelling Unit ABA Definition of... 82 ABA Scoping... 86, 87, 89, 91, 93, 98, 99, 102, 103, 107, 108, 124, 127, 128, 129, 130, 131 ADA Definition of... 15 ADA Scoping... 19, 21, 24, 30, 31, 32, 34, 35, 39, 40, 56, 59, 60, 61, 62 Common Technical... 182, 199, 200, 208, 209, 214, 215, 217, 238, 245, 249, 250, 251	Self-Service Storage Facilities ABA Definition of... 83 ABA Scoping... 98, 122 ADA Definition of... 15 ADA Scoping... 30, 54
Residential Facilities ABA Scoping... 89, 91, 93, 102, 103, 107, 108, 124, 127 ADA Scoping... 21, 24, 34, 35, 39, 40, 56, 59	Service Entrance ABA Definition of... 83 ADA Definition of... 15
Restaurants and Cafeterias ABA Scoping... 94 ADA Scoping... 26	Shelves ABA Scoping... 106, 111, 112, 117, 122, 124 ADA Scoping... 38, 44, 49, 54, 56 Common Technical... 198, 199, 205, 243, 259
Restricted Entrance ABA Definition of... 82 ADA Definition of... 15	Shooting Facilities ABA Scoping... 140 ADA Scoping... 71 Common Technical... 289
Running Slope ABA Definition of... 82 ADA Definition of... 15 Common Technical... 154, 156, 164, 165, 170, 274, 276	Shower Compartments Common Technical... 211, 212, 213, 214, 215, 216, 217, 218, 219, 247
<b>S</b>	Shower Seats Common Technical... 218
Sales and Service ABA Scoping... 89, 123 ADA Scoping... 55 Common Technical... 257, 258	Showers ABA Scoping... 106 ADA Scoping... 38
	Signs ABA Scoping... 107, 108, 109, 110 ADA Scoping... 39, 40, 41, 42 Common Technical... 188, 223, 226, 227

---

**LIST OF FIGURES AND INDEX**

---

ADA Definition of... 16  
ADA Scoping... 41, 42, 43, 44  
Common Technical... 230, 233, 238, 248

**Turning Space**

Common Technical... 143, 144, 146, 175, 197, 199,  
222, 243, 246, 248, 249, 250, 261, 272, 275, 276,  
278, 289

**Two-Way Communication Systems**

ABA Scoping... 125  
ADA Scoping... 56  
Common Technical... 183, 238

**U****Unisex Toilet Room**

ABA Scoping... 86, 105  
ADA Scoping... 37, 38

**Urinals**

ABA Scoping... 105, 106  
ADA Scoping... 38  
Common Technical... 207

**V****Van Parking Spaces**

ABA Scoping... 102  
ADA Scoping... 34, 35  
Common Technical... 186, 187, 188

**Vending Machines**

ABA Scoping... 89, 124  
ADA Scoping... 56

**Vertical Clearance**

ABA Scoping... 91  
ADA Scoping... 22  
Common Technical... 150, 188, 189, 274

**Visiting Areas**

ABA Scoping... 125, 127  
ADA Scoping... 57, 58, 59

**W****Wading Pools**

ABA Scoping... 139, 140  
ADA Scoping... 70  
Common Technical... 279, 283

**Waiting Lines**

ABA Scoping... 110, 123, 124  
ADA Scoping... 42, 55, 56

**Waivers (see Modifications and Waivers)****Walk**

ABA Definition of... 84  
ADA Definition of... 17

**Walking Surfaces**

Common Technical... 154, 191, 192, 233, 261

**Washing Machines and Clothes Dryers**

ABA Scoping... 106  
ADA Scoping... 38  
Common Technical... 152, 222

**Water Closets**

ABA Scoping... 105, 106  
ADA Scoping... 38  
Common Technical... 198, 200, 202, 205, 206, 219

**Water Slides**

ABA Scoping... 91  
ADA Scoping... 22

**Weather Shelters**

ABA Scoping... 96, 135  
ADA Scoping... 28, 66  
Common Technical... 272, 273

**Wheelchair Space(s),**

ABA Definition of... 84  
ABA Scoping... 94, 95, 99, 113, 114, 115, 116  
ADA Definition of... 17  
ADA Scoping... 25, 28, 31, 46, 47, 48  
Common Technical... 239, 240, 241, 242, 243, 261,  
262, 263

**Windows**

ABA Scoping... 124  
ADA Scoping... 56

**Work Surfaces**

ABA Scoping... 89, 122, 123  
ADA Scoping... 54, 55  
Common Technical... 256